

AVerMedia

NV 1000/3000/5000/7000
Digital Video Recording System

User's Manual

FCC NOTICE

This device has been tested and found to comply with the limits for a Class A digital device, pursuant to Part 15 of the FCC Rules. These limits are designed to provide reasonable protection against harmful interference in a commercial, industrial or business environment. This equipment can generate, use and radiate radio frequency energy and, if not installed and used in accordance with the instruction, may cause harmful interference to radio communications. However, there is no guarantee that interference will not occur in a particular installation. If this equipment does cause harmful interference to radio or television reception, which can be determined by turning the equipment off and on, the user is encouraged to try to correct the interference by one or more of the following measures:

Reorient or relocate the receiving antenna.

Increase the separation between the equipment and receiver.

Connect the equipment into an outlet on a circuit different from that to which the receiver is connected.

Consult the dealer or an experienced radio/TV technician for help.

This device complies with Part 15 of the FCC Rules. Operation is subject to the following two conditions: (1) this device may not cause harmful interference, and (2) this device must accept any interference received, including interference that may cause undesired operation.

CAUTION ON MODIFICATIONS

To comply with the limits for the Class A digital device, pursuant to Part 15 of the FCC Rules, this device must be installed in computer equipment certified to comply with the Class A limits. All cables used to connect the computer and peripherals must be shielded and grounded. Operation with non-certified computers or non-shielded cables may result in interference to radio or television reception.

Any changes or modifications not expressly approved by the grantee of this device could void the user's authority to operate the equipment.

CE NOTICE

This is a Class A product.

DISCLAIMER

No warranty or representation, either expressed or implied, is made with respect to the contents of this documentation, its quality, performance, merchantability, or fitness for a particular purpose. Information presented in this documentation has been carefully checked for reliability; however, no responsibility is assumed for inaccuracies. The information contained in this documentation is subject to change without notice.

In no event will AVerMedia be liable for direct, indirect, special, incidental, or consequential damages arising out of the use or inability to use this product or documentation, even if advised of the possibility of such damages.

TRADEMARKS

AVerMedia is a trademark of AVerMedia® TECHNOLOGIES, Inc. IBM PC is a registered trademark of International Business Machines Corporation. Microsoft is a registered trademark and Windows is a trademark of Microsoft Corporation. All other products or corporate names mentioned in this documentation are for identification and explanation purposes only, and may be trademarks or registered trademarks of their respective owners.

COPYRIGHT

2005 by AVerMedia® TECHNOLOGIES, Inc. All rights reserved. No part of this publication may be reproduced, transmitted, transcribed, stored in a retrieval system, or translated into any language in any form by any means without the written permission of AVerMedia® TECHNOLOGIES, Inc.

TABLE OF CONTENTS

Package Contents for NV 1000	vii
Package Contents for NV 3000	viii
Package Contents for NV 5000	viii
Package Contents for NV 7000	ix
NV 1000/ NV 3000 Video Capture Card Specifications	x
NV 5000 Video Capture Card Specifications	x
NV 7000 Video Capture Card Specifications	xi
Manual Conventions	xi
LIMITED WARRANTY	xiii
CHAPTER 1 INSTALLING HARDWARE	16
1.1 Hardware Recommendations	16
1.2 NV 1000/3000/5000/7000 Hardware Installation Combinations	17
1.3 NV 1000 DVR Hardware Installation	19
1.4 NV 3000 DVR Hardware Installation	20
1.5 NV 5000 DVR Hardware Installation	23
1.6 NV 7000 DVR Hardware Installation	28
1.6.1 Installing One AVerMedia NV 7000 Video Capture Card.....	28
1.6.2 Installing 4 NV 7000 Video Capture Cards	29
1.6.3 Installing an I/O Card	30
1.7 Connecting the Watchdog line	32
1.7.1 Connecting the Watchdog line to NV 1000/3000/5000	32
1.7.2 Connecting the Watchdog line to NV 7000	33
1.8 Connecting Cameras and TV-out Cable	34
1.8.1 Connecting Cameras and TV-out Cable to NV 1000/3000/5000	34
1.8.2 Connecting Cameras and TV-out Cable to NV7000	34
1.9 Connecting External Sensors/Relays to NV1000/3000/5000/7000	37
1.9.1 Connecting External Sensors/Relays to NV1000/3000/5000	37
1.9.2 Connecting External Sensors/Relays to NV7000	41

1.10	Connecting POS (Not Supplied)	43
CHAPTER 2 INSTALLING SOFTWARE.....		44
2.1	Installing NV1000/3000/5000 Application Software	45
2.1.1	Installing NV1000/3000/5000 Application in Windows 2000/XP	46
2.2	Installing NV 7000 Application Software	49
2.2.1	Installing NV7000 Application in Windows 2000/XP	50
2.3	Installing NV1000/3000/5000 Driver	53
2.3.1	Installing NV1000/3000/5000 driver in Windows 2000	53
2.3.2	Installing NV1000/3000/5000 driver in Windows XP	55
2.4	Installing NV7000 Driver	58
2.4.1	Installing NV7000 driver in Windows 2000	58
2.4.2	Installing NV7000 driver in Windows XP	60
2.5	Removing Video Capture Card Driver	62
CHAPTER 3 CONFIGURING THE SYSTEM		63
3.1	Logging in for the first time	63
3.1.1	Introducing the Functions buttons on Display/Playback	64
3.2	Configuring DVR	69
3.2.1	System Setting	70
3.2.2	Camera Setting	74
3.2.3	Recording Setting (Video and Audio)	77
3.2.4	Network Setting	84
3.2.5	Schedule Setting	86
3.2.6	Backup Setting	92
3.2.7	Sensor Setting	94
3.2.8	Relay Setting	97
3.2.9	Alarm Setting	98
3.2.10	User Setting	105
CHAPTER 4 USING THE SYSTEM		107
4.1	How to Monitor the Videos	107
4.1.1	Select the Split Display Mode	107
4.1.2	Full Screen Display	110
4.1.3	Auto Scan	110

Preface

4.1.4 Alarm Status and Reset	111
4.2 How to Playback the Videos	111
4.2.1 Setting the Video Playback Date and Time	111
4.2.2 Playing the Videos	113
4.2.3 Catching Desired Videos	114
4.3 Play Backup Video Files	116
4.4 Searching Desired Videos.....	118
4.5 Using E-Map.....	127
4.6 Using PTZ Camera	128
4.7 Using Event Log Viewer	131
4.7.1 Checking Event Logs	132
4.7.2 Checking Operation Logs	132
4.7.3 Checking POS Logs	133
4.6.4 Checking System Logs	133
4.7.5 Check Network Logs.....	133
4.8 Using POS	135
4.9 Using Network Server.....	136
4.10 Using Functional Keys	137
4.11 Checking System Information	138
CHAPTER 5 USING REMOTE PROGRAM.....	140
5.1 Using WebCam	141
5.2 Using the Remote Console	151
5.2.1 System requirement	151
5.2.2 Using Display from Remote Console.....	152
5.2.3 Using Playback from Remote Console	155
5.3 Handy View	158
5.4 Using PDA Viewer.....	158
APPENDIX A REGISTERING DOMAIN NAMES	166
APPENDIX B IMAGE VERIFICATION	168

PREFACE

Welcome to the realm of AVerMedia. AVerMedia DVR digital surveillance system, composed of one 32-bit PCI Video Capture Card, works as a digital video surveillance system. It enables you to capture true color images and real-time videos from 4-16 camera inputs simultaneously.

With the latest Motion Detection technology, once any movement is detected in the monitoring area, AVerMedia DIGITAL SURVEILLANCE SYSTEM automatically starts recording and triggers an alarm. You no longer need to monitor every single moment of the day; the system automatically alerts you when specified events occur.

Package Contents for NV 1000

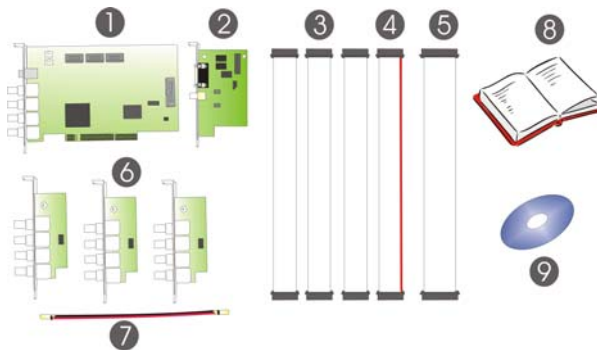

AVerMedia NV 1000 DIGITAL SURVEILLANCE SYSTEM package includes the following items :

1. 1 AVerMedia DVR Video Capture Card
2. 1 Audio + I/O Card
3. 3 Video Extension Card connection cables
4. 1 Audio Card connection cable
5. 1 I/O connection cable
6. 3 AVerMedia DVR Video Extension Cards
7. 1 30 CM Watchdog line
8. 1 Quick Start Guide
9. 1 Software CD (including driver, application software and 1 User's Manual)

Preface

Package Contents for NV 3000

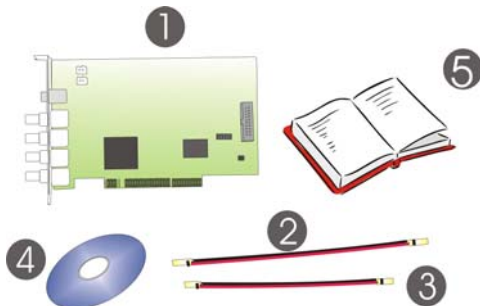

AVerMedia NV 3000 DIGITAL SURVEILLANCE SYSTEM package includes the following items :

1. 1 AVerMedia DVR Video Capture Card
2. 1 30 CM Watchdog line
3. 1 20 CM Video signal line
4. 1 Software CD (including driver, application software and 1 User's Manual
5. 1 Quick Start Guide

Package Contents for NV 5000

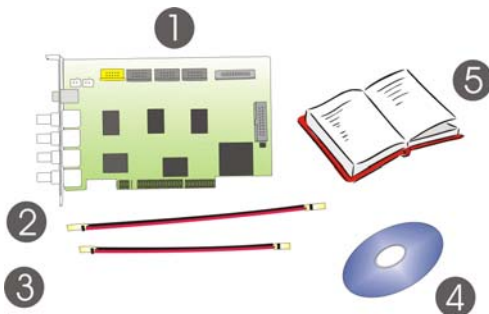

AVerMedia DIGITAL SURVEILLANCE SYSTEM package includes the following items :

1. 1 AVerMedia DVR Video Capture Card
2. 1 30 CM Watchdog line
3. 1 20 CM Video signal line
4. 1 Software CD (including driver, application software and 1 User's Manual
5. 1 Quick Start Guide

Package Contents for NV 7000

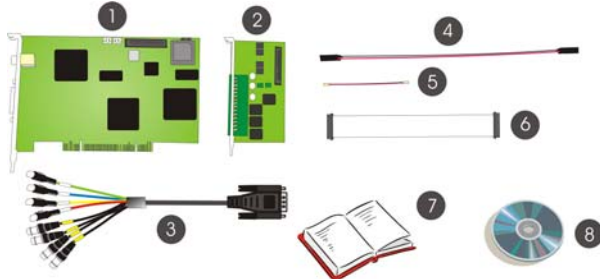

A complete NV 7000 surveillance system package includes the following items:

1. 1 NV 7000 Video capture card
2. 1 I/O card
3. 1 Video and audio connection cable
4. 1 30 CM Watchdog line
5. 1 20 CM Video signal line
6. I/O connection cable
7. Quick Start Guide
8. 1 Software CD

If there is any damage, shortage or inappropriate item in the package contents, please contact with your local dealer.

NV 1000/ NV 3000 Video Capture Card Specifications

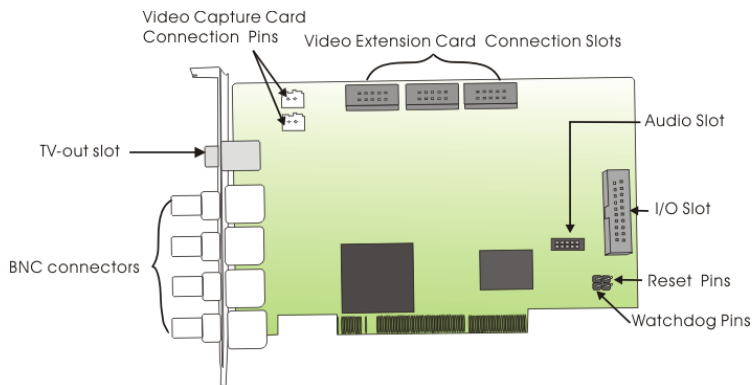

Product	Video Card	Specifications
NV 1000 NV 3000	1 card	One Video Capture Card with 4 BNC connectors and 1 TV-out slot.

NV 5000 Video Capture Card Specifications

The video card in the package meets the following specifications:

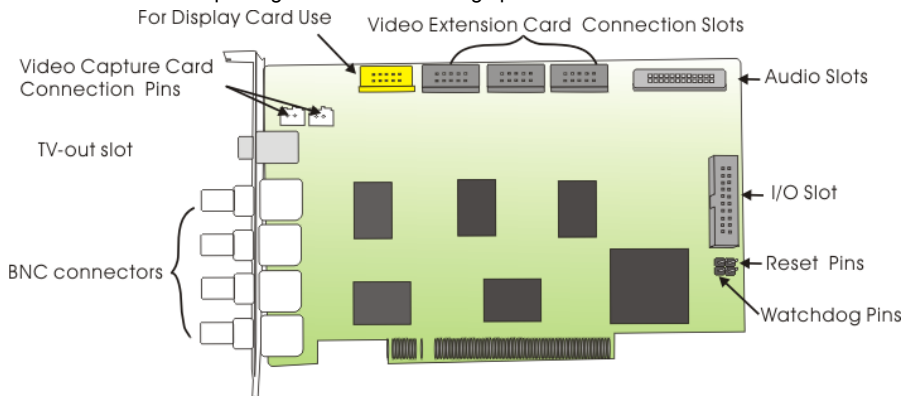

Product	Video Card	Specifications
NV 5000	1 card	One Video Capture Card with 4 BNC connectors and 1 TV-out slot.

NV 7000 Video Capture Card Specifications

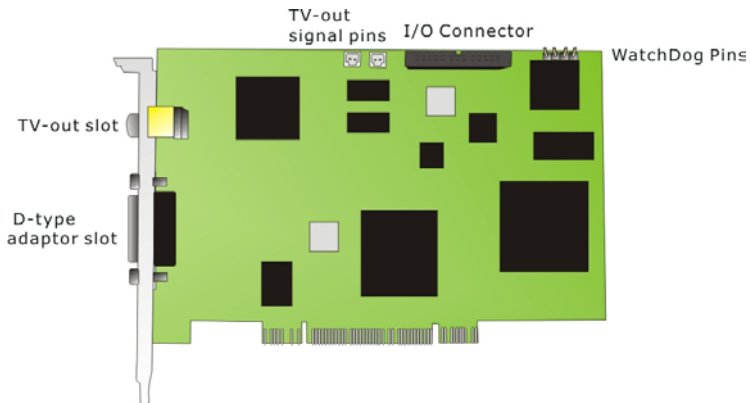

Product	Video Card	Specifications
NV 7000	1 card	One video capture card with 1 D-type connector and 1 TV-out slot

Manual Conventions

The following conventions are used throughout this manual.

Type	Stands for	Example
[paren.]	Keys on the keyboard	[Enter]
“Quotes”	Words to be typed in	“AVerMedia”
Italic	User in each authorization level	<i>Administrator</i>
Bold	Name of a dialog, Sections/Option title in the dialog/Field names/Buttons	Schedule Backup
Underlined	Table columns	<u>Start</u>



Caution Message: These messages are to advise you to proceed carefully. Failure to pay attention could result in damage to the system and may put personnel and environment at risk.



Informational Message: These messages are intended to provide additional information for the purpose of clarification.

LIMITED WARRANTY

AVerMedia TECHNOLOGIES, Inc. warrants that this product to be free of defects resulting from faulty manufacturing or components under the following terms:

WARRANTY LENGTH

Labor is warranted for 15 months from the date of purchase.

Replacement products will be warranted for the remainder of the 15-month warranty period or 30 days, whichever is longer.

WHO IS PROTECTED

This warranty is enforceable only by the first consumer purchaser.

WHAT IS AND IS NOT COVERED

Except as specified below, this warranty covers all defects resulting from faulty manufacturing of this product. The following are not covered by the warranty.

1. Any product on which the serial number has been defaced, modified, or removed.
2. Damage, deterioration, or malfunction resulting from:
 - A. Accident, abuse, misuse, neglect, fire, water, lightning, or other acts of nature, commercial or industrial use, unauthorized product modification, or failure to follow instructions included with the product.
 - B. Misapplication of service by someone other than the manufacturer's representative.
 - C. Any shipment damages. (Claims must be made with carriers.)
 - D. Any other cause that does not relate to a product defect.
3. Cartons, cases, batteries, cabinets, tapes, or accessories used with the product.
4. **AVerMedia TECHNOLOGIES, Inc.** does not warrant that this product will meet your requirements; it is your responsibility to determine the suitability of this product for your purpose.

Preface

WHAT WE WILL AND WILL NOT PAY FOR

We will pay labor and material expenses for covered items. However, we will not pay for the following:

1. Removal or installation charges.
2. Shipping charges.
3. Any incidental charges.

EXCLUSION OF DAMAGES

THE MANUFACTURER'S SOLE OBLIGATION AND LIABILITY UNDER THIS WARRANTY IS LIMITED TO THE REPAIR OR REPLACEMENT OF A DEFECTIVE PRODUCT AT OUR OPTION. THE MANUFACTURER SHALL NOT, IN ANY EVENT, BE LIABLE TO THE PURCHASER OR ANY THIRD PARTY FOR ANY INCIDENTAL OR CONSEQUENTIAL DAMAGE (INCLUDING, BUT NOT LIMITED TO, DAMAGES RESULTING FROM INTERRUPTION OF SERVICE AND LOSS OF BUSINESS) OR LIABILITY LIMITATIONS OF IMPLIED WARRANTIES.

There are no other oral or written warranties, expressed or implied, including but not limited to those of merchantability or fitness for a particular purpose. Any implied warranties are limited in duration to 15 months from the date of purchase.

STATE LAW AND YOUR WARRANTY

This warranty gives you specific legal rights, and you may also have other rights granted under state law. These rights vary from state to state.

CONTACT INFORMATION

Taiwan & International

No. 135, Jian Yi Rd., Chung Ho City, Taipei, Taiwan

TEL: 886-2-2226-3630

FAX: 886-2-3234-4842

Web Site: www.avermedia.com

Chapter 1 Installing Hardware

AVerMedia digital surveillance system is a digital surveillance system that supports Windows 2000/XP. Please follow the steps to install the hardware.

1.1 Hardware Recommendations



Please make sure you follow the minimum system requirement when putting together a PC for the NV series product. For a list of recommended motherboards, graphics cards, please go to: <http://www.avermedia.com/nvd/hardware-recom.htm>

Before you begin, please verify that your computer hardware specifications can meet your AVerMedia digital surveillance system requirements.

CPU	Pentium® 4 2.8GHz or above recommended
Motherboard	Intel 865, 875, 915 Chipset (VIA/SiS/ALi chipset motherboards temporarily not supported)
OS	Microsoft® Windows 2000 Pro./XP Pro.
Expansion Slots	1 / 2 / 3 / 4 × 32-bit PCI 2.1 compliant slots
RAM	DDR 512MB or above
Hard disk	120 GB of free hard disk space, at least 60GB free space for each partition.
Media	CD-ROM drive
VGA	16-bit high color SVGA graphic card with DirectDraw & YUV rendering capability, 64MB video memory at least
Audio	Sound card and speakers



For the latest information, please check www.avermedia.com/nvd/hardware-recom.htm

1.2 NV 1000/3000/5000/7000 Hardware Installation Combinations

The following instructions are for installing Video Capture Cards into the AVerMedia DVR digital surveillance system.

The DVR system has a powerful surveillance function and a flexible combination when you install the hardware. This table shows the numbers of audio devices, video channels, sensor inputs and relay outputs in different hardware combinations.

NV 1000 system hardware installation combinations:

Hardware Combinations			Number of Video channels	Number of Audio channels	Sensor Inputs	Relay Outputs
Video Capture Card Numbers	Video Extension Card Numbers	Audio / IO Card Number				
1	1	0	8	0	0	0
		1	8	1	4	3
	2	0	12	0	0	0
		1	12	1	4	3
	3	0	16	0	0	0
		1	16	1	4	3

NV 3000 system hardware installation combinations:

Hardware Combinations		Number of Video channels	Number of Audio channels	Sensor Inputs	Relay Outputs
Video Capture Card numbers	I/O + Audio Card Number				
1	0	4	0	0	0
	1	4	1	4	3
2	0	8	0	0	0
	1	8	1	4	3
	2	8	2	8	6
3	0	12	0	0	0
	1	12	1	4	3
	2	12	2	8	6
4	0	16	0	0	0
	1	16	1	4	3
	2	16	2	6	6

Chapter 1 Installing Hardware

NV 5000 system hardware installation combinations:

Hardware Combinations			Number of Video channels	Number of Audio channels	Sensor Inputs	Relay Outputs
Video Capture Card numbers	Video Extension Card numbers	Audio / IO Card Number				
1	0	0	4	0	0	0
		1	4	4	4	3
	1	0	8	0	0	0
		1	8	4	4	3
	2	0	12	0	0	0
		1	12	4	4	3
	3	0	16	0	0	0
		1	16	4	4	3
2	0	0	8	0	0	0
		1	8	4	4	3
	2	0	16	0	0	0
		1	16	4	4	3

NV 7000 system hardware installation combinations:

Hardware Combinations		Number of Video channels	Number of Audio channels	Sensor Inputs	Relay Outputs
Video Capture Card numbers	IO Card Number				
1	1	4	4	4	4
2	1	8	8	4	4
	2	8	8	8	8
3	1	12	12	4	8
	2	12	12	8	8
	3	12	12	12	12
4	1	16	16	4	4
	2	16	16	8	8
	3	16	16	12	12
	4	16	16	16	16

1.3 NV 1000 DVR Hardware Installation



Before installing the video card, turn off the computer's power, unplug the power cable and disconnect all other cables attached to the back of the computer.

Please follow the steps to install the system.

1. Remove the PC case cover.
2. Remove brackets for the PCI expansion slot. Save the screws.
3. Connect the Video Extension Cards and NV 1000 Video Capture Card with the connection cable.
4. Connect the Audio Card with the connection cables.
5. Insert the Video Capture Card, Video Extension Cards and the Audio Card into the available PCI slots and fix them.



It is important to fix the cards in sequence to avoid video transmission trouble.

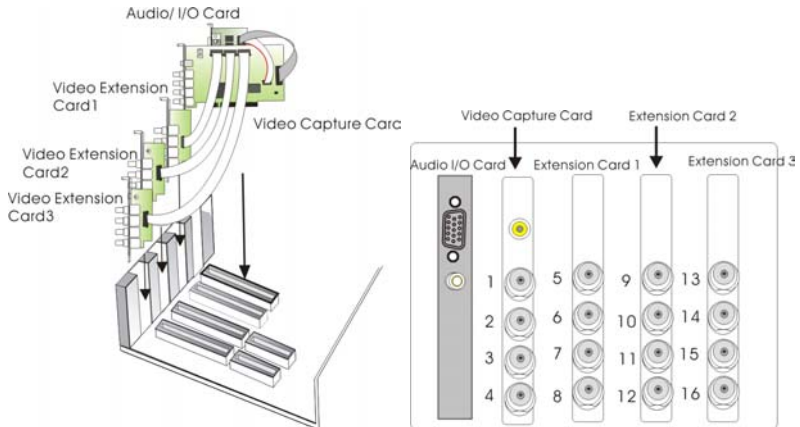

Chapter 1 Installing Hardware

1.4 NV 3000 DVR Hardware Installation



Before installing the video card, turn off the computer's power, unplug the power cable and disconnect all other cables attached to the back of the computer.

Users can purchase optional I/O Audio Cards if it is necessary.

1.4.1 Install One Video Capture Card and One Audio Card (Optional)

1. Please follow the steps to install the system. Remove the PC case cover.
2. Remove 2 brackets for the PCI slots. Save the screws.
3. Connect the Audio Card and the Video Capture Card with the connection cable.
4. Insert the Video Capture Card and I/O Audio Card and fix them.

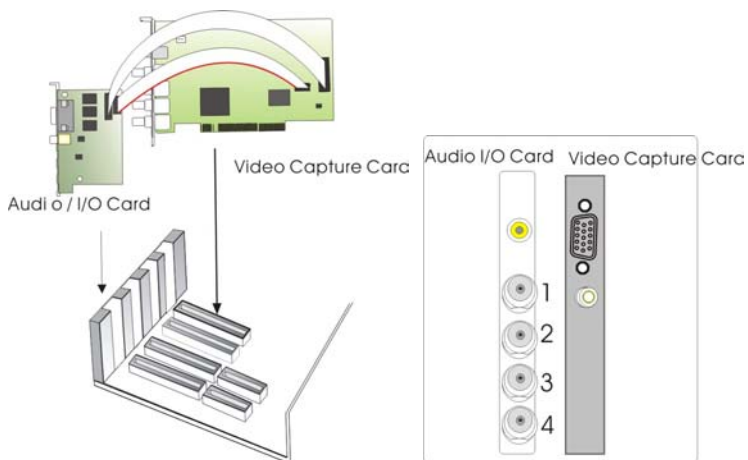

1.4.2 Install 2 Video Capture Cards and 2 Audio Cards

1. Please follow the steps to install the system. Remove the PC case cover.
2. Remove 4 brackets for the PCI slots. Save the screws.
3. Connect the Audio Card and the Video Capture Card with the connection cable.
4. Connect the 2 Video Capture Cards with a connection cable. Insert all the cards and fix them.



It is important to fix the cards in sequence to avoid video transmission trouble.

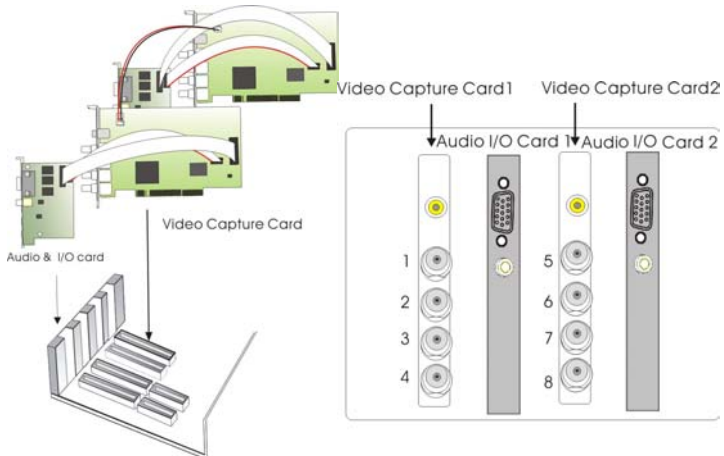

Chapter 1 Installing Hardware

1.4.3 Install 4 Video Capture Cards

Please follow the steps to install the system.

1. Remove the PC case cover.
2. Remove 4 brackets for the PCI slots. Save the screws.
3. Connect the Video Capture Cards with Connection cables.
4. Connect the 2 Video Capture Cards with a connection cable. Insert all the cards and fix them.



It is important to fix the cards in sequence to avoid video transmission trouble.

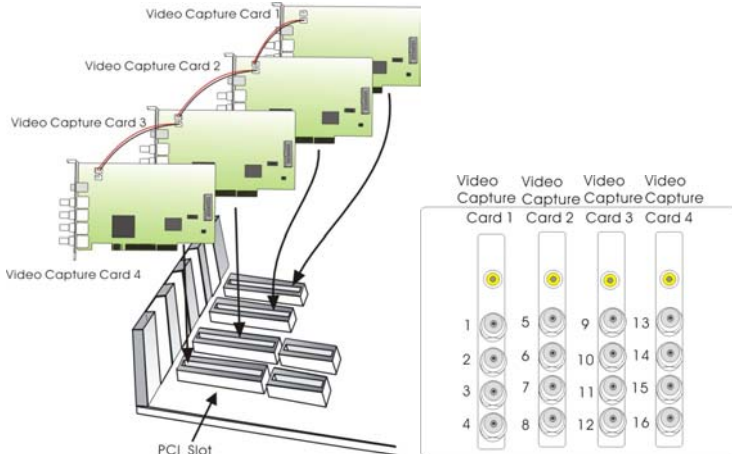

1.5 NV 5000 DVR Hardware Installation

1.5.1 Installing One AVerMedia DVR Video Capture Card



Before installing the video card, turn off the computer's power, unplug the power cable and disconnect all other cables attached to the back of the computer.

Please follow the steps to install the video capture card.

1. Remove the PC case cover.
2. Remove a bracket for the PCI expansion slot. Save the screw.
3. Insert the Video Capture Card into the available PCI slot and fix it.
4. The lower-right picture is the back panel of the Video Capture card.

NV 5000 Video Capture Card

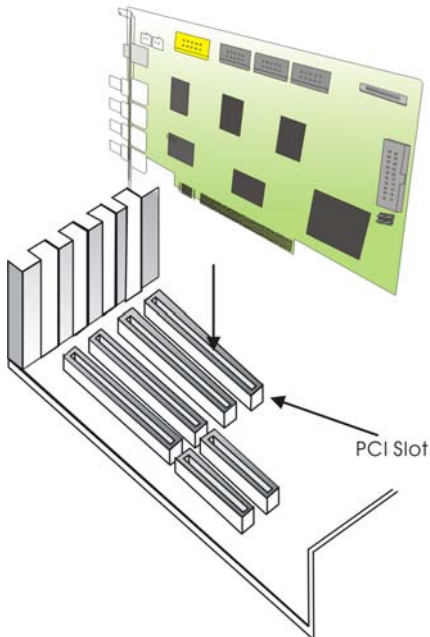

Video Capture Card

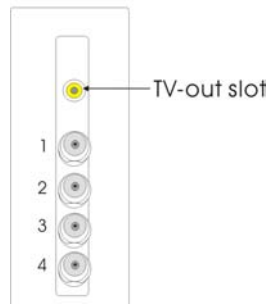

Chapter 1 Installing Hardware

1.5.2 Installing Optional I/O Audio Card and Video Extension Cards



Before installing the video card, turn off the computer's power, unplug the power cable and disconnect all other cables attached to the back of the computer.

Users can purchase an optional I/O Audio Card and Video Extension Cards if it is necessary.

1. Installing 1 Video Capture Card and 1 optional I/O Audio Card

For users who want to install 1 optional I/O Audio Card, please follow the steps.

1. Remove the PC case cover.
2. Remove 2 brackets for the PCI slots. Save the screws.
3. Insert the Video Capture Card and I/O Audio Card in PCI slots and fix them.
4. Connect the 2 cards with the I/O cable.
5. The back panel of the cards is shown as below.

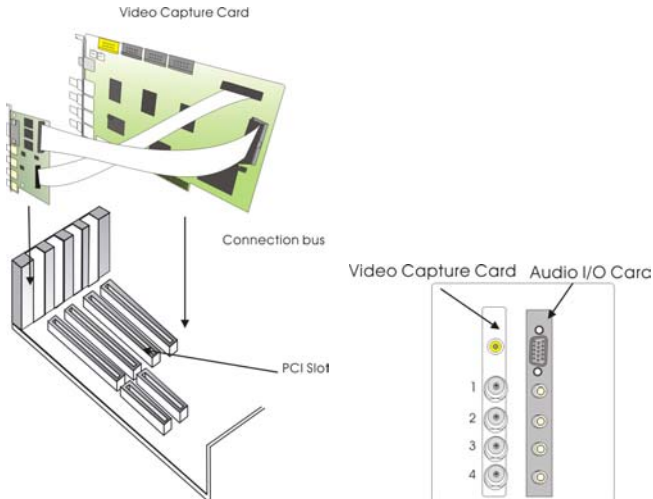

2. Installing 3 Optional Video Extension Cards

For users who want to install the Video Capture Card and 3 Video Extension Cards, please follow the steps.

1. Remove the PC case cover.
2. Remove 4 brackets for the PCI slots. Save the screws.

3. Insert the Video Capture Card and Video Extension Cards into the available PCI slots and fix them.



It is important to fix the cards in sequence to avoid video transmission trouble.

4. Connect the 4 cards with I/O cables as the following picture.
5. The lower-right picture is the back panel of 1 Video Capture card and 3 Video Extension Cards.

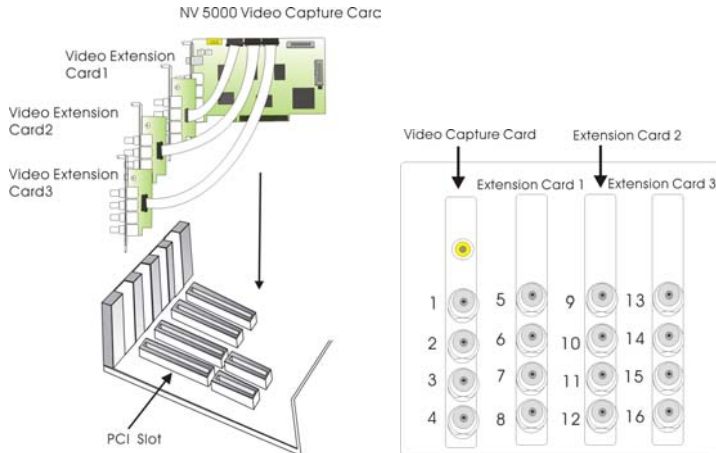

3. Install 1 Optional I/O Audio Card and 1 Video Extension Card

Please follow the steps to install the cards.

1. Remove brackets of PCI slots.
2. Insert the Video Capture Card, I/O Audio Card, and the Video Extension Card into the slots and fix them. The sequence of each card is as the lower-right picture.
3. Connect the cards with the connection cables as the lower-left picture.

Chapter 1 Installing Hardware

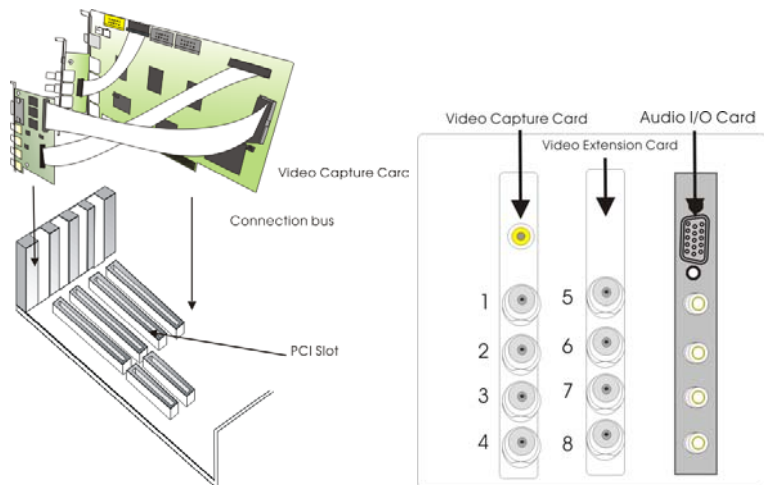

4. Installing 2 Video Capture Cards and 2 Video Extension Cards

For users who install 2 Video Capture Cards, please follow the steps.

1. Remove the brackets of PCI slots.
2. Insert the Video Capture Cards and Video Extension Cards into the PCI slots in sequence and fix them. You will see the back panel of each card as the lower right picture.
3. Connect the 2 Video Capture cards with the connection cable as the lower left picture.

AVerMedia NV1000/3000/5000/7000 User's Manual

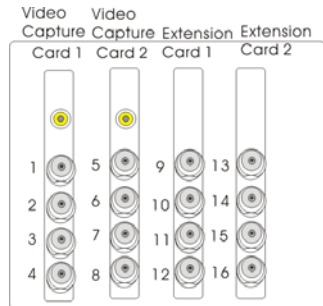
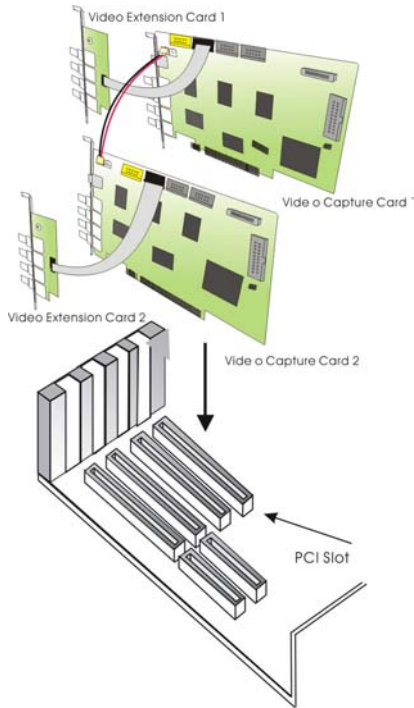

1.6 NV 7000 DVR Hardware Installation

1.6.1 Installing One AVerMedia NV 7000 Video Capture Card



Before installing the video card, turn off the computer's power, unplug the power cable and disconnect all other cables attached to the back of the computer.

1. Remove the computer cover.
2. Remove a bracket for the PCI expansion slot. Save the screw.
3. Insert the video capture card into the available PCI expansion slot and fix it as the right picture shows.

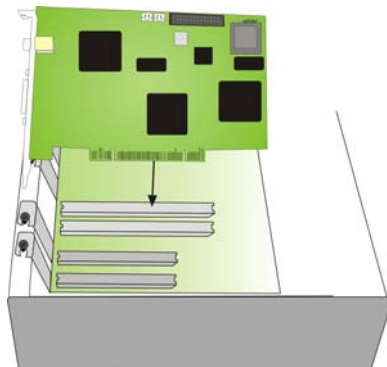

1.6.2 Installing 4 NV 7000 Video Capture Cards



Before installing the video card, turn off the computer's power, unplug the power cable and disconnect all other cables attached to the back of the computer.

For users who install more than 1 Video Capture Cards, please follow the steps.

1. Remove the computer cover.
2. Remove a bracket for the PCI expansion slot. Save the screw.
3. Connect cards with video lines as the right picture shows.



Chapter 1 Installing Hardware

1.6.3 Installing an I/O Card

Each Video Capture Card can come with an optional I/O card that enables to connect sensor inputs and relay outputs. For NV7000 users who only install an optional I/O card, please follow the steps.

1. Remove the computer cover.
2. Remove 2 brackets for PCI expansion slots. Save screws.
3. Connect the 2 cards with the I/O cable as the right picture shows.

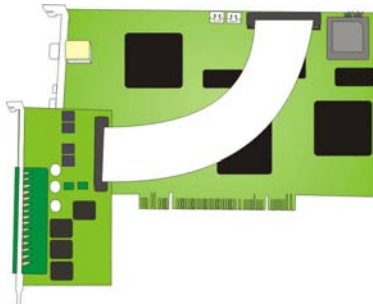

4. Insert the video capture card and the I/O card into the available PCI expansion slots and fix them.

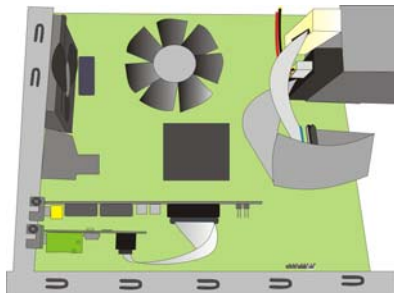

Chapter 1 Installing Hardware

1.7 Connecting the Watchdog line

1.7.1 Connecting the Watchdog line to NV 1000/3000/5000

After you finish installing the Video Capture Card, Video Extension Cards or the I/O Audio Card, please connect the reset cable of the PC case to the Video Capture Card, and then connect the Video Capture Card and Motherboard with the Watchdog line as the following picture.

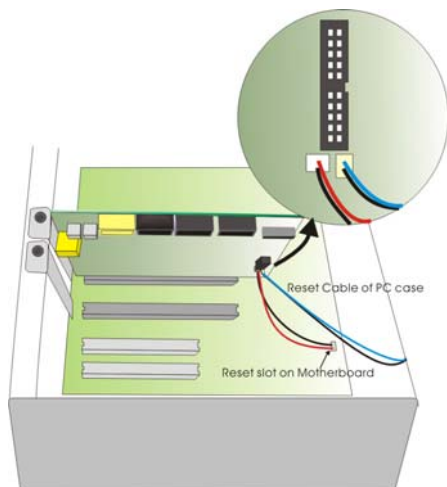

After connecting the Watchdog line and Reset Cable of the PC case, replace the PC cover and reconnect all the cables.

1.7.2 Connecting the Watchdog line to NV 7000



Before installing the video card, turn off the computer's power, unplug the power cable and disconnect all other cables attached to the back of the computer.

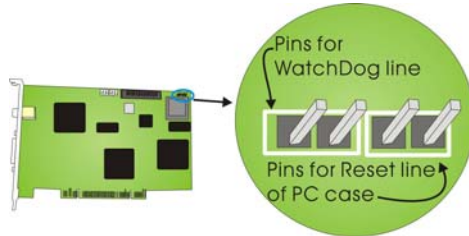

When you install ONE NV 7000 video capture card, please follow the instruction to connect the Watchdog line.

Remove the reset cable connector of your computer case, and plug in the slot. Please plug Watchdog cable connectors in both Video Capture Card slot and motherboard slot as the right picture.

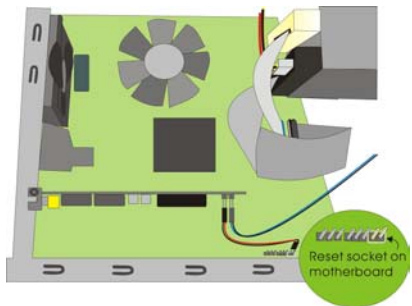

When you install FOUR NV7000 video capture cards, please follow the instruction to connect the Watchdog line.

Remove the reset cable connector of your computer case, and plug in the slot. Plug Watchdog cable connectors in a slot of one Video Capture Cards and plug another connector into motherboard slot as the right picture.

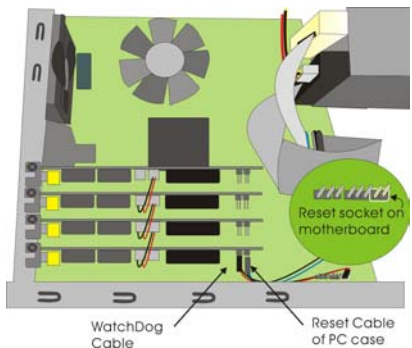

Chapter 1 Installing Hardware

1.8 Connecting Cameras and TV-out Cable

1.8.1 Connecting Cameras and TV-out Cable to NV 1000/3000/5000

After you finish installing the cards, please connect the BNC cable and the TV-out cable to the Video Capture Card as below figure. When you attach cameras to BNC connectors, please follow a numerical order indicated on the below figure to avoid transmission problem. Cameras need to be connected in sequence from the top to the bottom BNC terminals per card, starting from the left side to the right side on the chassis.

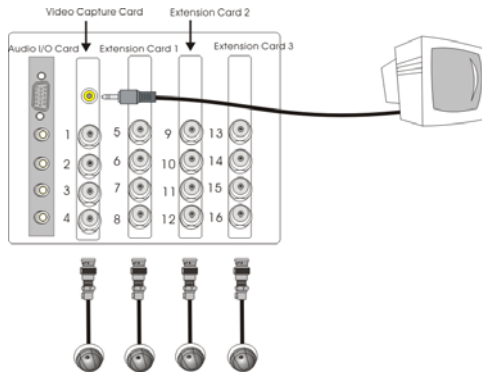

1.8.2 Connecting Cameras and TV-out Cable to NV7000

After you finish installing the video capture cards, please connect cameras, microphones, TV monitor, alarms and sensors as the following illustration.

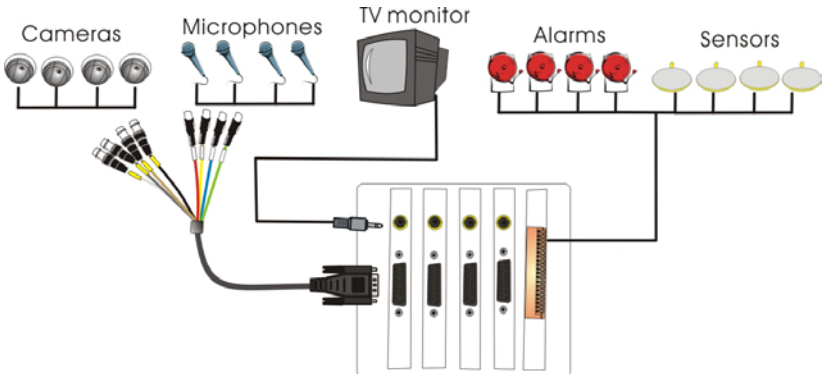

You must attach each camera and audio channel to the BNC connectors of the Video Capture card in a specific order to avoid transmission problems. The Video Capture card is stacked vertically into the chassis. Each Video Capture Card can support up to 4 cameras and 4 audio channels. 1 BNC cable contains 4 video connectors for cameras and 4 audio connectors for audio cameras.

The sequences of each camera connector and audio connector are marked on the cable. When you connect the connectors, please follow the numbers, which are marked on the BNC cable.

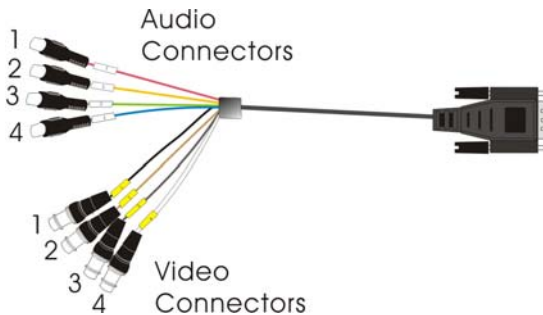

Video capture card numbers	Camera connecting sequence of BNC camera connector	Audio connecting sequence of BNC audio connector
Video Capture Card 1	Camera 1 to Camera 1	Audio 1 to Audio Channel 1
	Camera 2 to Camera 2	Audio 2 to Audio Channel 2
	Camera 3 to Camera 3	Audio 3 to Audio Channel 3
	Camera 4 to Camera 4	Audio 4 to Audio Channel 4
Video Capture Card 2	Camera 1 to Camera 5	Audio 1 to Audio Channel 5
	Camera 2 to Camera 6	Audio 2 to Audio Channel 6
	Camera 3 to Camera 7	Audio 3 to Audio Channel 7
	Camera 4 to Camera 8	Audio 4 to Audio Channel 8
Video	Camera 1 to Camera 9	Audio 1 to Audio Channel 9

Chapter 1 Installing Hardware

Capture Card 3	Camera 2 to Camera 10	Audio 2 to Audio Channel 10
	Camera 3 to Camera 11	Audio 3 to Audio Channel 11
	Camera 4 to Camera 12	Audio 4 to Audio Channel 12
Video Capture Card 4	Camera 1 to Camera 13	Audio 1 to Audio Channel 13
	Camera 2 to Camera 14	Audio 2 to Audio Channel 14
	Camera 3 to Camera 15	Audio 3 to Audio Channel 15
	Camera 4 to Camera 16	Audio 4 to Audio Channel 16

1.9 Connecting External Sensors/Relays to NV1000/3000/5000/7000

1.9.1 Connecting External Sensors/Relays to NV1000/3000/5000

The I/O Audio card enables you to connect 4 sensor inputs and 3 relay outputs. You need to use 1 D-type 15 Pin connector cable to connect the external I/O box and the I/O Audio card as below.

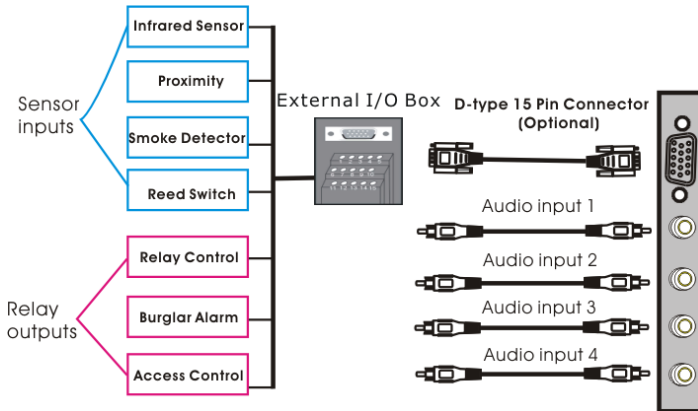

The optional I/O Audio card allows you to connect 4 audio inputs. Connect the audio cables to audio inputs if necessary.

The pin signal assignment of the external I/O box is as followed.

Sensor Inputs

You can attach external sensors such as infrared sensors, smoke detectors, proximity sensors, door sensors to the AVerMedia digital surveillance system's input-signal connectors on the I/O Audio Card. These devices trigger the system to respond with a predefined action (e.g. record video).

Chapter 1 Installing Hardware

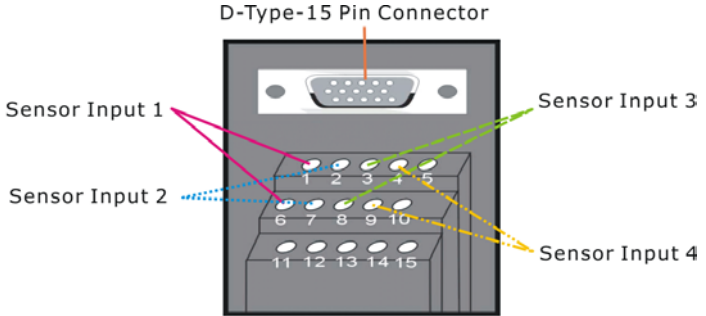

Sensor Inputs for External I/O Box

Relay Outputs

You can also attach external output control devices such as alarms to the AVerMedia digital surveillance system's output connectors (relay outputs). You can then configure the system to activate or deactivate these devices. Each AVerMedia video card supports 3 relay outputs. Two of them are normally open relays with one being a toggle switch.

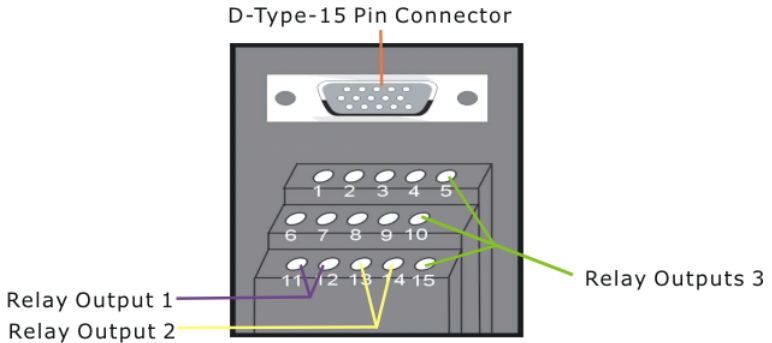

Relay Outputs for External I/O Box

Pin Signals and Specifications

The pin signals and specifications for the external I/O Box and the D-type 15-pin connectors are described below.

A. Sensor Input Specification

Absolute Maximum Ratings

(Ta=25°C)

Parameter		Symbol	Rating	Unit
Input	Forward Current	IF	50	mA
	Reverse Voltage	VR	6	V
	Power Dissipation	P	70	mW

Electrical/Optical Characteristics

(Ta=25°C)

Parameter		Symbol	Min.	Typ.	Max.	Unit	Conditions
Input	Forward Voltage	VF	—	1.2	1.4	V	IF=20mA
	Reverse Current	IR	—	—	10	A	VR=4V
	Terminal Capacitance	CI	—	30	250	pF	V=0, f=1KHz
Output	Collector Dark Current	ICEO	—	—	100	nA	VCE=20V
	Collector-Emitter Breakdown Voltage	BVCEO	35	—	—	V	IC=0.1mA
	Emitter-Collector Breakdown Voltage	BVECO	6	—	—	V	IE=10 A
Transfer Characteristics	*Current Transfer Ratio	CTR	50	—	600	%	IF=5mA, VCE=5V RBE=
	Collector Current	IC	2.5	—	30	mA	
	Collector-emitter Saturation Voltage	VCE(sat)	—	0.1	0.2	V	IF=20mA, IC=1mA
	Isolation Resistance	RISO	5 × 10 ¹⁰	10 ¹¹	—		DC500V, 40~60% R.H.
	Floating Capacitance	Cr	—	0.6	1.0	pF	V=0, f=1MHz
	Cut-off Frequency	fc	—	80	—	KHz	VCE=5V, IC=2mA RL=100 , -3dB
	Response Time (Rise)	tr	—	4	18	s	VCE=2V, IC=2mA
Response Time (Fall)	tf	—	3	18	s	RL=100	

*CTR= $\frac{I_C}{I_F}$ 100%

Relay Output Specification

Surge strength: 1500 VAC

Nominal power: 200mw ~ 360mw

Operating power: 110mw ~ 200mw

B. COIL RATINGS (at 20 °C)

Coil Nominal Voltage (VDC)	Coil Resistance ($\Omega \pm 10\%$)	Pick-up Voltage (VDC)	Drop-Out Voltage (VDC)	Nominal Current (mA)
5	125	3.75	0.5	40
* Max Continuous Voltage at 20°C : 110% of Coil Nominal Voltage				

C. CONTACT RATINGS

Contact Arrangement	1 Form C (SPDT)
max. Switch Power	125VA 60W
max. Switch voltage	125VAC 30VDC
max. Switch current	1A
Contact Resistance	\leq 100m Ω
Resistive Load	1A/125VAC 1A/30VDC
Contact Material	AgNi10

D. External I/O Box pin signals

Pin #	Definition
1	INPUT SIGNAL 1+
2	INPUT SIGNAL 2+
3	INPUT SIGNAL 3+
4	INPUT SIGNAL 4+
5	OUTPUT 3 – Normally Closed
6	INPUT SIGNAL 1-(GND)
7	INPUT SIGNAL 2-(GND)
8	INPUT SIGNAL 3-(GND)
9	INPUT SIGNAL 4-(GND)
10	OUTPUT 3 – Common
11	OUTPUT 1 – Normally Open
12	OUTPUT 1 – Common
13	OUTPUT 2 – Normally Open
14	OUTPUT 2 – Common
15	OUTPUT 3 – Normally Open

1.9.2 Connecting External Sensors/Relays to NV7000

The I/O Audio card enables you to connect 4 sensor inputs and 3 relay outputs. The pin signals for the I/O card are as followed. Please follow the pin signal assignments to connect the devices.

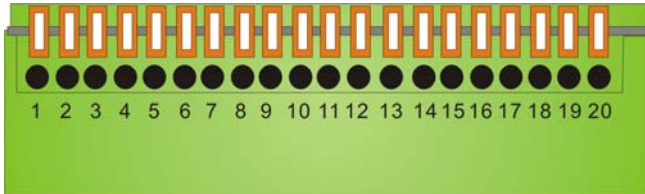

Pin #	Definition	Pin #	Definition
1	Sensor 1 input signal	11	Relay Normal Close 1
2	Sensor 1 output signal	12	Relay Comment 2
3	Sensor 2 input signal	13	Relay Normal Open 2
4	Sensor 2 output signal	14	Relay Normal Close 2
5	Sensor 3 input signal	15	Relay Comment 3
6	Sensor 3 output signal	16	Relay Normal Open 3
7	Sensor 4 input signal	17	Relay Normal Close 3
8	Sensor 4 output signal	18	Relay Comment 4
9	Relay Comment 1	19	Relay Normal Open 4
10	Relay Normal Open 1	20	Relay Normal Close 4

Sensor Inputs

You can attach external sensors such as infrared sensors, smoke detectors, proximity sensors, door sensors, etc., to the AVerMedia NV7000's input-signal connectors on the I/O card. These devices trigger the system to respond with a predefined action (e.g. record video).

Relay Outputs

You can also attach external output control devices such as alarms to the AVerMedia NV7000's output connectors (relay output). You can then configure the system to activate or deactivate these devices.

Chapter 1 Installing Hardware

Absolute Maximum Ratings

(Ta=25°C)

Parameter		Symbol	Rating	Unit
Input	Forward Current	IF	50	mA
	Reverse Voltage	VR	6	V
	Power Dissipation	P	70	mW

Electrical/Optical Characteristics

(Ta=25°C)

Parameter		Symbol	Min.	Typ.	Max.	Unit	Conditions
Input	Forward Voltage	VF	—	1.2	1.4	V	IF=20mA
	Reverse Current	IR	—	—	10	A	VR=4V
	Terminal Capacitance	CI	—	30	250	pF	V=0, f=1KHz
Output	Collector Dark Current	ICEO	—	—	100	nA	VCE=20V
	Collector-Emitter Breakdown Voltage	BVCEO	35	—	—	V	IC=0.1mA
	Emitter-Collector Breakdown Voltage	BVECO	6	—	—	V	IE=10 A
Transfer Characteristics	*Current Transfer Ratio	CTR	50	—	600	%	IF=5mA, VCE=5V RBE=
	Collector Current	IC	2.5	—	30	mA	IF=5mA, VCE=5V RBE=
	Collector-emitter Saturation Voltage	VCE(sat)	—	0.1	0.2	V	IF=20mA, IC=1mA
	Isolation Resistance	RISO	5×10^{10}	10^{11}	—	—	DC500V, 40~60% R.H.
	Floating Capacitance	CI	—	0.6	1.0	pF	V=0, f=1MHz
	Cut-off Frequency	fc	—	80	—	KHz	VCE=5V, IC=2mA RL=100 Ω, -3dB
	Response Time (Rise)	tr	—	4	18	s	VCE=2V, IC=2mA RL=100 Ω
Response Time (Fall)	tf	—	3	18	s	VCE=2V, IC=2mA RL=100 Ω	

$$*CTR = \frac{I_C}{I_F} \cdot 100\%$$

Relay Output Specification

Surge strength: 1500 VAC

Nominal power: 200mw ~ 360mw

Operating power: 110mw ~ 200mw

1.10 Connecting POS (Not Supplied)

Some users may install POS (Point of Sales) to facilitate the sales management. The system saves your time to install the POS system. Just connect your DVR system and POS with a RS232 cable as the following illustration.

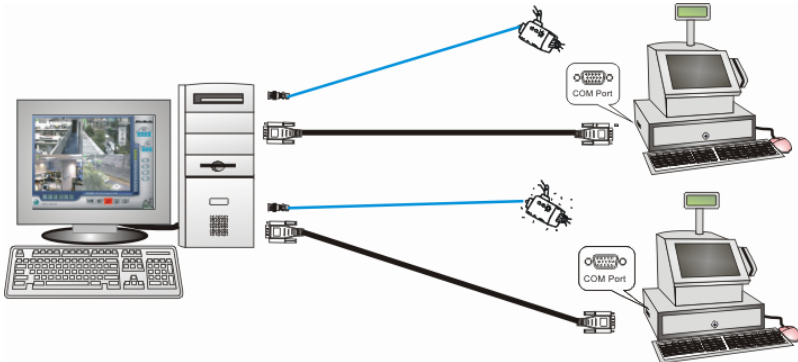

Connect the RS232 connectors to both POS and the digital surveillance system's COM ports respectively.

Chapter 2 Installing Software

This chapter describes how to install the Video Capture Card driver and required software to start and use AVerMedia DVR system.



Please update Windows patches and your Graphic Card driver before installing the DVR software.



Before you install the software that comes on the CD, please download the latest software from our website at the site listed below:

Worldwide

http://www.avermedia.com/cgi-bin/support_download.asp

US/CANADA

<http://www.aver.com/support>

2.1 Installing NV1000/3000/5000 Application Software

Once you have successfully completed installing Video Capture Cards, please follow the steps to install the DVR software first. After you completed the software installation, please install the driver.



Please disable hyper threading from your system BIOS before proceeding to install the software and driver for the NV product line.



Make sure to install the application before you install the driver to avoid unnecessary trouble.

Chapter 2 Installing Software

2.1.1 Installing NV1000/3000/5000 Application in Windows 2000/XP

After installing the hardware properly, please power on your computer and follow the steps to install the application.



If you have only one single hard drive, please divide the hard drive into two partitions. Install the Operating System onto the first partition (usually C drive) and use the second partition as your storage area for audio/video files and system log data. Remember to format both partitions into NTFS. Doing so will maintain an optimized system for your security needs.

1. Insert the Software CD to your CD-ROM driver and click Install Surveillance System to continue.



2. Click **Next** to continue.



3. Click **Yes** to accept the agreement. Click OK to continue.

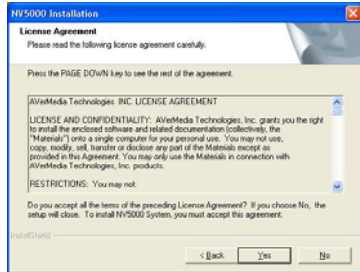

4. Enter the **Company Name** and **CDKey**.

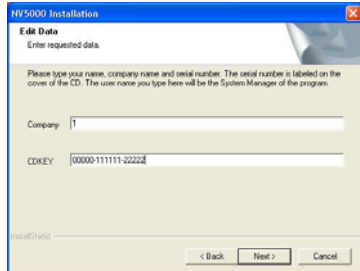

5. Enter User Name and Password. Click **Next** to continue.

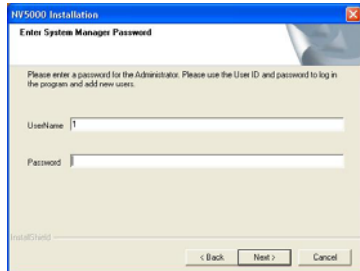

6. Select a program folder. Click **Next** to continue.

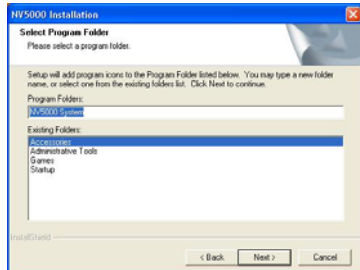

Chapter 2 Installing Software

7. Select a video system, and click **Next** to continue.

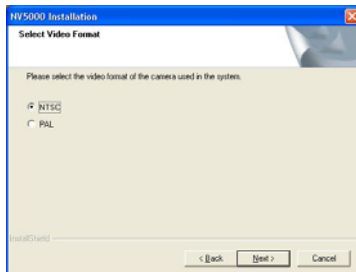

8. Select the Video Extension Card quantity and click **Next** to continue.

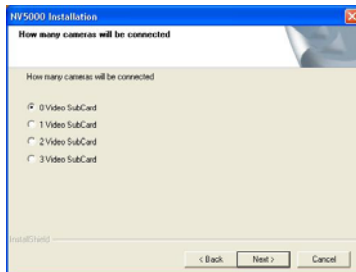

9. The system starts installing the application.

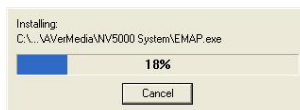

10. Select "**Yes, I want to restart my computer now**" and click **Finish** to complete the installation.

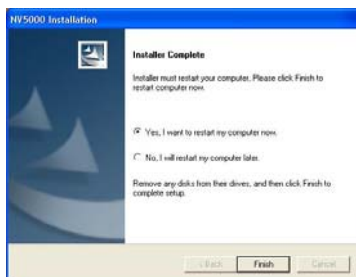

The system will reboot automatically to initiate a new setting after you finish the installation. You will see  on your desktop. Please install the driver before using the application.

2.2 Installing NV 7000 Application Software

Once you have successfully completed installing Video Capture Cards, please follow the steps to install the DVR software first. After you completed the software installation, please install the driver.



If you have only one single hard drive, please divide the hard drive into two partitions. Install the Operating System onto the first partition (usually C drive) and use the second partition as your storage area for audio/video files and system log data. Remember to format both partitions into NTFS. Doing so will maintain an optimized system for your security needs.



Make sure to install the application before you install the driver to avoid unnecessary trouble.

Chapter 2 Installing Software

2.2.1 Installing NV7000 Application in Windows 2000/XP

After installing the hardware properly, please power on your computer and follow the steps to install the application.

1. Insert the Software CD to your CD-ROM driver and click Install Surveillance System to continue.



2. Click **Next** to continue.

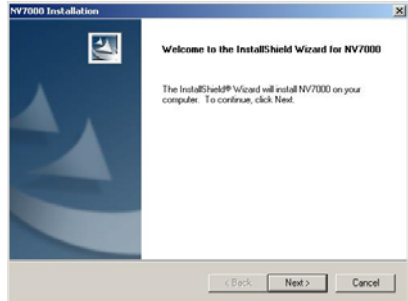

3. Click **Yes** to accept the agreement.
Click OK to continue.



4. Enter the **Company Name** and **CDKey**.

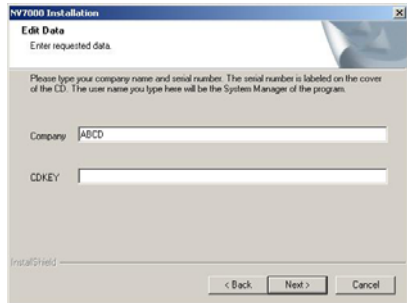

5. Enter **User ID** and **Password**. Click **Next** to continue.

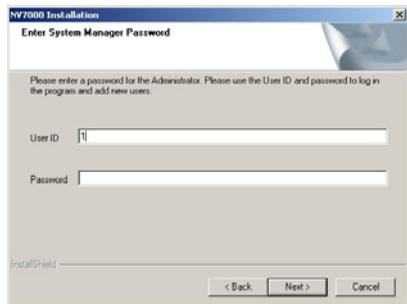

6. Select a program folder.
The default program folder name is **NV 7000**. Click **Next** to continue.

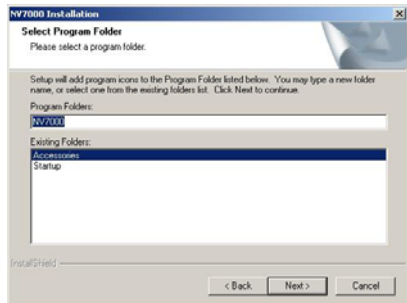

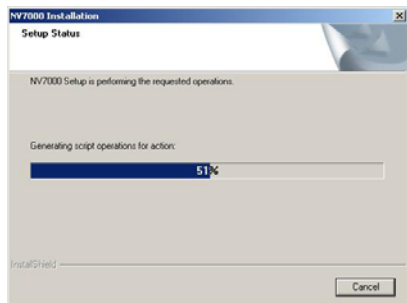

7. The system starts installing the application.

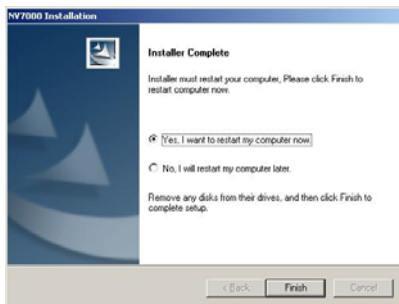

Chapter 2 Installing Software

9. Select **“Yes, I want to restart my computer now”** and click **Finish** to complete the installation.



The system will reboot automatically to initiate a new setting after you finish the installation. You will see  on your desktop. Please install the driver before using the application.

2.3 Installing NV1000/3000/5000 Driver

2.3.1 Installing NV1000/3000/5000 driver in Windows 2000

After the software installation, the system will reboot. Remove the software CD in the CD-Rom. The Windows system automatically detects a new hardware and show the following dialog box.

Click **Yes** to continue the installation.

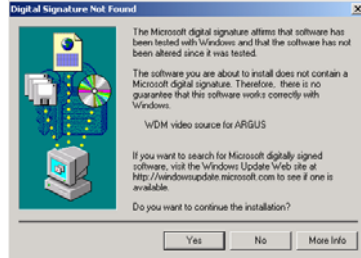

You will see the system installing the video driver as the right picture.

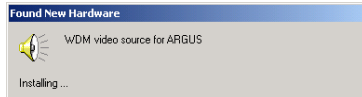

After finishing the installation, you will see the same dialog appears again. Repeat the same procedure until all the video drivers have been completely installed.

Continue to install the audio driver. You will see the right dialog box. Click **Yes** to continue the installation.



You will see the right picture when the driver is installing.

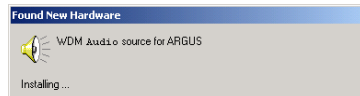

After finishing the first installation, you will see the same dialog appears again. Repeat the same procedure until all the video drivers have been completely installed.

After you finish the installation, please check the device manager to see if all the drivers are successfully installed.

Chapter 2 Installing Software

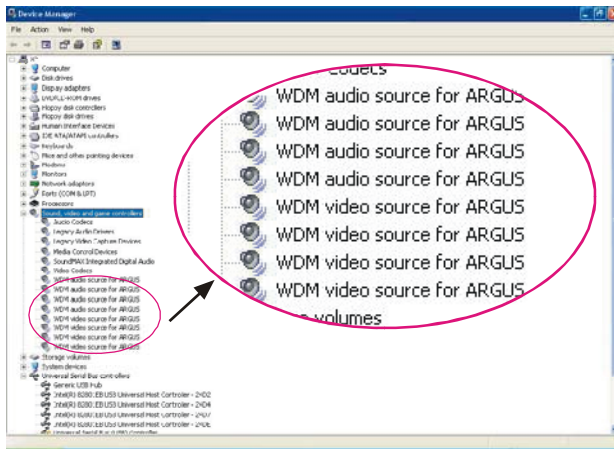

When your drivers are successfully installed, click  to run the surveillance system.

2.3.2 Installing NV1000/3000/5000 driver in Windows XP

After the software installation, the system will reboot. Remove the software CD in the CD-Rom. The Windows system automatically detects a new hardware and shows the right dialog box.

Please click **Cancel**. The system will start to search for the video driver. You will see the following dialog box.



After the searching, you will see the right dialog box.

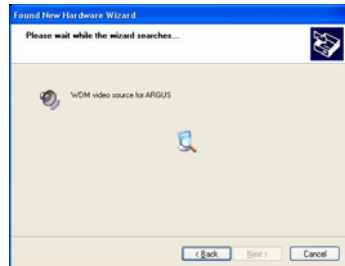

Please click **Continue Anyway** to install the driver. The system will show the installation status.



Chapter 2 Installing Software

You will see the following dialog box. Click **Finish**.



Repeat the same procedure until all the video drivers have been completely installed. After the video driver installation, the system will request to install the audio driver.

You will see the right dialog appear on the screen. Please click **Cancel**.



The system will search for the Audio driver. You will see the right dialog box.

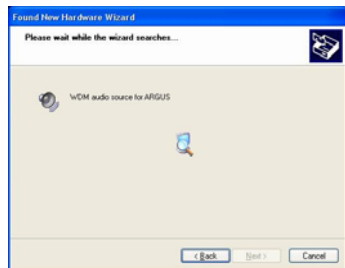

AVerMedia NV1000/3000/5000/7000 User's Manual

After the searching, you will see the right dialog box. Please click **Continue Anyway** to install the driver.



The system will show the installation status. Click **Finish**.



Repeat the same procedure until all the audio drivers have been completely installed.

After the audio driver installation, please check the device manager to see if all the drivers are successfully installed.

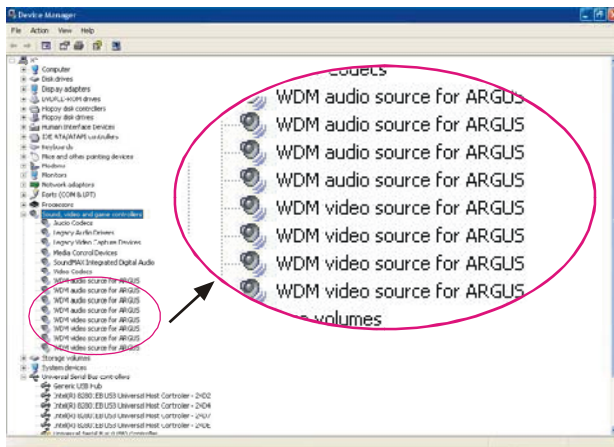

Chapter 2 Installing Software

When your drivers are successfully installed, click  to run the surveillance system.

2.4 Installing NV7000 Driver

2.4.1 Installing NV7000 driver in Windows 2000

After the software installation, the system will reboot. Remove the software CD in the CD-Rom. The Windows system automatically detects a new hardware and shows the following dialog box.

1. Click **NEXT** to continue the installation.



2. The system will start to search for the driver.

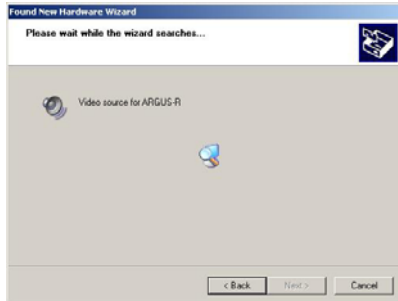

3. Click **Continue Anyway** to install the driver.



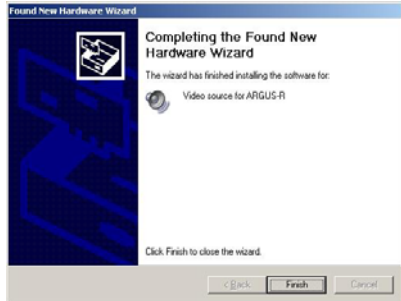

4. Click **Finish**.

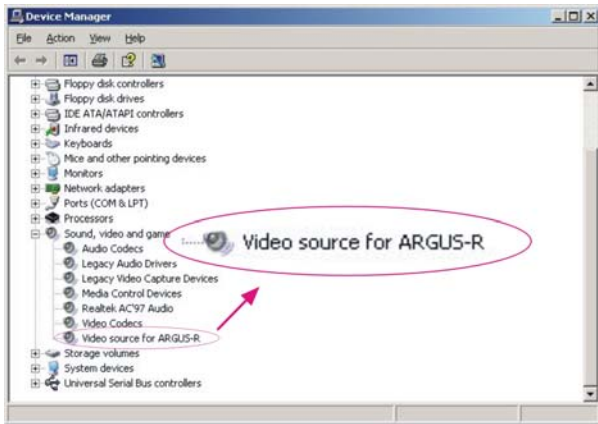

The system may repeat the driver installation according to the quantities of cards.

After you finish the installation, please check the device manager to see if all the drivers are successfully installed.



When your drivers are successfully installed, click  to run the surveillance system.

Chapter 2 Installing Software

2.4.2 Installing NV7000 driver in Windows XP

After the software installation, the system will reboot. Remove the software CD in the CD-Rom. The Windows system automatically detects a new hardware and shows the right dialog box

1. Please click **Cancel**. The system will start to search for the video driver. You will see the following dialog box.



2. After the searching, you will see the right dialog box.



3. Please click Continue Anyway to install the driver. The system will show the installation status.



4. Click **Finish**.



The system may repeat the driver installation according to the quantities of cards. After you finish the installation, please check the device manager to see if all the drivers are successfully installed.

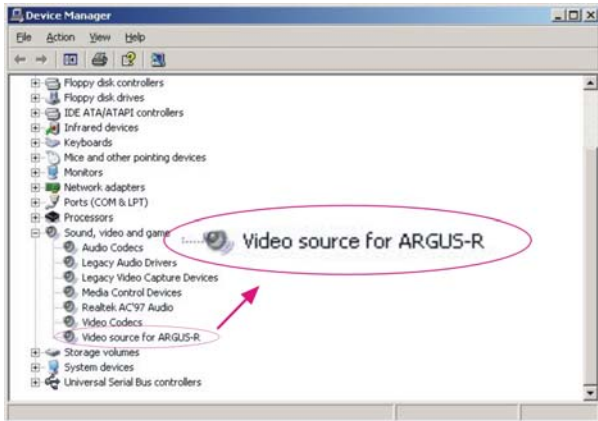

When your drivers are successfully installed, click  to run the surveillance system.

2.5 Removing Video Capture Card Driver

On occasion, it may become necessary to remove your video card software driver. To remove the driver, follow the steps described below.

1. Click **Start** and then go to **settings** to open **Control Panel**.
2. Double click **Add/Remove Program icon**.
3. Depending on your DVR version, select NV5000 or NV 7000. Click **Add/Remove** button to uninstall the program.

The operation system will request to reboot to initiate a new setting.

Chapter 3 Configuring the System



Before you start running the DVR system, please set your monitor resolution to 1024 x 768 and the color to 16-bit true color or above.

3.1 Logging in for the first time



Click  to initiate AVerMedia DVR system. The system will request an authorization when you initiate the system for the first time. **Enter the User ID and password that you set during the software installation.**

The image shows a software dialog box titled "Authorization". The text inside reads "Please enter your user ID and password." There are two input fields: "User ID" with the number "1" entered, and "Password" with four asterisks "****" entered. At the bottom of the dialog are two buttons: "OK" and "Cancel".

If you have successfully logged in, the Monitor Screen will appear.



Chapter 3 Configuring the System

3.1.1 Introducing the Functions buttons on Display/Playback



The application screens used in this manual are from NV 5000 system.

Monitor Screen









The functions of buttons on the Monitor Screen are as followed.

1. Exit

Click this item to minimize or exit the system. The DVR system will confirm your authorization before it shuts down. Enter your user ID and password and click **OK**. You can find the software information and update the latest software version in "About" dialog.

2. Split Screen Display

The DVR system provides 6 split display modes for your selection. You can select one of the split display modes by clicking the following icon.

-  1-Cam display
-  4-Cam split display
-  9-Cam split display
-  16-Cam split display
-  8-Cam split display
-  13-Cam split display

If you only have 4 cameras connected, the 8-Cam/9-Cam/13-Cam/16-Cam split display modes will be disabled automatically.

3. Date/Time/Free Space

2004/08/02 13:15:05 Free Space=4.61 GB

This bar shows the current time, frame size and the hard disk's free space.

4. Recording



Click  to start recording. The button turns red when it is recording. Click it again to stop.

5. E-Map



Click  to load your desired map according to your demands. You can change an E-map and locate cameras, sensors, and relays to desired positions. The DVR system can support up to 8 E-maps. Load BMP or JPG files as E-Maps.

6. Network



Click  to allow inbound connections. When this function is enabled, the button turns red. Click it again to disable all inbound connections.

7. System Configuration



You can configure camera setting, record setting, network setting, schedule setting, backup setting, sensor setting, relay setting, alarm setting and user setting by clicking  button.

8. PTZ



Click  to configure an appointed PTZ camera. It will pop-up a PTZ setup dialog. Users can configure a PTZ camera according to their demands.

9. Display/Playback



Users can switch between **Monitor Screen** and **Playback Screen** by clicking the buttons.

10. Camera ID



In the Camera ID area, you can see number icons of the cameras. Under 1-Cam

Chapter 3 Configuring the System

display mode, you can click a desired button to play the desired channel. After you click the icon, it turns yellow. If you assign a split display mode and appoint a camera number, the icon group of the cameras will turn yellow altogether.

11. Event Log

You can check **Event, Operation, POS (Point of Sales), System** and **Network** logs by clicking this icon. The Event Log Viewer dialog will appear. Select a desired date and an log item, the lower table will show all logs of the assigned event.

12. POS (Point of Sales)

DVR provides a function of POS to record sales records including the items, time, and quantities. When the cashier scans the barcodes of goods, the related sales information appears on the mapped channels. You can use POS to search an appointed purchase record or trace abnormal purchase records to avoid the loss of money.

13. Auto Scan

Click this button to start Auto Scan. It will cycle the screens according to the split display mode.

14. Full Screen mode

Click this button to turn to full screen mode.

15. Relays

The icon shows which relays that are triggered. Once the relays are triggered, the indicators will turn yellow according to the relay number. The top-down array of the indicators are from the left top to the right down.

16. Sensors

The icon shows which sensors that are triggered. Once the sensors are triggered, the indicators will turn yellow according to the sensor number. The top down array of the indicators are from the left top to the right down. For advanced alarm information, please click  to view the alarm status.

17. Audio Volume Adjustment

Click the icon to adjust the audio volume to a proper volume. You can Mute the channels by selecting the Mute box.

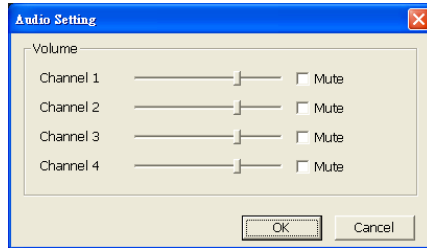

Playback Screen

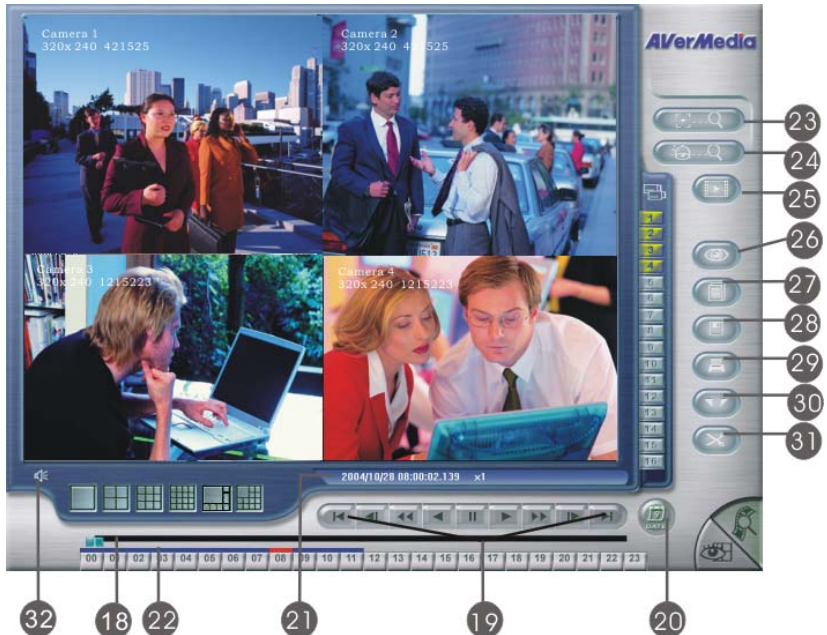

18. Slider

Drag the scroll box to go forward/backward to the desired event.

19. Playback Control Buttons



Begin: Move to the beginning of the video recording.









Previous: Go back to the previous frame.



Slower: Play the video recording at the speed of 1/2x, 1/4x, or 1/8x

Chapter 3 Configuring the System

-  **Rewind:** Play the video file reversely.
-  **Pause:** Stop playing the recording file.
-  **Play:** Play the recording file.
-  **Faster:** Play the video recording at the speed of 2x, 4x, or 8x.
-  **Next:** Go to the next frame.
-  **End:** Go to the end of the video recording.

20. Select Play Date

You can play an appointed recording by assigning a playing date. Click  to select a desired date to play the recording.

21. Date/Time /Play Speed Status

This bar shows the recording date, time and play speed of the data.



22. Time Buttons

The DVR system adopts 24-hour as time format. A blue bar on top of a time button indicates that there are videos during the time period. Click the desired time button to play back the videos that were recorded during the appointed time. The blue bar above the selected button will turn red.

23. Intelligent Search

DVR enables users to appoint a desire area to detect motion in the appointed area. Once the system detects motion in that area, it stops. Click  and the system will skip to the next motion event in that area.

24. Event Search

Users can appoint your system to search a desired event. Click  to setup the camera and the desired event you want to search. Click  to see the next event you want to search.

25. Find Next

When you enable Intelligent Search or Event Search, you can click  for the next search or the next event.

26. Visual Search

The system provides several time modes for visual searching, such as searching by day, searching by hour, searching every 3-minute, searching every 10-second and searching by second. The system will keep a stream of static pictures under the visual search mode so that you can find out the process of the desired event

through these serial images.

27. Event Log 

Click  to see **event, operation, POS, system** or **network** logs. Select date and an event item. The system will show the logs in the lower table in the Event Log Viewer dialog.





28. Save 

The DVR system allows you to save static recording images. You can catch a recording image and save it as a BMP or a JPG file.

29. Print 

Print the image by clicking .

30. Set Segment 

You can catch a desired segment of the recording file by setting segments. Click  to mark the beginning/ending of a segment. You will see a  and  on the slider. To cancel the triangles, click  again.

31. Output Segment 

After you finish setting the segment, you can output the desired segment by clicking . The system appears a dialog to ask for the storage path.

The system will name the output segment according to the time of the video.

32. Audio Volume Adjustment 

Click the icon to adjust the audio volume to a proper volume. You can mute the channels by selecting the Mute box.

3.2 Configuring DVR

When you first use the DVR system, please follow the steps to finish your configuration. Move the cursor to the  button, and it turns purple. Click it to turn it red and you will see DVR Configuration Setup dialog.



Chapter 3 Configuring the System

3.2.1 System Setting

Click  to configure basic settings.

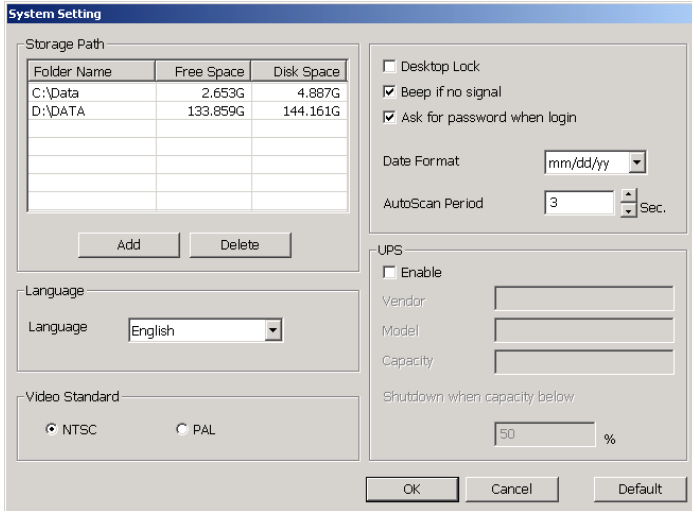

The System Setting dialog box is divided into several sections:

- Storage Path:** A table with columns for Folder Name, Free Space, and Disk Space. It contains two entries: C:\Data (2.653G Free Space, 4.887G Disk Space) and D:\DATA (133.859G Free Space, 144.161G Disk Space). Below the table are 'Add' and 'Delete' buttons.
- Language:** A dropdown menu currently set to 'English'.
- Video Standard:** Radio buttons for 'NTSC' (selected) and 'PAL'.
- Desktop Lock:** Checkboxes for 'Desktop Lock' (unchecked), 'Beep if no signal' (checked), and 'Ask for password when login' (checked).
- Date Format:** A dropdown menu set to 'mm/dd/yy'.
- AutoScan Period:** A numeric input field set to '3' with 'Sec.' to its right.
- UPS:** A section with an 'Enable' checkbox (unchecked), and input fields for 'Vendor', 'Model', and 'Capacity'. Below these is a 'Shutdown when capacity below' input field set to '50' with a '%' symbol.

At the bottom of the dialog are 'OK', 'Cancel', and 'Default' buttons.

1. Storage Path

You can see the current storage path. To change the path or add a new storage path, please click **Add** and select a desired folder. To delete a path, please select the path and click **Delete**. There must be at least one storage path.

The system will automatically recycle the oldest recorded file in storage path when free space is not enough to record one hour data.



Free space of each storage need to have at least 8 GB in the beginning.

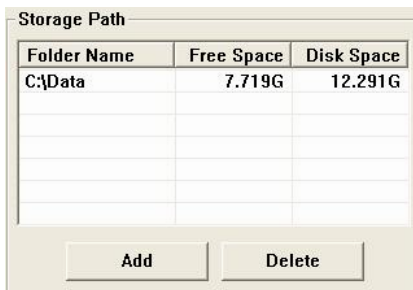

2. Desk Top lock

The DVR system provides a desktop lock function to avoid any mischievous system shutdown. You can select "Desktop Lock" to lock the tool tray on desktop to avoid unauthorized users using hot keys (Ctrl + Alt + Del) or  to shutdown the DVR application.



3. Beep if no signal

You can tick the box to enable the function, Beep if no signal, and click **OK** to keep the setting. Click the box again to cancel it.



4. Ask for password when login

You can tick this box to enable this function, **Ask for password when login**, and click **OK** to keep this setting. When this function is enabled, users need to enter a password when they login. To disable this function, please cancel the box.

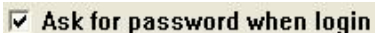

5. Date format

You can appoint the date format by dragging the list. Select an ideal format.



6. Auto scan period

You can appoint the auto scan period when enabling this function. Click  to adjust the time period and click **OK** to keep the setting. The system will display the cameras, stay for an appointed period and then cycle the next batch of cameras automatically.

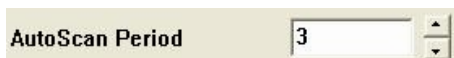

Chapter 3 Configuring the System

7. Language

You can click the drop-down list to select a desired language. The default language is English.



Language

Language English

8. Video System

Please select a proper video system according to your local video system. For NTSC system, please select NTSC. For PAL system, please select PAL. If you choose a wrong video system, the video recording will not appear normally.

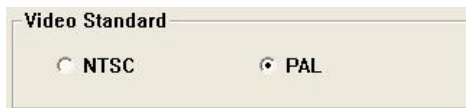

Video Standard

NTSC PAL

9. UPS (Uninterruptible Power Supply)

It enhances security for the system to warn administrators and users if AC power fails. It also enables the system to shutdown before the end of battery backup power is reached. The UPS device should be connected to your computer (refer to your UPS user's guide) before the presetting of this task.

- A. Check **Enable** to activate UPS meanwhile the **Vendor** as well as **Model** of your UPS will appear in the individual boxes if your UPS is completely connected.
- B. Determine a limited value in the blank of **Shutdown when capacity below** __%. The value is ranged between 10 and 90%. It is unavailable to be set lower than 10% or higher than 90%. **When the capacity of your UPS is below this the appointed percentage, DVR will be shut down automatically.**

UPS

Enable

Vendor

Model

Capacity

Shutdown when capacity below %



The UPS application must meet Window NT or above system requirements. Windows 2000 or Windows XP are recommended.

Chapter 3 Configuring the System

3.2.2 Camera Setting

Click  to set up the cameras.



1. Camera Icons

The bar below shows cameras that are connected to your DVR systems. When the number inside the camera icon lights up, it means the camera is connected to the system. A DVR system supports up to 16 cameras.



To set up the camera, just click desired camera icon. When you configure an appointed camera, the camera icon turns red. Right click to select multiple camera icons or tick "All" box to select all cameras. When you select all cameras, the screen inside the window will show "Multiple channels".

2 Enable

After you select a camera icon, you can decide to enable this camera or not. Tick the box to enable this camera and then click **OK** to keep the setting. To disable the camera, just leave the Enable box blank.

3 Camera

Display: After enabling the camera, the default setting allowed you seeing the real-time video on the screen. If you need video recorded but don't want to show the real-time video, uncheck the Display box..

Name: Enter a name for the camera.

Comment: Enter some descriptions for the camera.

Click  to enter the camera name and comment if you don't have a keyboard.



4 Video Adjustment

You can adjust the following items of a video.

Brightness: Drag the scroll box to adjust the brightness of the image when you enable the display. The higher the number is, the brighter the video is. The right figure next to the Brightness bar shows the brightness scale of the video.

Contrast: Drag the scroll box to adjust the contrast of the image when you enable the display. The right number next to the Contrast bar shows the contrast percentage of the video.

Hue: Drag the scroll box to adjust the hue of the image when you enable the display. The right number next to the Hue bar shows the hue scale of the video.

Saturation: Drag the scroll box to adjust the saturation of the image when you enable the display. The right number next to the Saturation bar shows the saturation scale of the video.

5 Noise Reduction

The DVR provides a feature, Noise Reduction, to reduce image noises of channels, thus the video images will become clearer.

Select **"Noise Reduction"** box to enable this function on Camera Setting dialog. When Noise Reduction is enabled, the system will filter unnecessary noise and

Chapter 3 Configuring the System

make video image clearer when you preview or playback the video file.

6 Auto Brightness Control and Night View

The video image quality of outside cameras may be affected by insolation and weather, thus the image can be too strong or too weak. The system provides **“Auto Brightness Control”** to improve image quality and avoid vague images when the objects are too bright or too dark. Select **“Auto Brightness Control”**. When video signals from cameras are too strong or too weak, the system will help adjust to a proper brightness according to the real situation.

When **Auto Adjustment Control** is enabled, you can select **“Night View”** to intensify the night view image. **“Night View” enables users to see objects clearer in dark places.** When Night View is enabled, you will find objects brighter and the image qualities improve. The following images indicate the difference before and after enabling the Night View function.



Before using Night View

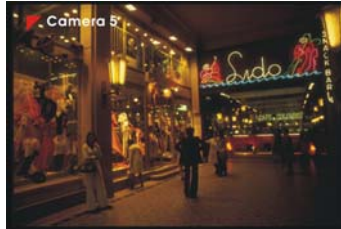

After using Night View

Click **OK** to keep the adjustments after you adjust the camera settings.

3.2.3 Recording Setting (Video and Audio)

Click  to configure the recording setting.

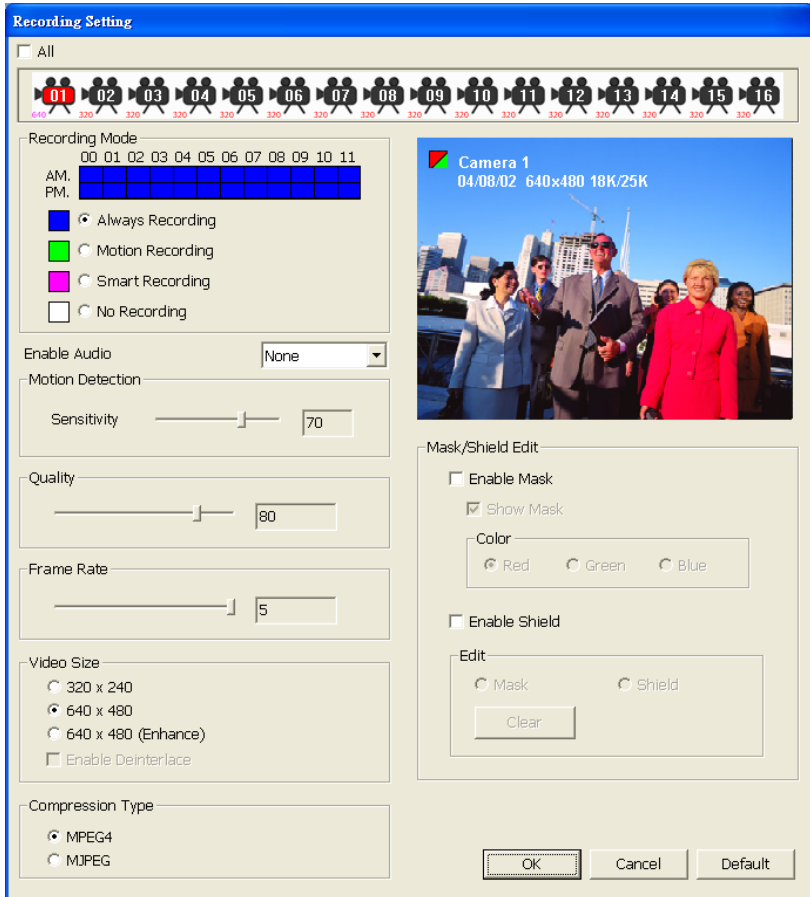

1 Camera Icons

The bar below shows cameras that are connected to your digital surveillance system. When the number inside the camera icon lights up, it means the camera is connected to the digital surveillance system. It supports up to 16 cameras. The number on the left lower corner represents the video size of the channel.

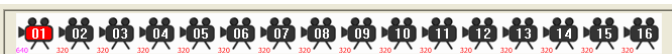

Chapter 3 Configuring the System

To set up the camera, just click the desired camera icon. When you configure an appointed camera, the camera icon turns red.

Right click to select multiple camera icons or tick “All” box. When you select all cameras, you will see the following picture.

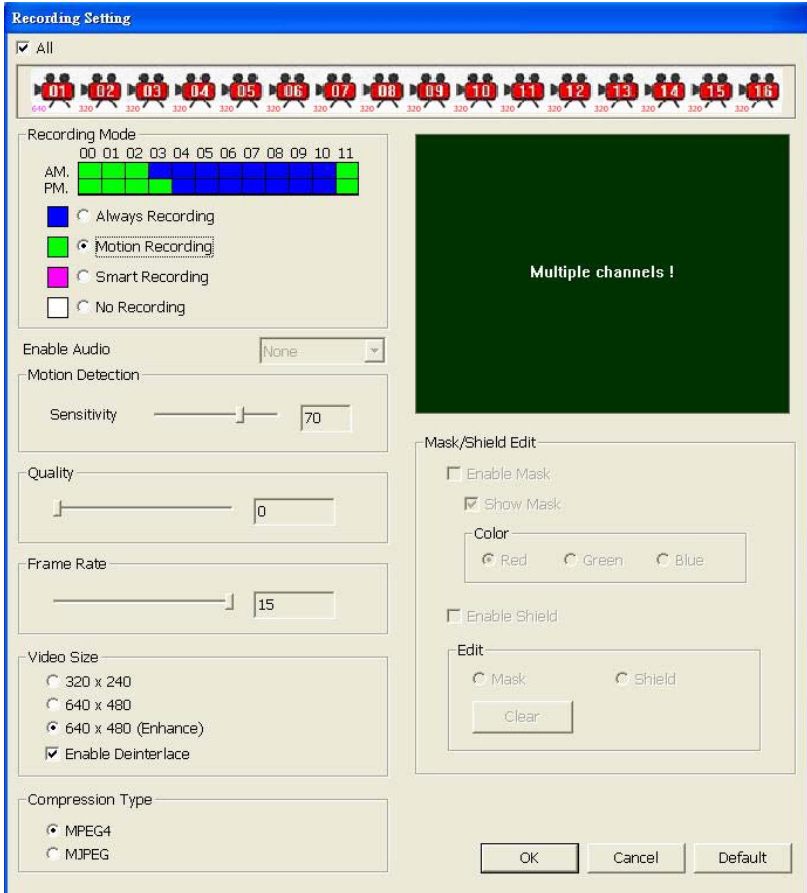

When you select all cameras, the screen inside the window will show “Multiple channels”.

2 Recording Mode

The system provides a time bar for recording selection. Each block represents one hour and the hours count from 00:00 to 12:00. On the left side of the time bar, you can tell the AM/PM marks.

	00	01	02	03	04	05	06	07	08	09	10	11
AM.	Blue	Blue	Green	Green	Pink	Pink	Blue	Blue	Blue	Blue	Blue	Blue
PM.	Blue	Blue	Green	Green	Pink	Pink	Blue	Blue	Blue	Blue	Blue	Blue

Users can define the recording mode in appointed hours according to their demands. The default setting is always recording which means the blocks on the time bar are all blue.

You can select one of the recording modes:

Always Recording: The system will record this appointed channel when it starts to monitor. When it starts to record, a red triangle mark appears at the upper-left corner on each screen of the channel. The recorded video file will be kept to the appointed storage path.

Click to set 24-hour recording mode, or you can click to change recording mode for each hour separately.

Motion Recording: The system will record once it detects any motion. The DVR system will record 10 frames before the motion is detected. When it starts to record, a red triangle mark appears at the upper-left corner on each screen of the channel. The recording files will be kept to the appointed storage path. Under this recording mode, the DVR won't record any video unless it detects any motion.

Click to set 24-hour recording mode, or you can click to change recording mode for each hour separately.

Smart Recording: The system records one frame per second if it does not detect any motion. When the system detects motion, it will keep on recording until the motion stops.

Click to set 24-hour recording mode, or you can click to change recording mode for each hour separately.

No Recording: The system won't record this channel's video.

Click to set 24-hour recording mode, or you can click to change recording mode for each hour separately.

Click to return to "Always recording" if you want to cancel previous recording mode.

3 Enable Audio:

For NV1000/3000/5000 users, select an audio channel to map the video channel if you want to monitor and record the audio of this appointed channel with video. NV1000/3000/5000 system allows 4 audio channels. Users can select ONE desired channel and map it to the video channel that is monitoring. A red triangle mark will be at the upper-left corner on each screen of the channel. Cancel it if you don't want to monitor and record audio. When you connect to the Audio/ IO card, the function will be activated.

For NV 7000 users, click the box and the correct audio source if you want to monitor and record the audio of the appointed channel.

4 Motion Detection

You can drag the scroll box to adjust the motion detection sensitivity to your desired scale. When it detects a motion, a green triangle mark appears at the upper-left corner on each screen of the channels. The higher the value is, the better the sensitivity the system can detect. The figure on the right side shows the sensitivity scale.

5 Quality

You can adjust the video quality by dragging the scroll box. The scale ranges from 0 to 100. The higher the value is, the better the video quality becomes. The right figure shows the current quality scale.



The file size of quality 100 will be larger, and it will shorten the recording time.

6 Frame Rate

This sets the number of images per second of video that is recorded. You can adjust the video frame rate to your desired rate by dragging the scroll box. The frame rate ranges from 1 to 30 (For NTSC, it is 1-30; For PAL, it is 1-25). The higher frame rate, the larger the recorded files.



The max frame rate will vary from different product configuration.

7 Video Size

For NV 1000/3000/5000 users, the system provides 3 sizes for selection: 320 × 240, 640 × 480, 640 × 480 (enhanced). Though the default system camera setting is resolution 320x240, **the system supports up to 16 cameras of**

resolution 640x480. You can modify the setting to resolution 640x 480 for a better video image quality.

The higher resolution will result in a larger video size. **640x480 (enhanced) mode provides a higher video quality than 640x480 mode, thus the image quality will be better; however, the file size recorded by 640x480 (enhanced) mode will become larger.**

When you adopt 640x480 (enhanced) mode, the system provides a “**Deinterlace**” function to make the video clearer when the system records moving objects. “**Deinterlace**” enables the system to eliminate some disturbing lines and make the video clear and smooth

For NV 7000 users, the system provides 2 sizes for selection: 352 × 240, 720 × 480 (NTSC) or 720 x 576 (PAL). The higher resolution will result in a larger video size. When you adopt 720 × 480 (NTSC) or 720 x 576 (PAL) mode, the system provides a **Deinterlace** function to make the video clearer when the system records moving objects.

When the system is recording objects of a moving process, it records 30fps or 25fps every second depending on the visual systems (NTSC/PAL). Each frame will consist of two sub-frames, or “fields”. When these fields are merged into the full frame, interlace lines appear where the fields differ (usually due to motion). When you select “**Deinterlace**”, the system will de-interlace the lines and make the motion smoother.

When you select 640x480 (enhanced) mode, the system will allow you to tick **Enable Deinterlace** to enable this function.



Resolution 640 × 480 mode will occupy much CPU resource. When you select this video size, please check your hardware specification to avoid unnecessary trouble.

8 Compression Type

The system provides 2 compression types: **MPEG4** and **MJPEG**. If you select **MJPEG** (lower compression ratio), the file size is bigger. If you select **MPEG4** (higher compression ratio), the recorded file will be smaller.



NV 7000 only supports MPEG4 compression format.

9 Mask/Shield Edit

Tick **Shield** or **Mask** box according to your demands.

- 10 **Mask:** Tick **Mask** box to enable this function. You can tick “**Show Mask**” and select a color. Move your cursor to the screen and then click the left button to mask a specific area. To cancel the mask area, you can select **Mask** in **Mask/Shield Edit** column and then click **Clear**.

When you enable Mask and assign a masked area, the system will **NOT** detect any motion in the masked area. When it detects motions outside the marked area, the upper-left corner of the screen will appear a green triangle mark.



Once the area is marked as a mask area, there won't be any motion detection. The images of the masked area will be meshed.

Shield: Tick the **Shield** box to enable Shield. Move your cursor to the screen and then click the left button to shield a specific area. The marked area will be shielded. That means the DVR system doesn't show, detect and record the shielded area. To cancel the shielded area, you can select **Shield** in **Mask/Shield Edit** column and then click **Clear**.





NV 7000 does not provide the Shield function.

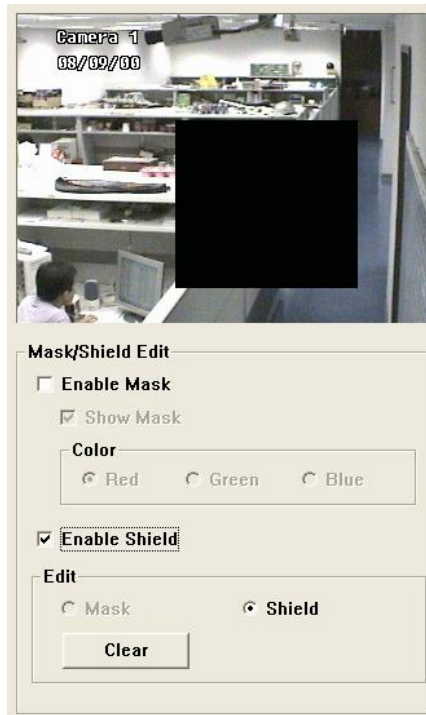

Please use Shield very carefully to avoid missing any important video data.



Click **OK** to save settings. You will return to the DVR configuration setup screen. Click  to return the main menu. You need to click  on Monitor Screen to record the video, and the system will begin to record according to the settings here.

Chapter 3 Configuring the System

While the recording task is in process, the icon turns red. Click the icon again to stop the recording task. The icon will return to gray.

3.2.4 Network Setting

Click  to start the networking configuration.



Network Setting

All

Transmitting Cameras

1 2 3 4 5 6 7 8
 9 10 11 12 13 14 15 16

Server Configuration

IP: 192.168.153.185

PORT: 8080

Webcam PORT: 80

Enable Handy View

Dynamic DNS

Domain Name:

Password:

Voice Phone

Talk to Web-Client

PORT: 9999

Transmitting Cameras

Transmitting cameras allow users to monitor remotely. You can decide which cameras can be remotely monitored. Tick "all" box to select all camera numbers, or select the desired camera numbers respectively.

Server Configuration

IP: You need to enable remote view server via TCP/IP. The system will catch the fixed IP address automatically.



If you have two Network Interface Cards in the system, it will catch the first IP. Execute "IPCONFIG" in Command Prompt to know the IP sequence.

Port: Please enter the port for a remote console. The default port is 8080.

WebCam PORT: Please enter the WebCam port. The default port is 80.

Enable Handy View: The system provides “Handy View” function to enable remote users to use a PDA or a mobile phone for remote monitor. Select the item, **Enable Handy View**, to enable remote users to connect the DVR server by PDA or mobile phone. For more information, please check **5.3 Handy View**.

Dynamic DNS: If your system uses a dynamic IP address, please go to <http://ddns.avers.com.tw> and register a dynamic domain name and password first. Select this item and enter the proper domain name and password to enable dynamic DNS. If you enable this function without entering the domain name and the password, the system will show an error message. For more information, please refer to **Appendix A Registering Domain Names**. DDNS provided by other DDNS provided are acceptable.

After you finish the network configuration, click  to keep the settings. You will return to the Monitor Screen. Click  to enable inbound connections from the client.



Voice Phone: The system provides a 2-way audio function to enable **ONE** WebCam user to have a free talk with **ONE** server user each time by using microphone via Intranet or Internet. Thus, a remote user and the DVR user can talk to each other directly by microphone via network.

Select **“Talk to Web-client”** to enable the administrator to talk to the client PC user, thus they can communicate via network. The default port is 9999.

If the server user does not want to talk to the Web client user, don't select **“Talk to Web-client”**. The server user can still hear the voice from the web client user, but he/she cannot answer the voice phone.





Before using the 2-way audio, please make sure both the speakers and microphones of your client PC and servers are working properly.

Click  to keep the setting or  to cancel the setting.

Chapter 3 Configuring the System

3.2.5 Schedule Setting

Click  to setup Schedule. You can schedule recording, backup or reboot schedule by day or by period. Click  or  to adjust to a proper month. The system will mark the present date.

August, 2004						
Sun	Mon	Tue	Wed	Thu	Fri	Sat
25	26	27	28	29	30	31
1	2	3	4	5	6	7
8	9	10	11	12	13	14
15	16	17	18	19	20	21
22	23	24	25	26	27	28
29	30	31	1	2	3	4

You will see a drop-down list on the upper right place. Drag the list to select a schedule task. The items in the list are below.

←
August, 2004
→

Sun	Mon	Tue	Wed	Thu	Fri	Sat
25	26	27	28	29	30	31
1	2	3	4	5	6	7
8	9	10	11	12	13	14
15	16	17	18	19	20	21
22	23	24	25	26	27	28
29	30	31				

←
September, 2004
→

Sun	Mon	Tue	Wed	Thu	Fri	Sat
				1	2	3
4	5	6	7	8	9	10
11	12	13	14	15	16	17
18	19	20	21	22	23	24
25	26	27	28	29	30	1
2	3	4	5	6	7	8
9						

Record ▼

WEEKLY

ONE TIME

	00	01	02	03	04	05	06	07	08	09	10	11	12	13	14	15	16	17	18	19	20	21	22	23
08/08 Sun																								
08/09 Mon																								
08/10 Tues																								
08/11 Wed																								
08/12 Thur																								
08/13 Fri																								
08/14 Sat																								

Save
Clear

OK
Cancel

Record: If you select **Record** as the task, the system will have all cameras start recording at the scheduled time. The task you set here has higher priority than the

recording mode you set for each camera. That means, even if you have set the camera to **"Motion Recording" mode**, the cameras will still start **"Always recording"** mode at the scheduled time.

Click **Save** to store the schedule setting of this task. Click **Clear** to remove all schedule setting of this task.

Schedule Setting

August, 2004 | September, 2004

Backup: WEEKLY

Backup To: F:\Data

	00	01	02	03	04	05	06	07	08	09	10	11	12	13	14	15	16	17	18	19	20	21	22	23
08/08 Sun																								
08/09 Mon																								
08/10 Tues																								
08/11 Wed																								
08/12 Thur																								
08/13 Fri																								
08/14 Sat																								

Save Clear OK Cancel

Backup: If you select **Backup** as the task, the system will have cameras start backup all data at the scheduled time. Please assign a storage path for backup files. It will detect the video files in the assigned folder and then check which files that the system needs to backup. Thus, it will copy the un-backup video data to the desired destination. Click **Save** to store the schedule setting of this task. Click **Clear** to remove all schedule setting of this task.



Backup path is not allowed to be set in the same disk drive where storage path existed.

Chapter 3 Configuring the System

Schedule Setting

August, 2004 September, 2004 Reboot

Sun	Mon	Tue	Wed	Thu	Fri	Sat	Sun	Mon	Tue	Wed	Thu	Fri	Sat
25	26	27	28	29	30	31				1	2	3	4
1	2	3	4	5	6	7	5	6	7	8	9	10	11
8	9	10	11	12	13	14	12	13	14	15	16	17	18
15	16	17	18	19	20	21	19	20	21	22	23	24	25
22	23	24	25	26	27	28	26	27	28	29	30	1	2
29	30	31					3	4	5	6	7	8	9

WEEKLY
 ONE TIME

	00	01	02	03	04	05	06	07	08	09	10	11	12	13	14	15	16	17	18	19	20	21	22	23
08/08 Sun																								
08/09 Mon																								
08/10 Tues																								
08/11 Wed																								
08/12 Thur																								
08/13 Fri																								
08/14 Sat																								

Save Clear OK Cancel

Reboot: If you select **Reboot** as the task, the system will reboot at the appointed time. Once it reboots the system successfully, the system will not reboot again in the same hour.

Click **Save** to store the schedule setting of this task. Click **Clear** to remove all schedule setting of this task.



If your Windows® operation system requests User name and Password to logon, please enter the administrator's name and Password for the OS. Thus the DVR system won't be hanged to the Windows® logon screen when it reboots.

Schedule Setting

◀ August, 2004
September, 2004 ▶

Sun	Mon	Tue	Wed	Thu	Fri	Sat	Sun	Mon	Tue	Wed	Thu	Fri	Sat
25	26	27	28	29	30	31				1	2	3	4
1	2	3	4	5	6	7	5	6	7	8	9	10	11
8	9	10	11	12	13	14	12	13	14	15	16	17	18
15	16	17	18	19	20	21	19	20	21	22	23	24	25
22	23	24	25	26	27	28	26	27	28	29	30	1	2
29	30	31					3	4	5	6	7	8	9

Enable Network ▾

WEEKLY

ONE TIME

	00	01	02	03	04	05	06	07	08	09	10	11	12	13	14	15	16	17	18	19	20	21	22	23
08/08 Sun																								
08/09 Mon																								
08/10 Tues																								
08/11 Wed																								
08/12 Thur																								
08/13 Fri																								
08/14 Sat																								

Enable Network: When you select Network and set a schedule in **Schedule Setting**, the system will allow inbound connections to monitor remotely during the appointed period of time. After the appoint time, the connection service will be stopped.

Click **Save** to store the schedule setting of this task. Click **Clear** to remove all schedule setting of this task.



If you enable the Network function manually before schedule time, the connection service will not be stopped after the appointed time.

Chapter 3 Configuring the System

Schedule Setting

August, 2004

25	26	27	28	29	30	31
1	2	3	4	5	6	7
8	9	10	11	12	13	14
15	16	17	18	19	20	21
22	23	24	25	26	27	28
29	30	31				

September, 2004

			1	2	3	4
5	6	7	8	9	10	11
12	13	14	15	16	17	18
19	20	21	22	23	24	25
26	27	28	29	30	1	2
3	4	5	6	7	8	9

Disable Alarm ▾

WEEKLY

ONE TIME

	00	01	02	03	04	05	06	07	08	09	10	11	12	13	14	15	16	17	18	19	20	21	22	23
08/08 Sun																								
08/09 Mon																								
08/10 Tues																								
08/11 Wed																								
08/12 Thur																								
08/13 Fri																								
08/14 Sat																								

Save

Clear

OK

Cancel

Disable Alarm: The **Disable Alarm** will disable the alarm function temporarily during the assigned period of time. Users can fully use this function and avoid unnecessary alarms during specific time. After the appointed time, the alarm function will execute automatically as it is configured.

There are 2 schedule modes to run the assigned task.

WEEKLY

ONE TIME

Weekly: Move the cursor to mark the desired time and date. The system will execute the same task automatically every week. Click Clear to clean the previous schedule setting. For instance, if you would like to assign DVR to record from 6:00 AM to 12:00 AM through Monday to Friday, you can mark the schedule as the above picture. Click **OK** to keep the setting. DVR will execute the task from 6:00 AM to 12:00 AM every week.



You can only set future dates for a schedule. Dates in the past are not accepted.

One Time: When you select **One Time** as a single schedule unit, it means the system executes the recording only one time during the appointed hours. You can move your cursor to the calendar and appoint a specific date and time to record. Click **Save** to keep the setting or click **Clear** to clear the setting. The above figure shows a schedule by day. You can set multiple dates for a single task. DVR will execute the task at the appointed schedule automatically.

Chapter 3 Configuring the System

3.2.6 Backup Setting

Click  to backup the recording files. The Backup Setting dialog will appear.

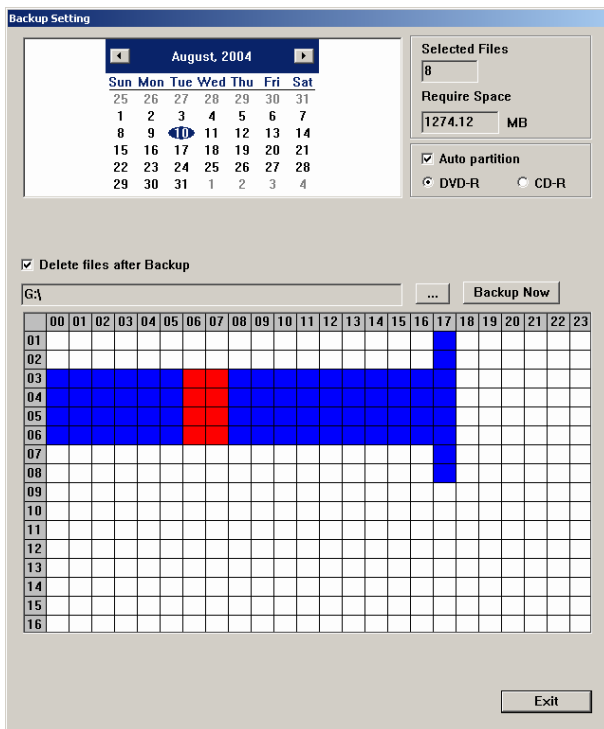

1. Calendar

Choose a backup date. The circled date is consistent with the system date.

2. Backup files Information

Selected Files: Blue blocks mean that there are video recording data during the period of time. Select the desired blue blocks to backup the recording. The selected files will turn red. The DVR system will calculate the number of backup files automatically and calculate the required space.

Required Space: The size of selected files.

3. Auto Partition

Tick the box and select the below partition category, the system will backup and divide its recording files in proper sizes to facilitate burning into portable media.

For example, if you backup the files in CD-R partition, it will backup and pack the files into several folders. Each size is smaller than 650Mb.

4. Delete files after Backup

Delete files after Backup: Tick **Delete files after Backup** to delete the selected files after backup. Cancel the tick to keep the file in the server.

5. Select backup files storage path

Click to select backup files storage path.

6. Backup Table

At the bottom of backup setting page, you can see a table. Below are the names of each item in the table.

00	01	02	03	04	05	06	07	08	09	10	11	12	13	14	15	16	17	18	19	20	21	22	23	Recording Time
----	----	----	----	----	----	----	----	----	----	----	----	----	----	----	----	----	----	----	----	----	----	----	----	----------------

01
02
03
04
05
06
07
08
09
10
11
12
13
14
15
16

Camera number

- (Blue): recording video file
- (Red): selected file
- (White): No video file

The following table shows the system recorded Channel 1 to Channel 4's video files during 8 A.M. to 11A.M.

	00	01	02	03	04	05	06	07	08	09	10	11	12	13	14	15	16	17	18	19	20	21	22	23
01																								
02																								
03																								
04																								

Chapter 3 Configuring the System

Click the blue blocks to assign the desired backup files. The appointed backup files turn red. Click **Cancel** to clear all the selected files. After backup files are selected, the system will calculate the file quantities and required space automatically, and show the results on the screen. Click **Backup Now** to backup the selected files.

3.2.7 Sensor Setting

Click  to set up sensors. This function will be activated after IO devices in the system are installed correctly.

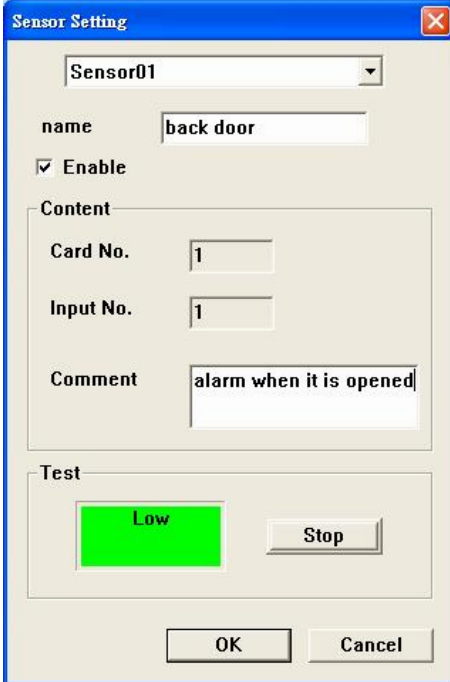

Sensor Setting

SensorID: Sensor01

name: back door

Enable

Content

Card No.: 1

Input No.: 1

Comment: alarm when it is opened

Test

Low Stop

OK Cancel

1. Sensor ID

Assign a sensor by clicking the drop-down menu , and enter its name in the name field.

2. Enable

Tick **Enable** to enable this sensor. Cancel the tick to disable the sensor.

3. Content

After you enable the appointed sensor, the system will automatically show the Card No. and Input No. in the following Content column. Enter the comment in the blank.

The following illustrations of the sensor inputs describe the pin assignments.

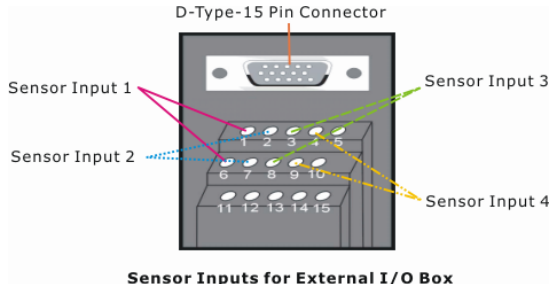

Sensor Inputs for External I/O Box
External I/O box for NV 1000/3000/5000

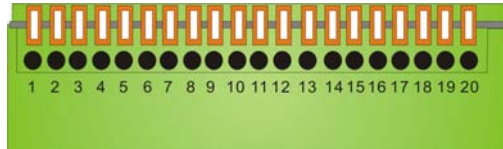

The optional NV 7000 I/O card

Chapter 3 Configuring the System

The following table shows NV 7000 I/O card pin assignments.

Pin #	Definition	Pin #	Definition
1	Sensor 1 input signal	11	Relay Normal Close 1
2	Sensor 1 output signal	12	Relay Comment 2
3	Sensor 2 input signal	13	Relay Normal Open 2
4	Sensor 2 output signal	14	Relay Normal Close 2
5	Sensor 3 input signal	15	Relay Comment 3
6	Sensor 3 output signal	16	Relay Normal Open 3
7	Sensor 4 input signal	17	Relay Normal Close 3
8	Sensor 4 output signal	18	Relay Comment 4
9	Relay Comment 1	19	Relay Normal Open 4
10	Relay Normal Open 1	20	Relay Normal Close 4

4. Test

After installing the sensors, you can test the sensors immediately. Click to find the sensor status: **High** electricity(Red) or **Low** electricity(Green).

Click to finish the setting or click to cancel the setting.

3.2.8 Relay Setting

Click  to set up relays.

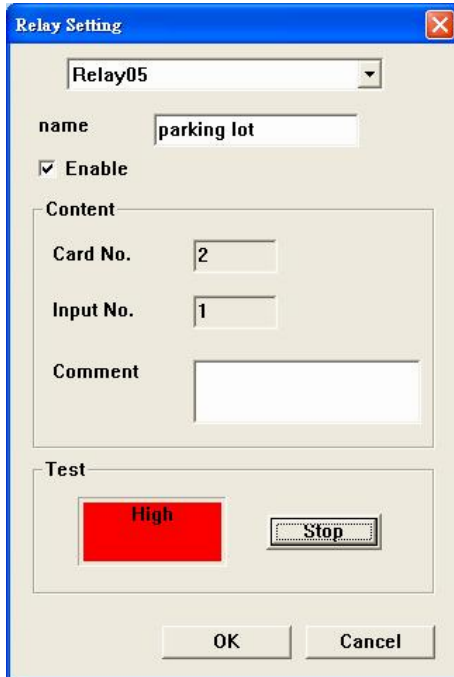

Relay Setting

Relay05

name parking lot

Enable

Content

Card No. 2

Input No. 1

Comment

Test

High Stop

OK Cancel

1. Relay ID

Assign a relay by clicking the drop-down menu , and enter its name in the name field.

2. Enable

Tick **Enable** to enable this relay. Cancel the tick to disable the relay.

3. Content

After you enable the appointed relays, the system will automatically show the Card No. and Input No. in the following Content column. You can see the following illustration of the relay inputs. Enter the comment in the blank.

Chapter 3 Configuring the System

Content

Card No.

Input No.

Comment

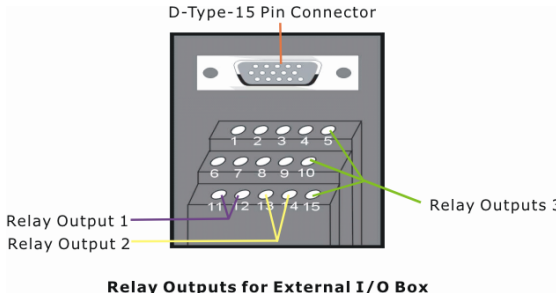

4. Test

After installing relays, you can test relays immediately. Click to find the relay status: or .

Click to finish the setting or click to cancel the setting.

After finish configuring sensors and relays, you can go to Alarming Setting to set alarms. When the appointed events happen, the system will alert.

3.2.9 Alarm Setting

Click  to setup alarm setting. You can setup the alarm settings of camera and sensor.

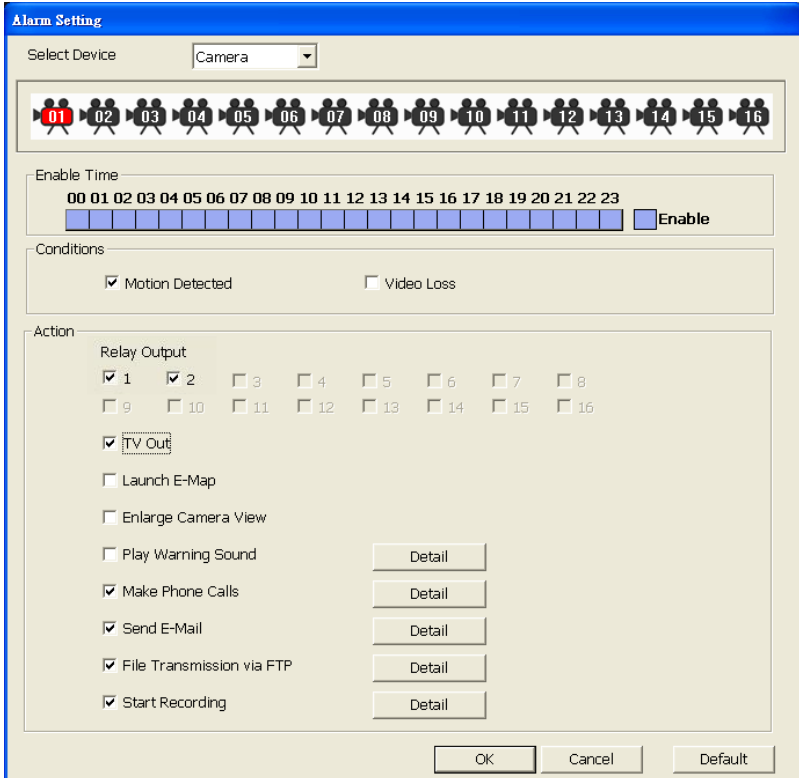

1. **Select Device:** Click the drop-down menu to select camera or sensor.
2. **Select Camera:** The bar below shows cameras that are connected to your DVR system. When the number inside the camera icon lights up, it means the camera is connected to the DVR system. The DVR system supports up to 16 cameras.



To set up the camera, just click desired camera icon. When you configure an appointed camera, the camera icon turns red.

3. **Enable Time:** Click the desired time block to turn it white. That means the alarm is canceled during the assigned hour. To enable the setting, click it again and the block will return to blue.

Chapter 3 Configuring the System

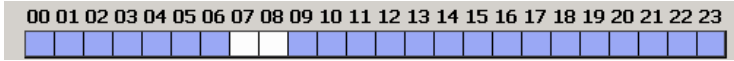

4. **Conditions:** This column shows the alarm triggered condition. Tick Motion or Video Loss boxes as the condition.

Conditions

Motion **Video Loss**

- **Motion:** When you click Motion as an alarm condition, the system will treat motion as an event to trigger the alarm.
 - **Video Loss:** When you click Video Loss as an alarm condition, the system will treat Video Loss as an event to trigger the alarm.
5. **Action:**

You can set up multiple alarm actions to warn the administrator if the alarm conditions are satisfied.

Action

Relay Output

1 2 3 4 5 6 7 8

9 10 11 12 13 14 15 16

TV Out

Launch E-Map

Enlarge Camera View

Play Warning Sound

Make Phone Calls

Send E-Mail

File Transmission via FTP

Start Recording

- **Relay Output:** Select the relay output numbers. Output relays when the alarm is triggered.
- **TV Out:** Select this item to output the video to a TV set. The system will skip to the event channel immediately when an alarm event happens.
- **Launch E-MAP:** The system will launch E-MAP when an alarm event is happened. The camera icon blinks when the alarm is triggered.
- **Enlarge Camera View:** Tick the box to enable **Enlarge Camera View**. Cancel the tick to disable the function. If you select Video Loss as the only alarm condition, this function will be disabled.
- **Play Warning Sound:** Tick the box to enable Play Sound alarm. Cancel the

tick to disable the function.

Click to set up the directory.

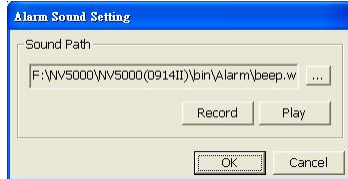

Click to assign the path of an assigned .WAV file. Click to play the .WAV file. You can also click to create a new file. The system pops up the following sound recorder.





To record a new sound file, you can click to record a new recording. When you finish the recording, click to stop. Go to **File** and then select **Save**. The system will request a file name and directory to keep the file. It returns to the Alarm sound dialog when you finish this step. Click to keep the setting or to cancel the setting.

- **Call Out:** Tick the box to enable **Call Out setting**. Cancel the tick to disable the function.

Click to set up a Call Out setting. You will see the following dialog.

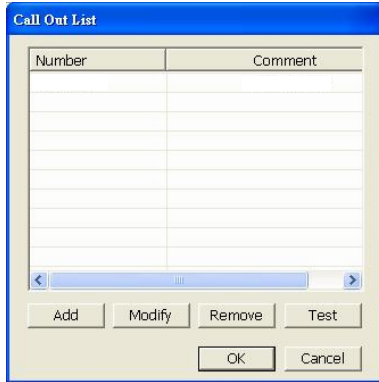
Chapter 3 Configuring the System



Click  to add a new **Call Out setting**.

Enter **Phone Number**, **Comment** and click  to import the voice file.

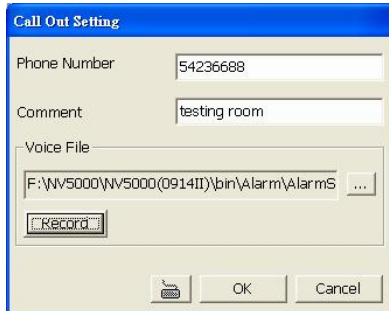

If you need to record your voice file, click . The sound recorder will appear.



To record a sound file, you can click  to record a new recording.

When you finish the recording, click  to stop. Go to **File** and then select **Save**. The system will request a file name and directory to keep the

file. It returns to the “Call Out List” when you finish this step. Click **OK** to keep the setting or **Cancel** to cancel the setting.

You will see the new setting in the table below.

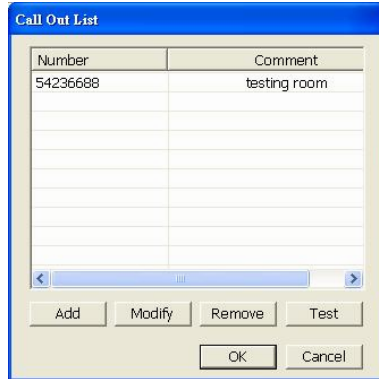

Click **Modify** to adjust the setting, or **Remove** to delete the setting if necessary. To test the setting, you can select the item and click **Test**.

Click **OK** to keep the setting or **Cancel** to cancel the setting.

- **Send E-Mail:** Tick the box to enable **E-Mail alarm**. The system will send an email and attach an alarm picture when the alarm is triggered. Cancel the tick to disable the function. Click **Detail** to set up an E-mail alarm. You will see the following dialog.

A. **Mail Server**

SMTP Server: Enter your **SMTP server** and **port**.

Authentication: Please tick the “**Authentication**” box when your mail server requests an authentication. If you don't tick this box, you can not enter **ID**



Chapter 3 Configuring the System

and **Password**.

ID and Password: Enter your **ID** and **password** of SMTP server so that the system can send the alarm by E-mail.

B. Mail

From: Enter the mail sender's E-mail address.

To: Enter the main receivers' email address.

CC: Enter the copy list of mail receivers.

Subject: Enter the E-mail title.

Message: Enter the message.

Click to save the setting or to cancel the setting.

- **Files Transmission via FTP:** Click to setup the FTP settings. You will see the FTP setting dialog.

The screenshot shows a dialog box titled "FTP Setting". It contains the following fields and values:

FTP Server	61.12.124.30
Port	21
ID	public
Password	*****

At the bottom of the dialog, there is a keyboard icon, an "OK" button, and a "Cancel" button.

FTP Server: Enter the FTP server IP.

Port: Enter the port of FTP protocol.

ID: Enter your ID for FTP server.

Password: Enter the password.

Click **OK** to finish the settings. If you cannot enter the information by keyboard, click to enter the information.

- **Start Recording:** Tick the box to enable **Record**. Click to select cameras, and set post-alarm recording time.

3.2.10 User Setting

Click  to set up user setting.

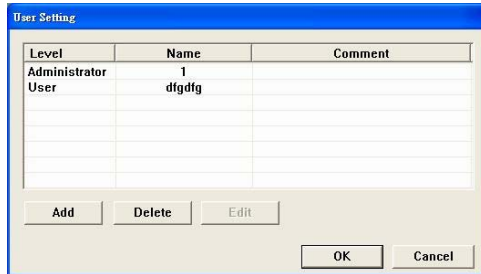

Click  to add a new user. You will see the following screen.

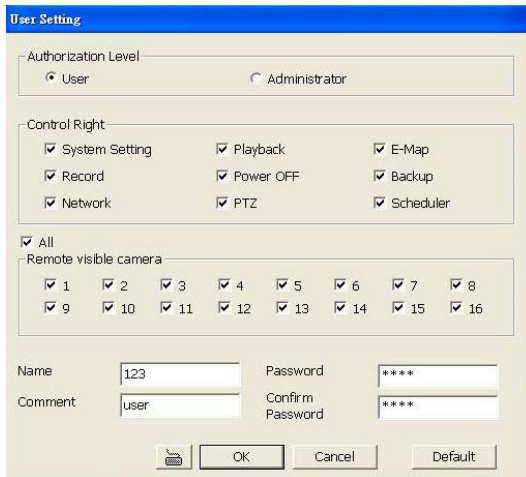

Please follow the steps to set user settings.

1 Authorization Level

Select the authorization level as **User** or **Administrator**. Only the Administrator can change the user settings.



2 Control Right

Tick the user's control rights according to your demands.

Chapter 3 Configuring the System

Control Right		
<input checked="" type="checkbox"/> System Setting	<input checked="" type="checkbox"/> Playback	<input checked="" type="checkbox"/> Emap
<input checked="" type="checkbox"/> Record Control	<input checked="" type="checkbox"/> Power OFF	<input checked="" type="checkbox"/> Backup
<input checked="" type="checkbox"/> Network Control	<input checked="" type="checkbox"/> PTZ Control	<input checked="" type="checkbox"/> Scheduler

3 Remote Visible Cameras

The DVR provides a feature to allow different users to see different channels via WebCam and remote console. The administrator can create and define remote users' authorization level to differentiate their control rights. For instance, you can let lesser important users to monitor limited channels via remote monitoring by selecting specific transmitting cameras. Thus, they are allowed to see limited channels. You can provide a higher authorization level for important users to see all channels by ticking "all" box.

<input checked="" type="checkbox"/> All							
Remote visible camera							
<input checked="" type="checkbox"/> 1	<input checked="" type="checkbox"/> 2	<input checked="" type="checkbox"/> 3	<input checked="" type="checkbox"/> 4	<input checked="" type="checkbox"/> 5	<input checked="" type="checkbox"/> 6	<input checked="" type="checkbox"/> 7	<input checked="" type="checkbox"/> 8
<input checked="" type="checkbox"/> 9	<input checked="" type="checkbox"/> 10	<input checked="" type="checkbox"/> 11	<input checked="" type="checkbox"/> 12	<input checked="" type="checkbox"/> 13	<input checked="" type="checkbox"/> 14	<input checked="" type="checkbox"/> 15	<input checked="" type="checkbox"/> 16

4 Name, Password, Comment and Confirm Password.

Enter the user name, password and comment. After the setting, enter the password again to confirm the authorization.

Name	<input type="text" value="test"/>	Password	<input type="password" value="****"/>
Comment	<input type="text"/>	Confirm Password	<input type="password" value="****"/>

Click to save the setting or to cancel the setting.







Chapter 4 Using the System

4.1 How to Monitor the Videos

Please switch to **Monitor Screen** to monitor all channels in real-time. The system provides a function of real-time monitoring.



4.1.1 Select the Split Display Mode

Before you use full screen display to monitor the videos, you can select the display mode by clicking one of the split display mode buttons. There are 6 split display modes to choose from:

-  1-Cam display
-  4-Cam split display
-  8-Cam split display
-  9-Cam split display
-  13-Cam split display
-  16-Cam split display

Select a split display mode to view the channel.

1-Camera Display

Click  to view an image from a single camera. If you install several cameras, you can click the camera number buttons  to switch to a specific camera. You can play the audio and video at the same time only under 1-Cam display mode.

4-Cam Split Display

Click  to split the screen into a 4-Cam split display.

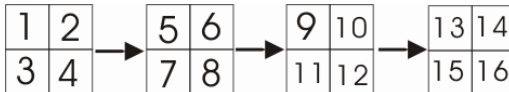

When the quantities of enabled cameras are more than the split screens, the system will show different batches of cameras under 4-Cam split display mode. For instance, if you enabled 16 cameras and click 4-Cam split display mode for 4 times, the batches of display will be Camera 1 - 4, Camera 5-8 and so on as the above illustration.

Chapter 4 Using the System

If you only have 4 cameras connected, the 8-Cam/9-Cam/13-Cam/16-Cam split display modes will be disabled automatically.

8-Cam Split Display

Click  to split the screen into a 8-Cam split display.

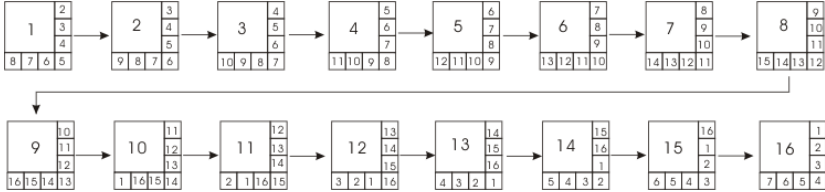

The system will display the first batch of cameras, Camera 1 to Camera 8, and then turns to the next batch of cameras, Camera 9 and so on. The above picture illustrates the sequences of 8-Cam split display.

9-Cam Split Display

Click  to split the screen into a 9-Cam split display.

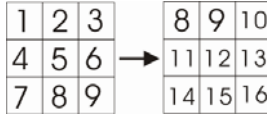

If you select a 9-Cam split display mode, the 2 display batches will be Camera 1-9 and Camera 8-16. When you click the camera number buttons, the system will show one of the batches.

13-Cam Split Display

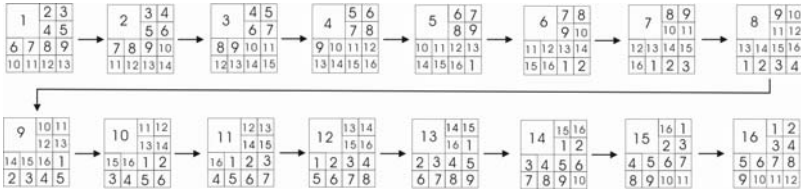

The appointed channels will be shown at the top left screen in turns according to their sequence as the above picture. The system will display the first batch of cameras, Camera 1 to Camera 13, and then turn to the next batch of cameras, Camera 2 to Camera 14, and so on.

16-Cam Split Display

Click  button to split the screen into a 16-Cam split display.

1	2	3	4
5	6	7	8
9	10	11	12
13	14	15	16

The system will display all cameras as the above picture.

Chapter 4 Using the System

4.1.2 Full Screen Display

On the **Monitor Screen**, you can click  to switch to a full screen display.



You will see the system turning to a full-size display. To monitor a specific channel, move the cursor to the desired channel and click the left button to switch the desired channel to full screen. Click again to return to the multi-display mode. Right click your mouse to return to the Monitor Screen.

4.1.3 Auto Scan

Click  on the **Monitor Screen** to enable “**Auto Scan**”. The system will cycle the channels according to the split display mode in sequence.

When the quantities of enabled cameras are more than the split screens, the split screens will cycle different batches of cameras. Please refer to **4.1.1** for the batch cycles in different split display modes. The camera ID icons turn yellow when the cycled channels are displayed. You can set up the auto scan period in system setting dialog.

4.1.4 Alarm Status and Reset

When the alarm is triggered, you can see the red sparkling arrow on the Monitor Screen.



Click the arrow to see the alarm status dialog.

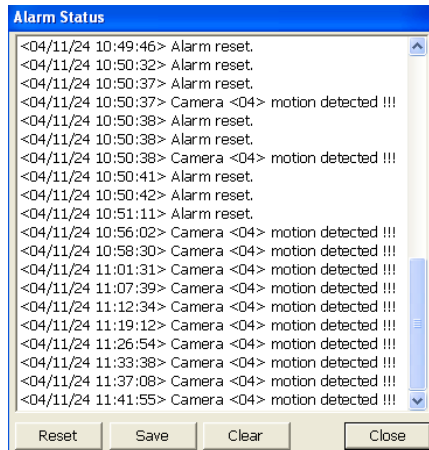

Reset: reset the triggered alarm status and cancel alarm actions. All previous alarms will be halted.

Save: save the alarm status as a text file.

Clear: clear the logs.

Close: exit the Alarm Status dialog.





4.2 How to Playback the Videos

4.2.1 Setting the Video Playback Date and Time

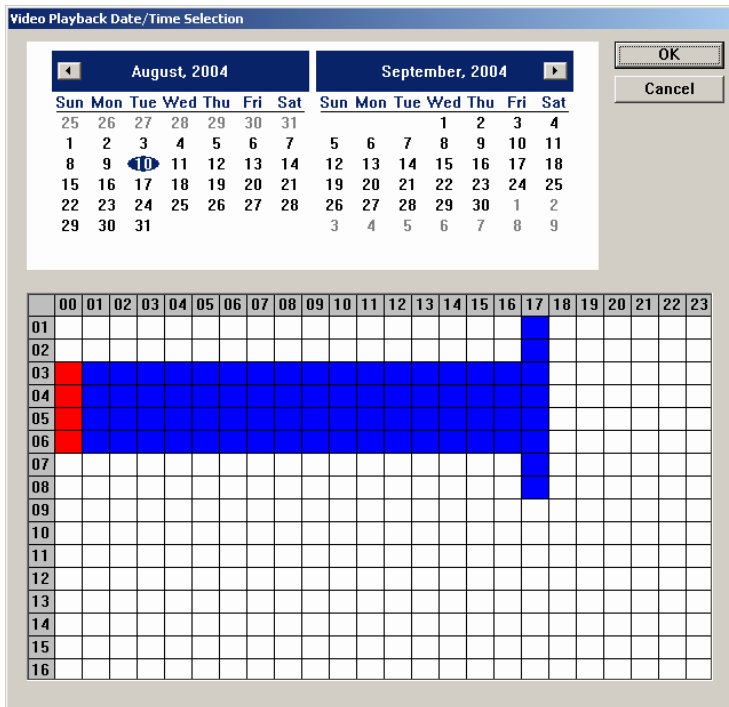
Click  switch to Playback Screen. Click  to pop up a **Video Playback Date/Time Selection** dialog.

Chapter 4 Using the System



Click   to select a date. You will see  in the lower table. The blue block means the channel has recording data during the period of time. Move the cursor to desired blue blocks and select them. The selected blocks will turn red. Click  to play the selected videos.

4.2.2 Playing the Videos



Click  to play the file. The selected button will then turn in red. You can use the playback control panel buttons to control the play mode. The functions of each button are below.



Begin: Move to the beginning of the video recording.



Previous: Go back to the previous frame.



Slower: Play the video recording at the speed of 1/2x, 1/4x, or 1/8x



Rewind: Play the video file reversely.



Pause: Stop playing the recording file.



Play: Play the recording file.



Faster: Play the video recording at the speed of 2x, 4x, or 8x.



Next: Go to the next frame.



End: Go to the end of the video recording.

After you click the play button, you will see a blue bar on top of a 24-hour time button.

Chapter 4 Using the System



The blue bars indicate that there are recorded videos during the time periods. If there are no video files recorded during your appointed time, you can not click the time button. Click the desired time button to play back the videos that were recorded during the appointed hour. The blue bar of the selected button will turn in red immediately when you click the time button.

When you play back the recording file, you can use the scroll box to drag it to go forward/backward to the desired video. The system shows the recording resolution of each channel and the frames on the upper left corner of each screen.

When you play the video in 1-Cam mode, you will see some color blocks on the slider. BLUE blocks mean recorded videos are available. Green blocks mean there is detected motion during the time segment. Black blocks mean no data recorded. Yellow blocks mean alert events videos are available.

When you play the video, the DVR system will show the date, time, and play speed status. As you see this bar , it means the video was recorded at 13:20:45.064, 2nd August 2004. 1 x means the speed of video playback. This is the normal playback speed. If you see 1/2 x, 1/4 x, or 1/8 x on the status bar, this means the play speed is 1/2, 1/4 or 1/8 times of the normal speed. If you see 2 x, 4 x, or 8 x on the bar, that means the play speed is 2, 4 or 8 times of the normal speed.



Right click to select an area, the system will enlarge that area for your further analysis.





4.2.3 Catching Desired Videos

4.2.3.1 Output AVI files

When you find a desired video and need to catch the film, you can use “**Set Segment**” and “**Output Segment**” to save the desired video as an AVI file.



Under 1-Cam display, you can catch a desired file by setting segments. Select a video playback date and time and click  to play back the recorded video.

Drag the slider to the desired position and then click  to mark the beginning of a segment. You will see a pink triangle  on the slider. Drag the slider to the desired position and then click  again to mark the end of a segment. You will see the other pink triangle on the slider, for example, .

Click  again to cancel the marked segment. After you finish the segment, the system will play the appointed video repeatedly.

Click  to output the appointed segment. You will see the following dialog.

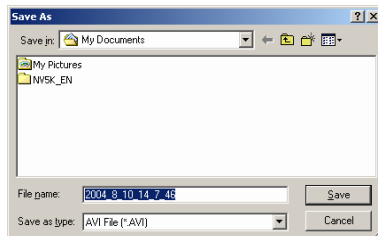

The default file name will be the recording time. Select the storage path and click

Chapter 4 Using the System

Save to output the video file. The system will name the output segment according to the recording time. You can save the video segment to hard disks, USB Flash disk or other network devices.

4.2.3.2 Save Static Images

Sometimes it is necessary to catch static images from the recorded videos.

The DVR system allows you to catch the static images. Users can save the image as a 1-Cam display image or a split display image. Click  to save the playback screen as a BMP or JPG file when you play back video recording.



The DVR provides a watermark proof function to avoid any unauthorized image forgery. The system can embed watermark proof in the image file. Only BMP files can be embedded with watermark. For more information, please check Appendix B Image Verification.

4.2.3.3 Printing Static Images















You can print the image files by clicking  button.

Before you print, please check the printer. If you never install any printer before, follow the instructions to install the printer. After successfully install the printer, you can start to print the images.

4.3 Play Backup Video Files

After you backup the data, use the application ,QLogViewer, to play the audio. Go to your assigned backup folder to run QLogViewer. When QLogViewer is running, please click  to assign your desired video file.



-  **Begin:** Move to the beginning of the video file.
-  **Previous:** Go back to the previous frame.
-  **Slower:** Play the video recording at the speed of 1/2x, 1/4x, or 1/8x
-  **Play:** Play the video file.
-  **Stop:** Stop to play the video file.
-  **Faster:** Play the video recording at the speed of 2x, 4x, or 8x.
-  **Next:** Go to the next frame.
-  **End:** Go to the end of the video recording.
-  **Set Segments:** The system provides a function to catch a desired video segment from the recording file by setting segments and outputting segments. Click  to mark the beginning/ending of a segment. You will see a  and  on the slider. The lower video slider indicates the segment in a blue bar. To cancel the segments, click  again.
-  **Output Segment:** After setting segments, click  to output the desired video segment as an AVI file. The system appears a dialog to ask for the storage path. The system names the output segment according to the time of the video.

Chapter 4 Using the System



Save: Click the button to save the playback screen as a BMP or JPG file.



Print: Print the current image.



Video Slider: Move the bar left/right to fast search a desired event.

Play Time: 2004/12/22 01:00:00 Speed: x1

Playing Time/Speed: This indicator shows the playing time and speed.

Play File: D:\data\2004_12_22\Channel02\20041222-01.asx

Play File: This indicator shows the directory of the backup video file.

4.4 Searching Desired Videos

Depending on users' demands, The DVR system provides the following smart ways: **Intelligent Search**, **Event Search**, **Visual Search** and **Event Log** to find the desired videos from the recorded videos.

4.4.1 Intelligent Search

Click  and it turns green when this function is enabled. Adjust the sensitivity first, higher number accompanies with higher sensitivity.

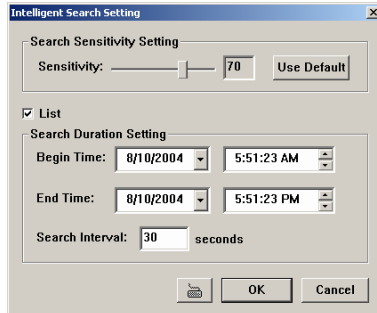

Move the cursor to the desired channel and click the mouse and drag to mark an area. A red frame appears on the display. The screen of the assigned channel also appears "**Intelligent Search**" in red on the lower left corner. When there is a motion event inside the marked area, the Monitor Screen will pause. If it is not a desired event, click  to find next.



If you would like to find out a searching list, tick "**List**" box, the items in the **Searching Duration Setting** will be enabled.

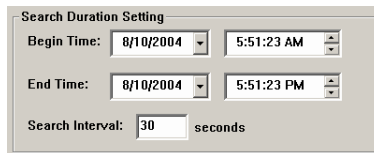

Select the **Begin/End Time** and enter **Search Interval**. Click **OK**. The system will show a **Search List** dialog that lists the desired events.

Chapter 4 Using the System

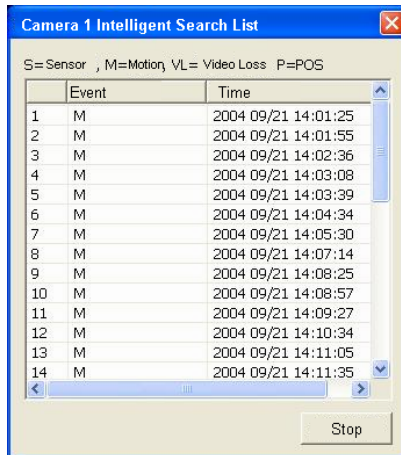



Select an event and double click. The system will show the video of the event.

4.4.2 Event Search

Click  to use Event Search.

An **Event Search Setting** dialog appears. Select **sensor events**, **motion events**, **video loss events**, and **POS** events according your demands.



The screen of the assigned channel appears "Event Search" in red on the lower left corner. Click **OK** and  to search events. Once the system finds the events, it will be paused. Click  again for next event search.

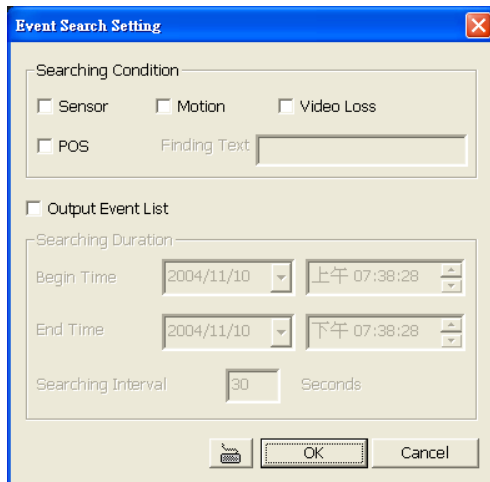

If you want to find a searching list, tick **Output Event List** box, and the **Searching Duration** items will be enabled. Select the **Begin/End Time** and enter **Search Interval**. Click **OK** to start searching.

After setting the event search, the system will appear a following event list.

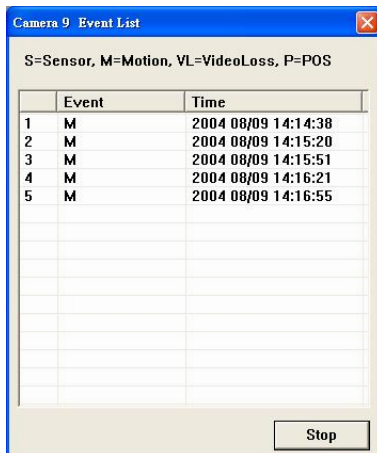

This list shows all events. Select an appointed event to play back the video.

4.4.3 Visual Search

Visual search provides serial static images to help analyze the differences in the same channel. The system provides 5 different time modes for visual searching: searching by day, searching by hour, searching by every 3 minutes, searching by

Chapter 4 Using the System

every 10 seconds and search by second.

Click  to initiate “Visual Search”. The following dialog will appear.

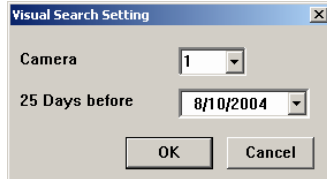

Visual Search Setting

Camera: 1

25 Days before: 8/10/2004

OK Cancel



Select a camera and assign a date. The system keeps the videos that are 25 days earlier than the appointed date. Click **OK** you will see the following images.



In “Visual search by day” mode, the serial static images are recorded by date. The system will show the 1st recorded video that is recorded after 12:00 PM in each day. Each picture shows its recording date on the upper left corner. If there is no data, the display will show “No Data”. Meanwhile, you will see the upper grey bar shows the date of the selected image. Exit the screen by clicking



AVerMedia NV1000/3000/5000/7000 User's Manual

Move the cursor to a desired date and click it. It turns to the **"Searching by hour"** mode. There are up to 24 screens on the display. The system presented the 1st video image in each hour. As you see the following picture, the system recorded the videos from 9:00 to 14:00. Each picture shows its recording time on the upper left corner. If there is no data, you will see **"No Data"** on the display. You can click  to return to **Visual search by day** or  to exit visual search.





Select the desired hour and click the mouse, you will see the following picture. The system shows the picture for 3 minutes.

Chapter 4 Using the System





As you see the above picture, the system recorded the videos from 12:00 to 13:00. There are 20 screens on the display at most.

Each picture shows its recording time on its upper left corner. If there is no data, you will see "No Data" on the display. You can click  to return to the **Video search by hour** or  to exit visual search.

Move the cursor to a desired picture. Click it and the system will show the display that is recorded every 10 seconds.



As you see the above picture, the static images are recorded every 10 seconds. The system recorded the videos from 12:00 AM to 12:02 AM. When you search video by every 10 seconds, the system will record a frame every 10 seconds. There are 20 pictures on this screen at most.



Each picture shows its recording time on its upper left corner. If there is no data, you will see “No Data” on the display. You can click  to return to **Video Search by minute** or  to exit visual search.

Select a desired picture and click it to show the “**Video search by second**” screen.

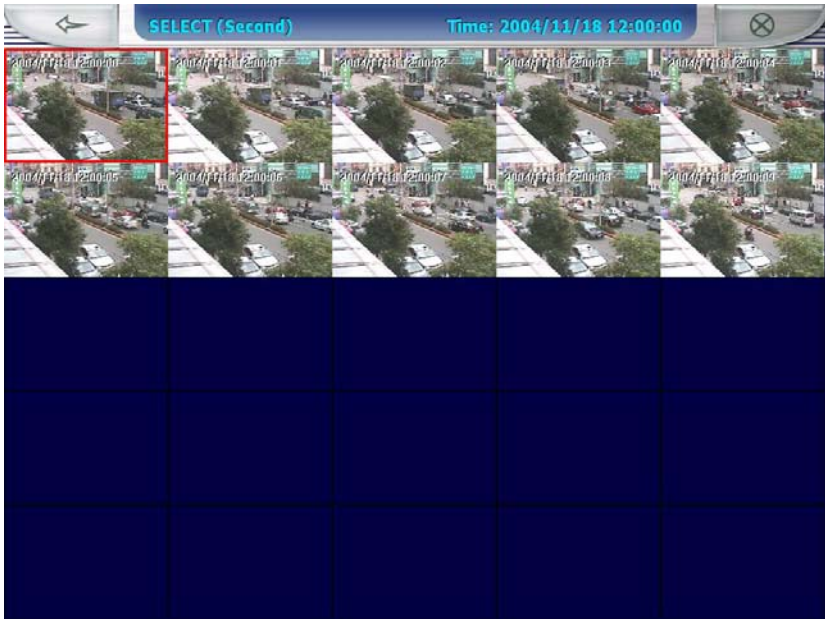
Chapter 4 Using the System



As you see the above picture, the static images are recorded by second. The system recorded the videos from 12:00:00 to 12:00:09. When you search video by second, the system will record a frame every second. There are 10 pictures on this screen at most.

Each picture shows its recording time on its upper left corner. If there is no data, you will see **"No Data"** on the display. You can click  to return to **Video search by 10-second** or  to exit visual search. Click the mouse again to play the video.

If you want to search for another channels or date, you should click  and enter visual search again.

4.4.4 Searching Events by Event Log Viewer

You can also use Event Log Viewer to track the desired event. Click  to see the Event Log Viewer dialog.

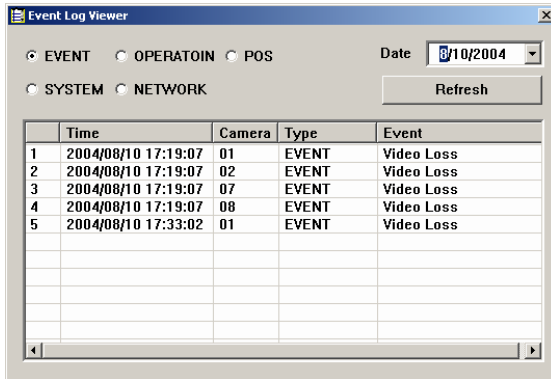

Select **EVENT** and the desired **Date**. Double click the desire event in the table. The system will show the video of the assigned event if there is recorded files.



4.5 Using E-Map



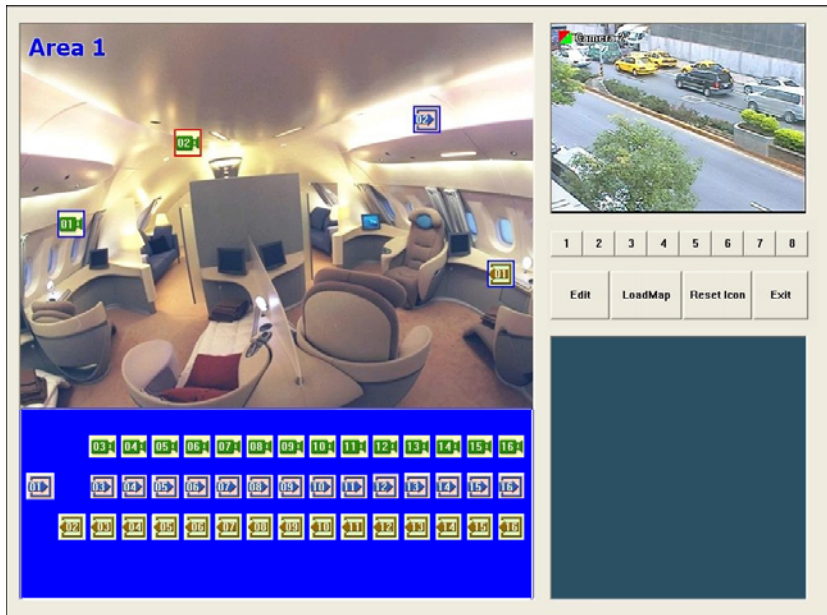

E-Map provides a completely configured map where all cameras, sensors, and relays are set.

Click  to set up the E-map.



Chapter 4 Using the System

1. Select a button from  to set up your E-map. When you click  button, the left-top corner will appear "Area 1" in blue. Click  to load an E-map. The system supports up to 8 E-maps. The map must have been saved in JPG or BMP format and file size is smaller than 200KB.

2. Click  to arrange **Cameras, Sensors, and Relays** by dragging  ,  and  buttons to the E-map to indicate actual locations of camera, sensor and relay devices. When you drag the camera icon to the desired E-map, the right windows will show images from the appointed camera if the enabled camera is connected to your digital surveillance system.

To delete the buttons, drag them back to the column where they were previously taken or click  to reset all icons. You will see your desired camera image at the right corner.

3. The lower-right column shows the information of cameras, relays and sensors when the system detects a video loss or sensors and relays are trigged. The icons on the E-map will turn red and blink.

Click  to save your current setup and leave E-map.

4.6 Using PTZ Camera

If you connect PTZ cameras to your DVR system, click  on the Monitor Screen and setup PTZ cameras first. You will see a controller after pressing the button.

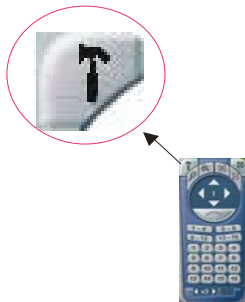

Click  to configure PTZ cameras as the above picture. A PTZ setup dialog appears.

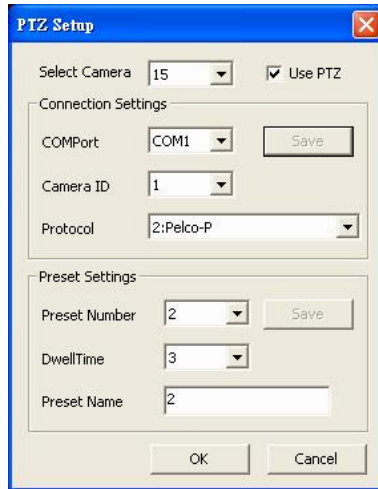

Please set up the following items before using PTZ cameras.

1. Select Camera

Tick **Use PTZ** box to enable the function. Select a camera in the drop-down list.

2. Connection Settings

A. Select a **Com Port** where the PTZ camera connector is connected.

B. Select a **Camera ID** from the drop-down list.

C. Assign the Protocol. Please select your **PTZ Model** (refer to your PTZ camera spec.) from the menu. Click **Save** to keep settings.

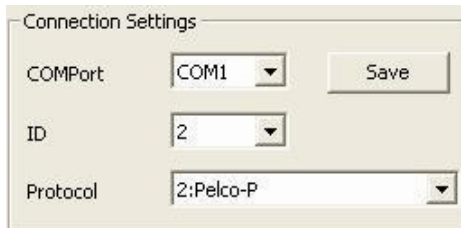

3. Preset Settings

A. Move the camera to the position (refer to the control panel below)

B. Choose a preset number from the drop-down list to set the monitoring position.

C. Set up the **Dwell** time for the camera to stay (1~60 seconds) at one position before rotating to the next position.

Chapter 4 Using the System



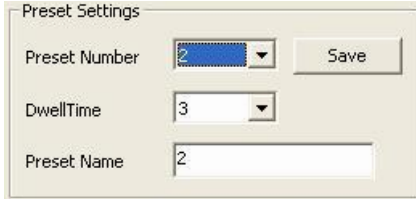

- D. Determine a **Preset Name** for the position.
- E. Click **Save** to keep the setting.



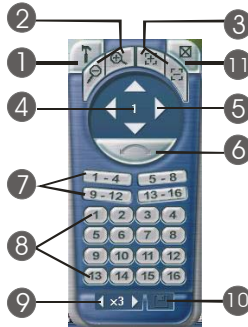



After you finish the above steps, repeat the same procedure to setup another PTZ camera until you finish all PTZ cameras. Click **OK** to finish the setting or **Cancel** to cancel it.

After the settings, you can start to use the PTZ controller.



1. **PTZ Setup.** Click  to configure PTZ cameras. After the settings, you can start to use the PTZ controller.
2. **Zoom in / Zoom out.** You can click  /  to size up / to size down the image. These buttons provide the function to adjust the focal distance of lens to size up / to size down the image.
3. **Focus in / Focus out.** Click  /  to adjust the focus to produce a clear image.
4. **Camera Number.** The white number inside the controller represents the PTZ camera number.
5. **Direction buttons.** You can use the 8 direction buttons to adjust the

direction of PTZ camera lens.

6. **Auto pan.** After you setup Preset position numbers and the auto pan path group, click  to monitor positions in sequence.
7. **Auto pan path group.** After setting up Preset position numbers from the server, you can enable the auto pan path group function according to your demands from the client. Click , and you will find the PTZ camera lens cycles to the desired positions and stays for the appointed time that you setup from the server. Users can click the 4 auto pan path group buttons at the same time to monitor the 16 Preset positions cyclically.
8. **Preset position numbers.** Users can appoint Preset positions of the PTZ camera lens from the server. Follow the steps to set Preset position numbers.
 - A. Select a desired preset number.
 - B. Click direction buttons to adjust the PTZ camera lens to a proper position
 - C. Click  to keep the assigned preset position number setting.Repeat the same steps to set all preset position numbers. 16 Preset position numbers are the maximum for a PTZ camera. Click the Preset position numbers to make the lens move to the desired positions.
9. **Moving speed of camera lens.** After you setup the preset position numbers, you can adjust the moving speed of camera lens by clicking the direction buttons to speed up/down the movement of lens. .
10. **Save.** After you determine the preset position, please click  to keep the setting.
11. **Exit.** Click this icon to close PTZ camera controller.

4.7 Using Event Log Viewer

Click  to check the Event Log Viewer dialog. The Event Log Viewer shows event logs, operation logs, POS logs, system logs and network logs.

Chapter 4 Using the System

4.7.1 Checking Event Logs

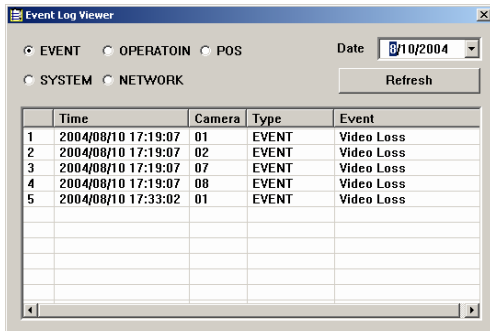

Select **Event** and a desired date, the lower table will show all event logs. You will see the event time, camera, type and event in the table. To check event logs of another day, just select the desired date and then click  to update the logs.

4.7.2 Checking Operation Logs

Select **Operation** and a desired date, the lower table will show all Operation logs. You will see the time, type and event logs. The system will keep all event logs such as network on/off, system setup, start/stop record and so on. To check the logs of another day, just select the desired date and then click  to update the logs.

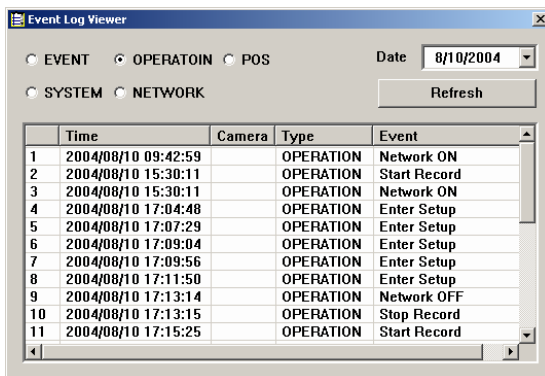

4.7.3 Checking POS Logs

Select **POS** and a desired date, the lower table will show all POS logs. You will see the time, type and event logs. The system will keep all POS logs. To check the logs of another day, just select the desired date and then click

to update the logs.

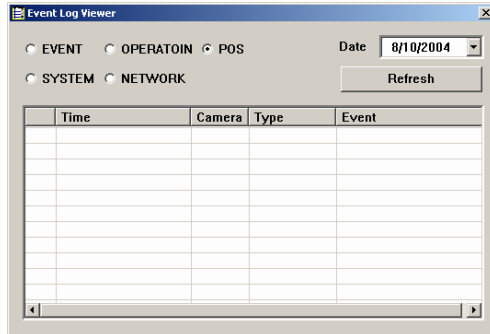

4.6.4 Checking System Logs

Select **System** and a desired date, the lower table will show all system logs such as DVR on and off. You will see the time, type and event logs. To check the logs of another day, just select the desired date and then click to update the logs.

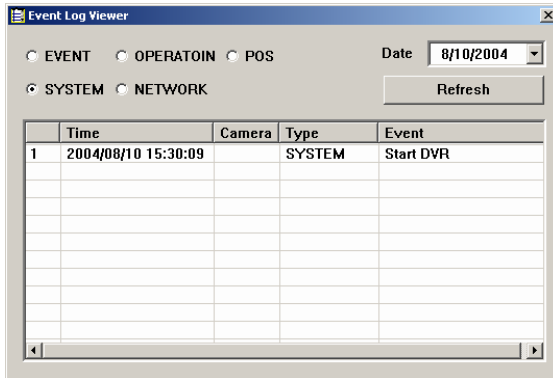

4.7.5 Check Network Logs

Select **Network** and a desired date, the lower table will show all network logs

Chapter 4 Using the System

such as Network on/off and remote login. You will see the time, type and event logs. To check the logs of another day, just select the desired date and then click

to update the logs.

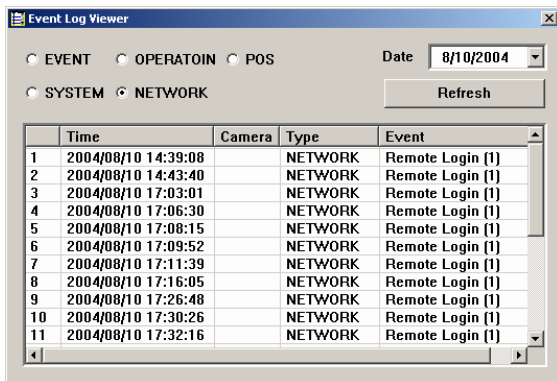

4.8 Using POS

After you connect the POS and the DVR system, click  to enter POS Console Setting screen. Click  to add a POS item.

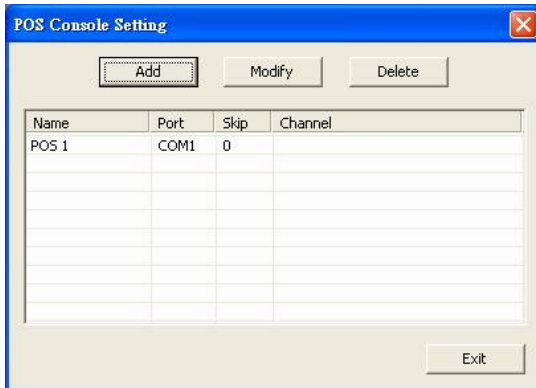

You will see the following dialog.

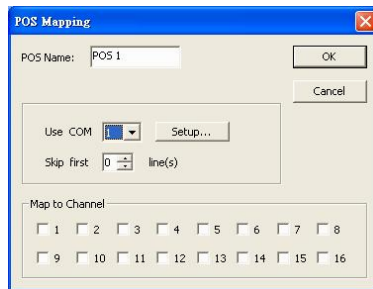

Please configure the following items.

POS name: Enter the POS name.

Use COM: Select a COM port from the drop-down list. The COM port number will vary according to the user's hardware.

Skip first...lines: Click  to adjust a desired number. The appointed number of lines will be skipped when receiving the POS data.

Map to Channel: Tick the boxes to make the POS mapped to the channels. The

Chapter 4 Using the System

POS information will show on the appointed channels.

After you finish the settings, click **OK**. You will return to POS console setting dialog. Click to add a POS setting and repeat the above procedure.

To modify the setting, please select the desired item and then click to adjust the settings. If you wish to delete the setting, please select the unwanted item and then click .

After finishing the settings, the POS information will be shown on the assigned channel and the system will record the information with video at the same time.

To search the POS event, you can use Event Search in **4.3.2 Event Search** to search POS keywords when you play back the video. When clicking POS event search, the **FINDING TEXT** is enabled for entering POS keyword. You can also check **4.3.4 Searching Events by Event Log Viewer** to get POS logs, and double click the log event to play the video recorded.

Note: For the POS recommendations, the Epson POS system is recommended.

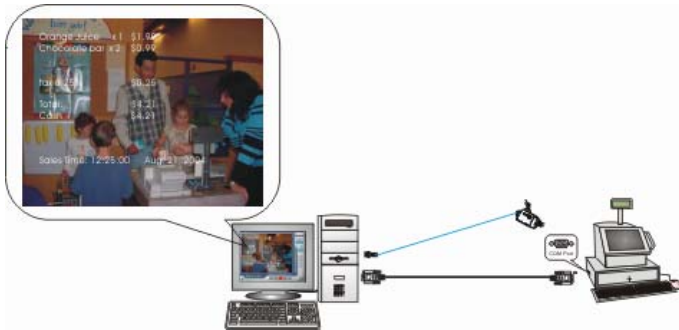

You can monitor the sales records through point of sales system. As you finishing setting POS, all sales record will be shown on the appointed screen. The sales information will be recorded in the channel.

4.9 Using Network Server

Click  on the Monitor Screen to allow network services. The icon turns red when you enable the network server. The digital surveillance system allows http inbound connections from client PC. For details, please refer to **Chapter 5 Using Remote Program**.

4.10 Using Functional Keys

The DVR system allows users to use functional keys to fast operate the application under Display mode. The following table shows functional descriptions of each function key.

Function Keys	Function description
F1	System Information
F2	Recording
F3	Network
F4	System Setting
F5	Switch to playback Mode
F6	Setting E-map
F7	Setting PTZ cameras
F8	Snapshot
F9	Switch to Full Screen
F11	Switch to Auto Scan

4.11 Checking System Information

Click F1 to see the system information. The system information includes status of CPU, RAM, VGA Memory, DirectX Version, Login ID, Production Version and Active Internet client connection.

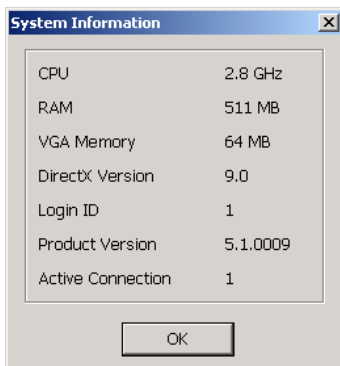

Click **OK** to exit system information dialog box.

Chapter 5 Using Remote Program

Make sure that remote access service is enabled as **4.8 Using Network Server** mentioned before you open IE. Enter the server's IP address or domain name which is mentioned in **3.2.4 Network Setting** to remote access the surveillance system from anywhere.

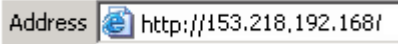

You will find the following screen on your browser. Click **Yes** to allow the web component installation.

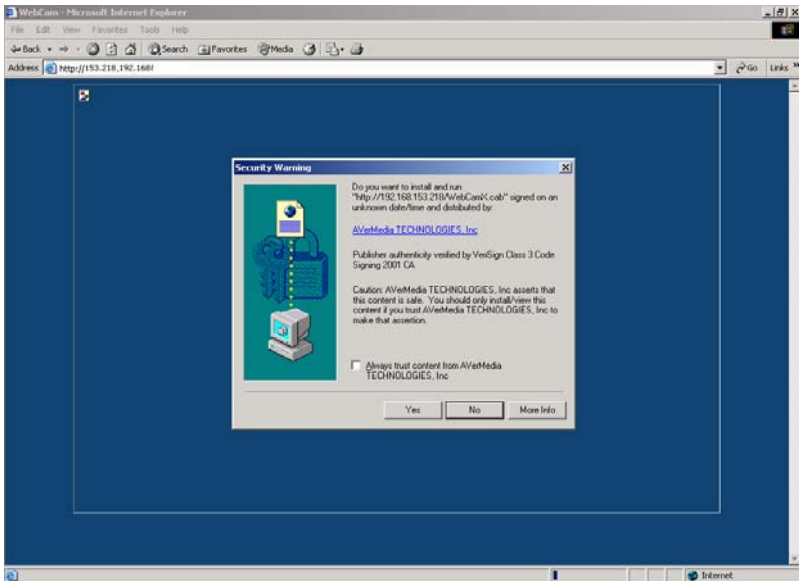

For Windows XP SP2 users, you will see "Internet Explorer- Security Warning" screen when you first time connect to the DVR. This is normal to see the security warning dialog. Click **Install** to install WebcamX.cab.



5.1 Using WebCam

After connecting to the surveillance server from the remote PC, enter the user ID and password to finish the authentication. Please refer to **3.2.10 User Setting** to set up new users.



After the authentication, you will see the below screen.



If the client PC supports DirectDraw, please click the DirectDraw button to use this function. You will have better video quality on WebCam.

Chapter 5 Using Remote Program

Here is a simple illustration of WebCam.

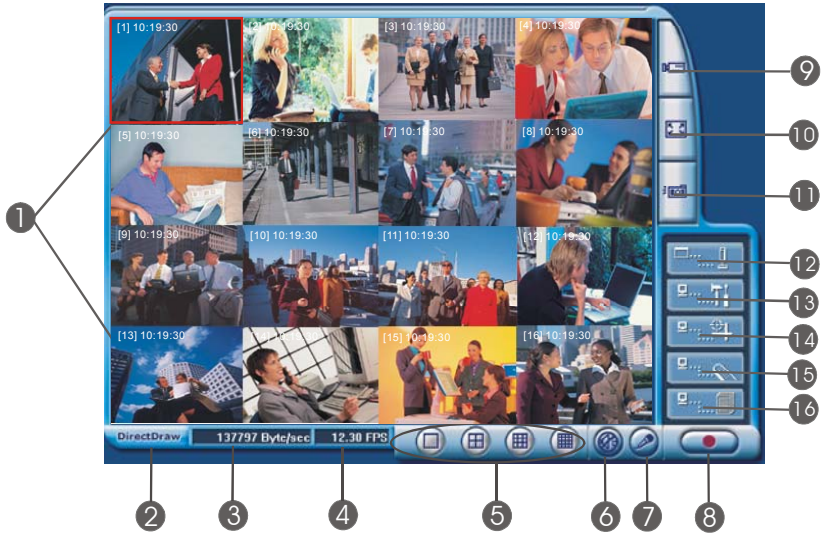

1. **Monitor Screens:** The screens show the allowed channels for remote monitoring. Users can monitor at most 16 channels according to the settings.
2. **DirectDraw:** Click  to enable this function. When DirectDraw is enabled, the video images become smoother, and the button turns yellow.



Not all graphic cards support the DirectDraw function.

The following pictures show the differences before using DirectDraw.







Before using DirectDraw



After using DirectDraw

Click  again to cancel the function.

3. **Received file size:** This shows the total size of the video files.
4. **Camera frames:** This shows the total frame rates of the channels.
5. **Split display mode.** The system provides 4 split display modes: 1-Cam split display, 4-Cam split display, 9-Cam split display and 16-Cam split display. If you only connect 4 cameras, the 9-Cam and 16-Cam split display will be disabled automatically.
6. **Audio:** If you select **"Enable Audio"** in **3.2.3 Recording Setting**, you can choose to play the audio or mute the channel when you monitor the video. This function is enabled under 1-Cam display mode. Users can hear the audio when monitoring or playing the data.
7. **Voice Phone:** Click  to start 2-way audio. Please refer to 3.2.4 Network Setting. Make sure your microphone and speakers work before you use a microphone to talk to the server user. The button turns yellow when it is enabled. Click  again to cancel it.
8. **Record:** Move the cursor to select a desired channel and click the button to record. The system provides you to save the desired recording as AVI files. Your system will appear a dialog to ask the storage path. The recording time is used as the file name to save the recording. You can also right click to start/stop recording.
9. **Select cameras to view.** Click  to enter Channel Monitor Screen. Click  to enable or  to disable the channel on Display column. The camera names are set in server's settings.

Chapter 5 Using Remote Program

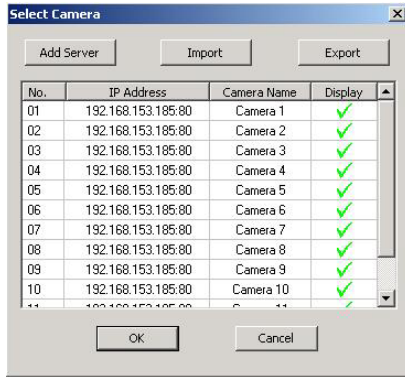

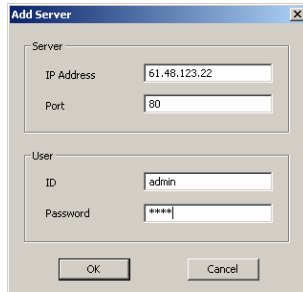

To connect a different server, click **Add Server** to add new camera settings. Enter the new server IP address, Port, User Name and Password. Click **OK** to save the settings. You can connect up to 16 different servers.

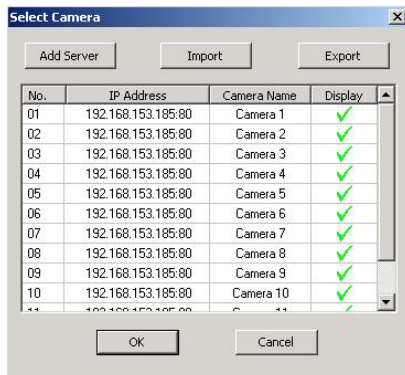

You will see the cameras of the added server in the table. Click display mode to rotate cameras that surpass 16 channels.



To save your time, you can keep the current setting as an encrypted text file by clicking the “**Export**” button. The system will request for a storage path and a file name. Select a file name and proper path to keep this current setting. When you open IE, just import the setting. Thus, you don't need to enter the server IP, account and password every time when you open IE.



10. **Full screen.** Click  to display full screen. Move the cursor to the screen and right click to return the browser.
11. **Snapshot.** Click  to save the desired image. The system will save the image as a bmp file.



12. **Select a PTZ camera.** Click  to show the PTZ camera controller. After you select a PTZ camera, you will find the PTZ camera icons are enabled as the following picture. Here are the introductions of each icon.

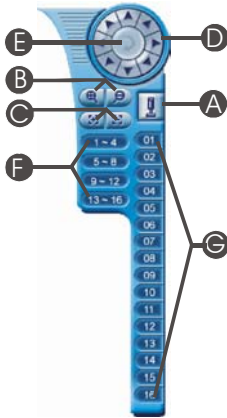



Chapter 5 Using Remote Program

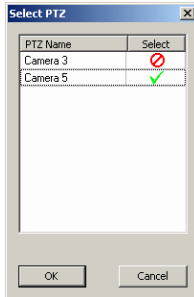

- A. **Select a PTZ camera.** Click  to select a PTZ camera. You can click  /  to enable / disable the appointed PTZ channel on the Select column. Click **OK** to save.



Note: Only PTZ cameras which are set from the server side will appear in this table.

- B. **Focus in / Focus out.** Click  /  to adjust the focus to produce a clearer image during surveillance.
- C. **Zoom in / Zoom out.** You can click  /  to size up / to size down the image. These buttons provide the function to adjust the focal distance of lens to size up / to size down the image.
- D. **Direction buttons.** You can use the 8 direction buttons to adjust the direction of PTZ camera lens during surveillance.
- E. **Preset position numbers.** Users can appoint Preset positions of the

PTZ camera lens from the server. 16 Preset position numbers are the maximum for a PTZ camera. Click the Preset position numbers to make the lens move to the desired positions.

- F. **Auto pan path group.** After setting up Preset position numbers from the server, you can enable the auto pan path group function according to your demands from the client. Click , and you will find the PTZ camera lens cycles to the desired positions and stays for the appointed time that you setup from the server.
- G. **Position status bar.** It shows the current position that the camera is monitoring.
- H. **Auto Pan.** After you setup Preset position numbers and the auto pan path group, click this button to monitor positions in sequence.
- I. When you monitor channels through a browser, you can save the recording data as AVI files. Move the cursor to the desired channel and right click to record. Assign the directory and file name to start recording. Right click the channel to stop the recording.

Users can also select the recording quality by right clicking the mouse. The DVR system provides 3 kinds of video quality modes: high, normal and low. Right click the mouse to select the video quality mode. When the recording quality is better, the file size will be larger.

- 13. **Remote setup.** Click  to initiate remote setup. The modified settings that you made through the browser will be applied to your server. The system will request an authorization. Enter the User ID and Password and then click **OK**.



The image shows a dialog box titled "Authorization" with a blue header. The main text reads "Please enter your user ID and password." Below this, there are two input fields: "User ID" with the value "1" and "Password" with the value "****". At the bottom, there are two buttons: "OK" and "Cancel".

You will see the below screen.

Chapter 5 Using Remote Program

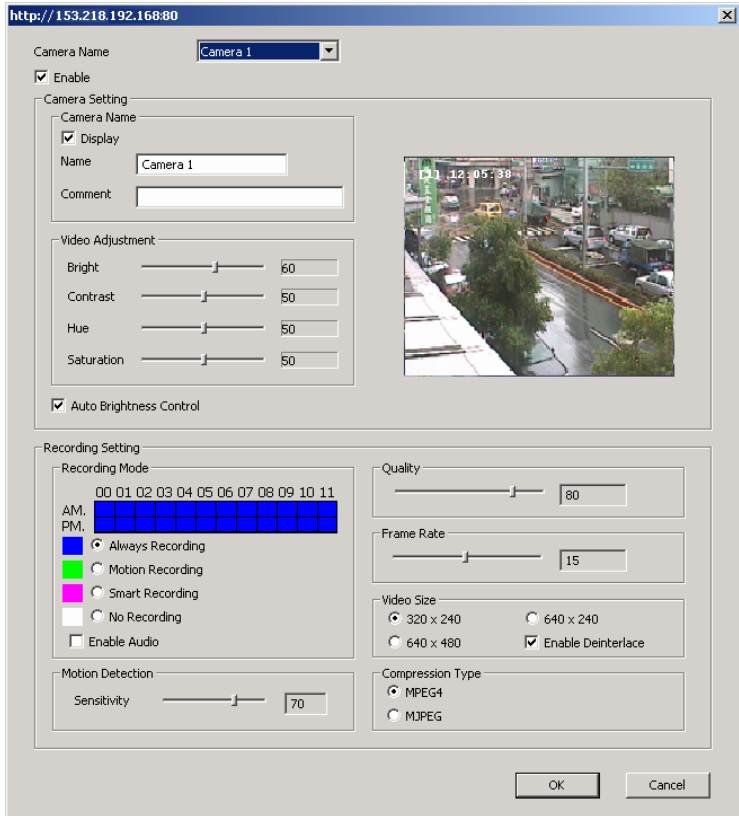

This function enables you to setup the cameras settings and recording settings on the server side. Please refer to 3.2.2 and 3.2.3.

14. **Remote E-Map.** Click  to initiate the E-Map. You will see an E-Map screen.

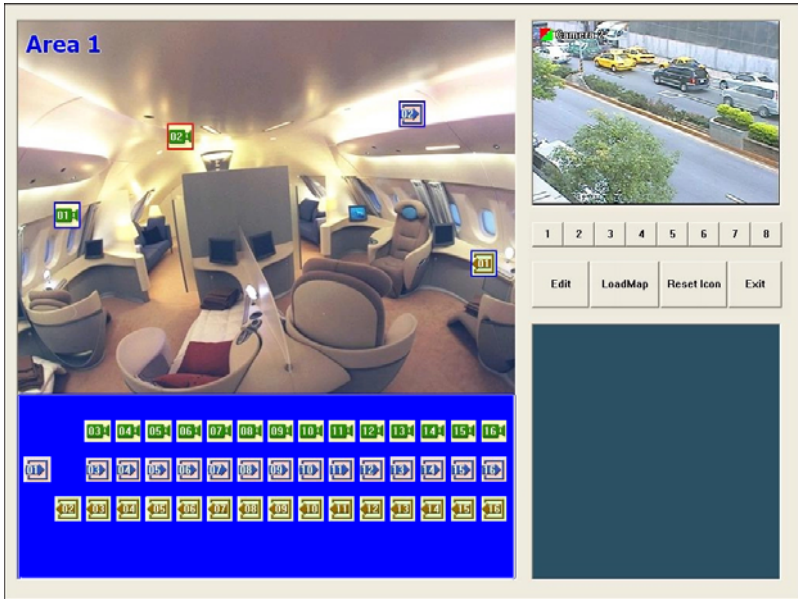

When you click the camera icon to the desired E-map, the right windows will show images from the appointed camera if the enable camera is connected to your digital surveillance system.

15. **Remote Console.** Click  to initiate Remote console. The system will request an authorization. Entering User ID, Password and then click **OK**.

The 'Authorization' dialog box contains the following text and elements:

- Title: Authorization
- Text: Please enter your user ID and password.
- User ID: A text input field containing the number '1'.
- Password: A text input field containing four asterisks '****'.
- Buttons: 'OK' and 'Cancel' buttons at the bottom.

Please refer to **5.2 Using Remote Console** for more details.

Chapter 5 Using Remote Program

16. **Event Log Viewer.** Click  to see the event log viewer. You will see the below dialog. Please refer to **4.5 Using Event Log Viewer** for more details.

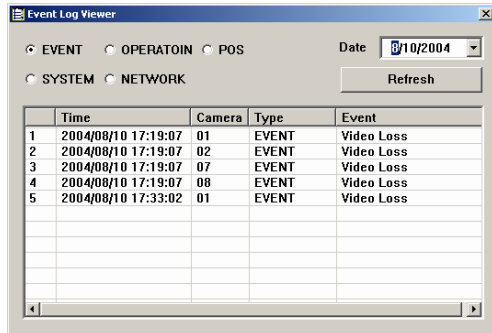

5.2 Using the Remote Console

Remote console can be regarded as a restricted DVR. It can record and play video data of remote server.

Please enter the server site when you open the browser. Enter the user ID and password to finish the authentication.

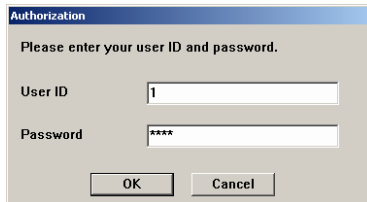

The image shows a dialog box titled "Authorization". Inside the dialog, there is a message: "Please enter your user ID and password." Below this message, there are two input fields: "User ID" and "Password". The "User ID" field contains the number "1". The "Password" field contains four asterisks "****". At the bottom of the dialog, there are two buttons: "OK" and "Cancel".

After you login the system through a browser, click  to start the remote Console. Enter the User ID and password and click **OK** to start the remote console.

You will see the following remote Console screen.



5.2.1 System requirement

CPU: Intel P4 1.8GHz

Memory: 256MB

VGA: 16 bit high color SVGA graphic card with Direct Draw & YUV rendering capability.



Do not perform NV DVR and Remote Console at the same server.

Chapter 5 Using Remote Program

5.2.2 Using Display from Remote Console







The functions of buttons on the remote console are below.

1. Exit

Click this item to exit the DVR system.

2. Split Screen Display

DVR provides 6 split display modes for your selection. You can select 1 /4 /9/ 16 split display mode by simply clicking the icon.

-  1-Cam Display
-  4-Cam split display
-  9-Cam split display
-  16-Cam split display

3. Server Site and Transmission Information

This bar shows the DVR server site and the transmission speed of the recording video.

4. Recording



Click  to record the video recording that you can monitor through your Remote console. Remote console helps you to backup the video recording that you monitor.



You can only record the channels that are shown on the Remote Console screen.

5. E-Map



Click E-Map button to load your desired map according to your demands..

6. Network



Network is enabled when it login. Click the button again to disable all inbound connections.

7. System Setup



You can change storage path, display language, and remote server IP to reconnect to the console. When you click this icon, you will see the following screen.

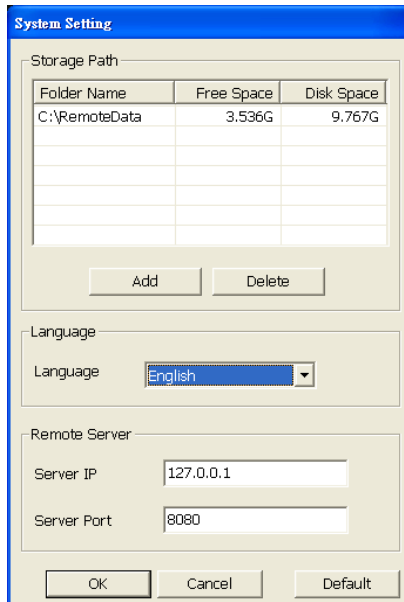

The System Setting dialog box contains the following sections:

- Storage Path:** A table with columns for Folder Name, Free Space, and Disk Space. The first row shows C:\RemoteData with 3.536G free space and 9.767G disk space. Below the table are Add and Delete buttons.
- Language:** A dropdown menu currently set to English.
- Remote Server:** Text input fields for Server IP (127.0.0.1) and Server Port (8080).

At the bottom are OK, Cancel, and Default buttons.

8. Display

Chapter 5 Using Remote Program

When you are running Remote console, the default screen will be Monitor Screen. You will see the button  in green. When you switch to Playback screen, the button turns gray.

9. Playback

Click  to switch to Playback Screen under Remote Console.

In Remote Console application, you can select to play remote video data of remote server or local data recorded.

The Remote console will pop up a schedule. Select a playback date and then click OK to continue.

10. Camera ID

In the No. area, you can see number icons of the cameras. Click a desired icon to display the channel. After you click the icon, it turns yellow. If you assign a split display mode and appoint a camera number, the icon group of the cameras will turn yellow altogether.

11. Full Screen

Click  to switch to a full screen mode. Click the full screen again to return to remote console display mode.



12. Sensors

The icon shows which sensors that are triggered. Once the sensors are triggered, the indicators will turn yellow according to the sensor number.



13. Relays

The icon shows which relays that are triggered. Once the relays are triggered, the indicators will turn yellow according to the relay number.

14. Audio Volume Adjustment

Click the icon to adjust the audio volume to a proper volume. You can mute the channels by selecting the Mute box.

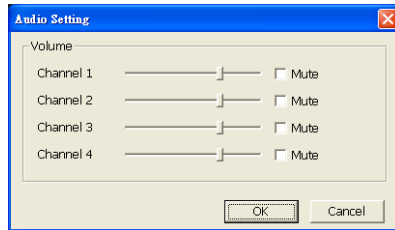

5.2.3 Using Playback from Remote Console

User can choose to play local video files or remote video files. Select a desired item and then click OK to continue the playback task.

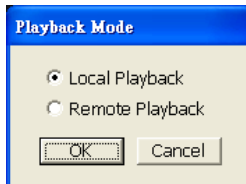

You will see a playback screen as below. Here is the introduction of each button in Playback screen.

Chapter 5 Using Remote Program



1. Audio Volume Adjustment

Click the icon to adjust the audio volume to a proper volume. You can mute the channels by selecting the Mute box.

2. Slider

Drag the slider to go forward or backward through the video of a selected video recording.





3. Time Button

A blue bar on top of a time button indicates that there are recorded videos during the time period. Click the desired time button to play back the videos that were recorded during the appointed time. The selected button will then turn in red.

A grey bar on top of a time button indicates that there are no video recordings during the time period. If there are no videos recorded during your appointed time, it won't show any image.



4. Split Screen Display

There are 6 split display modes to choose from:

-  1-Cam display
-  4-Cam split display
-  9-Cam split display
-  16-Cam split display

Select a split display mode to view the channel. You can play the audio and video at the same time only under 1-Cam Display mode. When the quantities of enabled cameras are more than the split screens, the system will show different batches of cameras under 4-Cam/9-Cam split display mode. For instance, if you enabled 16 cameras and select a 4-Cam split display mode, the batches of display will be Camera 1 - 4, Camera 5-8 and so on. When you click camera 8, the DVR system displays the batch of Camera 5 to Camera 8. If you select a 9-Cam split display mode, the 2 display batches will be Camera 1-9 and Camera 8-16. When you assign a camera, the system will show one of the batches.

5. Date / Time / Speed Status

This shows the date and time of recording of the current video file and the playback speed. There are 7 levels of playback speeds: 1/8x, 1/4x, 1/2x, 1x, 2x, 4x, and 8x. The default setting is set at 1x normal speed. Click  or  to set the desired speed.

6. Playback Control Buttons



Begin: Move to the beginning of the video recording.



Previous: Go back to the previous frame.



Slower: Play the video recording at the speed of 1/2x, 1/4x, or 1/8x



Rewind: Play the video file reversely.



Pause: Stop to play the recording.

Chapter 5 Using Remote Program



Play: Play the recording file.



Faster: Play the video recording at the speed of 2x, 4x, or 8x.



Next: Go to the next frame.



End: Go to the end of the video recording.

7. **Date**

Click this button to choose the date of the recorded files that you want to play back.

8. **Camera ID**

Click the desired cameras from which to retrieve previously recorded videos. Video recordings from each chosen camera will be displayed in the split-screen video windows. The chosen camera icons will turn yellow.

5.3 Handy View

NV series provide easy connection. Users can use a PDA or a mobile phone to access the NV DVR through Internet. Just ensure your mobile or PDA connecting to Internet, enter "your website address/MOBLIE" to monitor the channels anytime anywhere. The website IP may vary according to your server IP address. For instance, you may enter <http://61.12.33.65/MOBILE> to access your server. You can watch the latest image by one camera. Click < > to change channels, and click REFRESH to reload the new camera image. Please check **3.2.4 Network setting** to enable Handy View.

5.4 Using PDA Viewer

"PDA Viewer" allows PDA users to monitor channels anytime anywhere as Internet is available.

Before you use PDA Viewer, please meet the PDA System Requirement.

OS: MS Windows CE 4.0 (PocketPC 2003)

CPU: ARM architecture

Follow the steps to install the PDA Viewer application before using a PDA to monitor live video.

AVerMedia NV1000/3000/5000/7000 User's Manual

- A. Connect your PDA to your PC.
Click Install PDA Viewer.



- B. The system will automatically install the PDA Viewer application.



- C. Click Next to continue.

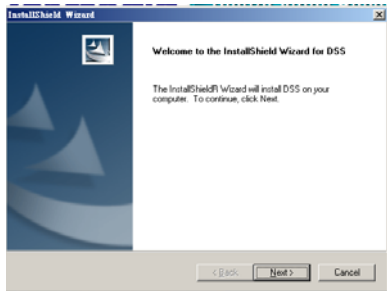

- D. Click **Yes** to continue the installation.

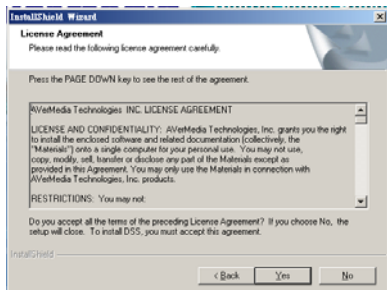

Chapter 5 Using Remote Program

- E. The system automatically installs the application.

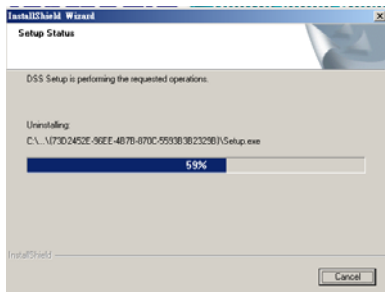

- F. The system appears an 'Install AVerMedia PDA Viewer using the default application directory?' dialog box. Click Yes to use a default directory.

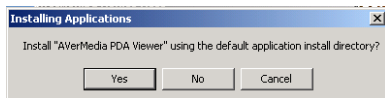

- G. The system continues to install the application.



- H. After finishing the installation, the system will show an "Application Downloading Complete" dialog, click OK.



Note: The system provides PDA-Viewer online download. Open IE and enter server IP. You will see the following screen.



Click the hyperlink, **Download PDA-Viewer**, to see the download screen. Click Yes to download PDA-viewer. The system will automatically install PDA-Viewer after the download is completed.

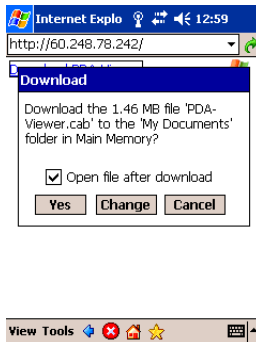

After the installation, you will see an icon  on the PDA desktop. Make sure your PDA connect to Internet before you start monitoring.

Chapter 5 Using Remote Program

Follow the steps to connect to the DVR server.

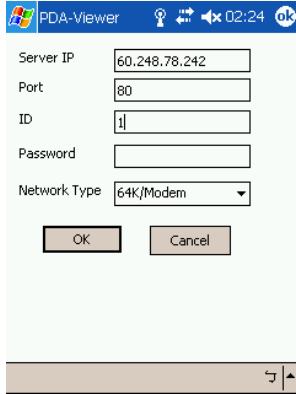

1. Click  on your PDA desktop.
2. Enter the server IP, Port, ID and password. Select a network type and click **OK**.

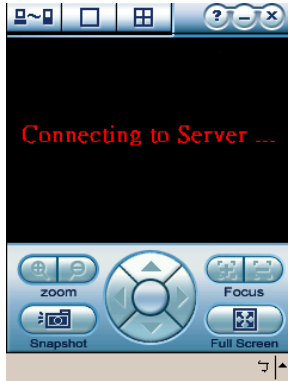



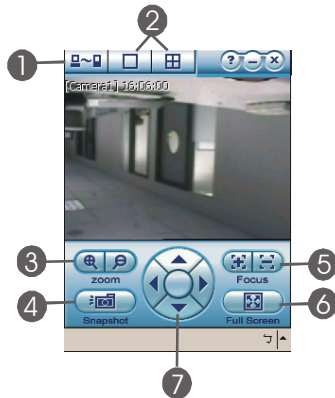

The screen will show "**Connecting to Server**". After you access the server, you can see the following screen.

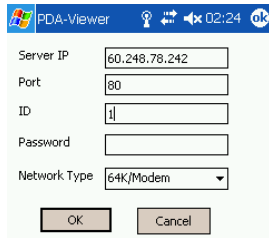





1. **Connecting DVR server**  : Click this button to set the server IP, port, ID and password.

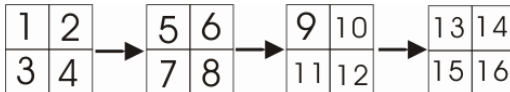

2. **Display mode**   : Click  to view an image from a single camera. Your PDA will show all camera screens in turn. To switch to 4-Cam display mode, click . You will see the following screen. When the quantities of enabled cameras are more than the split screens, the system will show different batches of cameras under 4-Cam split display mode.



For instance, if there are 16 cameras connected to the server, you will see the batches of display will be Camera 1 - 4, Camera 5-8 and so on as the above illustration.

3. **Zoom in / Zoom out**   : You can click  /  to size up / to size down the image when a PTZ camera is enabled. These buttons provide the function to adjust the focal distance of lens to size up / to size down the image. If there is no PTZ camera connected to the server, the buttons will







Chapter 5 Using Remote Program

be disabled.

4. **Snapshot:** Click  to save the desired image.



The system will save the image as a bmp file. Click Save to keep the images.

5. **Focus in / Focus out**  : When a PTZ camera is enabled, you can click  /  to adjust the focus to produce a clearer image during surveillance. If there is no PTZ camera connected to the server, the buttons will be disabled.
6. **Full screen** : Click  to display full screen. Click the screen again to return to the system.

7. **Direction buttons** : You can use the 4 direction buttons to adjust the direction of PTZ camera lens during surveillance.

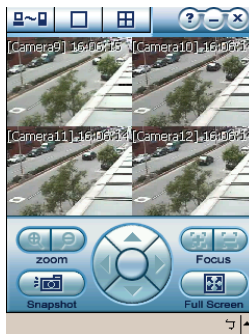

Use the tablet pan to click the screen for 4-5 seconds to change the video quality whether you are under 1-Cam display, 4-Cam display or a full display screen.

AVerMedia NV1000/3000/5000/7000 User's Manual



You will see above screen. Select a proper video quality according to your demand.

Appendix A Registering Domain Names

DDNS (Dynamic Domain Name Service) is a data query service mainly used on the Internet for translating domain names into Internet addresses. It allows remote clients to intelligently search dynamic servers without any previous enquiring for servers' Internet addresses.

In order to take advantage of this intelligent service, first register your domain name on the following Web site: <http://ddns.avers.com.tw>.

1. User Login

Browse the website ddns.avers.com.tw with Microsoft IE or Netscape Navigator to access the following dialog.



The dialog box has a blue title bar with the text "User Login". Below the title bar, there is a light blue background. It contains a text input field labeled "Serial No." with a white border. Below that is a dropdown menu labeled "Product" with "DX7000" selected. At the bottom, there are two buttons: "OK" and "Reset".

First input the serial number of your product and select the product name. Then click **OK** to login or **Reset** to clear the previous input.

2. Password

Set a password to secure your identification.



The dialog box has a blue title bar with the text "Input your password". Below the title bar, there is a light blue background. It contains a text input field labeled "Password" with a white border and a small icon to its left. At the bottom, there are two buttons: "OK" and "Reset".

3. **User Information**

Please provide the following user information, **Host Name**, **Password**, **E-mail**, **Company**, and **Country** to complete the registration process.



Note that Host Name and Domain Name (AVerMedia.avers.com.tw) are the replacement for Internet address while a remote client tends to search a dynamic server.

The image shows a 'User Information' registration form with a blue header and a light blue body. The form contains the following fields and controls:

- Host Name:** A text input field containing 'AVerMedia' with a red asterisk to its right.
- Domain Name:** A text input field containing 'avers.com.tw'.
- Password:** A text input field with masked characters (dots) and a red asterisk to its right.
- Confirm Password:** A text input field with masked characters and a red asterisk to its right.
- E_mail:** A text input field containing 'odysseus@ms1.url.cor' with a red asterisk to its right.
- Company:** A text input field containing 'AVerMedia'.
- Country:** A dropdown menu with 'Taiwan' selected.
- Buttons:** 'OK' and 'Reset' buttons at the bottom.

Appendix B Image Verification

1 ImageVerify is a watermark-checking program to identify the validity of a saved image (e.g. by snapshot).

a. Run the setup/start program

Click Start->Program files->NV->Image Verification to execute the program.

b. Load the image file to start verifying file

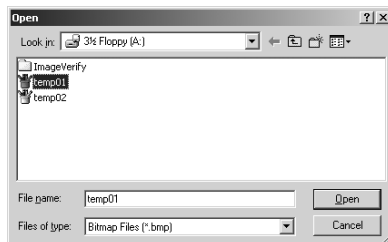
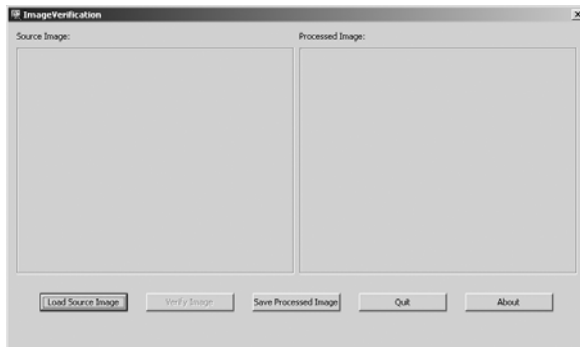

This program can only verify uncompressed bmp image files.

A. Verify image file. Click 'Verify Image' to begin the process.

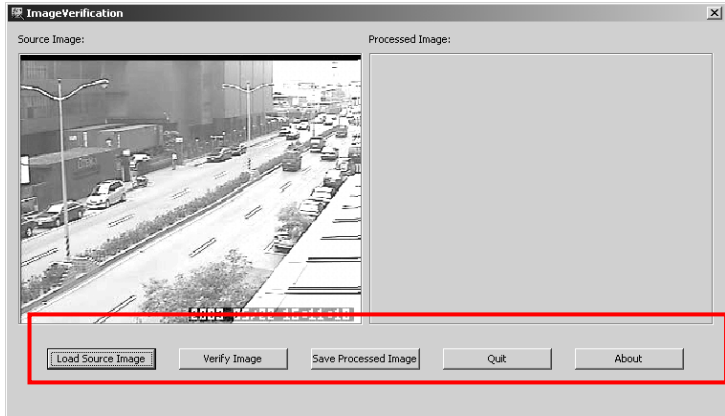

B. ImageVerify returns a result.

(1) If the file is not modified, the same picture appears in the right side result picture box.



(2) If the file is modified, a warning dialog appears.

In the result box, the area that is being changed is highlighted.



Appendix B Image Verification

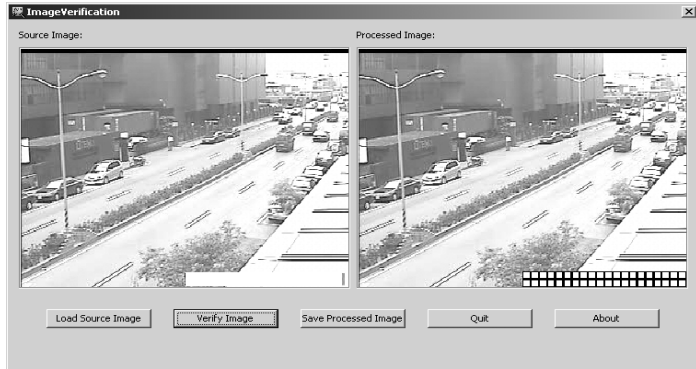

Free Manuals Download Website

<http://myh66.com>

<http://usermanuals.us>

<http://www.somanuals.com>

<http://www.4manuals.cc>

<http://www.manual-lib.com>

<http://www.404manual.com>

<http://www.luxmanual.com>

<http://aubethermostatmanual.com>

Golf course search by state

<http://golfingnear.com>

Email search by domain

<http://emailbydomain.com>

Auto manuals search

<http://auto.somanuals.com>

TV manuals search

<http://tv.somanuals.com>