

# RAMPAGE™

## OWNER'S MANUAL AND INSTALLATION GUIDE

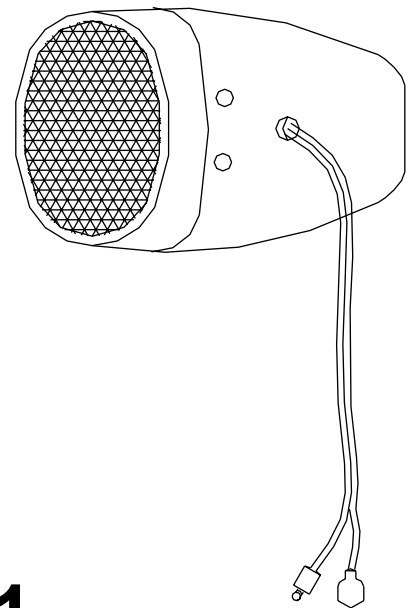

## MODEL SU-101 SUB-WOOFER SPEAKER SYSTEM WITH DUAL SATELLITE TWEETERS

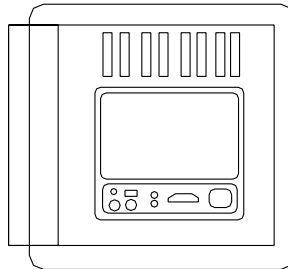
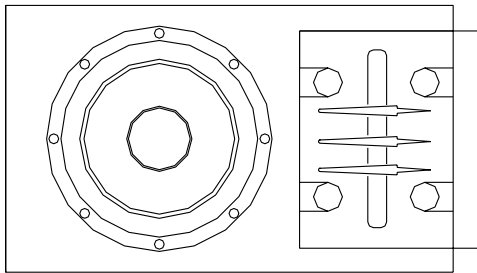

# **INTRODUCTION**

Congratulations on your purchase of the **Rampage** High Performance vehicle Sub-woofer System. High quality Bass reproduction, coupled with dual tweeters, allows your car's audio system perform to its full potential.

# **TOLL-FREE ASSISTANCE**

The installation and connections are so simple we doubt you'll need our help, but if you do, we're here to help you. Just call our toll-free assistance line at **1-800-645-4994** during the days/hours shown.

DAY	TIME ZONE			
	PACIFIC	MOUNTAIN	CENTRAL	EASTERN
MON. - FRI.	5:30AM - 4PM	6:30AM - 5PM	7:30AM - 6PM	8:30AM - 7PM
SATURDAY	6AM - 2PM	7AM - 3PM	8AM - 4PM	9AM - 5PM

# **INDEX**

Introduction and Contents	Page 2	Satellite Tweeter Configuration	Page 6
Packing List	Page 3	Wiring Instructions	Page 7
Major Components	Page 3	SU-101 Speaker System Interconnection Wiring Diagram	Page 8
Installation Parts	Page 3	Use of Controls	Page 9
Placing the System	Page 4	Troubleshooting	Page 10
Installation Sub-woofer Enclosure	Page 5	Specifications	Page 10
		Warranty	Page 11

# PACKING LIST

Installation of your SU-101 is easy and everything you need is included in this package. Open it up, lay out the parts and you are ready to get started.

## MAJOR COMPONENTS



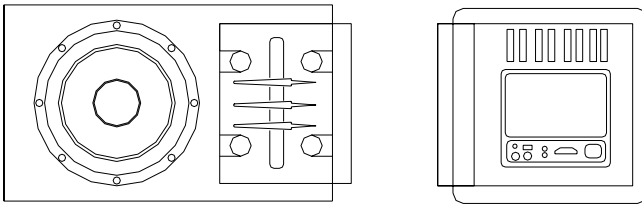



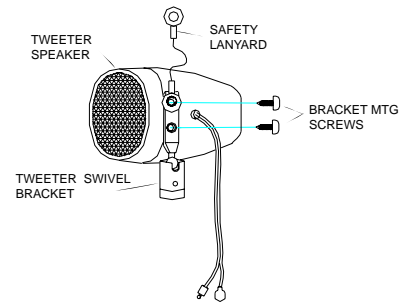





Sub-woofer Enclosure Assembly

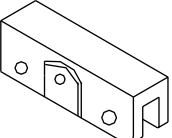

Tweeters (2)

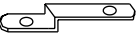
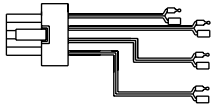
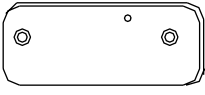

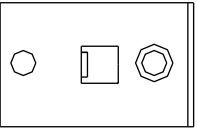
## INSTALLATION PARTS

4 pcs		Socket-Head Machine Screw M6 x 12 mm	12 Vdc B+ Wire (Yellow, 4.0 M)		1 pc
4 pcs		Pan-Head Machine Screw M5 x 10 mm	Remote Wire (Blue, 3.0 M)		1 pc
4 pcs		M5 Flat Washer	Ground Wire (Black, 1.3 M)		1 pc
2 pcs		Tweeter Mtg U-Channel Bracket	High Input/Output Extension Cable Assys (4 M Each)		2 pcs
2 pcs		Tweeter Mtg Bracket	Enclosure Cable Assembly (High Level In/Out)		1 pc
2 pcs		Tweeter Mtg Retaining Plate	Hex Allen-Head Driver (2.5mm and 5mm)		2 pcs
			Enclosure Mtg Bracket		4 pcs
			Hex-Head Tapping Screw (with Captive Washer) 5mm x 25 mm		8 pcs

## Placing the System

1. Mount the subwoofer enclosure in either the Rear Cargo Area (for Vans, SUVs and Hatchbacks) or in the trunk (for sedans).
2. Mount the tweeters on the vehicle interior, high up for maximum sound and facing forward for optimum usage.

## Important Installation Warnings

1. **NEVER** attempt to install this system in the area above the vehicle fuel tank. Drilling mounting holes could pierce the fuel tank.
2. **ALWAYS** check under the area you select for installation, for wires or other obstructions.
3. **ALWAYS** make sure that you mount the subwoofer so the control panel is accessible to facilitate adjustments.
4. **NEVER** try to extend the length of the cables supplied with your system. The High Level Input/Output cable from the speaker enclosure and the four RCA jacked extension cables are 15 feet long. **DO NOT** exceed this length in your installation.
5. **CAREFULLY** plan the routing of your wires from the rear deck area to the dashboard and/or satellite tweeters, keeping in mind the length of the available cables.
6. **CHECK** to make sure your chosen installation place does not interfere with the removal of your spare tire.
7. **REMEMBER** that failure to properly install the subwoofer enclosure may affect sound quality.  
Follow the installation instructions for best results.

### REAR CARGO AREA MOUNTING (VANS, SUVs AND HATCHBACKS)

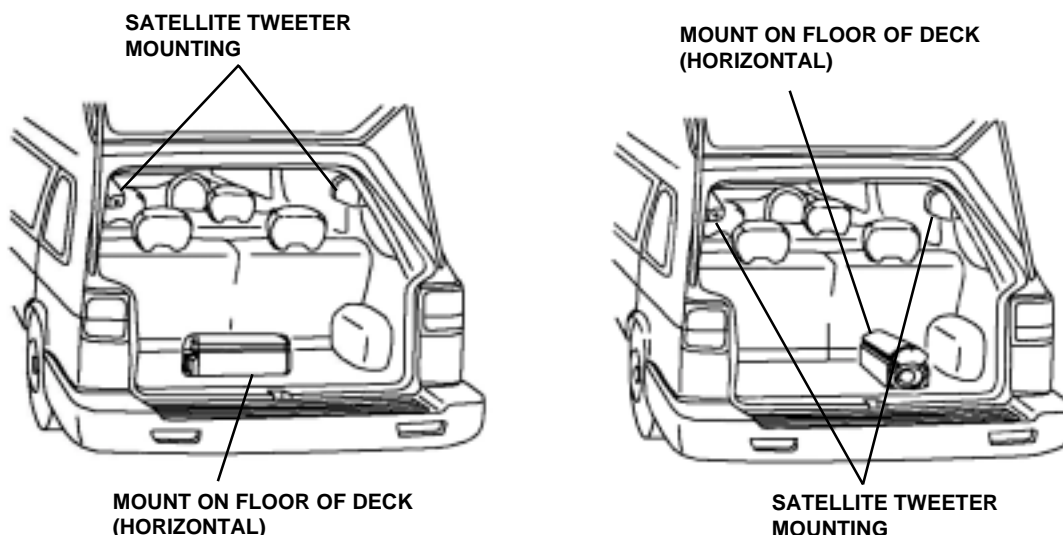

### TRUNK MOUNTING (SEDANS)

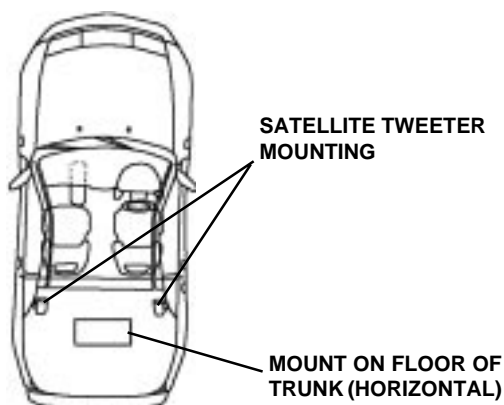

# INSTALLATION

## SUB-WOOFER ENCLOSURE

The SU-101 sub-woofer enclosure is designed for horizontal (flat) mounting. It must never be mounted upside-down or on either of its sides. The most convenient area for enclosure installation is within the trunk of cars, such as sedans, or on the rear cargo area of vans and SUVs. It is also possible to mount the unit behind the front seat area of utility and pick-up trucks if space allows.

The following procedure outlines the basic installation criteria for the enclosure.

1. On a flat surface, place the enclosure upside down and determine the position of each of the four mounting brackets; each should be positioned in from each corner approximately 2 inches.

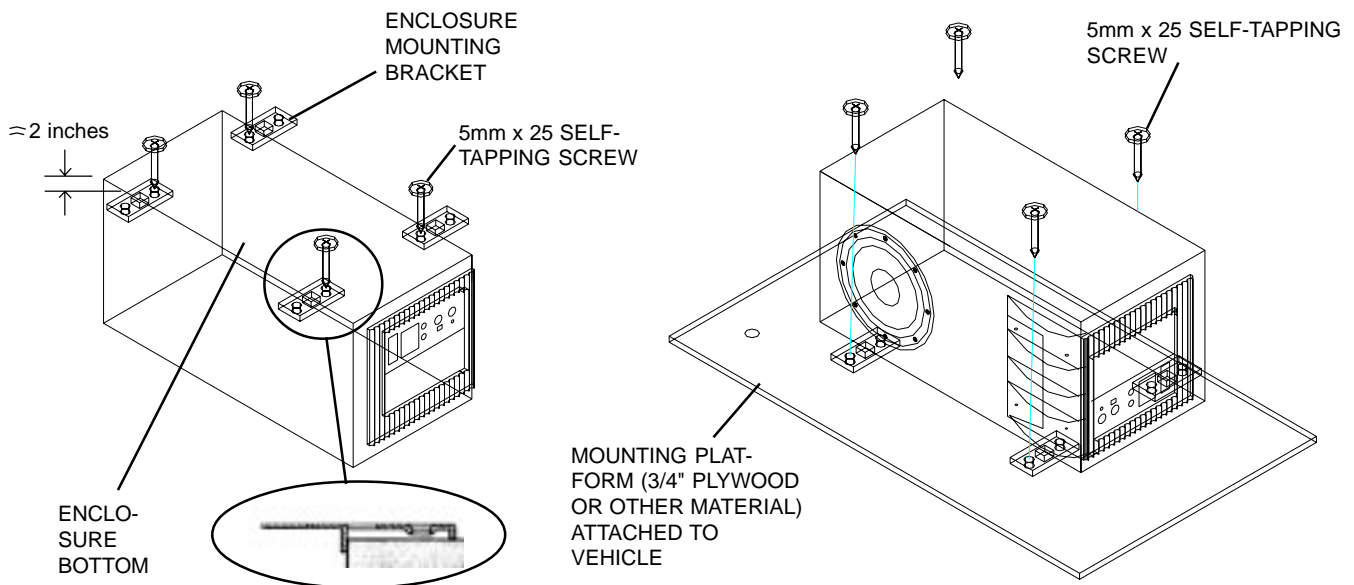

2. Attach each bracket using four of the 5mm x 25 self-tapping screws supplied.

**NOTE:** Make sure to orient each bracket so the tab contacts the side of the unit. This will prevent the bracket from shifting during vehicle movement, sudden stops, etc.

3. Secure the enclosure to the surface (trunk or deck ) of the vehicle in the desired position. If desired, a mounting platform of 3/4" plywood or other material could be used to compensate for uneven surfaces within the vehicle; the enclosure could then be mounted to this surface.
4. Center the enclosure either on the vehicle surface or on the mounting platform and secure the unit using the remaining four 5mm x 25 self-tapping screws through the bracket holes.
5. Proceed to the wiring diagram on page 8 of this manual.

## SATELLITE TWEETERS CONFIGURATION:

Normally, the satellite tweeter each is supplied with the bracket and lanyard wire attached as shown in the drawing to the right. If the speaker is not assembled as shown, assemble the swivel bracket and lanyard to the speaker as illustrated. The bracket, lanyard and screws are packed with each speaker.

## SATELLITE TWEETERS

The two satellite tweeters supplied with the system are intended for mounting inside the vehicle interior; they can be mounted several different ways.

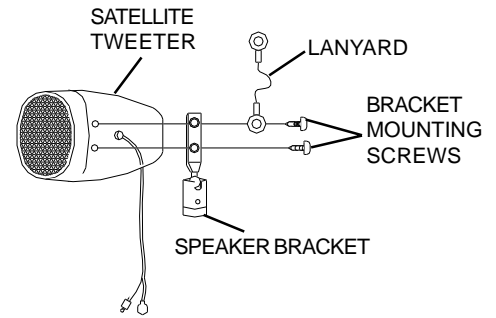

SATELLITE TWEETER CONFIGURATION

### 1. Mounting the Speaker to the Rear Wall:

The satellite tweeter can be mounted to the interior rear wall on each side of the vehicle, aft of the rear window. Suggested locations are the clothes hangar clip and/or the assist handle. To accomplish this, proceed as follows:

- Attach one end of a stepped metal bracket to each speaker bracket as shown using an M5 x 10 mm screw.
- Loosen the assist handle or clothes hangar clip at the desired mounting location.
- Attach the other end of the stepped bracket to the desired mounting location using the existing factory hardware. The speaker lanyard should be securely attached to the other available factory hole locations using the existing factory hardware.
- Orient the speaker (facing front) as desired and tighten the speaker bracket setscrew to maintain this position.

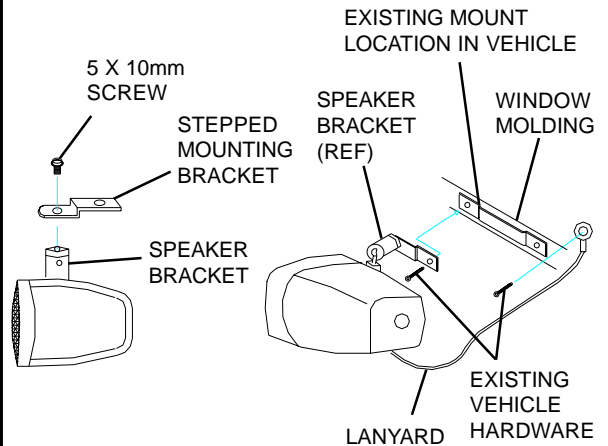

### 2. Mounting the Speaker over the Rear Molding:

The satellite tweeter can be mounted over the edge of the molding that runs along the interior rear wall on each side of the vehicle. To accomplish this, proceed as follows:

- Attach a U-channel bracket to each speaker bracket using an M5 x 10 mm screw; the screw can be tightened by extending the screwdriver through the large access hole in the U-channel bracket as shown.
- Slip the U-channel bracket over the top edge of the molding; then slide the retaining plate in front of the molding surface. Secure each assembly in place by threading two M6 x 12 mm screws through the U-channel bracket into the indents of the retaining plate, clamping the retaining plate securely against the molding surface. The speaker lanyard should be securely attached to the other available factory hole locations using the existing factory hardware.
- Orient the speaker as desired and tighten the speaker bracket setscrew to maintain this position.

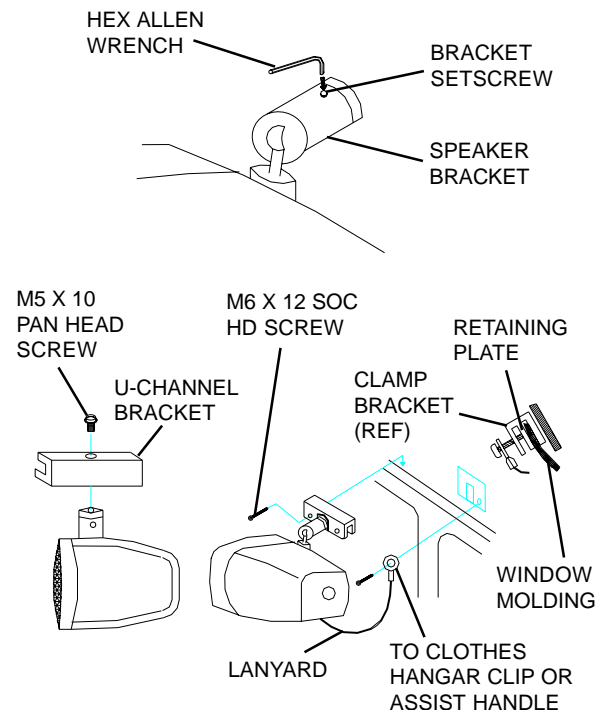

## WIRING INSTRUCTIONS

The power connections for the SU-101 enclosure are made via a screw-tightened terminal block. Simply loosen the screw fully insert the wire or spade lug under the respective terminal screw, then tighten the screw to secure the lug.

### 1. Power Connection

The battery terminal (**B+**) must be connected directly to the positive terminal of the vehicle battery to provide an adequate voltage source and minimize noise. Connecting the battery terminal lead to any other point (such as the fuse block) will not power-up the SU-101. Use only the **Yellow** wire supplied for this purpose. Connect this lead to the battery terminal after all other wiring is completed.

### 2. Ground Connection

The ground terminal (**GND**) terminal connection is also critical for correct operation of the SU-101. Use only the supplied **Black** wire with spade lugs for this purpose, and connect it between the ground terminal (**GND**) of the enclosure and a metal part of the vehicle close to the mounting location. This wire should be as short as possible and any paint or rust at the grounding point should be scraped away to provide a clean metal surface to which the end of the ground wire can be screwed or bolted.

### 3. Remote Turn-On Connection

The SU-101 is turned on by applying +12 volts to the remote turn-on terminal (**REM**). The supplied **Blue** wire with spade lugs should be attached between this terminal and the "Auto-Antenna" lead from the car stereo which will provide +12 volts only when the car stereo is turned on. If the car stereo does not provide an Auto-Antenna lead, the remote turn-on lead may be wired to an "Accessory" or "Radio" terminal in the car's fuse block. This will turn the amplifier on and off with the ignition key, regardless of whether the car stereo is on or off.

### 4. Speaker Connections

Wire the satellite speakers to the "Speaker Output" terminals as per the Output Wiring Diagram using the supplied input/output extension cable assemblies. When mating the wiring to the speakers, pay careful attention to the polarity of the speaker leads, and make certain they correspond to the polarity of the corresponding terminals on the high level input/output 10-pin adapter harness. **DO NOT** ground any speaker leads to the chassis of the vehicle.

### 5. Input Connections

The sub-woofer enclosure features both high and low-level input capability. Use either the low-level or high-level inputs, not both. If low-level outputs are provided from the car stereo, it is recommended that the low-level inputs be used for lowest distortion and best performance. Use good quality shielded audio cables with RCA plugs (not supplied) at both ends to connect the stereo to the sub-woofer enclosure **L** and **R** low-level input jacks; keep the cable lengths to a minimum to avoid noise.

If the car stereo does not provide low-level outputs, the sub-woofer may be connected via the speaker (high-level) outputs from the stereo. Wire the speaker leads from the car stereo to the supplied 10-pin adapter harness using the supplied RCA tip-jack cable assemblies as shown in the diagram (shielded cable is not required for this application), and plug the harness connector into the mating High-Level Input connector on the enclosure. Carefully mate and insulate all wire connections.

**CAUTION:** Use either the low-level or the high-level inputs on the enclosure. **DO NOT** use both input levels at the same time.

# SU-101 SPEAKER SYSTEM INTERCONNECTION WIRING DIAGRAM

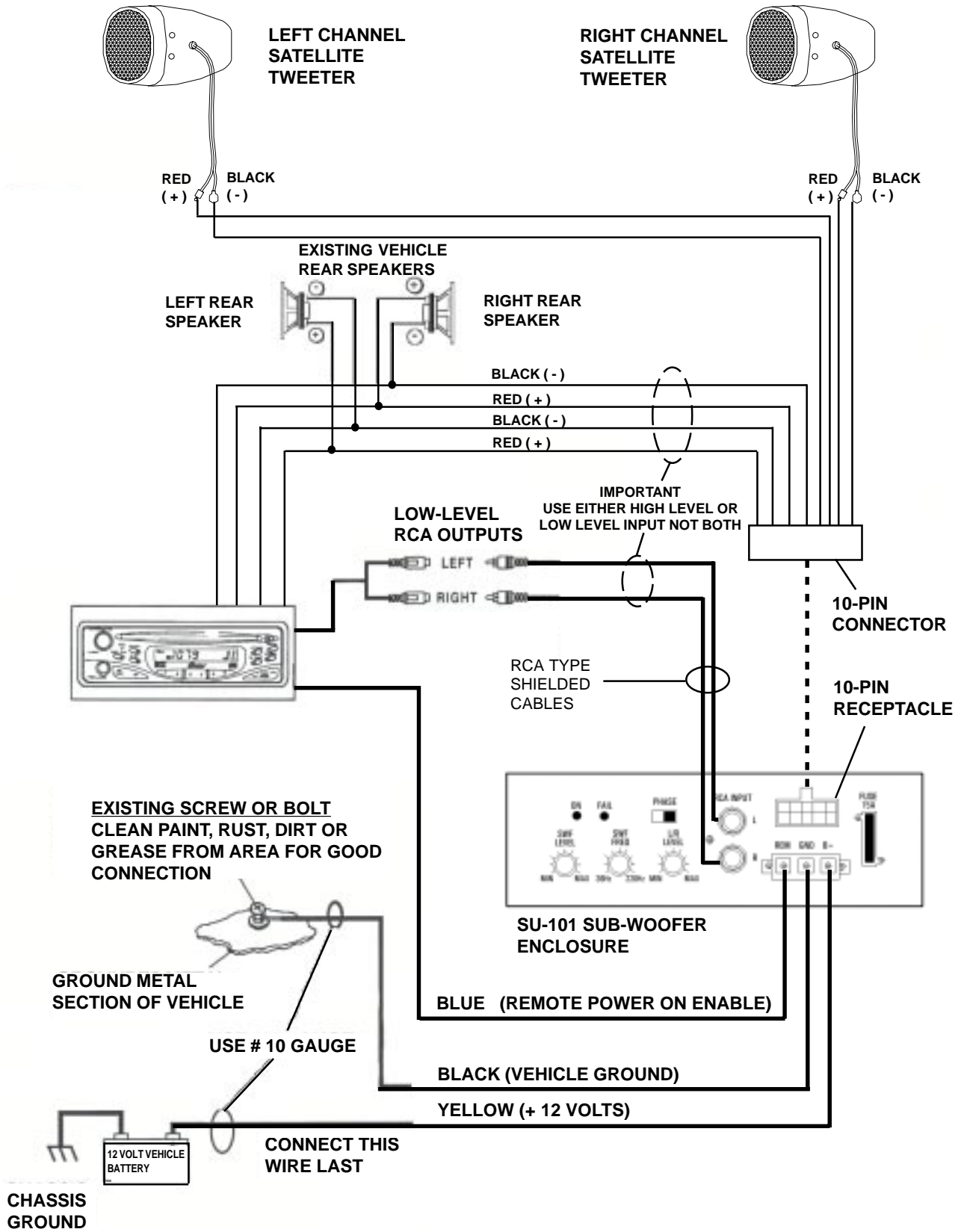



# USE OF CONTROLS

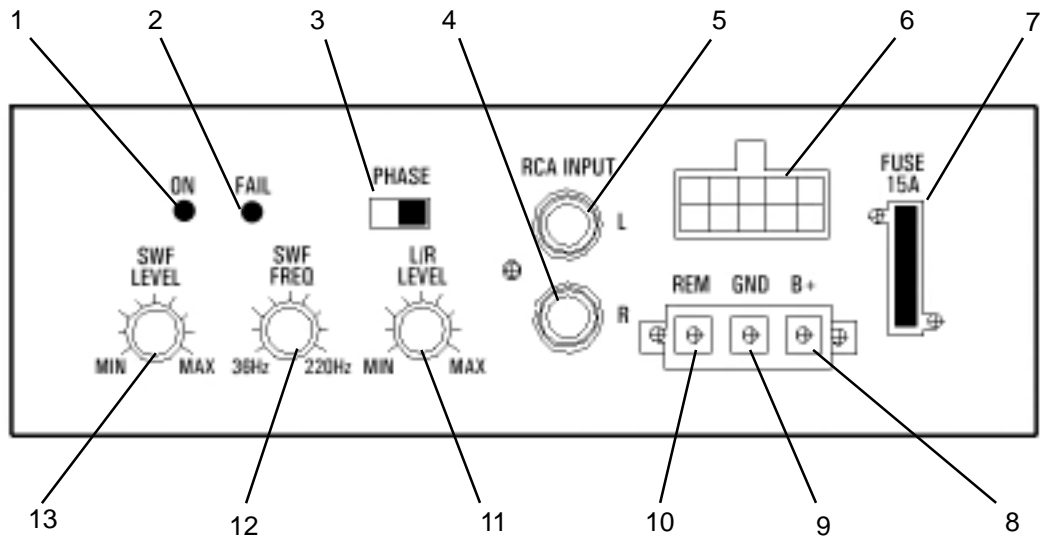

## ① ON LED INDICATOR

This indicator lights green when the system is powered up and operating normally.

## ② FAIL LED INDICATOR

This indicator lights red when a system failure occurs activating the overvoltage protection circuit.

## ③ PHASE SELECT SWITCH

This slide switch is used to change the phase of the reproduced sound output from the SU-101 Speakers to match the phase of the audio receiver system.

## ④ RCA INPUT - R CONNECTOR

This connector accepts the right channel low level output RCA connector (LINE OUT) from the vehicle radio receiver.

## ⑤ RCA INPUT - L CONNECTOR

This connector accepts the left channel low level output RCA connector (LINE OUT) from the vehicle radio receiver.

## ⑥ HIGH LEVEL INPUT/OUTPUT CONNECTOR

This 10-pin connector provides audio (speaker) connections between the sub-woofer enclosure, the satellite tweeters and existing audio receiver system.

## ⑦ FUSE - 15A

This fuse provides surge/overvoltage protection for the SU-101 speaker system.

## ⑧ B+ TERMINAL

Connect +12Vdc vehicle power to this terminal using the **Yellow** wire supplied (4 meters long).

## ⑨ GND TERMINAL

Connect this terminal to vehicle chassis ground using the **Black** wire supplied (1.3 meters long).

## ⑩ REMOTE (REM) TERMINAL

Connect the remote output from the car audio system to this terminal using the **Blue** wire supplied (3 meters long).

## ⑪ L/R LEVEL CONTROL

This control varies the audio output level to the satellite tweeters between MIN and MAX.

## ⑫ SWF FREQ CONTROL

This control adjusts the sub-woofer low-pass-filter cutoff frequency between 36 Hz and 220 Hz.

## ⑬ SWF LEVEL CONTROL

This control varies the audio output level to the sub-woofer enclosure between MIN and MAX.

## TROUBLESHOOTING

An error made in operation or during installation of this product may be mistaken for a system malfunction. Please perform the checks described below before contacting your dealer or service facility.

Symptom	Possible Cause	Remedy
No power	Blown fuse	Check fuses in vehicle fuse box and SU-101 system. Replace as necessary with fuse of same type and rating as original. If fuse blows again, consult with service facility.
	Incorrect connection	Check all wiring and correct as necessary.
Sub-woofer audio output distorted	Use PHASE switch to adjust the phase relationship between car audio system and sub-woofer system.	Check all wiring and correct as necessary. Consult with service facility.
Satellite tweeter audio output too low	Use L/R LEVEL control on enclosure to adjust tweeter audio output to desired level.	Check satellite tweeter wiring. Consult with service facility.
Sub-woofer audio output too low	Use SWF LEVEL control on enclosure to adjust sub-woofer audio output to desired level.	Check wiring between sub-woofer enclosure and existing audio system. Consult with service facility.

## Specifications:

### Speaker Section:

Woofer (1)	8" Cone Type
Tweeter (2)	3" Satellite Speaker
Impedance	4 Ohms

### Power Amplifier Section:

Inputs	Low-Level RCA Jack and High Level Speaker Inputs
Maximum Output	360 Watts
Nominal Output	55 Watts (150 Hz, 0.1% THD)
Input Level Adjustment Range	0.2 - 4.0 V Low Level 0.4 - 8.0 V High Level
Harmonic Distortion	< 0.03 % (at 100 Hz)
Low-Pass Filter	Cut-Off Frequency 36 - 220 Hz (Variable), 18 dB/Octave
Satellite Tweeter Frequency Range	2 kHz - 20 kHz
Subwoofer Frequency Range	30 Hz - 300 kHz

### System Section:

Input Power Requirements	12 Vdc Car Battery (Negative Ground)
Power Supply Voltage (min/max)	10.5/16 Vdc
Current Drain	13 Amps at Rated Output 1.5 mA Remote Input
Dimensions	
Main Unit	420 mm x 249 mm x 249 mm (16 2" W x 9F" H x 9F" D)
Satellite Tweeter	76 mm x 76 mm x 102 mm (3.0" W x 3.0" H x 4.0" D)
Weight	
Main Unit	9 kg (19 lbs, 13 oz)
Satellite Tweeter	0.4 kg (0.85 lb, 0.58 oz)

### **WARNING:**

High-powered car audio systems may produce sound pressure levels that exceed the threshold at which hearing loss may result. They may also impair a driver's ability to hear traffic sounds or emergency vehicles. Use common sense and practice safe listening habits when listening to your audio system.

## 90 DAY LIMITED WARRANTY

AUDIOVOX CORPORATION (the Company) warrants to the original retail purchaser of this product that should this product or any part thereof, under normal use and conditions, be proven defective in material or workmanship within 90 days from the date of original purchase, such defect(s) will be repaired or replaced with new or reconditioned product (at the Company's option) without charge for parts and repair labor.

To obtain repair or replacement within the terms of this Warranty, the product is to be delivered with proof of warranty coverage (e.g. dated bill of sale), specification of defect(s), transportation prepaid, to the warranty center at the address shown below.

This Warranty does not extend to the elimination of car static or motor noise, to correction of antenna problems, to costs incurred for installation, removal, or reinstallation of the product, or damage to tapes, compact discs, speakers, accessories, or vehicle electrical systems.

This Warranty does not apply to any product or part thereof which, in the opinion of the Company, has suffered or been damaged through alteration, improper installation, mishandling, misuse, neglect, accident, or by removal or defacement of the factory serial number/bar code label(s). THE EXTENT OF THE COMPANY'S LIABILITY UNDER THIS WARRANTY IS LIMITED TO THE REPAIR OR REPLACEMENT PROVIDED ABOVE AND, IN NO EVENT, SHALL THE COMPANY'S LIABILITY EXCEED THE PURCHASE PRICE PAID BY PURCHASER FOR THE PRODUCT.

This Warranty is in lieu of all other express warranties or liabilities. ANY IMPLIED WARRANTIES, INCLUDING ANY IMPLIED WARRANTY OF MERCHANTABILITY, SHALL BE LIMITED TO THE DURATION OF THIS WRITTEN WARRANTY. ANY ACTION FOR BREACH OF ANY WARRANTY HEREUNDER INCLUDING ANY IMPLIED WARRANTY OF MERCHANTABILITY MUST BE BROUGHT WITHIN A PERIOD OF 30 MONTHS FROM DATE OF ORIGINAL PURCHASE. IN NO CASE SHALL THE COMPANY BE LIABLE FOR ANY CONSEQUENTIAL OR INCIDENTAL DAMAGES FOR BREACH OF THIS OR ANY OTHER WARRANTY, EXPRESS OR IMPLIED, WHATSOEVER. No person or representative is authorized to assume for the Company any liability other than expressed herein in connection with the sale of this product.

Some states do not allow limitations on how long an implied warranty lasts or the exclusion or limitation of incidental or consequential damage so the above limitations or exclusions may not apply to you. This Warranty gives you specific legal rights and you may also have other rights which vary from state to state.

**U.S.A. :** AUDIOVOX CORPORATION, 150 MARCUS BLVD., HAUPPAUGE, NEW YORK 11788 • 1-800-645-4994

**CANADA:** CALL 1-800-645-4994 FOR LOCATION OF WARRANTY STATION SERVING YOUR AREA

Form No. 128-5047A



For Customer Service  
Visit Our Website At  
**www.audiovox.com**  
Product Information, Photos,  
FAQ's, Owner's Manuals

## Free Manuals Download Website

<http://myh66.com>

<http://usermanuals.us>

<http://www.somanuals.com>

<http://www.4manuals.cc>

<http://www.manual-lib.com>

<http://www.404manual.com>

<http://www.luxmanual.com>

<http://aubethermostatmanual.com>

Golf course search by state

<http://golfingnear.com>

Email search by domain

<http://emailbydomain.com>

Auto manuals search

<http://auto.somanuals.com>

TV manuals search

<http://tv.somanuals.com>