



AUDIOWOX®
ELECTRONICS CORP.

VE720

UNDER THE COUNTER 7" TV,

AM/FM RADIO and DVD

PLAYER

OWNER'S and INSTALL

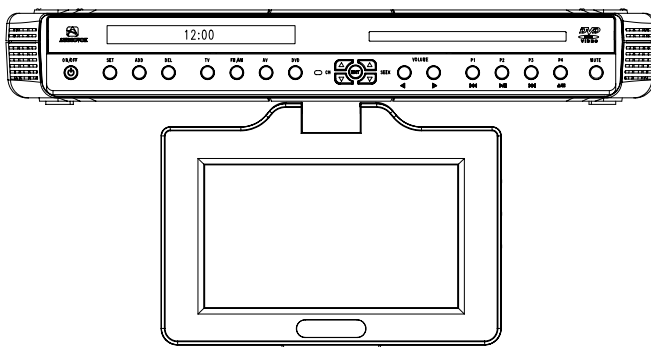

- Slot-in DVD Player & 9" TFT LCD Monitor
- Multi-function Remote Control
- Cable Ready 125 Channel TV Tuner
- AM/FM Radio
- 2 A/V Inputs
- Internal Stereo Speakers
- Under Cabinet / Table Top Mounting

INTRODUCTION

WARNING – To prevent fire or shock hazard, do not expose this unit to moisture.

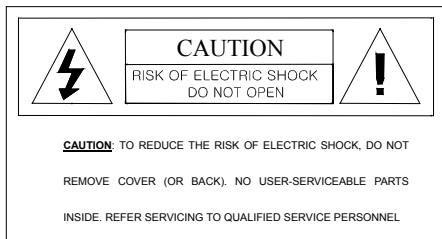

CAUTION: TO REDUCE THE RISK OF ELECTRIC SHOCK, DO NOT REMOVE COVER (OR BACK). NO USER-SERVICEABLE PARTS INSIDE. REFER SERVICING TO QUALIFIED SERVICE PERSONNEL.

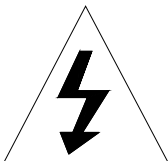

This symbol alerts the user to the fact that exposed “dangerous voltages” reside within this product’s enclosure and contact with any of these voltages will result in electric shock.

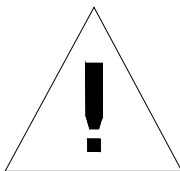

This symbol alerts the user that important and maintenance (servicing) instructions in the literature accompanying the unit.

To prevent electric shock: do not use this unit’s polarized ac plug with extension cords, receptacles or other outlets that prevent the units plug from being fully seated and leave any part of the blade exposed.

INFORMATION

Installation of this equipment shall be in strict accordance with the manufacture's instructions. Failure to follow these instructions may cause or result in the reception of unwanted interference. This unit complies with FCC Rules Part 15, which are designed to provide reasonable protection against interference in a residential installation. However, there is no guarantee that interference will not occur in a particular installation. If this equipment does cause harmful interference with radio or television reception, which can be determined by turning the equipment off and on, the user is encouraged to try to correct the interference by one or more of the following means:

Reorient or relocate the receiving antenna

- Increase the separation between the equipment and receiver
- Connect the equipment to an outlet on a circuit different from that to which the receiver is connected
- Consult with the dealer or an experienced radio/TV technician for help

NOTE:

Record your unit's Model Number and Serial Number in the space provided below. Refer to these numbers if you need to call your AUDIOVOX dealer regarding this product.

<u>MODEL No.</u>	<u>SERIAL No.</u>
<hr/>	

IMPORTANT SAFETY INFORMATION

1. **Read Instructions** – All the safety and operating instructions should be read before the product is operated.
2. **Retain Instructions** – The safety and operating instructions should be retained for future reference.
3. **Heed Warnings** – All warnings on the product and in the operating instructions should be adhered to.
4. **Follow Instructions** – All operating and use instructions should be followed.
5. **Cleaning** – Unplug this product from the wall outlet before cleaning. Do not use liquid or aerosol cleaners. Use a damp cloth for cleaning. Do not apply pressure to the LCD screen. Excess pressure may damage the screen.
6. **External Accessories** – Do not use external accessories that have not been recommended by the product manufacturer, as they may damage the unit.
7. **Water and Moisture** – Do not use this product near water, for example, near a bathtub, kitchen sink, washing machine, in a wet basement, near a swimming pool, or similar environment.
8. **Mounting considerations** – Do not mount this product on an unstable surface. The product may fall, causing serious injury to a child or adult, and may result in damage to the product. Use only with a cart, stand, tripod, bracket, or table recommended by the manufactures, or sold with the product. Mounting of this product should be in accordance the manufacture's instructions, and should use the mounting hardware provided with the unit by the manufacturer.
9. **Carts** – A product and cart combination should be moved with care. Quick stops, excessive force, and uneven surfaces may cause the product and cart combination to overturn.
10. **Ventilation** – Slots and openings in the cabinet are provided for ventilation and protect the product from over heating. These openings must not be blocked or covered. This product should not be placed in a built-in installation such as a bookcase or rack unless proper ventilation is provided.
11. **Power Sources** – This product should be operated only from the type of power source indicated on the marking label. If you are not sure of the type of power supply in your home, consult your product dealer or local power company.
12. **Grounding or Polarization** – This product may be equipped with a polarized alternating current line plug (a plug having one blade wider than the other). This plug will fit into the power outlet only one way this is a safety feature. If you are unable to insert the plug into the outlet, try rotating the plug 180 degrees. If the plug still cannot be inserted, contact your electrician to replace your outlet. Do not defeat the safety purpose of the polarized plug, doing so will void product warranty.



13. **Power-Cord Protection** – Route the power supply cord in a manner that protects it from being stepped on or pinched by items placed on it. Pay particular attention to the power cord's plug, and the point where the power cord exits from the product.
14. **Outdoor Antenna Grounding** – If an outside antenna or cable system is being connected to the product, verify that it is properly grounded to insure some type of protection against voltage surges and static build-up. Article 810 of the National Electrical Code, ANSI/NFPA 70, provides information with regards to proper grounding of the mast, supporting structure, grounding of the lead-in wire to an antenna discharge unit, size of grounding conductors, location of antenna-discharges unit, and connection to grounding electrode
15. **Lightning** – For added protection against lightning storms, or when the unit is not going to be used for long periods of time, it is recommended that it be unplugged from the wall outlet and disconnected from the antenna or cable system. This will prevent damage to the product due to lightning and power-line surges.
16. **Power Lines** – An outside antenna system should not be located in the vicinity of overhead power lines or other electric light or power circuit, or where it can fall into such power lines or circuits. When installing an outside antenna system, extreme care should be taken to keep from touching such power lines or circuits, as contact with them might be fatal.
17. **Overloading** – Do not overload wall outlets, extension cords, or integral convenience receptacles, as this can result in a risk of fire or electric shock.
18. **Object and Liquid Entry** – Never insert objects of any kind into this product through the openings in the chassis as this may result in a fire or electric shock. Never spill liquid of any kind on the product.
19. **Servicing** – Do not attempt to service this product yourself as opening or removing covers will expose you to dangerous voltages and other hazards. Refer servicing to qualified service personnel.
20. **Damage Requiring Service** – Unplug this product from the wall outlet and refer servicing to qualified service personnel under the following conditions:
 - A. When the power-supply cord or plug is damaged.
 - B. If liquid has been spilled, into the product.
 - C. If the product has been exposed to rain or water.
 - D. If the product does not operate normally as defined by the operating instructions. Adjust only those controls that are covered by the operating instructions, as an improper adjustment of other controls may result in damage and will often require extensive work by a qualified technician to restore the product to it's normal operation.
 - E. If the product has been dropped or damaged in any way.
 - F. When the product exhibits a significant change in performance this indicates a need or service.

21. **Replacement Parts** – When replacement parts are required, be sure the service technician has used replacement parts specified by the manufacturer or that have the same characteristics as the original part. Unauthorized substitutions may result in fire, electric shock or other hazards.
22. **Safety check** – Upon completion of any service or repairs to this product, ask the service technician to perform safety checks to determine that the product is in proper operating condition.
23. **Mounting** – The product should be mounted only as specified in this manual.
24. **Heat** – The product should be situated away from heat sources such as radiators, heating vents, stoves, or other products (including amplifiers) that produce heat.

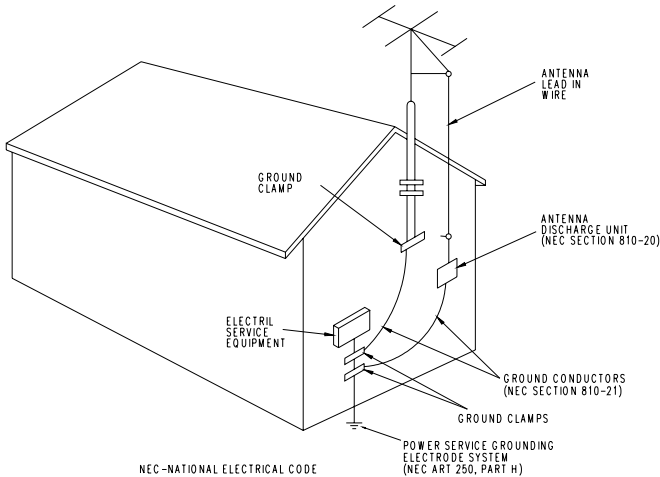

– Cable System Installation:

Note to CATV system installer: “This reminder is provided to call the CATV (CABLE-TV) system installer’s attention to article 820-40 of the NEC, that provides guidelines for proper grounding and, in particular, specifies that the cable ground shall be connected to the grounding system of the building, as close to the point of cable entry as possible”

– Under cabinet mounting:

CAUTION: to reduce the risk of fire, do not place any heating or cooking product beneath this unit.

– Speaker Impedance Marking:

External 8 ohm speakers only

TABLE OF CONTENTS

Before You Begin	Introduction _____	1
	Important Safety Information _____	3
	Table of Contents _____	6
	Contents of package _____	7
Installation	Under Cabinet Installation _____	8
	Countertop/Desktop Installation _____	9
	Front Panel Controls _____	10
	Rear Panel Controls _____	11
	Battery Installation _____	12
Remote Control Functions	Remote Control Functions _____	13
Modes of Operation	Operation _____	16
	Initial Set up_____	16
	Channel Tuning Set up_____	16
	Positioning the Screen_____	16
	Setting the Time_____	16
	SETTING THE ALARM VOLUME_____	16
	Setting and Activating The Alarm_____	16
	Deactivating Alarm_____	17
	Setting the Alarm Tones_____	17
	Setting the Cable TV Mode_____	17
	Setting the Air TV Mode_____	18
	Setting the Speaker Mode_____	18
	Setting the Presets (FM and AM or TV Modes)_____	18
Using the DVD Loader	Using the DVD Loader _____	19
	Inserting and Ejecting the Disc_____	19
	Playback and Stop_____	19
	Searching for a Specific Scene/Song	
	by Selecting the Chapter Number_____	19
	by Using the Chapter_____	19
	by Using Playback Speed_____	20
	Repetitive Playback	
	To Repeat a Specific Section_____	20
	Changing the Subtitle Language_____	20
	Changing the Vocal Language_____	20
	To Enlarge a Picture_____	21
	Viewing Different Angles_____	21
	Viewing a Menu Installed in Discs_____	21
	Viewing the Playback Time, Title, Chapter Status_____	21
	Playing Audio CDs_____	23
	Playing MP3 Discs_____	23
	Playing A JPEG FILE_____	25
	SETUP (Language, Video, Rating)_____	25
Technical Specifications	Technical Specifications _____	29
Troubleshooting Check List	Troubleshooting Check List _____	30

CONTENTS OF PACKAGE

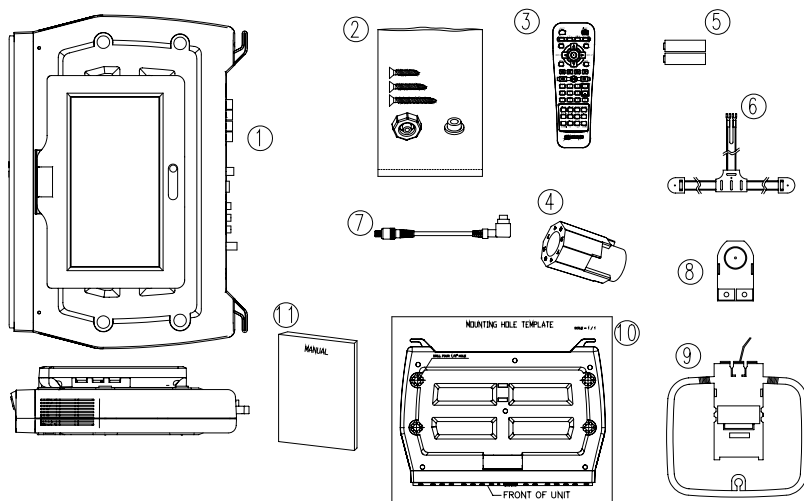

1. VE720

2. Hardware bag

- A. 2" Mounting screws (4)
- B. 2-1/2" Mounting screws (4)
- C. 3" Mounting screws (4)
- D. Foot (4)
- E. Hole cap (4)

3. Remote Control

4. Multi Height Spacer (4)

5. Batteries (AAA)

6. FM Dipole Antenna

7. Right Angle Coaxial Adaptor

8. FM Antenna Balun

9. AM Antenna

10. Mounting Hole Template

11. Owners Installation manual

UNDER CABINET INSTALLATION

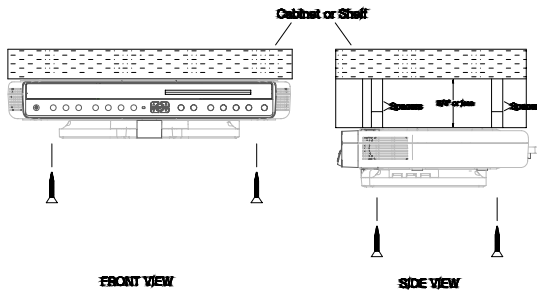

- 1) Choose an appropriate mounting location underneath a cabinet or shelf. Close proximity to an electrical outlet, TV antenna or cable connection will facilitate a neat, easy installation. Do not mount the VE720 above a range or oven. Be sure that the location chosen will provide adequate access to the electrical connections on the rear of the unit before continuing.
- 2) If the location chosen has a bottom edge molding it may be necessary to use the mounting spacers provided to effectively lower the VE720 below or even with the molding. Measure the distance between the edge molding and the bottom of the cabinet. The spacers and mounting holes are stepped to achieve different mounting heights from .5" to 1". Adjusting the mounting height is done by lifting and rotating the spacer in the mounting hole. Choose a spacer height, which will allow the VE720 to clear the edge molding.
- 3) Measure the thickness of the bottom of the cabinet or shelf and the spacer height chosen. Select the shortest screw length, which will secure the VE720 to the bottom of the cabinet.
- 4) Cut out the template supplied and tape it in place onto the cabinet surface to be drilled. Center punch the four holes indicated on the template and remove the template.
- 5) Carefully drill four 1/8" holes at the locations marked above.
- 6) Connect your TV antenna or cable system to the antenna connector on the rear of the VE720.
- 7) Attach the FM Dipole Antenna and position the antenna for the best reception.
- 8) Attach the AM Antenna and position the antenna for the best reception.
- 9) Position the VE720 and mount it in place using the selected screws. **NOTE: Do not over-tighten.**
- 10) Plug the AC power cable into the wall outlet. Route the wires safely away from heat and moisture sources.

COUNTERTOP/DESKTOP INSTALLATION

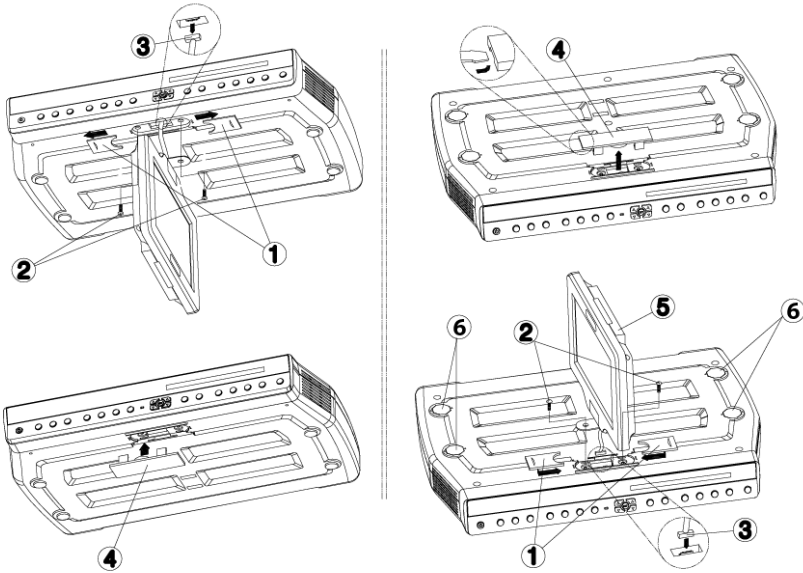

NOTE: Use caution to avoid damaging the LCD screen and the main unit when converting this unit from an under-counter unit to a countertop unit. Leave the protective plastic on the screen until this procedure is completed.

- 1) Place the unit (with the screen facing up) on a soft padded surface.
- 2) Pivot the screen so that it is perpendicular to the front of the unit and then turn it sideways.
- 3) Remove the hinge guide covers (#1) using a flat blade screwdriver inserted into the removal slots. Unscrew the mounting screws (#2). Remove the connector from the unit (#3), be careful not to damage the screen (#5) or wires.
- 4) Turn the unit over and remove the blank cover (#4)
- 5) Connect the plug of the LCD monitor into the connector (#3). **NOTE:** Align the "L" and "R" stamped on the screen-mounting bracket with the "L" and "R" molded into the connector housing.
- 6) Replace the screws and slide the hinge guide covers onto the unit, be careful to not damage the wires. **NOTE:** Do not over-tighten.
- 7) Insert the rubber pieces (#6) (Foot, Mounting Cap - please refer to the illustration above) into the unit. Install the blank cover on the unused port.

FRONT PANEL CONTROLS

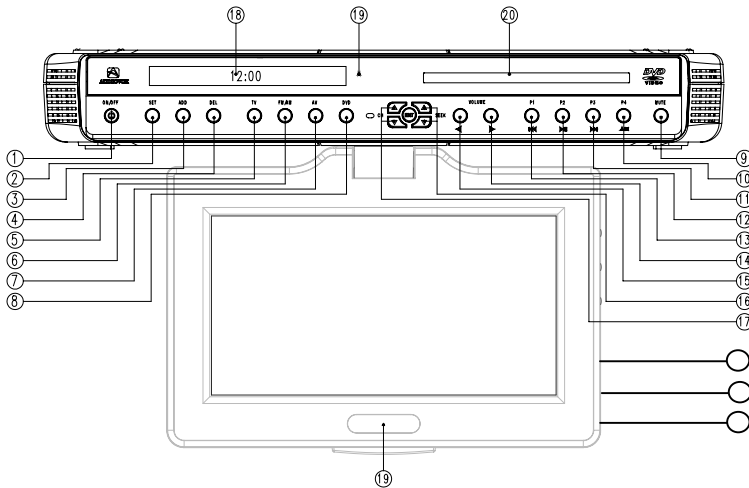

- 1) **ON/OFF BUTTON** – Power ON/OFF.
- 2) **SET BUTTON** – Press this button to set the TIME, ALARM, TV Mode or Speaker Mode.
- 3) **ADD BUTTON** – Press this button to add a selected TV channel.
- 4) **DEL BUTTON** – Press this button to delete a selected TV channel.
- 5) **TV BUTTON** – Press this button to select TV mode, press and hold to change the aspect ratio.
- 6) **FM/AM BUTTON** – Press this button to select FM or AM mode.
- 7) **AV BUTTON** – Press this button to select AV1 or AV2 mode.
- 8) **DVD BUTTON** – Press this button to select DVD mode.
- 9) **MUTE BUTTON** – Press this button to mute the audio (++++) will appear and blink on the display when the system is muted).
- 10) **P4 BUTTON** – Selected Preset Channel “4” in the Radio or TV mode.
Stop and Eject(press and hold) button in DVD play mode.
- 11) **P3 BUTTON** – Selected Preset Channel “3” in the Radio or TV mode.
Next button in DVD play mode.
- 12) **P2 BUTTON** – Selected Preset Channel “2” in the Radio or TV mode.
Play/Pause button in DVD play mode.
- 13) **P1 BUTTON** – Selected Preset Channel “1” in the Radio or TV mode.
Previous button in DVD play mode.
- 14) **VOLUME UP (▶) BUTTON** – Press this button to raise the volume.
- 15) **VOLUME DOWN (◀) BUTTON** – Press this button to lower the volume.

- 16) **SEEK BUTTONS (▼▲-Right Side)** – Press these buttons to go to next available channel with sufficient signal strength.
- 17) **CHANNEL BUTTONS (▼▲-Left Side)** – Press these buttons to go to next available channel.
- 18) **DISPLAY WINDOW** – Displays the channel/station number, time, and selected source.
- 19) **REMOTE INFRARED SENSORS**-These sensors receive infrared command signals from the hand held remote control unit.
- 20) **Contrast Control**- Use this control to adjust the contrast
- 21) **Color Control**- Use this control to adjust the color
- 22) **Brightness Control**- Use this control to adjust the brightness

REAR PANEL CONNECTIONS

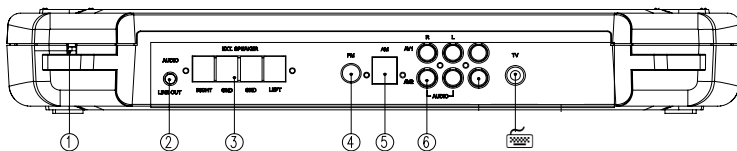

- 1) **AC LINE CORD** – Connects to AC outlet
- 2) **AUDIO LINE OUT** – Connect to low-level input of stereo system or low-level input of computer speaker
- 3) **SPEAKER OUT TERMINAL** – Connect to external speakers (min. 8ohms)
- 4) **FM ANTENNA** – Allows the **VE720** to be connected to a 75-Ohm external antenna for the reception of FM broadcast signals.
- 5) **AM ANTENNA** - Allows the **VE720** to be connected to an external antenna for the reception of AM broadcast signals.
- 6) **A/V (AUDIO/VIDEO) INPUT CONNECTORS** – Connect to A/V OUTPUT of a VCR or Camcorder.
- 7) **TV ANTENNA (75 OHM ANTENNA CONNECTOR)** -Allows the **VE720** to be connected to a 75-ohm external coaxial antenna or cable TV system.

BATTERY INSTALLATION

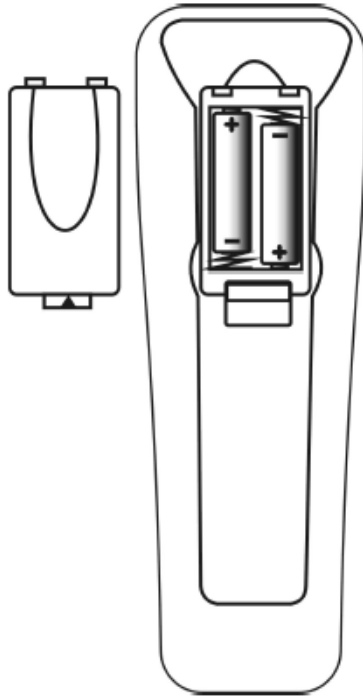

(Rear View, Battery Size AAA)

REMOTE CONTROL FUNCTIONS

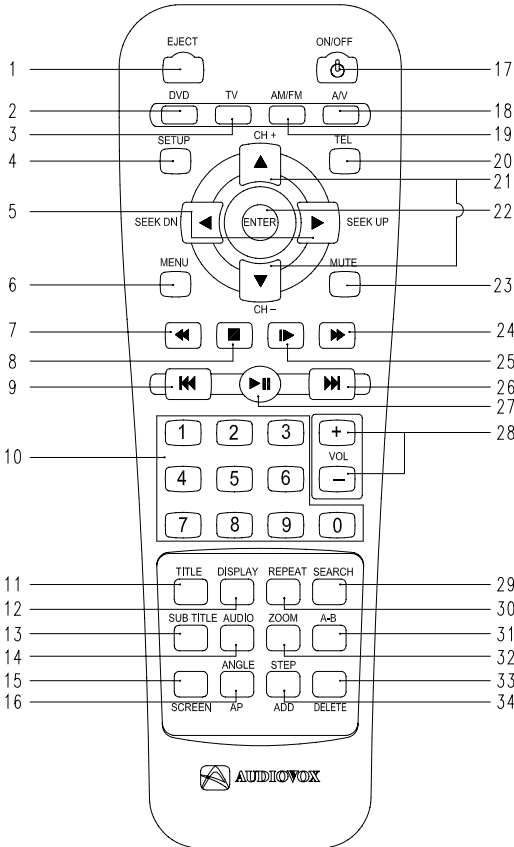

- (1) EJECT
- (2) DVD
- (3) TV
- (4) SETUP
- (5) SEEK DN, SEEKUP
- (6) MENU
- (7) FR(◀◀)
- (8) STOP(■)
- (9) PREV (◀◀)
- (10) Digit 0-9 Select
- (11) TITLE
- (12) DISPLAY
- (13) SUB TITLE
- (14) AUDIO
- (15) SCREEN
- (16) ANGLE (AP)
- (17) ON/OFF
- (18) A/V
- (19) AM/FM
- (20) TEL (Not Used)
- (21) CH+, CH-
- (22) ENTER
- (23) MUTE
- (24) FF (▶▶)
- (25) SF (▶)
- (26) NEXT (▶▶)
- (27) PLAY/PAUSE (▶||)
- (28) VOL +/-
- (29) SEARCH
- (30) REPEAT
- (31) A-B Repeat
- (32) ZOOM
- (33) DELETE
- (34) STEP (ADD)

DVD REMOTE FUNCTION

- (1) **EJECT**: Press this button to Eject and Load the disc tray.
- (2) **DVD**: Press this button to select DVD mode of operation.
- (4) **SETUP**: Displays setup menu for initial user settings.
- (5) **SEEK DN/UP (21) CH+/-**: For selecting item on menu.
- (6) **MENU**: For displaying the menu contained in the disc. (PBC ON/OFF Function - VCD)
- (7) **FR (◀◀)**: Fast reverse (2X, 4X, 8X, and 20X).
- (8) **STOP (■)**: Press this button to stop disc playback
(1 time) Stop at the present playing point / (2 times) Stop playing
- (9) **PREV (I◀◀)**: For skipping to the next or previous chapter or track.
- (10) **Digit 0~9 Select**: For direct selecting a chapter (or tack) and for password input.
- (11) **TITLE**: For displaying the title menu contained in the disc.
- (12) **DISPLAY**: For checking the current disc status.
- (13) **SUBTITLE**: For selecting the subtitle language
- (14) **AUDIO**: For selecting the audio language.
- (15) **SCREEN**: Press this button to change Display Mode. Push the SCREEN Button to enlarge the screen. The screen will be enlarged in the following order:
TV MODE: Normal (default) -> Full
AV, DVD MODE: Full (default) -> Normal
CDDA, MP3: Full (default) -> Normal -> LCD MONITOR OFF
- (16) **ANGLE**: If a DVD disc contains sequences recorded from different camera angles you can change the camera angle for playback.
- (17) **ON/OFF**: Press this button to turn power ON and OFF.
- (22) **ENTER**: Press this button will cause the chapter (or track) change to occur immediately.
- (23) **MUTE**: Press this button to remove all sound (++++ blanks on display window).
- (24) **FF (◀◀)**: Fast Forward (2X, 4X, 8X, and 20X).
- (25) **SF (I▶)**: Slow Play (1/2, 1/4, 1/6, 1/7) speed in forward.
- (26) **NEXT (▶▶I)**: For skipping to the next chapter or track.
- (27) **PLAY/PAUSE (▶II)**: Start disc playback or Pauses disc play.
- (28) **VOL +/-**: Use these buttons to increase or decrease the volume level.
- (29) **SEARCH**: Allows a search to a desired Chapter/Title/Song/etc.
- (30) **REPEAT**: For repeated playback of disc title, chapter/track.
- (31) **A-B**: For specifying and repeating playback of a section of the disc.
- (32) **ZOOM**: For magnifying the screen (1, 2, 3 or OFF).
- (34) **STEP**: Advance one frame each time the button is pressed.

TV REMOTE FUNCTION

- (3) **TV**: Press this button to select TV mode.
- (5) **SEEK DN/UP**: Use these buttons to advance to the next higher or lower station.
- (10) **0~9**: Use these buttons to make a direct channel selection
- (15) **SCREEN**: Press this button to change the Display Mode.
- (16) **AP (Auto Program)**: Press and hold this button for 0.5sec to program and save all active stations in memory.
- (21) **CH+/-**: Use these buttons to advance to the next higher or lower channel.
- (23) **MUTE**: Press this button to remove all sound (++++ blinks on display window)
- (28) **VOL+/-**: Use these buttons to increase or decrease the volume.
- (33) **Delete**: Use to remove selected channel from memory.
- (34) **Step (Add)**: Use to add a selected channel to memory.

RADIO REMOTE FUNCTION

- (5) **SEEK DN/UP**: Use these buttons to advance to the next higher or lower active station.
- (19) **AM/FM**: Each time this button is pressed, the VE720 will alternate between the AM and FM radio bands.
- (21) **CH +/-**: Use these buttons to advance to the next higher or lower channel.
- (23) **MUTE**: Press this button to mute the sound (++++ blinks on display window).
- (28) **VOL +/-**: Use these buttons to increase or decrease the volume.

MISC REMOTE FUNCTION

- (20) **TEL**: Not used in this model
- (18) **AV**: Press this button to select external A/V source 1 or 2.

OPERATION

INITIAL SETUP

This unit defaults to cable TV mode. When the unit is first powered on, it will detect the cable system and auto-program the TV tuner to the available stations. Please wait while the unit auto-programs before attempting to operate the unit. During this time the unit will not respond to any commands. The unit will respond normally once the cable mode and channel search mode is concluded.

CHANNEL TUNING SETUP

If you are Cable TV subscriber, in addition to normal broadcast reception of VHF and UHF channels, your new TV is capable of receiving many unscrambled Cable channels without the use of a converter box. When set to broadcast (AIR) TV, it receives CH2-CH69. When set to one of the CATV modes (STD, HRC, or IRC) it receives CH1-CH125. **NOTE:** *Most cable companies broadcast in STD Mode*

After a power interruption, the unit will go into a cable mode search (HRC, IRC, STD) and channel search mode automatically. During this time the unit will not respond to any commands. The unit will respond normally once the cable mode and channel search mode is concluded.

POSITIONING THE SCREEN

Press the screen lock button and pivot the screen forward until a comfortable viewing angle is reached. The screen may also be rotated from side to side. Do not force the screen beyond its rotational limit. The VE720 is now ready for use.

Pressing the ON/OFF button on the unit or the remote will turn the system on or off. Remember to turn the unit off and pivot the screen to the closed position when not in use to prevent damage to the screen.

SETTING THE TIME

NOTE: *All settings (except setting the presets) are performed with the VE720 turned OFF.*

- 1) Press the SET button and the minutes will flash.
- 2) Use the CH up/down button to set the minutes.
- 3) Press the SEEK button to toggle between the hour and minutes.
- 4) Use the CH up/down button to set the hour. (Check AM/PM indicator)
- 5) Press the ON/OFF button to return to the time display.

SETTING and ACTIVATING the ALARM

NOTE: The VE720 must be turned "OFF" when performing the following procedure.

1) Press the SET button twice to enter the alarm mode, press the P3 button to toggle between the active and deactivated mode.

NOTE: If a series of dashes appear (--: --), the Alarm is DEACTIVATED.

2) Press the CH up/down buttons to set the desired hour/minute. When setting the alarm, check the AM/PM indicator to assure the proper setting.

3) Press the SEEK buttons to toggle between the hours and minutes.

4) Press the ON/OFF button. The alarm is now set and activated. Once the alarm is set it will sound each day at the same time as long as it is activated.

DEACTIVATING ALARM

1) Press the SET button twice to enter the alarm mode.

2) Press the P3 button once. The set time will disappear from the Display Window and a series of dashes (--: --) will appear, Alarm DEACTIVATED mode.

3) Press the ON/OFF button. The alarm is now deactivated.

NOTE: The set time will be stored in memory and can be reactivated whenever desired by performing step 1) – 3) of the ACTIVATING ALARM procedure.

SETTING THE ALARM TONES

1) Press the SET button twice (power off).

2) Press the P4 button once to hear the alarm tone.

NOTE: Alarm must be in the "Activated" mode to hear tones.

3) Each time CH UP/DOWN button(s) is pressed it will select a different alarm tone.

4) Press the ON/OFF button to confirm the selected tone.

5) When the alarm sounds, press the ON/OFF button to turn it off.

SETTING THE ALARM VOLUME

1) Power OFF

2) Press the SET button twice for the Alarm setting mode.

3) To select alarm tone, Press "P4" button and press volume UP/DOWN for your desired volume level. Then, press "SET" button for volume setting

SETTING THE CABLE TV MODE

- 1) Press the SET button three times to enter the TV/Cable configuration mode.
- 2) CABLE or AIR will appear on the display.
- 3) Press the SEEK button to select Cable mode.
- 4) Press the CH UP/DOWN button(s) to select the desired cable mode (STD/IRC/HRC).
- 5) When the desired mode is reached, press the ON/OFF button to confirm.

SETTING THE AIR TV MODE

- 1) Press the SET button three times to enter the TV/Cable configuration mode.
- 2) Press the SEEK button to select the AIR mode.
- 3) Press the ON/OFF button to confirm.

SETTING THE SPEAKER MODE

- 1) With power off, press the SET button four times to enter the speaker configuration mode.
"ISP" (Internal Speaker) or "ESP" (External Speaker) appears on the VFD.
- 2) Press the seek button to toggle between the "I SP" and "E SP"
- 3) When the desired mode is reached, press the ON/OFF button.

SETTING THE PRESETS (IN AM, FM OR TV MODES)

- 1) Tune to the desired channel/station.
- 2) Press the SET button and the display flashes.
- 3) Press desired preset (P1, P2, P3 & P4) to confirm the selection.

NOTE: *you can preset four (4) AM, (4) FM and (4) TV Channels*

USING THE DVD PLAYER

Inserting and Ejecting the Disc

1. Set the unit to DVD mode (press source button until (-----) appears on the display).
2. Insert the disc with the label facing up.
3. The disc will begin playing automatically. If this is a DVD it will go to the DVD root menu. Press the PLAY button to begin watching the movie.
4. To eject the disc, press and hold the  button. The disc will be ejected.
* Discs playable through DVD player – DVD, CD, CD-RW with MP3.





Playback and Stop

1. To temporarily stop playback, press the STOP button once. The player memorizes the exact position where it was stopped, and it will resume playback again from that position. When it is desired to playback from the beginning, press the STOP button twice.
2. To Playback again, Press the PLAY () button.
* For some VCDs, stop mode is possible by pressing the NEXT button.





Searching for a Specific Scene/song by Selecting the Chapter Number

1. Pressing the SEARCH button once will display the Time / Title / Chapter input screen.
2. Input the chapter number or time that is desired and press the ENTER button. The player will commence play from the chapter number or time that that was entered.

Searching for a Specific Scene/song by using Chapters

1. The player will automatically change to the next or previous chapter from the current chapter being played when the PREV () or /NEXT () button is pressed.
2. Pressing PREV () will change the player to the chapter previous to the chapter currently being played.
3. The chapter change status is displayed on the upper part of the screen.
* While playing MP3 discs, PREV () /NEXT () button to select the previous or next song. When the MP3 disc is stopped, Press CH+/- button to select the song.

Searching for a Specific Scene/song by Playback Speed

1. Search by Fast Forward () and Fast Reverse ()
2. Search by Slow Forward ()
3. Search by watching one scene at a time. Press the PLAY/PAUSE () button.
* For normal speed playback, press the PLAY () button.

Repetitive Playback –To Repeat a Specific Section

1. Press the REPEAT button once to enable the REPEAT selection screen, follow by pressing the REPEAT button until REPEAT CHAPTER is displayed, the current chapter or track will be replayed repetitively (CHAPTER REPEAT ON).
2. Repeat step 1 until REPEAT TITLE is displayed on the screen, the currently playing title or CD will be played repetitively (TITLE REPEAT ON).
3. Repeat step 1 until OFF is displayed on the screen, the repeat function will be turned off (REPEAT OFF).

* For MP3 discs, Press the REPEAT button to change the PLAY MODE

Repetitive Playback –To Repeat a Specific Section (A-B Repeat)

1. Choose the section to be repeated by pressing the A-B button once (SET A).
2. Press the A-B button again to choose the end of the section. (SET B)
3. Press the button until OFF is displayed on the screen this will turn off the repeat function. (A TO B OFF)

Changing the Subtitle Language

1. If the disc contains caption data, press the SUBTITLE button to choose a specific language. (e.g., 1/3 ENG, 2/3 SPA, 3/3 FRE will be displayed on the screen)
2. SUBTITLE OFF shows that there are no subtitles.

* This function may not be incorporated in some disc titles

Changing the Vocal Language (AUDIO)

1. If the disc contains different audio tracks, press the AUDIO button to choose between the various spoken languages (e.g., 1/4 5.1ch ENG, 2/4 2ch ENG, 3/4 2ch ENG, 3/4 2ch ENG).

* This function may not be incorporated in some disc titles

ZOOM (To Enlarge a Picture)

1. Pressing the ZOOM button allows the picture to be enlarged by X1, X2 or X3.
2. Navigation buttons (Seek DN/Seek UP/ Ch UP/Ch DN) allow the enlarged picture to be shifted.
3. To resume normal settings, press the ZOOM button again until ZOOM is OFF.

Viewing Different Angles

Angle indicator appears on the upper part of the LCD display. When the Angle indicator appears, press the ANGLE button to view the screen from various angles.

* This function may not be incorporated in some titles.

Viewing the Main Disc Menu

A DVD is divided into sections called titles and chapters. When you play a DVD, a root menu of the disc will appear on the screen of your Monitor. Contents of the menu will vary depending on the disc content. Press MENU during playback to display the main menu. Some DVDs only allow you to select disc playback options using the DVD root menu

1. The root menu of a disc appears when pressing the MENU button.
2. Use the navigation buttons to select the desired item on the menu and press ENTER button
 - * Use the TITLE button instead of the MENU button, depending on the type of disc being played

Viewing the Playback Time, Title and Chapter Status

1. Pressing the DISPLAY button will allow the user to see the title, chapter number, and the elapsed time of the currently playing disc on the upper part of the screen, show the remaining time of the current title, show the elapsed time of the current chapter, show the remaining time of the current chapter.
2. Pressing the button once again will turn the display OFF.

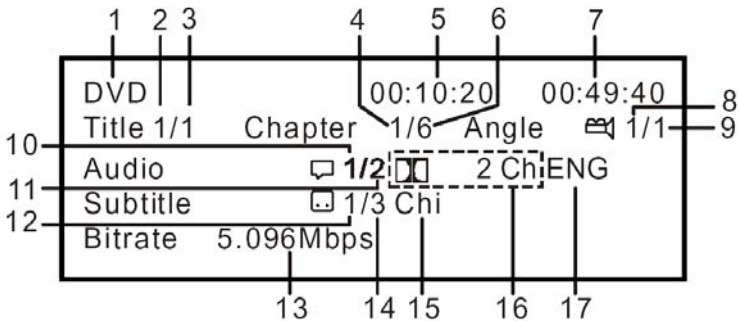

During playback press DISPLAY to display the current disc playback information. Press display again to remove the display.

1. The type of disc.
2. The number of current title.
3. The number of total titles.
4. The number of current chapter.
5. The elapsed time of title.
6. The number of total chapters.
7. The remaining time of title.
8. The number of the current angle.
9. The number of total angles.
10. The number of the current audio language.
11. The number of total audio languages.
12. The number of current subtitle language.
13. The speed at which the disc is being read.
14. The number of total subtitle languages.
15. Current subtitle language.
16. Dolby audio mode.
17. Current audio language selected.

PLAYING AUDIO CDS

When playing an audio CD the display will automatically display the disc playback information. The options below show you what information is displayed. Press the 'DISPLAY' button to remove the display.

1. The current track.
2. The number of total tracks.
3. Playing time of the disc.
4. Remaining time of the disc.

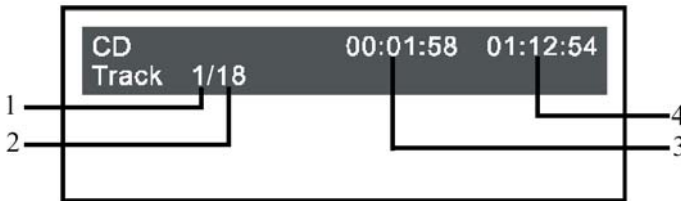

USING THE REPEAT FEATURE

The default mode for the Repeat feature is OFF. Pressing REPEAT consecutively changes the repeat options:

- Repeat Single- repeats the track that is playing.
- Repeat All- repeats the disc that is playing.
- Off

As you toggle through the options, the repeat option changes. The selected repeat option loops repeatedly until its turned off.

PLAYING MP3 DISCS

MP3 is a digital audio format. An audio CD-quality song is compressed into the MP3 format with no significant loss of audio quality. CD-R/RW discs that have been encoded in MP3 format are compatible with this device.

Insert an MP3 Disc, the DVD player will initialize the disc and the directory (folder) will be shown on the monitor screen.

When an MP3 disc is inserted into the unit, the menu screen appears automatically. You can use the menu screen to change folders and songs. The system plays the songs in the order they were recorded onto the disc.

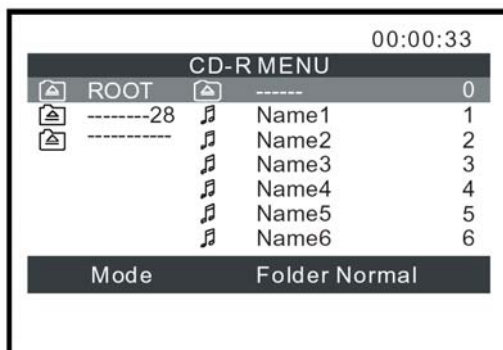

1. Press the ***** or **□** button to choose a folder from the folder list on the left side of the screen.
2. Press ENTER to select the highlighted folder. All songs available under the selected folder will be listed.
3. Use ***** or **□** button to choose a song from the list, then press ENTER to play the selected song.
4. To move back up to the previous folder use the ***** button to highlight the **█** at the top of the screen, make sure that the disc is paused and press ENTER.

Use the NEXT (**▶▶|**) button to move to the next song. Press the PREVIOUS (**|◀◀**) button to move to the previous song.

USING THE REPEAT FEATURE

The default mode for the Repeat feature is OFF. Pressing REPEAT consecutively changes the repeat options:

- Repeat Single (repeat playback of a song)
- Repeat All (repeat playback of all folder)
- Off (normal playback)

Pressing REPEAT a 3rd time will resume normal playback. As you toggle through the options, the repeat option changes. Selected repeat option loops repeatedly until you turn it off.

NOTICE

- **[Folder Icon]** sign in front of a file name indicates that this is a folder, not a MP3 file.
- **[Song Icon]** sign in front of a file name indicates that this is a MP3 file.

NOTE: During MP3 playback, you cannot access "PLAY MODE", folders or songs.

PLAYING A JPEG FILE

1. Insert the JPEG Disc into tray.
2. Select JPEG file by pressing the “UP/DOWN” button.
3. You can preview the JPEG file by pressing “Play” or “ENTER”.
4. Pressing the left or right button will rotate the JPEG in that direction.
5. When browsing the photos, you can reverse the photo horizontally by pressing the “Up” button, or you can reverse the photos vertically by pressing the “Down” button.
6. You can return the root Menu by pressing “MENU” key.

SETUP

The setup menu allows the user to select the play mode settings. Follow the basic steps below for each setup menu selection.

The following options are available when in SETUP mode.

OSD Menu: Use to select DVD Setup Menu Language (ENGLISH - Default).

Subtitle: Select a language for subtitles (disc dependent).

ENGLISH (Default), FRENCH, SPANISH, CHINESE.

OFF: No subtitles are displayed.

Audio: Select a language for audio (where available – language depend on disc).

ENGLISH (Default), FRENCH, SPANISH, CHINESE.

DVD Menu: (where available – language depend on disc).

ENGLISH (Default), FRENCH, SPANISH, CHINESE

LANGUAGE Menu

1. Press the SETUP button to display the main menu. The following Menu will appear.



2. Press ENTER, the following screen will appear.



3. Use the ***** or **□** buttons to highlight the desired menu item.
4. Press ENTER button to display the sub-menu.
5. Each sub-menu item provides a number of option items to its right. Use the ***** or **□** buttons to highlight the desired option item for selection.



6. Press the ENTER button to select the option item.
7. Press the ***** or **□** button to highlight the next sub-menu item for setup and repeat steps 3 and 6.
8. Press the SETUP button to exit the SETUP mode.

VIDEO Menu

1. Press the SETUP button to display the main menu (see sample screen under LANGUAGE Menu)
2. Press the  button to highlight **Video** and press ENTER one time. Use the following screen to select screen aspect ratio.

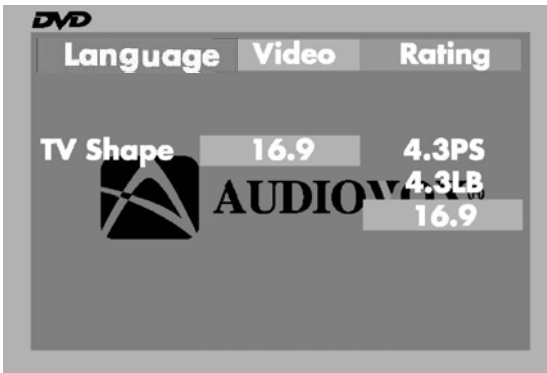

- * **4:3 PS** : When the player is connected to a normal TV, and a wide picture is shown on the full screen.
- * **4:3 LB** : When the player is connected to a normal TV, and a wide picture is shown on the screen with a black strip at both the top and bottom of the screen.
- * **16:9** : When the player is connected to a wide screen TV, a wide picture is shown on the full screen(Default).

Rating Menu

Press the SETUP button to display the main menu (see sample screen under LANGUAGE Menu).

Use to select parental Rating:

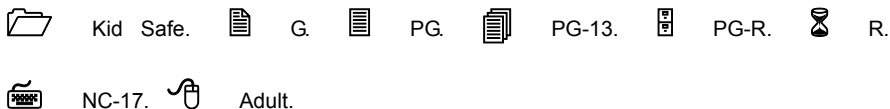

CHANGE PASSWORD & RATING

1. Select Rating by \square or \times buttons and press ENTER to enter the Rating setup page
2. Enter the current password and press ENTER button (unlock).
3. Select Rating by \square button and press ENTER button to enter the sub-menu.
4. Select the rating level you desire by repeatedly pressing the ENTER button.
5. Select password by \star button and input either the default password or any new 4-digit password and press ENTER button (locked).
6. Press SETUP button.

NOTE: The Default Password is 3308. This password is always effective even after you have selected your own password and changed it. To avoid the possibility of others using the default password to set the parental level and change the password, you can record this default password in another area and delete it from this manual. Some discs can be limited depending on the age of users while some discs cannot.

Load Factory

To restore all of the options to the default settings select 'LOAD FACTORY' using the \star or \square buttons and press ENTER. This will return all of the settings except for parental to the default

settings.

TECHNICAL SPECIFICATIONS

GENERAL

Power Supply_____ : AC100-240V ~50/60Hz 40watts
Operating Temperature_____ : 0°~40°C / 32°~104°F
Operating Humidity_____ : 10% ~ 75%
Body Size_____ : 400 X 280 X 56mm / 15.8" x 11.0" x 2.20" Inches
Weight_____ : 3.4 Kg / 7.50Lbs

DISPLAY

LCD Illumination_____ : CCFL Edge Lit Tube
Backlighting Life Expectancy_____ : 30,000Hrs
Resolution_____ : 1440(W) X 234(H)
Screen_____ : TFT LCD (16:9)

DISC AVAILABLE

DVD_____ : Linear Velocity - 3.49m/sec, Maximum
– Playback Time – 135minute
CD_____ : Linear Velocity 1.2~1.4m/sec, Maximum Playback
Time – 74minute CD-R/CD-RW

MISC

TV Channels_____ : VHF/UHF (2-69), CABLE TV (STD,IRC,HRC) 1 - 125
TV Channels_____ : NTSC
Radio Frequency Range_____ : AM 530KHz – 1710KHz, FM 87.5MHz – 107.9MHz
Audio output_____ : 1.2W / 8ohm (2 Speakers)

TROUBLESHOOTING CHECK LIST

Problem	Solution
Power does not turn on	<ul style="list-style-type: none"> • Check if the power cord is securely plugged into the wall • Check if the batteries of the remote control unit are not depleted.
Disc fails to play	<ul style="list-style-type: none"> • Check if the disc is inserted properly into tray (Label Side Up). • Check if the disc has viewing restriction selected. • Check if the disc is the proper region code. • Not all discs are playable in the DVD. • Check with the beginning part of the manual on whether the disc is playable.
Camera angles cannot be changed	<ul style="list-style-type: none"> • The disc being played does not support ANGLE functions. • In order to check whether the disc supports the ANGLE functions, see if the ANGLE indicator on the upper part of the main display is illuminated.
Subtitles cannot be changed	<ul style="list-style-type: none"> • The disc being played does not support subtitle functions. • The disc is prohibited from changing subtitle languages.
Vocal languages (AUDIO) cannot be changed	<ul style="list-style-type: none"> • The disc being played does not support AUDIO functions. • The disc is prohibited from changing vocal languages (AUDIO).
No sound output	<ul style="list-style-type: none"> • Check whether the player is in slow or fast playback mode (if it is case, then just press PLAY button for normal playback) • Check whether the MUTE function is on. • If the internal speakers are being used, make sure they are turned on and volume is turned up.
Remote control doesn't work	<ul style="list-style-type: none"> • Remote too far from the unit. • Batteries in the remote control are dead. • Angle of remote to unit too extreme.
Setup menu does not operate	<ul style="list-style-type: none"> • DVD must have a setup menu; if the disc does not have a setup you will not be able to display a menu.
TV MODE functions don't work	<ul style="list-style-type: none"> • Confirm Antenna is connected. • Confirm Air/Cable setting is correct. • Confirm that unit is in TV mode.



90 DAY LIMITED WARRANTY

Applies to Audiovox Video Products

AUDIOVOX ELECTRONICS CORP. (the Company) warrants to the original retail purchaser of this product that should this product or any part thereof, under normal use and conditions, be proven defective in material or workmanship within 90 days from the date of original purchase, such defect(s) will be repaired or replaced with reconditioned product (at the Company's option) without charge for parts and repair labor.

To obtain repair or replacement within the terms of this Warranty, the product is to be delivered with proof of warranty coverage (e.g. dated bill of sale), specification of defect(s), transportation prepaid, to the Company at the address shown below.

This Warranty does not extend to the elimination of externally generated static or noise, to correction of antenna problems, to costs incurred for installation, removal or reinstallation of the product, or to damage to tapes, discs, speakers, accessories, or electrical systems.

This Warranty does not apply to any product or part thereof which, in the opinion of the Company, has suffered or been damaged through alteration, improper installation, mishandling, misuse, neglect, accident, or by removal or defacement of the factory serial number/bar code label(s). THE EXTENT OF THE COMPANY'S LIABILITY UNDER THIS WARRANTY IS LIMITED TO THE REPAIR OR REPLACEMENT PROVIDED ABOVE AND, IN NO EVENT, SHALL THE COMPANY'S LIABILITY EXCEED THE PURCHASE PRICE PAID BY PURCHASER FOR THE PRODUCT.

This Warranty is in lieu of all other express warranties or liabilities. ANY IMPLIED WARRANTIES, INCLUDING ANY IMPLIED WARRANTY OF MERCHANTABILITY, SHALL BE LIMITED TO THE DURATION OF THIS WRITTEN WARRANTY. ANY ACTION FOR BREACH OF ANY WARRANTY HEREUNDER INCLUDING ANY IMPLIED WARRANTY OF MERCHANTABILITY MUST BE BROUGHT WITHIN A PERIOD OF 30 MONTHS FROM DATE OF ORIGINAL PURCHASE. IN NO CASE SHALL THE COMPANY BE LIABLE FOR ANY CONSEQUENTIAL OR INCIDENTAL DAMAGES FOR BREACH OF THIS OR ANY OTHER WARRANTY, EXPRESS OR IMPLIED, WHATSOEVER. No person or representative is authorized to assume for the Company any liability other than expressed herein in connection with the sale of this product.

Some states do not allow limitations on how long an implied warranty lasts or the exclusion or limitation of incidental or consequential damage so the above limitations or exclusions may not apply to you. This Warranty gives you specific legal rights and you may also have other rights which vary from state to state.

U.S.A. : AUDIOVOX ELECTRONICS CORPORATION, 150 MARCUS BLVD., HAUPPAUGE, NEW YORK 11788 • 1-800-645-4994

CANADA : CALL 1-800-645-4994 FOR LOCATION OF WARRANTY STATION SERVING YOUR AREA

128-5556C



For Customer Service
Visit Our Website At
www.audiovox.com
Product Information, Photos,
FAQ's, Owner's Manuals

Free Manuals Download Website

<http://myh66.com>

<http://usermanuals.us>

<http://www.somanuals.com>

<http://www.4manuals.cc>

<http://www.manual-lib.com>

<http://www.404manual.com>

<http://www.luxmanual.com>

<http://aubethermostatmanual.com>

Golf course search by state

<http://golfingnear.com>

Email search by domain

<http://emailbydomain.com>

Auto manuals search

<http://auto.somanuals.com>

TV manuals search

<http://tv.somanuals.com>