

Audix

TVD6040

COMBINED 21" TV AND DVD PLAYER

OWNER'S MANUAL



Please read this manual carefully before using this TV set and keep it for future reference.

CONTENTS

| | |
|---|----|
| Basic operation | 2 |
| Warning and cautions | 2 |
| Installation | 3 |
| Aerial connection | 3 |
| Preparation of the remotecontrol | 3 |
| Function buttons and external sockets | 4 |
| Front panel of the TV set | 4 |
| Rear panel of the TV set | 4 |
| Using the remote control | 5 |
| Basic operation | 6 |
| Switching on/off the TV set | 6 |
| Watching TV | 7 |
| Watching TV program | 7 |
| Program swap and auto scan functions | 8 |
| Searching channel | 9 |
| Full automatic mode | 9 |
| Semi-automatic search | 10 |
| Manual fine tune | 11 |
| Program skip | 12 |
| Convenient picture and sound control functions | 13 |
| Multiple picture modes | 13 |
| Black stretch and noise reduce | 14 |
| Mute , Select the language and Fade function | 15 |
| Time functions | 16 |
| Clock setting and timer on/off functions | 16 |
| Sleep timer and program preset | 17 |
| Setup function | 18 |
| Screen saver and childlock functions | 18 |
| AVL and calendar functions | 19 |
| Position exchange function | 20 |
| Teletext | 21 |
| DVD Operation | 23 |
| Basic Playback | 23 |
| Advanced Playback | 24 |
| Special Function Playback | 25 |
| DVD System Setup | 27 |
| Playable Discs | 31 |
| Disc Protection and DVD Characteristics | 32 |
| Others | 33 |
| Connection to the external audio and video equipment | 33 |
| Troubleshooting guide | 34 |
| Specifications | 35 |

Warning and cautions

1. When you clean the TV set, please pull out the power plug from AC outlet. Don't clean the cabinet and the screen with benzene, petrol and other chemicals.



4. Do not place the TV set near rain or moisture as it may cause an electric shock, or the TV set to catch fire. The TV set must only be used in dry in door locations.

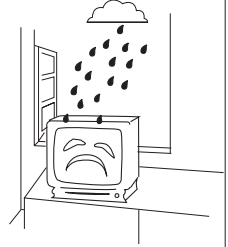

2. In order to prolong the live of the product, please use in a well ventilated location.

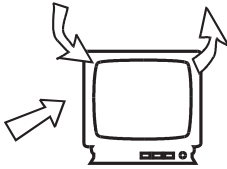

5. The back cover must only be removed by a registered electrical service person. Removing the back cover may result in electric shock, fire or damage to the TV set.

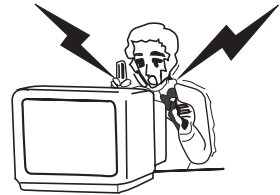

3. Don't place the TV set in direct sunlight or near a heat source.

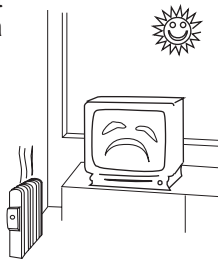

6. If the TV set is not going to be used for a long time, or there is a severe thunder & Lighting storm, it is recommended that the TV set be disconnected from the AC power outlet and the aerial plug removed.

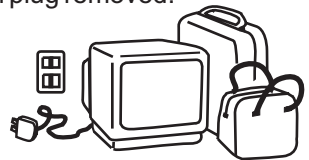

Cleaning the tube

If the picture tube require cleaning, disconnect the power and use a dry soft cotton cloth. Do not use any cleaner or abrasive cloths.

Installation

Aerial Connection

If the picture is not clear or snowy, we recommend that you use an outdoor aerial. In different places, the suitable antenna type and position are different.

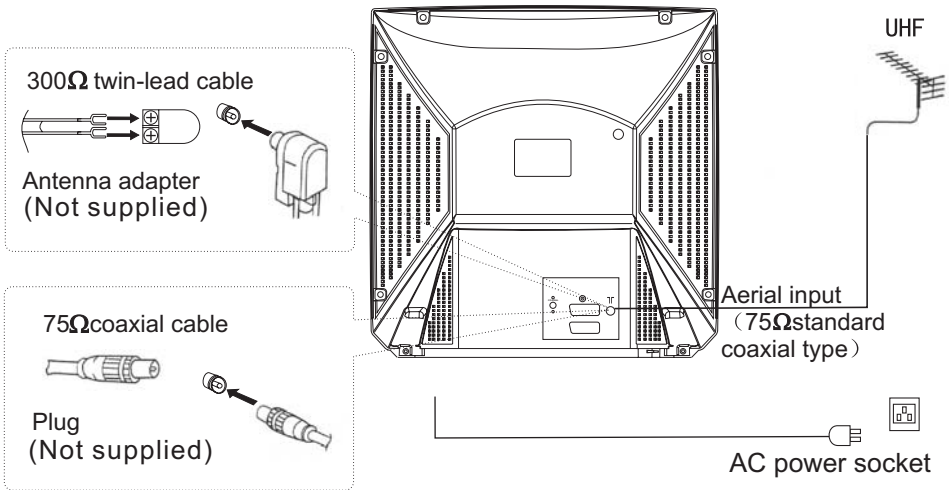

Note:

- * It is recommended that a 75 ohm coaxial antenna is used to avoid interference.
- * To avoid interference from electrical signals, do not bind the antenna cable together with any mains lead.

Preparation for the remote control

Battery installation

Remove the battery cover.

Insert two size AAA batteries matching the +/- polarities of the battery to the +/- marks inside the battery compartment.

Tips for remote operation

When the remote control will not be used for a long period of time or when the batteries are worn out, remove the batteries to prevent leakage.

Do not throw the batteries into fire. Dispose of used batteries in the specified manner.

Do not drop, dampen or disassemble the remote control.

Function Buttons and External Sockets

Front panel the TV set

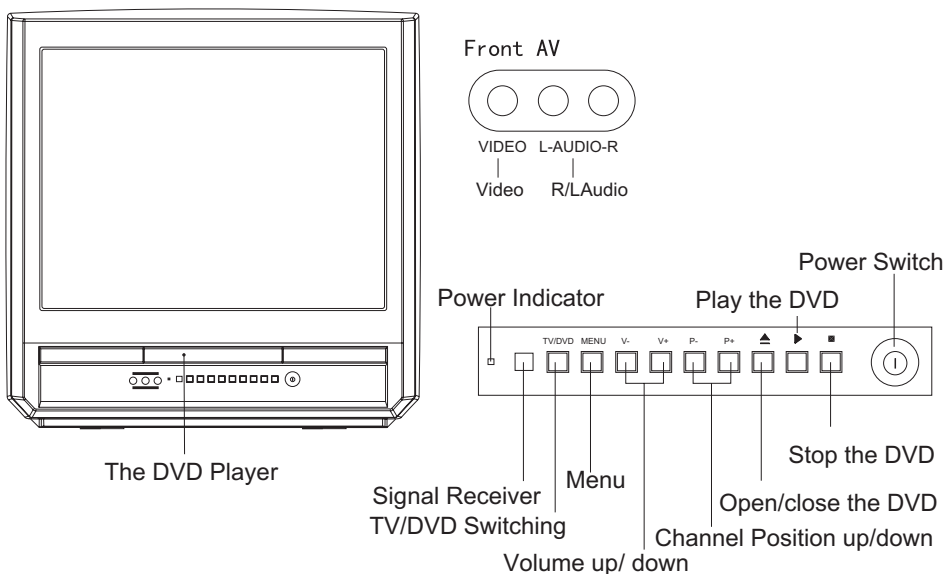

Rear panel of the TV set

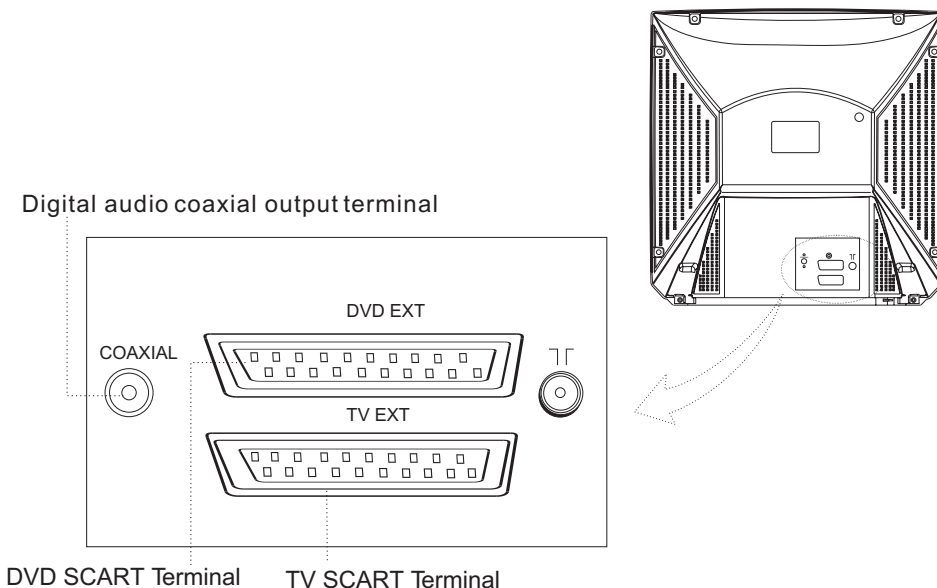

Using the Remote Control

Buttons on the remote control

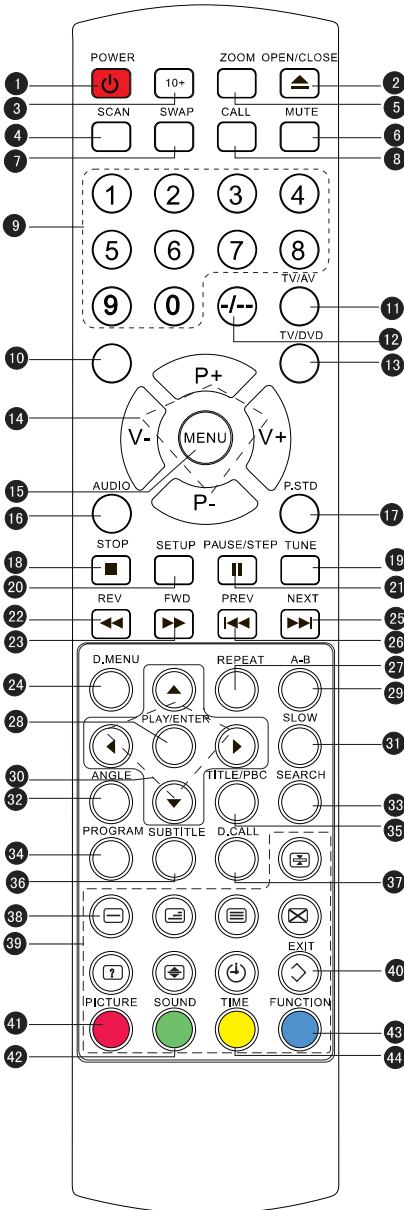

- 1 Stand By
- 2 DVD Open/close
- 3 DVD 10+
- 4 Scan
- 5 Zoom
- 6 Mute
- 7 Former Program
- 8 Call Screen Display
- 9 Program Number
- 10 (No available)
- 11 TV/AV Exchange
- 12 Digital Selector
- 13 TV/DVD
- 14 Volume/Channel Selection
- 15 MENU
- 16 DVD Audio
- 17 Picture Mode
- 18 DVD STOP
- 19 Tune Menu Button
- 20 DVD SETUP
- 21 DVD PAUSE/STEP
- 22 DVD FAST REVERSE
- 23 DVD FAST FORWARD
- 24 DVD MENU
- 25 DVD NEXT
- 26 DVD PREVIOUS
- 27 DVD REPEAT
- 28 DVD PLAY/ENTER
- 29 DVD A-B REPEAT
- 30 DVD Cursor Move button
- 31 DVD SLOW
- 32 DVD ANGLE
- 33 DVD SEARCH
- 34 DVD PROGRAM
- 35 DVD TITLE
- 36 DVD SUBTITLE
- 37 DVD CALL
- 38 (No available)
- 39 TELETEXT BUTTONS
- 40 Exit Screen Display
- 41 PICTURE MENU BUTTON (Red)
- 42 Green Button
- 43 FUNCTION MENU BUTTON (Blue)
- 44 TIME MENU BUTTON (Yellow)

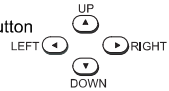

Switching on/ off the TV set

- This section explains the use of the power button and remote handset to turn your unit on and off.

Switching on/ off the TV set

Switching on/ off the TV set

1 Please press the power switch to switch on AC power supply and the power indicator will light.

2 If the indicator is lighting in red, press the button  on the remote control again.

Note:

1 When you don't operate the TV set with a remote control, you can turn on it directly through pressing the channel buttons on the TV set (Child Lock must be turned off).

4
AUTO
BG

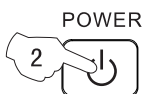

2 If you want to exchange to standby status, please press down the button  on the remote control.

3 If you want to fully switch off the power supply for the TV set, please press the power switch button on the TV set.

Auto switch-off function

If transmissions are finished for the day, the Automatic Power Off feature will put the TV to standby automatically. The Automatic Power Off feature will not operate in AV mode or when the background is set to off (see page 18).

Watching TV

- You can watch TV program in a preset channel.

Watching TV program

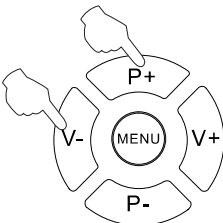
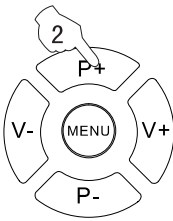
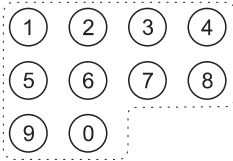

How to select TV program

Select the desired program

1 Using "Program number" buttons

- Directly enter the channel number with the numeric keypad on the remote control.
- To select channel numbers from 10 ~ 99 press [-/--] button and enter the two digit channel number
- To select channel numbers from 100 ~ 218 press [-/--] button twice and enter the 3 digit channel number

2 Using the P+/- buttons

- Press the P+ button to increase channel number.
- Press the P- button to decrease channel number.

Select the desired sound

Press the V-/+ buttons on the remote or the front of the TV set to adjust the volume level. The range is 0~100. When the volume buttons are pressed the volume level is displayed automatically on the TV screen.

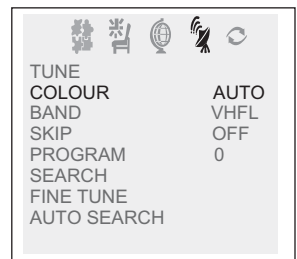

- If picture colour is abnormal
Use the P+/- buttons to select Colour then the V-/+ buttons to change between Auto, PAL, NTSC and NTSC443. Press the EXIT button to save the setting.

Watching TV (continued)

- Swap function enables quick swap to the last watched program.
- Auto scan function enables automatic successive scanning of all the programs in memory with "OFF" skip status (each channel will last about 2 seconds).

Program swap and auto scan functions

Program swap

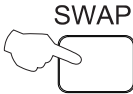

1 Suppose the channel number you used just now is 8 and the channel number you are using is 18 (as shown in the figure).

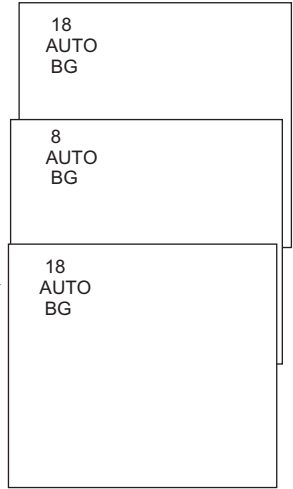

2 If you want to return to the last watched program channel 8, you can simply press the SWAP button.

3 If you want to return to channel 18, press the button again. Through this function, you can easily change between the channel you are using and the channel you used last time.

Auto program scan



1 Press the SCAN button to scan through all the memorized TV channels. The scan will pause for about 2 seconds on each channel.

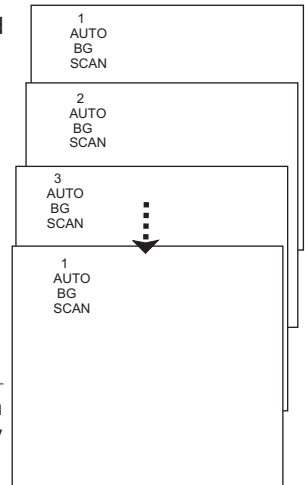

2 If you want to stop the function during auto scanning, simply press the SCAN button again.

Searching channel

(Continued)

Program skip

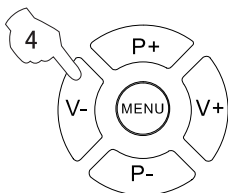
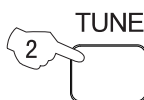
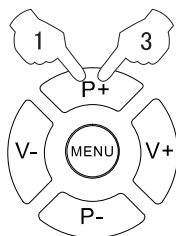

Program skip

Channels can be set so that they are skipped during program selection.

1 Press the P+/- buttons or PROGRAM NUMBER (0-9) button to choose desired channels (I.E. channel 1) .

1
AUTO
BG

2 Press the TUNE button, the TUNE menu shown on the right display on the screen.

| | |
|-------------|------|
| TUNE | AUTO |
| COLOUR | VHFL |
| BAND | OFF |
| SKIP | 0 |
| PROGRAM | |
| SEARCH | |
| FINE TUNE | |
| AUTO SEARCH | |

3 Press the P+/- buttons to select "SKIP".

4 Press the V-/+ buttons to turn the SKIP function "ON".

| | |
|-------------|------|
| TUNE | AUTO |
| COLOUR | VHFL |
| BAND | ON |
| SKIP | 0 |
| PROGRAM | |
| SEARCH | |
| FINE TUNE | |
| AUTO SEARCH | |

5 Press the TUNE button to close the menu. When you use the P+/- buttons to select channel, this channel will be skipped. However, you can still use the PROGRAM NUMBER buttons to select the skipped channel numbers.

If you want to recover the skipped channel

- 1 Use the PROGRAM NUMBER buttons to select the channel number to be recovered.
- 2 Repeat those steps just now.
- 3 Press the V-/+ buttons to turn the SKIP function "OFF".

Convenient picture and sound control functions

Multiple picture modes



How to select picture modes

You can quickly select the desired picture mode from four preset modes and one customized mode.

Press the P.STD button to select the desired picture quality. Five kinds of picture modes (i.e., "STANDARD", "RICH", "USER", "LISTEN", "SOFT") can be selected in turn.

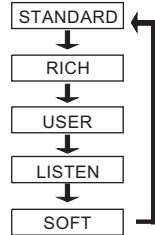

The 5 modes are

- Listen-This is a new feature that blacks out the TV screen when listening to music only channels;
- Soft-Designed for night time low light viewing;
- Standard -Designed for rooms that have good all round lighting;
- Rich-Designed for rooms with high ambient lighting such as daytime sport;
- User-A spare setting that can be adjusted to personal tastes.

PICTURE

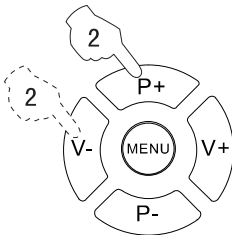

How to customize your own picture status

1 Press the PICTURE button, the PICTURE menu shown on the right display on the screen.

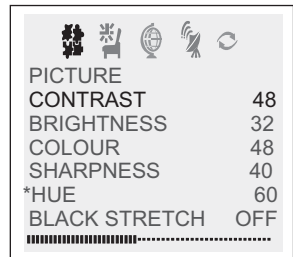

2 Press the P+/- buttons to select the item to adjusted, then press the V+/- buttons to obtain the desired effect.

| ITEM | Press V - | Press V + |
|------------|----------------|---------------|
| CONTRAST | Weak | Strong |
| BRIGHTNESS | Dark | Bright |
| COLOUR | Shallow | Deep |
| SHARPNESS | Soft | Sharp |
| *Hue | lean to purple | lean to green |

Note:

The "Hue" item only appears when the colour system is NTSC.

Convenient picture and sound control functions

(Continued)

- Black Stretch Automatically increases the contrast range
- Noise Reduce Picture Noise & Grain Reduction Circuit. (Use only on poor reception)

Black stretch and noise reduce

PICTURE

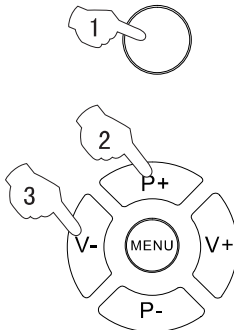

How to select BLACK STRETCH

1 Press the PICTURE button, the PICTURE menu shown on the right display on the screen.

| | |
|---------------|-----|
| | |
| PICTURE | |
| CONTRAST | 48 |
| BRIGHTNESS | 32 |
| COLOUR | 48 |
| SHARPNESS | 40 |
| *HUE | 60 |
| BLACK STRETCH | OFF |
| | |

2 Press the P+/- buttons to select "BLACK STRETCH".

| | |
|---------------|----|
| | |
| PICTURE | |
| CONTRAST | 48 |
| BRIGHTNESS | 32 |
| COLOUR | 48 |
| SHARPNESS | 40 |
| *HUE | 60 |
| BLACK STRETCH | ON |
| | |

3 Press the V-/+ buttons to turn the BLACK STRETCH function "ON" or "OFF".

FUNCTION

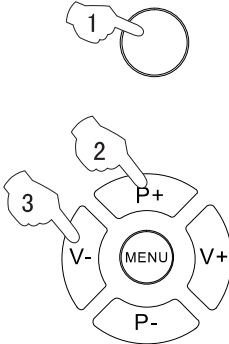

1 Press the FUNCTION button, the FUNCTION menu shown on the right display on the screen.

| | |
|--------------|-----|
| | |
| FUNCTION | |
| ENGLISH | |
| BACKGROUND | ON |
| NOISE REDUCE | ON |
| FADE | ON |
| CHILD LOCK | OFF |
| AVL | ON |
| CALENDAR | |

2 Press the P+/- buttons to select "NOISE REDUCE".

| | |
|--------------|-----|
| | |
| FUNCTION | |
| ENGLISH | |
| BACKGROUND | ON |
| NOISE REDUCE | ON |
| FADE | ON |
| CHILD LOCK | OFF |
| AVL | ON |
| CALENDAR | |

3 Press the V-/+ buttons to turn the NOISE REDUCE function "ON" or "OFF".

Convenient picture and sound control functions

(Continued)

Mute, Select Language and Fade function



Sound mute

1 Press the MUTE button on the remote control to turn off the sound. MUTE will appear on the top left of the display.

MUTE

2 Press MUTE again to turn the sound back on.



How to select Language

1 Press the FUNCTION menu button, till the FUNCTION menu shown on the right display on the screen.



| | |
|--------------|-----|
| FUNCTION | |
| ENGLISH | |
| BACKGROUND | ON |
| NOISE REDUCE | OFF |
| FADE | ON |
| CHILD LOCK | OFF |
| AVL | ON |
| CALENDAR | |

2 Press the P+/- button to select " ENGLISH ".

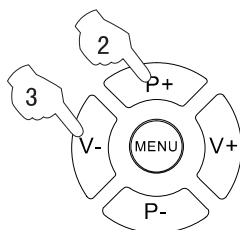

3 Press the V-/+ buttons to select the OSD language.

FADE FUNCTION

Using on/off fade function, the TV turn on or turn off mild.



1 Press the FUNCTION button, the FUNCTION menu shown on the right display on the screen.



| | |
|--------------|-----|
| FUNCTION | |
| ENGLISH | |
| BACKGROUND | ON |
| NOISE REDUCE | OFF |
| FADE | ON |
| CHILD LOCK | OFF |
| AVL | ON |
| CALENDAR | |

2 Press the P+/- button to select FADE.

3 Press V-/V+ buttons to turn the FADE function ON or OFF.

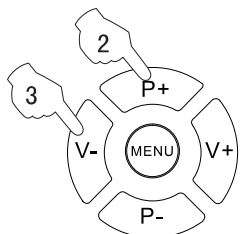

Time functions

Clock setting and timer on/off functions

Clock setting

The clock will only work if the TV set is left turned on or in standby. When the set is disconnected from the power supply or is turned off by the main power on the front panel, the clock loses power and will need to be reset when the power is reconnected.

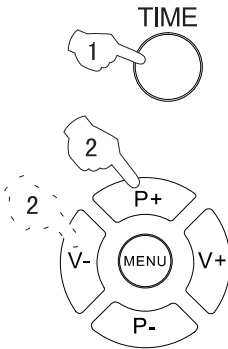

1 Press the TIME button, and the TIME menu display on the screen.

| | | | | |
|------|-------------|-------|--|--|
| | | | | |
| TIME | CLOCK | 17:18 | | |
| | ON TIME | 18:00 | | |
| | ON PROG | 1 | | |
| | OFF TIME | --:-- | | |
| | SLEEP TIMER | 0 | | |
| | REMIN TIME | --:-- | | |
| | REMIN PROG | 1 | | |

2 Press the P+/- buttons select "CLOCK", then press the V-/+ buttons to adjust the time in hour position; press again the P+/- buttons to select the time in minute position, then press the V-/+ buttons to adjust the value of minutes.

On/off timer

Using on/off timer function, the TV set can automatically turn on to a preset program or shut down in a preset time.

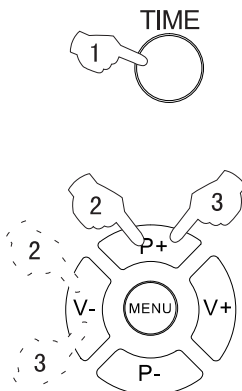

1 Press the TIME button to call up the TIME menu on the screen.

| | | | | |
|------|-------------|-------|--|--|
| | | | | |
| TIME | CLOCK | 17:18 | | |
| | ON TIME | 18:00 | | |
| | ON PROG | 1 | | |
| | OFF TIME | --:-- | | |
| | SLEEP TIMER | 0 | | |
| | REMIN TIME | --:-- | | |
| | REMIN PROG | 1 | | |

2 Press the P+/- buttons to select "ON TIME", then press the V-/+ buttons to set the value in hour position; press again the P+/- buttons to select the minute position and set the value of the minute. (take 18:00 as an example)

3 Press the P+/- buttons to select "ON PROG", then press the V-/+ or program direct number buttons to select your desired channel (take 8 as an example).

| | | | | |
|------|-------------|-------|--|--|
| | | | | |
| TIME | CLOCK | 17:18 | | |
| | ON TIME | 18:00 | | |
| | ON PROG | 8 | | |
| | OFF TIME | 23:00 | | |
| | SLEEP TIMER | 0 | | |
| | REMIN TIME | --:-- | | |
| | REMIN PROG | 1 | | |

4 Repeat step 1-2 to set OFF TIME. (take 23:00 as an example)

Time functions (Continued)

Sleep timer and program preset

Sleep timer

The TV set have 18 sections option for sleep timer function (each section has a time interval of 10 minutes) (See right chart):

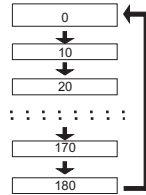

1 Press the TIME button, and the TIME menu display on the screen.

2 Press the P+/- buttons to select "SLEEP TIMER".

3 press the V -/+ buttons to set the value of the SLEEP TIMER.

| | | |
|-------------|--|-------|
| | | |
| TIME | | |
| CLOCK | | 17:18 |
| ON TIME | | 18:00 |
| ON PROG | | 8 |
| OFF TIME | | 23:00 |
| SLEEP TIMER | | 120 |
| REMIN TIME | | --- |
| REMIN PROG | | 1 |

REMIND PROG function

Program remind timer, that displays an on-screen reminder prompt, when a program on a different channel is due to start.

1 Press the TIME button to call up the TIME menu on the screen.

2 Press the P+/- buttons to select "REMIND TIME", then press the V-/+ buttons to set the value in hour position; press again the P+/- buttons to select the minute position, and then set the value of the minute.(take 19:00 as an example)

3.Press the P+/- buttons to select "REMIND PROG", then press the V -/+ buttons or the program direct number buttons to set the desired channel (take 18 as an example).

| | | |
|-------------|--|-------|
| | | |
| TIME | | |
| CLOCK | | 17:18 |
| ON TIME | | 18:00 |
| ON PROG | | 8 |
| OFF TIME | | 23:00 |
| SLEEP TIMER | | 120 |
| REMIN TIME | | 19:00 |
| REMIN PROG | | 1 |

| | | |
|-------------|--|-------|
| | | |
| TIME | | |
| CLOCK | | 17:18 |
| ON TIME | | 18:00 |
| ON PROG | | 8 |
| OFF TIME | | 23:00 |
| SLEEP TIMER | | 120 |
| REMIN TIME | | 19:00 |
| REMIN PROG | | 18 |

NOTE: For REMIND PROG to operate CHILD LOCK must be turned off.

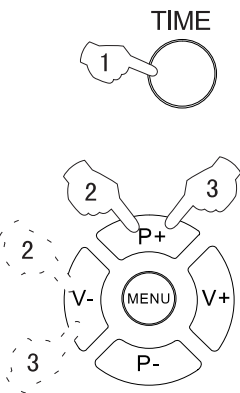
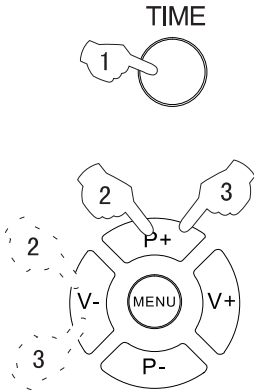

Set up function

Screen saver and childlock functions

How to start screen saver function

When the background function is ON, a bouncing 'NO SIGNAL' will be displayed on a blue background.

NO SIGNAL

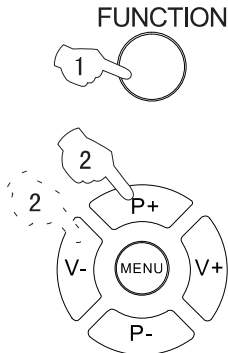

1 Press the FUNCTION button, the FUNCTION menu shown on the right display on the screen.

2 Press the P+/- buttons to select "BACKGROUND" and press the V-/+ buttons to turn the BACKGROUND function "ON".

| | | | | | | | |
|----------|---------|------------|--------------|------|------------|-----|----------|
| | | | | | | | |
| FUNCTION | ENGLISH | BACKGROUND | NOISE REDUCE | FADE | CHILD LOCK | AVL | CALENDAR |
| | | ON | ON | ON | OFF | OFF | ON |

Child lock function

Enables the TV front control buttons to be locked.

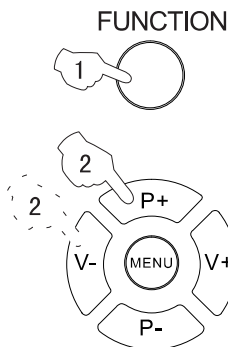

1 Press the FUNCTION button, the FUNCTION menu shown on the right display on the screen.

2 Press the P+/- buttons to select "CHILD LOCK" and press the V-/+ buttons to turn the CHILD LOCK function "ON".

| | | | | | | | |
|----------|---------|------------|--------------|------|------------|-----|----------|
| | | | | | | | |
| FUNCTION | ENGLISH | BACKGROUND | NOISE REDUCE | FADE | CHILD LOCK | AVL | CALENDAR |
| | | ON | ON | ON | ON | ON | ON |

NOTE:

All the control panel buttons on the front of the TV are disabled when CHILD LOCK is turned on. The power switch will still turn the TV set off.

Set up function

(Continued)

AVL and calendar functions

FUNCTION

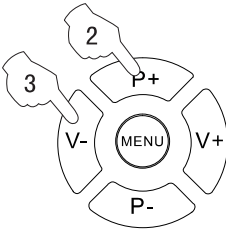

AVL function

Automatic Volume Limit Control reduces the effect of large volume changes. For instance, when advertisements come on.

1 Press the FUNCTION button, the FUNCTION menu shown on the right display on the screen.



2 Press the P+/- buttons to select "AVL" .

3 Press V-/+ buttons to turn the AVL function "ON" or "OFF:"



FUNCTION

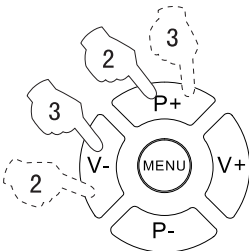

Calendar function

Enables the TV sets internal calendar to be set.

1 Press the FUNCTION button, the FUNCTION menu shown on the right display on the screen.

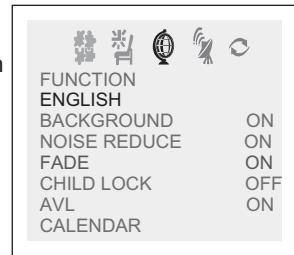

2 Press the P+/- buttons to select "CALENDAR" , then press the V-/+ buttons to the CALENDAR display on the screen.

3 Press the P+/- buttons to turn the YEAR/MONTH/DAY, press V-/+ buttons to set or adjust the YEAR/MONTH/DAY.



Position exchange function

Exchange

Exchange

This feature enables TV programs that may be on a wrong TV channel number to be swapped/exchanged. This feature is very useful when Automatic Search Tuning has been used, to reallocate the found programs to the correct channel numbers.

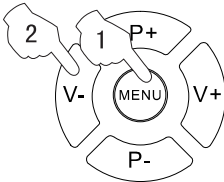

1 Press the MENU button , till the EXCHANGE menu display on the screen.

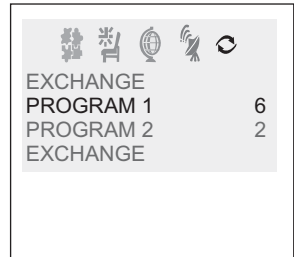

2 Press the V-/V+ buttons or the PROGRAM NUMBER (0-9) buttons to set PROGRAM 1 TO 6.

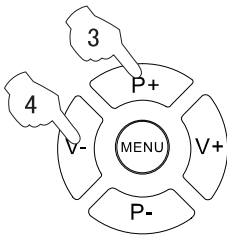

3 Press the P+/- buttons to select "PROGRAM 2".

4 Press the V-/V+ buttons or the PROGRAM NUMBER (0-9) buttons to set PROGRAM 2 TO 9.

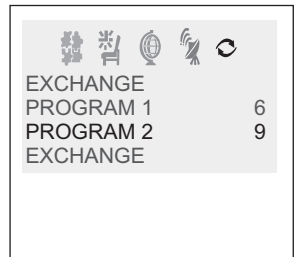

5 Press the P+/- buttons to select "EXCHANGE".

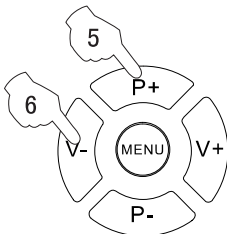

6 Press the V-/V+ buttons to set "EXCHANGE".

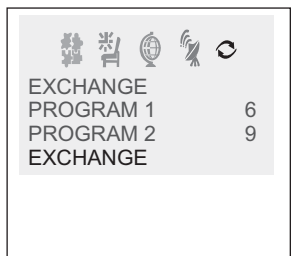

Teletext

- Teletext is an information system, broadcast by certain channels, which can be read like a newspaper . It also provides subtitles for people with hearing difficulties or those who are unfamiliar with the language in which a particular program is being broadcast (cable networks, satellite channels, etc.).

Teletext

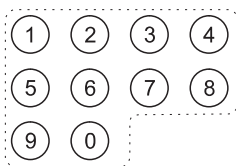
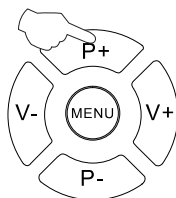

Teletext functions

To select "Teletext" press the Teletext button on the handset. To switch off Teletext, press the button again. "Note all menu functions are not available in Teletext mode". Only a few direct button control functions are available in TELETEXT mode, they are:

- Volume adjustment, but without OSD display.
- Mute function, but without OSD display.

Page up/down

Use the P+/- buttons to browse next or previous page.

Page number entering

To select a Teletext page, enter the page number using the numeric key pad on the remote control, or use the P+ or P- buttons, or the coloured Fast text buttons.

Mix mode

To view the TV picture while in Text mode press the  button, this will superimpose the Teletext data on top of the Tv picture. Press this button again to return to Full text.

INDEX

Press the tune button to go to the index page of teletext.

Teletext

(Continued)

Teletext

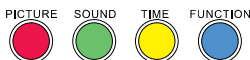

Cancel mode

This feature allows the TV picture to be displayed while next page to be searched is entered and found. Only the top teletext line is displayed until the page is found. Press the button to hide the teletext information. Either press the  button or the Text button to exit the cancel display mode.

Language change

Pressing the  button will change the Teletext characters between Eastern and Western.

Hold

Pressing the  button will stop the teletext page automatically updating. This feature is very useful where there are several teletext pages or data on the same page number.

Size

Pressing the  button changes between full screen top half bottom half full screen. This feature is very useful as it magnifies the image making the characters easier to read.

Reveal

Pressing the  button will reveal hidden text. This feature is used to reveal information such as answers to Teletext on-line interactive puzzles.

Subcode / Time

By entering its 4-digit number to enter a secondary page; While in normal TV mode only, pressing the button  will display the teletext time in the top right hand corner for a few seconds.

Switch teletext on/off

Press the  button on the remote control to turn teletext On/Off.

Fast text coloured buttons

Fast text automatically displays the four most commonly used pages that the broadcaster thinks that you may want to choose next. Press the same coloured button on the remote control as the coloured link at the bottom of the teletext page to go directly to that page.

Basic Playback

Basic Playback

Preparations

- Press the TV/DVD button on the remote control or the TV to enter the DVD status.

Basic playback

1. Press OPEN/CLOSE to open the disc tray, place a disc on the disc tray.
There are two different disc sizes. Place the disc in the correct guide on the disc tray. If the disc is out of the guide, it may damage the disc and cause the DVD player to malfunction.
 - Do not place a disc which is unplayable in this DVD player.
2. Press OPEN/CLOSE to close the disc tray, the playback will automatically start.
 - Some discs do not start automatically. Press PLAY/ENTER to start playback.
3. Some discs may start playback with a menu. Use the cursor buttons on the remote control to select menu options and press PLAY/ENTER to start. You may also press the digit buttons to select a menu option directly. Many DVDs will not allow this during start-up.

Pause playback

1. Press PAUSE/STEP to pause playback (still mode).
The sound will be muted during still mode.
2. Press PLAY/ENTER to resume normal playback.

Stop playback

1. Press STOP ■ button to stop the disc playing. With some discs the player will memorize the stop position, such as DVD's and audio CD's.
2. Press PLAY/ENTER to playback to resume playback from the location where playback is stopped or from the beginning of the disc.
3. Press STOP twice to stop completely.

Previous and Next

During Playing, pressing the PREVI◀◀ key will restart the current chapter and skip chapters backwards with each subsequent press until the start of the disc is reached.
Each press of NEXT ▶▶ key during playing will skip the current chapter and play the next one.

Fast forward and Fast reverse

1. Press FWD ▶▶ to fast forward through the disc.
Each time the FWD ▶▶ button is pressed, the fast forward motion speed changes.
2. Press PLAY/ENTER to resume normal playback.
3. Press REV ◀◀ to fast reverse through the disc.
Each time the REV ◀◀ button is pressed, the fast reverse motion speed changes.
4. Press PLAY/ENTER to resume normal playback.

Single step playback

To "single step" press the "Pause" button, then press "Pause/Step" in continuous steps to view the next frame.

Advanced Playback

Advanced Playback

IMPORTANT NOTE:

ALL DESCRIBING FUNCTION IS FOR DVD DISCS. IF YOU PLAY OTHER FORMAT DISC, THE OPERATION AND DISPLAY ON SCREEN WILL BE SOME DIFFERENCE.

CAPTION

Press "CAPTION", the screen will display "SUBTITLE 01/XX XXXXX", "01" indicates the ordinal number of this language; "XX" indicates total number of language; "XXXXXX" indicates the language of country. (the number of language depends on disc). This function can select up to 32 languages displayed on screen.

REPEAT

Press "REPEAT" and Chapter repeat will be displayed on screen, the second press will display Title repeat, the third press will display All repeat, the fourth press will cancel this function.

A-B

Press "A-B" to begin start-point, press again to set an end point and complete setting. The selected section A-B will be repeated. The third press will cancel this function.

ANGLE

When enjoying sports, concert or theatre, press this key to watch same actions in different angles. (Valid for discs possessing this function. Using a disc recorded in multi-angle you can view the scene from different angles, for example, front, side, whole view and exterior scene).

D.MENU

Press this key to display root menu, select item according to your preference. (This function will work with a DVD having a multi-layer menu.)

D.CALL

Pressing this key will cycle through "title elapsed", "title remain", "chapter elapsed", "chapter remain" and "display off".

PROGRAM

When playing discs, press "PROGRAM" to enter program mode. Press the digit buttons to select the program number that you want. When finished move the cursor to select "START". This will start the program playback.

SEARCH

Press "SEARCH" once to display the search menu. Press the button again to select. And then press the digit (0-9) buttons to select the number. Press PLAY/ENTER to confirm.

SLOW

Press SLOW to play a disc in slow forward. Each time the SLOW button is pressed, the slow motion speed changes. Press PLAY/ENTER to resume normal playback;

Note: This function is invalid for CD and MP3.

TITLE/PBC

With some DVD discs pressing this key will display the title menu. You can then use the digit buttons to select the item you prefer.

AUDIO

Press this key can change the mode of audio. such as: Audio 1/2: AC 3 2 CH English
Audio 2/2: AC 3 5.1 CH English
Press this button to cycle between Mono Left, Mono Right, Mix-Mono and Stereo.

Note: When press this button continuously, you must above 3 seconds interval.

Special Function Playback

JPEG DISC PLAYBACK

When a disc containing standard JPEG picture files is inserted into the player, a navigation menu will be displayed automatically. Use the UP and DOWN cursor buttons to select a file then press PLAY/ENTER. The slide show will commence. Press PREVIOUS or NEXT to move between pictures. Press pause to stop on the current picture. Press PLAY/ENTER to resume normal playing.

JPEG disc contains with JPG-format picture information which can be decoded by micro-computer software and output through video output interface for enjoying on TV screen. Such function can be used in many domains. For example, in education, teachers can change those pictures for class into JPG-format file by digital camera or scanner, which is commonly used in computer, and record them into CD-R disc through disc recorder. It will be convenient for and direct to the students when teachers play the disc by TV set or other equipment in class. That reduces teachers' repetition work and good for reservation (information in disc can be reserved for more than 100 years); in family, users can record pictures which formed by digital camera or scanner into CD-R disc. Suppose one picture occupies about 100K bytes, then one disc may record about 6000 pictures; in commerce, manufacturers can show the products pictures one by one to consumers.

NOTE: The actual content will be different as per disc.

MP3 PLAYBACK

When playing an MP3 disc, a navigation menu will be displayed automatically. In the menu, use UP or DOWN cursor buttons to choose the folder, then press PLAY/ENTER to enter the folder. Use the UP and DOWN cursor buttons to select the file and press PLAY/ENTER. Pressing the LEFT cursor button will take you to the previous screen/menu.

SCREEN SAVER FUNCTION

This unit employs a screen saver mode to help protect the tube during static video pictures. This can be turned off on the GENERAL SETUP PAGE (see Pg. 28)

Special Function Playback(Continued)

Kodak Picture CD

A Kodak Picture CD has the size and shape of a regular CD. You can order a Kodak Picture CD simply by checking the box on the photofinishing envelope when you drop off a roll of film (35 mm or Advanced Photo System (APS) color print film) at the time of processing in Kodak Express store displaying "Kodak Picture CD" sign. When your order is returned, you receive your prints, negatives, and your full roll of pictures safely stored on your Kodak Picture CD. Each Kodak Picture CD brings you the tools to enhance, share and manage your pictures on your computer.

Playback

When a Kodak Picture CD is inserted in the player an automatic slide show is launched. Each picture in the Kodak Picture CD will be displayed consecutively in a slide-show fashion and will be scaled to fit in the whole TV screen.

To display an image indefinitely, press the "PAUSE" key.

To resume the slideshow, press the "PLAY/ENTER" key.

To view the next or previous picture, press "NEXT" or "PREV" key.

After all the slide have played the screen displays the folder and file view of the folder containing the photographs. You can select a photo with the up and down DVD cursor buttons then press PLAY / ENTER resume the slide show from that point.

DVD System Setup

DVD System Setup

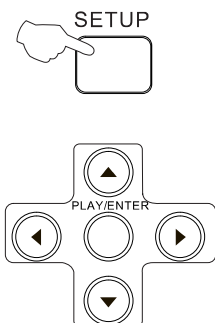

General Setup Process

1. Press the SETUP button, the General Setup Page, Preference Page will be displayed in turn.

2. Press ▲ or ▼ to select, the item, then press ► to enter the submenu.

3. Press ▲ or ▼ to select then press PLAY/ENTER to confirm.

4. Press EXIT key or press SETUP repeatedly to exit the set-up menus.

```
..General Setup Page..
TV Display  LB  4: 3:Ps
Angle Mark  On  4: 3:Lb
OSD Lang    ENG 16: 9
Spdif Output
Caption     On
```

```
..Preference Page..
TV Type  Auto  PAL
Parental          AUTO
Password          NTSC
Default
```

General Setup Page

ASPECT RATIO DESCRIPTION

When using the DVD with the internal TV, select 4: 3/LB.

The following information applies only when the DVD output is connected to an external TV.

●4: 3/PS (PS = Pan and Scan)

You may select if you have a normal aspect ratio (4:3) TV, although the NORMAL/LB (letter box) is a more common choice. In PS

mode, widescreen material will fill the screen, but at the expense of chopping off extreme left and right edges of the original film picture. For this feature to work, the disc must be specially coded. Such discs are uncommon.

●4: 3/LB (LB = Letter Box)

You may select this if you have a normal aspect ratio (4:3) TV. Widescreen material will be shown in pure unaltered form, allowing the entire picture area of the original film to be viewed without any side cropping. Black bars will appear above and below the picture.

●16: 9

You may select this if you have a widescreen (16:9) TV. Black bars may still appear above and below the picture even if using a widescreen TV. This is because some film directors prefer to use ultra widescreen aspect ratios e.g. 2.35:1. This will normally be indicated on the DVD packaging.

```
..General Setup Page..
TV Display  LB  4: 3:Ps
Angle Mark  On  4: 3:Lb
OSD Lang    ENG 16: 9
Spdif Output
Caption     On
Screen Saver Off
```

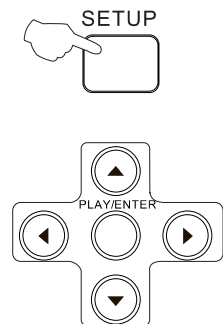

DVD System Setup(Continued)

DVD System Setup

General Setup Page

ANGLE MARK: Users can select a particular camera angle when playing a DVD which offers multiple angles.

This item allows you to set Angle Mark ON or OFF.

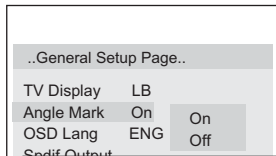

On Screen Display (OSD) Language: Users can select on-screen display language.

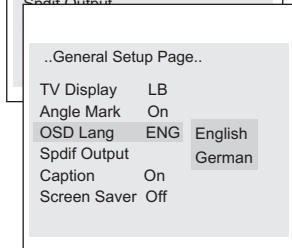

SPDIF OUTPUT MODE: Sets the audio outputs.

This DVD player includes three kinds of audio output:

1. **SPDIF OFF:** An analog surround sound format is output through the back-panel connections for 2-CH audio out or 5.1 CH audio out.
2. **SPDIF/RAW or SPDIF/PCM:** This surround sound format is output to a Dolby Digital/DTS decoder through the coaxial connector on the back panel of the product.

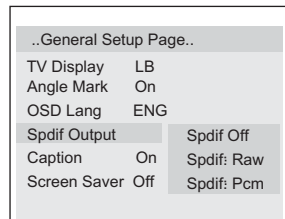

CAPTIONS: This function allows you to display or hide the caption.

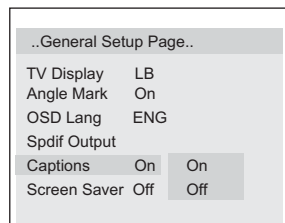

SCREEN SAVER: If the screen saver is on, then there will be an animated picture of DVD on the screen whenever the DVD player is idle for more than 3 minutes.

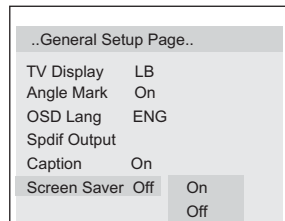

DVD System Setup(Continued)

DVD System Setup

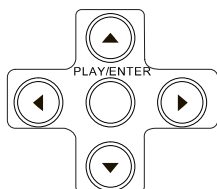

Preference Page

The Preference Page is only available when there is no disc in the player. These settings are applied consistently to all discs which are inserted and played.

TV TYPE: This player supports different TV output, including MULTI(Auto), NTSC, and PAL systems. Usually please set to MULTI.

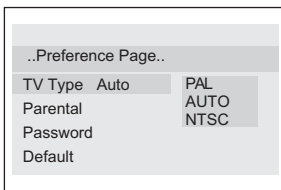

PARENTAL: The parental control function works in conjunction with the different censorship classes assigned to DVDs. These classes help to control the types of DVDs that the family watches, There are up to 8 censorship classes for DVDs.

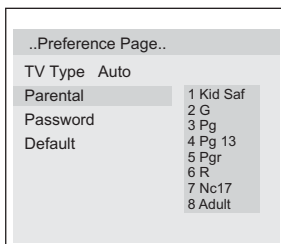

Note:

- 1 To change this setting you must enter your password. (Initial password is 1234)
- 2 When set to OFF, all discs may be viewed.

PASSWORD CHANGE:

You can change your password by entering 4 digits. You must confirm the 4 digits before the new password can be accepted.

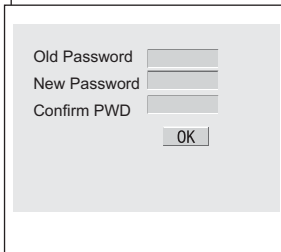
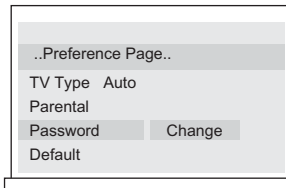

NOTE: If you forget your password or a password is accidentally set enter 1369 as the password. This will enable you to regain control.

DVD System Setup(Continued)

DVD System Setup

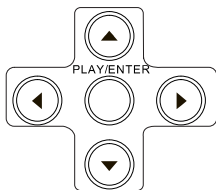

DEFAULT: Resets all settings (except password and parental lock status) for this DVD player back to the manufacturers original settings. Press ENTER to perform the reset.

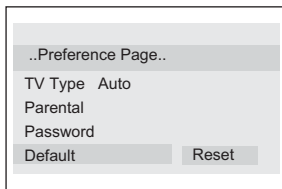









Note:

Some functions may not be available depending on the type of disc.

Playable Discs

The following discs can be played:

| DISCS | LABEL | CONTENTS | DIMENSION |
|-----------|--|------------------------------------|-----------|
| DVD VIDEO |  | Audio +Video (moving picture) | 12cm |
| | | | 8cm |
| AUDIO CD |  | Audio | 12cm |
| | | | 8cm |
| HDCD |  | Audio | 12cm |
| | | | 8cm |
| MP3 |  | Audio | 12cm |
| | | | 8cm |
| JPEG |  | Video(picture) | 12cm |
| | | | 8cm |
| KODAK CD |  | Video(picture) | 12cm |
| | | | 8cm |
| CD-R |  | Audio or Video (moving picture) | 12cm |
| | | | 8cm |
| CD-RW |  | Audio or Video (moving picture) | 12cm |
| | | | 8cm |
| CD+G |  | Audio(picture) | 12cm |
| | | | 8cm |

- You cannot play discs other than those listed above.
- You cannot play discs of non-standardized discs, even if they may be labelled as above.
- The performance of CD-R or CD-RW disc is depend on the way of disc-burning. In a few cases, their performance may be not very well or even no performance.

Disc Protection and DVD Characteristics

ON HANDLING DISCS

- Do not touch the playback side of the disc.
- Do not attach paper or tape to disc.

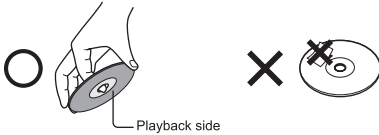

ON CLEANING DISCS

- Fingerprints and dust on the disc cause picture and sound deterioration. Wipe the disc from the centre outwards with a soft cloth. Always keep the disc clean.



- If you can not wipe off the dust with a soft cloth, wipe the disc lightly with a slightly moistened soft cloth and finish with a dry cloth.
- Do not use any type of solvent such as thinner, benzene, commercially available cleaners or anti-static spray for vinyl Lps. It may damage the disc.

ON STORING DISCS

- Do not store discs in a place subject to direct sunlight or near heat source.
- Do not store discs in place subject to moisture and dust such as a bathroom or near a humidifier.
- Store discs vertically in a case. Stacking or placing object on discs outside of their case may cause warping.

STRUCTURE OF DISC CONTENTS

Normally, DVD discs are divided into titles, and the titles are sub-divided into chapters. Audio CD are divided into tracks.

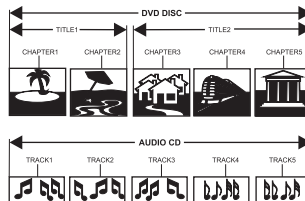

Each title, chapter, or track is assigned a number, which is called title number, chapter number or track number respectively.

There may be discs that do not have these number.

Compare DVD disc with other discs:

| | DVD | | | | LD | SVCD | VCD | CD |
|-----------------------|-------------------------------|-------------------------------|-------------------------------|------------------------------|-----------------------|-----------------------|-----------------------|----------------|
| Encode method | Digital/MPEG II | | | | Analog | Digital | Digital/MPEG I | Digital |
| Capacity | Single-side single-layer 4.7G | Double-side single-layer 8.5G | Single-side double-layer 9.4G | Double-side double-layer 17G | / | 650MB | 650MB | 650MB |
| Playing Time | 133 minutes | 242 minutes | 266 minutes | 484 minutes | | 45 minutes | 74 minutes | 74 minutes |
| Disc diameter | 12cm/8cm | | | | 30cm/20cm | 12cm | 12cm | 12cm/8cm |
| Horizontal resolution | More than 500 line | | | | No more than 430 line | No more than 350 line | No more than 250 line | / |
| Picture proportion | Multiple kinds | | | | One kind | One kind | One kind | |
| Subtitle | 32 kinds | | | | 16 kinds at most | 4 kinds | / | / |
| Language | 8 kinds | | | | 4 kinds at most | 4 kinds at most | | |
| Sound quality | 48KHz, 96KHz/ 6, 20, 24bit | | | | 44.1KHz/ 16bit | 44.1KHz/ 16bit | 44.1KHz/ 16bit | 44.1KHz/ 16bit |

Connecting the TV set to the other video and audio equipment

Connecting to the other video and audio equipment

- You can attach optional equipment such as another TV or other audio amplification equipment to the scart/digital coaxial sockets at the rear of the set to enjoy higher quality sound and picture.

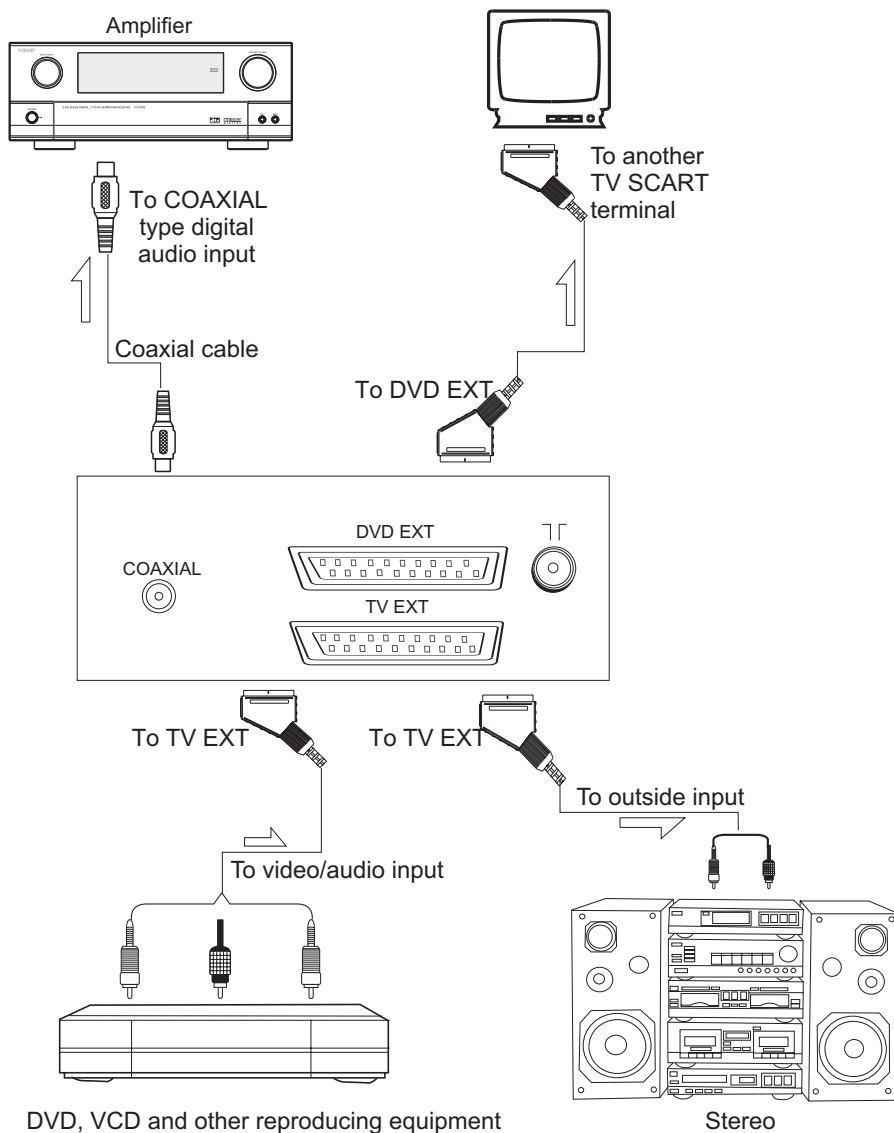

















DVD, VCD and other reproducing equipment

Stereo

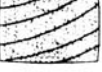
Troubleshooting guide

- To assist in location possible faults use help guide below.

| BREAKDOWN PHENOMENON | | CHECKING |
|---|--|--|
| PICTURE | SOUND | |
|  <p>Picture with snow</p> |  <p>Noise</p> | The aerial direction and connection |
|  <p>Double or Triple Image</p> |  <p>Normal</p> | This is called ghosting which can be minimized with an outside aerial, and good quality cable and terminations. Altering the aerial direction can also minimize this effect. |
|  <p>Disturb</p> |  <p>Noise</p> | Electrical interference which can be caused by cars, motorbikes etc, Fluorescent lamps and dirty insulators on overhead power cables. |
|  <p>Normal</p> |  <p>No sound</p> | Volume Sound mute |
|  <p>No Picture</p> |  <p>No sound</p> | Ensure that the power supply is connected to the TV set and turned on. Also ensure that the TV set is not in "Listen Mode" or that the brightness and contrast are not turned down. |
|  <p>No colour</p> |  <p>Normal volume</p> | Adjust colour control |
|  <p>Scramble</p> |  <p>Normal or Weak Volume</p> | Adjust channel again |
|  <p>Colour Spot</p> |  <p>Normal volume</p> | Colour Purity fault which can be caused by moving the TV set, placing magnets near the TV screen or turning on/off household appliances such as vacuum cleaners near the TV set. Turn the TV off with the mains power switch for 15 minutes. When the power is turned on again the TV set will automatically degauss the picture. In severe cases leave the TV set turned off overnight. |

Note:

1. If the fault can not be repaired using the above guide consult with your local authorized service center.
2. The TV set must only be repaired by a qualified registered service person. Never attempt to remove the back cover as the TV set has dangerous voltages inside that may cause a fatality or fire.
3. The cabinet may produce the occasional "snapping sound" This is normal and caused by the materials in the cabinet expanding with room temperature changes.

Specifications

- The specifications offered you here are only for reference and, with the improvement of the products ,there may be some different between the description and the practicality.

Specifications

| Model | TVD6040 |
|--------------------|---|
| Colour system | PAL, NTSC PLAYBACK |
| Sound system | BG |
| Picture tube | 21"colour picture tube (51cm viewable) |
| Sound output power | 2X2W (10% THD) |
| Power requirements | AC 230V~ 50Hz |
| Power consumption | ≤ 80W |
| Dimension | 504 (Width) x482 (Depth) x512 (Height) (mm) |
| Accessories | Remote control X1 Owner's manual X1 Battery(AAA) X2 |



If at any time in the future you should need to dispose of this product please note that Waste electrical products should not be disposed of with household waste. Please recycle where facilities exist. Check with your Local Authority or retailer for recycling advice.(Waste Electrical and Electronic Equipment Directive)

NOTE

Design and specifications are subject to change without notice.
Dimensions quoted in this manual are approximate.

Audix

Free Manuals Download Website

<http://myh66.com>

<http://usermanuals.us>

<http://www.somanuals.com>

<http://www.4manuals.cc>

<http://www.manual-lib.com>

<http://www.404manual.com>

<http://www.luxmanual.com>

<http://aubethermostatmanual.com>

Golf course search by state

<http://golfingnear.com>

Email search by domain

<http://emailbydomain.com>

Auto manuals search

<http://auto.somanuals.com>

TV manuals search

<http://tv.somanuals.com>