

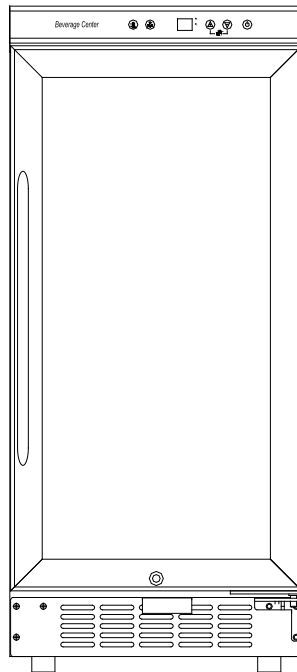

**BUILT-IN BEVERAGE CENTER / REFRIGERADOR EMPOTRABLE  
INSTRUCTION MANUAL  
MANUAL DE INSTRUCCIONES**

**Model Number / No. de Modelo: BCA1501SS**



**( Picture may vary )**

**BEFORE USE, PLEASE READ AND FOLLOW ALL SAFETY RULES AND OPERATING INSTRUCTIONS.**

La sección en español empieza en la página 15.

Avanti Products has a policy of continuous improvement on its products and reserves the right to change materials and specifications without notice.

---

**Avanti Products, A Division of The Mackle Co., Inc.  
P.O. Box 520604 - Miami, Florida 33152  
[www.avantiproducs.com](http://www.avantiproducs.com)**

---

## TABLE OF CONTENTS

|  |         |
|--|---------|
| Appliance Safety                               | 3       |
| Important Safeguides                           | 4       |
| Help Us Help You ...                           | 5       |
| Parts and Features                             | 6       |
| Important Safety Instructions                  | 7       |
| Installation Instructions                      | 7       |
| Before Using Your Beverage Center              | 7       |
| Installation of Your Beverage Center           | 7       |
| Electrical Connection                          | 8       |
| Extension Cord                                 | 8       |
| Reversing the Door Swing of Your Appliance     | 8       |
| Installing Stainless Steel Handle              | 9       |
| Operating Your Beverage Center                 | 10      |
| ON/OFF Power & Control Panel Lock              | 10      |
| Setting the Temperature Control                | 10      |
| Interior Light                                 | 11      |
| Door Lock                                      | 11      |
| Shelves  | 11      |
| Care and Maintenance                           | 11      |
| Cleaning Your Beverage Center                  | 11      |
| Power Failure                                  | 11      |
| Moving Your Beverage Center                    | 12      |
| Energy Saving Tips                             | 12      |
| Troubleshooting Guide                          | 12      |
| Service for Your Beverage Center               | 13      |
| Wiring Diagram                                 | 13      |
| Your Avanti Products Warranty                  | 14      |
| INSTRUCCIONES EN ESPAÑOL                       | 15 ~ 17 |
| Registration Information and Registration Card | 19      |

## APPLIANCE SAFETY

**Your safety and the safety of others are very important.**

We have provided many important safety messages in this manual and on your appliance. Always read and obey all safety messages.



This is the Safety Alert Symbol. This symbol alerts you to potential hazards that can kill or injure you and others. All safety messages will follow the Safety Alert Symbol and either the words "DANGER", "WARNING" or "CAUTION".



Danger means that failure to heed this safety statement may result in severe personal injury or death.



Warning means that failure to heed this safety statement may result in extensive product damage, serious personal injury, or death.



Caution means that failure to heed this safety statement may result in minor or moderate personal injury, or property or equipment damage.

All safety messages will alert you do what the potential hazard is, tell you how to reduce the chance of injury, and let you know what can happen if the instructions are not followed.

## IMPORTANT SAFEGUIDES



Before the appliance is used, it must be properly positioned and installed as described in this manual, so read the manual carefully. To reduce the risk of fire, electrical shock or injury when using the appliance, follow basic precaution, including the following:

### **DANGER**

- Plug into a grounded 3-prong outlet, do not remove grounding prong, do not use an adapter, and do not use an extension cord.
- Replace all panels before operating.
- It is recommended that a separate circuit, serving only your appliance be provided. Use receptacles that cannot be turned off by a switch or pull chain.
- Never clean appliance parts with flammable fluids. These fumes can create a fire hazard or explosion. And do not store or use gasoline or other flammable vapors and liquids in the vicinity of this or any other appliance. The fumes can create a fire hazard or explosion.
- Before proceeding with cleaning and maintenance operations, make sure the power line of the unit is disconnected.
- Do not connect or disconnect the electric plug when your hands are wet.
- Unplug the appliance or disconnect power before cleaning or servicing. Failure to do so can result in electrical shock or death.
- Do not attempt to repair or replace any part of your appliance unless it is specifically recommended in this material. All other servicing should be referred to a qualified technician.

### **WARNING**

FOLLOW WARNING CALL OUTS BELOW ONLY WHEN APPLICABLE TO YOUR MODEL

- Use two or more people to move and install appliance. Failure to do so can result in back or other injury.
- To ensure proper ventilation for your appliance, the front of the unit must be completely unobstructed. Choose a well-ventilated area with temperatures above 60°F (16°C) and below 90°F (32°C). This unit must be installed in an area protected from the element, such as wind, rain, water spray or drips.
- The appliance should not be located next to ovens, grills or other sources of high heat.
- The appliance must be installed with all electrical, water and drain connections in accordance with state and local codes. A standard electrical supply (115 V AC only, 60 Hz), properly grounded in accordance with the National Electrical Code and local codes and ordinances is required.
- Do not kink or pinch the power supply cord of appliance.
- The fuse (or circuit breaker) size should be 15 amperes.
- It is important for the appliance to be leveled in order to work properly. You may need to make several adjustments to level it.
- Never allow children to operate, play with or crawl inside the appliance.
- Do not use solvent-based cleaning agents or abrasives on the interior. These cleaners may damage or discolor the interior.
- Do not use this apparatus for other than its intended purpose.

---

## HELP US HELP YOU...

### Read this guide carefully.

It is intended to help you operate and maintain your new Beverage Center properly.

Keep it handy to answer your questions. If you don't understand something or you need more assistance, please call:

**Avanti Customer Service**  
**800-220-5570**

Keep proof of original purchase date (such as your sales slip) with this guide to establish the warranty period.

### **CAUTION:**

**THIS BEVERAGE CENTER IS NOT DESIGNED FOR THE STORAGE OF MEDICINE OR OTHER MEDICAL PRODUCTS.**

### Write down the model and serial numbers.

You'll find them on a plate located on the rear outside wall of the Beverage Center.

Please write these numbers here:

\_\_\_\_\_  
Date of Purchase

\_\_\_\_\_  
Model Number

\_\_\_\_\_  
Serial Number

Use these numbers in any correspondence or service calls concerning your Beverage Center.

If you received a damaged Beverage Center, immediately contact the dealer (or builder) that sold you the Beverage Center.

Save time and money. Before you call for service, check the Troubleshooting Guide. It lists causes of minor operating problems that you can correct yourself.

---

## IF YOU NEED SERVICE

We're proud of our service and want you to be pleased. If for some reason you are not happy with the service you receive, here are some steps to follow for further assistance.

FIRST, contact the people who serviced your Beverage Center. Explain why you are not pleased. In most cases, this will solve the problem.

NEXT, if you are still not pleased, write all the details, including your telephone number, and send it to:

**Customer Service**  
**Avanti Products**  
**10880 NW 30 Street**  
**Miami, FL 33172 USA**

## PARTS & FEATURES

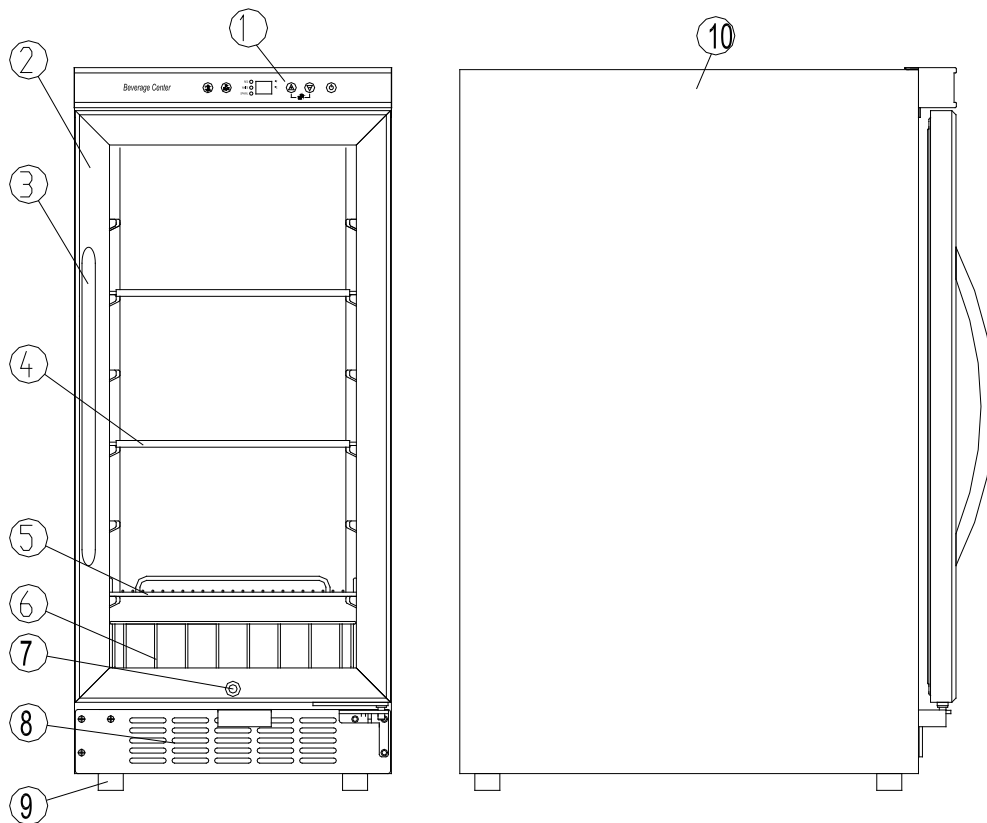

1. DIGITAL CONTROL PANEL
2. STAINLESS STEEL GLASS DOOR
3. STAINLESS STEEL HANDLE
4. GLASS SHELF (TOTAL 2)
5. WIRE BOTTOM SHELF
6. WIRE STORAGE BASKET
7. LOCK
8. BOTTOM GRILLE
9. LEVELING LEGS (4)
10. CABINET

## IMPORTANT SAFETY INSTRUCTIONS

|   |  |
|---|--|
| <b>⚡ WARNING ⚡</b>  | To reduce the risk of fire, electrical shock, or injury when using your appliance, follow these basic precautions: |
| <ul style="list-style-type: none"><li>• Read all instructions before using the Beverage Center.</li><li>• <b>DANGER or WARNING:</b> Risk of child entrapment. Child entrapment and suffocation are not problems of the past. Junked or abandoned appliances are still dangerous . . . even if they will “just sit in the garage a few days”.</li><li>• <b>Before you throw away your old Beverage Center:</b> Take off the door. Leave the shelves in place so that children may not easily climb inside.</li><li>• Never allow children to operate, play with, or crawl inside the appliance.</li><li>• Never clean appliance parts with flammable fluids. The fumes can create a fire hazard or explosion.</li><li>• Do not store or use gasoline or any other flammable vapors and liquids in the vicinity of this or any other appliance. The fumes can create a fire hazard or explosion.</li></ul> <p style="text-align: center;">-Save these instructions-</p> |  |

## INSTALLATION INSTRUCTIONS

### ➤ **BEFORE USING YOUR BEVERAGE CENTER**

- Remove the exterior and interior packing.
- Check to be sure you have all of the following parts:
  - 2 Glass Shelves
  - 1 Wire Shelf
  - 1 Wire basket
  - 2 Keys
  - 1 Stainless Steel Handle Assembly with Hardware
  - 2 decorative screws.
  - 1 Instruction Manual
- Before connecting the Beverage Center to the power source, let it stand upright for approximately 2 hours. This will reduce the possibility of a malfunction in the cooling system from handling during transportation.
- Clean the interior surface with lukewarm water using a soft cloth.
- Install the handle on the left side of the door.

### ➤ **INSTALLATION OF YOUR BEVERAGE CENTER**

- This appliance is designed to be for free standing installation or built-in (fully recessed).
- Place your Beverage Center on a floor that is strong enough to support it when it is fully loaded. To level your Beverage Center, adjust the front leveling legs at the bottom of the Beverage Center.
- Locate the Beverage Center away from direct sunlight and sources of heat (stove, heater, radiator, etc.). Direct sunlight may affect the acrylic coating and heat sources may increase electrical consumption. Extreme cold ambient temperatures may also cause the unit not to perform properly.
- Avoid locating the unit in moist areas.
- Plug the Beverage Center into an exclusive, properly installed-grounded wall outlet. Do not under any circumstances cut or remove the third (ground) prong from the power cord. Any questions concerning power and/or grounding should be directed toward a certified electrician or an authorized Avanti Products service center.

➤ **ELECTRICAL CONNECTION**

**⚡ Warning ⚡**

Improper use of the grounded plug can result in the risk of electrical shock. If the power cord is damaged, have it replaced by an authorized Avanti Products service center.

This appliance should be properly grounded for your safety. The power cord of this appliance is equipped with a three-prong plug which mates with standard three prong wall outlets to minimize the possibility of electrical shock.

Do not under any circumstances cut or remove the third ground prong from the power cord supplied. For personal safety, this appliance must be properly grounded.

This appliance requires a standard 115/120 Volt AC ~/60Hz electrical ground outlet with three-prong. Have the wall outlet and circuit checked by a qualified electrician to make sure the outlet is properly grounded. When a standard 2-prong wall outlet is encountered, it is your responsibility and obligation to have it replaced with a properly grounded 3-prong wall outlet.

The cord should be secured behind the appliance and not left exposed or dangling to prevent accidental injury.

The appliance should always be plugged into its own individual electrical outlet which has a voltage rating that matches the rating label on the appliance. This provides the best performance and also prevent overloading house wiring circuits that could cause a fire hazard from overheated. Never unplug the appliance by pulling the power cord. Always grip the plug firmly and pull straight out from the receptacle. Repair or replace immediately all power cords that have become frayed or otherwise damaged. Do not use a cord that shows cracks or abrasion damage along its length or at either end. When moving the appliance, be careful not to damage the power cord.

➤ **EXTENSION CORD**

Because of potential safety hazards under certain conditions, it is strongly recommended that you do not use an extension cord with this appliance. However, if you must use an extension cord it is absolutely necessary that it be a UL/CUL-Listed, 3-wire grounding type appliance extension cord having a grounding type plug and outlet and that the electrical rating of the cord be 115 volts and at least 10 amperes.

➤ **REVERSING THE DOOR SWING OF YOUR APPLIANCE**

This appliance has the capability of the door opening from either the left or right side. The unit is delivered to you with the door opening from the left side. Should you desire to reverse the opening direction, please call service for reversal instructions.



➤ **INSTALLING STAINLESS STEEL HANDLE**

This wine cellar includes a stainless steel handle that is not required to operate this unit.

To install the handle please follow the below instructions:

For your convenience the screws used in the installation of the handle have been put in place at the factory.

1. Pull away the door gasket in the area where the handle is to be installed on the left side as shown below in Illustration # 1. The gasket is easily displaced by hand, no tools are necessary.
2. Align the handle with the screws installed. Tighten the screws using a Phillips head screwdriver until the handle sets both flush and secured tightly against the door frame. (DO NOT over tighten as this will cause damage to the handle assembly).
3. Replace the door gasket to its original position.
4. If you choose not to use the handle supplied, simply follow step 1 to access the installation screws and remove them and then place the two decorative plugs into the two holes separately. Continue on to step 3 to replace the door gasket to its original position.

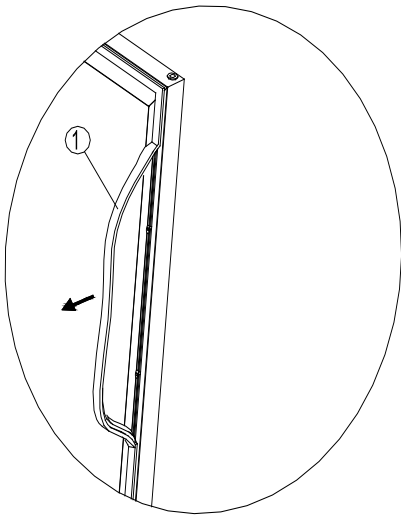

Illustration # 1

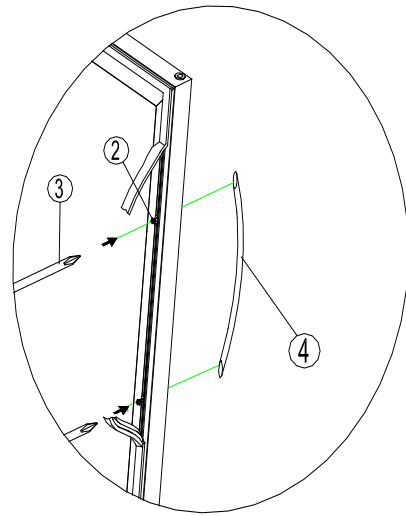
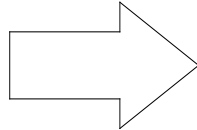

Illustration # 2

|   |                     |   |                            |
|---|---------------------|---|----------------------------|
| 1 | Gasket              | 3 | Phillips Head Screw Driver |
| 2 | Phillips Head Screw | 4 | Handle                     |

## OPERATING YOUR BEVERAGE CENTER

It is recommended you install the Beverage Center in a place where the ambient temperature is between 23°-26°C/ 72°-78°F. If the ambient temperature is above or below recommended temperatures, the performance of the unit may be affected. For example, placing your unit in extreme cold or hot conditions may cause interior temperatures to fluctuate. The range of 5°-18°C/40°-65°F may not be reached.

The temperature range of this Beverage Center is 1°-6°C/34°-43°F The preset temperature is 3°C/38°F.

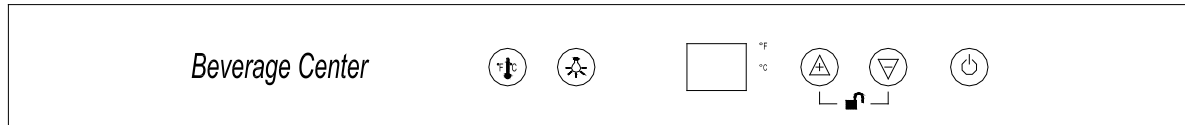



You can select temperature display setting from Fahrenheit to Celsius degree by touching the °F/°C mark. Fahrenheit or Celsius degrees indicator will appear in blue color in the temperature display window.





### ➤ ON/OFF POWER

To turn OFF the appliance, touch the  mark and hold for 2 seconds.

### ➤ Control Panel Lock.

- Your Beverage Center is equipped with an automatic Control panel lock function. This function will prevent any unwanted changes to your temperature or power settings.
- The lock function will activate automatically 12 seconds after the last time a button is pushed on the control panel.
- To unlock the control panel lock press and hold the  and the  buttons for 3 seconds the control panel will beep and blink once indicating that the control panel is active and the settings can be changed.

### ➤ SETTING THE TEMPERATURE CONTROL

- You can set the temperature as you desire by touching the  or  mark. When you touch the two marks for the first time, the LED readout will show the original temperature set at previous time (the temperature preset at the factory is 3°C/38°F).
- The temperature that you desire to set will increase 1°F or 1°C if you touch the  mark once, on the contrary the temperature will decrease 1°F or 1°C if you touch the  mark once.
- The temperature inside the unit will be appeared in blue color in the display window.

### NOTE:

- If the unit is unplugged, power lost, or turned off, you must wait 3 to 5 minutes before restarting the unit. If you attempt to restart before this time delay, the Beverage Center will not start.
- When you use the Beverage Center for the first time or restart the Beverage Center after having been shut off for a long time, there could be a few degrees variance between the temperature you select and the one indicated on the LED readout. This is normal and it is due to the length of the activation time. Once the Beverage Center is running for a few hours everything will be back to normal.

### ➤ **INTERIOR LIGHT**

You can turn the interior light ON or OFF by touching the mark .

The light will be turned off automatically if it remains ON for 10 minutes. You have to touch the mark  again and the light will turn back on.

### ➤ **DOOR LOCK**

Your unit is provided with a lock and key combination.

The keys are located inside the plastic bag that contains the User's Guide. Insert the key into the lock and turn it counterclockwise to unlock the door. To lock the door do the reverse operation making sure metal pin is engaged completely. Remove the key and place it in a secure place for safekeeping.

### ➤ **SHELVES**

The beverage center is equipped with the two (2) glass shelves and one (1) wire shelf. You can move the shelves out and in smoothly.

- To prevent damaging the door gasket, make sure to have the door all the way opened when pulling the shelves outward.
- For easy access to the storage content, you can pull the shelves outward to gain access to the items on the rear portion of the shelf, however this unit was designed with a plastic post on each sides of the shelf track to prevent the shelves from falling.
- When removing the shelf out of the inner rail, make sure to remove all items first. Then move the shelf to the position where the notch of shelf is exactly under the plastic post and lift the shelf. In order to replace the shelf, repeat steps described above in reverse.

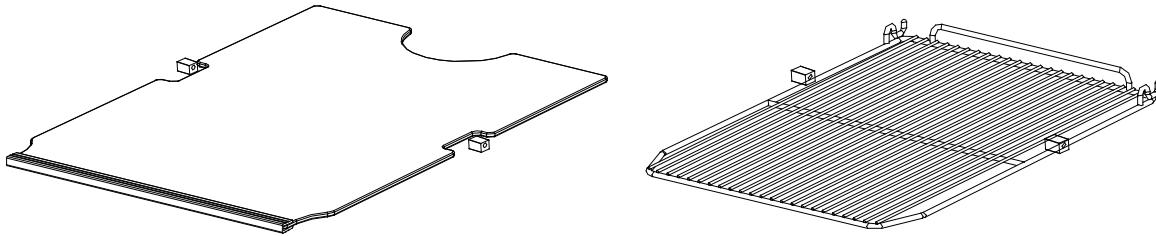

## **CARE AND MAINTENANCE**

### ➤ **CLEANING YOUR BEVERAGE CENTER**

- Turn off the power, unplug the appliance, and remove all items including shelves.
- Wash the inside surfaces with a warm water and baking soda solution. The solution should be about 2 tablespoons of baking soda to a quart of water.
- Wash the shelves with a mild detergent solution.
- Wring excess water out of the sponge or cloth when cleaning area of the controls, or any electrical parts.
- Wash the outside cabinet with warm water and mild liquid detergent. Rinse well and wipe dry with a clean soft cloth.
- Do not use steel wool or steel brush on the stainless steel. These will contaminate the stainless steel with steel particles and rusting may occur.

### ➤ **POWER FAILURE**

- Most power failures are corrected within a few hours and should not affect the temperature of your appliance if you minimize the number of times the door is opened. If the power is going to be off for a longer period of time, you need to take the proper steps to protect your contents.

➤ **MOVING YOUR BEVERAGE CENTER**

- Remove all items.
- Securely tape down all loose items (shelves) inside your appliance.
- Turn the adjustable leg up to the base to avoid damage.
- Tape the door shut.
- Be sure the appliance stays secure in the upright position during transportation. Also protect outside of appliance with a blanket, or similar item.

➤ **ENERGY SAVING TIPS**

- The Beverage Center should be located in the coolest area of the room, away from heat producing appliances, and out of the direct sunlight.

## **PROBLEMS WITH YOUR BEVERAGE CENTER?**

You can solve many common Beverage Center problems easily, saving you the cost of a possible service call. Try the suggestions below to see if you can solve the problem before calling the servicer.

### **TROUBLESHOOTING GUIDE**

| <b>PROBLEM</b>                                    | <b>POSSIBLE CAUSE</b>   |
|---|---|
| Beverage Center does not operate.                 | Not plugged in.<br>The appliance is turned off.<br>The circuit breaker tripped or a blown fuse.   |
| Beverage Center is not cold enough.               | Check the temperature control setting.<br>External environment may require a higher setting.<br>The door is opened too often.<br>The door is not closed completely.<br>The door gasket does not seal properly.  |
| Turns on and off frequently.                      | The room temperature is hotter than normal.<br>A large amount of contents has been added to the Beverage Center.<br>The door is opened too often.<br>The door is not closed completely.<br>The temperature control is not set correctly.<br>The door gasket does not seal properly.   |
| The light does not work.                          | Not plugged in.<br>The circuit breaker tripped or a blown fuse.<br>The light button is "OFF".   |
| Vibrations.                                       | Check to assure that the Beverage Center is level.  |
| The Beverage Center seems to make too much noise. | The rattling noise may come from the flow of the refrigerant, which is normal.<br>As each cycle ends, you may hear gurgling sounds caused by the flow of refrigerant in your Beverage Center.<br>Contraction and expansion of the inside walls may cause popping and crackling noises.<br>The Beverage Center is not level. |
| The door will not close properly.                 | The Beverage Center is not level.<br>The door was reversed and not properly installed.<br>The gasket is dirty.<br>The shelves are out of position.  |

## SERVICE FOR YOUR BEVERAGE CENTER

We are proud of our customer service organization and the network of professional service technicians that provide service on your Avanti appliances. With the purchase of your Avanti appliance, you can have the confidence that if you ever need additional information or assistance, the Avanti Products Customer Service team will be here for you. Just call us toll-free.

### AVANTI PRODUCTS CUSTOMER SERVICES

|   |  |
|---|--|
| <b>Product Information</b><br>800-323-5029    | Whatever your questions are about our products, help is available.   |
| <b>Part Orders</b><br>800-220-5570            | You may order parts and accessories that will be delivered directly to your home by personal check, money order, Master Card, or Visa.   |
| <b>In-Home Repair Service</b><br>800-220-5570 | An Avanti Products authorized service center will provide expert repair service, scheduled at a time that is convenient for you. Our trained servicers know your appliance inside and out. |

### WIRING DIAGRAM

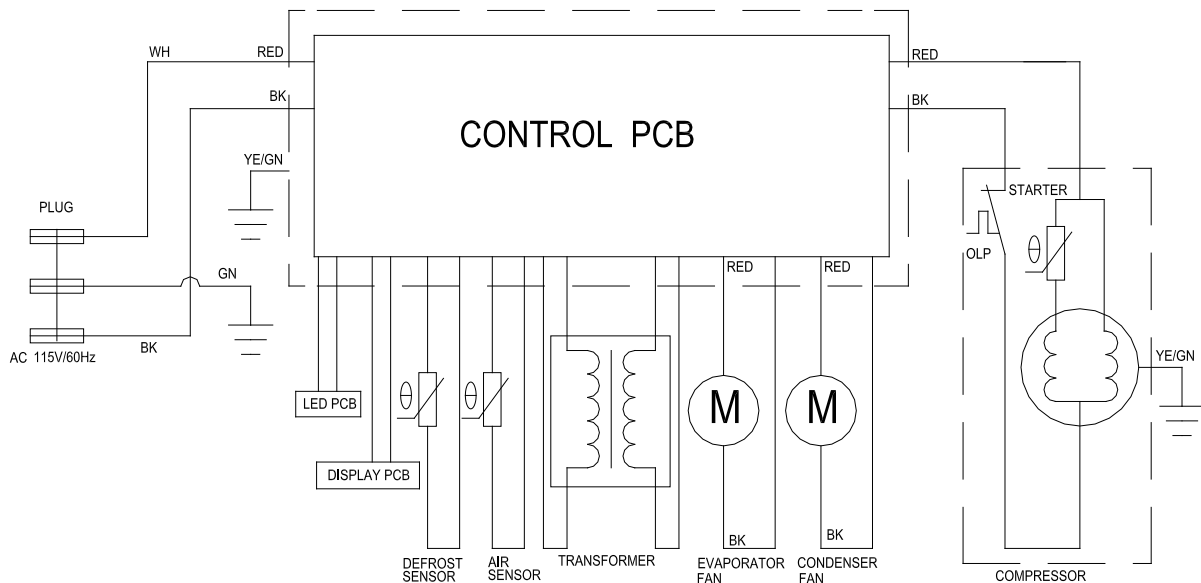

**WHAT IS COVERED****LIMITED ONE-YEAR WARRANTY**

For one year from the date of purchase by the original owner, Avanti Products will, at its option, repair or replace any part of the unit, which proves to be defective in material or workmanship under normal use. During this period Avanti Products will provide all parts and labor necessary to correct such defects free of charge, so long as the unit has been installed and operated in accordance with the written instructions in this manual. Avanti Products will provide you with a reasonably similar replacement product that is either new or factory refurbished. In rental or commercial use, the warranty period is 90 days. All Avanti Appliances of 3.5 cubic feet capacity or less must be brought/sent to the appliance service shop for repair.

**LIMITED SECOND THROUGH FIFTH YEAR WARRANTY**

For the second through the fifth year from date of original purchase, Avanti Products will provide a replacement compressor free of charge due to a failure. You are responsible for the service labor and freight charges. In rental or commercial use, the limited compressor warranty is one year and nine months. Cost to move the appliance to the servicers' shop and back to the user's home, as may be required, are the user's responsibility.

**WHAT IS NOT COVERED**

- Content losses of food or other, due to spoilage.
- Incidental or consequential damages.
- Parts and labor costs for the following will not be considered as warranty:
  - Door springs, and/or frames.
  - Inner door panels, door rails and/or door supports.
  - Light bulbs and/or plastic housing.
  - Plastic cabinet liners.
  - Punctured evaporator that voids the warranty on the complete sealed system.
  - Shipping and Handling costs associated with the replacement of the unit.
- Repairs performed by unauthorized servicers.
- Service calls that do not involve defects in material or workmanship such as customer education, door reversal, or proper installation.
- Surcharges including, but not limited to, any after hour, weekend, or holiday service calls, tolls, ferry trip charges, or mileage expense for service call to remote areas, including the State of Alaska.
- Service calls that are related to external problems, such as abuse, misuse, inadequate electrical power, accidents, fire, floods, or acts of God.
- Replacement of house fuses or resetting circuit breakers.
- Failure of the product if it is used for other than its intended purpose.
- This warranty does not apply outside the Continental USA.

## **INSTRUCCIONES DE SEGURIDAD**

### **ATENCION**

#### **INSTRUCCIONES PARA LA CONEXION A TIERRA**

Este aparato electrodoméstico debe estar conectado a tierra. En caso de un cortocircuito eléctrico, la conexión a tierra reduce el riesgo de choque eléctrico proporcionando un cable a tierra con una enchufe de conexión a tierra. Este enchufe debe estar conectado en un tomacorriente instalado correctamente y conectado a tierra.

**ADVERTENCIA** – El uso inadecuado del enchufe de conexión a tierra puede resultar en un riesgo de choque eléctrico. Consulte con un electricista o persona de reparaciones competente si no comprenden bien las instrucciones de conexión a tierra o si existe alguna duda sobre si el aparato esta conectado a tierra correctamente.

#### **NO USE UN CORDON DE PROLONGACION ELECTRICA**

Use un tomacorriente de pared exclusivo. No conecte su vinera a cordones de prolongación eléctrica o junto a cualquier otro electrodoméstico en el mismo tomacorriente de pared.

#### **ADVERTENCIA IMPORTANTE:**

Un refrigerador vacío es una atracción muy peligrosa para los niños. Saque todas las juntas, pestillos, tapas o puerta de todo electrodoméstico que no esté en uso, o tome alguna medida para asegurar que no presente peligro.

### **INSTRUCCIONES DE INSTALACION**

Saque los embalajes exteriores, limpie bien el exterior con un paño suave seco, y el interior con un paño húmedo y tibio. Evite colocar el refrigerador cerca de una fuente de calor, luz de sol directa, o lugar húmedo.

#### **Ubicación**

1. Seleccione un lugar con su piso fuerte y nivelado.
2. Evite la luz directa del sol o calor. La luz directa del sol puede afectar la capa de acrílico. Las fuentes de calor en su proximidad provocarán un consumo mayor de electricidad.

### **OPERACION**

Para evitar vibraciones, el compartimiento interior debe estar bien nivelado. La temperatura variará dependiendo de la cantidad de botellas o latas almacenadas y la frecuencia con que se abre la puerta.

Cuando el refrigerador no se use por un período largo, desconecte el enchufe y deje la puerta entreabierta.

Nota: Espere entre 3 a 5 minutos antes de volver a encender si el funcionamiento ha sido interrumpido.

Se recomienda que Ud coloque su refrigerador en un lugar donde la temperatura ambiental se mantenga entre 23-25 grados centígrados.

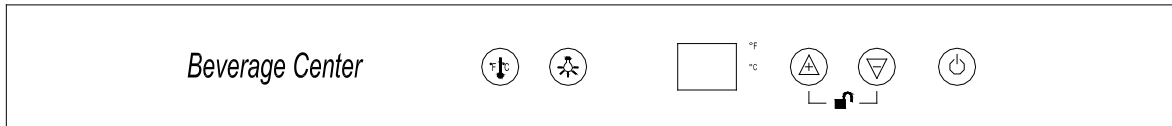

Si la temperatura ambiental oscila afuera de esos límites, pueda afectar la temperatura de la caja. Por ejemplo, si su unidad está situada en lugares donde hay temperaturas muy frías o calientes también puede afectar la temperatura de la caja.







## ENCENDIDO/APAGADO



Para apagar el refrigerador, presione el botón (  ) y manténgalo presionado por un mínimo de 3 segundos.

## PANEL DE CONTROL DE SEGURIDAD

- Su refrigerador está equipada con un Panel de Control de Seguridad de función automática. Esta función previene cualquier cambio no deseado en el control de temperatura.
- La función de seguridad se activará automáticamente 12 segundos después de la última vez que cualquier botón del Panel de Control sea presionado.
- Para poder hacer cambios en el Panel de Control, presione y mantenga presionados los botones  y  por 3 segundos, el Panel del Control emitirá un sonido de “Beep” y parpadeará una vez, indicando que el Panel de Control ha sido activado y que puede efectuar cambios en los controles.

## Operación

Oprima los botones marcado “” y “” localizados en el panel de controles para programar la temperatura. Al presionar los botones marcados “” o “” por primera vez, el indicador en la pantalla mostrará la temperatura programada de fábrica o la más reciente.

Oprima el botón marcado  una vez y la temperatura aumentará un grado. Si Ud oprime el botón marcado  una vez la temperatura bajará un grado.

## Luz interior

La luz interior se controla manualmente y no funciona al abrir ni cerrar la puerta. Para prender o apagar la luz, presione el botón marcado () de la luz ubicado en el panel de control. Si la luz esta prendida, por más de 10 minutos, se apagará automáticamente.

## Cerradura de la puerta

Su unidad viene equipada con una combinación de cerradura y llave.

Las llaves (2) están dentro de la bolsa plástica junto al manual de instrucciones.

Introduzca la llave en la cerradura y gírela hacia la izquierda para abrir la puerta.

Para cerrarla, gire la llave hacia la derecha.

Quite la llave y colóquela en un lugar seguro para evitar que se pierda.

## Descongelación

Su refrigerador ha sido diseñado con un sistema de descongelación de “ciclo automático”.

Las superficies refrigeradas del compartimento se descongelan automáticamente, durante el ciclo “apagado” del control de enfriamiento (termostato). El agua descongelada del compartimento es eliminada automáticamente, encauzándola hacia una bandeja de goteo ubicado en el compresor. La transferencia de calor del compresor evapora el agua.

## **ADVERTENCIA**

Asegúrese de tener la puerta abierta completamente se Ud desea remover las repisas o moverlas hacia adelante para extraer una botella.



**NOTA:**

Para remover las repisas corredizas, vacíe las repisas antes de sacarlas. Hálelas aproximadamente un tercio hacia afuera hasta que la marca en el raíl se alinee con el poste plástico en ambos lados. Levante cada repisa y sáquela suavemente de la unidad. Para reemplazar de nuevo la repisa, repita los pasos anteriores en dirección opuesta.

**CUIDADO Y MANTENIMIENTO****Limpieza**

Para limpiar el interior, use un paño suave con una solución de una cucharada de bicarbonato de sodio por cada cuarto de agua, o una solución de espuma de jabón suave, o un detergente suave. Para lavar las rejillas, sáquelas deslizándolas con cuidado, y use una solución de detergente suave; luego séquelas con un paño suave. Limpie el exterior con un paño húmedo suave y un poco de detergente suave o productos de limpieza para electrodomésticos.

**Período de vacaciones**

Para períodos cortos de vacaciones, deje los controles en la posición normal. Durante ausencias más largas;

- (a) saque todo el contenido,
- (b) desconecte la vinera del tomacorriente,
- (c) limpie bien el refrigerador para vinos,
- (d) deje la puerta abierta para evitar la formación de condensación, moho u olores.

**Corte de corriente**

La mayoría de los cortes de corriente se corrigen en una o dos horas y no afectarán las temperaturas de su vinera. Sin embargo, Ud. deberá reducir la cantidad de veces que abra la puerta cuando la corriente esté apagada.

**Si Ud. se muda**

Saque o asegure todos los artículos dentro de su refrigerador. Para evitar que los tornillos nivelantes se averíen, gírelos completamente hacia la base.

**Algunas reglas importantes para el uso correcto de su refrigerador.**

- Las bebidas se deben guardar en botellas o latas cerradas.
- No sobrecargue el compartimiento interior.
- No abra la puerta a menos que sea necesario.
- Si el refrigerador se guardara sin uso por períodos largos, se sugiere que, luego de una limpieza cuidadosa, se deje la puerta entreabierta para permitir que el aire circule dentro de la caja y evitar una posible formación de condensación, moho u olores.
- Nunca cubra los estantes del compartimiento para vinos con papel de aluminio o cualquier otro material para cubrir estantes que puedan obstruir la circulación del aire.



## REGISTRATION INFORMATION

Thank you for purchasing this fine Avanti product. Please fill out this form and return it within 100 days of purchase and receive these important benefits to the following address:

**Avanti Products, A Division of The Mackle Co., Inc.**  
**P.O. Box 520604 - Miami, Florida 33152 USA**

➤ **Protect your product:**

We will keep the model number and date of purchase of your new Avanti Products product on file to help you refer to this information in the event of an insurance claim such as fire or theft.

➤ **Promote better products:**

We value your input. Your responses will help us develop products designed to best meet your future needs.

------(detach here)-----

### Avanti Registration Form

\_\_\_\_\_  
Name

\_\_\_\_\_  
Model #

\_\_\_\_\_  
Serial #

\_\_\_\_\_  
Address

\_\_\_\_\_  
Date Purchased

\_\_\_\_\_  
Store/Dealer Name

\_\_\_\_\_  
City

\_\_\_\_\_  
State

\_\_\_\_\_  
Zip

\_\_\_\_\_  
Occupation

\_\_\_\_\_  
Area Code

\_\_\_\_\_  
Phone Number

**As Your Primary Residence, Do You:**

Own

Rent

**Did You Purchase An Additional Warranty:**

Extended  Food Loss  None

**Reason For Choosing This Avanti Product:**

Please indicate the most important factors that influenced your decision to purchase this product.

Price

Product Features

Avanti Products Reputation

Product Quality

Salesperson Recommendation

Friend/Relative Recommendation

Warranty

Other \_\_\_\_\_

**Your Age:**

under 18  18-25  26-30

31-35  36-50  over 50

**Marital Status:**

Married  Single

**Is This Product Used In The:**

Home  Business

**How Did You Learn About This Product:**

Advertising

In Store Demo

Personal Demo

Other \_\_\_\_\_

Comments \_\_\_\_\_

**V2**

**PRINTED IN CHINA**

## Free Manuals Download Website

<http://myh66.com>

<http://usermanuals.us>

<http://www.somanuals.com>

<http://www.4manuals.cc>

<http://www.manual-lib.com>

<http://www.404manual.com>

<http://www.luxmanual.com>

<http://aubethermostatmanual.com>

Golf course search by state

<http://golfingnear.com>

Email search by domain

<http://emailbydomain.com>

Auto manuals search

<http://auto.somanuals.com>

TV manuals search

<http://tv.somanuals.com>