

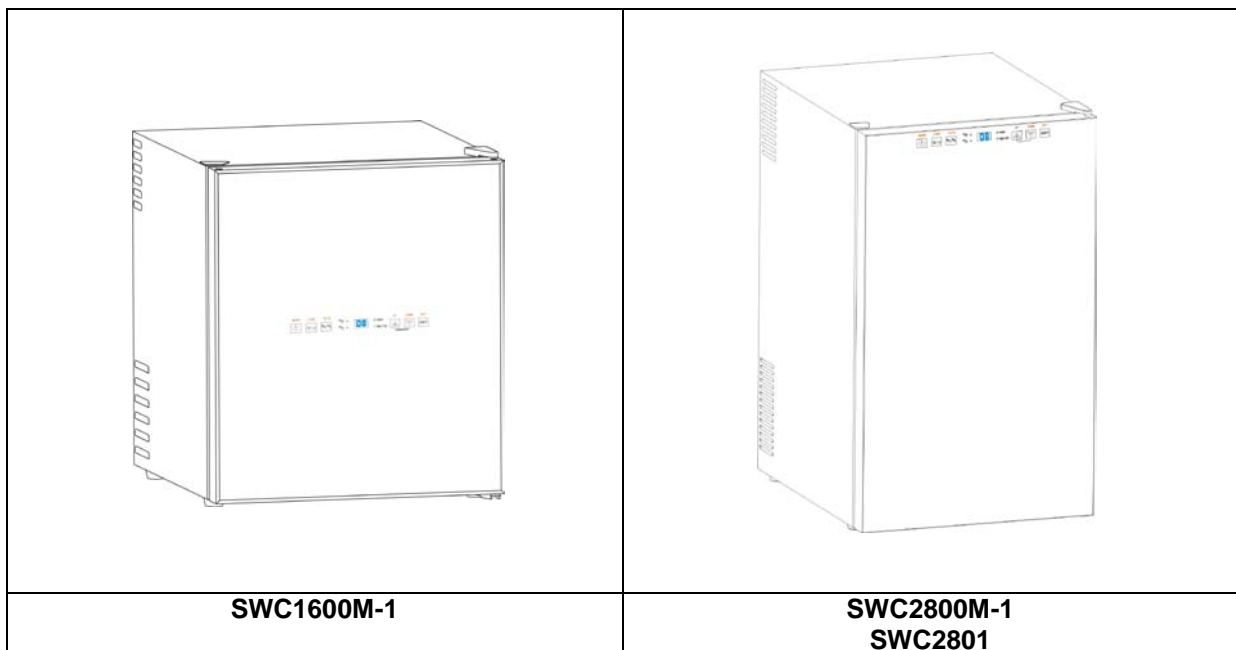

**INSTRUCTION MANUAL
MANUAL DE INSTRUCCIONES**

Model Numbers / No. de Modelos: SWC1600M-1 / SWC2800M-1 / SWC2801

WINE CHILLER / VINERA



(Image may vary)

BEFORE USE, PLEASE READ AND FOLLOW ALL SAFETY RULES AND OPERATING INSTRUCTIONS.

La sección en español empieza en la página 12.

Avanti Products has a policy of continuous improvement on its products and reserves the right to change materials and specifications without notice.

Avanti Products, A Division of The Mackle Co., Inc.
P.O. Box 520604 - Miami, Florida 33152
www.avantiproductions.com

TABLE OF CONTENTS

Help Us Help You	3
Parts and Features	4
Important Safety Instructions	5
Installation Instructions	5
Before Using Your Wine Chiller	5
Installation of Your Wine Chiller	5
Electrical Connection	6
Extension Cord	6
Operating Your Wine Chiller	7
Temperature Control	7
Storage Capacity	8
Interior Light	8
Care and Maintenance	8
Cleaning Your Wine Chiller	8
Power Failure	8
Moving Your Wine Chiller	8
Energy Saving Tips	8
Troubleshooting Guide	9
Service for Your Appliance	10
Wiring Diagram	10
Your Avanti Products Warranty	11
Instrucciones en Español	12 – 14
Registration Information and Registration Card	15

HELP US HELP YOU...

Read this guide carefully.

It is intended to help you operate and maintain your new Wine Chiller properly.

Keep it handy to answer your questions. If you don't understand something or you need more assistance, please call:

Avanti Customer Service
800-220-5570

Keep proof of original purchase date (such as your sales slip) with this guide to establish the warranty period.

CAUTION:

THIS WINE CHILLER IS NOT DESIGNED FOR THE STORAGE OF MEDICINE OR OTHER MEDICAL PRODUCTS.

Write down the model and serial numbers.

You'll find them on a plate located on the rear outside wall of the Wine Chiller.

Please write these numbers here:

Date of Purchase

Model Number

Serial Number

Use these numbers in any correspondence or service calls concerning your Wine Chiller.

If you received a damaged Wine Chiller, immediately contact the dealer (or builder) that sold you the Wine Chiller.

Save time and money. Before you call for service, check the Troubleshooting Guide. It lists causes of minor operating problems that you can correct yourself.

IF YOU NEED SERVICE

We're proud of our service and want you to be pleased. If for some reason you are not happy with the service you receive, here are some steps to follow for further assistance.

FIRST, contact the people who serviced your Wine Chiller. Explain why you are not pleased. In most cases, this will solve the problem.

NEXT, if you are still not pleased, write all the details, including your telephone number, and send it to:

Customer Service
Avanti Products
10880 NW 30 Street
Miami, FL 33172 USA

PARTS & FEATURES

SWC1600M-1

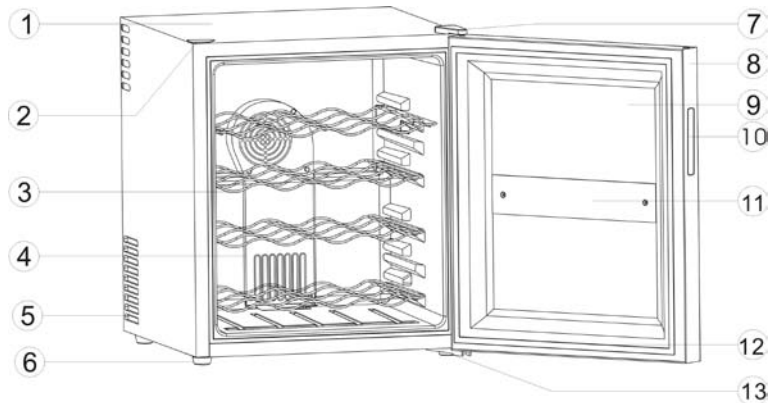

1	Cabinet	8	Door Panel
2	Plastic Cover	9	Glass Door
3	Shelf (Total 4)	10	Door Handle
4	Fan Cover	11	Control Panel (Inside view)
5	Ventilation Holes	12	Door Gasket
6	Leveling Legs	13	Lower Door Hinge
7	Upper Door Hinge w/ Cover		

MODELS: SWC2800M-1 / SWC2801

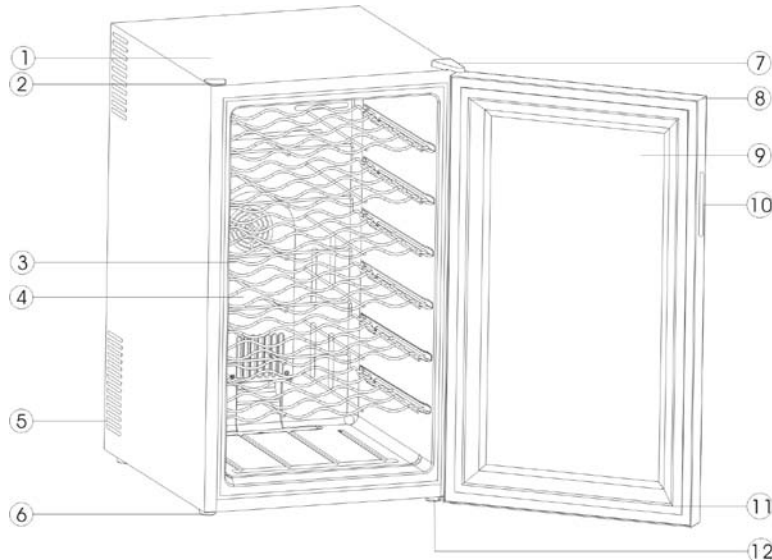

1	Cabinet	7	Upper Door Hinge with Cover
2	Plastic Cover	8	Door Panel
3	Shelf (Total 6)	9	Glass Door
4	Fan Cover	10	Door Handle
5	Ventilation Holes	11	Door Gasket
6	Leveling Legs	12	Lower Door Hinge

IMPORTANT SAFETY INSTRUCTIONS

~WARNING~	To reduce the risk of fire, electrical shock, or injury when using your appliance, follow these basic precautions:
<ul style="list-style-type: none"> • Read all instructions before using the Wine Chiller. • DANGER or WARNING: Risk of child entrapment. Child entrapment and suffocation are not problems of the past. Junked or abandoned appliances are still dangerous . . . even if they will “just sit in the garage a few days”. • Before you throw away your old Wine Chiller: Take off the door. Leave the shelves in place so that children may not easily climb inside. • Never allow children to operate, play with, or crawl inside the appliance. • Never clean appliance parts with flammable fluids. The fumes can create a fire hazard or explosion. • Do not store or use gasoline or any other flammable vapors and liquids in the vicinity of this or any other appliance. The fumes can create a fire hazard or explosion. • Do not repair or replace any part of the wine chiller or attempt any servicing unless specifically recommended in the user-maintenance instructions or in published user-repair instructions. Replace the fuse with the same type. <p style="text-align: center;">-Save these instructions-</p>	

INSTALLATION INSTRUCTIONS

→ **Before Using Your Wine Chiller**

- Remove the exterior and interior packing.
- Check to be sure you have all of the following parts:

Model SWC1600M-1	Models SWC2800M-1 SWC2801
(4) Shelves	(6) Shelves
(1) Instruction Manual	(1) Instruction Manual

- Clean the interior surface with lukewarm water using a soft cloth.
- **Installation of Your Wine Chiller**
- This Wine Chiller is designed to be free standing installation only, and should not be recessed or built-in (Fully recessed).
 - Place your Wine Chiller on a surface that is strong enough to support it when it is fully loaded.
 - Allow 5 inches of space between the back and sides of the wine chiller, which allows the proper air circulation to cool the heat sink.
 - Locate the Wine Chiller away from direct sunlight and sources of heat (stove, heater, radiator, etc.). Direct sunlight may affect the acrylic coating and heat sources may increase electrical consumption. Extreme cold ambient temperatures may also cause the unit not to perform properly.
 - This Wine Chiller uses superconductor refrigeration technology (no compressor) and is not designed for storage in hot areas like garages, warehouses or outdoors since it is designed to operate at a maximum of 30 degrees below the ambient temperature.
 - Avoid locating the unit in moist areas.
 - Plug the Wine Chiller into an exclusive, properly installed-grounded wall outlet. Do not under any circumstances cut or remove the third (ground) prong from the power cord. Any questions concerning power and/or grounding should be directed toward a certified electrician or an authorized Avanti Products service center.
 - After plugging the Wine Chiller into a wall outlet, allow the unit to cool down for 2-3 hours before placing any items in the compartment.

→ **Electrical Connection**

~Warning~

Improper use of the grounded plug can result in the risk of electrical shock. If the power cord is damaged, have it replaced by an authorized Avanti Products service center.

This appliance should be properly grounded for your safety. The power cord of this appliance is equipped with a three-prong plug which mates with standard three prong wall outlets to minimize the possibility of electrical shock.

Do not under any circumstances cut or remove the third ground prong from the power cord supplied. For personal safety, this appliance must be properly grounded.

This appliance requires a standard 115 Volt AC / 60Hz electrical ground outlet with three-prong. Have the wall outlet and circuit checked by a qualified electrician to make sure the outlet is properly grounded. When a standard 2-prong wall outlet is encountered, it is your responsibility and obligation to have it replaced with a properly grounded 3-prong wall outlet.

The cord should be secured behind the appliance and not left exposed or dangling to prevent accidental injury.

The appliance should always be plugged into its own individual electrical outlet which has a voltage rating that matches the rating label on the appliance. This provides the best performance and also prevent overloading house wiring circuits that could cause a fire hazard from overheated. Never unplug the appliance by pulling the power cord. Always grip the plug firmly and pull straight out from the receptacle. Repair or replace immediately all power cords that have become frayed or otherwise damaged. Do not use a cord that shows cracks or abrasion damage along its length or at either end. When moving the appliance, be careful not to damage the power cord.

→ **Extension Cord**

Because of potential safety hazards under certain conditions, it is strongly recommended that you do not use an extension cord with this appliance. However, if you must use an extension cord it is absolutely necessary that it be a UL/CUL-Listed, 3-wire grounding type appliance extension cord having a grounding type plug and outlet and that the electrical rating of the cord be 115 volts and at least 10 amperes.

OPERATING YOUR WINE CHILLER

It is recommended you install the Wine Chiller in a place where the ambient temperature is between 23°-26°C/ 72°-78°F. If the ambient temperature is above or below recommended temperatures, the performance of the unit may be affected. For example, placing your unit in extreme cold or hot conditions may cause interior temperatures to fluctuate. The range of 8°-18°C/46°-65°F may not be reached.

Recommended Temperatures for Chilling Wine.

Red Wines	14° - 18° C	57 – 65° F
Dry/White Wines	9° - 14° C	49 – 58° F
Rose Wines	10° - 11° C	51 – 53° F
Sparkling Wines	5° - 9° C	40 – 49° F







Temperature Ranges For Your Wine Chiller

Temperature Range	8 - 18° C	46 – 64° F
-------------------	-----------	------------

CONTROL PANEL



 You can select temperature display setting from Fahrenheit to Celsius degree by pushing this button. (Fahrenheit or Celsius indicator will appear in green color) The degrees will appear in blue color in the temperature display window.

- **SETTING THE TEMPERATURE CONTROL**
- Your Wine Cellar has been equipped with an “automatic” control panel lock, that will activate 12 seconds after the last time a button has been touched.
Push the  and  button simultaneously for 3 seconds to unlock the control panel. You will hear a “BEEP” sound to alert you that the control is now active.
- You can set the temperature as you desire by pushing the  or  button on the control panel for each zone. The temperature that you desire to set will increase 1°F or 1°C if you push the  button once, on the contrary the temperature will decrease 1°F or 1°C if you push the  button once.
- When you store mostly red wines, the temperature needs to be set at between 14° - 18°C (57° - 65°F). The indicator marked “RED” will light up in Red.
- When you store mostly white wines, the temperature needs to be set at between 9° - 14°C (49° - 58°F). The indicator marked “WHITE” will light up in Blue.
- When you store mostly sparkling wines, the temperature needs to be set at between 5° - 9°C (40° - 49°F). The indicator marked “WHITE” will light up in Blue.
- **NOTE:**
 - When you use the wine chiller for the first time or restart the wine chiller after having been shut off for a long time, there could be a few degrees variance between the temperature you select and the one indicated on the LED readout. This is normal and it is due to the length of the activation

time. Once the wine chiller is running for a few hours everything will be back to normal.



→ **Storage Capacity**

Model SWC1600M-1: You can place 16 standard bottles in this wine chiller.

Models SWC2800M-1 / SWC2801: You can place 28 standard bottles in this wine chiller.

Many bottles may differ in size and dimensions. As such the actual number of bottles you may be able to store may vary. Bottle capacities are approximate maximums when storing traditional Bordeaux 750ml bottles and include bulk storage.

→ **Interior Light**

You can turn the interior light ON or OFF by pushing the button marked with the “Light” symbol . The light will be turned off automatically if it remains ON for 10 minutes. You have to push the button marked with the “Light” symbol  again and the light will turn back on.

CARE AND MAINTENANCE

→ **Cleaning Your Wine Chiller**

- UNPLUG the Wine Chiller, and remove all items including shelves.
- Wash the inside surfaces with a warm water and baking soda solution. The solution should be about 2 tablespoons of baking soda to a quart of water.
- Wash the shelves with a mild detergent solution.
- Wring excess water out of the sponge or cloth when cleaning area of the controls, or any electrical parts.
- Wash the outside cabinet with warm water and mild liquid detergent. Rinse well and wipe dry with a clean soft cloth.

CAUTION

Failure to unplug the Wine Chiller could result in electrical shock or personal injury.

→ **Power Failure**

- Most power failures are corrected within a few hours and should not affect the temperature of your appliance if you minimize the number of times the door is opened. If the power is going to be off for a longer period of time, you need to take the proper steps to protect your contents.

→ **Moving Your Wine Chiller**

- Remove all bottles.
- Securely tape down all loose items (shelves) inside your appliance.
- Tape the door shut.
- Protect outside of appliance with a blanket, or similar item.



→ **Energy Saving Tips**

- The Wine Chiller should be located in the coolest area of the room, away from heat producing appliances, and out of the direct sunlight.
- One characteristic of superconductor units is the length of time it requires to recover from having the door opened and shut frequently. It may be necessary to wait longer for the temperature to return to its former level once the door has been opened for too long. This is normal for this type of unit.

PROBLEMS WITH YOUR WINE CHILLER?

You can solve many common Wine Chiller problems easily, saving you the cost of a possible service call. Try the suggestions below to see if you can solve the problem before calling the servicer.

TROUBLESHOOTING GUIDE

PROBLEM	POSSIBLE CAUSE
Wine Chiller does not operate.	Not plugged in. The circuit breaker tripped or a blown fuse.
Control panel is locked	Push the  and  button simultaneously for 3 seconds to unlock the control panel. Wait for beep sound.
Wine Chiller is not cold enough.	Check the temperature control setting. External environment may require a higher setting. The door is opened too often. The door is not closed completely. The door gasket does not seal properly. The Wine Chiller does not have the correct clearances. Abnormal voltage.
The light does not work.	Not plugged in. The circuit breaker tripped or a blown fuse. The light button is "OFF".
Vibrations.	Check to assure that the Wine Chiller is level.
The door will not close properly.	The Wine Chiller is not level. The door was not properly installed. The gasket is dirty. The shelves are out of position.

SERVICE FOR YOUR WINE CHILLER

We are proud of our customer service organization and the network of professional service technicians that provide service on your Avanti appliances. With the purchase of your Avanti appliance, you can have the confidence that if you ever need additional information or assistance, the Avanti Products Customer Service team will be here for you. Just call us toll-free.

AVANTI PRODUCTS CUSTOMER SERVICES

Product Information 800-323-5029	Whatever your questions are about our products, help is available.
Part Orders 800-220-5570	You may order parts and accessories that will be delivered directly to your home by personal check, money order, Master Card, or Visa.
In-Home Repair Service 800-220-5570	An Avanti Products authorized service center will provide expert repair service, scheduled at a time that is convenient for you. Our trained servicers know your appliance inside and out.

WIRING DIAGRAM

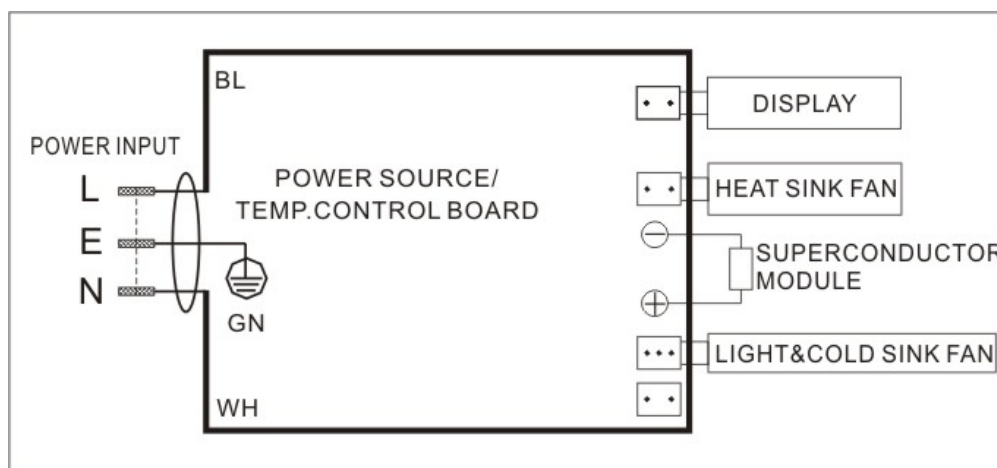

TECHNICAL / ELECTRICAL SPECIFICATIONS

Rated Voltage	115V
Rated Frequency	60Hz
Rated Input Power	83W

YOUR AVANTI PRODUCTS WARRANTY	Staple your sales receipt here. Proof of original purchase date is needed to obtain service under warranty.
<u>WHAT IS COVERED – LIMITED ONE-YEAR WARRANTY</u>	
<p>Avanti Products warrants that the product is free from defects in materials and/or workmanship for a period of twelve (12) months from the date of purchase by the original owner. The foregoing timeline begins to run upon the date of purchase, and shall not be stalled, tolled, extended, or suspended for any reason whatsoever unless described in detail in the warranty document. For one year from the date of purchase by the original owner, Avanti products will, at its option, repair or replace any part of the product which proves to be defective in material or workmanship under normal use. Avanti Products will provide you with a reasonably similar product that is either new or factory refurbished. During this period Avanti Products will provide all parts and labor necessary to correct such defects free of charge, so long as the product has been installed and operated in accordance with the written instructions in this manual. In rental or commercial use, the warranty period is 90 days. All Avanti appliances of 3.5 cubic feet capacity or less must be brought/sent to the appliance service center for repair.</p>	
<u>WARRANTY EXCLUSIONS / WHAT IS NOT COVERED:</u>	
<p>The warranty coverage described herein excludes all defects or damage that are not the direct fault of Avanti Products, including without limitation, one or more of the following:</p>	
<ul style="list-style-type: none"> • A failure to comply with any applicable state, local, city, or county electrical, plumbing and/or building codes, regulations, or laws, including failure to install the product in strict conformity with local fire and building codes and regulations. • Any external, elemental and/or environmental forces and factors, including without limitation, rain, wind, sand, floods, fires, mud slides, freezing temperatures, excessive moisture or extended exposure to humidity, lightning, power surges, structural failures surrounding the appliance, and acts of God. 	
<ul style="list-style-type: none"> • Content losses of food or other content due to spoilage. • Incidental or consequential damages • Parts and labor costs for the following will not be considered as warranty: <ul style="list-style-type: none"> • Evaporator doors, door springs, and/or frames. • Inner door panels, door shelves, door rails, and/or door supports. • Chest freezer lid liners. • Vegetable crispers. • Light bulbs and/or plastic housing. • Plastic cabinet liners. • Punctured evaporator that voids the warranty on the complete sealed system. 	<ul style="list-style-type: none"> • Shipping and handling costs associated with the replacement of the unit. • Repairs performed by unauthorized servicers. • Service calls that are related to external problems, such as abuse, misuse, inadequate electrical power, accidents, fire, floods, or any other acts of God. • Failure of the product if it is used for other than its intended purpose. • The warranty does not apply outside the Continental USA. • Surcharges including but not limited to, any after hour, weekend, or holiday service calls, tolls, ferry trip charges, or mileage expense for service calls to remote areas.
<p>In no event shall Avanti Products have any liability or responsibility whatsoever for damage to surrounding property, including cabinetry, floors, ceilings, and other structures and/or objects around the product. Also excluded from this warranty are scratches, nicks, minor dents, and other cosmetic damages on external surfaces and exposed parts; Products on which the serial numbers have been altered, defaced or removed; service visits for customer education, or visits where there is nothing wrong with the product; correction of installation problems (you are solely responsible for any structure and setting for the product, including all electrical, plumbing and/or other connecting facilities, for proper foundation/flooring, and for any alterations including without limitation cabinetry, walls, floors, shelving etc., as well as the resetting of breakers or fuses.</p>	
<u>OUT OF WARRANTY PRODUCT</u>	
<p>Avanti Products is under no obligation, at law or otherwise, to provide you with any concessions, including repairs, pro-rates, or product replacement, once this warranty has expired.</p>	
<small>WARRANTY – REFRIGERATION – NON COMPRESSOR</small>	

INSTRUCCIONES DE SEGURIDAD

ATENCION

INSTRUCCIONES PARA LA CONEXION A TIERRA

Este aparato electrodoméstico debe estar conectado a tierra. En caso de un cortocircuito eléctrico, la conexión a tierra reduce el riesgo de choque eléctrico proporcionando un cable a tierra con una enchufe de conexión a tierra. Este enchufe debe estar conectado en un tomacorriente instalado correctamente y conectado a tierra.

ADVERTENCIA – El uso inadecuado del enchufe de conexión a tierra puede resultar en un riesgo de choque eléctrico. Consulte con un electricista o persona de reparaciones competente si no comprenden bien las instrucciones de conexión a tierra o si existe alguna duda sobre si el aparato esta conectado a tierra correctamente.

NO USE UN CORDON DE PROLONGACION ELECTRICA

Use un tomacorriente de pared exclusivo. No conecte su vinera a cordones de prolongación eléctrica o junto a cualquier otro electrodoméstico en el mismo tomacorriente de pared.

ADVERTENCIA IMPORTANTE:

Una vinera vacía es una atracción muy peligrosa para los niños. Saque todas las juntas, pestillos, tapas o puerta de todo electrodoméstico que no esté en uso, o tome alguna medida para asegurar que no presente peligro.

INSTRUCCIONES DE INSTALACION

Saque los embalajes exteriores, limpie bien el exterior con un paño suave seco, y el interior con un paño húmedo y tibio. Evite colocar la vinera cerca de una fuente de calor, luz de sol directa, o lugar húmedo.

Ubicación

1. Seleccione un lugar con su piso fuerte y nivelado.
2. Deje cinco pulgadas de espacio entre la parte posterior de la vinera y toda pared contigua.
3. Las bodegas superconductores necesitan cierto tiempo de recuperación cuando la puerta se abre y se deja abierta por mucho tiempo. Esto es normal para este tipo de unidad.
4. Evite la luz directa del sol o calor. La luz directa del sol puede afectar la capa de acrílico. Las fuentes de calor en su proximidad provocarán un consumo mayor de electricidad.
5. Para un mejor desempeño, nivele la vinera utilizando las patas ajustables o tornillos niveladores.

OPERACION

Para evitar vibraciones, el compartimiento interior debe estar bien nivelado. La temperatura variará dependiendo de la cantidad de botellas almacenadas y la frecuencia con que se abre la puerta.

Cuando la vinera no se use por un período largo, desconecte el enchufe y deje la puerta entreabierta.

CONTROL DE TEMPERATURA:

Se recomienda que Ud coloque su vinera en un lugar donde la temperatura ambiental se mantenga entre 23°-26°C / 72°-78°F.

Si la temperatura ambiental oscila fuera de esos límites, pueda afectar la temperatura de la unidad. Por ejemplo, si su unidad está situada en lugares donde hay temperaturas muy frías o calientes también puede afectar la temperatura de la unidad y no alcanzará los límites 8°-18°C/46°-65°F).

Temperaturas recomendadas para enfriar vinos:

Vinos rojos	14° - 18° C	57 – 65° F
Vinos blancos	9° - 14° C	49 – 58° F
Vinos tintos	10° - 11° C	51 – 53° F
Vinos espumantes	5° - 9° C	40 – 49° F

Rango de Temperatura de su vinera

Rango De Temperatura	8 - 18° C	46 – 64° F
----------------------	-----------	------------

Panel de controles



Control de temperatura

El panel de control de su vinera se anulará automáticamente 12 segundos después que cualquier botón haya sido presionado.

Para activar el panel de control de su vinera, presione simultáneamente los botones marcados y por 3 segundos. Espere por el sonido.

Ud. se puede seleccionar la temperatura preferida presionando los botones marcados

o . Cuando Ud. presione uno de los dos botones por primera vez la temperatura seleccionada originalmente en la factoría aparecerá en la pantalla. (12°C / 54°F).

La temperatura que Ud. selecciona subirá 1°C/F cada vez que presione el botón marcado al contrario la temperatura bajará 1°C/F cada vez que presione el botón marcado .

AVISO:

Cuando Ud. encienda su vinera por primera vez o después de un largo tiempo de estar apagado, habrá una diferencia entre la temperatura que Ud. selecciona y la temperatura indicada en la pantalla digital. Este situación es normal debido al tiempo de que estuvo apagado. En cuanto la unidad esté encendida por un par de horas la temperatura volverá a su nivel normal.

Luz interior

Ud. puedes encender o apagar la luz interior presionando el botón marcado . La luz interior se apagará automáticamente si está encendida por 10 minutos seguidos. Ud. necesita presionar el botón de nuevo para encender la luz.

CUIDADO Y MANTENIMIENTO

Capacidad

Modelo: SWC1600M-1: 16 botellas de tamaño normal (standard)

Modelos: SWC2800M-1 / SWC2801: 28 botellas de tamaño normal (standard)

El tamaño de las botellas pueden variar y afectará la cantidad de botellas que Ud. puede almacenar.

Limpieza

Para limpiar el interior, use un paño suave con una solución de una cucharada de bicarbonato de sodio por cada cuarto de agua, o una solución de espuma de jabón suave, o un detergente suave. Para lavar las rejillas, sáquelas deslizándolas con cuidado, y use una solución de detergente suave; luego séquelas con un paño suave. Limpie el exterior con un paño húmedo suave y un poco de detergente suave o productos de limpieza para electrodomésticos.

Corte de corriente

La mayoría de los cortes de corriente se corrigen en una o dos horas y no afectarán las temperaturas de su vinera. Sin embargo, Ud. deberá reducir la cantidad de veces que abra la puerta cuando la corriente esté apagada. Durante los cortes de corriente de larga duración, tome medidas para proteger sus botellas de vino.

Si Ud. se muda

Saque o asegure todos los artículos dentro de su vinera. Para evitar que los tornillos nivelantes se averíen, gírelos completamente hacia la base.

Algunas reglas importantes para el uso correcto de la vinera.

- Las bebidas deben guardarse en botellas cerradas.
- No sobrecargue el compartimiento interior.
- No abra la puerta a menos que sea necesario.

Nunca cubra los estantes del compartimiento para vinos con papel de aluminio o cualquier otro material para cubrir estantes que puedan obstruir la circulación del aire.

Registration Information

Thank you for purchasing this fine Avanti product. Please fill out this form and return it to the following address within 100 days from the date of purchase and receive these important benefits:

Avanti Products, A Division of The Mackle Co., Inc.
P.O.Box 520604 – Miami, Florida 33152

→ **Protect your product:**

We will keep the model number and date of purchase of your new Avanti product on file to help you refer to this information in the event of an insurance claim such as fire or theft.

→ **Promote better products:**

We value your input. Your responses will help us develop products designed to best meet your future needs.

------(detach here)-----

Avanti Registration Card

Name	Model #	Serial #
Address	Date Purchased	Store / Dealer Name
City State Zip	E-mail Address	
Area Code Phone Number	Occupation	
Did You Purchase An Additional Warranty	As your Primary Residence, Do You:	
≤ Extended	≤ Own	≤ Rent
≤ None		
Reason for Choosing This Avanti Product: Please indicate the most important factors That influenced your decision to purchase this product:	Your Age:	
≤ Price	≤ under 18 ≤ 18-25 ≤ 26-30	
≤ Product Features	≤ 31-35 ≤ 36-50 ≤ over 50	
≤ Avanti Reputation	<u>Marital Status:</u>	
≤ Product Quality	≤ Married ≤ Single	
≤ Salesperson Recommendation	<u>Is This Product Used In The:</u>	
≤ Other: _____	≤ Home ≤ Business	
≤ Friend / Relative Recommendation	<u>How Did You Learn About This Product:</u>	
≤ Warranty	≤ Advertising	
≤ Other: _____	≤ In-Store Demo	
Comments:	≤ Personal Demo	

SW1600M-1/2800M-1/2801 VER 1.0 9111

PRINTED IN CHINA

Free Manuals Download Website

<http://myh66.com>

<http://usermanuals.us>

<http://www.somanuals.com>

<http://www.4manuals.cc>

<http://www.manual-lib.com>

<http://www.404manual.com>

<http://www.luxmanual.com>

<http://aubethermostatmanual.com>

Golf course search by state

<http://golfingnear.com>

Email search by domain

<http://emailbydomain.com>

Auto manuals search

<http://auto.somanuals.com>

TV manuals search

<http://tv.somanuals.com>