



IP Office

Installation Manual

40DHB0002USCL – Issue 7 (09/25/2002)

Contents

Introduction	5
General	5
Scope of Manual	5
Safety and Homologation Statements	6
Lithium Batteries	6
Electromagnetic Interference Information	6
Federal Communications Commission (FCC)	6
Canadian Department of Communications (DOC)	6
89/336/ EEC (EMC Directive) CISPR 22:1993 including A1 + A2, AS/NZ 3548:1995 (ROW)	6
Trunk Interface Modules	7
ROW	7
USA/Canada	7
Further Information and Product Updates	7
Support Telephone Numbers	7
Regulatory Instructions for Use	8
IP Office Operation in Australia	8
IP Office Operation in Canada	8
IP Office Operation in EU	9
IP Office Operation in New Zealand	9
IP Office Operation in USA	9
IP401 Compact Office Platform	10
General	10
IP401 Compact Office - Front View	11
Port connections	11
IP401 Compact Office - Rear View	12
Port connections	12
Typical Configuration	13
IP403 Office Platform	14
General	14
Expansion Modules	14
Integral Modules	14
IP403 Office - Front View	15
Port connections	15
IP403 Office - Rear View	16
Port connections	16
Typical Configuration	17
IP406 Office Platform	18
General	18
Expansion Modules	18
Integral Modules	18
IP406 Office - Front View	19
Port connections	19
IP406 Office - Rear View	20
Port connections	20
Typical Configurations	21
IP412 Office Platform	22
General	22
Expansion Modules	22
Integral Modules	22
IP412 Office - Front View	23
Port connections	23
IP412 Office - Rear View	24
Port connections	24
Typical Configurations	25

Contents (Cont.)

Expansion Modules	27
IP400 Digital Terminal 16/30.....	27
Front View (30 Port version).....	27
Rear View (all versions).....	27
IP400 Digital Stations 16/30.....	28
IP400 Phone 8/16/30.....	28
Front View (30 port version).....	28
Rear View (all versions).....	28
IP400 So8.....	29
Front View.....	29
Rear View.....	29
IP400 WAN3.....	30
Front View.....	30
Rear View.....	30
IP400 Analog Trunk 16.....	31
Front View.....	31
Rear View.....	31
Country Variants	32
IP400 Office Systems.....	32
Integral Module Kits.....	33
Trunk Module Kits.....	33
Power Supplies.....	33
IP Office Rack Mounting Kits.....	34
Expansion Modules.....	34
Preparing for Installation	35
Introduction.....	35
Tools & Parts Required.....	35
Space requirements.....	35
Environmental requirements.....	36
Power Supply requirements.....	36
Grounding.....	37
Protective Ground.....	37
Functional Ground.....	37
Installing a New System	38
Unpacking.....	38
Initial Assembly.....	38
Installation of Integral Modules.....	39
Rack Mounting Assembly Instructions.....	42
IP401 Compact Office Wall Mounting.....	43
IP401 Expansion and Installation of Integral Modules.....	44
Basic System Programming	45
Introduction.....	45
Programming Tools.....	45
PC to IP Office LAN Port Connection.....	45
Initial Programming.....	46

Contents (Cont.)

Telephone Installation	46
Checking Telephones	47
Connecting & Testing IP Office Telephones.....	47
Connecting & Checking Two-Wire Telephones.....	47
Power Fail Telephones and Sockets.....	47
Wall Mounting 2000 Series Telephones	48
Wall Mounting 44/4600 & 6400 Series Telephones.....	49
System Handover	50
Checklist	50
Technical Data	51
Port Pinouts	51
Analog Trunk Ports (RJ45).....	51
Power Fail and POT Ports (RJ45).....	51
DS/DT Ports (RJ45).....	51
ISDN Port – BRI (RJ45).....	51
ISDN Port – PRI (RJ45).....	52
LAN Port – 10/100 BaseT.....	52
DTE Port (25 Way or 9 Way D-Type socket).....	52
Audio Port (3.5mm Stereo Jack Socket)	53
Expansion Port (RJ45 Socket)	53
External Control Port (3.5mm Stereo Jack Socket).....	53
WAN Port (37 Way D-Type Socket)	54
Cables.....	55
DTE Cable.....	55
DT Line Cord for Structured Cabling.....	56
PRI/BRI ISDN Cable.....	57
LAN Interconnect Cable	58
LAN Cable	59
LAN Crossover Cable.....	60
Expansion Interconnect Cable.....	61
V.24/V.28 WAN Cable	62
X.21 WAN Cable	63
V.35 WAN Cable	64
Telephone Converter Cables.....	65
Out of Building Installation.....	65
Port Safety Classification	66
Compliance with FCC Rules.....	66
Technical Specifications	67
General.....	67
Interfaces.....	67
Protocols.....	68
Index	69

Introduction

General

This manual covers the installation of your Avaya IP Office equipped with release Level 1.0+ software. It is intended for use by installers and maintainers who have successfully completed the appropriate IP Office training courses.



Ensure that you have read and understood this manual before beginning installation.

Scope of Manual

This manual, for IP Office systems only, covers the following areas:

– **Technical Data :**

This manual contains information on the Port Pinouts/Safety classifications, cables, and basic technical specifications only. Descriptions of the functionality, features and performance of the IP Office are covered by the Product Description.

– **Rack Installation :**

You can install your IP403/406/412 Office (base units and expansion modules) into a suitable rack system (see page 42). The IP401 Compact Office can be wall mounted (see page 43).

– **System Programming :**

System programming is necessary for installation and maintenance of the IP Office. This manual only covers very basic programming (see page 45). For full details refer to the Administration Help files contained on the Installation CD supplied with every unit.

– **Terminal/Telephone Usage :**

This manual does not detail the usage and functionality of IP Office terminals/telephones. These details are to be found in the appropriate User Guides.

The terminals/telephones that are supported by the IP Office are:

Avaya 2000 Series	20AT, 20CC, 2010, 2030, 2050, (analog only), 20DSS/BLF and 20DT
Avaya 4400 Series	4406D, 4412D, 4424D and 4450DSS*
Avaya 4600 Series	4606 (Level 1.1+ only), 4612 and 4624
Avaya 6400 Series	6408D+, 6416D+M, 6424D+M and XM24(DSS)

***Caution:** See page 56 for wiring details on a 4450DSS module.

Safety and Homologation Statements

CE Mark

The "CE" mark affixed to this equipment means that the unit complies with the 1999/5/EC (R&TTE), 89/336/EEC (EMC) and 72/23EEC (LVD) Directives

Declaration of Conformity

The Declaration of Conformity (DoC) for the IP400 Office products is contained within the CD accompanying the products.



This warning symbol may be found on the base of IP401, IP403, IP416 and IP412 units. Refer to page 7 for information concerning which Trunk Interface module variants can be fitted in which country

WARNING

The Avaya IP400 Office units are intended to be installed by 'Service Personnel' and it is the responsibility of the Service Personnel to ensure that all subsidiary interconnected equipment is wired correctly and also meet the safety requirements of IEC60950 or UL60950 where applicable.

Lithium Batteries

A lithium battery is fitted to the real time clock on the IP401/403/406 and IP412 mother boards.

WARNING

The Lithium battery must be replaced by Avaya personnel or authorized representatives. There is a danger of explosion if the battery is incorrectly replaced. Replace only with the same or equivalent type recommended by the manufacturer. Dispose of used batteries according to the manufacturer's instructions.

Electromagnetic Interference Information

Federal Communications Commission (FCC)

This equipment has been tested and found to comply with the limits for a Class A digital device, pursuant to Part 15 of the FCC Rules. These limits are designed to provide reasonable protection against harmful interference when the equipment is operated in a commercial environment. This equipment generates, uses, and can radiate radio frequency energy and, if not installed and used in accordance with the instruction manual, may cause harmful interference to radio communications. Operation of this equipment in a residential area is likely to cause harmful interference, in which case the user will be required to correct the interference at his or her own expense.

Canadian Department of Communications (DOC)

"NOTICE: This equipment meets the applicable Industry Canada Terminal Equipment Technical Specifications. This is confirmed by the registration number. The abbreviation, IC, before the registration number signifies that registration was performed based on a Declaration of Conformity indicating that Industry Canada technical specifications were met. It does not imply that Industry Canada approved the equipment."

89/336/ EEC (EMC Directive) CISPR 22:1993 including A1 + A2, AS/NZ 3548:1995 (ROW)

WARNING

IP401 Compact Office, IP403, IP406, IP412 and all Expansion Modules are Class A products. In a domestic environment, IP401 Compact Office, IP403, IP406, IP412 and all Expansion Modules may cause radio interference in which case the user may be requested to take adequate measures.

Trunk Interface Modules

ROW

To ensure the validation of the approvals in ROW (i.e. EU, Hungary, Australia and New Zealand), only the following interface cards must be installed as detailed in the following IP400 Office products:

Product	Interface Modules					
	Quad BRI	PRI-E1 PRI E1-R2*	PRI-T1	Analog Trunk 4 (LS)	Dual PRI-E1 Dual PRI-E1-R2*	Dual PRI-T1
IP403 Office DT	Yes	Yes	No	Yes	No	No
IP403 Office DS	Yes	Yes	No	Yes	No	No
IP406 Office	Yes	Yes	No	Yes	No	No
IP412 Office	Yes	Yes	No	Yes	Yes	No

* CALA /Korea only

USA/Canada

To ensure the validation of the approvals in US and Canada, only the following interface cards must be installed in the following IP400 Office products:

Product	Interface Cards					
	Quad BRI	PRI-E1	PRI-T1	Analog Trunk 4 (LS)	Dual PRI-E1	Dual PRI-T1
IP403 Office DT	No	No	No	No	No	No
IP403 Office DS	No	No	Yes	Yes	No	Yes
IP406 Office	No	No	Yes	Yes	No	Yes
IP412 Office*	No	No	Yes	Yes	No	Yes

See page 33 for country specific variant SAP codes.

Further Information and Product Updates

Further information, including Product and Reference Manual updates, can be obtained from Avaya's Dealers and Distributors, or from Avaya's web site: <http://www.avaya.com>.

This guide is also available from Avaya's support web site: <http://support.avaya.com>

Support Telephone Numbers

In the USA only, Avaya provides a toll-tree Customer Helpline 24 hours a day:

Name: Avaya Technical Support Organization (TSO)

Customer Helpline: 1 800 628-2888

Address: 8744 Lucent Blvd., Highlands Ranch, Colorado, 80129 USA

URL: <http://support.avaya.com/>

If you need assistance when installing, programming, or using your system, call the Helpline or your Avaya representative. Consultation charges may apply.

Outside the USA, if you need assistance when installing, programming, or using your system, contact your Avaya representative.

Regulatory Instructions for Use

IP Office Operation in Australia

Connection

Connection of IP400 Office products must be via a Line Isolation Unit with a telecommunications compliance label.

BRI Interface

During the configuration, ensure "000" emergency number is not barred, by performing the following:

Short Code: "000"
Telephone No.: "000;"
Function: "Dial Emergency"

Connections to TS013, the following Bearer Capabilities shall not be used:

7kHz Audio
Video
Restricted Digital Information

If unknown type of number is used in calling party number, the network will use the default CLI.

The system must be configured for Point to Multi point connection to comply with Austel requirements for connecting to TS013 circuits.

As the IP Office does not support emergency dialing after loss of power, the following warning notice should be recognized:

WARNING

This equipment will be inoperable when mains power fails.

PRI Interface

During the configuration, ensure "000" emergency number is not barred, by performing the following:

Short Code: "000"
Telephone No.: "000;"
Function: "Dial Emergency"

WARNING

This equipment will be inoperable during mains power failure.

IP Office Operation in Canada

Industry Canada Notification (DoC)

This equipment meets the applicable Industry Canada Terminal Equipment Technical Specifications. This is confirmed by the registration number. The abbreviation, IC, before the registration number signifies that registration was performed based on a Declaration of Conformity indicating that Industry Canada technical specifications were met.

It does not imply that Industry Canada approved the equipment.

"NOTICE: The Ringer Equivalence Number (REN) for this terminal equipment is 1. The REN assigned to each terminal equipment provides an indication of the maximum number of terminals allowed to be connected to a telephone interface. The termination on an interface may consist of any combination of devices subject only to the requirement that the sum of the Ringer Equivalence Numbers of all the devices does not exceed five."

IP Office Operation in EU

1. 999 and 112 calls must not be barred. Doing so will invalidate the approval.
2. All connections at the MDF shall be identifiable by suitable labeling.
3. The CE mark displayed on IP Office equipment indicates the systems compliance with the EMC, LVD, and R&TTE Directives and common technical regulations for Primary Rate and Basic Rate ISDN.
4. All ports for the connection of other non-telecommunications apparatus have a Safety Extra Low Voltage (SELV) safety status.

IP Office Operation in New Zealand

The grant of a Telepermit for any item of terminal equipment indicates only that Telecom has accepted that the item complies with minimum conditions for connection to its network. It indicates no endorsement of the product by Telecom, nor does it provide any sort of warranty. Above all, it provides no assurance that any item will work correctly in all respects with another item of Telepermitted equipment of a different make or model, nor does it imply that any product is compatible with all of Telecom's network services.

IP Office Operation in USA

FCC Notification

This equipment is registered with the ACTA (Administrative Council for Terminal Attachments) in accordance with FCC Part 68 of its rules. In compliance with those rules, you are advised of the following:

- **Means of Connection.** Connection of this equipment to the telephone network shall be through a standard network interface jack. Connection to 1.544-Mbps digital facilities must be through a USOC RJ48C. Connection to the Analog Trunk facilities must be through a USOC RJ45S.
- **Notification to the Telephone Companies.** Before connecting this equipment, you or your equipment supplier must notify your local telephone company's business office of the telephone number or numbers you will be using with this equipment.
- **The facility interface codes (FIC)** for 1.544-Mbps digital connection (i.e. IP400 Office PRI-T1) are 04DU9.BN, 04DU9.DN, 04DU9.IKN, 04DU9.ISN.
- **The facility interface code (FIC)** for analog trunk connection (i.e. IP400 Office Quad Analog Trunk-LS) are OL13A, OL13B, OL13C, 02AC2, 02LA2, 02LB2, 02LC2, 02LR2, 02LS2.
- **The facility interface code (FIC)** for analog trunk connection (i.e. IP400 Office ATM16-LS/GS) are OL13A, OL13B, OL13C, 02AC2, 02GS2, 02LA2, 02LB2, 02LC2, 02LR2, 02LF2.
- **The Service Order Code (SOC)** for 1.544-Mbps digital connection (i.e. IP400 Office PRI-T1) is 6.0Y
- **The Service Order Code (SOC)** for analog trunk connection (i.e. IP400 Office Quad Analog Trunk-LS) is 9.0Y
- **Disconnection.** You must also notify your local telephone company if and when this equipment is permanently disconnected from the line or lines.
- **Hearing Aid Compatibility.** The custom telephone sets for this system are compatible with inductively coupled hearing aids as prescribed by the FCC.

Ringer Equivalence Number (REN). The REN is used to determine the number of devices that may be connected to the telephone line. Excessive RENs on the line may result in the devices not ringing in response to an incoming call. In most, but not all, areas, the sum of the RENs should not exceed five. To be certain of the number of devices that may be connected to the line, as determined by the total RENs, contact the local telephone company to determine the maximum REN for the calling area.

IP401 Compact Office Platform

General

The IP401 Compact Office system platform is supplied in two variants:

IP401 Compact Office 2 supports:

Two digital and two analog telephones

A BRI ISDN port (2 trunks)

An four port auto-negotiating 10/100 BaseT LAN hub

IP401 Compact Office 4 supports:

Four digital and four analog telephones

Two BRI ISDN ports (4 trunks)

An eight port auto-negotiating 10/100 BaseT LAN hub.

The auto-negotiating 10/100 BaseT LAN hub provides access to networks and/or up to eight IP telephones.

The DT ports support Avaya 2000 series telephones. DT ports are set to A-Law PCM encoding at default but can be programmed to μ -Law PCM encoding.

An IP401 Compact Office 2 can be expanded to an IP401 Compact Office 4.

In addition the IP401 Compact Office can be fitted with any of the following optional Integral Modules:

- **WAN Port**

This port supports a single synchronous data connection, which can be X.21, V.35 or V.24.

- **Voice Compression Module (VCM)**

Supports VoIP applications (over two channels) using Avaya 4600 IP telephone connected via LAN ports.

- **VME card**

Provides memory capacity for embedded voice mail feature.

See page 44 for expansion and page 32 for country specific variants.

IP401 Compact Office - Front View

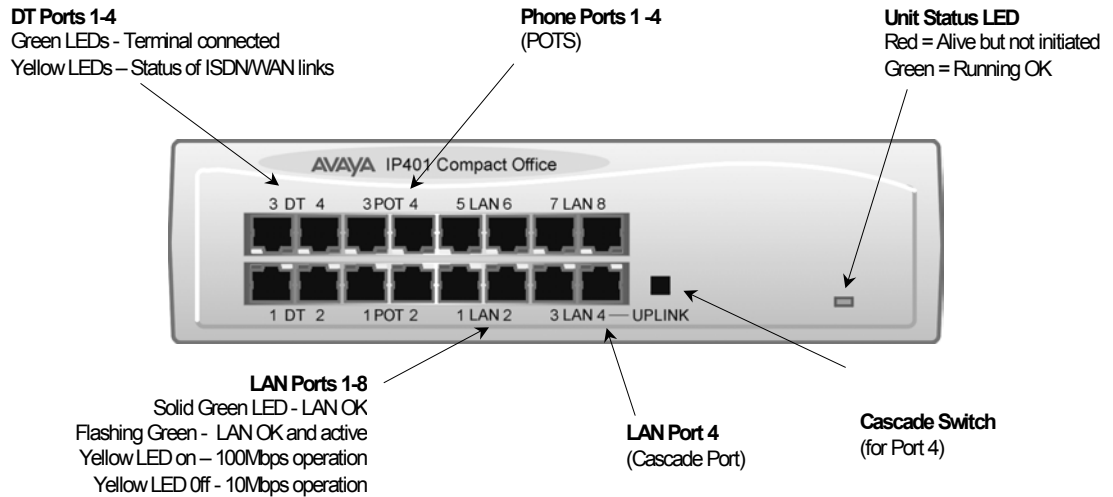

Note: The IP Compact Office DT4 is shown above. The IP Compact Office DT2 does not have the top row (labeled **3 DT 4**, **3 POT 4**, **5 LAN 6** and **7 LAN 8**) of RJ45 ports fitted.

Port connections

- **DT Ports**

DT ports are used for connection to Avaya 2000 series telephones (see page 5) and support either A-Law or μ -Law PCM encoding (default A-Law). Using DT Line Cords (see page 56) and standard structured wiring, these RJ45 ports can be extended to the required telephone location. In addition, converters can be used to provide BT New Plan sockets (431A/631A) if required (see page 65). When telephones are equipped with line cords that terminate in RJ11 plugs, then pin-to-pin RJ11/RJ45 adapters should be used.

- **Plain Ordinary Telephone (POT) Ports**

These ports are used for connection to standard analog telephones, fax machines and modems. Using standard structured wiring, these RJ45 ports can be extended to the required telephone location. Converters can be used to provide BT New Plan sockets (431A/631A) if required (see page 65). When telephones are equipped with line cords that terminate in RJ11 plugs, then pin-to-pin RJ11/RJ45 adapters should be used.

- **LAN Ports**

The auto-negotiating 10/100 BaseT LAN hub ports are used for PC and server connectivity. They can also be used to connect to IP telephones (Avaya 4600 IP series).

LAN ports allow information relating to incoming and outgoing telephone calls to be forwarded to PC based applications. They also provide access to the router functionality/configuration of the IP401 Compact Office platform for both data and Voice over IP (VoIP) calls. The auto-negotiating 10/100 BaseT LAN hub ports support a single MAC address only (printed on base of unit).

Where more than eight LAN connections are required, the fourth LAN port can be used for cascading to other hubs. The **Cascade** pushbutton to the right of this port is used to set the mode. When the **Cascade** switch is in the *out* position the port can be connected to another hub without the need for a crossover cable, i.e. the port is an MDI type port. When the **Cascade** switch is in the *in* position the port can be connected directly to a PC.

Cables

IP401 Compact Office 2 is supplied with one red ISDN cable. The Compact Office 4 is supplied with two red ISDN cables. For Port Pinouts and Cables, refer to pages 51 and 55 respectively.

IP401 Compact Office - Rear View

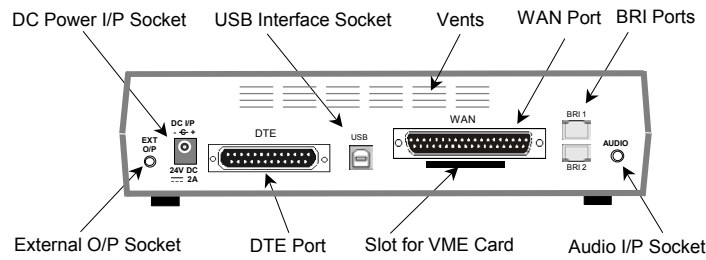

- Notes:**
1. The IP401 Compact Office 4 is shown above; the WAN port is optional.
 2. On an IP401 Compact Office 2, the WAN port is optional and BRI 2 is not fitted. (See pages 32 and 44 for upgrade kits and expansion instructions respectively).
 3. The IP401 Compact Office can be wall mounted (see page 43).

Port connections

- **External O/P Socket**
Allows externally powered circuits to be controlled via a single 3.5mm stereo jack socket.
- **DC Power I/P Socket**
Socket for the external 24V DC unregulated power supply (supplied with kit).
- **DTE Port**
A 25-way D-type socket. Used for connection to PCs, servers and EFTPOS terminals.
- **BRI Ports**
Two BRI trunk interface ports are fitted on an IP401 Compact Office 4 and only one on an IP401 Compact Office 2; providing four and two trunks respectively.
See page 44 for expansion and page 32 for country specific variants.
- **WAN Port**
This port supports a single synchronous data connection, which can be X.21, V.35 or V.24. The selection of the required interface is automatically determined from the pin-out of the cable plugged into the 'WAN' port. This cable **must be** connected before power is applied for auto detection to work. Connection to a Digital Leased Circuit is made by connecting the WAN port on the rear of the unit to the existing Network Terminating Unit (NTU) via the appropriate X.21, V.35 or V.24 cable.
See pages 62, 63 and 64 for cable details and page 54 for port details.
- **USB Interface**
This port may only be used by trained maintenance personnel using static protection precautions. Used for connection to a PC or server, allowing it to utilize the IP401 Office as a Terminal Adapter (TA). (Before installing the USB software on your PC **you must read** the instructions supplied with the installation software - refer to the USB Installation Manual for details).
- **Audio I/P Socket**
A single 3.5mm stereo or mono jack socket that enables input from an external 'Music-on-Hold' source.

Port Pinouts and Cables

For Port Pinouts and Cables, refer to pages 51 and 55 respectively.

Typical Configuration

Scenario:

A customer requiring a voice and data solution for a warehousing facility remote from a regional office. Three administrators and two pickers staff the warehouse.

This configuration provides support for four Avaya 2000 series digital telephones, one for each of the administrators, leaving a spare port for future growth. Up to four analog telephones (POTS), two of which support a DECT wireless solution to allow the pickers freedom of movement, with one of the remaining ports being used for a fax machine.

The eight port 10/100M Hub allows the local PCs and Printers to be networked. Connectivity for all voice and data traffic between the Warehouse and the regional office is carried over the optional IP401 WAN interface using Voice over IP and standards based compression (through the optional IP400 VCM 5 media card). Two ISDN ports allow up to four simultaneous calls to the public network.

Kit List

IP401 Compact Office DT4

IP401 Compact Office WAN Expansion

IP400 Office Voice Compression Module 5

2 x 2030 Display Terminals

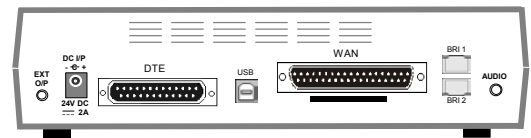
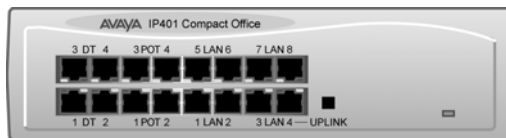

IP403 Office Platform

General

The IP403 Office system platform supports up to eight digital and two analog telephones. This can be expanded, by use of extension modules, to 100 extensions.

Two variants are available and are equipped as follows:

- DT ports - Support Avaya 2000 series telephones.
- DS ports - Support Avaya 6400 and/or Avaya 4400 series telephones.

Both ports can be set for either μ -Law or A-Law PCM encoding. At default DT ports are set to A-Law and DS ports are set to μ -Law. However, these can be switched in software (refer to the Administration Manager Manual for details).

Connection to trunks is via one* of the following integral interface modules:-

Single PRI E1 (30 trunks) or Single PRI T1 (23B+1D or 24B trunks - USA only) or Quad BRI (8 trunks) or Analog 4 (loop start trunks).

If Analog 4 modules are used, a second module can be fitted in Slot A.

See page 39 for installation and page 32 for country specific variants.

An eight port auto-negotiating 10/100 BaseT LAN hub provides access to networks and/or up to eight IP telephones. (Where IP telephones are to be used, the hub should be connected to a suitable switch, e.g. an Avaya Cajun P130.)

Expansion Modules

Optional **Expansion Modules** (see page 27) allow the IP403 Office to be expanded to 100 extensions. These modules (with the exception of the WAN3 – see below) are connected via the Expansion Port sockets that are located on the back of each unit. Up to 3, **in any combination**, of the following Expansion Modules can be supported by the IP403 Office base unit.

- **IP400 Digital Terminal 16/30 or Digital Station 16/30**
Two variants of both (16 or 30 extensions) for digital telephones (see page 27). Hence, if all 3 extension modules are IP400 Digital Terminal/Station 30s, then the maximum of 100 extensions will consist of 90 digital extensions, plus the base unit's 2 analog extensions and 8 digital extensions.
- **IP400 Phone 8/16/30**
Three variants (8, 16 or 30 extensions) for analog telephones (see page 28). Hence, if all 3 extension modules are IP400 Phone 30s, then the maximum of 100 extensions will consist of 90 analog extensions, plus the base unit's 2 analog extensions and 8 digital extensions.
- **IP400 So8**
An S-bus module that provides 8 Basic rate ISDN interfaces (see page 29).
- **IP400 WAN3**
Provides support for a further 3 digital leased line (WAN) connections (see page 30). These expansion modules are connected to the IP403 Office unit via one of the LAN Ports located on the front of each unit.
- **IP400 Analog Trunk 16**
Provides support for up to 16 Loop Start or Ground Start analog trunks (see page 31). Two power fail sockets are also provided.

Integral Modules

In addition the IP403 Office can be fitted with either or both of the following optional Integral Modules (see pages 40 and 41):

- **Voice Compression Module (VCM)**
Supports VoIP applications (e.g. using Avaya 4600 IP series telephones connected via LAN ports). Available in 5, 10 and 20 channel variants.
- **Dual Modem Module**
Allows termination of two simultaneous analog modem calls up to and including 56kbps.

IP403 Office - Front View

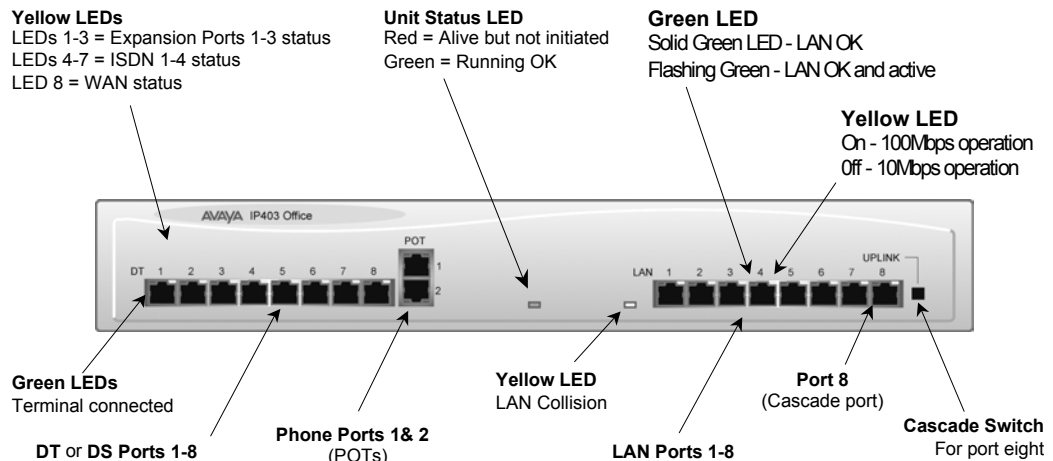

Port connections

• DT/DS Ports

- DT ports are for connection to Avaya 2000 series telephones (see page 5).
- DS ports are for connection to Avaya 4400 and/or 6400 series telephones (see page 5). At default DT ports are set to A-Law PCM encoding and DS ports to either A-Law or μ -Law PCM encoding (see page 32). However, both ports can be switched in software - refer to the Administration Manager Manual for details).

Using DT Line Cords (see page 56) and standard structured wiring, these RJ45 ports can be extended to the required telephone location. In addition, converters can be used to provide BT New Plan sockets (431A/631A) if required (see page 65). When telephones are equipped with line cords that terminate in RJ11 plugs, then pin-to-pin RJ11/RJ45 adapters should be used.

• Plain Ordinary Telephone (POTS) Ports

These two ports are used for connection to standard analog telephones, fax machines and modems. Using standard structured wiring, these RJ45 ports can be extended to the required telephone location. Converters can be used to provide BT New Plan sockets (431A/631A) if required (see page 65). When devices are equipped with line cords that terminate in RJ11 plugs, then pin-to-pin RJ11/RJ45 adapters should be used.

• LAN Ports

The eight auto-negotiating 10/100 BaseT LAN hub ports are used for PC and server connectivity. They can also be used to connect to the optional IP400 WAN3 Expansion Module (see page 30) and IP telephones. LAN ports allow information relating to incoming and outgoing telephone calls to be forwarded to PC based applications. They also provide access to the router functionality/configuration of the IP403 Office platform for both data and Voice over IP (VoIP) calls. (Where IP telephony is required, a suitable switch, i.e. an Avaya Cajun P130, should be used.) This eight port auto-negotiating 10/100 BaseT LAN hub has a single MAC address (printed on the base of the unit).

Where more than eight LAN connections are required, the eighth LAN port can be used for cascading to other hubs. The **Cascade** pushbutton to the right of this port is used to set the mode. When the **Cascade** switch is in the *out* position the port can be connected to another hub without the need for a crossover cable, i.e. the port is an MDI type port. When the **Cascade** switch is in the *in* position the port can be connected directly to a PC.

Cables

IP403 Office DT PRI 30 E1 & DS PRI 24 T1 are supplied with one red ISDN cable. IP403 Office DT BRI 8 & DS Analog 4 are supplied with four red ISDN cables. For Port Pinouts and Cables, refer to pages 51 and 55 respectively.

IP403 Office - Rear View

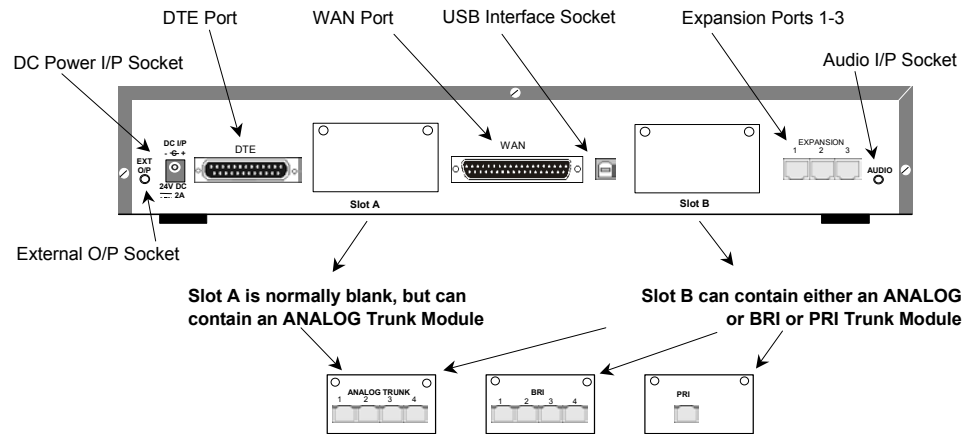

Port connections

- **External O/P Socket**
Two relay ports that allow externally powered circuits to be controlled via a single 3.5mm stereo jack socket.
- **DC Power I/P Socket**
Socket for the external 24V DC unregulated power supply (supplied with equipment).
- **DTE Port**
A 25-way D-type socket. Used for connection to PCs, servers and EFTPOS devices or terminals.
- **BRI/PRI/ANALOG Ports**
The trunk interface modules are fitted into either Slot A or Slot B as follows:
 - Slot A** Quad Analog: 4 trunks (see page 37 for grounding)
 - Slot B** Quad Analog: 4 trunks (see page 37 for grounding)
 - PRI E1/PRI E1-R2: 30 trunks
 - PRI T1: 24B trunks or 23B+1D trunks (see page 37 for grounding)
 - Quad BRI: 8 trunks.

PRI T1 trunks support both ISDN and Analog emulation. The default setting is 23B+1D and is switchable in the installation software to provide 24B trunks.
See page 39 for installation, page 33 for country specific variants and page 37 for grounding.
- **WAN Port**
This port supports a single synchronous data connection, which can be X.21, V.35 or V.24. The selection of the required interface is automatically determined from the pin-out of the cable plugged into the 'WAN' port. This cable **must be** connected before power is applied for auto detection to work. Connection to a Digital Leased Circuit is made by connecting the WAN port on the rear of the unit to the existing Network Terminating Unit (NTU) via the appropriate X.21, V.35 or V.24 cable.
See pages 62, 63 and 64 for cable details and page 54 for port details. *These interfaces are identical to those on the WAN3 Extension Module (see page 30).*
- **USB Interface**
Used for connection to a PC or server, allowing it to utilize the IP403 Office as a Terminal Adapter (TA). (Before installing the USB software on your PC **you must read** the instructions supplied with the installation software - refer to the USB Installation Manual for details).
- **Expansion Ports 1-3**
Used to provide access to the optional **Expansion Modules** (see page 27) which allow the IP403 Office to be expanded to 100 extensions (see page 14).
- **Audio I/P Socket**
A single 3.5mm stereo or mono jack socket that enables input from an external 'Music-on-Hold' source.

Port Pinouts and Cables

For Port Pinouts and Cables, refer to pages 51 and 55 respectively.

Typical Configuration

Scenario:

A customer with sophisticated telephony requirements, needing 30 exchange lines and 80 Display Terminals.

This configuration provides support for 98 Avaya 20 series digital telephones (18 spare for growth) and a single Primary Rate ISDN connection. If growth beyond 18 users or additional line capacity were anticipated, the IP406 Office would be considered more appropriate. Typically, a business of this size would have a data network built using LAN switches such as the Avaya Cajun range. The IP403 Compact Office would be connected to the data network through its integral 8 port Hub, providing all users access to the Internet and IP Office productivity applications.

Kit List

IP403 Office DT PRI 30 E1

3 x IP400 Digital Terminal Module 30

80 x 2030 Display Terminals

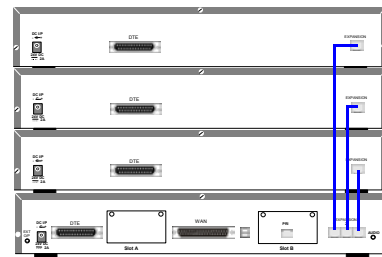
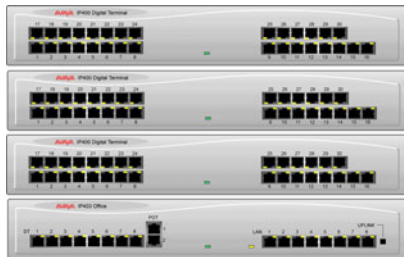

IP406 Office Platform

General

The IP406 Office system platform supports up to 180 extensions. Connection to trunks is via any two of the following integral interface modules as follows:-

- Single PRI E1/PRI E1-R2 (30 trunks) or
- Single PRI T1 (23B+1D or 24B trunks - USA only) or
- Quad BRI (8 trunks) or
- Analog 4 (loop start).

See page 39 for installation and page 32 for country specific variants.

An eight port auto-negotiating 10/100 BaseT LAN hub provides access to networks and/or up to eight IP telephones.

(Where IP telephones are to be used a suitable switch, e.g. an Avaya Cajun P130, should be used)

Expansion Modules

Optional **Expansion Modules** (see page 27) allow the IP403 Office to be expanded to 180 extensions. These modules (with the exception of the WAN3 – see below) are connected via the Expansion Port sockets that are located on the back of each unit.

Up to six, **in any combination**, of the following Expansion Modules can be supported by the IP406 Office base unit.

- **IP400 Digital Terminal 16/30 or Digital Station 16/30**
Two variants of both (16 or 30 extensions) for digital telephones (see page 27).
Hence, six IP400 Digital Terminal/Station 30s will allow a maximum of 180 digital extensions.
- **IP400 Phone 8/16/30**
Three variants (8, 16 or 30 extensions) for analog telephones (see page 28).
Hence, six IP400 Phone 30s will allow a maximum of 180 analog extensions.
- **IP400 So8**
An S-bus module that provides 8 Basic rate ISDN interfaces (see page 29).
- **IP400 WAN3**
Provides support for a further 3 digital leased line (WAN) connections (see page 30). These expansion modules are connected to the IP403 Office unit via one of the LAN Ports located on the front of each unit.
- **IP400 Analog Trunk 16**
Provides support for up to 16 Loop Start or Ground Start analog trunks (see page 31). Two power fail sockets are also provided.

Integral Modules

In addition the IP403 Office can be fitted with either or both of the following optional Integral Modules (see pages 40 and 41):

- **Voice Compression Module (VCM)**
Supports VoIP applications (e.g. using Avaya 4600 IP series telephones connected via LAN ports). Available in 5, 10 and 20 channel variants.
- **Dual Modem Module**
Allows termination of two simultaneous analog modem calls up to and including 56kbps.

IP406 Office - Front View

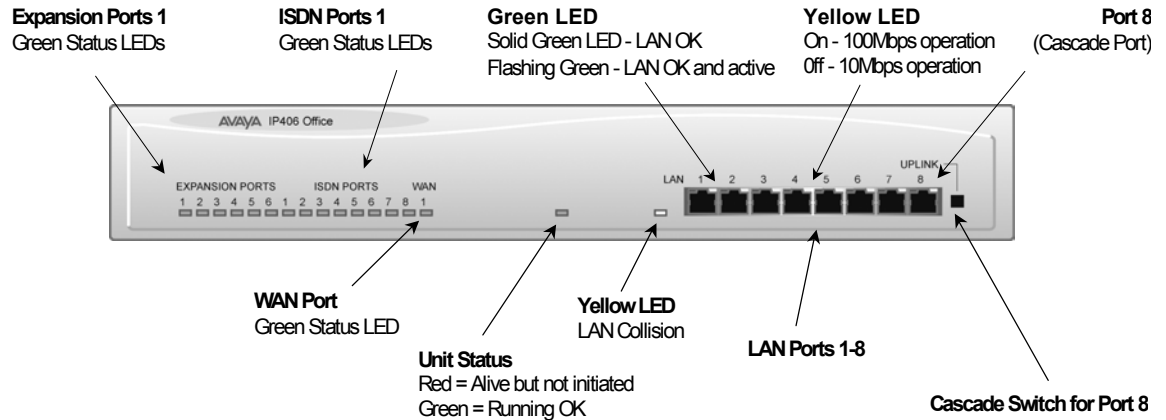

Port connections

- **LAN Ports**

The eight auto-negotiating 10/100 BaseT LAN hub ports are used for PC and server connectivity. They can also be used to connect to the optional IP400 WAN3 Expansion Module (see page 30) and IP telephones.

LAN ports allow information relating to incoming and outgoing telephone calls to be forwarded to PC based applications. They also provide access to the router functionality/configuration of the IP406 Office platform for both data and Voice over IP (VoIP) calls. (Where IP telephony is required, the hub must be connected to a suitable switch, i.e. an Avaya Cajun P130.) This eight port auto-negotiating 10/100 BaseT LAN hub supports a single MAC address only (printed on the base of the module).

Where more than eight LAN connections are required, the eighth LAN port can be used for cascading to other hubs. The **Cascade** pushbutton to the right of this port is used to set the mode. When the **Cascade** switch is in the *out* position the port can be connected to another hub without the need for a crossover cable, i.e. the port is an MDI type port. When the **Cascade** switch is in the *in* position the port can be connected directly to a PC.

Cables

IP406 Office PRI 30 E1 & PRI 24 T1 are supplied with one red ISDN cable. IP406 Office Analog 4 is supplied with four red ISDN cables. IP406 Office BRI 16 is supplied with eight red ISDN cables. For Port Pinouts and Cables, refer to pages 51 and 55 respectively.

IP406 Office - Rear View

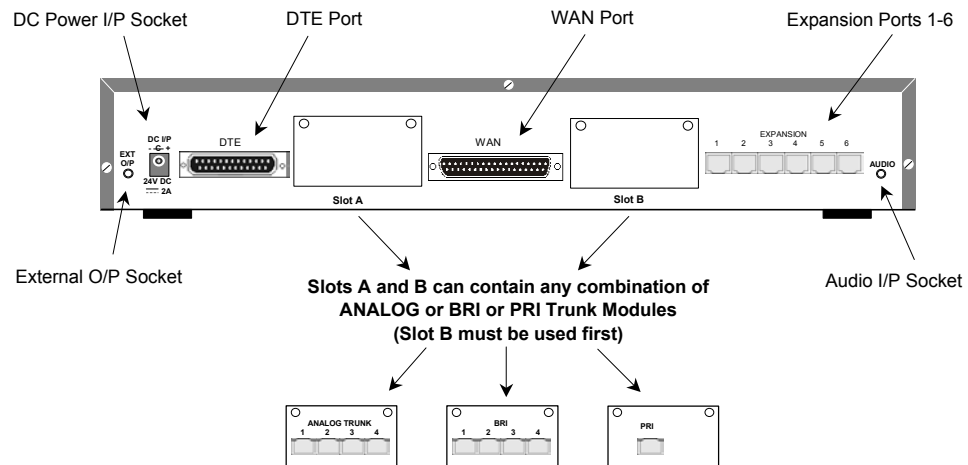

Port connections

- **External O/P Socket**
Two relay ports that allow externally powered circuits to be controlled via a single 3.5mm stereo jack socket.
- **DC Power I/P Socket**
Socket for the external 24V DC unregulated power supply (supplied with kit).
- **DTE Port**
A 25-way D-type socket. Used for connection to PCs, servers and EFTPOS terminals.
- **BRI/PRI/ALOG Ports**
The trunk interface modules are fitted into either Slots A or B and can consist of any combination of:
 - Quad Analog - 4 trunks (see page 37 for grounding)
 - PRI E1/PRI E1-R2: 30 trunks
 - PRI T1: 24B trunks or 23B+1D trunks (see page 37 for grounding)
 - Quad BRI: 8 trunks.
 PRI T1 trunks support both ISDN and Analog emulation. The default setting is 23B+1D and is switchable in the installation software to provide 24B trunks.
See page 39 for installation, page 33 for country specific variants and page 37 for grounding.
- **WAN Port**
This port supports a single synchronous data connection, which can be X.21, V.35 or V.24. The selection of the required interface is automatically determined from the pin-out of the cable plugged into the 'WAN' port. This cable **must be** connected before power is applied for auto detection to work. Connection to a Digital Leased Circuit is made by connecting the WAN port on the rear of the unit to the existing Network Terminating Unit (NTU) via the appropriate X.21, V.35 or V.24 cable.
See pages 62, 63 and 64 for cable details and page 54 for port details. *These interfaces are identical to those on the WAN3 Extension Module (see page 30).*
- **Expansion Ports 1-6**
Used to provide access to the optional **Expansion Modules** (see page 27) which allow the IP406 Office to be expanded to 180 extensions (see page 18).
- **Audio I/P Socket**
A single 3.5mm stereo or mono jack socket that enables input from an external 'Music-on-Hold' source.

Port Pinouts and Cables

For Port Pinouts and Cables, refer to pages 51 and 55 respectively.

Typical Configurations

Scenario 1:

A business requiring 60 analog Telephones and 8 Basic Rate ISDN lines (16 channels).

The IP406 Office BRI 16 with two IP400 Office Phone 30 modules provides the required line and extension capacity. Through the use of PhoneManager Lite the functionality provided by the Analog Telephones is greatly enhanced. Expansion capability for an additional 4 Modules allows the system to be expanded to a full 180 extensions. Additional lines can be added by replacing one of the BRI interfaces for a Primary rate.

Kit List

- IP406 Office BRI 16
- 2 x IP400 Office Phone Module 30

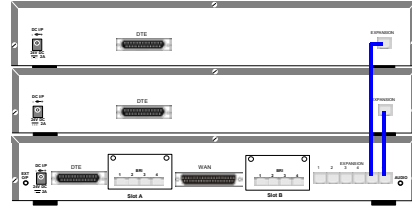
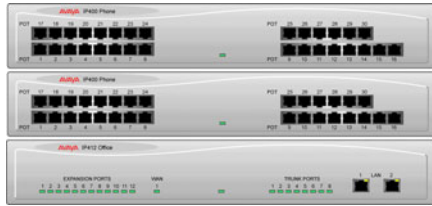

Scenario 2:

A business requiring 180 analog Telephones and 60 lines.

The configuration illustrates a fully configured IP406 Office providing 180 extensions and 60 trunks. Factory shipped with a single PRI the system is fitted with an extra trunk card in its spare slot to provide the additional 30 lines.

Kit List

- IP406 Office PRI 30 E1 fitted with an additional IP400 IP PRI E1 trunk card
- 6 x IP400 Office Phone Module 30

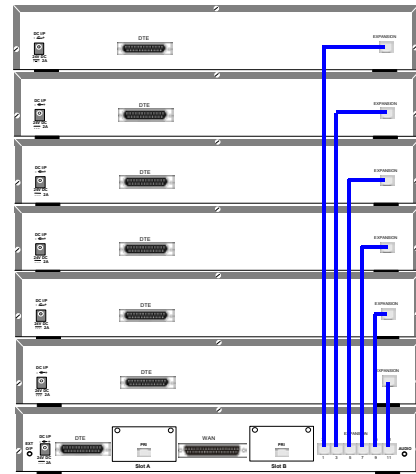
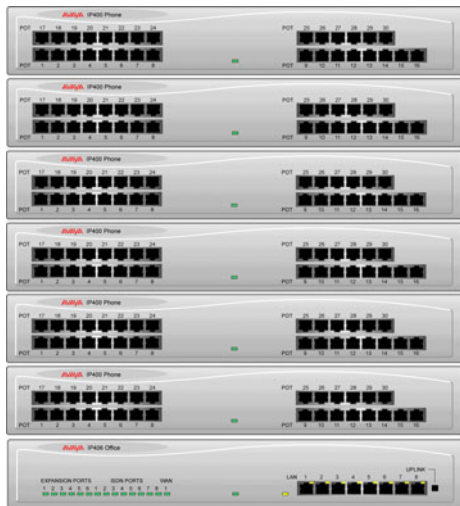

IP412 Office Platform

General

The IP412 Office system platform supports up to 256 extensions. Connection to trunks is via a combination of any of the following integral interface modules :-

- Single or Dual PRI E1/PRIE1-R2 (30 or 60 trunks respectively)
- Single or Dual PRI T1 (24 or 48 trunks respectively - USA only)
- Quad BRI (8 trunks)
- Analog 4 (4 loop start trunks)

See page 39 for installation and page 32 for country specific variants.

Dual independent auto-negotiating 10/100 BaseT Ethernet ports provide segmented access (allows a firewall break to be used) to the LAN.

(Where IP telephones are to be used a suitable switch, e.g. an Avaya Cajun P130, must be used.)

Expansion Modules

Optional **Expansion Modules** (see page 27) allow the IP412 Office to be expanded to a maximum of 256 digital or analog extensions. The Expansion Modules (with the exception of the WAN3 – see below) are connected via the Expansion Port sockets that are located on the back of each unit.

Up to twelve, **in any combination**, of the following Expansion Modules can be supported by the IP412 Office base unit provided that the maximum number of extensions does not exceed 256.

- **IP400 Digital Terminal 16/30 or Digital Station 16/30**
Two variants of both (for 16 or 30 extensions) for digital telephones (see page 27). Hence, nine IP400 Digital Terminal/Station modules can be fitted to allow a maximum of 256 digital extensions, e.g. eight equipped with 30 extensions and the ninth with sixteen extensions.
- **IP400 Phone 8/16/30**
Three variants (for 8, 16 or 30 extensions) for analog telephones (see page 28). Hence, nine IP400 Phone modules can be fitted to allow a maximum of 256 analog extensions, e.g. eight equipped with 30 extensions and the ninth with sixteen extensions.
- **IP400 So8**
An S-bus module that provides 8 Basic rate ISDN interfaces (see page 29).
- **IP400 WAN3**
Provides support for a further 3 digital leased line (WAN) connections (see page 30). These expansion modules are connected to the IP403 Office unit via one of the LAN Ports located on the front of each unit.
- **IP400 Analog Trunk 16**
Provides support for up to 16 Loop Start or Ground Start analog trunks (see page 31). Two power fail sockets are also provided.

Integral Modules

In addition the IP403 Office can be fitted with either or both of the following optional Integral Modules (see pages 40 and 41):

- **Voice Compression Module (VCM)**
Provides VoIP applications (using Avaya 4600 IP series telephones connected via LAN ports). Available in 5, 10 and 20 channel variants.
- **Dual Modem Module**
Allows termination of two simultaneous analog modem calls at speeds up to and including 56kbps (V.90).

IP412 Office - Front View

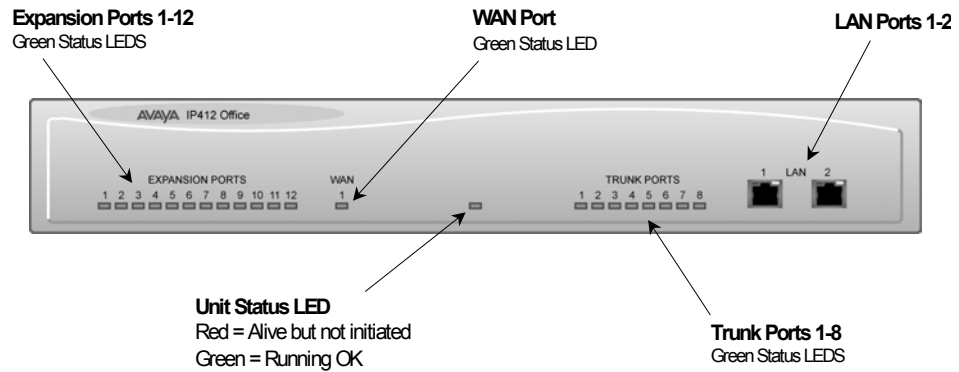

Port connections

- **LAN Ports**

The segmented dual independent auto-negotiating 10/100 BaseT Ethernet ports are used for PC and server connectivity. They can also be used to connect to the optional IP400 WAN3 Expansion Module (see page 30) and IP telephones.

Information relating to incoming and outgoing telephone calls can be forwarded to PC based applications via these ports. These segmented Ethernet ports support separate IP and MAC addresses and hence a Firewall break may be implemented. They also provide access to the router functionality/configuration of the IP412 Office platform for both data and Voice over IP (VoIP) calls. (Where IP telephony is required, a suitable switch, i.e. an Avaya Cajun P130, must be used.)

Cables

IP412 Office DT PRI 30 E1 & DS PRI 24 T1 are supplied with one red ISDN cable. IP412 Office DT PRI60 E1 & PRI48 T1 are supplied with two red ISDN cables. For Port Pinouts and Cables, refer to pages 51 and 55 respectively.

IP412 Office - Rear View

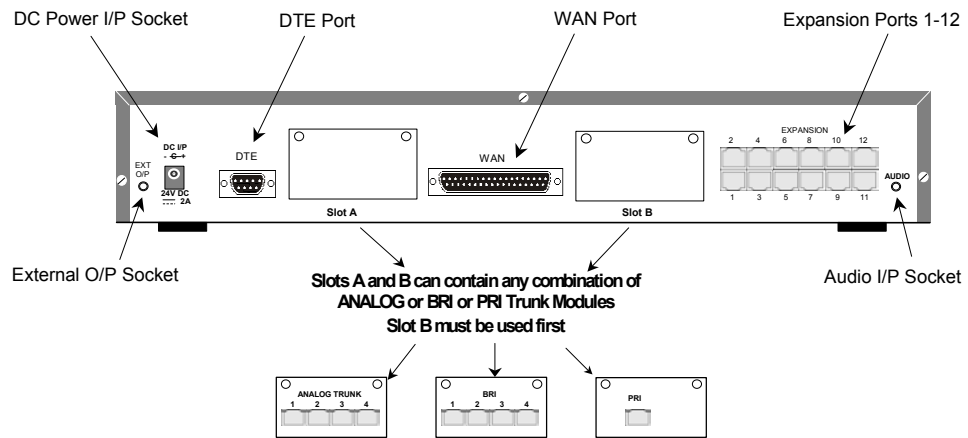

Port connections

- **External O/P Socket**
Two relay ports that allow externally powered circuits to be controlled via a single 3.5mm stereo jack socket.
- **DC Power I/P Socket**
Socket for the external 24V DC unregulated power supply (supplied with kit).
- **DTE Port**
A 9-way D-type socket. Used for connection to PCs, servers and EFTPOS terminals.
- **BRI/PRI/ALOG Ports**
The trunk interface modules are fitted into either Slots A or B as follows:
 - Slot A** Quad Analog: 4 trunks (see page 37 for grounding)
Quad BRI: 8 trunks
Single or Dual PRI E1/E1-R2: 30 or 60 trunks respectively
Single or Dual PRI T1: 24B/ 23B+1D or 48B/46B+2D trunks respectively (see page 37 for grounding).
 - Slot B** Single or Dual PRI E1/E1-R2: 30 or 60 trunks respectively
Single or Dual PRI T1: 24B/ 23B+1D or 48B/46B+2D trunks respectively (see page 37 for grounding).

PRI T1trunks support both ISDN and Analog emulation. The default setting is 23B+1D (46B+2D) and is switchable in the installation software to become a 24B (48B) trunk.
See page 39 for installation, page 33 for country specific variants and page 37 for grounding.
- **WAN Port**
This port supports a single synchronous data connection, which can be X.21, V.35 or V.24. The selection of the required interface is automatically determined from the pin-out of the cable plugged into the WAN port. This cable **must be** connected before power is applied for auto detection to work. Connection to a Digital Leased Circuit is made by connecting the WAN port on the rear of the unit to the supplied Network Terminating Unit (NTU) via the appropriate X.21, V.35 or V.24 cable.
See pages 62, 63 and 64 for cable details and page 54 for port details. *These interfaces are identical to those on the WAN3 Extension Module (see page 30).*
- **Expansion Ports 1-12**
Used to provide access to either:
 - optional **Expansion Modules** which allow the IP412 Office to be expanded to 256 extensions (see page 22).
 - additional ISDN or WAN interfaces.
- **Audio I/P Socket**
A single 3.5mm stereo or mono jack socket that enables input from an external 'Music-on-Hold' source.

Port Pinouts and Cables

For Port Pinouts and Cables, refer to pages 51 and 55 respectively.

Typical Configurations

Scenario 1:

A business requiring 180 Display Telephones and 96 Digital lines with 20 Analog lines for fall back purposes in the event of the T1 service failing.

The configuration illustrates a fully configured IP412 Office providing 180 extensions and 96 digital trunks (4 x T1) and two IP400 Office Analog Trunk 16 modules offering capacity of up to 32 analog trunk lines. Factory shipped with a single Dual PRI T1 interface, the system is fitted with an extra trunk card in its spare slot to provide the additional 48 lines.

Kit List

- IP412 Office PRI 48 T1
- 6 X IP400 Office Digital Station 30 Module
- 2 x IP400 Office Analog Trunk 16
- 180 x Avaya 6412 Digital Terminals

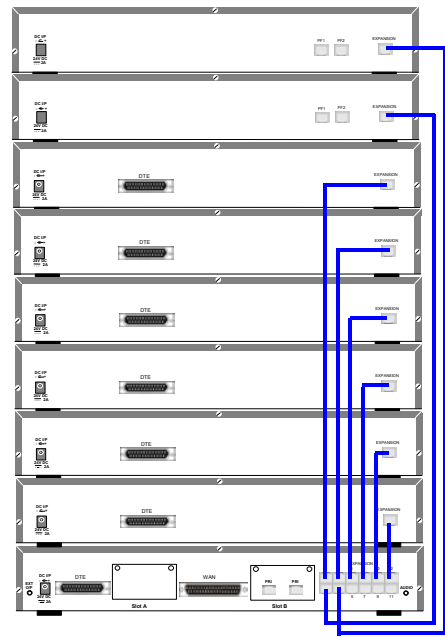
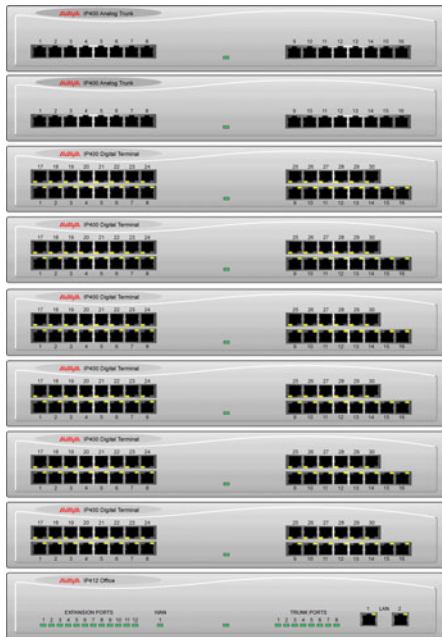

Scenario 2:

A Business requiring 90 IP hardphones, 90 IP softphones and 60 lines.

This configuration illustrates an IP412 Office PRI 60 E1 fitted with two optional IP400 Office Voice Compression Module 20s. These two internally fitted cards allow up to 40 simultaneous calls to external parties, as they are only used when an IP extension is calling a non-IP telephone or line. If less 'Gateway'ed calls are required, one of the 20 channel cards could be substituted for a smaller variant.

The IP Office softphone is 'iPhoneManager Pro' which requires two types of Licence Keys which allow PhoneManager Lite, supplied as standard, to run as IP Extensions.

Kit List

IP412 Office PRI 60 E1 fitted with two optional IP400 Voice Compression Module 20s

90 x 4612 IP Hardphones

- IP400 PhoneManager Pro RFA
- IP400 iPhoneManager Pro RFA 50
- IP400 iPhoneManager Pro RFA 40 (50+40 = 90)

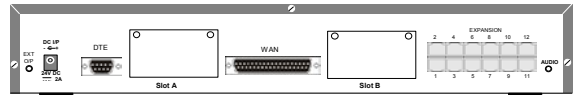
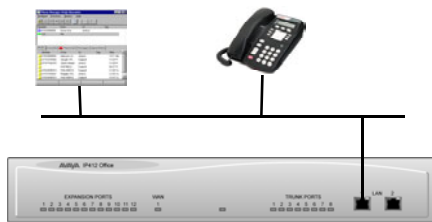

Expansion Modules

Dependent upon configuration requirements, combinations of the following Expansion Modules are used with IP Office platforms. With the exception of the WAN3 module (see page 30), all of these Expansion Modules are connected to the Expansion Ports of an IP Office platform using Expansion Interconnect Cables (see page 61).

IP400 Digital Terminal 16/30

Front View (30 Port version)

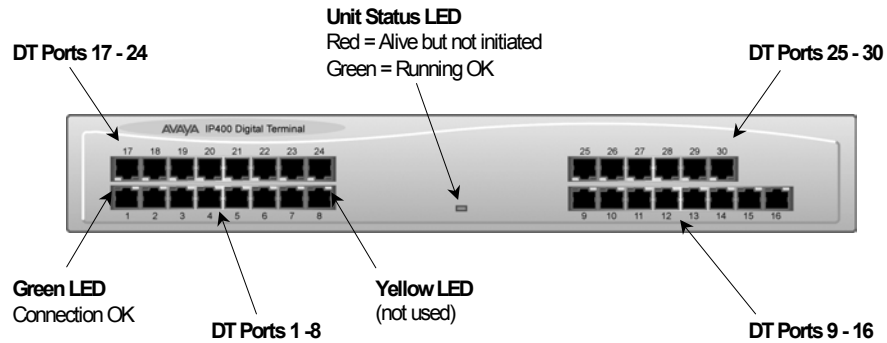

Note: The IP400 Digital Terminal 16 Expansion Module is only equipped with the bottom row of ports (1-16).

Port connections

- DT ports are used for connection to Avaya 2000 series telephones (see page 5) and support either A-Law or μ -Law PCM encoding. Both DT and DS ports can be set for either μ -Law or A-Law PCM encoding. At default both types of port are set to μ -Law but can be switched, in software, to A-Law (refer to the Administration Manager Manual for details). Using DT Line Cords (see page 56) and standard structured wiring, these RJ45 ports can be extended to the required telephone location. In addition, converters can be used to provide BT New Plan sockets (431A/631A) if required (see page 65). When devices are equipped with line cords that terminate in RJ11 plugs, then RJ11/RJ45 adapters should be used.

Rear View (all versions)

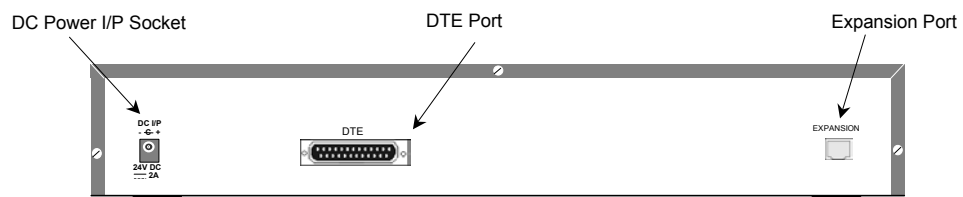

Port connections

- Expansion Port**
Used to connect a Digital Terminal Expansion Module to the Expansion Port of an IP Office platform.
- DC Power I/P Socket**
Socket for the external 24V DC unregulated power supply (supplied with kit).
- DTE Port**
A 25-way D-type socket. Used for connection to PC (diagnostics only).

Cables

All IP400 Office Digital Terminal/Digital Station variants are supplied with one blue Expansion Interconnect cable. For Port Pinouts and Cables, refer to pages 51 and 55 respectively.

IP400 Digital Stations 16/30

The IP400 Digital Station Expansion Module similar to the IP400 Digital Terminal Expansion Module (see page 27) with the exception that the Ports are labeled **DS** not **DT** and support **Avaya 6400** or **4400** series telephones.

IP400 Phone 8/16/30

Front View (30 port version)

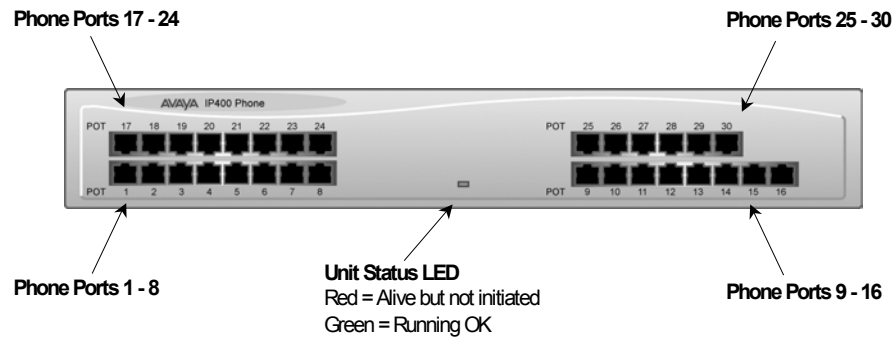

Notes: The IP400 Phone 8 variant is only equipped with the bottom left row of ports.
The IP400 Phone 16 variant is only equipped with the bottom row of ports.

Port connections

- **Plain Ordinary Telephone (POT) Ports**

These ports are used for connection to standard analog telephones, fax machines and modems. Using standard structured wiring, these RJ45 ports can be extended to the required telephone location. Converters can be used to provide BT New Plan sockets (431A/631A) if required (see page 65). When devices are equipped with line cords that terminate in RJ11 plugs, then RJ11/RJ45 adapters should be used.

All analog telephones must conform to the port specification (see page 67).

Rear View (all versions)

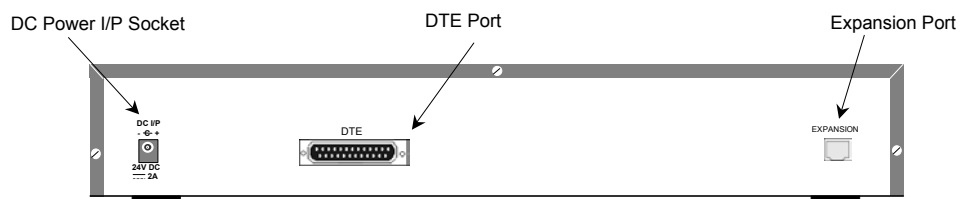

Port connections

- **Expansion Port**

Used to connect a Phone Expansion Module to the Expansion Ports of an IP Office platform.

- **DC Power I/P Socket**

Socket for the external 24V DC unregulated power supply (supplied with kit).

- **DTE Port**

A 25-way D-type socket. Used for connection to PC (diagnostics only).

Cables

All IP400 Office Phone variants are supplied with one blue Expansion Interconnect cable. For Port Pinouts and Cables, refer to pages 51 and 55 respectively.

IP400 So8

The So8 Module is only applicable to countries that support the ETSI signaling protocol (see page 34).

Front View

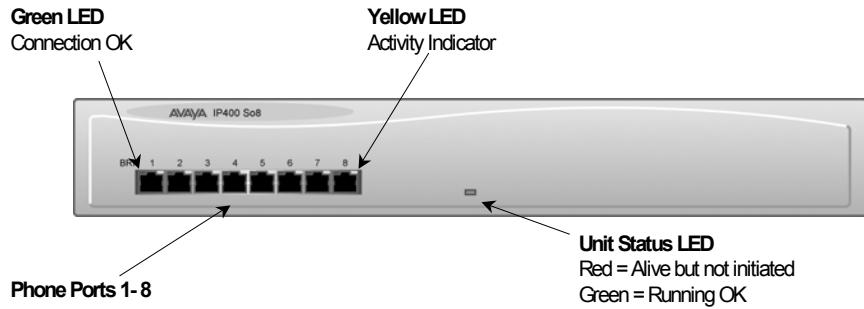

Port connections

- **BRI Ports**
These are 64k ISDN BRI S-Bus ports and are used for connection to ISDN Telephones, Group 4 faxes, Video conferencing units, etc.

WARNING: BRI phone ports 1-8 **must not** be connected to the external ISDN Connections.

Rear View

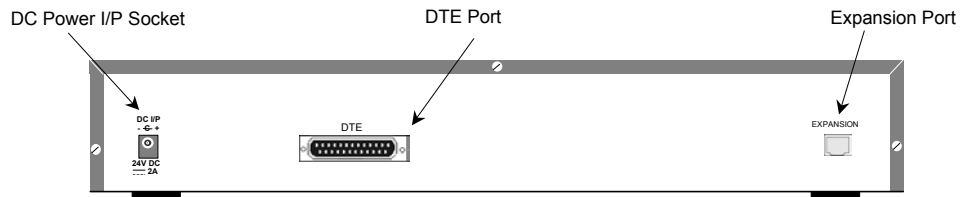

Port connections

- **Expansion Port**
Used to connect a So8 Module to the Expansion Ports of an IP Office platform.
- **DC Power I/P Socket**
Socket for the external 24V DC unregulated power supply (supplied with kit).
- **DTE Port**
A 25-way D-type socket. Used for connection to PC (as a diagnostic aid).

Cables

IP400 So8 is supplied with one blue Expansion Interconnect cable. For Port Pinouts and Cables, refer to pages 51 and 55 respectively.

IP400 WAN3

Front View

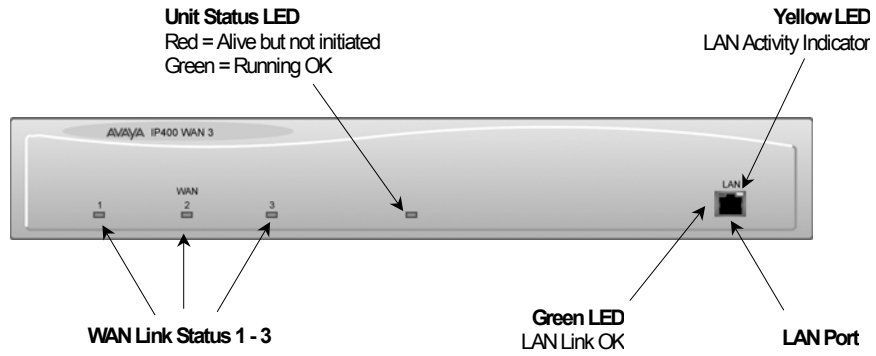

Port connections

- LAN Port

The LAN Port is the expansion port and permits connection to an IP403, IP406 or IP412 Office platform LAN Port. A LAN Interconnect cable (see page 58) is required for connection to an IP403 or IP406 and an IP412 requires a Crossover cable (see page 60).

Rear View

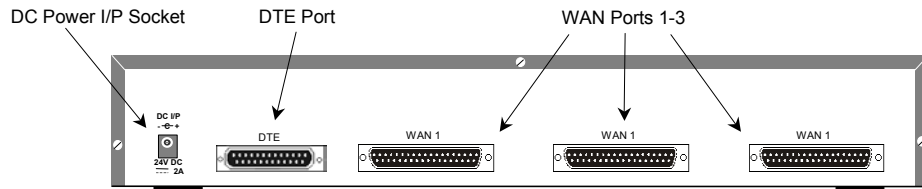

Port connections

- WAN Ports

These ports support a single synchronous data connection, which can be X.21, V.35 or V.24/V.28. The selection of the required interface is automatically determined from the pin-out of the cable plugged into the WAN port. This cable **must be** connected before power is applied for auto detection to work. Connection to a Digital Leased Circuit is made by connecting the WAN port on the rear of the unit to the existing Network Terminating Unit (NTU) via the appropriate X.21, V.35 or V.24 cable. These cables are detailed in the table below (see pages 62, 63 and 64 for details).

Cable Type	SAP Code
V.24/V.28 Cable	700213416
V.35 Cable	700213408
X.21 Cable	700213424

These WAN ports are identical to those on the IP403/406/412 Office platforms (see pages 16, 20 and 24).

- DC Power I/P Socket

Socket for the external 24V DC unregulated power supply (supplied with kit).

- DTE Port

A 25-way D-type socket. Used for connection to PC (as a diagnostic aid).

Cables

IP400 WAN3 is supplied with one green LAN Interconnect cable. For Port Pinouts and Cables, refer to pages 51 and 55 respectively.

IP400 Analog Trunk 16

Front View

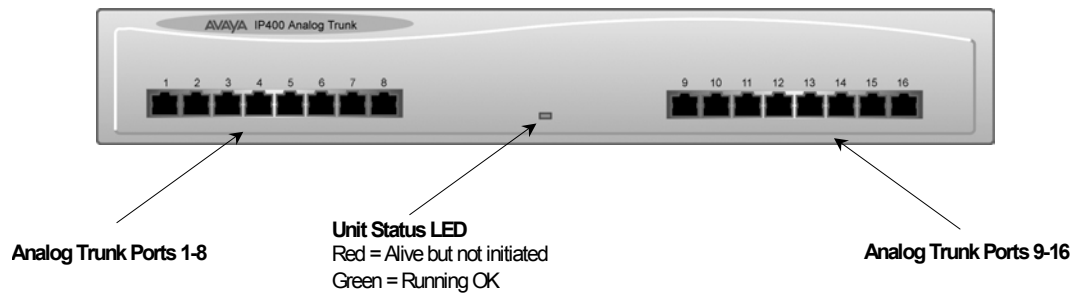

Port connections

- **Analog Trunk Ports**

These ports are used for connection to standard analog trunks (loop start or ground start). Using standard structured wiring, these RJ45 ports can be extended to the required trunk sockets. Trunk ports 1 and 2 are, in the event of power failure, automatically switched to PF1 and PF2 respectively on the rear of the unit (see below).

Rear View

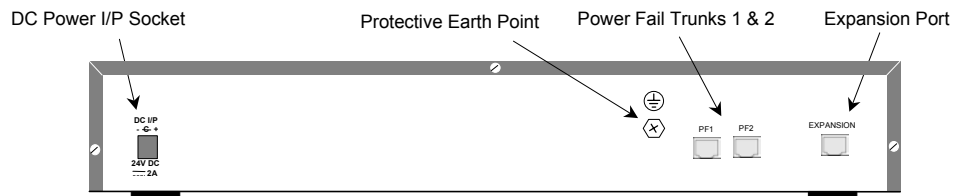

Port connections

- **Expansion Port**

Used to connect the Analog Trunk Expansion Module an Expansion Ports of an IP400 Office platform.

- **DC Power I/P Socket**

Socket for the external 24V DC unregulated power supply (supplied with kit).

- **Protective Grounding Point**

Within the USA a protective grounding **must be permanently** fitted. Connection of this protective grounding requires the use of suitable tools and **must be** connected at both ends before connection is made to the telecommunications network (see page 37).

- **Power Fail Trunks**

These two ports **must be** set and connected to Loop Start trunks only. POTs plugged into these two sockets are mapped to trunk ports 1 & 2 such that, in the event of a mains power failure, PF1 and PF2 can operate as 'hot lines' to the emergency services (e.g. 911, etc).

Cables

IP400 Analog Trunk 16 is supplied with one blue Expansion Interconnect cable. For Port Pinouts and Cables, refer to pages 51 and 55 respectively.

Country Variants

The following are lists of the country variants for each IP400 Office platform, trunk module kits, Integral module kits and expansion modules. The PCS level for each module can be found on a label that is stuck to the base of each module.

IP400 Office Systems

Throughout this section the following abbreviations are used:

ROW = Rest of world (excluding USA, Canada),

NA = North America (USA and/or Canada),

CALA = Caribbean/Latin America,

CH = China.

EU = Europe

KR = Korea

NZ = New Zealand

For countries outside North America/ CALA, use ROW variant unless stated otherwise.

IP401 Compact Office

Variant	A-Law / μ -Law	Country	SAP Code
IP401 Compact Office DT2	A	ROW	700184617
IP401 WAN Expansion kit	-	ROW	700185093
IP401 Memory Expansion kit	-	ROW	700198351
IP401 CO DT2 Expansion kit	-	ROW	700185085
IP401 Compact Office DT4	A	ROW	700184633

IP403 Office

Variant	A-Law / μ -Law	Country	SAP Code
IP403 Office DT (No Trunks)	A	ROW/CALA	700210578
IP403 Office DT BRI 8	A	ROW	700184641
IP403 Office DT PRI 30 E1	A	ROW	700184658
IP403 Office DS (No Trunks)	A	ROW/CALA	700234453
IP403 Office DS (No Trunks)	μ	NA	700210610
IP403 Office DS PRI 24 T1	μ	NA	700184666
IP403 Office DS Analog 4	μ	NA	700184674

IP406 Office

Variant	A-Law / μ -Law	Country	SAP Code
IP406 Office (No Trunks)	A	ROW/CALA	700234461
IP406 Office BRI 16	A	ROW	700184682
IP406 Office PRI 30 E1	A	ROW	700184690
IP406 Office (No Trunks)	μ	NA	700210776
IP406 Office PRI 24 T1	μ	NA	700184708
IP406 Office Analog 4	μ	NA	700184716

IP412 Office

Variant	A-Law / μ -Law	Country	SAP Code
IP412 Office (No Trunks)	A	ROW/CALA	700234479
IP412 Office PRI 30 E1	A	ROW	700184724
IP412 Office PRI 60 E1	A	ROW	700184732
IP412 Office (No Trunks)	μ	NA	700210784
IP412 Office PRI 24 T1	μ	NA	700184740
IP412 Office PRI 48 T1	μ	NA	700184757

Integral Module Kits

Voice Compression Modules (VCM)

Variants	Country	SAP Code
5 Channel	ALL	700185119
10 Channel	ALL	700185127
20 Channel	ALL	700185135

Dual Modem Module

Variants	Country	SAP Code
Modem 2	ALL	700185226

Trunk Module Kits

BRI Trunk Interface Module

Variant	Country	SAP Code
IP400 QUAD BRI	ROW	700185168

Analog Trunk Interface Module

Variant	Country	SAP Code
IP400 ANALOG 4 (LS)	NA/CALA	700185192
IP400 ANALOG 4 (LS)	EU	700241672
IP400 ANALOG 4 (LS)	NZ	700241706

PRI Module

Variant	Country	SAP Code
IP400 DUAL PRI 60 E1	ROW/CALA	700185184
IP400 DUAL PRI 60 E1R2 RJ45	CALA/KR/CH	700241649
IP400 DUAL PRI 60 E1R2 COAX	CALA	700241664
IP400 SINGLE PRI 30 E1	ROW/CALA	700185176
IP400 DUAL PRI 30 E1R2 RJ45	CALA/KR/CH	700241631
IP400 DUAL PRI 30 E1R2 COAX	CALA	700241656
IP400 SINGLE PRI 24 T1	NA	700185200
IP400 DUAL PRI 48 T1	NA	700185218

- Notes:**
1. For countries outside North America/CALA, use the ROW variant unless stated otherwise.
 2. PRI T1trunks support both ISDN and Analog emulation. The default setting is 23B+1D and is switchable in the installation software to become a 24B trunk.

Power Supplies

Common Lump-in-Line Power Supply units are supplied with each IP Office/Expansion Module. However, the power leads are county specific and **must be** ordered separately as follows:

Variant	Country	SAP Code
IP400 Power Supply (1off)	ALL	700210792
IP400 Power Lead UK (1 off)	UK	700213374
IP400 Power Lead UK (pack of ten)	UK	700251473
IP400 Power Lead Europe CEE7/16 (1 off)	EU	700213382
IP400 Power Lead Europe CEE7/16 (pack of ten)	EU	700251465
IP400 Power Lead NA (1 off)	NA	700213390
IP400 Power Lead NA (pack of ten)	NA	700251481
IP400 Power Lead Europe CEE7/7 (1 off)	KR	700254519
IP400 Power Lead Europe CEE7/7 (pack of ten)	KR	700254576

IP Office Rack Mounting Kits

Rack Mounting Kit

Variant	Country	SAP Code
Rack Mounting kit for 19 inch racks	ALL	700210800

Expansion Modules

IP400 Phone

Variant	Country	SAP Code
IP400 Phone 8	ALL	700184773
IP400 Phone 16	ALL	700184781
IP400 Phone 30	ALL	700184799

IP400 Digital Terminals

Variant	Country	SAP Code
IP400 Digital Terminal 16	ROW	700185606
IP400 Digital Terminal 30	ROW	700185069

IP400 Digital Stations

Variant	Country	SAP Code
IP400 Digital Station 16	ALL	700184807
IP400 Digital Station 30	ALL	700184880

IP400 Analog 16 Trunks

Variant	Country	SAP Code
IP400 Analog Trunk 16	NA/CALA	700211360
IP400 Analog Trunk 16 EU	EU	700241680
IP400 Analog Trunk 16 NZ	NZ	700241698

IP400 So8

Variant	Country	SAP Code
IP400 So8	ALL	700185077

IP400 WAN3

Variant	Country	SAP Code
IP400 WAN3	ALL	700185028

Note: For countries outside the Americas/CALA, use ROW variant unless stated otherwise.

Preparing for Installation

Introduction

This section reviews the requirements for installing an IP Office system. You must meet these requirements for the system to operate safely and in the intended manner.

This section covers :

- "Tools & Parts Required" on page 35.
- "Space requirements" on page 35.
- "Environmental requirements" on page 36.
- "Power Supply requirements" on page 36.

Tools & Parts Required

General :

- Pozidrive No. 1 screwdriver for removal of unit covers.
- Cutter/knife for cable ties.
- Cable ties - 3mm x 50mm.
- Pozidrive No. 4 screwdriver for Analog Trunk 16 expansion module grounding post.

Note: In addition, ensure that you have sufficient cables that are **not supplied** with the modules, e.g. Line Cords for structured cabling (see page 55) and power supply cables (see page 33).

Programming :

These are the tools required for programming of a newly installed IP Office system.

- PC running Windows 95/98/2000 or NT with the following specification:
 - Intel Pentium II 333Mhz or faster, 100MB HD space, CD-ROM drive, COM port, terminal emulation (e.g. HyperTerminal) and a super VGA Monitor (set to 1024 by 768).
- PC with a LAN card with either a fixed IP address (allocated by your system administrator) or be using DHCP to obtain an IP address.
- IP Cat. 5E patch cable (red – supplied with system see page 57).
- IP Office Administration CD (supplied with system).
- IP Office Manager Application Manual (supplied on CD with system).
- IP Office Feature Key (where software that requires a Licence Key is to be installed).

Space requirements

Check that the planned location meets the following requirements.

- **Height :** A IP401 Compact Office module is 71mm high.
IP403, 406, 412 and all Expansion modules are 71mm high.
Hence the total height of a system is the number of modules multiplied by 71mm.
- **Width :** A IP401 Compact Office module is 255mm wide.
IP403, 406, 412 and all Expansion modules are 445mm wide.
- **Depth :** A IP401 Compact Office module is 235mm deep.
IP403, 406, 412 and all Expansion modules are 245mm deep.
- IP403, IP406, IP412 and Expansion modules can be mounted in 19" racks (see page 42).
- When modules are free standing (ideally mounted one upon another), allow a minimum clearance of 50mm either side for cable trunking.
- Check there is suitable lighting for installation, system programming and future maintenance.
- Check that there is sufficient working space for installation and future maintenance.
- Ensure that likely activities near the system will not cause any problems, e.g. access to and maintenance of any other equipment in the area.

Environmental requirements

The planned location must meet the following requirements:

- Check that the area is a well ventilated area, having a temperature range of 0°C to +40°C and a humidity range of 10% to 95% non-condensing.
- Check there are no flammable materials in the area.
- Check there is no possibility of flooding.
- Check that no other machinery or equipment needs to be moved first.
- Check that it is not an excessively dusty atmosphere.
- Check that the area is unlikely to suffer rapid changes in temperature and humidity.
- Check for the proximity of strong magnetic fields, sources of radio frequency and other electrical interference.
- Check there are no corrosive chemicals or gasses.
- Check there is no excessive vibration or potential of excessive vibration, especially of the cabinet mounting surface.
- Check that, for the USA only, where telephones are installed in another building, that the appropriate IROB protectors are fitted (see page 65).

IMPORTANT SAFETY INSTRUCTIONS

When using your telephone equipment, basic safety precautions should always be followed to reduce the risk of fire, electric shock and injury to persons, including the following:

1. Do not use this product near water, for example, near a bath tub, wash bowl, kitchen sink or laundry tub, in a wet basement or near a swimming pool.
2. Avoid using a telephone (other than a cordless type) during an electrical storm. There may be a remote risk of electric shock from lightning.
3. Do not use the telephone to report a gas leak in the vicinity of the leak.
4. Use only the power cord and batteries indicated in this manual. Do not dispose of batteries in a fire. They may explode. Check with local codes for possible special disposal instructions.

SAVE THESE INSTRUCTIONS.

Power Supply requirements

Check the following:

- **IP Office Base Unit and Expansion Modules :**
IP Office modules require a separate **switched** mains supply. Power on the Expansion Modules **first**. If the main IP Office Module does not detect an item at power on, it will never use it. If power is switched on from a central point for all modules, then, as the main unit is the slowest to start, this will be taken care of automatically.
- Common Lump-in-Line Power Supply units are supplied with each IP Office/Expansion Module. However, the power leads are country specific and **must be** ordered separately (see page 33).

CAUTION: The 2A 24V Lump-in-Line PSUs supplied with each IP Office module must be connected to a 50/60Hz, 100-240V power source only.

- **UPS Equipment :**
The use of UPS's to support the IP Office system during mains power failure is highly recommended. Such equipment also provides mains conditioning. Contact Avaya for details of preferred and tested suppliers and models.

Grounding

Protective Ground

A protective ground **must be permanently** fitted to IP400 Analog Trunk 16 modules (see page 31). Connection of this protective ground requires the use of suitable tools and **must be** connected at **both ends** before connection is made to the telecommunications network.

To connect the protective ground:

1. Attached one end of a #12 AWG or #14 AWG solid insulated cable (sleeve **must be** green/yellow) to the Protective Ground Point as shown below. Ensure that the Ground Post securing screw is fully tightened.

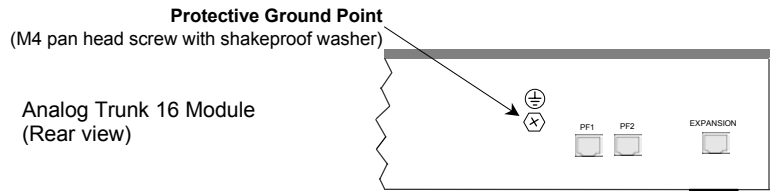

2. Connect, using a fastening that satisfies local regulations, the other end of the wire to the approved protective ground.

Functional Ground

Within the USA only, for areas with high lightning and/or ESD, we recommend that a functional ground is fitted to the following trunk modules on IP403, 406 and 412 systems:

Trunk Module	IP400 QUAD ANALOG	IP400 SINGLE PRI T1	IP400 DUAL PRI T1
SAP Code	700185192	700185200	700185218

Note: This functional ground is **not** a protective ground.

To connect the functional earth:

1. Attached one end of a #12 AWG or #14 AWG solid insulated cable (sleeve **must not be** green/yellow) to the M3 grounding screw as shown below. Ensure that the grounding screw is fully tightened.

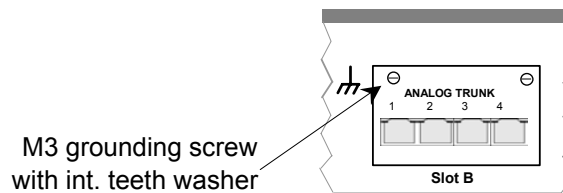

2. Connect, using a fastening that satisfies local regulations, the other end of the wire to the approved round, such as building steel or a cold water pipe.

Installing a New System

Unpacking

Before proceeding with installation, ensure that you have read the notes covered in Preparing for Installation on page 35.

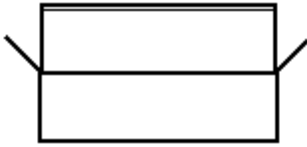

Unpacking and checking :

1. Before unpacking check for any signs of damage that has occurred during transit. If any damage exists bring it to the attention of the carrier.
2. Check all cartons against the packing slip (see page 32). Report any errors or omissions to the equipment supplier.
3. While unpacking the equipment, retain all the packaging material. Fault returns are accepted only if repackaged in the original packaging.
4. Visually inspect each item and check that all the necessary documentation and accessory items have been included. Report any errors or omissions to the dealer who supplied the equipment.
5. Ensure you read and understand any documentation included with any item.

Initial Assembly

Prior to initial assembly and mounting (rack or free standing) of your system, check that:

- For Analog Trunk 16 expansion modules, ensure that the protective ground is fitted (see pages 31 and 37).
- The required Trunk Interface Modules have been installed (see pages 16, 20 and 24), are of the correct country variant type (see page 33) and if functional grounding is required (see page 37) that it has been fitted.
- Any optional Integral Voice Compression and/or Dual Modem Modules have been fitted (see pages 40 and 41).
- Where rack mounting is required, that the mounting brackets have been fitted (see page 42).
- Where structured cabling is to be used it has been installed, conforms to all local regulations and is clearly labeled.

Perform the following:

1. Mount the IP Office modules in their final location (free standing units are ideally stacked one upon another).
2. Run the individual Lump-in-Line PSU cables back to the switchable mains supply but **do not switch-on or connect** the PSUs to the IP Office modules.
3. With the exception of a WAN3 module, connect the IP Office base module to the Expansion Modules using Expansion Interconnect Cables (blue - see page 61). These cables run from one of the Expansion Ports on the rear of a base module to the Expansion Port on the rear of the Expansion Modules.
For WAN3 Modules, use a LAN Interconnect cable (see page 58) running between one of the LAN Ports on the front of a base unit to the LAN Port on the front of the WAN3 module.
4. Connect the Trunk Ports on the base unit, using PRI/BRI ISDN Cables (see page 57), to your provider's trunk sockets.
5. Connect the DT/DS/POT Ports on the front of the units, using DT Line Cords (see page 56), to the structured cable sockets. Note that in default, the lowest port number corresponds to the lowest extension number (201).
6. Install all telephones in their appropriate locations. For wall mounting, see pages 48 and 49.
7. Connect your PC LAN Port to one of the LAN Ports on the front of an IP Office base module using a LAN Cable (see page 59).
8. Connect the individual Lump-in-Line PSU to each IP Office module and switch on.

IMPORTANT: Power on the Expansion Modules **first**. If the main IP Office Module does not detect an item at power on, it will never use it. If power is switched on from a central point for all modules, then, as the main unit is the slowest to start, this will be taken care of automatically. Proceed to Basic System Programming on page 45.

Installation of Integral Modules

To install an integral module in a IP Office system, follow the pictorial instructions given below:

Trunk Interface Modules (BRI/PRI/ANALOG4)

For IP403 see page 16, for IP406 see page 20 and for IP412 see page 24.

Procedure

1. Remove the three fixing screws on the rear of cover.
2. Turn the unit over and remove the four fixing screws from the base.
3. Slide the cover from the unit.
4. Remove the two blanking plate securing screws and remove blanking plate.
5. Insert the trunk module and secure with the two screws.
6. Mount the trunk module in position as shown below and secure with the two snap-in spacers (except for PRI E1/R2).
7. For CALA only, on the PRI E1/R2 coax. module, use the shorting blocks to connect Rx1 GND to Tx1 GND and or Rx2 GND to Tx2 GND as required.
8. Where required, fit the functional ground (see page 37).
9. Replace cover and secure with the seven fixing screws.

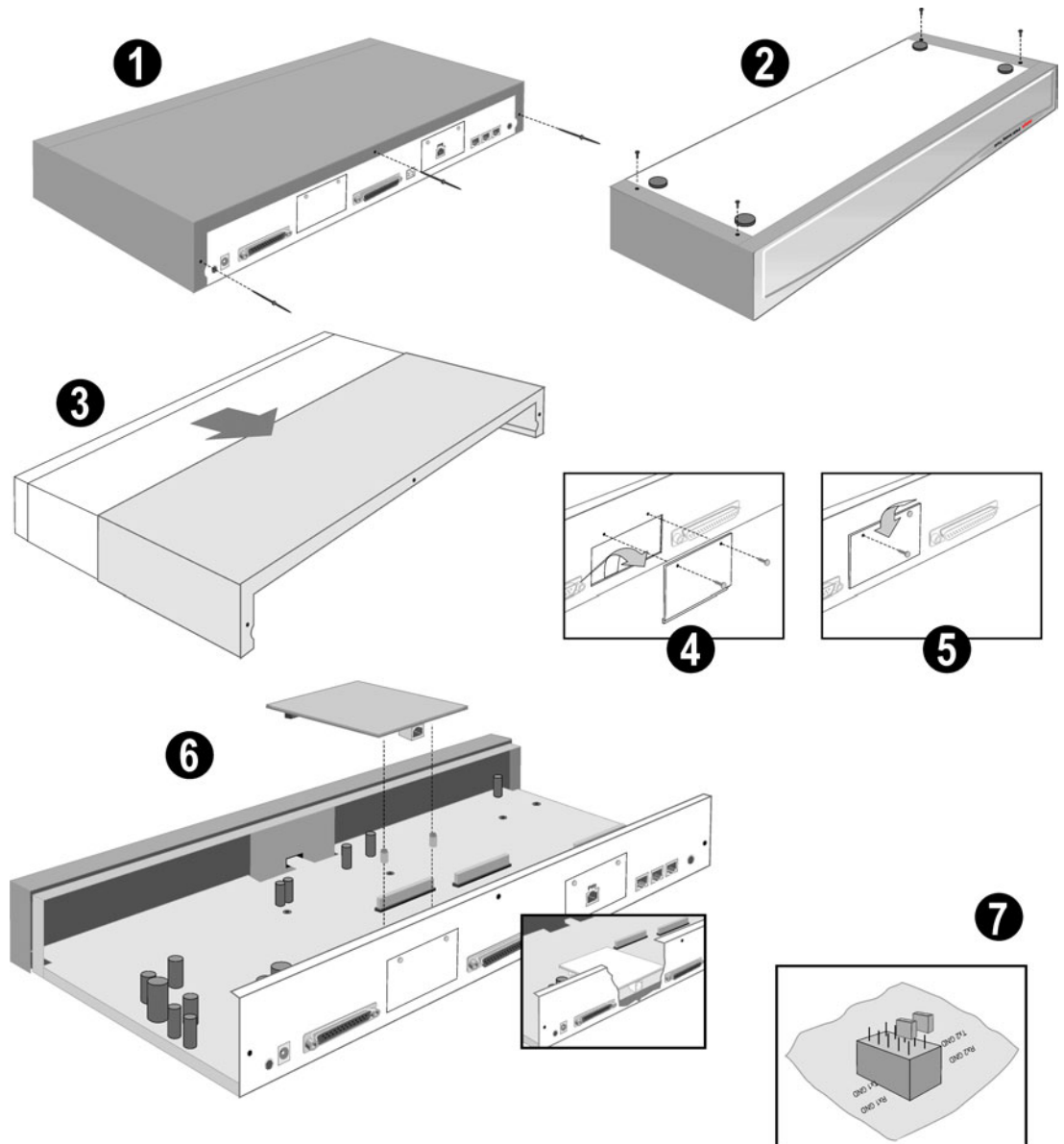

Caution: While installing, ensure that you wear a ground wrist strap that is connected to a suitable grounding point.

Voice Compression Module (VCM)

An optional Voice Compression Module (see pages 14, 18 and 22) is fitted to an IP Office base unit as follows:

Procedure

1. Remove the three fixing screws on the rear of cover.
2. Turn the unit over and remove the four fixing screws from the base.
3. Slide the cover from the unit.
4. Mount the VCM in position as shown below and secure with the two snap-in spacers.
5. Replace cover and secure with the seven fixing screws.

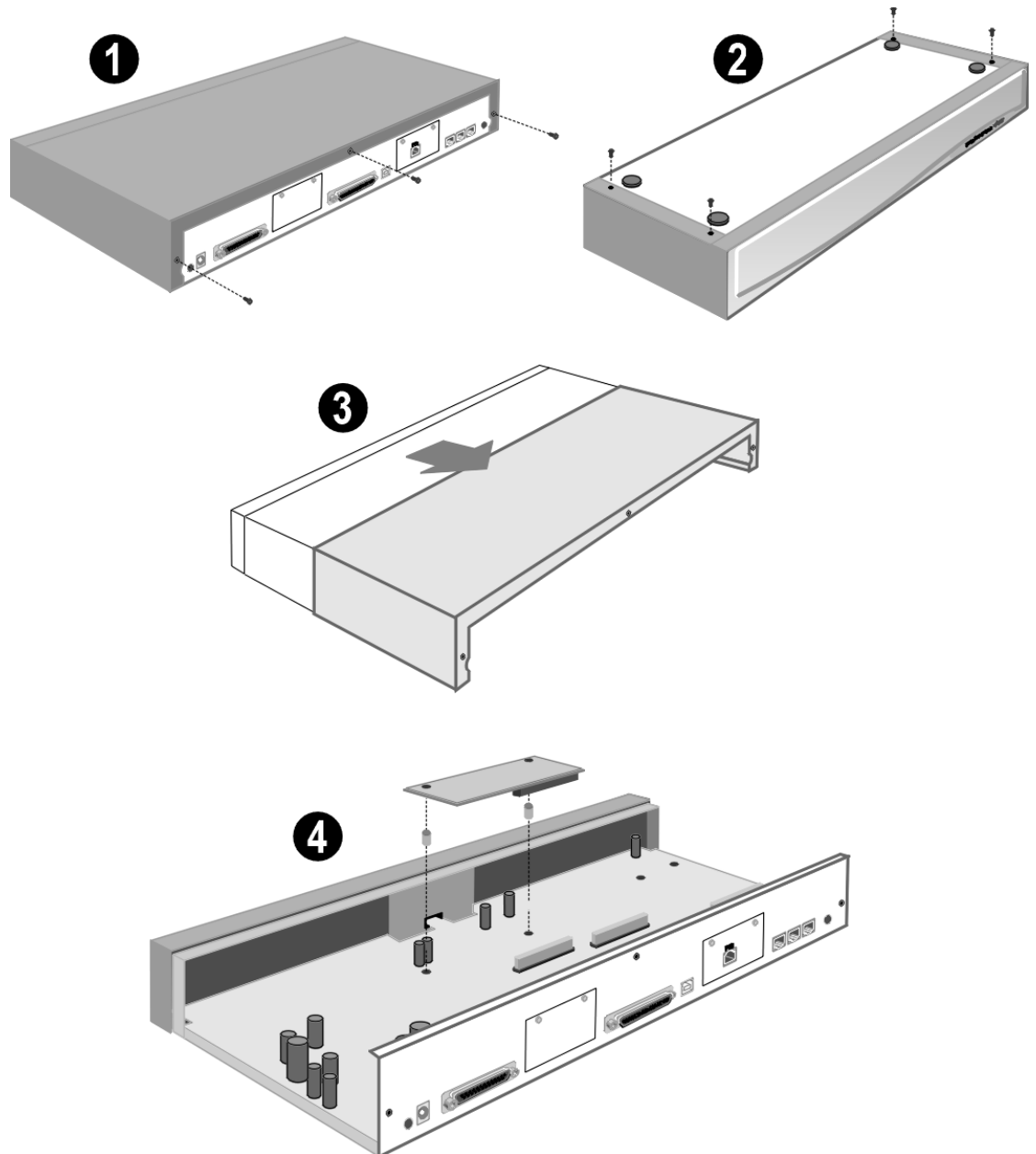

Caution: While installing, ensure that you wear a ground wrist strap that is connected to a suitable grounding point.

Dual Modem Module

An optional Dual Modem Module (see pages 14, 18 and 22) is fitted to an IP Office base unit as follows:

Procedure

1. Remove the three fixing screws on the rear of cover.
2. Turn the unit over and remove the four fixing screws from the base.
3. Slide the cover from the unit.
4. Mount the module in position as shown below and secure with the two snap-in spacers.
5. Replace the cover and secure with the seven fixing screws.

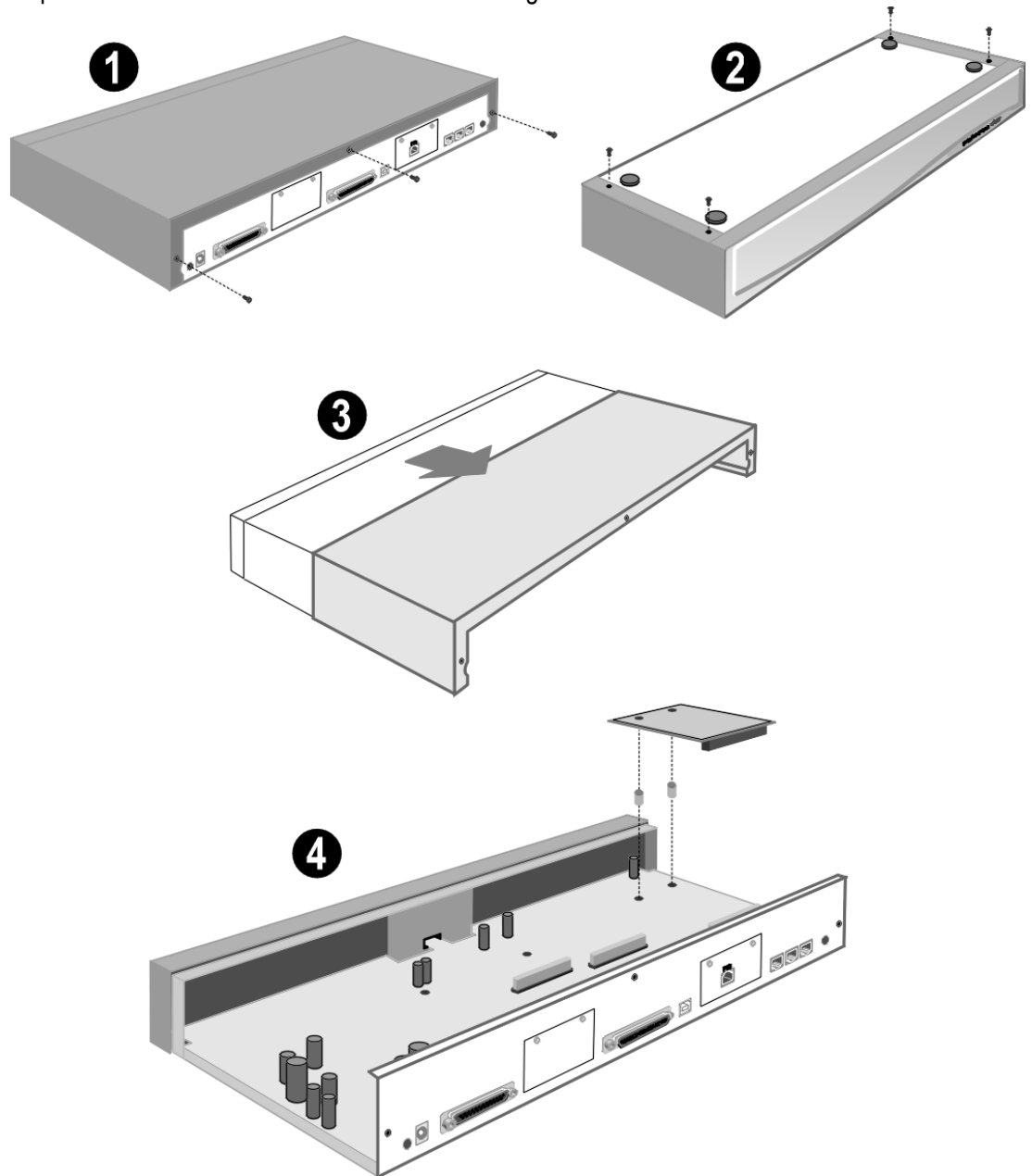

Caution: While installing, ensure that you wear a ground wrist strap that is connected to a suitable grounding point.

Rack Mounting Assembly Instructions

IP403, 406, 412 and expansion modules can be mounted in any standard 19" rack as follows:

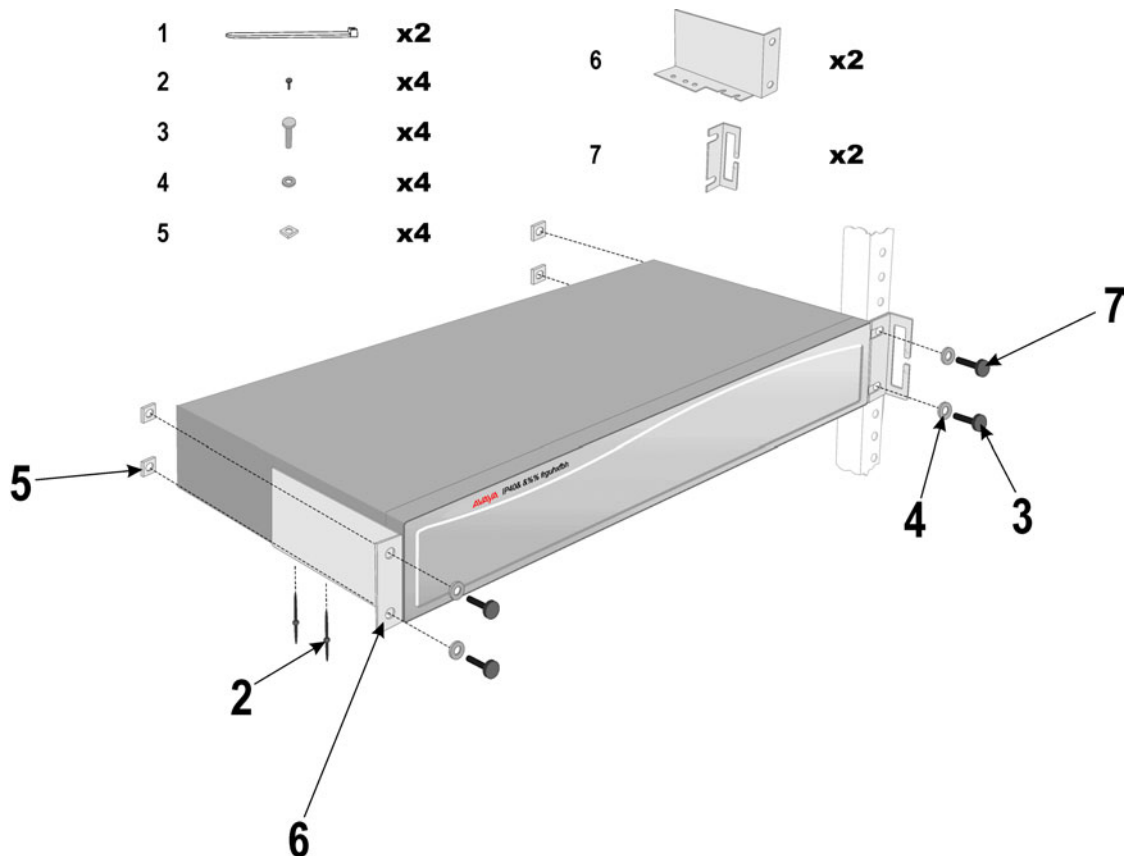

CAUTIONS: Elevated Operating Ambient Temperature:

If installed in a closed or multi-unit rack assemble, the operating ambient temperature of the rack environment may be greater than the room ambient. Therefore, consideration should be given to installing the equipment in an environment compatible with the manufacturer's maximum rated ambient temperature (T_{mra}).

Reduced Air Flow:

Installation of the equipment in a rack should be such that the amount of air flow required for safe operation of the equipment is not compromised.

Mechanical Loading:

Mounting of the equipment in the rack should be such that a hazardous condition is not achieved due to uneven mechanical loading.

Circuit Overloading:

Consideration should be given to the connection of the equipment to the supply circuit and the effect that overloading of circuits might have on overcurrent protection and supply wiring. Appropriate consideration of equipment nameplate ratings should be used when addressing this concern.

Reliable Grounding:

Reliable grounding of rack-mounted equipment should be maintained. Particular attention should be given to supply connections other than direct connections to the branch circuit (e.g. use of power strips). See page 37.

IP401 Compact Office Wall Mounting

Bath variants of the IP401 Compact Office can be wall mounted. Four retaining slots (item ❶ below) enable the IP401 unit to be mounted in any one of three positions (two horizontal and one vertical) by using two No. 8 Panhead screws. A Z-bracket (item ❷ below, supplied with unit) is used to retain the IP401 unit in position.

- Cautions:**
1. The Z-bracket **must not be used** as the sole wall mounting fixture.
 2. The weight of the IP401 unit **must be held** by the two No 8 Panhead screws located into the retaining slots.
 3. When mounted vertically, the air vents (on the rear panel of the IP401 unit) **must be** on the top surface. E.g. item ❷ below **must be fitted above** the unit.

Procedure:

1. Drill two holes 16cm apart (horizontally or vertically – see Caution 3 above).
Using suitable wall fixings (wall plugs), insert two No.8, Panhead screws (25mm long min. - not supplied) into wall leaving approximately 1cm proud of wall.
2. Fit the Z-bracket (item ❷ below) onto the base of the unit using the M3 Plastite self tapping screw supplied.
3. Slide the IP401 Compact Office unit onto the two screws, locating them into the two retaining slots (item ❶ below).
4. Mark the position of the retaining screw (No. 8 Panhead or similar – not supplied) that is to be used through the slot of the Z-bracket .
5. Remove the unit from the wall and, using suitable wall fixings, drill a hole for the Z-bracket retaining screw.
6. Re-position the IP401 compact Office unit and secure with a No. 8 Panhead (or similar) through the slot of the Z-bracket.

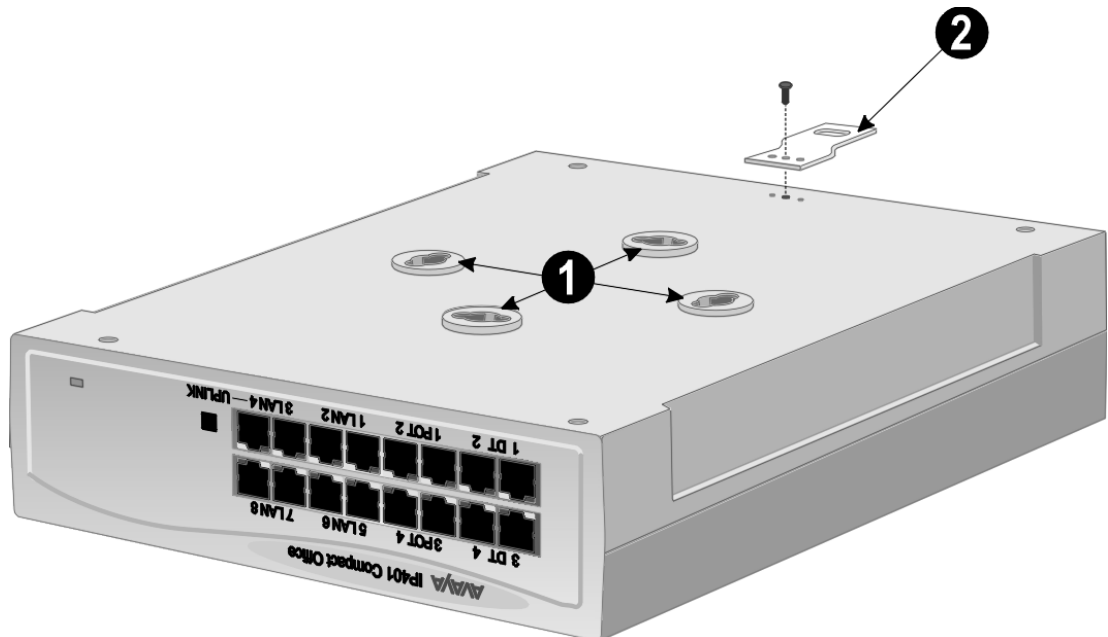

IP401 Expansion and Installation of Integral Modules

An IP401 Compact Office 2 can be expanded to an IP401 Compact Office 4. Either unit can be expanded with a WAN card. In addition, either or both an optional Voice Compression Module (VCM) and/or a VME module (providing memory capacity for embedded voice mail) can be fitted.

Procedure:

1. To add a VME memory card you do not need to de-assemble a module, simply:
 - Insert the VME memory card (item ❶) into the slot in the rear panel below the WAN port position (item ❷).
2. Remove the top cover (item ❸) from the base cover by removing the four retaining screws (two either side - items ❹) and proceed as follows.
3. To expand an IP401 Compact Office 2 to an IP Compact Office 4:
 - Remove and discard the front panel (item ❺).
 - Remove the rear panel (item ❻). Only discard if a WAN module is being fitted (see below).
 - On the rear panel, press out the molding for the additional BRI RJ45 socket (item ❼).
 - Plug the expansion board (item ❸) onto it's sockets and stand-off hex. pillars.
 - Ensure that the additional BRI RJ45 socket slots into the hole in the rear panel (item ❼).
 - Secure the expansion board (item ❸) with the three retaining screws.
 - Mount the new front and existing rear (if a WAN module is being fitted, see below) panels.
4. To add a WAN module:
 - Remove and discard the rear panel (item ❻).
 - Fit the new rear panel (with slot for WAN port 27-way D-type, items ❻ and ❷).
 - Mount WAN Module (item ❾) in position and secure with the two snap-in spacers.
5. To add a Voice Compression Module (VCM):
 - Mount the VCM Module (item ❿) in position and secure with the two snap-in spacers.

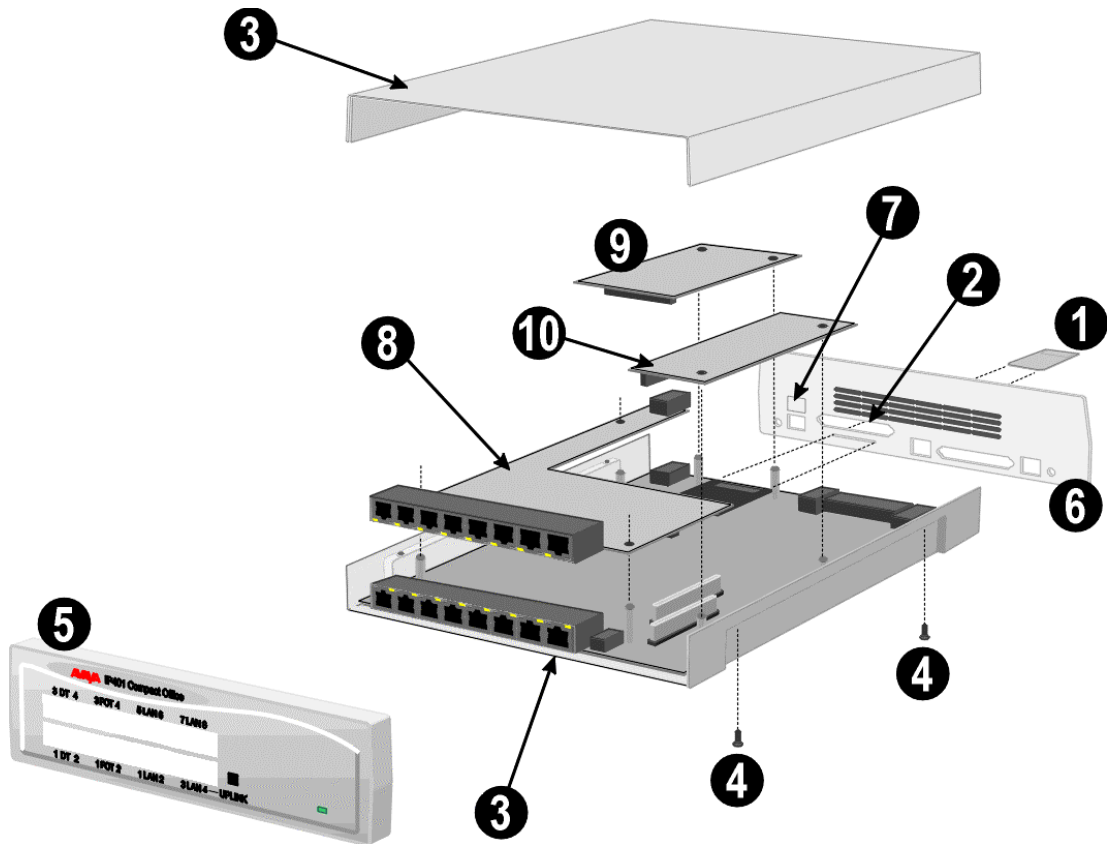

Caution: While installing modules, ensure that you wear a ground wrist strap that is connected to a suitable grounding point.

Basic System Programming

Introduction

This sections covers only the most basic aspects of system programming required to install an IP Office system. When first powered up, all IP Office systems will operate as a simple PBX. However, full system programming is highly dependent on customer requirements. Hence, some basic Initial Programming must be performed before detailed configuration programming is possible. The Administration CD (supplied with each system) contains the suite of programs required to install and maintain the IP Office system. Once loaded, inter-active *Help* files provide all the instructions and details required to operate and administer the program suite.

Note: When applying power to the IP Office system, the Expansion Modules **must be** switched on **first**. If the main IP Office Module does not detect an item at power on it will never use it. If power is switched on from a central point for all modules, then, as the main unit is the slowest to start, this will be taken care of automatically.

When powered up correctly, all modules will display a steady green light in the center of each module. When connection is established with ports, the port socket on the appropriate module will show a green LED, e.g. the hub port connected to your PC for programming. IP Office systems are ready for use within 1 minute of power on.

Programming Tools

The IP Office supports programming through any one of it's 10/100 Base-T hub port connections. The tools required for programming of a newly installed IP Office system are:

- PC running Windows 95/98, NT, 2000 or ME (see page 35).
- PC with a LAN (NIC) card with either a fixed IP address (allocated by your system administrator) or by using DHCP to obtain an IP address.
- IP Office Cat. 5E patch cable (red – supplied with system see page 57).
- IP Office Administration CD (supplied with system).
- IP Office Manager Application Manual (supplied on CD with system).
- IP Office Feature Key (where software that requires a Licence Key is to be installed).

Note: Once installed, the software level of all software fitted to the IP Office system can be identified. With Manager running, use *File/Advanced/Upgrade* to display menu. Refer to the Manager Application Manual for details of system configuration, software upgrade, etc.

PC to IP Office LAN Port Connection

An IP Office system, when first powered up, will scan the LAN for a DHCP server that will allocate it with an IP address. If the IP Office system does not find a DHCP server then it will automatically become a DHCP server itself with an IP address of 192.168.42.1. The IP Office system will allocate an IP address to the PC if required. Initially, the IP Office system assumes that all addresses are on the local LAN and that the PC software supplied uses broadcast to establish communication with the IP Office system.

The IP Office hub port can be connected in two ways; either directly to a PC or as part of a LAN. Both methods use an IP Office Cat. 5E patch cable (see page 57) connected between one of the LAN hub ports on the front of the IP Office base unit and the PC.

- **Direct Connection:**

This method is used for local system programming directly from a PC.

- **LAN Network Connection:**

This is the option to use for remote programming access. It will require liaison with the LAN network manager to obtain the IP address details and to ensure that the IP traffic routing is allowed. When connected to an IP LAN network, you must consult with the Network Manager to obtain the required IP settings. For IP operation the IP Office requires a static IP address including a subnet mask and default gateway value.

Initial Programming

All the software used to configure and manage the IP Office system must be installed on your PC from the supplied Administration CD. With the initial assembly completed (see page 38) and your PC connected to the IP Office system, insert and run the Administration CD. From the initial 'Welcome' screen, click on **Next**. The Administration Installation Wizard will confirm communication with the IP Office system with an *Only configured units were found* message together with an invitation to *Install Suite*. If a *No units were found* message appears, check that the IP Office has been switched on and the PC/IP Office connection established. You can still install the software on your PC, but of course, you will not be able to configure your system until connection is established. Perform the following:

- Click on **Install Suite**, wait for the *Install Welcome* message and click on **Next**.
- Either accept the default location (click on **Next**) of where the Administration Suite is to be installed or change the location by clicking on **Browse** and entering a new location.
- Select which components you wish to install by selecting the appropriate boxes (*Manager* and *Voice Mail* are default minimums).
- Name the program folder or accept the default (**IP Office**) and wait for the Administration Suite installation to be completed.
- On completion click **Finish**. (You are presented with the option to restart your PC now or later). From the **Program** file (or the file you selected), select *IP Office* and *Manager*.
- You will be requested to enter both the *Operator Name* and *Password*. This password gains access to the Configuration Tree facilities allocated to the named operator. At default, five options are available, but, for full access, select *Administrator*:

	Name	Password
For full facilities access:	<i>Administrator</i>	<i>Administrator</i>

- The *Configuration Tree* blank screen is displayed. To display the facilities available for this named operator's Configuration Tree, from **File** select **Open** and, when requested, enter the password for the *IP Office* unit. The default for the *IP Office* unit is *password*.

You must change the operator Names, their Passwords and the Password for the IP Office unit as soon as possible. A combination of at least 8 alpha and numeric characters is recommended for passwords, avoiding the use of common words.

- From either Configuration Tree, select **File** and **Change Password**. The operator *Name* is displayed, together with both the *Password* and *Confirm Password* as a series of xxxxx's. Enter the new *Password* and *Confirm Password*. Click **OK** and **Save As**.
- From the Configuration Tree for the *Administrator*, double click on the **System** icon to display the *System Configuration* menu for the IP Office unit. The following items must be set/changed:

Name: A name to identify this system. Used to identify the configuration by its location or customer's company name.

Locale: This option sets country variations, e.g. US = enu, UK = eng, Netherlands = nld, Germany = deu. Locale defines the country dependent default ring sequences, display types/language, etc. This option is automatically set dependent on the Regional Settings of the PC on which the Manager is running. For instance, if this setting defaults to *eng* rather than *enu* this is because the Regional Settings of the PC are set to English (United Kingdom) therefore change the Regional Settings to English (United States).

Password: This is the password (default *password*) for controlling access to the IP Office unit and is required to upgrade, reboot and send or receive configurations from the unit. **Change this password as soon as possible.**

Basic programming is completed and you can now configure the system to the customer's requirements. Full details on configuration and administration are contained in the inter-active *Help* files and/or the Manager Application Manual. Press **F1** to access the *Help* files.

Telephone Installation

Checking Telephones

It is preferable to leave connection of telephones until after installation of other IP Office equipment and full system programming has been completed (including the set-up of directory numbers and names). Note that by IP Office telephones we mean devices manufactured and supplied as part of the IP Office product range and not third party telephone devices.

While installing and checking each telephone, it may also be required to do some basic telephone programming such as setting-up call forwarding, call pickup, group numbers, etc.

The detailed instructions for setting-up these feature are contained in the Manager Application Manual and within the Configuration Tree *Help* files. With the configuration tree for *Administrator* open, press **F1** to access the *Help* files.

The following instructions are the minimum required for testing and wall mounting of IP Office telephones. Detailed instructions for testing, wall mounting and using IP Office telephones are contained in the appropriate Installation and User Guides contained on the CD supplied with each system.

Connecting & Testing IP Office Telephones

Use the following process to connect and check IP Office telephones.

To check a IP Office telephone :

1. Unpack the telephone and check that all parts are present including labels and user guides.
2. Insert the handset cord into the base. Route the cord through the cable channels to come out at the side of the telephone.
3. Insert the line cord into the wall socket.
4. Insert the line cord into the telephone's base and route the cord through the cable channels to come out at the side/rear of the telephone.
5. Lift the handset, check that you hear dial tone and make a test call to another extension.
6. On a display telephone, ensure that the display shows the number called and that the display is in the correct language.

Note: On 44/4600 series telephones, the line cord is fitted with an RJ11 plug. In which case, when connecting directly to an IP Office module, an RJ11/RJ45 adapter should be used. Similarly, the structured wiring should terminate in RJ11 sockets.

Connecting & Checking Two-Wire Telephones

All two-wire devices (POTS) should be tested according to the manufacturer's instructions before connection to the IP Office system. Connect the two-wire device and make a test call.

Power Fail Telephones and Sockets

All power fail sockets (on IP400 Analog Trunk 16 modules only – see page 31) must be tested.

To test a power fail socket :

1. Locate the socket and check that it is clearly labeled as a power fail socket.
2. Connect a telephone to the socket.
3. With power to the IP Office system switched on, make a test call.
4. Switch the power to the IP Office system off and again make a test call.
5. Switch the power to the IP Office system back on again.
6. Repeat the test for any other power fail sockets.

Note: Where E911 statutory requirements for discrete location identification of a power fail phone are required on the transmitted CLI, ensure that the relevant installation programming is completed.

Wall Mounting 2000 Series Telephones

Mounting brackets exist which clip onto the base on IP Office telephones. These brackets (two required per telephone) can be used to either raise the desk position of the telephone or for wall mounting. Before wall mounting a telephone, check that the surface is flat, vertical and not subject to movement or vibration.

To wall mount an IP Office telephone :

1. Using the dimensions given below, mark the position for the screw holes. Ensure that adequate clearance above and below the telephone is allowed.
2. Drill the necessary holes and insert the wall plugs.
3. Insert the screws, leaving the heads approximately 3mm proud of the surface (check by clipping a bracket over the screw head).
4. Attach the brackets to the telephone. Then slide the bracket key-slots over the screw-heads.
5. Reverse the position of the handset retainer tab (located below the hook switch on the telephone). This keeps the handset in place whilst the telephone is mounted on the wall.

Additional Items :

- Two No. 8 Pan head or Round head screws.
- Two wall plugs.
- Drill and drill bit.
- Screwdriver.

IP Office 2030/50 Telephones (Not to scale)

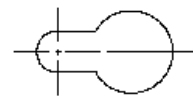

Wall Mounting Dimensions (not to scale)

Horizontal: 129mm between centres
Use No. 8 Pan Head or Screws
Clearance: Allow 170mm below, 70mm above and 40 mm either side



IP Office 2010 , IP Office 20AT Telephones (Not to scale)

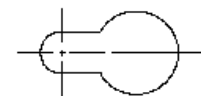

Wall Mounting Dimensions (not to scale)

Horizontal: 78mm between centres
Use No. 8 Pan Head or Screws
Clearance: Allow 170mm below, 70mm above and 40 mm either side



Wall Mounting 44/4600 & 6400 Series Telephones

The following pictorial instructions, although for a 4600 telephone, provide a general overview on how to wall mount both series of telephones. For safety instructions and details, refer to the specific instructions for each telephone type (supplied on the CD with the IP Office system).

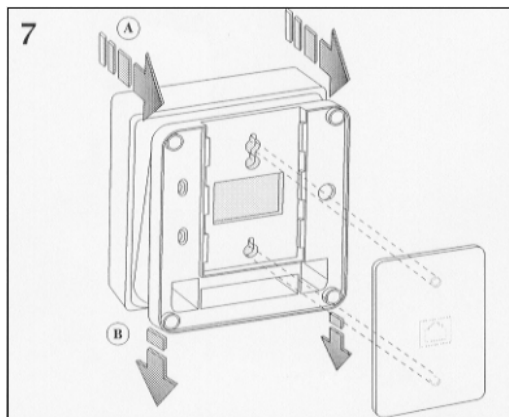
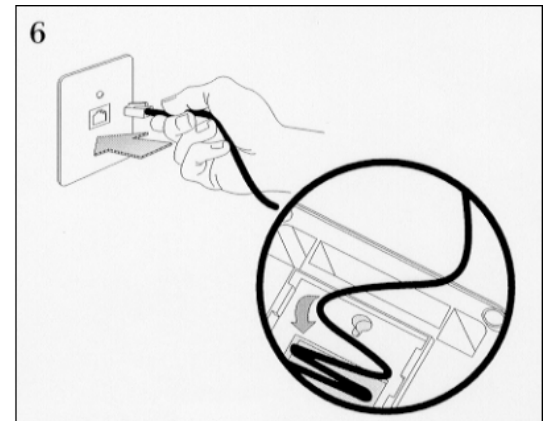
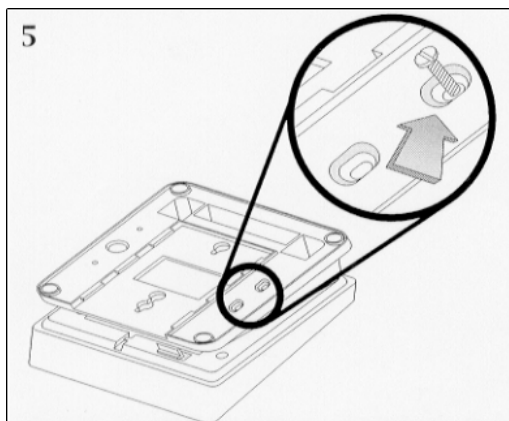
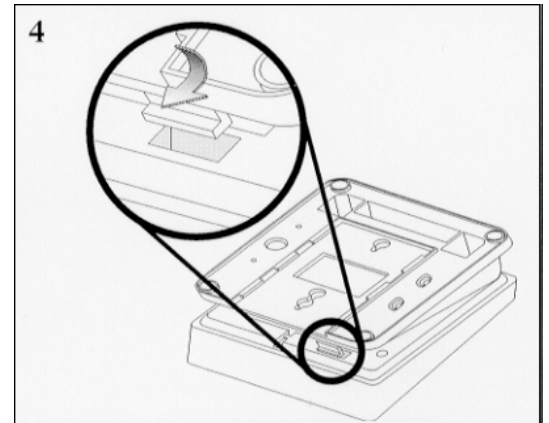
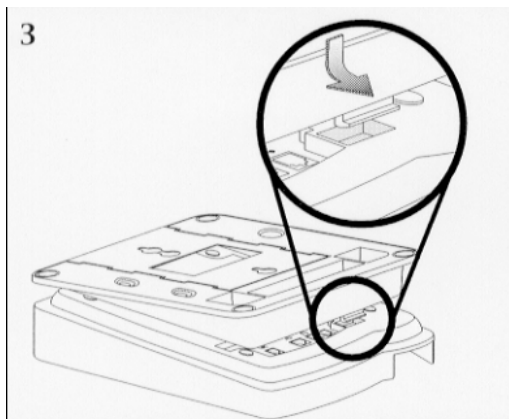
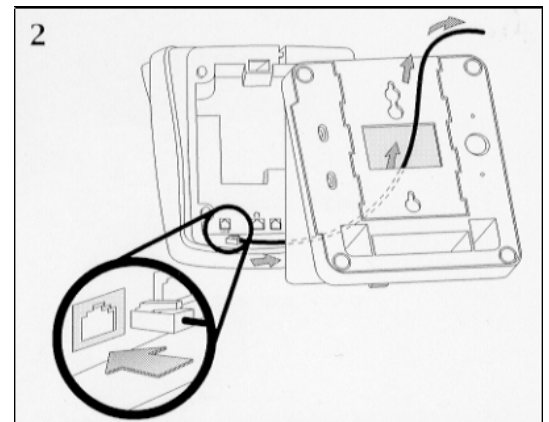
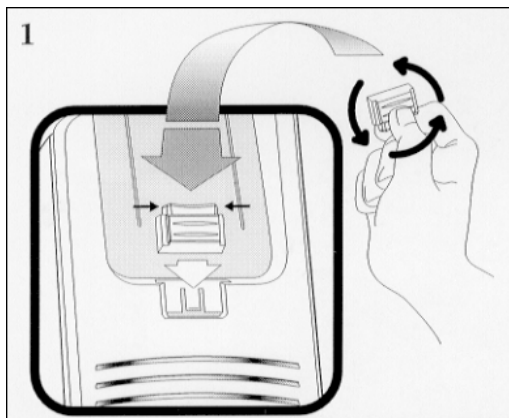

System Handover

Checklist

Equipment :

- Have all extensions been tested?
- Have all exchange lines been tested?
- Have all private wires been tested?
- Is system programming in line with the customer specification?
E.g. all specified applications, CTI settings, etc.
- Has the customer been made aware of the drop back (power fail) locations?
Are these been clearly marked and have they been tested?
- Has the mains supply (and any UPS if fitted) been tested?

Wiring :

- Have the trunk modules and Analog Trunk 16, where equipped, been fitted with the appropriate functional/protective grounds (see page 37).
- Is the distribution wiring (structured cabling) satisfactory to the required national standards?
- Are all wires and cables clearly labeled.
- Is the site clean and tidy with all rubbish removed?

Information :

- Have the telephone user guides been issued to the user.
- Has the customer been made aware of the telephone number for maintenance/fault reports.

Feature Key :

- Where a Feature Key has been used (for software requiring a license), record it's physical location (location of the PC is it plugged into) and leave a record of such on site with the system.

Technical Data

Port Pinouts

This section provides the technical specifications for the IP Office ports with the exception of the USB port and cable. All diagrams are viewed from the front. The USB port and cable (up to 5 meters) are standard. Refer to page 55 for cable details.

Note: Throughout the following, Tx = from IP Office and Rx = to IP Office.

Analog Trunk Ports (RJ45)

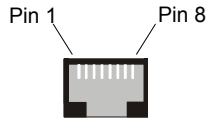

Pin No.	Description
1-3	Do not use
4	Ring
5	Tip
6-8	Do not use

Power Fail and POT Ports (RJ45)

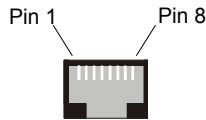

Pin No.	Description
1 & 3	Do not use
2	Connected to pin 6*
4	Ring
5	Tip
6	Connected to pin 2*
7-8	Do not use

* Pins 2 and 6 are shorted together and, via a 'ringer' capacitor, connected to in 5.

DS/DT Ports (RJ45)

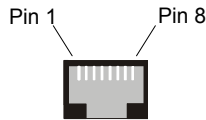

Pin No.	Description
1-3	Do not use
4	Sig 1
5	Sig 2
6-8	Do not use

ISDN Port – BRI (RJ45)

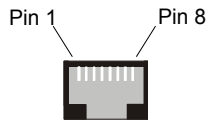

Pin No.	Description	Signal Direction
3	Transmit Data (Tx-A)	➔
4	Receive Data (Rx-A)	➔
5	Receive Data (Rx-B)	➔
6	Transmit Data (Tx-B)	➔

ISDN Port – PRI (RJ45)

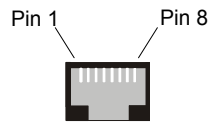

Pin No.	Description	Signal Direction
1	Receive Data (Rx-A)	←
2	Receive Data (Rx-B)	←
4	Transmit Data (Tx-A)	→
5	Transmit Data (Tx-B)	→

LAN Port – 10/100 BaseT

For IP Office 403/406 the information below refers to LAN ports 1 – 7. Port 8 is switchable in software (exchanges Tx and Rx signals).

For IP412 and WAN3, both ports have the Rx and Tx connections exchanged.

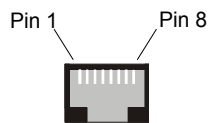

Pin No.	Description	Signal Direction
1	Receive Data (Rx-A)	←
2	Receive Data (Rx-B)	←
3	Transmit Data (Tx-A)	→
6	Transmit Data (Tx-B)	→

DTE Port (25 Way or 9 Way D-Type socket)

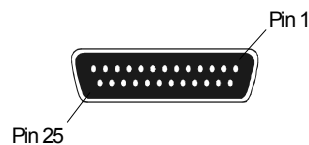

Pin No (25 Way).	Pin No (9 Way).	Description	Signal Direction
2	3	Receive Data (Rx)	←
3	2	Transmit Data (Tx)	→
4	7	Request to Send (RTS)	←
5	8	Clear to Send (CTS)	→
6	6	Data Set Ready (DSR)	→
7	5	Signal Ground	
8	1	Data Carrier Detect (DCD)	→
20	4	Data Terminal Ready (DTR)	←
22	9	Ring Indicator (RI)	→

Audio Port (3.5mm Stereo Jack Socket)

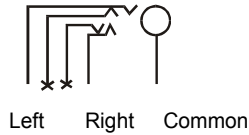

Pin No.	Description	Signal Direction
Common	Common	
Left	Audio in – Left Channel	←
Right	Audio in – Right Channel	←

Expansion Port (RJ45 Socket)

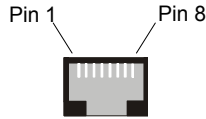

Pin No.	Description	Signal Direction
1	Receive Data (Rx-B)	←
2	Receive Data (Rx-A)	←
3	Sync-B	→
4	Clock (Clk-B)	→
5	Clock (Clk-A)	→
6	Sync-A	→
7	Transmit Data (Tx-B)	→
8	Transmit Data (Tx-A)	→
Shield	Connected to chassis	Ground

External Control Port (3.5mm Stereo Jack Socket)

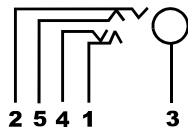

Pin No.	Description
1	Circuit 1
2	Circuit 2
3	0 Volts (Ground/Chassis)
4	Not Connected
5	Not Connected

Control Circuit	Information
Control Circuit 1	Pin 2 and Pin 3, ensure that Pin 2 is at a positive voltage with respect to Pin 3.
Control Circuit 2	Pin 1 and Pin 3, ensure that Pin 1 is at a positive voltage with respect to Pin 3.

Each circuit can be switched independently.

Switch Setting	Information
ON	Low resistance between Pins.
OFF	High resistance between Pins.

WAN Port (37 Way D-Type Socket)

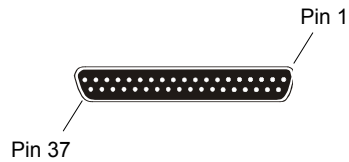

Pin No.	Description	Signal Dir.	Pin No.	Description	Signal Dir.
1	V11 Rx-B	←	20	V11 Rx-A	←
2	V11 Ind-A	←	21	V11 Ind-B	←
3	V11 Clk-A	←	22	V11 Clk-B	←
4	V11 Tx-A	→	23	V11 Tx-B	→
5	V11 Ctl-B	→	24	V11 Ctl-A	→
6	V11 Gnd		25	WAN ID 0	←
7	WAN ID 1	←	26	V24 Tx	→
8	V24 DTR	→	27	V24 RTS	→
9	V24 Rx	←	28	V24 RxClk	←
10	V24 TxClk	←	29	V24 RI	←
11	V24 DCD	←	30	V24 DSR	←
12	V24 CTS	←	31	N/C	
13	N/C		32	V35 Tx-A	→
14	V35 Tx-B	→	33	V35 SCTE-A	→
15	V35 SCTE-B	→	34	V35 Gnd	
16	V35 Rx-B	→	35	V35 Rx-A	→
17	V35 TxClk-B	←	36	V35 TxClk-A	←
18	V35 RxClk-B	←	37	V35 RxClk-A	←
19	CHASSIS				

- Notes:**
1. For the USA, only FCC Part 68 registered data circuit terminal equipment should be connected to the WAN Ports.
 2. * For X21, V24/28 and V35 variants, pins 7 and 25 are connected as follows:
X21: Pin 7 is connected to pin 6
V24/28: Pin 25 is connected to pin 6
V35: Pins 7 and 25 are connected to pin 6

Cables

This section provides information about the cables that are used with IP Office.
 Refer to page 51 for port pin out details.
 All of the following cables are for internal use only.
 All structured cabling/site wiring **must** conform to all local regulations.

- CAUTION:**
1. All ISDN and WAN cables should not be longer than 5 meters in length.
 2. For Analog Trunk cables, to reduce the risk of fire, use only No. 26 AWG or larger telecommunications line cord.

DTE Cable

SAP Code.: - 700213432 (25 Way)

SAP Code.: - 700218209 (9 Way)

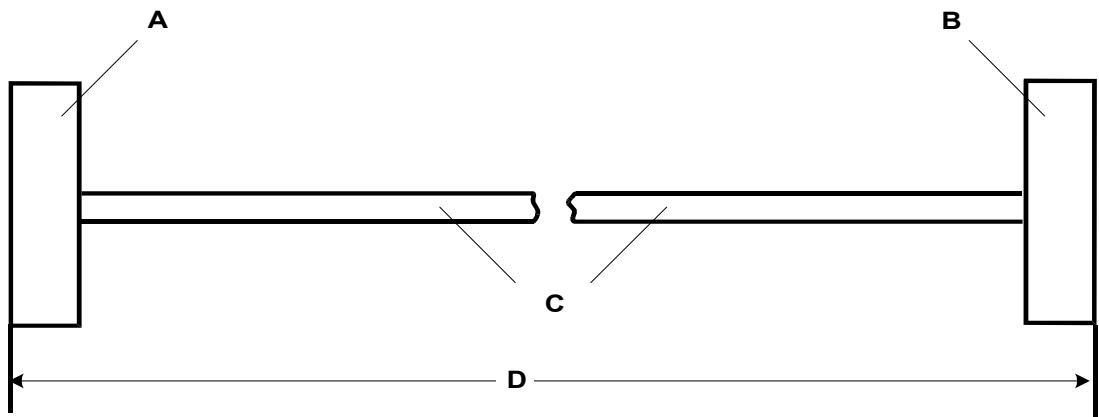

- A 25 Way (or 9 Way on IP412) D-Type Plug with UNC 4-40 locking screws.
- B 9 Way D-Type Socket with UNC 4-40 locking screws.
- C 12 core screened cable - each core is 7/0.203mm (24 AWG) tinned copper stranded wire, nominal capacitance of 95pF/m, resistance of 92 Ω/km, screened with tinned copper braid, maximum working voltage of 440V rms and a Maximum current per core of 1A rms
- D 2 meters.

Pin Connections

End A (25 Way)	End A (9 Way)	Name	End B
2	3	Receive data	3
3	2	Transmit Data	2
4	7	RTS (Request To Send)	7
5	8	CTS (Clear To Send)	8
6	6	DSR (Data Set Ready)	6
7	5	Ground	5
8	1	DCD (Data Carrier Detect)	1
20	4	DTR (Data Terminal Ready)	4
22	9	RI (Ring Indicator)	9

DT Line Cord for Structured Cabling

SAP Code.: - 700047871

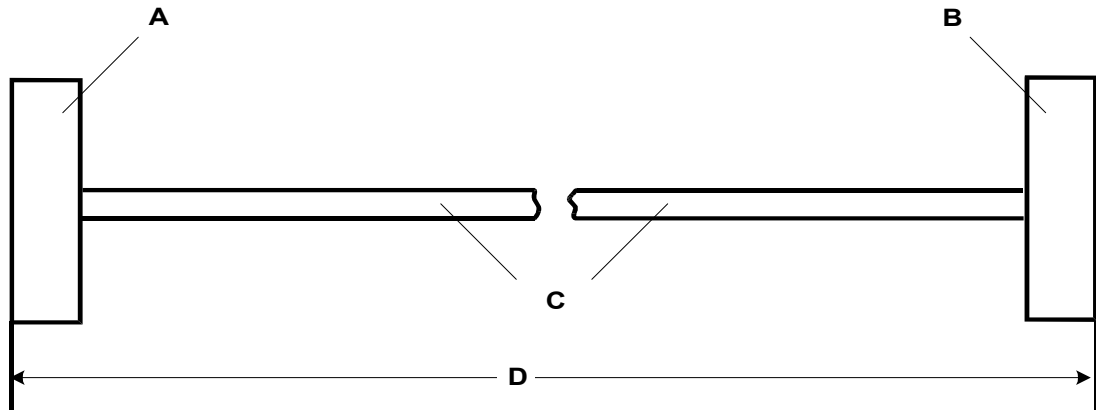

- A RJ11 Plug.
- B RJ45 Plug.
- C Cable.
- D 4 meters.

Pin Connections

RJ11 Pin Number	RJ45 Pin Number
3	5
4	4

Caution: Other connections may be present in cables and or structured cabling. For 4450DS modules, this cable can be used to connect the module's PSU *Line* socket and the structured cabling. The PSU's *Tel* socket **must only be connected** to the *Line* socket of the associated 4424D telephone using the D4BU cable supplied with the PSU.

This cable can be used to replace the RJ11 to BT Newplan plug that is attached to the 20 series telephones to allow connection to structured cabling.

PRI/BRI ISDN Cable

SAP Code:- 700213440

Supply: As standard with IP Office systems.

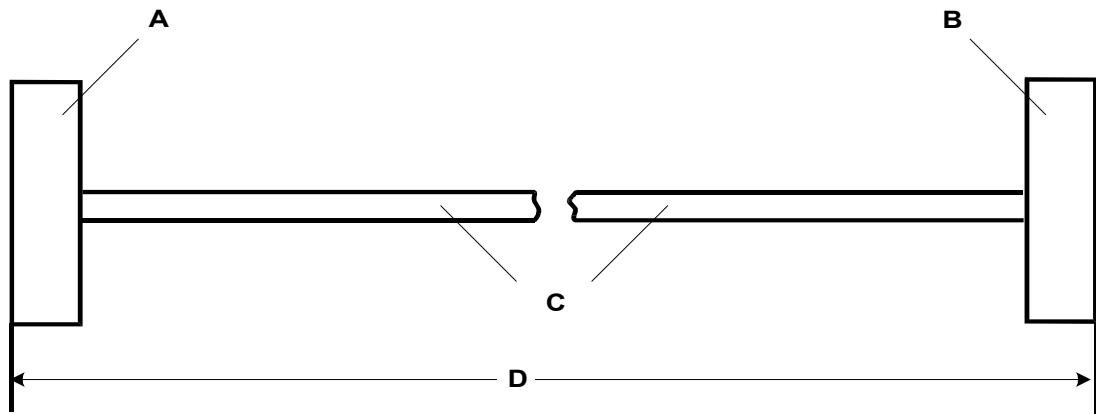

- A RJ45 Plug.
- B RJ45 Plug.
- C Cat 5 UTP cable - **RED**.
- D 3 meters.

Pin Connections

End A	BRI	PRI	Color	Cable Notes	End B
4	*Rx-A	*Tx-A	Blue/White	Twisted pair	4
5	*Rx-B	*Tx-B	White/Blue	Twisted pair	5
3	*Tx-A	---	White/Green	Twisted pair	3
6	*Tx-B	---	Green/White	Twisted pair	6
1	---	*Rx-A	White/Orange	Twisted pair	1
2	---	*Rx-B	Orange/White	Twisted pair	2
7	---	---	White/Brown	Twisted pair	7
8	---	---	Brown/White	Twisted pair	8

* With reference to the TE.

► Pins 7 and 8 are through connected for ease of construction. They are not actually used.

LAN Interconnect Cable

SAP Code:- 700213465

Supply: The cable is supplied with the WAN3 Expansion Module.

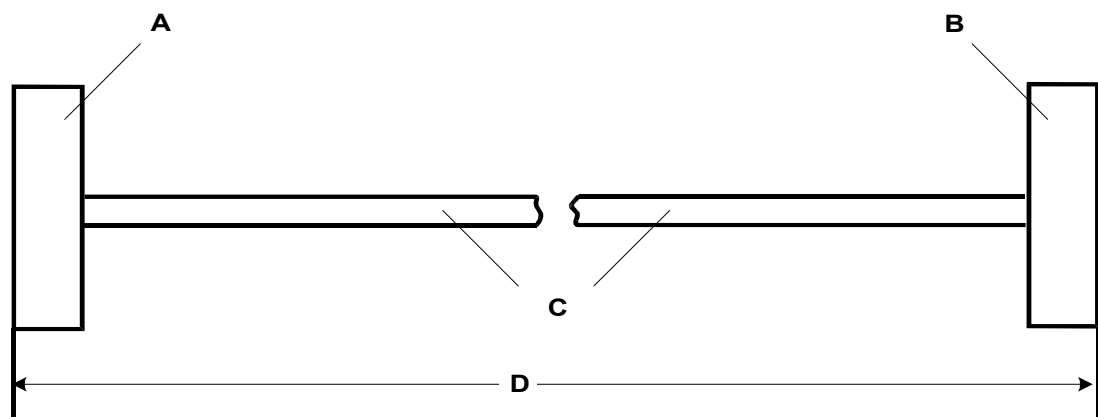

- A RJ45 Plug.
- B RJ45 Plug.
- C Cat 5 UTP cable - **GREEN**.
- D 1 meter.

Pin Connections

End A	Color	Cable Notes	End B
1	White/Orange	Twisted Pair	1
2	Orange/White		2
3	White/Green	Twisted Pair	3
6	Green/White		4
4	Blue/White	Twisted Pair	5
5	White/Blue		6
7	White/Brown	Twisted Pair	7
8	Brown/White		8

- ▶ This cable is used:
 - When connecting IP Office hub ports 1 - 7 directly to a PC.
 - When connecting a WAN3 to an IP403/406 hub port which is located in the same cabinet as the IP Office.

Pins 4,5,7 and 8 are through connected for ease of construction. They are not actually used.

LAN Cable

SAP Code:- 700213481

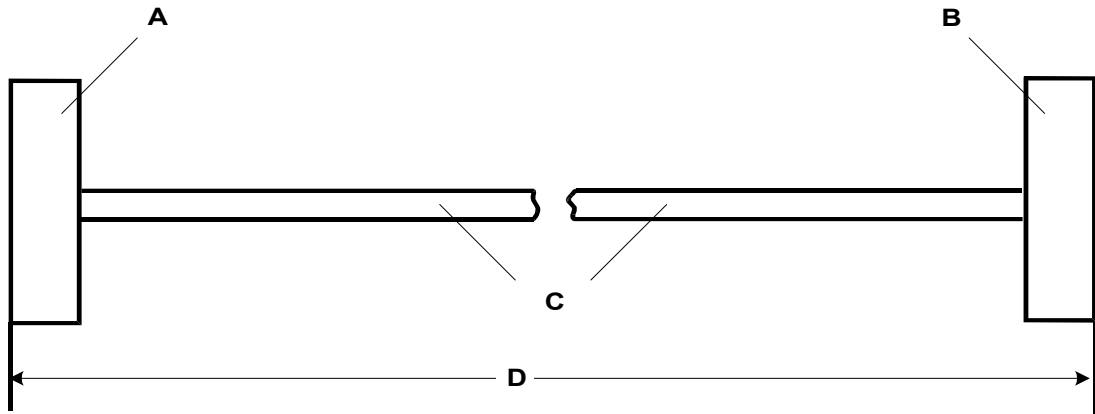

- A RJ45 Plug.
- B RJ45 Plug.
- C Cat 5 UTP cable - **GREY**.
- D 3 meters.

Pin Connections

End A	Color	Cable Notes	End B
1	White/Orange	Twisted Pair	1
2	Orange/White		2
3	White/Green	Twisted Pair	3
6	Green/White		6
4	Blue/White	Twisted Pair	4
5	White/Blue		5
7	White/Brown	Twisted Pair	7
8	Brown/White		8

- ▶ This cable is used:
 - When connecting IP Office hub ports 1 - 7 directly to a PC.
 - When connecting a WAN3 port to an IP403/406 hub port which is not located in the same cabinet as the IP Office.
- Pins 4, 5, 7 and 8 are through connected for ease of construction. They are not actually used.

LAN Crossover Cable

SAP Code:- 700213473

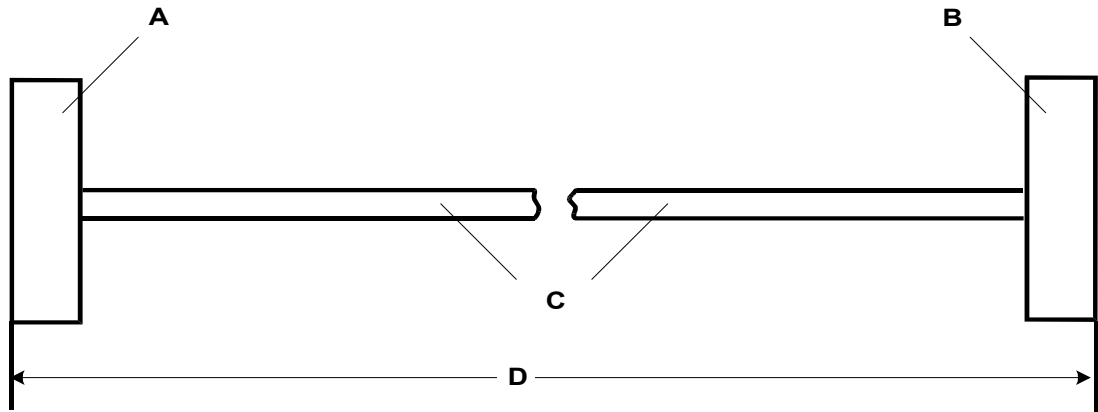

- A RJ45 Plug.
- B RJ45 Plug.
- C Cat 5 UTP cable - **BLACK**.
- D 3 meters.

Pin Connections

End A	Color	Cable Notes	End B
1	White/Orange	Twisted Pair	3
2	Orange/White		6
3	White/Green	Twisted Pair	1
6	Green/White		2

- This cable is used when connecting Hub Ports 1 - 7 directly to another Hub and for connecting a WAN3 to an IP412.

Expansion Interconnect Cable

SAP Code:- 700213457

Supply: One per Expansion Module.

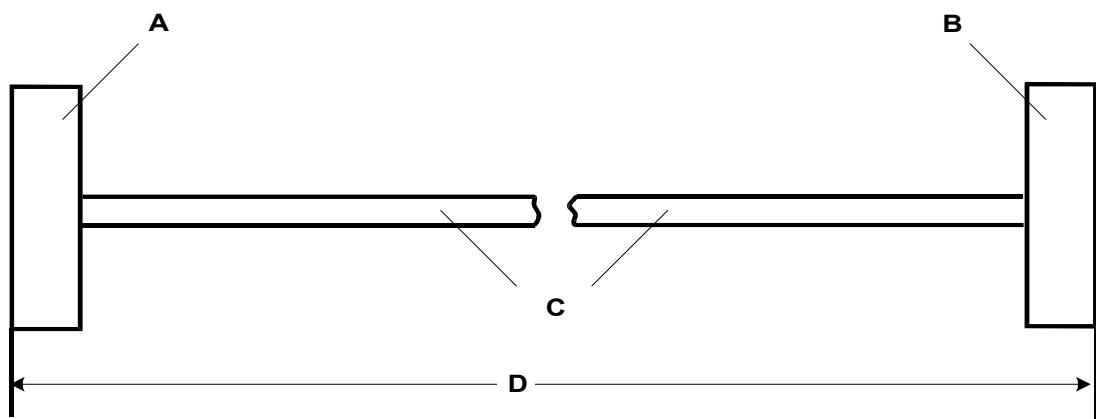

- A Shielded RJ45 Plug.
- B Shielded RJ45 Plug.
- C STP (Shielded Twisted Pair) cable - **BLUE**.
- D 1 meter.

Pin Connections

End A	Name	Color	Cable Notes	End B
1	Rx-A	White/Orange	Twisted Pair	1
2	Rx-B	Orange/White		2
3	Sync-A	White/Green	Twisted Pair	3
6	Sync-B	Green/White		6
4	Clock-A	Blue/White	Twisted Pair	4
5	Clock-B	White/Blue		5
7	Tx-A	White/Brown	Twisted Pair	7
8	Tx-B	Brown/White		8

► The RJ45 Plug Shell at each end of the cable is connected to the STP Cable Drain Wire.

V.24/V.28 WAN Cable

SAP Code:- 700213416

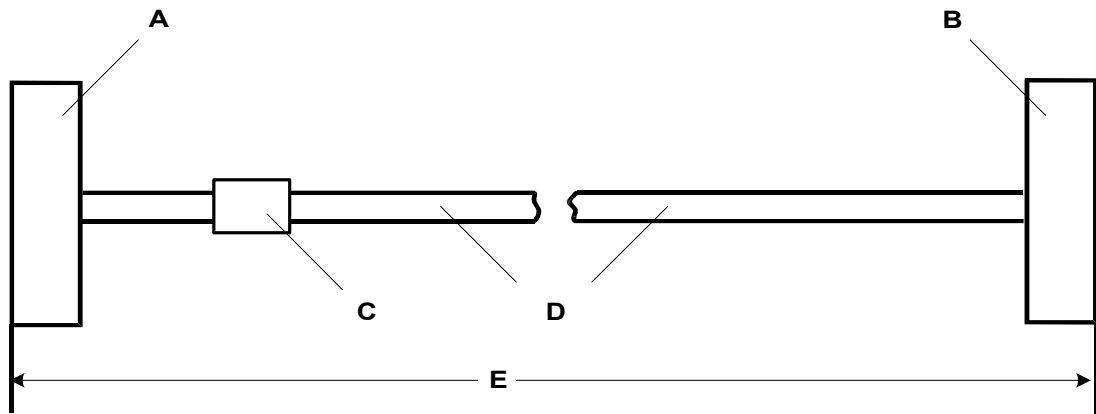

- A 37 Way D-Type Plug with UNC 4-40 locking screws.
- B 25 Way D-Type Plug with UNC 4-40 locking screws.
- C Label
- D 12 core screened cable - each core is 7/0.203mm (24 AWG) tinned copper stranded wire, nominal capacitance of 95pF/m, resistance of 92 Ω /km, screened with tinned copper braid, maximum working voltage of 440V rms and a Maximum current per core of 1A rms
- E 3 meters.

Pin Connections

End A	Name	End B
6	Ground	7
8	DTR (Data Terminal Ready)	20
9	Receive Data	3
10	Transmit Clock	15
11	DCD (Data Carrier Detect)	8
12	CTS (Clear To Send)	5
26	Transmit Data	2
27	RTS (Request To Send)	4
28	Receive Clock	17
29	RI (Ring Indicator)	22
30	DSR (Data Set Ready)	6

► Connect pin 25 to pin 6 at End A **only**.

Pin 19 at end A is connected to the Screened Cable Drain Wire.

The maximum core to core capacitance must not exceed 800pF.

This cable is used to connect a WAN port to a Digital leased Line.

X.21 WAN Cable

SAP Code:- 700213408

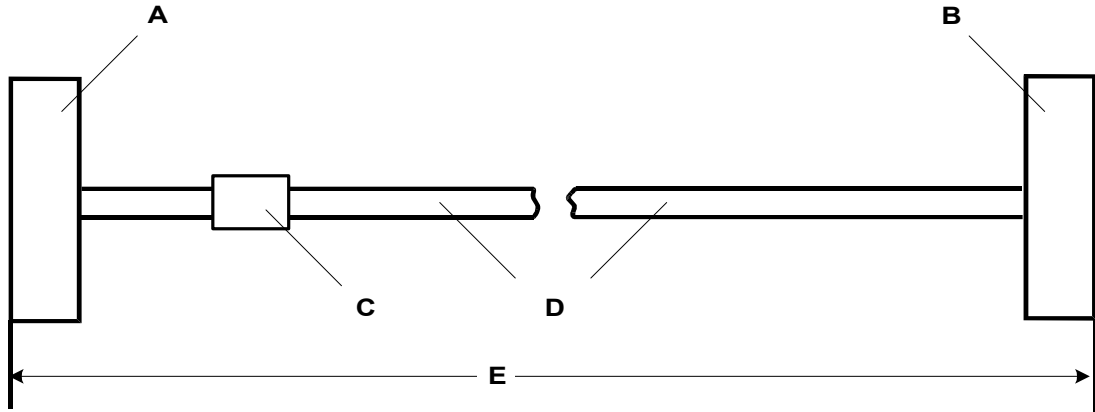

- A 37 Way D-Type Plug with UNC 4-40 locking screws.
- B 15 Way D-Type Plug with M3 locking screws.
- C Label
- D 6 twisted pair screened cable - each core is 7/0.203mm (24 AWG) tinned copper stranded wire, nominal capacitance of 98pF/m, impedance of 77 Ω at 1MHz, screened with aluminized tape and a tinned copper wire drain.
- E 3 meters.

Pin Connections

End A	Name	Cable Notes	End B
1	Receive (Rx-B)	Twisted Pair	11
20	Receive (Rx-A)		4
4	Transmit (Tx-A)	Twisted Pair	2
23	Transmit (Tx-B)		9
24	Control (Ctl-A)	Twisted Pair	3
5	Control (Ctl-B)		10
2	Indicate (Ind-A)	Twisted Pair	5
21	Indicate (Ind-B)		12
3	SE-Timing (S-A)	Twisted Pair	6
22	SE-Timing (S-B)		13
6	Ground	-----	8

► Connect pin 7 to pin 6 at End A **only**.

Pin 19 at end A is connected to the Screened Cable Drain Wire.

This cable is used to connect a WAN port to a Digital leased Line.

V.35 WAN Cable

SAP Code:- 700213424

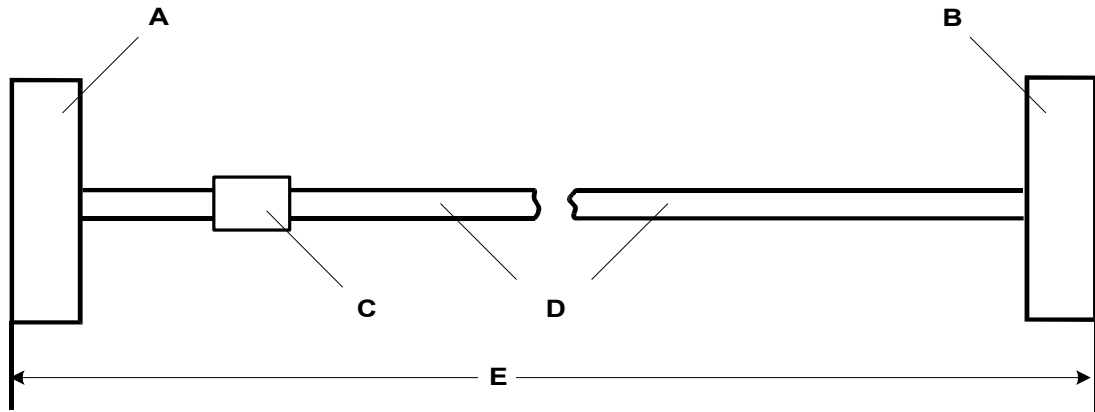

- A 37 Way D-Type Plug with UNC 4-40 locking screws.
- B 34 Way MRAC Plug.
- C Label
- D 10 twisted pair screened cable - each core is 7/0.203mm (24 AWG) tinned copper stranded wire, nominal capacitance of 98pF/m, impedance of $80 \Omega \pm 10\%$ at 1MHz, screened with aluminized tape and a tinned copper wire drain.
- E 3 meters.

Pin Connections

End A	Name	Cable Notes	End B
8	DTR (Data Terminal Ready)	----	H
11	DCD (Data Carrier Detect)	----	F
12	CTS (Clear To Send)	----	D
27	RTS (Request To Send)	----	C
29	RI (Ring Indicator)	----	J
30	DSR (Data Set Ready)	----	E
32	Transmit Data - A	Twisted Pair	P
14	Transmit Data - B		S
35	Receive Data - A	Twisted Pair	R
16	Receive Data - B		T
36	Transmit Clock - A	Twisted Pair	Y
17	Transmit Clock - B		AA
37	Receive Clock - A	Twisted Pair	V
18	Receive Clock - B		X
33	External Clock - A	Twisted Pair	U
15	External Clock - B		W
34	Ground	----	B

► Connect pins 7 and 25 to pin 6 at End A **only**.

Pin 19 at end A is connected to the Screened Cable Drain Wire.

The maximum core to core capacitance **must not** exceed 800pF.

This cable is used to connect a WAN port to a Digital leased Line.

Telephone Converter Cables

The following diagrams show the pin-outs of various Structured Cabling Telephone Converters. The first two telephone converters shown provide the required conversion allowing correct operation of the attached telephone.

Each telephone port on the **Phone** modules acts as a Master socket, thus only Slave Telephone Converters are required.

RJ45 - Compatible Converter

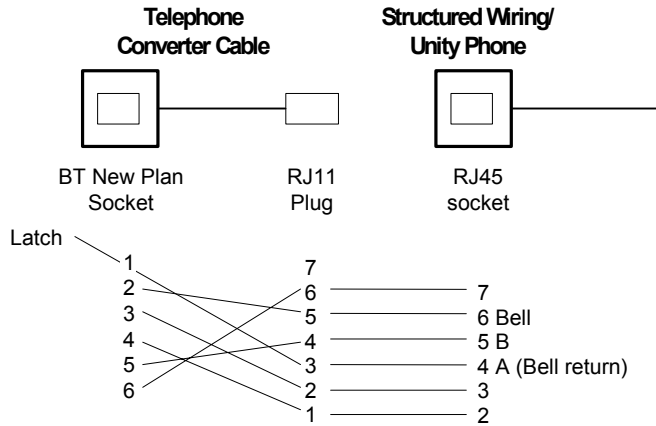

RJ11/45 Adapter

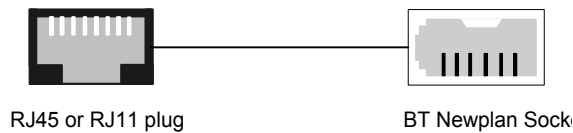

RJ11 Pin Number	RJ45 Pin Number	BT Newplan Socket Pin Number
3	4	3
4	5	4

Other connections are not relevant.

BT Newplan socket connections may be reversed as polarity is not important.

This adapter may be used with DT telephones fitted with BT Newplan plugs.

Out of Building Installation

In the USA only, installation of telephone and/or other standard (tip/ring) devices in another building requires the following:

- In-Range-Out-Of-Building (IROB) protectors, to protect the control unit and device from electrical surges, must be fitted as follows:
 - System telephone : two IROB protectors
 - Standard telephone : two IROB protectors plus one carbon block protector.
 Install the IROBs as per the instructions supplied with the IROB. Three versions are available as follows :
 - 146C - Trunks - SAP code 407228923
 - 146D - Two-wire - SAP code 407568146
 - 146E - TDL - SAP code 407568161
- Installation of a Contact Closure Adjunct controlled device outside the building requires a 146G Surge Protector – SCL/8 to protect the control unit from electrical surges.

Port Safety Classification

The Avaya IP Office systems have the following ports:

- Expansion ports
- 10/100 BaseT LAN ports
- Telephone ports which are either DT (A-Law encoding) or DS (μ -Law encoding)
- ISDN ports
- Analog ports
- Power Fail ports
- WAN ports
- DTE ports
- Audio I/P port
- DC Power Input port
- External Control port

These Ports are classified as follows:

Port Name	Port Description	Port Classification
PRI port	PRI ISDN connection (NET)	TNV (Operating within the limits of SELV)
BRI ports	BRI ISDN connection (NET)	TNV (Operating within the limits of SELV)
Analog ports	Two wire analog trunk	TNV3
Power fail ports	Two wire analog trunk	TNV3
DTE port	Async Data connection.	SELV
Telephone Ports	Telephone Extension ports	TNV2
WAN port	WAN connection (NET).	SELV
LAN ports	10/100 BaseT attachment to LAN.	SELV
Expansion ports	Expansion Module connector.	SELV
Audio port	Connector for Music on Hold.	SELV
External Control port	Connector for Controlling Ancillary circuits.	SELV
DC Input port	Connector for DC input power.	SELV

Interconnection circuits shall be selected to provide continued conformance with the requirements of EN 60950:1992/A3:1995 clause 2.3 for SELV circuits and with the requirements of clause 6 for TNV circuits, after connections between equipment.

Compliance with FCC Rules

Transmit and Receive Gain Settings for PRI/T1 and Analog Ports

The Gain settings are password controlled for use by qualified installation personnel only and must not be made available to the end user. The default gain settings of 0dB ensures compliance with FCC part 68 section 68.308(b)(5) and TIA/EIA-IS-968 Section 4.5.2.5. "Through transmission amplification from ports for the connection of separately registered equipment or from other network connection ports". Gain setting adjustment by unqualified personnel may result in violation of the FCC rules. Qualified personnel may adjust gain settings above these levels only where:

1. Measurement is made to ensure that the power levels sent to line at each network interface connected does not exceed the maximum levels specified in FCC part 68 section 68.308(b) and TIA/EIA-IS-968 Section 4.5 for that specific interface type.
2. Where gain adjustment away from the default values are made, precautions should be taken to ensure that the connection of terminal equipment is controlled by qualified installation personnel.

Technical Specifications

General

Dimensions	IP401: Width: 255mm. Height: 71mm. Depth: 235mm. IP403/6/12 and Expansion Modules : Width: 445mm. Height: 71mm. Depth: 245mm
Environmental	0 to +40°C. 95% relative humidity, non-condensing.
Weight (in Kgs)	Unit: 401 403 406 412 Analog16 DT/DS16 DT/DS30 WAN3 So8 Phone8 Phone16 Phone30 1.2 2.6 3.0 3.0 2.9 3.0 3.50 2.8 2.75 2.80 2.90 3.10
Power Supply Consumption (nominal Watts)	2.5mm DC inlet socket. 24Vdc Power input. Rating 24Vd.c., 2A max. Unit: 401 403 406 412 Analog16 DT/DS16 DT/DS30 WAN3 So8 Phone8 Phone16 Phone30 24 26 16 17.5 5 24 30 12 24 12 16 30
Lump-in-Line PSU	Power Requirements: I/P 100-240Vac, 50/60Hz, 81-115VA, Input current 2A max O/P 24Vdc, 1.875A, output Power 45W max. The Lump-in-line PSU is CE/UL/Dentori Safety Approved.

Interfaces

Interface	Information
DTE	25 way D-Type female connector, V.24/V.28. (9 way D-type on IP412s)
ISDN	ROW Interfaces: BRI : RJ45 sockets. ETSI S/T Interface to CTR3 for Pan European Connection. PRI E1: RJ45 socket. ETSI T Interface to CTR4 for Pan European Connection. PRI E1-R2: RJ45 socket. ETSI T Interface to CTR4 for Pan European Connection. PRI E1-R2: 75Ω BNC Coax.. ETSI T Interface. PRI T1: RJ45 socket: FCC Part 68/JATE connection. USA Interfaces: PRI T1 Service: Ground Start (GS) – Default, E&M, 56k data for 5ESS, 56/64/64 restricted for 4ESS PRI ISDN Switch support: 4ESS, 5ESS, DMS-100, DMS-250 (includes conformance to ANSI T1.607 & Bellcore Special Report SR4287, 1992 PRI ISDN Services: AT&T Megacom 800, AT&T WATS (4ESS), AT&T SDS Accunet 56kB/s & 64kB/s (4ESS), AT&T Multiquest (4ESS).
Analog ports	RJ45 sockets: Loop start/Ground start (regional dependant)
Power Fail ports	RJ45 sockets: telephone ports act as master sockets
ISDN Data Rates	BRI: B-channel 64kbps or 56kbps, D-channel 16kbps. PRI: B-channel 64kbps or 56kbps, D-channel 64kbps.
Telephone	RJ45 sockets. EU - Telephone ports act as master sockets. CLI Schemes: DTMFA, DTMFC, DTMFD, FSK and UK20. REN = 2 Off Hook current = 25mA. Ring Voltage = 40V (nominal) RMS. External Bell (via analog port); REN = 1
LAN	RJ45 sockets. Auto-negotiating 10/100BaseT Ethernet (10Mbps). Port 8 is MDI/MDIX switchable via the adjacent Cascade pushbutton switch. Refer to pages 15, 19 and 23.
WAN	37 way D-Type female sockets. X.21 interface to 2048k bps, V.35 interface to 2048k bps and V.24 Interface to 19k2 bps.
Audio	3.5mm Stereo Jack socket. Input impedance - 10k /channel. Maximum a.c. signal – 200mV rms.
External Control	3.5mm Stereo Jack socket. Switching Capacity - 0.7A. Maximum Voltage - 55V d.c. On state resistance - 0.7Ω. Short circuit current - 1A. Reverse circuit current capacity - 1.4A.

Protocols

Protocol		Information
A-Law	---	PCM encoding (mainly used outside N.America)
μ -Law	---	PCM encoding (mainly used in N.America and Japan)
V.120	---	A standard Rate Adaption mechanism.
V.110	---	A standard Rate Adaption mechanism.
PPP	RFC 1661	Point to Point Protocol.
LCP	RFC 1570	Link Control Protocol.
MP	RFC 1990	Multi-Link (Point to Point) Protocol.
PAP	RFC 1334	Password Authentication Protocol.
CHAP	RFC 1994	Challenge Handshake Authentication Protocol.
CCP	RFC 1962	Compression Control Protocol.
STAC	RFC 1974	Stac LZS Compression Protocol.
MPPC	RFC 2118	Microsoft Point to Point Compression (Protocol).
BACP	RFC 2125	Bandwidth Allocation Control Protocol.
IPCP	RFC 1332	Internet protocol Control Protocol.
TCP/IP	RFC 793	Transmission Control Protocol/Internet Protocol.
DHCP	RFC 1533	Dynamic Host Control Protocol.
NAT	RFC 1631	Network Address Translation.
BOOTP	RFC 951	Bootstrap Protocol.
TFTP	RFC 1350	Trivial File Transfer Protocol

Index

Analog 4.....	14, 18, 22
Analogue Ports	11, 15, 22
BRI.....	8, 14, 16, 18, 20, 22, 29, 33, 34, 38, 39, 51, 57, 66, 67
Cable ties.....	35
DECT	13
Digital leased circuit.....	12, 16, 20, 24, 30
Digital leased line.....	14, 18, 22
Dimensions	35, 67
Dust	36
Earthing	
Functional.....	37
Protective.....	31, 37
Environmental requirements.....	36
Extensions	26
Fault returns.....	38
Feature Key	35, 45, 50
Flooding	36
Humidity.....	36
IROB	65
ISDN interfaces.....	14, 18, 22
Licence Key	26, 35, 45
Lithium battery	6
Mains supply.....	36
NTU	12, 16, 20, 24, 30
Packaging.....	38
Parts required	35
PCM encoding	10, 14, 15, 27
μ-Law.....	11, 27
A-Law.....	10, 27
PCS level.....	32
Power	
Consumption.....	67
Supply	36
Power fail.....	31, 47
PRI E1	14, 16, 18, 20, 22, 67
PRI T1.....	14, 16, 18, 20, 22, 33, 67
Product description	5
Rack.....	5
Sales feature.....	12, 16, 20, 24, 30
Software Level	5, 45
Upgrade	45
Space requirements.....	35
Clearance.....	35
Height.....	35
Width.....	35
Temperature	36
Terminal installation.....	47
Testing terminals	47
Tools required.....	35
Trunk Modules	16, 20, 24
Unpacking.....	38
UPS Equipment	36
USB Interface	12, 16
Ventilation.....	36
Voice over IP	11, 15, 19
Weight.....	67

Performance figures and data quoted in this document are typical, and must be specifically confirmed in writing by Avaya before they become applicable to any particular order or contract. The company reserves the right to make alterations or amendments to the detailed specifications at its discretion.

The publication of information in this document does not imply freedom from patent or other protective rights of Avaya, or others.

Intellectual property related to this product (including trademarks) and registered to Lucent Technologies has been transferred or licensed to Avaya.

All trademarks identified by ® or TM are registered marks or trademarks, respectively, of Avaya Inc. All other trademarks are the property of their respective owners.

This document contains propriety information of Avaya and is not to be disclosed or used except in accordance with applicable agreements.

Any comments or suggestions regarding this document should be sent to "wgctechpubs@avaya.com".

© Copyright 2002 Avaya

All rights reserved.

Avaya Global SME Solutions
Sterling Court
15 - 21 Mundells
Welwyn Garden City
Hertfordshire
AL7 1LZ
England

Tel: +44 (0) 1707 392200

Fax: +44 (0) 1707 376933

Web: <http://www.avaya.com>.

Free Manuals Download Website

<http://myh66.com>

<http://usermanuals.us>

<http://www.somanuals.com>

<http://www.4manuals.cc>

<http://www.manual-lib.com>

<http://www.404manual.com>

<http://www.luxmanual.com>

<http://aubethermostatmanual.com>

Golf course search by state

<http://golfingnear.com>

Email search by domain

<http://emailbydomain.com>

Auto manuals search

<http://auto.somanuals.com>

TV manuals search

<http://tv.somanuals.com>