



# **TransTalk<sup>®</sup> 9000**

## **Digital Wireless System**

MDW 9040 Wireless Pocket Phone  
Installation and Use

503-801-190  
Comcode 700060940  
Issue 2  
February 2001

© 2001 by Avaya Communication. All rights reserved.

For trademark, regulatory compliance, and related legal information, see the *Copyright and Legal Notices* section.

# Copyright and Legal Notices

<b>Copyright</b>	© 2001 by Avaya Communication. All rights reserved. Printed in U.S.A.
<b>Notice</b>	<p>Every effort has been made to ensure that the information in this book was complete and accurate at the time of printing. Information, however, is subject to change. The pictures in this book are for illustrative purposes; your actual hardware may look slightly different.</p> <p>This document was prepared by the Product Publications Department of the Global Learning Solutions Division of Avaya. U.S. offices are located in Denver, CO; Columbus, OH; Holmdel, NJ; and Basking Ridge, NJ.</p>
<b>Federal Communications Commission and Industry Canada (IC) Information</b>	For details, see Appendix B.
<b>Security</b>	<p>Toll fraud, the unauthorized use of your telecommunications system by an unauthorized party (for example, persons other than your company's employees, agents, subcontractors, or persons working on your company's behalf), can result in substantial additional charges for your telecommunications services. You are responsible for the security of your system. There may be a risk of toll fraud associated with your telecommunications system. You are also responsible for programming and configuring your equipment to prevent unauthorized use. Your system administrator should read all documents provided with this product to fully understand the features that can introduce the risk of toll fraud and the steps that can be taken to reduce that risk. Avaya does not warrant that this product is immune from or will prevent unauthorized use of common-carrier telecommunication services or facilities accessed through or connected to it. Avaya will not be responsible for any charges that result from such unauthorized use.</p>
<b>Trademarks</b>	DEFINITY, MERLIN, MERLIN LEGEND, PARTNER, and TransTalk are registered trademarks of Avaya; MERLIN MAGIX is a trademark of Avaya. Supra is a registered trademark of Plantronics, Inc.
<b>Warranty</b>	Avaya provides a limited warranty for this product; see Appendix A.
<b>Ordering Information</b>	The order number for this book is 503-801-190. To order additional copies of these reference materials, call 1-800-457-1235 or 317-322-6791. To order parts and accessories, see Appendix D, "Ordering Replacement and Optional Parts."

## Copyright and Legal Notices

---

### Customer Support

In the continental U.S., call 1-800-628-2888 if you need assistance when installing the Dual Radio Module for an MDW 9040 Wireless Pocket Phone with a PARTNER, MERLIN, MERLIN LEGEND, or MERLIN MAGIX System. Consultation charges may apply.

In the continental U.S., call 1-800-225-7585 if you need assistance when installing the Dual Radio Module for an MDW 9040 Wireless Pocket Phone with a DEFINITY System, or contact the Avaya Customer Care Center at 1-800-242-2121. Consultation charges may apply.

Outside the continental U.S., contact your Avaya Representative or local Authorized Dealer.

# Contents

<b>1 Introduction</b>	<b>1</b>
About TransTalk® 9000 Products . . . . .	1
What Is a Wireless Phone? . . . . .	1
About the MDW 9040 Pocket Phone . . . . .	1
About the MDW 9040 Pocket Phone in a Dual Zone Configuration . . . . .	2
Privacy Information . . . . .	2
Where Can You Use Your Pocket Phone? . . . . .	2
Parts List . . . . .	2
<b>2 Installing the MDW 9040 Pocket Phone System</b>	<b>5</b>
Important Safety Instructions . . . . .	5
Guidelines for Safe and Efficient Operation . . . . .	5
Basic Safety Precautions for Installation and Use . . . . .	6
Additional Safety Instructions for Installation Personnel . . . . .	7
Quick Installation Overview . . . . .	7
About the Dual Radio Module . . . . .	8
Auxiliary Power and Switch Wiring . . . . .	11
Positioning a Dual Radio Module . . . . .	12
Single Zone and Dual Zone Configuration . . . . .	13
Installation Procedures for Dual Radio Modules . . . . .	14
Wall-Mounting the Dual Radio Module . . . . .	14
Installing a Dual Radio Module . . . . .	15
Installing Multiple Radio Modules for Single Zone Operation . . . . .	15
Installing Multiple Radio Modules in a Dual Zone Configuration . . . . .	17
Dual Zone Administration . . . . .	19
Administration for PARTNER . . . . .	19
Administration for MERLIN 410 and 820 . . . . .	19
Administration for MERLIN MAGIX . . . . .	20
Administration for MERLIN LEGEND . . . . .	20
Administration for DEFINITY, Prior to Release 5.0 . . . . .	20
Administration for DEFINITY, After Release 5.0 . . . . .	20
Dual Zone Configuration Settings . . . . .	21
The Battery Charger . . . . .	24
Positioning the Battery Charger . . . . .	24
Installing the Battery Charger . . . . .	25
Inserting a Battery Pack into the Spare Battery Compartment . . . . .	26
Inserting and Removing the Handset's Battery Pack . . . . .	28
Inserting the Handset into the Battery Charger's Handset Cradle . . . . .	29
<b>3 Using the Battery Charger</b>	<b>31</b>
The Battery Charger . . . . .	31

Battery Charger Features . . . . .	31
Extending Battery Life. . . . .	32
<b>4 Registering the Pocket Phone to a Dual Radio Module</b>	<b>35</b>
Registration Overview . . . . .	35
Setting Up and Registering the Handset . . . . .	35
Registering a Handset . . . . .	35
Registering the Second Zone of a Dual Zone Configuration . . . . .	37
Removing Registration Between a Handset and a Dual Radio Module. . . . .	38
A Quick Reference Procedure for Handset Registration . . . . .	39
Mapping to the Correct Communications System . . . . .	40
Filling Out the Handset Label . . . . .	41
Other Handset Configuration Options. . . . .	42
<b>5 Programming &amp; Using the MDW 9040 Pocket Phone</b>	<b>43</b>
Important Safety Instructions . . . . .	43
About the Handset . . . . .	43
Handset Features . . . . .	44
The Handset Display . . . . .	45
Setting or Changing Handset Settings. . . . .	50
Features and Options . . . . .	52
A Flowchart for the Configuration, Options, and Test Mode Display Screens . . . . .	59
Test Modes . . . . .	60
Using Handset Features . . . . .	66
"Waking Up" the Phone . . . . .	66
Placing a Call . . . . .	66
Answering a Call . . . . .	66
Manually Selecting a Line or Programmed Button . . . . .	67
Preselecting a Line . . . . .	67
Using a Headset . . . . .	68
Programming Switch-Related Features. . . . .	69
The Handset Antenna. . . . .	69
Carrying Your Pocket Phone . . . . .	70
<b>6 MDW 9040 Pocket Phone Compatibility</b>	<b>73</b>
Programming and Call Handling Instructions. . . . .	73
Programming Features for PARTNER, MERLIN, MERLIN LEGEND and MERLIN MAGIX Systems . . . . .	74
Communications System Compatibility . . . . .	75
Accessing Button Mapping . . . . .	75
PARTNER Systems . . . . .	77
MERLIN Systems . . . . .	79
MERLIN MAGIX System . . . . .	84
DEFINITY Systems . . . . .	86

---

<b>Appendix A: Warranty and Repair Information</b>	<b>91</b>
Avaya Communication Limited Warranty and Limitation of Liability . . . . .	91
Limitation of Liability . . . . .	92
Repair Information. . . . .	92
In-Warranty Repairs . . . . .	92
Post-Warranty Repairs . . . . .	92
<b>Appendix B: Regulatory Information</b>	<b>93</b>
FCC Part 15 Rules . . . . .	93
IC RSS-210 Compliance . . . . .	93
Hearing Aid Compatibility . . . . .	93
<b>Appendix C: Specifications</b>	<b>95</b>
<b>Appendix D: Ordering Replacement and Optional Parts</b>	<b>97</b>
<b>Appendix E: Wall-Mounting Templates</b>	<b>99</b>
Battery Charger Wall-Mounting Template . . . . .	99
Multiple Dual Radio Modules Spacing Wall-Mounting Template . . . . .	101

## Contents

---



# 1 Introduction

## About TransTalk<sup>®</sup> 9000 Products

Congratulations on the purchase of your new TransTalk 9000 Digital Wireless System **MDW 9040 Wireless Pocket Phone**. MDW stands for “Multi-Line Digital Wireless.” The MDW 9040 Pocket Phones are the latest addition to the TransTalk 9000 family of wireless products. These phones are designed to Avaya Communication’s high standards for convenience, reliability, and innovation.

### What Is a Wireless Phone?

A wireless phone has no handset cord, so it is portable. This portability lets you move around freely, without giving up the features of a wired phone. With a wireless phone, you can make and receive calls even when you are away from your desk, thus remaining accessible and responsive to your customers and coworkers as you move around your work area. Time-sensitive work issues will not have to be postponed until you are back at your desk. You can also reduce the number of (sometimes costly) phone calls you must return.

## About the MDW 9040 Pocket Phone

The MDW 9040 Pocket Phone has been designed to work with Avaya communications systems including PARTNER<sup>®</sup>, MERLIN<sup>®</sup>, MERLIN LEGEND<sup>®</sup>, MERLIN MAGIX<sup>™</sup> and DEFINITY<sup>®</sup> switches.

**IMPORTANT NOTE: The MDW 9040 is NOT backward compatible with other TransTalk systems; that is, it CANNOT be added to existing TransTalk systems or used in the same coverage area as the MDW 9000, MDW 9010, MDW 9030, or MDW 9031.**

The MDW 9040 is different from its predecessors in several ways:

- The base station to which the handset is linked is called a **Dual Radio Module** because each module can support two handsets simultaneously.
- Synchronization of multiple Dual Radio Modules and handsets is accomplished without a carrier. The radio module itself can be placed on a flat surface such as a shelf or table or mounted on a wall.
- In the past, one base station was shipped from the factory together with a handset with the same serial code and registration number. Beginning with the MDW 9040, the Dual Radio Module and the handset are packaged separately, and the customer will need to register each handset with the radio module with which it will communicate. Again, each Dual Radio Module can communicate with two handsets.

The MDW 9040 is lightweight and pocket-sized. A belt clip and wrist lanyard are provided with the handset. You can use either the clip or the lanyard for hands-free portability. The MDW 9040 also has a headset connector to accommodate an optional headset.

You can be notified of an incoming call by either an alerter (which rings) or a vibrator, or both. There is a 5 row x 16 character user-activated backlit display that shows telephone system information, icons representing various handset functions (such as the alerter and the vibrator), and the status of up to 12 lines/features (i.e., telephone lines, intercom lines, programmable features and telephone features). The MDW 9040 provides Redial, Hold, Mute, Transfer, and Conference buttons, and allows you to program additional features.

## About the MDW 9040 Pocket Phone in a Dual Zone Configuration

The MDW 9040 Pocket Phone allows you to link up with either of two different radio modules in a dual zone configuration. This dual zone capability expands the coverage area in which you are able to make and answer calls. Dual zone coverage allows you to make and answer calls using the same MDW 9040 Pocket Phone for either radio module in Zone 1 or Zone 2. Dual zone installations require 2 station ports, one for each radio module. See “Installing Multiple Radio Modules in a Dual Zone Configuration” in Chapter 2 for more information.

### Privacy Information

The MDW 9040 Pocket Phone is designed to protect the privacy and security of your voice conversation. The phone uses continuously changing radio frequencies and digital encoding techniques to make it impossible for eavesdropping to occur through the use of commercially available analog radio scanners.

### Where Can You Use Your Pocket Phone?

The MDW 9040 Pocket Phone can be used in most typical office buildings, warehouses, factories, malls, and even outdoor areas such as loading docks. *The location of the Dual Radio Module greatly affects the performance of the MDW 9040. Read the “Positioning a Dual Radio Module” section in Chapter 2 to determine the best place to install the radio module.* Repeat the tests several times with the radio module positioned in a different location each time. If you are using an optional auxiliary power supply, the MDW 9040 Pocket Phone has a built-in testing feature that you can use before final installation (station wiring run) to help determine proper placement of the radio module. To perform the tests, you need an electrical outlet for the radio module, a 14 foot (4.2 m) Station Line Cord (provided) with the auxiliary power supply, and a charged battery pack in the handset (you do not need a communications system switch or control unit). The tests are described in “Using Wireless Test Mode” in Chapter 5.

### Parts List

As noted above, the handset and the Dual Radio Module are packaged separately. The packages should contain the items shown below. If any items are missing, call for customer support as described in the *Copyright and Legal Notices* at the beginning of this book.

The **handset** is packaged with a user Quick Reference and the following:

**Figure 1. Handset Packaging Components**

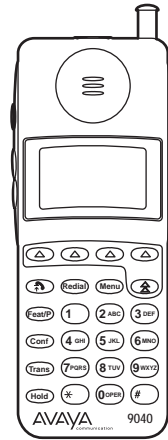

Handset

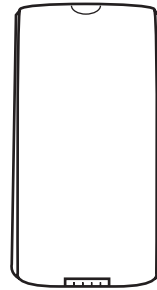

Battery Pack

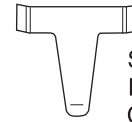

Standard  
Battery Pack  
Carrying Clip

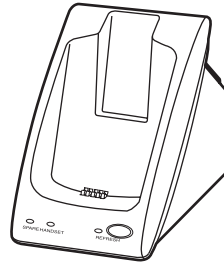

Battery Charger  
and Wall Mounting Kit



8-inch (0.5 m) Lanyard



(2) Phillips Head  
Wood Screws



(2) Wall Spacers

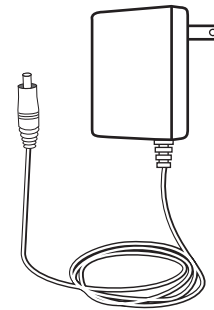

11-foot (3.4 m)  
Power Cord/AC Adapter  
for Battery Charger

The **Dual Radio Module** is packaged with this Installation and Use manual and the following:

**Figure 2. Dual Radio Module Packaging Components**

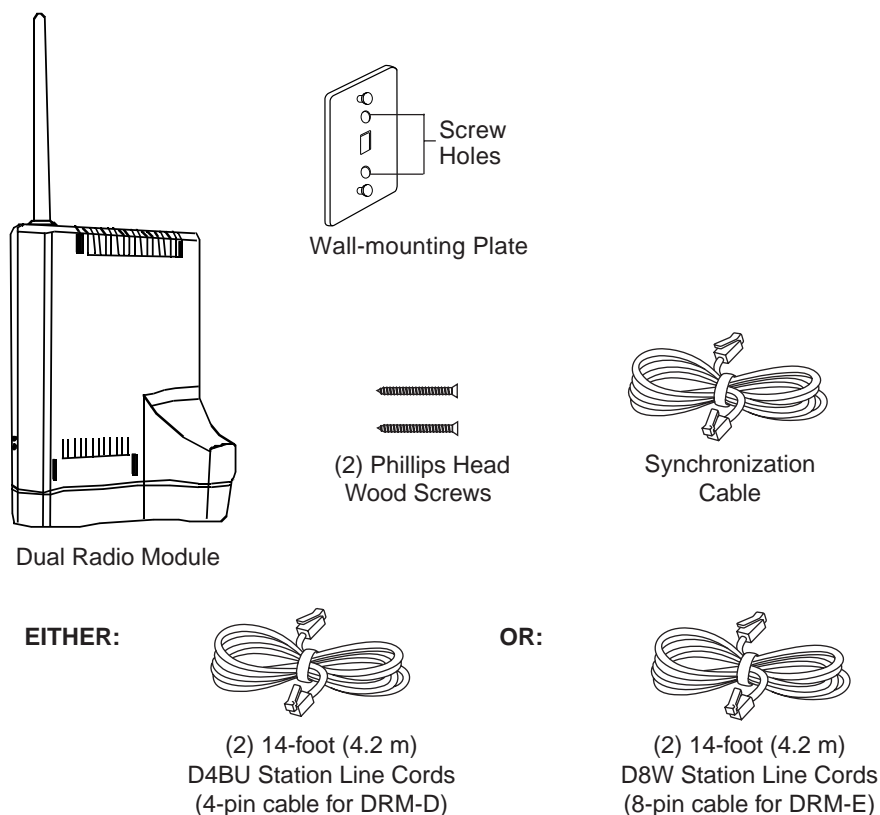

For information about ordering replacement parts, see Appendix D, “Ordering Replacement and Optional Parts.”

#### Additional Parts

One nickel metal hydride battery pack, which provides up to three hours of talk time, comes with your MDW 9040 Pocket Phone. If you require additional phone usage, you can purchase either an additional/second standard battery pack or an extended battery pack. For more information about battery packs, see “Inserting a Battery Pack into the Spare Battery Compartment” in Chapter 2.

Optional Supra<sup>®</sup> Mobility headsets can be attached to a quick-disconnect adapter cord, which you can insert into the connector on the bottom of the handset to allow hands-free conversation specifically designed for TransTalk. For more information about headsets, see “Using a Headset” in Chapter 5.

For ordering information, see Appendix D, “Ordering Replacement and Optional Parts.”

# 2 Installing the MDW 9040 Pocket Phone System

## Important Safety Instructions

This book contains instructions related to safety labels on the product:

### **WARNING:**

**WARNING** indicates the presence of a hazard that can cause severe or fatal personal injury if the hazard is not avoided.

### **CAUTION:**

**CAUTION** indicates the presence of a hazard that will or can cause minor personal injury or property damage if not avoided.

This phone is designed to provide trouble-free performance without any special maintenance procedures. To reduce the risk of accidental damage:

- Keep the phone in an area free of dust, smoke, and moisture; do not block the air vents by placing objects on top of the radio module.
- Do not place the phone or battery charger near a heating duct, radiator, or other heat source, and do not drop or expose it to excessive shock or vibration.
- Unplug the battery charger, radio module, or carrier if its power cord is damaged, if liquid is spilled into it, or if its housing becomes cracked or otherwise damaged.
- To clean your phone, wipe the outside housing with a soft, dust-free cloth. If absolutely necessary, you may use a cloth slightly dampened with a mild soap-and-water solution. Dry quickly with a soft cloth.

### **CAUTION:**

Your phone contains sensitive electronic parts. Never submerge it in any kind of liquid, and never use liquid or aerosol cleaners, detergents, alcohols, solvents, abrasive cleaners, or an excessive amount of water when cleaning the housing and faceplate. To do so could result in irreparable damage.

## Guidelines for Safe and Efficient Operation

Your wireless telephone is a radio transmitter and receiver. When the phone is turned on, it receives and sends out radio frequency (RF) energy. The phone operates in the frequency range of 902-928 MHz.

### **Exposure to Radio Frequency Energy**

The design of your wireless telephone complies with the latest Institute of Electrical and Electronic Engineers (IEEE) and the American National Standards Institute (ANSI) safety levels with respect to human exposure to RF energy.

**FCC Radio Frequency Requirement:** The base antenna on the Dual Radio Module must be installed with a minimum separation distance of 7.88 inches (20 cm) from the end user or any nearby person.

**Cardiac Pacemakers  
and Life-Support  
Equipment****⚠ CAUTION:**

The MDW 9040 handset is a radio transceiver device. It is recommended that the handset not be placed within 6 inches of a pacemaker.

It is recommended that standard acceptance test procedures be followed prior to operating this equipment in proximity of life-support equipment. Until more is known, the FDA suggests that people with pacemakers may want to take some simple precautions when using or carrying digital wireless telephones. They should ensure that there is ample distance between the digital wireless telephone and the pacemaker—by not placing the phone next to the pacemaker implant (for example, in a shirt or a coat pocket directly over the pacemaker implant) when the phone is on and ready to receive a call and by holding it to the ear opposite the side of the body where the pacemaker is implanted when using the phone. They should consult their physicians or medical device manufacturers to determine if additional precautions are necessary.

**Hearing Aid  
Compatibility**

Most electronic equipment, such as equipment in hospitals, is shielded from RF energy. RF energy from wireless telephones, however, may affect some electronic equipment.

Although the TransTalk wireless telephone is compatible with inductively coupled hearing aids, a physician or hearing aid manufacturer should be consulted to determine if a hearing aid is adequately shielded from external RF energy. The operation of inadequately shielded medical devices may be adversely affected when a portable wireless telephone is operating in close proximity. Use of an optional headset would solve this problem.

**Basic Safety Precautions for Installation and Use**

Always follow these basic safety precautions when installing or using this product to reduce risk of injury from fire or electric shock.

**⚠ WARNING:**

**Installation of this equipment for In-Range Out of Building (IROB) conditions requires the use of protectors. See the documentation that came with your communications system for more information.**

**⚠ CAUTION:**

This equipment is for installation on Avaya PARTNER, MERLIN, MERLIN MAGIX, and DEFINITY Communications Systems only.

- *Before using this product*, read and understand all warnings and instructions.
- Observe all warnings and instructions marked on this product.
- Do not use this phone in the vicinity of a suspected gas leak. This product is not approved for use in areas labeled by the Occupational Safety and Health Administration (OSHA) as “explosive environments.” Only “Explosive Atmosphere Telephones” may be used in such hazardous environments.

- This product should be serviced by a qualified service center when service or repair work is required. Do not open the product or push objects through housing slots. There are no user-serviceable components inside.
- Use only the type of battery pack shipped with this product or sold as an optional part. (See Appendix D, "Ordering Replacement and Optional Parts.")

**WARNING:**

**Do not burn or puncture the battery pack. As with other batteries of this type, burning or puncturing could release toxic material, which could cause injury. Do not dispose of the battery pack in household garbage. For information about recycling or proper disposal, consult your local solid waste (garbage) collection or disposal organization.**

**Additional Safety Instructions for Installation Personnel**

- Install the product to meet all environmental and electrical requirements listed in Appendix C, "Specifications."
- All wiring that connects to this equipment and becomes part of the building wiring must be a minimum of CLASS 2 or UL (Underwriters Laboratories) Listed Communications cable.
- Do not install telephone wiring during a lightning storm.
- Do not install telephone jacks in a wet location unless the jack is specifically designed for wet locations. Never touch telephone wires or terminals that are not insulated unless the telephone line has been disconnected at the network interface.
- Install this product in a protected location where no one can step on or trip over power cords and telephone line cords. Do not place objects on the cords that may cause damage or abrasion.
- Use only the power supply (Comcode 408082204) shipped with this product for the battery charger.
- When required, use only the auxiliary power supply (Comcode 108212952) or the power supply with battery holdover (Comcode 108212960) specified for use with this product.

## Quick Installation Overview

There are **four main steps** for installing your MDW 9040:

- 1 Connecting the Dual Radio Module to the switch**  
Make sure you have the correct radio module for your system. (See “About the Dual Radio Module” later in this Chapter.)
- 2 Registering each handset to the appropriate Dual Radio Module**  
Only one handset can be registered at a time. (See “Setting Up and Registering the Handset” in Chapter 4.)
- 3 Checking button mapping to coincide with the communications system to which the MDW 9040 is connected**  
Make sure you have mapped the buttons to the correct system. (See Chapter 6, “MDW 9040 Pocket Phone Compatibility” for more information.)
- 4 Choosing features and options**  
A menu of features and options is available to configure your handset. (See “About the Handset” in Chapter 5.)

### About the Dual Radio Module

Each **radio module can communicate with up to two handsets**. However, it is important to remember that only one handset can be registered at a time with its appropriate radio module.

**There are two types of Dual Radio Modules.** The table below shows which type of radio module you should use.

DUAL RADIO MODULE SELECTION TABLE		
PEC of Compatible Dual Radio Module	Dual Radio Module Model Number	Switch Type
3204-DRE	600A1	PARTNER
		MERLIN
		MERLIN 410/820
		MERLIN LEGEND
3204-DRD	601A1	MERLIN MAGIX
		DEFINITY



The following figure shows the components of a typical radio module.

**Figure 3. The Dual Radio Module**

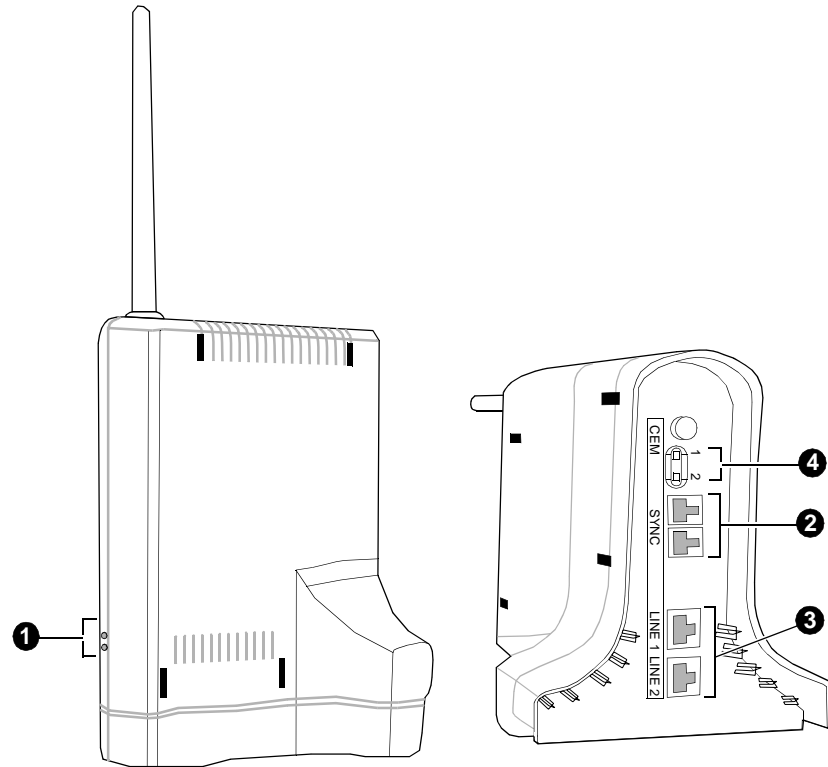

**A Key to Figure 3, The Dual Radio Module:**

- 1** Power and Control LEDs: the radio module has two LEDs on its side (see “Dual Radio Module Light Indications” on page 10 for more information).
- 2** Synchronization Jacks: each of these two jacks (labeled **SYNC**) connects multiple radio modules together forming inter-Dual Radio Module synchronization.
- 3** Station Ports: these 8-pin RJ-45 line jacks (labeled **LINE 1** and **LINE 2**) allow connection of the radio module to the station port interface. Before you use the MDW 9040 Pocket Phone, you must register each of the two handsets with the associated radio module.

**Note:** The power for the radio modules is provided by the switch when the Station Line Cord is connected from the switch to either of the Line Jacks. An optional auxiliary power supply can be provided, in which case, the line cord connects in and out of the auxiliary power supply.

- 4** Registration Buttons: for the handset connected to **LINE 1**, press the registration button labeled **1**; for the handset connected to **LINE 2**, press the registration button labeled **2** (for more information on Registration, see Chapter 4, “Registering the Pocket Phone to a Dual Radio Module”).

**Note:** The circuitry of each radio module allows it to interface with two station ports for communications, signaling, and power.

**Dual Radio Module  
Light Indications**

There are two LEDs on the side of the radio module: the System Power LED (labeled **Power**) and the Synchronization Controller LED (labeled **Control**). These LED indications have the following meanings:

<b>When this LED</b>	<b>is:</b>	<b>It indicates:</b>
<b>The Power LED (Top)</b>	STEADY GREEN	The radio module is receiving power from the switch or auxiliary power supply.
	NO LIGHT	The radio module is not receiving power, is connected to the wrong switch, or has failed.
	FLASHING	The radio module is in Registration or Wireless Test Mode <i>for Line 1</i> .
<b>The Control LED (Bottom)</b>	STEADY GREEN	This is the control radio module.
	STEADY AMBER	This is the expansion radio module.
	STEADY RED	Either or both handset(s) for this base are ON and linked up to the base.
	FLASHING	The radio module is in Registration or Wireless Test Mode <i>for Line 2</i> .
	NO LIGHT	The radio module is connected to the wrong switch or has failed.

**Note:** When inserting or replacing a Dual Radio Module in an existing installation, a different radio module may become the control radio module (green LED). This is normal. However, only one radio module can be the control radio module. All other radio modules must be expansion (amber LED) radio modules.

## Auxiliary Power and Switch Wiring

The radio module connects to an associated switch through a station port. Normally, a radio module is powered through one or both of its station port interfaces. However, there may be occasions when an auxiliary power supply may be required. The auxiliary power supply can be connected to either of the radio module's station ports.

With 24-gauge wire, the maximum loop length of a radio module connected with a PARTNER or MERLIN system is 1,000 feet (305 m). When the radio module is connected with a MERLIN MAGIX or DEFINITY system, the maximum loop length is 2,000 feet (610 m). However, with auxiliary power, radio modules connected to these systems will have a maximum loop length of 3,000 feet (915 m).

The following auxiliary power supplies are preferred: The 1151A1 Power Supply (PEC: 2404-010A; Comcode: 108212952) or the 1151A2 Power Supply with Battery Holdover (PEC: 2404-012A; Comcode: 108212960).

**Note:** If you are using an auxiliary power supply, the MDW 9040 Pocket Phone has a built-in testing feature that you can use before final installation (station wiring run) to help determine proper placement of the radio module. To perform the tests, you need an electrical outlet for the radio module, a 14 foot (4.2 m) Station Line Cord (provided) with the auxiliary power supply, and a charged battery pack in the handset (you do not need a communications system switch or control unit). The tests are described in "Using Wireless Test Mode" in Chapter 5.

Be sure the radio module does not share the same power line as equipment with microprocessors such as answering machines, personal computers, and fax machines or electromagnetic equipment such as electric motors.

If your installation requires customized wiring, the wiring technician should match the Pin numbers with the switch interfaces as shown in the following table.

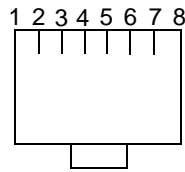

**View of Line Jack  
(with Dual Radio Module  
upside down)**

<b>Dual Radio Module LINE 1 and LINE 2 Jack Wiring</b>				
<b>Jack Pin #</b>	<b>SWITCH TYPE and Radio Module PEC CODE</b>			
	<b>PARTNER 3204-DRE</b>	<b>MERLIN 3204-DRE</b>	<b>DEFINITY 3204-DRD</b>	<b>MERLIN MAGIX 3204-DRD</b>
<b>1</b>	–	Control Tip	–	–
<b>2</b>	–	Control Ring	–	–
<b>3</b>	Control Tip	Line Power Pos.	–	–
<b>4</b>	Voice Ring	Voice Ring	Ring	Ring
<b>5</b>	Voice Tip	Voice Tip	Tip	Tip
<b>6</b>	Control Ring	Line Power Neg.	–	–
<b>7</b>	Aux. Power Neg.	Aux. Power Neg.	Aux. Power Neg.	Aux. Power Neg.
<b>8</b>	Aux. Power Pos.	Aux. Power Pos.	Aux. Power Pos.	Aux. Power Pos.

**Note:** A Dual Radio Module used with an MDW 9040 Wireless Pocket Phone will NOT support a Tip/Ring [Plain Old Telephone Service (POTS)] interface.

## Positioning a Dual Radio Module

The radio modules for each zone of communication can be placed on a flat surface such as a desk or shelf for ease of installation, OR mounted on the wall (higher is usually better). Use the following rules for positioning a radio module in your system.

The range depends on your particular operating environment. For indoor use, walls between the handset and the radio module will reduce the phone's range. Avoid concentrations of structural metal, such as steel and aluminum, and reinforced concrete.

### General Positioning Rules

**Failure to observe the following rules regarding location and use will result in poor performance of your MDW 9040 Pocket Phone.**

- The Synchronization cable connecting two radio modules is 20 inches (50 cm) long.
- When positioning radio modules, they must be installed with a minimum separation that is provided by the base "wings" of the radio module (5 1/4"). A template for wall-mounting the radio modules is provided in Appendix E.
- When wall-mounting the radio module, place it high on the wall for optimum voice quality and range. Allow 6 to 12 inches (15.2 to 30.5 cm) of space between the top of the antenna on the radio module and the ceiling.

- DO NOT install the radio module above a drop or suspended ceiling.
- Do not locate the radio module within 3 feet (0.9 m) of any large metal object, and be sure no metal objects are in the line of sight to the operating area of the handset.
- **Do not locate the radio module within 6 to 10 feet (1.8 to 3 m) of equipment with microprocessors, such as answering machines, personal computers, and fax machines; control units, communications system switches, or other phones (especially speakerphones); competing radio devices such as wireless bar-code scanners; electromagnetic equipment such as electric motors; or electrical main power feeds, junction boxes, circuit-breaker panels, fuse boxes, or 220-volt power lines.**
- You can install a single radio module in a remote location using a telephone line cord to connect the radio module to the communications system switch/control unit. **IROBs and (if required by distance limitations) an auxiliary power supply must be used for out-of-building installations.**

**Note:** You should perform the tests described in “Using Wireless Test Mode” in Chapter 5 to determine the optimal placement of the radio module.

## Single Zone and Dual Zone Configuration

Multiple radio module units can be installed and configured for single or dual zone operation.

- In a single zone configuration, all radio modules provide communication *to the same* area or zone.
- In a dual zone configuration, two sets of radio modules share handsets that can be operated in two different areas. This type of operation requires two connections to the associated switch.

You must register the radio module with its associated handset(s). For single zone operation, each handset must be registered to its associated radio module; each radio module can be registered with one or two handsets. For a handset being used in a dual zone configuration, the handset must be registered to a radio module in each of the two zones. (See Chapter 4, “Registering the Pocket Phone to a Dual Radio Module” for registration information.)

## Installation Procedures for Dual Radio Modules

There are three types of installations according to the needs of your wireless communications system.

- 1 Installing **one radio module for single zone operation**, the simplest type of configuration; for information on this type of configuration, use the procedures on page 15.
- 2 Installing **multiple radio modules for single zone operation**; for information on this type of configuration, use the procedures on page 15.
- 3 Installing **multiple radio modules for dual zone operation**; for information on this type of configuration, use the procedures on page 17.

Before you begin installation, please review the “Quick Installation Overview” section beginning on page 8 and information about positioning the radio module on page 12.

**Note:** For some installers, it may be more convenient to unpack the radio module and handset in the switch room, power up the radio module, and then register the handset prior to installing the radio module. For this procedure, refer to the introductory information and figures for the radio module in this section and then follow the registration procedures outlined in Chapter 4, “Registering the Pocket Phone to a Dual Radio Module,” or see “A Quick Reference Procedure for Handset Registration” on page 39.

Before you register the handset with the radio module, you must insert the charged battery pack in the handset. See “Inserting and Removing the Handset’s Battery Pack” later in this Chapter.

A radio module can be placed on a flat surface such as a desk or shelf OR mounted on the wall.

### Wall-Mounting the Dual Radio Module

To wall-mount a radio module:

- 1 Remove the radio module and mounting plate from its shipping box. Choose a location where one of the screw holes will be backed by a wooden stud (if unavailable, use toggle bolts instead of the supplied wood screws). Hold the plate straight; use a level if needed.
- 2 Using the plate, mark the locations for the two wall-mounting screws. Lightly tap a nail into the wall to start the holes.

- 3 Place the mounting plate against the wall, and align the screw holes on the plate with the holes that you have marked on the wall. Start the screws, and screw them in until the plate rests flush against the wall.

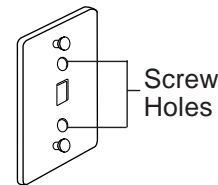

Wall-mounting Plate

- 4 Place the keyhole-shaped openings on the back of the radio module over the screw heads, then slide the radio module downward until it locks into place.
- 5 Follow the installation procedures for "Installing a Dual Radio Module," "Installing Multiple Radio Modules for Single Zone Operation," or "Installing Multiple Radio Modules in a Dual Zone Configuration."

### Installing a Dual Radio Module

To install one radio module on a desk or shelf:

- 1 Remove the radio module from its shipping box and place it in the location you have selected (for wall-mounting instructions, see "Wall-Mounting the Dual Radio Module" on page 14).
- 2 For the first handset to be connected to the radio module, connect a 14 foot (4.2 m) Station Line Cord (provided) to **Line 1** on the radio module and then connect the other end of the cord to a station port at the main communication system. If a second handset is to be connected to the radio module, connect another Station Line Cord to **Line 2** on the radio module and then connect the other end of that cord to another station port.

**Note:** If the radio module cannot be connected to an associated switch, it can be temporarily connected to an auxiliary power supply that can provide electrical power.

- 3 Verify that the radio module has power and that the status LED information is correct. See "Dual Radio Module Light Indications" on page 10.
- 4 Proceed to "Setting Up and Registering the Handset" on page 35.

### Installing Multiple Radio Modules for Single Zone Operation

Two or more radio modules must be connected so that their transmission and reception signals will be synchronized. In this way, the signals transmitted to or received by one radio module will not interfere with another. This synchronization can be done in a single zone (see below) or a dual zone configuration (see page 17).

### Synchronization

When two or more radio modules are connected, one radio module shall be deemed the “Control” radio module since it is administered to control the synchronization for all of the other radio modules to which it is connected; that is, when the “Control” radio module is transmitting or receiving signals (Control LED is Steady Green), the expansion or other radio modules connected to it transmit or receive signals at the same time (Expansion LEDs are Steady Amber).

**Note:** Radio modules can be installed in a single zone or dual zone configuration with up to the same number of handsets—that is, 9 radio modules (18 handsets) per zone for key systems such as PARTNER or MERLIN or MERLIN MAGIX and up to 15 radio modules (30 handsets) for PBX systems such as MERLIN LEGEND or MERLIN MAGIX (in PBX mode) and DEFINITY.

The following is a diagram showing three radio module units operating in a single zone configuration providing six handsets with the appropriate switch interface.

**Figure 4. Three Dual Radio Modules Connected and In Sync (Front View)**

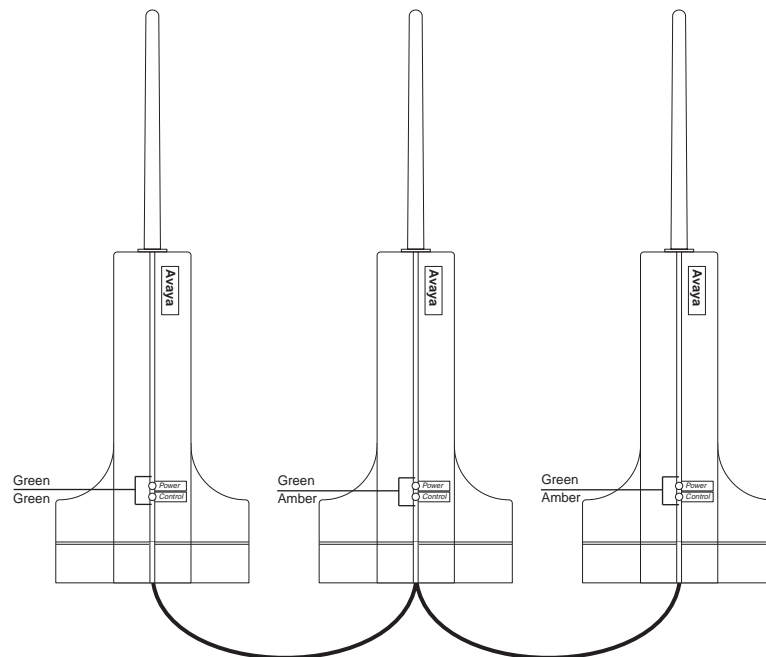

**Figure 5. Three Dual Radio Modules Connected and In Sync (Bottom View)**

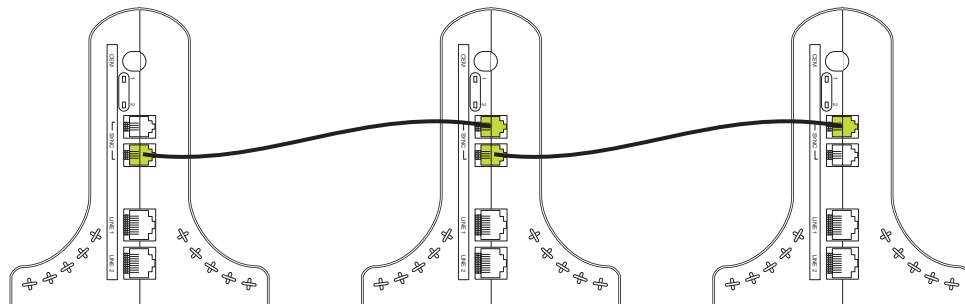



To install multiple radio modules for single zone operation:

- 1 Remove each radio module from its shipping box and place it in the location you have selected (for wall-mounting instructions, see “Wall-Mounting the Dual Radio Module” on page 14).
- 2 For the first handset to be connected to the radio module, connect a 14 foot (4.2 m) Station Line Cord (provided) to **Line 1** on the radio module and then connect the other end of the cord to a station port at the main system. If a second handset is to be connected to the radio module, connect another Station Line Cord to **Line 2** on the radio module and then connect the other end of that cord to another station port.

**Note:** If the radio module cannot be connected to an associated switch, the radio module can be temporarily connected to an auxiliary power supply that can provide electrical power.

- 3 Verify that the radio module has power and that the status LED information is correct. See “Dual Radio Module Light Indications” on page 10.
- 4 Repeat Steps 1 and 2 for each radio module and handset combination in this configuration.
- 5 To daisy chain two or more radio modules, plug the 20 inch (50 cm) synchronization cable (provided) from the Sync jack on one radio module to the Sync jack on the other radio module (either Sync jack can be used).
- 6 Proceed to “Setting Up and Registering the Handset” on page 35.

### Installing Multiple Radio Modules in a Dual Zone Configuration

Dual zone coverage allows you to originate and receive calls using the same handset for two radio modules in either Zone 1 or Zone 2. Dual zone installations require two station ports, one for each radio module, as shown in Figure 6 below.

Figure 6. Dual Zone Installation

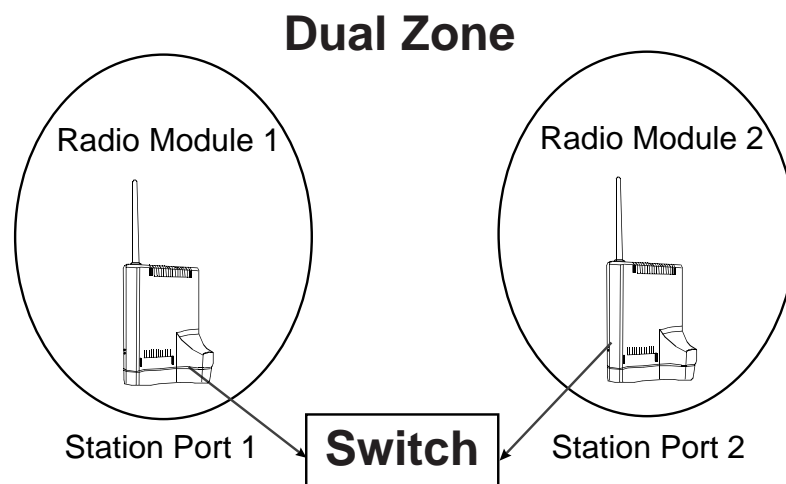

Installation of the MDW 9040 in a dual zone configuration is the same as that for the single zone, except that the installation of a second radio module is required. Like the single zone MDW 9040, the dual zone can be installed in a single user configuration or a multiple user configuration with up to the same number of handsets, that is, 18 handsets per zone for key systems such as PARTNER or MERLIN and up to 30 handsets for PBX systems such as MERLIN MAGIX and MERLIN LEGEND (in PBX mode) and DEFINITY.

When installing the MDW 9040 in a dual zone configuration in the same building, you should eliminate or limit how much zone overlap there is between Zone 1 and Zone 2, as shown in Figure 7. In the ideal dual zone installation, there is no overlap or interference between radio modules. If there is minimal overlap, there will be some interference between radio modules. If the zones overlap too much, there will be interference between the two radio module installations, causing the following: bad voice quality and/or the handset is rendered inoperable (“ranges”).

#### General Guidelines Regarding Zone Overlaps

- Separate the radio modules so that you have continual coverage, yet no overlap (recommended) or minimal overlap between zones.
- If there is an overlap condition, poor voice quality could occur and the Range icon may begin flashing in the handset display. If this occurs, move the radio module further from the original installation position.

Figure 7. Ideal Dual Zone Installation

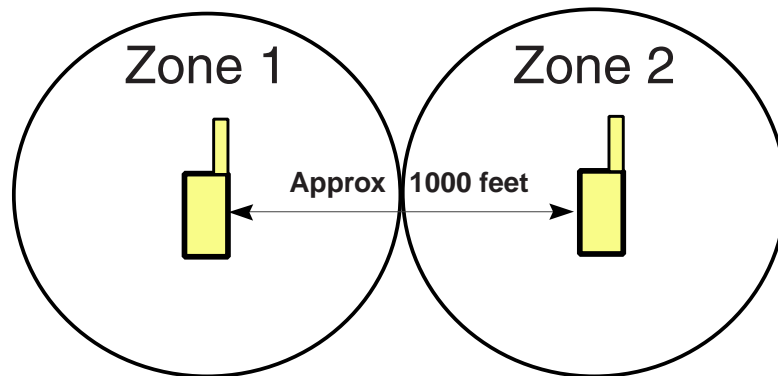

**Recommended Dual Zone Installation - No Overlap of Zones, No Interference or Operational Issues.**

#### Dual Zone Installation Procedures

To install multiple radio modules for dual zone operation:

- 1 Remove each radio module from its shipping box and place them in the locations you have selected (for wall-mounting instructions, see “Wall-Mounting the Dual Radio Module” on page 14). The radio modules must be placed in separate zones.
- 2 For the first handset to be connected to the radio module in Zone 1, connect a 14 foot (4.2 m) Station Line Cord (provided) to **Line 1** on the radio module and then connect the other end of the cord to a station port at the main system. If a second handset is to be connected to the radio module, connect another Station Line Cord to **Line 2** on the radio module and then connect the other end of that cord to another station port.
- 3 Repeat Step 2 for the second radio module in Zone 1.
- 4 Verify that both radio modules have power and that the status LED information is correct. See “Dual Radio Module Light Indications” on page 10.

- 5 Repeat Steps 1 and 2 for each radio module and handset combination in the second zone (Zone 2).
- 6 To daisy chain two or more radio modules in the same zone, plug the 20 inch (50 cm) synchronization cable (provided) from the Sync jack on one radio module to the Sync jack on the other radio module (either Sync jack can be used).

**Note:** When two or more radio modules are synchronized, only one radio module should have the **CONTROL LED** lit (Steady Green), all others must be lit Amber.

- 7 Proceed to “Setting Up and Registering the Handset” on page 35.

## Dual Zone Administration

The MDW 9040 Wireless Pocket Phone works with the following Avaya communications systems:

- PARTNER
- MERLIN
- MERLIN LEGEND
- MERLIN MAGIX
- DEFINITY

Each communications system requires unique administration in order to work with the MDW 9040 Wireless Pocket Phone. Locate your communications system from the sections that follow and perform the administration tasks provided.

**Note:** Features, lines, and ringing options administered for any of the communications systems should be administered identically for both zones (station port 1 and station port 2) so that your pocket phone operates the same way in either zone.

### Administration for PARTNER

For PARTNER Communications Systems, you must administer 2 station ports (2 extensions)—one for each radio module. Both radio module station ports should be set for either call coverage or set up in a calling group. PARTNER calling groups are numbered 71-74. See your PARTNER Communications System manual for information on setting up call coverage or calling groups.

If all calling groups are already used, group hunting can be set up between the two radio modules. See your PARTNER Communications System manual for information on applying setups.

### Administration for MERLIN 410 and 820

For MERLIN 410 and 820 Communications Systems, you must administer 2 station ports (extensions)—one for each radio module. In this configuration, an intercom call coming into one zone does not ring in the other zone. However, a call coming in from the Central Office rings in both zones.

## Administration for MERLIN MAGIX

See “Administration for MERLIN LEGEND” below.

## Administration for MERLIN LEGEND

For MERLIN LEGEND Communications Systems, you must administer 2 station ports (extensions)—one for each radio module.

- For MERLIN LEGEND in Key Mode, call coverage should be set up between the two station ports so that both station ports ring simultaneously on the handset.
- For MERLIN LEGEND in PBX mode, each station port needs 2 shared system access buttons for the other station port.

See your MERLIN LEGEND Communications System manual for information on applying call coverage setups or for programming shared system access buttons.

## Administration for DEFINITY, Prior to Release 5.0

For DEFINITY Communications Systems prior to Release 5.0, you must administer 2 station ports (2 extensions)—one for each radio module. Each station port must be administered with 3 call appearances of its own and 3 bridged appearances of the other station extension number.

## Administration for DEFINITY, After Release 5.0

For DEFINITY Communications Systems after Release 5.0, you must administer 2 station ports (2 primary extension numbers)—one for each radio module. Administer station port 1 as the primary station port with call appearances, and then administer station port 2 as a zero call appearance station with bridged appearances of port 1 if the 9040 Pocket Phone is your only telephone. If you have a wired telephone, keep your wired telephone as the primary station port and administer both ports as zero call appearance stations with bridged call appearances of the primary wired telephone.

**Note:** All bridged extension conventions apply. For example, when configured as part of an ACD split, only the primary station port (extension) will ring.

## Dual Zone Configuration Settings

This section provides screen shots of the Station Configuration settings for both primary and bridge extension translations.

**Figure 8. Type 8410D Primary Station Translation (4 screens)**

```

add station next                                     Page 1 of 4  SPE B
                                                    STATION
Extension: 30016
  Type: 8410D                                     Lock Messages? n   BCC: 1
  Port:                                           Security Code:     TN: 1
  Name: TransTalk Dual Zone 1                    Coverage Path 1:   COR: 1
                                                    Coverage Path 2:   COS: 1
                                                    Hunt-to Station:

STATION OPTIONS
  Data Module? n
  Speakerphone: n                               Personalized Ringing Pattern: 1
  Display Language: english                     Message Lamp Ext: 30016
                                                    Mute Button Enabled? n
                                                    MM Complex Data Ext:

```

```

add station next                                     Page 2 of 4  SPE B
                                                    STATION
FEATURE OPTIONS
  LWC Reception: spe                             Auto Select Any Idle Appearance? n
  LWC Activation? y                               Coverage Msg Retrieval? y
  CDR Privacy? n                                 Auto Answer: none
  Redirect Notification? y                       Data Restriction? n
  Per Button Ring Control? n                     Idle Appearance Preference? n
  Bridged Call Alerting? y
  Active Station Ringing: single                 Restrict Last Appearance? y

  H.320 Conversion? n
                                                    Per Station CPN - Send Calling Number?
                                                    Multimedia Early Answer? n
                                                    Audible Message Waiting? n
                                                    Display Client Redirection? n
  AUDIX Name: n                                  Select Last Used Appearance? n
  Messaging Server Name: n

```

```

add station next                               Page 3 of 4 SPE B
                                           STATION
SITE DATA
  Room:                                         Headset? n
  Jack:                                         Speaker? n
  Cable:                                       Mounting: d
  Floor:                                       Cord Length: 0
  Building:                                    Set Color:

ABBREVIATED DIALING
  List1:                                       List2:                                       List3:

BUTTON ASSIGNMENTS
  1: (A) call - appr                           6: (3)
  2: (B) call - appr                           7: (4)
  3: (C) call - appr                           8: (5)
  4: (1)                                       9: (6)
  5: (2)                                       10: (7)

```

```

add station next                               Page 4 of 4 SPE B
                                           STATION
SOFTKEY BUTTON ASSIGNMENTS
  1: lwc-store
  2: lwc-cancel
  3: auto-cback
  4: timer
  5: call-fwd Ext:
  6: date-time
  7: call-park
  8: priority
  9: abr-prog
 10: abr-spchar Char: ~p
 11: abr-spchar Char: ~m
 12: abr-spchar Char: ~w

Note: All Softkey button assignments should be initially removed when administering an MDW 9040 Dual Zone terminal. The desired Softkey features can then be properly programmed on the Dual Zone Pocket Phone programmable buttons (1 - 7). Button 8 is a firmware-programmed hard Scroll button on the MDW 9040 Pocket Phone.

```

Figure 9. Type 8410D Bridge Station Translation (4 screens)

```

add station next                               Page 1 of 4 SPE B
                                           STATION
Extension: 30017
  Type: 8410D                                  Lock Messages? n      BCC: 0
  Port:                                         Security Code:        TN: 1
  Name: TransTalk Dual Zone 2                 Coverage Path 1:     COR: 1
                                           Coverage Path 2:     COS: 1
                                           Hunt-to Station:

STATION OPTIONS
  Data Module? n
  Speakerphone: n
  Display Language: english
  Personalized Ringing Pattern: 1
  Message Lamp Ext: 30017
  Mute Button Enabled? n
  MM Complex Data Ext:

```

```

add station next                                     Page 2 of 4  SPE B

FEATURE OPTIONS                                     STATION
LWC Reception: spe      Auto Select Any Idle Appearance? n
LWC Activation? y      Coverage Msg Retrieval? y
CDR Privacy? n        Auto Answer: none
Redirect Notification? y      Data Restriction? n
Per Button Ring Control? n    Idle Appearance Preference? n
Bridged Call Alerting? y
Active Station Ringing: single  Restrict Last Appearance? y

H.320 Conversion? n
Per Station CPN - Send Calling Number?
Multimedia Early Answer? n
Audible Message Waiting? n
Display Client Redirection? n
AUDIX Name:      Select Last Used Appearance? n
Messaging Server Name:

```

```

add station next                                     Page 3 of 4  SPE B

SITE DATA                                         STATION
Room:                                             Headset? n
Jack:                                             Speaker? n
Cable:                                           Mounting: d
Floor:                                           Cord Length: 0
Building:                                        Set Color:

ABBREVIATED DIALING
List1:                                           List2:      List3:

BUTTON ASSIGNMENTS
1: (A) brdg - appr Btn:1 Ext: 30016      6: (3)
2: (B) brdg - appr Btn:2 Ext: 30016      7: (4)
3: (C) brdg - appr Btn:3 Ext: 30016      8: (5)
4: (1)                                     9: (6)
5: (2)                                     10: (7)

```

```

add station next                                     Page 4 of 4  SPE B

SOFTKEY BUTTON ASSIGNMENTS                       STATION

1: lwc-store
2: lwc-cancel
3: auto-cback
4: timer
5: call-fwd  Ext:
6: date-time
7: call-park
8: priority
9: abr-prog
10: abr-spchar Char: ~p
11: abr-spchar Char: ~m
12: abr-spchar Char: ~w

Note: All Softkey button assignments should be initially removed when administering an MDW 9040 Dual Zone terminal. The desired Softkey features can then be properly programmed on the Dual Zone Pocket Phone programmable buttons (1 - 7). Button 8 is a firmware-programmed hard Scroll button on the MDW 9040 Pocket Phone.

```

## The Battery Charger

This section explains how to choose a location for the battery charger and install it. It also explains how to insert and remove a battery pack.

### Positioning the Battery Charger

The battery charger can be placed on a desk, or it can be mounted on a wall. Before you install the battery charger, note the following considerations:

- Locate the battery charger within 5 feet (1.6 m) of a properly grounded electrical outlet that is not controlled by an on/off switch.
- If your communications system uses an uninterruptible power supply, such as a backup generator, you may want to connect the battery charger to that power supply.
- Do not locate the battery charger where it will be exposed to direct sunlight or water.

**⚠ WARNING:**

**The rechargeable battery pack may contain elements that are harmful to the environment (for example, nickel). Do not burn or puncture the battery. As with other batteries of this type, burning or puncturing could release toxic material that could cause injury. Do not dispose of it in household garbage. For information about recycling or proper disposal, consult your local solid waste (garbage) collection or disposal organization.**



## Installing the Battery Charger

- If you are wall-mounting the battery charger, follow Steps 1 through 7.
- If you are desk-mounting the battery charger, follow only Steps 1, 5, and 7.

To install the battery charger:

- 1** Check to make sure the battery charger's power cord is unplugged from the wall outlet before continuing. If you are desk-mounting, skip to Step 5.
- 2** To wall-mount, place the battery charger's wall-mounting template (located in Appendix E) against the wall. Choose a location backed by a wooden stud (if unavailable, use toggle bolts instead of the supplied wood screws). Hold the template straight; use a level if needed.
- 3** Mark the locations for the two wall-mounting screws, and then remove the template from the wall. Lightly tap a nail into the wall to start the holes.
- 4** Place the screw through the wall spacers so that the screw head nests in the indentation on the spacer. Start the screws, and screw them in until the wall spacers rest against the wall.
- 5** Insert the battery charger's power cord/AC adapter into the battery charger. If you are desk-mounting the battery charger, skip to Step 7.

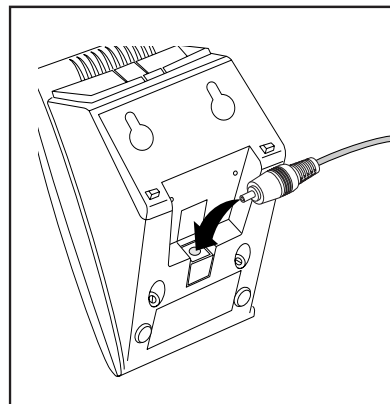

- 6** Place the keyhole-shaped openings in the back of the battery charger over the screw heads and wall spacers, then slide the battery charger downward into the groove in the wall spacers to lock it into place.

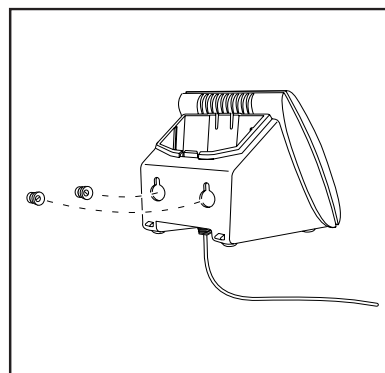

- 7 Plug the battery charger's power cord/AC adapter into a properly grounded, wall outlet that is not controlled by an on/off switch.

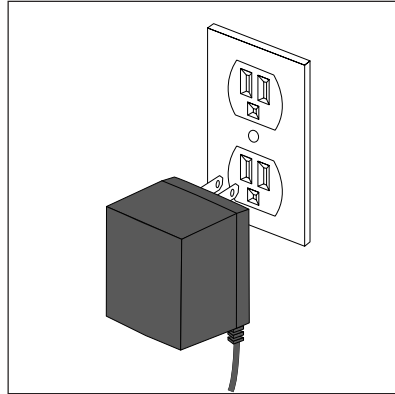

### Inserting a Battery Pack into the Spare Battery Compartment

#### Inserting the Battery Pack

Slide the battery pack (or an optional extended battery pack) into the spare battery compartment until it is firmly seated, that is, with the back of the battery pack against the back of the spare battery compartment. Do not force the battery pack down. The battery pack should slide easily into the slot.

Correct positioning of the battery pack in the charger is important to ensure proper charging. The bottom end of either battery pack also has two small round holes that must align with two guide pins on the bottom of the spare battery compartment. When a battery pack is positioned correctly in the spare battery compartment, the **SPARE** LED on the front of the battery charger lights.

The spare battery compartment has a vertical ridge on each side that serves as a “guide rail” for positioning the standard battery pack.

Figure 10. Inserting Battery Pack Into Spare Battery Compartment

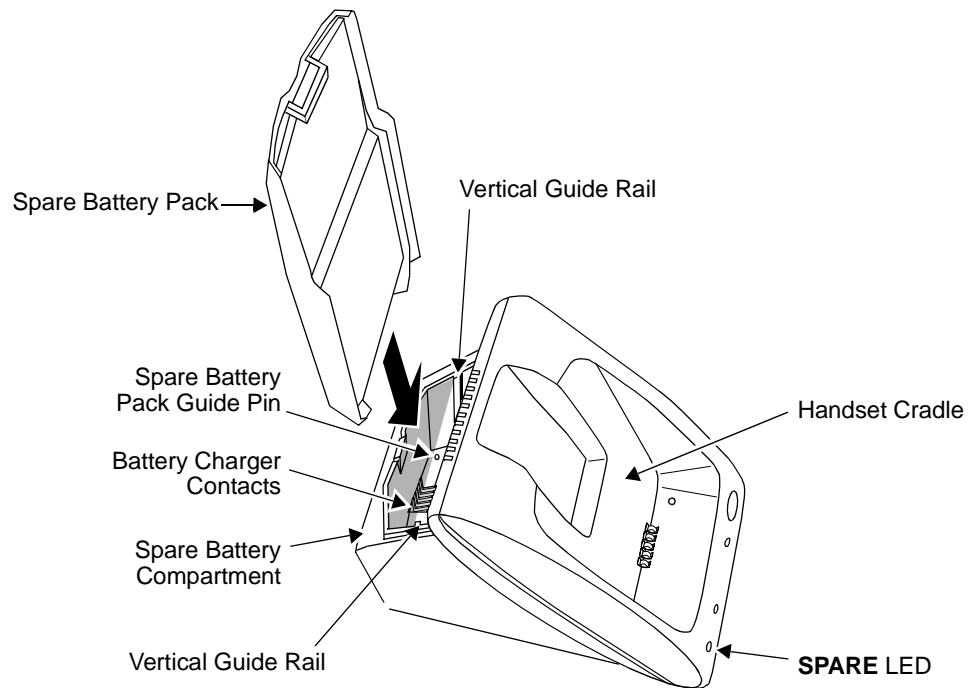
**Removing a Battery Pack from the Spare Battery Compartment**

To remove a battery pack from the spare battery compartment of the charger, lift the battery pack up and out.

## Inserting and Removing the Handset's Battery Pack

Before you register the handset with the radio module, you must insert the charged battery pack in the handset. The following explains how to install the handset battery pack.

To insert the battery pack into the handset:

- 1 Insert the two small rectangular tabs located along the bottom back edge of the handset into the two rectangular holes along the bottom front edge of the battery pack.

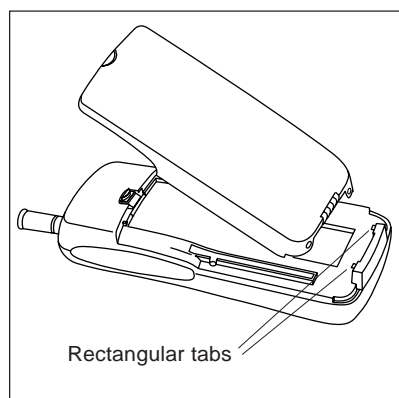

- 2 Press the battery pack downward until it clicks into place.

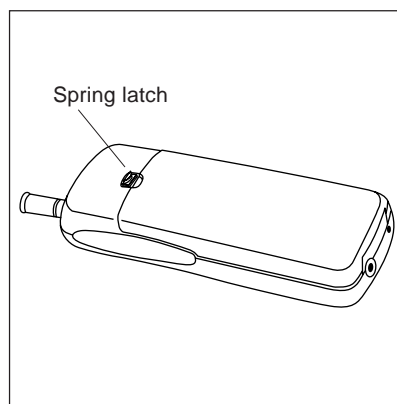

**Note:** The battery pack must be charged prior to using the handset.

- 3 To remove the battery pack, slide the spring latch upward (away from the battery pack). Then, grasp both sides of the battery pack and gently pull the battery pack upward and out.

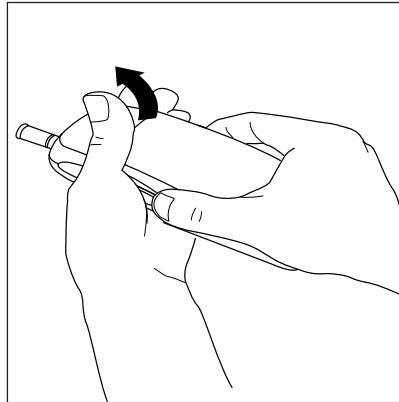

## Inserting the Handset into the Battery Charger's Handset Cradle

### Positioning and Inserting the Handset

Correct positioning of the handset in the charger is important to ensure proper charging:

- 1 Position the handset (with either battery pack attached) so that the two small round holes in the bottom of the handset fit over the two guide pins on the bottom of the handset cradle.
- 2 Rock the handset back into the cradle until it is firmly seated with the back of the handset battery pack against the back of the handset cradle.

When the handset has been inserted correctly, the following occur:

- The **HANDSET** Battery Status LED lights.
- If the handset was off-hook, the **OFF-HOOK** icon in the display is no longer visible.
- Any call that was in progress is terminated.

Figure 11. Inserting the Handset into the Battery Charger

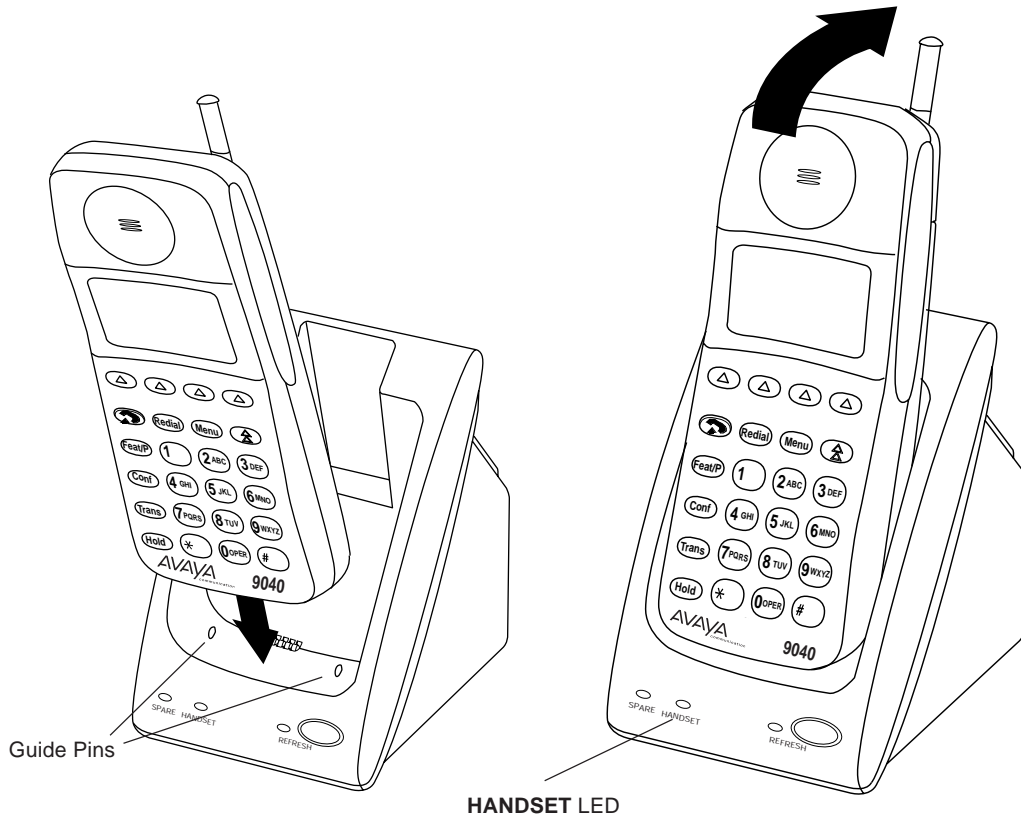

**Removing the Handset from the Handset Cradle** To remove the handset from the handset cradle, lift it out.

# 3 Using the Battery Charger

## The Battery Charger

The battery charger charges battery packs in both the spare battery compartment and in the handset when the handset is placed into the handset cradle. If both are present at the same time, charging in the spare battery compartment is suspended until the battery pack in the handset is fully charged.

**Figure 12. The Battery Charger**

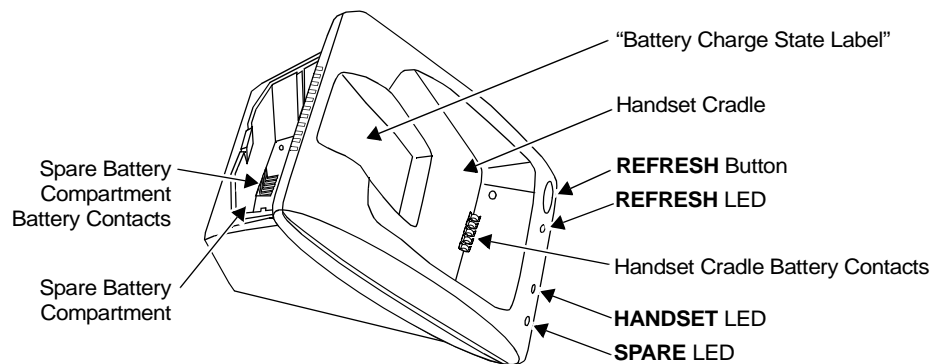

**Note:** Do not touch, push, or pull any exposed battery contacts.

## Battery Charger Features

The battery charger offers these features:

- The **spare battery compartment** refreshes the battery pack automatically by fully *discharging* it before *recharging* it. This process reduces or eliminates the potential “memory” effect. Memory effect, which reduces a battery’s capacity, occurs over time when you repeatedly recharge a battery before it is fully discharged.
- The **handset cradle** charges a battery pack in the handset.
- The **REFRESH button**, when pressed, refreshes the handset battery pack in the handset cradle by fully *discharging* the battery pack before *recharging* it.
- The **REFRESH** and the **HANDSET** LEDs go on when the **REFRESH** button is pressed and stay lit until the battery pack finishes *discharging*.
- The **HANDSET** LED, when lit, indicates that the handset battery pack is installed in the handset, and the handset is in the handset cradle.
- The **SPARE** LED, when lit, indicates that a battery pack is in the spare battery compartment.

**Note:** Before you use the MDW 9040 Pocket Phone handset for the first time, the battery pack must be charged.

The color of the battery charger's LEDs indicates the state of the corresponding battery pack, as shown in the following table:

Battery charger LED shows...	If it is the SPARE LED, the battery pack in the spare battery compartment...	If it is the HANDSET LED, the battery pack in the handset...	If it is the REFRESH LED, the Refresh button was pressed, and the handset battery pack...
Steady orange	Is charging	Is charging	N/A
Steady green	Is fully charged	Is fully charged	N/A
Flashing red See Note below.	Has one of the following problems: <ul style="list-style-type: none"> <li>Is not seated properly in the charger</li> <li>Has dirty contacts</li> <li>Is defective</li> </ul>	Has one of the following problems: <ul style="list-style-type: none"> <li>Is not seated properly in the charger</li> <li>Has dirty contacts</li> <li>Is defective</li> </ul>	N/A
Steady red	Is in the Discharge portion of the Refresh cycle	Is in the Discharge portion of the Refresh cycle	Is in the Discharge portion of the Refresh cycle
<b>Note:</b> If either the <b>SPARE</b> LED or the <b>HANDSET</b> LED is flashing red, both battery packs must be removed from the charger to clear the flashing-red condition. Address the possible problems for one battery pack at a time to determine whether one is bad.			

## Extending Battery Life

The battery charger will charge a battery pack in the handset if you simply insert the handset in the battery charger's handset cradle; however, the Refresh process fully discharges the battery pack before recharging it, thereby ensuring the best possible charge and the longest talk time. For more information about the battery charger, see "The Battery Charger" in Chapter 2.

"Memory effect" reduces a battery's capacity and can occur when you repeatedly recharge a battery pack before it is fully discharged. The nickel metal hydride battery pack shipped with your MDW 9040 is resistant to the memory effect. Even so, it is recommended that you refresh your battery pack at least once a week.

The following table shows how long refreshing takes, depending on how much charge is left in the battery pack when you insert it into the charger and press the **REFRESH** button:

Battery Pack	Battery-Pack Charge State	Average Discharge Time	Average Recharge Time	Average Total Time
Standard Battery Pack	Low charge ( <b>Battery</b> icon is lit)	0.5 hours	1.25 hours	1.75 hours
	Full charge	3 hours	1.25 hours	4.25 hours
Extended Battery Pack	Low charge ( <b>Battery</b> icon is lit)	0.5 hours	3.25 hours	3.75 hours
	Full charge	8 hours	3.75 hours	11.75 hours



Note that your handset will consume power both during talk time (when the handset is turned on) and during standby time (when the handset is turned off, but out of the battery charger). The following chart illustrates typical power usage:

Battery Use at Full Charge		
Type	Approximate Talk Time	Approximate Standby Time
Standard Battery Pack	3 hours	22 hours
Extended Battery Pack	8 hours	72 hours

As a guideline, you can expect a 1-hour reduction in talk time for every 7 hours of standby time. Similarly, you can expect a 7-hour reduction in standby time for every hour of talk time.

It is highly recommended that you purchase a second battery pack to use as a spare. With the spare battery pack in the spare battery compartment of the battery charger, you are assured of always having a fresh, usable battery pack.

The following steps will ensure an uninterrupted supply of power to your MDW 9040 Pocket Phone:

- If you have only one battery pack, be sure to refresh it at least once a week. You can refresh it by:
  - ~ Placing it in the spare battery compartment of the battery charger.
  - ~ Leaving it in the handset, placing the handset in the handset cradle of the battery charger, and pressing the **REFRESH** button.
- If you have two battery packs, exchange the packs between the handset and the spare battery compartment at least once a week, so that each battery pack is automatically refreshed. (Alternate the battery packs even if the handset battery never flashes the **Battery** icon in the handset display to indicate a low battery condition.)
- The average battery life for both the standard and the extended battery packs is approximately one year, assuming that the battery is discharged and charged once a day. If the battery packs are discharged and charged twice a day, the life expectancy is approximately six months.

**IMPORTANT NOTE: Depending on the level of memory effect that the battery pack has, it is sometimes necessary to refresh the battery pack two or more times.**

- ~ Insert the battery pack in the spare battery compartment of the battery charger and leave it there until the **SPARE** LED is steady green. Remove the battery pack from the charger, then reinsert it, and leave it until the **SPARE** LED is steady green a second time.
- ~ **OR**, with the battery pack in the handset, insert the handset in the handset cradle, press **REFRESH**, and leave it there until the **HANDSET** LED is steady green. Remove the handset from the handset cradle, then reinsert it, press **REFRESH** again, and leave it until the **HANDSET** LED is steady green a second time.



# 4 Registering the Pocket Phone to a Dual Radio Module

## Registration Overview

You must register the Dual Radio Module with its associated handsets. For single zone operation, each handset must be registered to its associated radio module; each radio module can be registered with one or two handsets. For a handset being used in a dual zone configuration, the handset must be registered to a radio module in each of the two zones.

## Setting Up and Registering the Handset

Before you begin using your telephone, you must:

- 1 Insert the charged battery pack into the handset.
- 2 Register the handset with the correct radio module(s).

For a detailed description of the handset and its features, see Chapter 5, "Programming & Using the MDW 9040 Pocket Phone." There, you will find a drawing of the handset with a description of its features, and procedures for configuring and using your telephone, as well as directions for performing a Local and a Wireless Test of the handset.

## Registering a Handset

To register your handset with the radio module to which it will be connected in a single zone configuration or the first zone of a dual configuration:

- 1 Signal the radio module that registration is about to start by pressing the Handset Registration activation button on the Dual Radio Module corresponding to the Line (1 or 2) to which the handset will be registered.

**Note:** After you press the Handset Registration activation button on the Dual Radio Module, there is a 5 minute time limit to complete the registration process. If no further action is taken during this span of time, the radio module will time out, and you must start the registration process again.

- 2 At the handset, press **Menu**.

The initial Menu screen displays.

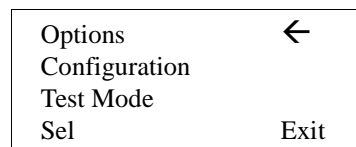

- 3 Press the Select-Row () button to move the arrow to the right of the selected option to **Configuration**.

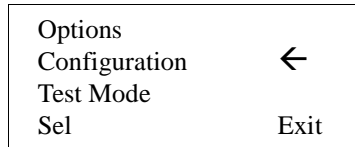

- 4 Press the Softkey () below **Sel**.

The initial Configuration Menu screen displays.

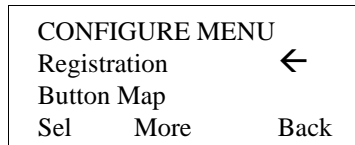

- 5 Press () to move the arrow to **Registration** and then press the Softkey () below **Sel**.

The Registration screen (Zone 1 and Zone 2) displays.

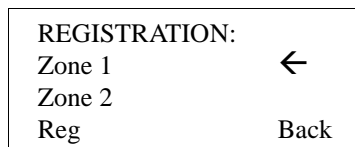

**IMPORTANT NOTE:** After you enter the Registration Mode on the **handset**, there is a 60 second time limit in which to register before the menu time's out.

- 6 For single zone operation or the first zone of a dual zone installation, move the arrow to Zone 1, then press the Softkey () below **Reg**.

The following occurs:

- The selected radio module makes checks regarding the handset registration request.
- If there are no unexpected conditions, the associated base module and handset communicate using special link-up signaling.
- The handset displays the following screen when registration is completed. (When selecting Registration in Step 5, this screen displays if the handset was previously registered.)

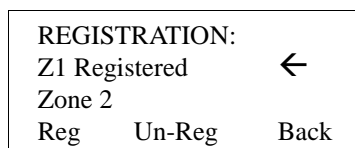

**Note:** Repeat these procedures for a second handset registered to this radio module or for multiple radio modules in a single zone configuration.

The LEDs on the radio module have the following meaning.

Flashing <b>Power</b> LED	Handset is in Registration Mode for Line 1
Flashing <b>Control</b> LED	Handset is in Registration Mode for Line 2

**IMPORTANT NOTE:** The radio module will NOT allow the registration process to occur if there is anything preventing registration such as the radio module actively communicating with a previously registered handset.

- 7 To exit any screen and move back to the previous screen, **OR**, if you do not want to make any changes at this time, press the Softkey () below **Back**.
- 8 Proceed to the instructions in “Mapping to the Correct Communications System” on page 40.

### Registering the Second Zone of a Dual Zone Configuration

To register your handset with the radio modules to which it will be connected in a dual zone configuration:

- 1 Follow the procedures in the previous section, “Registering a Handset” on page 35.
- 2 Select Zone 2 in Step 5 to register the handset with the other radio module with which it will be associated for dual zone operation.

The following occurs:

- The second radio module makes checks regarding the handset registration request.
- If there are no unexpected conditions, the associated base module and handset communicate using special link-up signaling.
- The handset displays a “Registration Completed” message to the user.

The LEDs on the radio module have the following meaning.

Flashing <b>Power</b> LED	Handset is in Registration Mode for Line 1
Flashing <b>Control</b> LED	Handset is in Registration Mode for Line 2

**IMPORTANT NOTE:** The radio module will NOT allow the registration process to occur if there is anything preventing registration such as the radio module actively communicating with a previously registered handset.

- 3 To exit any screen and move back to the previous screen, **OR**, if you do not want to make any changes at this time, press the Softkey () below **Back**. To exit Menu Mode, press the Menu button.
- 4 Once all handsets have been registered, proceed to the instructions in “Mapping to the Correct Communications System” on page 40.

### Removing Registration Between a Handset and a Dual Radio Module

To unregister a handset and a radio module:

- 1 Follow Steps 1 through 5 of the registration procedures.
- 2 At the Registration screen (**Zone 1** and **Zone 2**), press the Softkey () below **UnReg**.

### A Quick Reference Procedure for Handset Registration

Refer to the main features on the radio module in Figure 3: "The Dual Radio Module" on page 9 as you complete the procedural steps listed below.

**STEP 1:** Use the Station Line Cord provided to connect the radio module Line jack (either Line 1 or Line 2) to the desired station port.

**STEP 2:** Attach a charged battery to the handset.

**STEP 3:** Use the handset Menu and the double-arrow Select-Row buttons under the CONFIGURATION option to select the REGISTRATION screen.

**STEP 4:** Press the Handset Registration activation button on the Dual Radio Module corresponding to the Line (1 or 2) to which the handset will be registered. The corresponding radio module LED will flash to indicate that the radio module is ready for handset registration.

**STEP 5:** Press the Softkey (  ) below **Reg** on the handset display to complete the registration process. The handset display should indicate a successful completion and the radio module LED should stop flashing.

REGISTRATION: Z1 Registered ← Zone 2 Reg Un-Reg Back
---

**NOTE:** For dual zone operation, register the first handset to Zone 1. Then, repeat the registration process, moving the arrow to Zone 2 to register the handset with the other radio module to which it will be associated for dual zone operation.

The following occurs:

- ~ The second radio module makes checks regarding the handset registration request.
- ~ If there are no unexpected conditions, the associated base module and handset communicate using special link-up signaling.
- ~ The handset displays a "Registration Completed" message to the user.

## Mapping to the Correct Communications System

The communications system you use determines what information the MDW 9040 Pocket Phone can display and how the phone lines and programmable/intercom/drop buttons are identified. (For a detailed description of Button Mapping, see the appropriate “Button Mapping” topics in Chapter 6, “MDW 9040 Pocket Phone Compatibility.”)

### Reacting to the Button Mapping Display Screens

During the registration process between the handset and the radio module, the handset notes the type of radio module to which it is connected (either a DRM-D or a DRM-E). When your handset has been successfully registered, and when the radio module is connected to the switch, the associated default button mapping will flash. The table below lists the default switch interfaces for each radio module type.

If your handset has been registered to this type of Dual Radio Module:	The Dual Radio Module is connected to:	The default button mapping is:
DRM-D	DEFINITY	DEFINITY
DRM-D	MERLIN MAGIX	MERLIN MAGIX
DRM-E	MERLIN	MERLIN
DRM-E	PARTNER MERLIN LEGEND with PARTNER Card MERLIN MAGIX with PARTNER Card	PARTNER

If your communication system is not the default switch listed in the table above, you must set the correct Button Mapping. Use the following procedures to verify that your handset is mapped to the correct communications system.

- 1 Press **Menu** to enter Menu Mode.

Options	←
Configuration	
Test Mode	
Sel	Exit



- 2 Press the Select-Row () button until the arrow is to the right of **Configuration**.

Options	
Configuration	←
Test Mode	
Sel	Exit

- 3 Press the Softkey () below **Sel**.

CONFIGURE MENU		
Registration	←	
Button Map		
Sel	More	Back



- 4 Press  until the arrow is to the right of **Button Map** and then press the Softkey () below **Sel**.

Button Map:		
Partner		←
Merlin/Partner		
Sel	More	Back

**Note:** For MERLIN LEGEND R7, use the Merlin/Partner button map.

- 5 From the Button Map screen, choose **Partner**, or **Merlin/Partner**, or press the Softkey () below **More**.

Button Map:		
Merlin		←
Merlin (410/820)		
Sel	More	Back

**Note:** For MERLIN LEGEND releases before R7, use the **Merlin** button map.

- 6 Choose **Merlin**, or **Merlin (410/820)**, or press the Softkey () below **More**.

Button Map:		
Merlin Magix		←
Definity		
Sel	More	Back

- 7 For **Merlin Magix**, or **Definity**, the radio module will automatically choose the correct button map.

**Note:** If you receive a failed message that reads “Switch Config. failed. Conflict with DRM type,” verify that you have the correct switch with the correct Dual Radio Module and start over at Step 1.

### Filling Out the Handset Label

Once you have checked to make sure that the MDW 9040 is mapped to the correct communications system, fill out the handset label on the back of the handset. The MDW 9040 display shows the status of up to 12 lines or programmable/intercom/drop buttons. Since the MDW 9040 is compatible with several different communications systems, diagrams of the button mappings for these systems are provided in Chapter 6, “MDW 9040 Pocket Phone Compatibility.”

The MDW 9040 has a label on the back of the handset near the top where you can record:

- Your extension number.
- The mapping of your MDW 9040 line buttons to those on a wired phone for your communications system.

**Note:** Use a pencil or *ballpoint* pen on the label, in case you want to erase the information later. Do *not* use felt-tip or other types of non-erasable markers. Also, do not remove the label.

Figure 13. The Handset Label

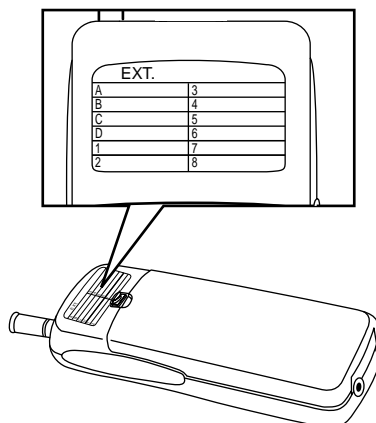

To fill out the handset label:

- 1 Write your extension number on the label.
- 2 Locate the section in Chapter 6 that describes the button mapping for your communications system; then copy the mapping to the label for ease of reference.

### Other Handset Configuration Options

Before using your handset and its display, you may also wish to do the following:

- Select the **Display** (1 or 2 lines). For more information about selecting the display length, see Chapter 5, "Programming & Using the MDW 9040 Pocket Phone."

# 5 Programming & Using the MDW 9040 Pocket Phone

---

## Important Safety Instructions

Please see “Important Safety Instructions” provided at the beginning of Chapter 2.

## About the Handset

The MDW 9040 Wireless Pocket Phone supports normal operation of all of the features of the switch as far as is practical within the limitations of its reduced size and power and the nature of wireless operation. There are very few differences in operation between the wireless MDW 9040 Pocket Phone and a wired deskset.

This chapter describes the handset and how to use it. It also explains how to use a headset.

## Handset Features

Figure 14. The MDW 9040 Pocket Phone\

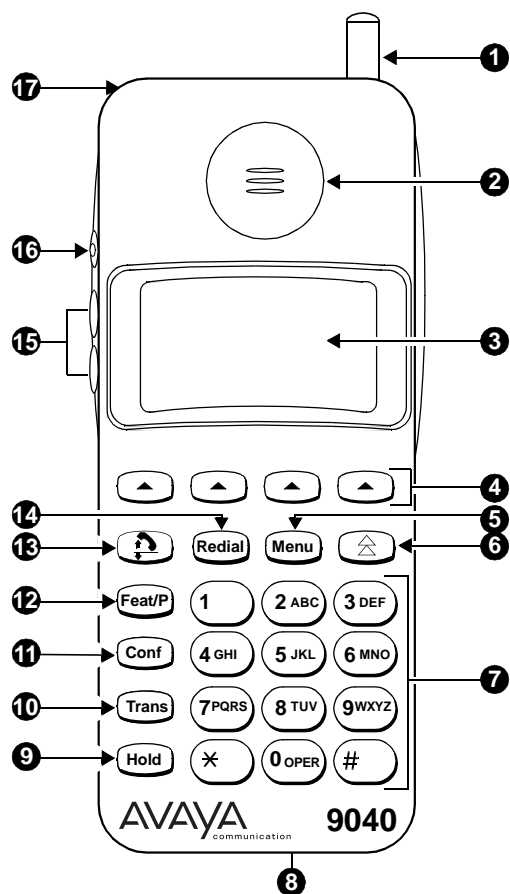

- 1 Antenna** — Extend fully or retract fully to use handset. Extend fully to maximize the handset range and voice quality.
- 2 Receiver** — Receives the sound of your caller's voice, unless a headset is connected.
- 3 Handset Display with Backlighting** — Displays status of lines and range as well as system and local programming messages. For a detailed description, see the following section, "The Handset Display."
- 4 Four Softkeys/Column Buttons** — Use together with Select-Row button to choose a line or programmable/intercom/drop button.
- 5 Menu Button** — Press to enter/exit Menu Mode.
- 6 Select-Row Button** — Use to move the Select-Row arrow, and, together with the Column buttons, to choose a line or programmable/intercom/drop button. Also used to "wake-up" the phone.
- 7 Dial Pad** — The usual 12-button dial pad for placing calls or accessing features.
- 8 Headset Connector** — Plug in the headset adapter to use the headset.
- 9 Hold** — Press to put a call on hold.
- 10 Trans (Transfer)** — Press to transfer a call to another extension.
- 11 Conf (Conference)** — Press to conference in (add) another person to your call.

**12 Feat/P (Feature/Program)** — Press to access switch-dependent features or to enter Programming Mode. (Exit for 9040 DCP only.)

**13 (On/Off)** — Press to turn the handset on.  appears in the handset display next to the battery icon. To turn off, press again. Turn on to place or answer a call, and turn off to "hang up."

**14 Redial Button** — Press to redial the last number manually dialed from the handset.

**15 Volume Control** — Press "▲" to increase or "▼" to decrease the volume of the receiver or alerter.

**16 Mute Button** — Press to turn the handset microphone off for privacy.

**17 Lanyard Loop** — Attach an (optional) lanyard for carrying the handset.

## The Handset Display

The MDW 9040 Pocket Phone display has one line of icons and four alphanumeric-character lines (up to 16 digits and/or characters on each line) to provide you with status information and programming options. The MDW 9040 display also provides Backlighting so that you can read your display in poorly-lit environments. You can choose to turn on the Backlighting feature or turn it off as well as select the amount of time the feature is on. The following default screen appears initially on the handset display.

- **The top row of the display** shows the status icons.

**Figure 15. The MDW 9040 Display**

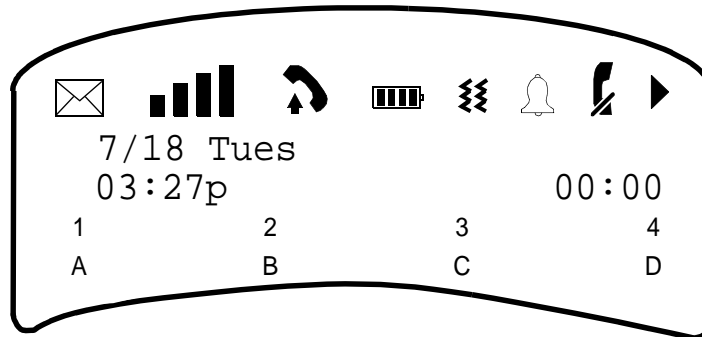

The following list describes the meaning of each status icon (from left to right).

**Figure 16. The Top Row of the Display Showing Handset Status Icons.**

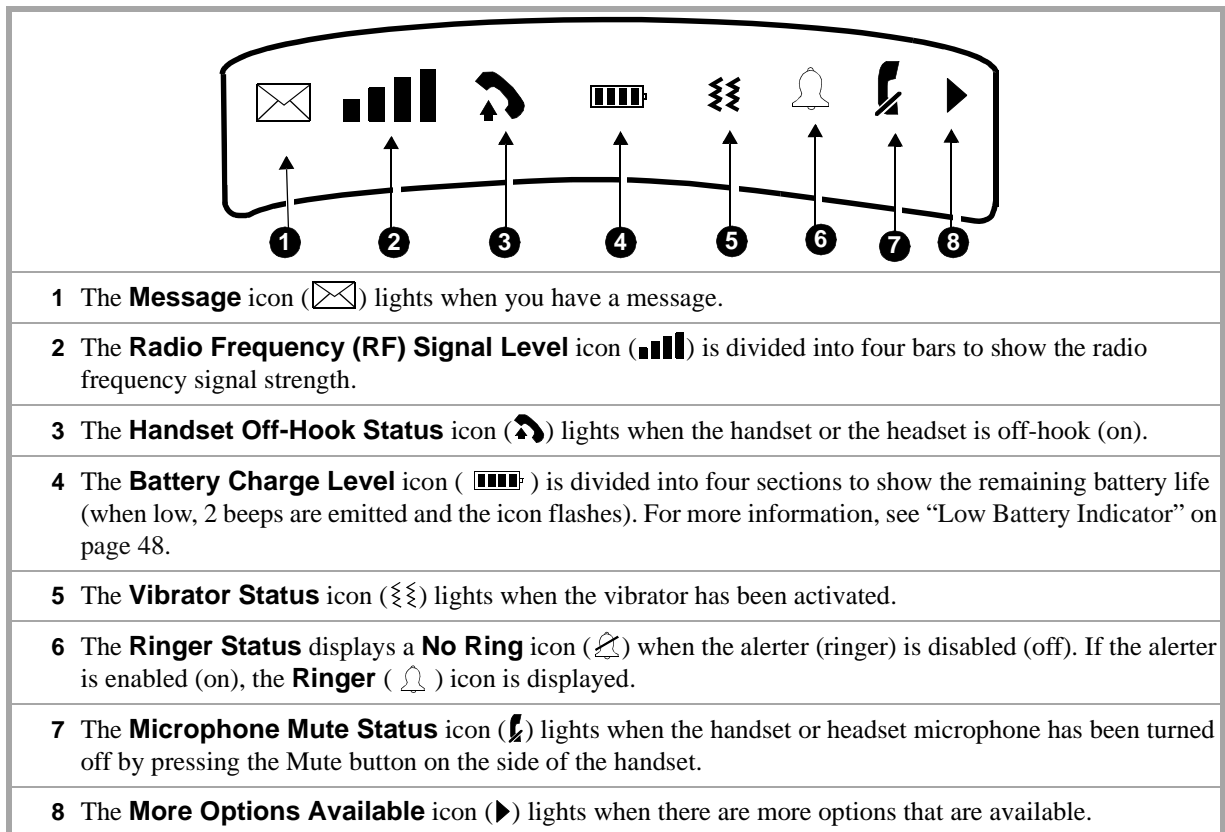

- **The second and third rows of the display** show the information you would see on the top line (and second line if provided by the system to which you are connected) of a wired system phone's display. The information varies according to which communications system you are using. For example, the display may show the current date, the number you are calling, or Caller ID information (if the system supports this feature). This display line is also used for feedback when testing and programming the handset.

**Note:** When the MDW 9040 is shipped from the factory, it is set for a 2-line display (see "Figure 15: The MDW 9040 Display" on the previous page). However, the display length can be changed to 1-line if so desired (see "Figure 17: Using the Select-Row and Column Buttons Together" on the next page). If you choose 1-line of information for your display, four additional programmable buttons appear on the third line of the display.

- **The fourth and fifth rows on the display** show the line or programmable/intercom/drop buttons. Line Status indicators, such as a triangle or a rectangle next to the line you are using or to which you will be connected once you turn on the phone are discussed in "Line Status Indicators" in the next section. See Chapter 6, "MDW 9040 Pocket Phone Compatibility" for more information about Button Mapping.

### Line Status Indicators

There are up to 12 status indicators (**A through D, 1 through 8**, see Figure 15). Each one corresponds to a specific outside or intercom line, recall and/or drop button and programmable buttons. (The function of these status indicators varies, depending on the communications system you are using—see the Button Mapping topic in Chapter 6, "MDW 9040 Pocket Phone Compatibility" for the appropriate communications system switch.) The status indicators show either a triangle (◀) or a rectangle (■), signifying the following activity:

#### For PARTNER Systems:

A **triangle** (◀) showing line status is the equivalent of a green LED on a wired system phone.

A **rectangle** (■) showing line status is the equivalent of a red LED on a wired system phone.

#### For all other Systems:

A **rectangle** (■) showing line status is the equivalent of a green LED on a wired system phone.



A **triangle** (◀) showing line status is the equivalent of a red LED on a wired system phone.

### The Select-Row Button and the Column Buttons

The MDW 9040 Pocket Phone can display the status of up to 12 lines/intercom/programmable buttons, but the number of lines supported by compatible communications system switches varies.

**Use the Select-Row** (⬆) **button** to move the arrow on the right side of the display up one row. Each time you press the Select-Row (⬆) button, the arrow moves to another row (cycling through the three rows in turn, and then returning to the bottom row).

Located under the display are four Column buttons, labeled  (in Menu Mode, these four buttons are called **Softkeys**). Each Column button affects one of the four columns or programmable/intercom/drop buttons directly above it.

Once you have moved the Select-Row () button to the row you wish to access, press the Column button () to select the line or programmable/intercom/drop button in that row.

For example, if you press the second Column button from the left (shaded in Figure 17 below), you select Line 2, as indicated by the triangle (for PARTNER) next to 2 in the figure below.

**Figure 17. Using the Select-Row and Column Buttons Together**

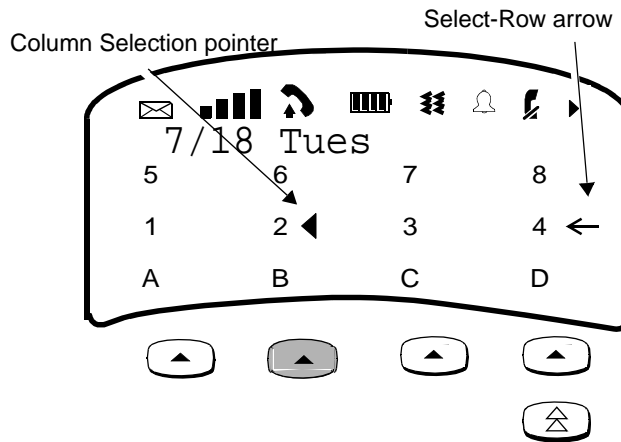



### Signal Strength and Range Indicators

Signal Strength is indicated by the number of bars in the **Radio Frequency (RF) Signal Level** icon (). Four bars indicate optimal signal level, while one bar or no bars indicate poor signal level.

**Note:** The antenna must be either fully retracted (for short range) or fully extended (for maximum range) to use the Pocket Phone.

**Approaching Out of Range:** The handset provides an audible and a visual signal to alert you when the handset is near the end of the range of the radio module. Depending on how far away the handset is from the radio module, the signals function as follows:

- During a call, the handset emits **2 beeps** and/or turns on the vibrator for a short period of time and flashes the  icon continuously.

**Out of range.** You have walked into an area that is near the end of the operating range of the radio module. You can continue your conversation or initiate a call, but you are likely to experience a degradation in voice quality or possible loss of communications link. If a link is lost, the call will be automatically placed on Hold, before the handset will turn off. To talk with your party, move back toward the radio module, press , then proceed as you would for any call placed on Hold.

- If out of range and attempting to make a call, the handset emits **2 beeps** and flashes the  icon twice; then the handset automatically turns off.

**Cannot establish communication link.** You are completely out of range of the radio module. To make the call, move back towards the radio module and try again.

**Turning the Handset On (off-hook)** To place the handset off-hook:

- 1 Press .

This action wakes up the handset and tells the switch that the handset is off-hook. The  icon on the display screen lights.

The Home screen appears on the display. See Figure 15 for a sample display.

**Note:** If you press  a second time, the handset goes off.

For more information about using the display to set or change the handset settings, see “Setting or Changing Handset Settings” on page 50.

#### Low Battery Indicator

The Battery Charge Level is indicated by the number of cells displayed on the **Battery Charge Level** icon (). If all four cells are filled in, the battery is fully charged. If two or less cells are displayed, it is time to recharge the battery.

The standard battery pack has approximately three hours of continuous talk time after being fully charged.

The optional extended battery pack has approximately eight hours of continuous talk time after being fully charged.

When the handset is On and the battery power is low, the handset will emit two beeps and/or turn on the vibrator for a short period of time and the  icon on the handset display will flash. When this occurs, depending on the condition and/or age of your battery, you have five minutes or less of talk time left. At this point, you can either:

- Complete your call, turn the handset off, and recharge the battery pack, **or**,
- If you have a charged spare battery pack, place your call on Hold and replace the handset battery pack with the spare battery pack. Wait 6 to 10 seconds, then turn the handset on and proceed as you would for any call placed on Hold.

**Note:** When the battery power is low, two beeps will sound each time you press  until either the battery is drained or you replace the battery. If you continue talking, the handset will turn off when the battery pack is drained. Your call will be placed on Hold automatically so that you can swap battery packs or pick up the call on another telephone.



### Adjusting the Volume Control

The volume control is located on the side of the handset. The volume buttons are marked with an arrow “▲” (volume up) “▼” (volume down). This control raises and lowers the volume of the alerter and the receiver. There are eight incremental volume levels. If the ringer is enabled on the user menu, the display indicates the current volume level with arrows (>>).

**Figure 18. Volume Control Buttons**

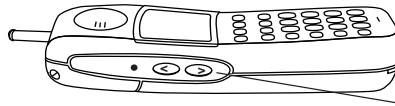

▲ and ▼ Volume Control Buttons

- To raise or lower the **Alerter** (or **Ringer**) volume: While the MDW 9040 is awake but on-hook, press the “▲” or the “▼” button. Each time you press the “▲” or “▼” button, the handset makes a “chirping” sound, and the display shows the current volume level.

**Figure 19. Ringer Volume Level Display**

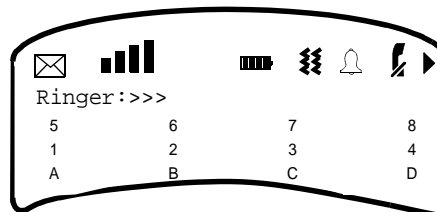

- To raise or lower the volume of the **Handset Receiver** (or the **Earpiece**): While the MDW 9040 is off-hook, press the “▲” or the “▼” button. Each time you press the “▲” or “▼” button, the handset audio dial tone level changes, and the display shows the current volume level. There are four ringer settings.

**Figure 20. Receiver Volume Level Display**

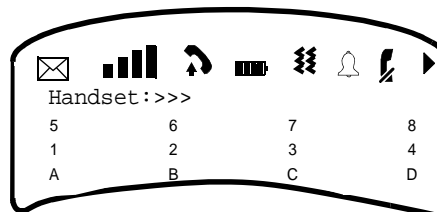

### Muting the Handset or Headset Microphone

To turn off the microphone associated with the handset or headset while the handset is off-hook:

Press the Mute (  ) button on the side of the handset.

*The microphone is turned off. The  icon lights.*



- Note:** If you press  a second time, the Mute function is turned off. The Mute function is also turned off when the handset goes on-hook or if the user changes to another line.

## Setting or Changing Handset Settings

You can set or change the handset settings by entering Menu Mode (press ) and completing the procedures for the following functions:

- From the **Configure** menu:
  - ~ **Register** your handset with the appropriate radio module.
  - ~ Choose the **Display length** (1 or 2 lines).
- From the **Options** menu:
  - ~ Choose the **Type of Alerter** you want to use on your phone, the ringer and/or the vibrator.
  - ~ Turn off/on **Backlighting** for your telephone display.
  - ~ Turn on the **Line Pre-Select** feature.
  - ~ Hear **Key Clicks** as you press keys on the telephone dial pad.
- From the **Test Mode** menu:
  - ~ Enter **Local Test Mode**, which enables you to test the alerter, vibrator, and display.
  - ~ Enter **Wireless Test Mode**, which enables you to test sound clarity, signal strength, and voice quality.

**Selecting a Menu Item**    The Selection control buttons are used to identify fields within three rows (the 3rd, 4th, and 5th rows) on your display.

- After pressing  to enter Menu Mode, use the Select-Row () button to move the arrow to the right of the line currently being viewed, to the appropriate row. The arrow moves down from the second to the third row, then to the fourth row, and then cycles back to the second row again.

This action wakes up the handset and enables all of the other handset buttons.

- The four Softkeys () beneath the display allow you to select the items shown on the fifth row of the display screen.

For example, to select an option on the handset display:

- 1 Press **Menu** to enter Menu Mode.

The display shows the initial Menu screen.

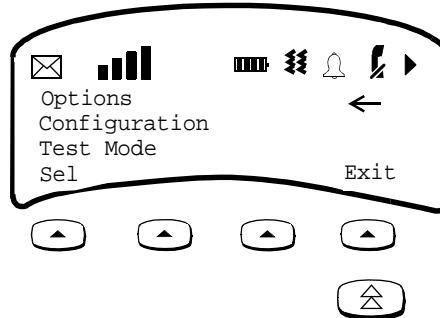

- 2 Press the Select-Row (**△**) button until the arrow is placed to the right of the row on which the selected option is located. For example, press **△** until the arrow is placed to the right of **Options** as in the example above.
- 3 Press the Softkey (**▲**) below **Sel** (for **Select**).

**Responding to the Last Line on the Screen**

On the bottom row of the screen, you may see **Sel**, **More**, or **Exit/Back** such as in the following example:

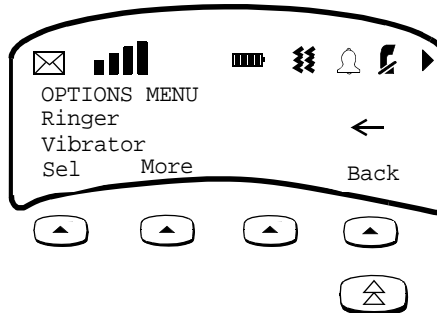

These options indicate:

- **Sel**(ect) — you can select the currently highlighted option such as Ringer or Vibrator by pressing the Softkey (**▲**) below **Sel**.
- **More** — there are more options than shown on the current screen. To see the next screen of options, press the Softkey (**▲**) below **More**.
- **Back**— available on many screens, this option allows you to go back to the previous screen.
- **Exit** — available on the initial Menu screen, this option allows you to exit Menu Mode. When in Menu Mode, you can also exit by pressing the Menu button.

### Features and Options

As you read the following information, refer to “A Flowchart for the Configuration, Options, and Test Mode Display Screens” on page 59.

#### Configuration Menu

Before you begin to use your MDW 9040 Pocket Phone, you must configure the telephone for the following options accessed through the Configuration Menu:

- Registration
- Button Mapping
- Display

To access the Configuration Menu:

- 1 Press **Menu** to enter Menu Mode.

The initial Menu screen displays.

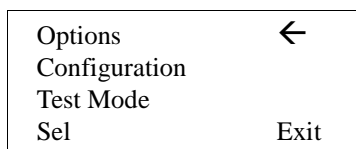

- 2 Press the Select-Row () button to move the arrow to **Configuration**.

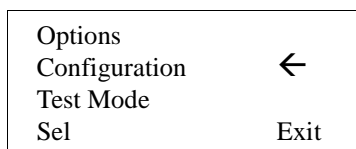

- 3 Press the Softkey () below **Sel**.

The initial Configure Menu screen displays.

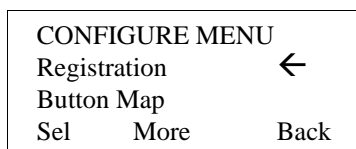

#### Registering the Handset to the Dual Radio Module

The Registration feature under the Configure Menu allows you to register the handset with its appropriate radio module. For detailed instructions on registering the handset with the appropriate radio module(s), see the information included in Chapter 4, “Registering the Pocket Phone to a Dual Radio Module.”

#### Button Mapping

The Button Map feature under the Configure Menu allows you to map your MDW 9040 to the correct communications system. For information on Button Mapping, see Chapter 6, “MDW 9040 Pocket Phone Compatibility.”

**Choosing the Number of Display Lines**

When the MDW 9040 Pocket Phone is shipped from the factory, it is set for **2 lines of text**, on the second and the third lines of the display screen. However, the display can be changed to **1 line of text** if so desired.

To select the length of a Display message:

- 1 From the initial Configure Menu screen, press the Softkey (⬆) below **More**.

The additional Configure Menu feature displays.

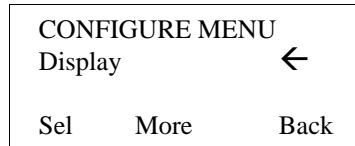

- 2 With the Select-Row arrow to the right of **Display**, press the Softkey (⬆) below **Sel**.

The Display Menu screen displays.

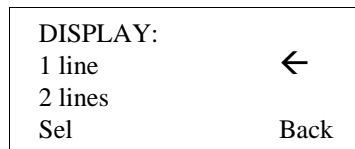

**Note:** The currently active option, if there is one, flashes.

- 3 Press the Select-Row (⬆) button to move the arrow to the display length you want and press the Softkey (⬆) below **Sel**.

**Figure 21. Example of 1 Line screen**

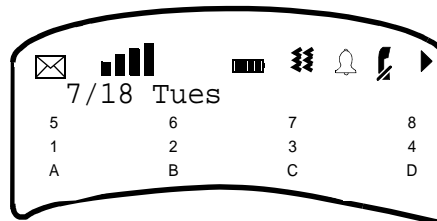

**Figure 22. Example of 2 Line screen**

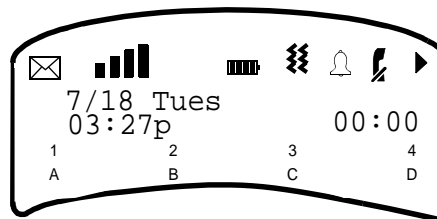

### Options Menu

Once your handset is registered with the correct radio module, you can customize your MDW 9040 with the following options accessed through the Options Menu:

- Ringer
- Vibrator
- Backlighting
- Pre-Select
- Key Clicks

To access the Options Menu:

- 1 Press **Menu** to enter Menu Mode.

The initial Menu screen displays.

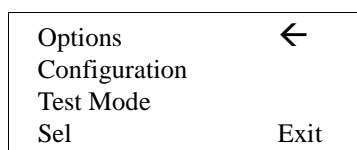

- 2 With the Select-Row arrow to the right of **Options**, press the Softkey (**▲**) below **Sel**.

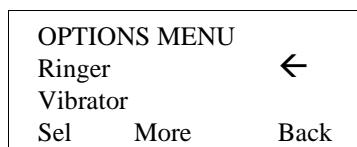

The initial Options Menu screen displays.



### Choosing the Type of Alerter

You can choose the type of alerter you want to hear on your phone. Select either the **Ringer** or the **Vibrator** option or both to alert you when there is an incoming call.

- ~ **The Ringer** is an audible signal to notify you of an incoming call. If a call comes in while the phone is idle, the handset rings. If you are already on a call, the handset chirps softly. You can adjust the volume of the alerter by pressing the "**▲**" button or the "**v**" button on the side of the handset *when the phone is turned off*.
- ~ **The Vibrator** can be used in place of the alerter in situations where you do not want to disturb others with an audible ring.

**Note:** The Ringer icon () is displayed on the handset when the Ringer is turned on. The No Ring icon () is lit when the Ringer is turned off. When the Vibrator option is active, the () is lit.

To enable or disable the Ringer option:

- 1 From the initial Options Menu screen, press the Select-Row () button to move the arrow to **Ringer**.

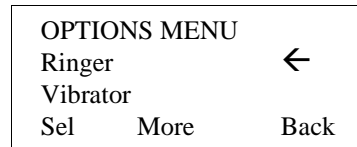

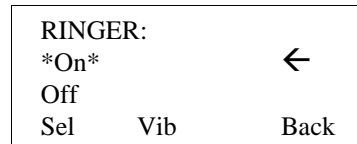

- 2 Press the Softkey () below **Sel**.

The Ringer Control screen displays:



**Note:** The currently active option, if any, flashes (indicated by \*\*).

- 3 Press the Select-Row () button to move the arrow to the **On** or **Off** option, or press the Softkey () below **Vib** to access the **Vibrator Control** screen.
- 4 When you have moved the Select-Row arrow to the appropriate option, press the Softkey () below **Sel**.

#### Enabling or Disabling the Vibrator

To enable or disable the Vibrator option:

- 1 From the initial Options Menu screen, press the Select-Row () button to move the arrow to **Vibrator**.

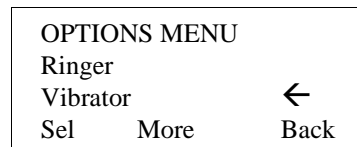

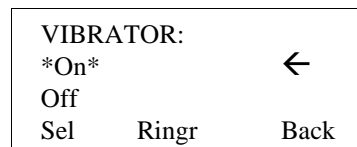

- 2 Press the Softkey () below **Sel**.

The Vibrator Control screen displays:



**Note:** The currently active option, if any, flashes (indicated by \*\*).

- 3 Press the Select-Row () button to move the arrow to the **On** or **Off** option, or press the Softkey () below **Ringr** to access the **Ringer Control** screen.
- 4 When you have moved the Select-Row arrow to the appropriate option, press the Softkey () below **Sel**.

**Activating Backlighting** The Backlighting option for the display is factory set to ON for the MDW 9040 Pocket Phone. However, the Backlighting can also be turned OFF.

Backlighting for the handset display allows you to see the display in poorly-lit environments. If you choose to turn the Backlighting option on for your handset display, you can also choose the amount of time Backlighting is active. The options are 7 seconds, 15 seconds, and 30 seconds.

To activate or deactivate the Backlighting option and choose the amount of time Backlighting is active:

- 1 From the initial Options Menu screen, press the Softkey (  ) below **More**.  
Additional Options Menu options display.



OPTIONS MENU		
Backlighting		←
Pre-Select		
Sel	More	Back

- 2 With the Select-Row arrow to the right of **Backlighting**, press the Softkey (  ) below **Sel**.

The Backlighting Control screen displays.



BACKLIGHTING:		
*On*		←
Off		
Sel		Back

**Note:** The currently active option, if any, flashes (indicated by \*\*).

- 3 Press the Select-Row (  ) button to move the arrow to the **On** or **Off** option.
- 4 When you have moved the Select-Row arrow to the appropriate option, press the Softkey (  ) below **Sel**.
- 5 If you selected to turn Backlighting **On**, you will be prompted to choose the amount of time Backlighting is active.

The Backlighting Time Setting screen displays when Backlighting is activated.

B-Light	7 sec.	
*B-Light	15sec.*	←
B-Light	30 sec.	
Sel		Back

- 6 Press the Select-Row (  ) button to move the arrow to the amount of time you want.
- 7 When you have moved the Select-Row arrow to the appropriate option, press the Softkey (  ) below **Sel**.



**Turning on the Line Pre-Select Option**

Line Pre-Select lets you choose the line or button you want to use before turning the handset on. For example, suppose your phone is ringing, but you want to pick up a call that is holding on another line instead of the ringing call. In normal operation, the communications system automatically connects you to the ringing line as soon as you turn on the handset. With Line Pre-Select enabled, you can select the line you want to connect to *before* turning on the handset.

The Line Pre-Select option can be turned ON or turned OFF.

**Note:** When Line Pre-Select is enabled, you do not have to use it; however you cannot use it unless it is enabled.

To enable Line Pre-Select:

- 1 From the initial Options Menu screen, press the Softkey (▲) below **More**.

Additional Options Menu options display.

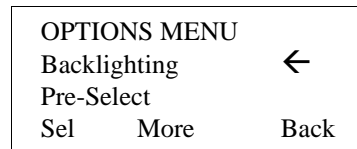

- 2 Press the Select-Row (⬆) button to move the arrow to **Pre-Select**.

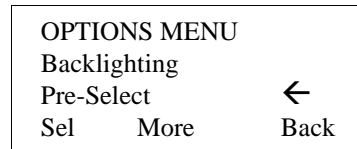

- 3 Press the Softkey (▲) below **Sel**.

The Pre-Select Control screen displays.

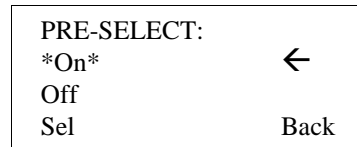

**Note:** The currently active option, if any, flashes (indicated by \*\*).

- 4 Press the Select-Row (⬆) button to move the arrow to the **On** or **Off** option.
- 5 When you have moved the Select-Row arrow to the appropriate option, press the Softkey (▲) below **Sel**.

### Enabling or Disabling Key Clicks

The Key Clicks option allows you to hear Key Clicks as you press keys on the telephone dial pad.

The Key Clicks option can be turned ON or turned OFF.

If you choose to turn the Key Clicks option on, you can also choose the volume of the Key Clicks. The options are High, Med, and Low.

To enable or disable the Key Clicks option and choose the volume setting:

- 1 From the initial Options Menu screen, press the Softkey () below **More**.

An additional Options Menu option displays.





- 2 With the Select-Row arrow to the right of **Key Clicks**, press the Softkey () below **Sel**.

The Key Clicks Control screen displays.





**Note:** The currently active option, if any, flashes (indicated by \*\*).

- 3 Press the Select-Row () button to move the arrow to the **On** or **Off** option.
- 4 When you have moved the Select-Row arrow to the appropriate option, press the Softkey () below **Sel**.
- 5 If you selected to turn Key Clicks **On**, you will be prompted to choose the volume setting.

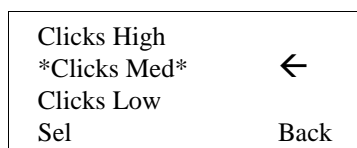
The Key Clicks Volume Setting screen displays when Key Clicks is enabled:



- 6 Press the Select-Row () button to move the arrow to the volume setting you want.
- 7 When you have moved the Select-Row arrow to the appropriate setting, press the Softkey () below **Sel**.

A Flowchart for the Configuration, Options, and Test Mode Display Screens

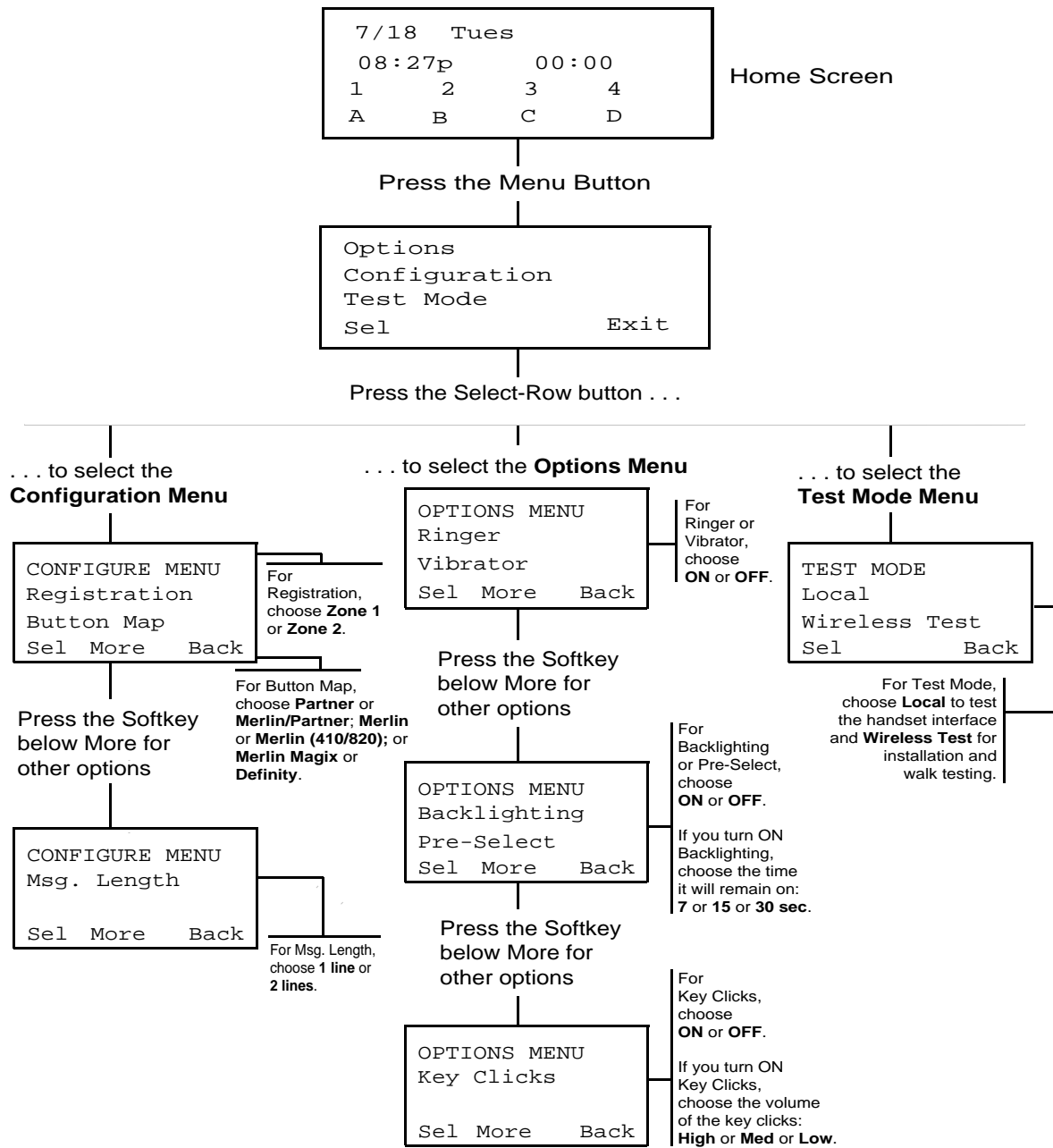

### Test Modes

You may use Local Test Mode and Wireless Test Mode to verify that your handset is working properly and that the MDW 9040 Pocket Phone is performing optimally. While the handset is in test mode, the MDW 9040 will not be alerted to incoming calls, nor will you be able to access programming mode using the Feat/P button.

**Using Local Test Mode** Local Test Mode allows you to test the handset without the radio module. You can use Local Test Mode to activate the audio warning signal, the vibrator, and all visual indicators on the handset display, enabling you to test the following:

- Does the ringer function properly?
- Does the vibrator vibrate?
- Are beeps generated when pressing all key pad buttons?
- Is the display operational?

To use Local Test Mode:

- 1 Make sure the handset is turned off.
- 2 Press **Menu**.

The initial Menu screen displays.

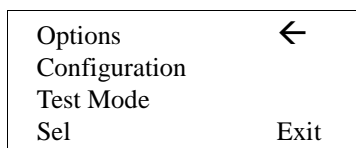

- 3 Press the Select-Row **△** button to move the arrow to **Test Mode**.

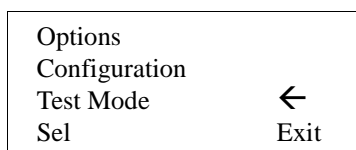

- 4 Press the Softkey (**▲**) below **Sel**.

The initial Test Mode Menu screen displays.

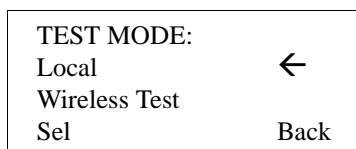

- 5 With the Select-Row arrow to the right of **Local**, press the Softkey (**▲**) below **Sel**.

The handset rings for two seconds, the vibrator vibrates for three seconds, and all indicators on the display appear (including the rectangles and triangles).

If the ringer does not sound, the vibrator does not vibrate, or the indicators do not appear, repeat Steps 1-5. If you still have problems, call for Customer Support as described in the *Copyright and Legal Notices* at the beginning of this book.

- 6 To exit both Local Test Mode and Menu Mode, press **Menu** or **End Call**.

**Note:** You must exit Local Test Mode to reinstate proper call handling.

**Using Wireless Test Mode**

Wireless Test Mode allows you to test how the handset is working with its radio module. You can determine sound clarity, signal strength, voice quality, and how far the handset will “walk” using Wireless Test Mode.

You should use Wireless Test Mode to help you locate the best place to install the radio module(s) to optimize the performance of your MDW 9040 Pocket Phone. Repeat the tests several times, with the radio module positioned in a different location each time.

By performing the tests as you walk around the area in which the handset will be used, you can determine the handset’s range and the voice quality throughout the area of coverage. To perform the tests, all you need is an electrical outlet for the radio module, a 14 foot (4.2 m) Station Line Cord (provided) with an auxiliary power supply, and a charged battery pack in the handset. You can perform the tests multiple times and in any order; you can exit at any time by pressing **Menu**.

**Note:** Ignore anything that appears on the display if you press “4” while in Wireless Test Mode. This information is for Avaya technicians’ use only.

While using Wireless Test Mode to walk on-site for a pre-site survey, **walk with the handset antenna down** to guarantee proper coverage.

To use Wireless Test Mode:

- 1 Make sure the handset is turned off.
- 2 Press **Menu**.

The initial Menu screen displays.

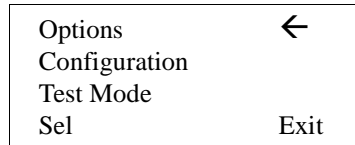

- 3 Press the Select-Row **Up Arrow** button to move the arrow to **Test Mode**.

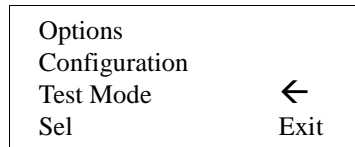

- 4 Press the Softkey (**Up Arrow**) below **Sel**.

The initial Test Mode Menu screen displays.

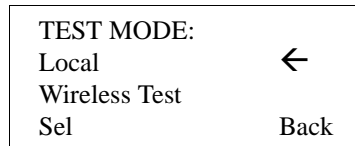

- 5 Press the Select-Row **Up Arrow** button to move the arrow to **Wireless Test**.

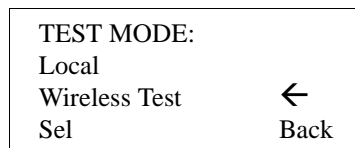

**6** Press the Softkey (▲) below **Sel**.

The handset emits a simulated dial tone, which continues until you exit Wireless Test Mode. The radio module LED signals flash in a unique pattern to identify the test ports.

The Wireless Test Mode results screen displays. (H = handset reading, B = base/radio module reading.).

SIGNAL:	H=	B=
VOICE:	H=	B=
POWER:	H=	B=
Man	Auto	Back

**Note:** Press the Softkey (▲) below **Man** to get manual test readings. Each time the Softkey is pressed below **Man**, new manual readings will display. To get an average reading, press this button a number of times (multiple readings).

Press the Softkey (▲) below **Auto** to get automatic test readings every three seconds. The automatic condition continues until either the manual Softkey button is pressed, or you exit Wireless Test Mode.

**7** To determine **signal strength** for both the handset and the radio module, press the Softkey (▲) below **Man** or **Auto**.

The display shows the signal strength (**SIGNAL**) for both the handset (**H**) and the base (**B**) (the Dual Radio Module) at the moment that the Softkey was pressed, using a number from 1 to 10.

The higher the number, the stronger the signal, as shown in the following table.

Display Number	Signal Strength Is
10	Strong
9	Strong
8	Strong
7	Very Good
6	Very Good
5	Good
4	Good to Fair
3	Fair
2	Near end of range
1	Near end of range/loss of link

- 8 To determine **voice quality** of both the handset and the radio module, press the Softkey (▲) below **Man** or **Auto**.

The display shows the voice quality (**VOICE**) for both the handset (**H**) and the base (**B**) (the Dual Radio Module) using a number from 1 to 10, as shown in the following table.

The higher the number, the better the voice quality, as shown in the following table. A low number may indicate potential interfering devices (such as another radio transmitter) in the area.

Display Number	Voice Quality Is
10	Very Good
9	Very Good/almost error free
8	Errors, but not noticeable in normal speech
7	Errors, but not noticeable in normal speech
6	Noticeable noise
5	Noticeable noise
4	Noisy but intelligible speech
3	Noisy but intelligible speech
2	Garbled speech
1	Unintelligible speech

- 9 To determine the **power level**, press the Softkey (▲) below **Man** or **Auto**.

The display shows the power level (**POWER**) to which the handset (**H**) and the base (**B**) (the Dual Radio Module) have adjusted. The power level adjusts from low power (1) to high power (8) as the Pocket Phone is moved farther from its radio module.

When the signal strength, voice quality, and power level tests are complete, the following message appears on the display screen.

Figure 23. The Wireless Test Mode Screen with Test Results

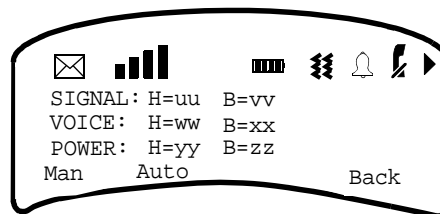

**Note:** If you wish to view the test results another time and thus repeat the Wireless Test, press the Softkey (▲) below **Man** or **Auto**.

- 10 To exit both Wireless Test Mode and Menu Mode, press **Menu** or (⏪).

### Performance / Range Test in Wireless Test Mode

Using the signal strength test and the voice quality test together, you can determine:

- if the installation has been done correctly.
- if the handsets and radio module(s) are working properly.
- the range in which your MDW 9040 Pocket Phone performs best at your site.

### Close Up Test

**Note:** To properly test the installation, **test with the handset antenna down and place all handsets into Wireless Test Mode at the same time.**

At no more than 5 to 10 feet (1.5 to 3.1 m) from its radio module, use the following procedure:

- 1 Make sure the handset is turned off.
- 2 Enter Wireless Test Mode. See “*Using Wireless Test Mode*” on page page 61.

The handset emits a simulated dial tone, which continues until you exit Wireless Test Mode. The radio module LED signals flash in a unique pattern to identify the test ports (Power LED = Line 1, Control LED = Line 2).

The Wireless Test Mode results screen displays.

SIGNAL:	H=	B=
VOICE:	H=	B=
POWER:	H=	B=
Man	Auto	Back

For all sets, do the following.

- 3 Press the Softkey (  ) below **Auto**.

The display should show a **9** or **10** for signal strength (an occasional **8** is acceptable) for both handset (H) and base (B).

The display should show a **9** or **10** for voice quality (an occasional **8** is acceptable) for both handset (H) and base (B).

Individual set readings below 9 or 10 (an occasional 8 is acceptable) can illustrate problems with individual handset/base combinations. If all set readings are below these numbers, it could indicate problems with the installation or interference from other 900 MHz devices.



**Edge of Range Test**

**Note:** To guarantee proper site coverage during this test, walk with the handset antenna down.

- 1 After performing the close up test, periodically check the signal strength and voice quality as you walk away from the radio module.

**Note:** Each time you press the Softkey (▲) below **Man**, new manual readings will display.

If you press the Softkey (▲) below **Auto**, automatic test readings will display every three seconds. The automatic condition will continue until either the Manual Softkey button is pressed, or you exit Wireless Test Mode.

- 2 When you see a signal strength of **3** and a voice quality level of **7** or **8** for both handset (H) and base (B), and the power level shows H=8 and B=8, the voice quality should be satisfactory. This is the edge of your usable range.

**Note:** The distance will vary depending on the environment, building structure, and other factors. The range in an average office building is 500 to 900 feet (152.5 to 274.5 m). If, however, dense walls intervene, the distance could be less.

**Figure 24. Close Up and Edge of Usable Range Test**

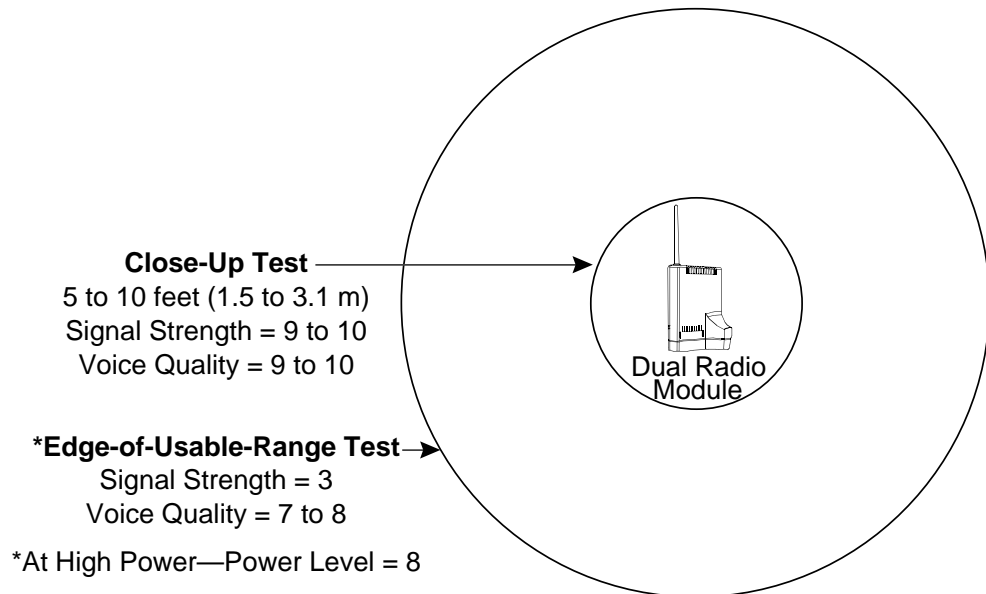



## Using Handset Features

### “Waking Up” the Phone

The MDW 9040 Pocket Phone has an energy-saving “sleep” or “standby” mode.

You can wake up the phone in any of the following ways:

- Press  on the handset.
- Press the Select-Row button .

**Note:** You can also press  to activate the display to see whether you have a message or to check if your alerter is enabled without actually turning the phone on (if the communications system is very busy, for instance).

- Press either of the volume control buttons (“▲” or “▼”).
- Press .

When you “wake up” the phone, the handset display is activated and shows line and handset status.

### Placing a Call

To place a call using your MDW 9040, use the following procedure:

- 1 Press  on the handset (or the headset **On/Off** button if you have the headset attached) to turn the phone on.

The MDW 9040 Pocket Phone seizes an available line and a triangle or a rectangle (depending on your communications system) appears beside that line in the handset display.

You hear a dial tone.

- 2 Dial the call as you would on a wired system phone.
- 3 To end the call, press .

**Note:** Unless there is other activity on the phone, the handset goes into the energy-saving “sleep” mode.

### Answering a Call

When you receive a call on your MDW 9040 Pocket Phone, you hear a ringing tone if your alerter is enabled, or you feel a vibration in the handset if the vibrator is enabled, or both. To answer the call, use the following procedure:

- 1 Press  on the handset (or the headset **On/Off** button if you have the headset attached) to turn the phone on.

You are automatically connected to the ringing line.

- 2 Speak into the handset to converse with your caller.
- 3 To end the call, press .

## Manually Selecting a Line or Programmed Button

When you are placing or answering a call, the MDW 9040 automatically selects the line for you. In some situations, however, you may want to select a particular line (for example, to use an “800” line).

To select a particular line or programmable/intercom/drop button, use the following procedure:

- 1 Press .

The  icon displays steadily, and you are connected to an available line.

- 2 If the Selection arrow does not appear to the right of the row that includes the line or button you want to use, press the Select-Row () button one or more times until the arrow is to the right of that row. (See “The Select-Row Button and the Column Buttons” earlier in this chapter for more information.)

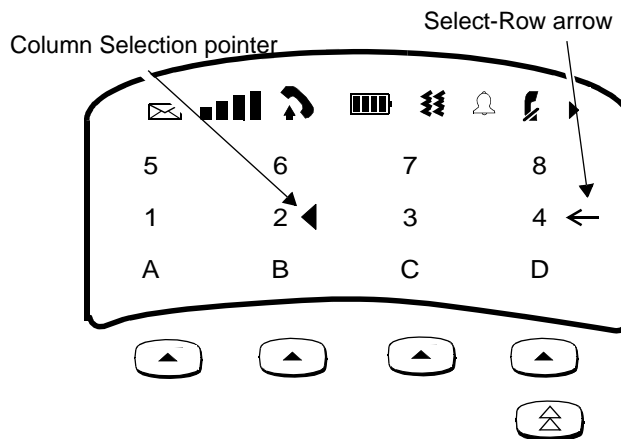

- 3 Press the Softkey () button below the line or button triangle that you want to select.

You are connected to the line or you have access to the button you chose.



- 4 To deselect the line or button, press .

For information about assigning features to buttons, see Chapter 6, “MDW 9040 Pocket Phone Compatibility.”

## Preselecting a Line

You may sometimes want to select a line other than the line to which the communications system automatically connects you. To preselect a line, you must first enable Line Preselection. See “Turning on the Line Pre-Select Option” earlier in this chapter.

Once Line Pre-Select is enabled, use the following procedure:

- 1 If the handset is “asleep,” press  to wake it up and activate the display.
- 2 If the Selection arrow does not appear to the right of the row that includes the line or button you want to use, press the Select-Row () button one or more times until the arrow is to the right of that row. (See “The Select-Row Button and the Column Buttons” earlier in this chapter for more information.)
- 3 Press the Column () button that corresponds to the line that you want to select.

The  icon flashes in the display and the handset emits double beeps.

- 4 Press .

The  icon displays steadily, and you are connected to the line you chose.

## Using a Headset

Avaya offers Mobility headsets, which are specifically designed for use with your MDW 9040 Pocket Phone. A headset assists in call answering and provides hands-free operation.

For ordering information, see Appendix D, “Ordering Replacement and Optional Parts.”

### CAUTION:

Plug ONLY the Mobility-type headset cord into the headset adapter.

**Figure 25. Connecting a Headset to Your MDW 9040**

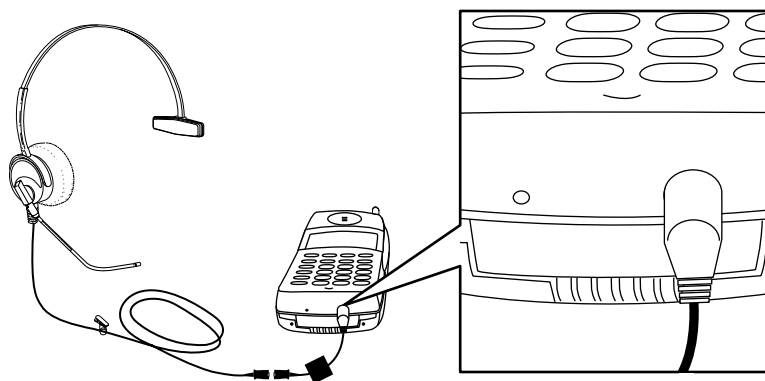

**Note:** Calls cannot be heard on the handset receiver when the headset is plugged in to the headset adapter. The handset microphone is also deactivated. The range of the handset is slightly diminished when you are using a headset. You may need to move closer to the radio module or move the radio module closer to you.

If desired, you can disconnect the headset from the handset without dropping the call, either by unplugging the headset adapter from the handset or by releasing the Quick Disconnect plug from the headset adapter cord. You can then use the handset as you normally would.

**Using the Headset On/Off Button**

The headset On/Off button on the headset adapter cord becomes active **only** when the headset is plugged into the headset connector. The headset On/Off button is identical in function to the  button near the dial pad.

**Answering Calls with a Headset**

When you receive a call, you will hear a ringing tone or feel a vibration coming from the handset (you will not hear a tone from the headset itself).

To answer a call:

- 1 Press either the headset On/Off button on the headset adapter cord or the  button near the dial pad.

**Placing Calls with a Headset**

To place a call with a headset:

- 1 Press the On/Off button on the headset adapter cord or the  button near the dial pad to access an available line.

The microphone and earpiece in the handset are disabled.

- 2 Dial the call as you would on a wired system phone.
- 3 Press either the On/Off button on the headset adapter cord or the  button near the dial pad to end the call.

## Programming Switch-Related Features

See “Programming Features for PARTNER, MERLIN, MERLIN LEGEND and MERLIN MAGIX Systems” on page 74 of Chapter 6.

## The Handset Antenna

The MDW 9040 Pocket Phone comes with a user-replaceable, flexible, retractable antenna. For maximum range and voice quality, always fully extend the antenna before placing or answering a call. You can receive a call (if you are within range of the radio module) without extending the antenna, but the Range  icon may light indicating that you are out-of-range or there is poor signal strength. The antenna must be fully extended for optimal performance.

**Replacing the Antenna** If the antenna on your MDW 9040 Pocket Phone handset becomes damaged, you can order a replacement antenna (see Appendix D, “Ordering Replacement and Optional Parts”), and replace it yourself.

To replace the antenna:

- 1 Fully retract the antenna.
- 2 Grasping the base of the antenna, unscrew it by turning it counterclockwise.
- 3 Grasping the base of the new antenna, screw it into the handset in a clockwise direction.

## Carrying Your Pocket Phone

The MDW 9040 Pocket Phone has a loop in the upper corner to accommodate the included lanyard. You can attach the lanyard, as illustrated below, and slip the lanyard over your wrist to guard against dropping the phone. A leather carrying case is also available separately; see Appendix D, "Ordering Replacement and Optional Parts."

**Figure 26. Attaching the Lanyard Loop to the Handset**

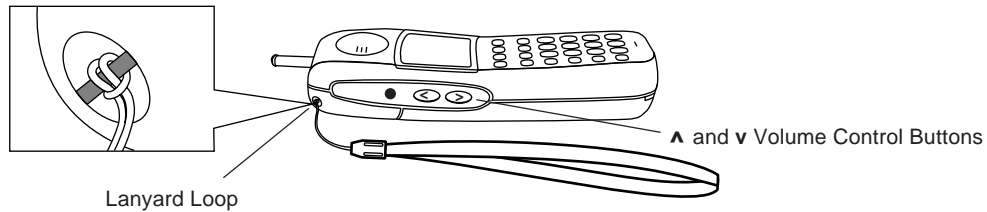

Each battery pack (standard or extended) also comes with its own detachable clip that you can attach to the back of the battery pack, enabling you to attach the phone to your belt or purse strap. Be sure to use the clip that matches the battery pack; they are not interchangeable.

**Fastening the Belt Clip** To fasten the belt clip to the handset (or battery pack), refer to the following figure and set of instructions.

**Figure 27. Fastening the Belt Clip**

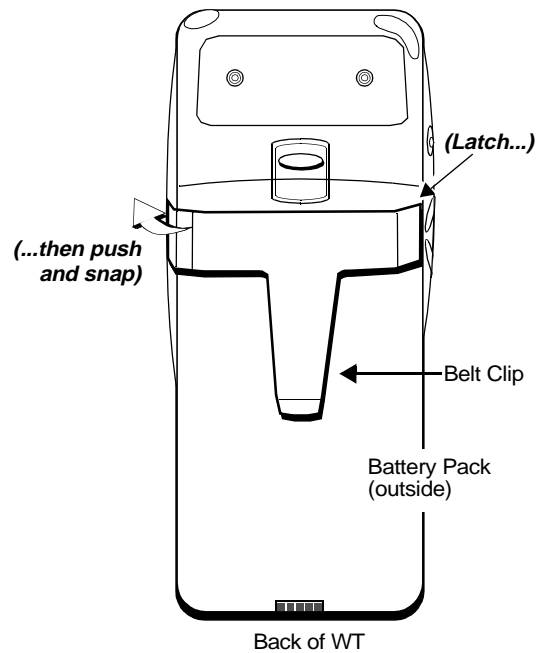

- 1 Hold the handset (or battery pack) so that the back of the handset (or battery pack) is facing you.
- 2 Hold the belt clip so that it looks like the letter “T.”
- 3 Latch the right edge of the belt clip into the corresponding groove on the inner side of the battery pack. (The groove is about 1/4 inch from the top of the battery pack.)
- 4 Push the left edge of the belt clip and snap it into the corresponding groove on the inner side of the battery pack.

**Removing the Belt Clip** To remove the belt clip from the battery pack, refer to the following figure and set of instructions.

**Figure 28. Removing the Belt Clip**

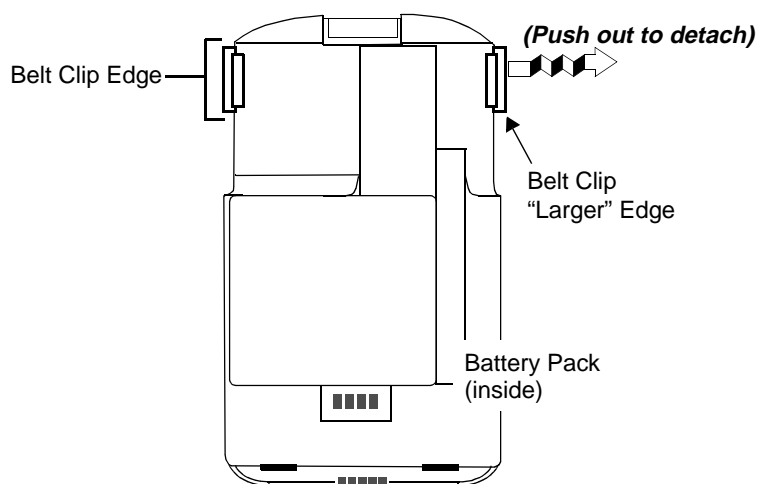

- 1 Remove the battery pack from the handset.
- 2 Hold the battery pack so that the inside of the pack is facing you.
- 3 Find the “larger” edge of the belt clip that is fastened to the battery pack.
- 4 Push the “larger” edge of the belt clip out and away from the battery pack until you free the clip from the pack.



# 6 MDW 9040 Pocket Phone Compatibility

## Programming and Call Handling Instructions

The MDW 9040 Pocket Phone handset can display the status of up to 12 telephone lines, but the number of lines supported by the associated switches varies. After you have installed your MDW 9040 and understand the controls and displays, use the programming and call-handling instructions that came with your communications system. Follow the user instructions for the phone type identified in the table below:

For this release...	Of this communications system...	used with this Dual Radio Module Type	Use the instructions for a...
R1, R2, R3, R4, R4.1	PARTNER	3204-DRE	18D phone (Apparatus code 7311H)
R1, R2, R3, R4, R4.1	PARTNER II		
R1, R2, R3, R4, R4.1	PARTNER Plus		
R1, R1.1, R2, R3.1	PARTNER Advanced Communications System		
FP 2	MERLIN (206, 410)	3204-DRE	BIS-22D phone (Apparatus code 7315H)  <b>Note:</b> The MDW 9040 display and mail capabilities will function only if your system supports:  <b>1</b> Analog/Hybrid display sets.  <b>2</b> Hybrid pack connections with necessary tone generation for AUDIX/VOICE MAIL interaction.  Consult your System Administration manuals for this compatibility.  If your system does not support the items above, consult the System Administration manual for the BIS-10 phone (Apparatus Code 7303S).
FP 2	MERLIN (820)		
FM 1, 2, 3, 4, & 5	MERLIN (1030, 3070)		
FM 1, 2, R3	MERLIN II		
R1, R2	MERLIN Plus		
R1, R1.1, R2, R2.1, R3, R4, R5, R6	MERLIN LEGEND		
R7	MERLIN LEGEND		
			18D phone (Apparatus code 7311H) with an ETR card

1 of 2

For this release...	Of this communications system...	used with this Dual Radio Module Type	Use the instructions for a...
All versions that support PARTNER Circuit Packs	MERLIN MAGIX	3204-DRE	18D phone (Apparatus code 7311H)
R1.5, R2	MERLIN MAGIX	3204-DRD	12- or 24-button 4400 Series phone (Apparatus code 7317H)
All versions that support 2-wire DCP	DEFINITY	3204-DRD	8410D
	DEFINITY PRO LOGIC	3204-DRD	8410D

**Legend:** R = Release, FP = Feature Package, FM = Feature Module, G = Generic

2 of 2

**Note:** The MDW 9040 Pocket Phone is fully compatible with the PARTNER family of communications systems. For the remaining communications systems, however, you must carefully note the functional differences between your wireless phone and the phone type identified in the previous table. Differences are summarized on the following pages.

Some systems do not support display features. In these cases, the display is not available; the MDW 9040 Pocket Phone works as a nondisplay set.

## Programming Features for PARTNER, MERLIN, MERLIN LEGEND and MERLIN MAGIX Systems

On all PARTNER, MERLIN, MERLIN LEGEND and MERLIN MAGIX systems, you can assign a feature to an available button (a button that does not have a line or another feature assigned to it):

- 1 To enter programming mode, turn on the handset, then press **(Feat/P)** followed by "0 0."
- 2 Press the Select-Row (**(⏏)**) button to move the arrow to the row of line indicators containing the available button.
- 3 Press the Column (**(⏏)**) button under the button that you want.
- 4 Program the feature (using the procedure described in the manual for your PARTNER, MERLIN, MERLIN LEGEND, or MERLIN MAGIX communications systems).

**Note:** Some features provide a visual indication in the handset display that the feature is turned on. Be aware that if you turn off the handset while using one of these features, you may forget that the feature is on. To verify the status of a such a feature, you can simply press the **(⏏)** button to "wake up" the phone and activate the display.

- 5 To exit programming mode, press **(Feat/P)** followed by 00 or turn off the handset. For MERLIN LEGEND and MERLIN MAGIX, press **(Feat/P)** followed by \*00 or turn off the handset.

**Note:** The above instructions do not apply to DEFINITY systems, because in those systems, features are assigned by the System Administrator.

## Communications System Compatibility

This section describes some communications system-dependent programming to help you optimize the performance of your MDW 9040 Pocket Phone. It also describes how the buttons on a wired phone for your communications system map to the buttons on your MDW 9040. After accessing button mapping as described below, turn to the information appropriate to your communications system:

- PARTNER
- MERLIN
- MERLIN LEGEND
- MERLIN MAGIX
- DEFINITY

### Accessing Button Mapping

Button mapping options are accessed through the Configuration Menu.

To access button mapping from the Configuration Menu:

- 1 Press **Menu** to enter Menu Mode.

The initial Menu screen displays.

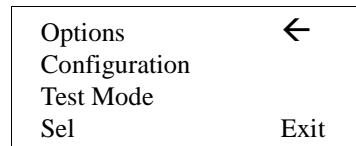

- 2 Press the Select-Row (**△**) button to move the arrow to **Configuration**.

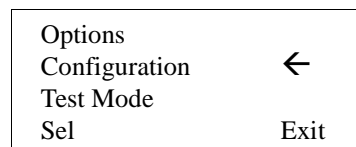

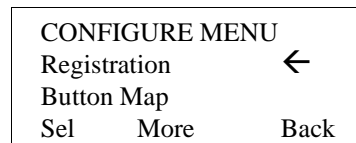

- 3 Press the Softkey (**▲**) below **Sel**.

The initial Configure Menu screen displays.

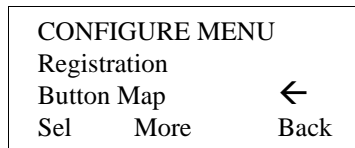

- 4 Press the Select-Row () button to move the arrow to **Button Map**.



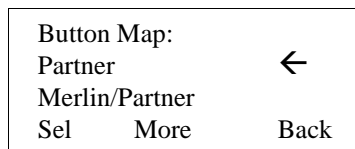

- 5 Press the Softkey () below **Sel**.

The initial Button Map screen displays.





**Note:** For MERLIN LEGEND R7, use the **Merlin/Partner** button map.

- 6 Press the Select-Row () button to move the arrow to the appropriate communications system and press the Softkey () below **Sel**, or press the Softkey () below **More**.

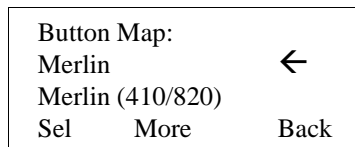
Additional button map options display.



**Note:** For MERLIN LEGEND releases before R7, use the **Merlin** button map.

- 7 Press the Select-Row () button to move the arrow to the appropriate communications system on this Button Map screen and press the Softkey () below **Sel**, or press the Softkey () below **More**.

Additional button map options display.

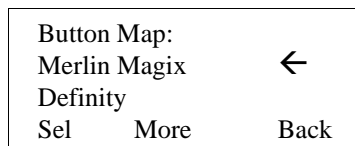

- 8 For **Merlin Magix**, or **Definity**, the radio module will automatically choose the correct button map.

## PARTNER Systems

### Button mapping for PARTNER systems

On PARTNER systems, the MDW 9040 emulates the PARTNER 18D telephones. The following diagram illustrates the button assignments on an 18D phone and the corresponding assignments on the MDW 9040 Pocket Phone.

**Note:** When the handset is set for one line of display, you will not be able to see the second page of display data (time and timer).

**Figure 29. Button mapping for an MDW 9040 Pocket Phone connected to the PARTNER system**

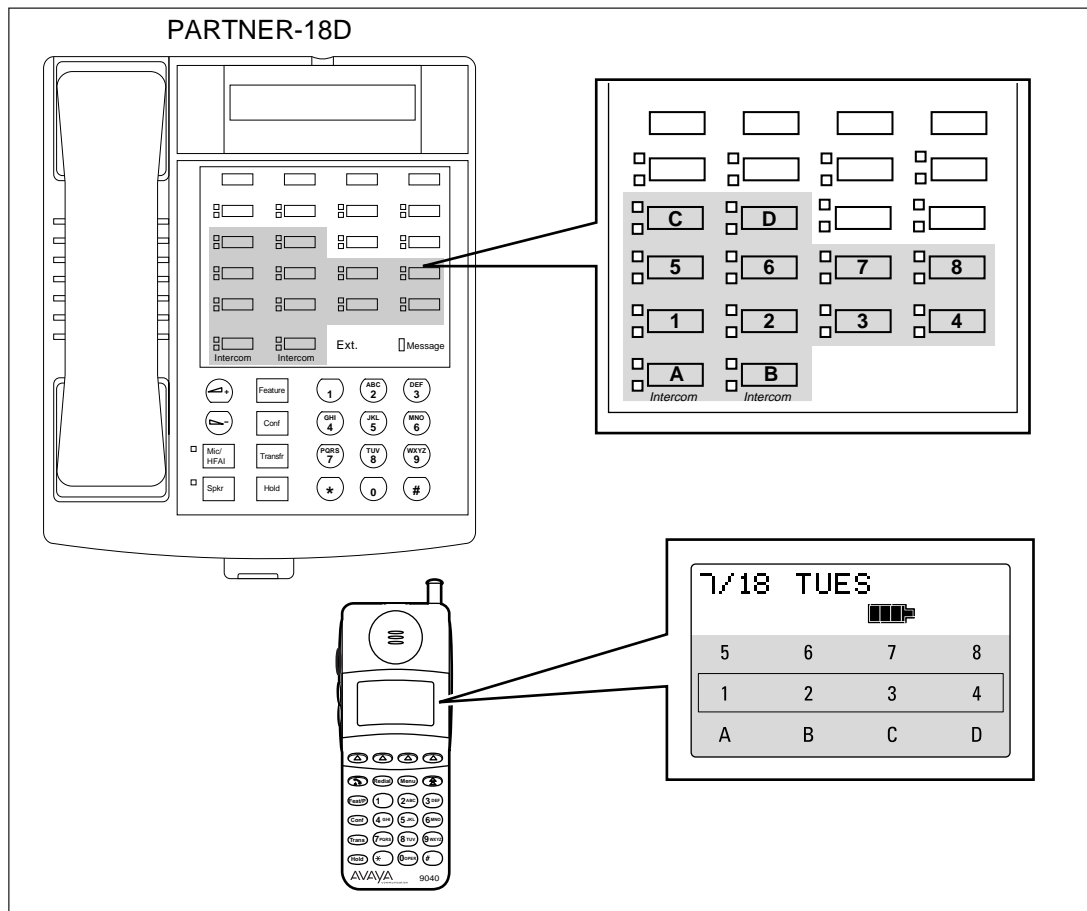

The MDW 9040 does not have a speaker; therefore, it does not support voice announce/page calls.

**Setting the Line Ringing options for PARTNER systems**



Use the following guidelines to ensure optimal voice quality when using MDW 9040 Pocket Phones with a PARTNER, PARTNER Plus, PARTNER II, or PARTNER Advanced Communications System in key mode.

**Note:** For PARTNER II and PARTNER ACS hybrid systems that use pooled lines, set the Line Ringing options as described in the following table if more than six MDW 9040 Pocket Phone handsets have the same pooled line appearance.

Telephone Communications System	TransTalk 9000 System with 7 – 12 Handsets	TransTalk 9000 System with 13 – 18 Handsets
PARTNER	<ol style="list-style-type: none"> <li>1 Set Line Ringing for the first six handsets to <b>Ring</b>.</li> <li>2 Set Line Ringing for each additional handset to <b>No Ring</b>. (Install an external audible alert for these extensions.)</li> </ol>	Not applicable; PARTNER supports up to 12 phones.
PARTNER Plus PARTNER II PARTNER Advanced Communications System PARTNER Endeavor	<ol style="list-style-type: none"> <li>1 Set Line Ringing for the first six handsets to <b>Ring</b>.</li> <li>2 Set Line Ringing for each additional handset to <b>Delayed Ring</b>.</li> </ol>	<ol style="list-style-type: none"> <li>1 Set Line Ringing for the first six handsets to <b>Ring</b>.</li> <li>2 Set Line Ringing for handsets 7 – 12 to <b>Delayed Ring</b>.</li> <li>3 Set Line Ringing for each handset beyond the first 12 (handsets 13 – 18) to <b>No Ring</b>. (Install an external audible alert for these extensions.)</li> </ol>

The MDW 9040 Pocket Phone does not have a speaker; therefore, it does not support voice announce/page calls.

## MERLIN Systems

- On MERLIN II and MERLIN LEGEND systems, you must connect your wireless phone to an available jack on either a 408 outside line/analog telephone module or a 008 analog telephone module.
- Since the MDW 9040 Pocket Phone does not have a speaker function, the Voice Announce feature must be disabled. It is recommended that you use MERLIN 206/410/820 systems installed with Feature Package 2 with your wireless phone, so that you can disable that feature.
- Since the MDW 9040 has no speaker function, it should not be assigned to a paging group.
- To program the Ringing Option feature, use the “triangle” and “rectangle” indicators in the display as the equivalent of red and green LEDs, respectively.
- For MERLIN II system users, if you program an Auto Intercom button, idle line preference must be set to intercom.
- If any of your incoming lines has the Call Waiting feature, use the Recall feature (letter “C” in the display) and press it before you pick up a waiting call. You can dial “# 5 0” before you pick up a waiting call on the following: MERLIN 206/410/820 systems only with Feature Package 2, and all MERLIN Plus, MERLIN II, and MERLIN 1030/3070 systems. Pressing the  button disconnects the call.
- The  button on the MDW 9040 allows you only to enter programming mode. It does not work when using MERLIN LEGEND or MERLIN MAGIX system features. To use MERLIN LEGEND or MERLIN MAGIX system feature codes with this phone, program any available button as a System Feature button. This enables you to use the wide array of MERLIN LEGEND or MERLIN MAGIX system features by turning the handset on, pressing the System Feature button, and dialing the appropriate “\*” code number.

**Note:** MERLIN LEGEND does not support Caller ID and some other Display features to Analog/Hybrid terminals, such as the MDW 9040.

**Button mapping for MERLIN systems except MERLIN 410 and MERLIN 820**

On MERLIN systems, the MDW 9040 emulates a Model BIS-22D phone (Apparatus Code 7315H). The BIS-22D button assignments, however, differ depending on the MERLIN system used. The following diagram illustrates the BIS-22D button assignments and the corresponding assignments on the MDW 9040 for MERLIN systems *except MERLIN 410, MERLIN 820, MERLIN LEGEND R7 and MERLIN MAGIX*. (See the following sections for button mapping for MERLIN 410, MERLIN 820, MERLIN LEGEND R7 and MERLIN MAGIX systems.)

**Figure 30. Button mapping for an MDW 9040 Pocket Phone connected to MERLIN systems EXCEPT the MERLIN 410 and the MERLIN 820 systems and MERLIN LEGEND R7 and MERLIN MAGIX**

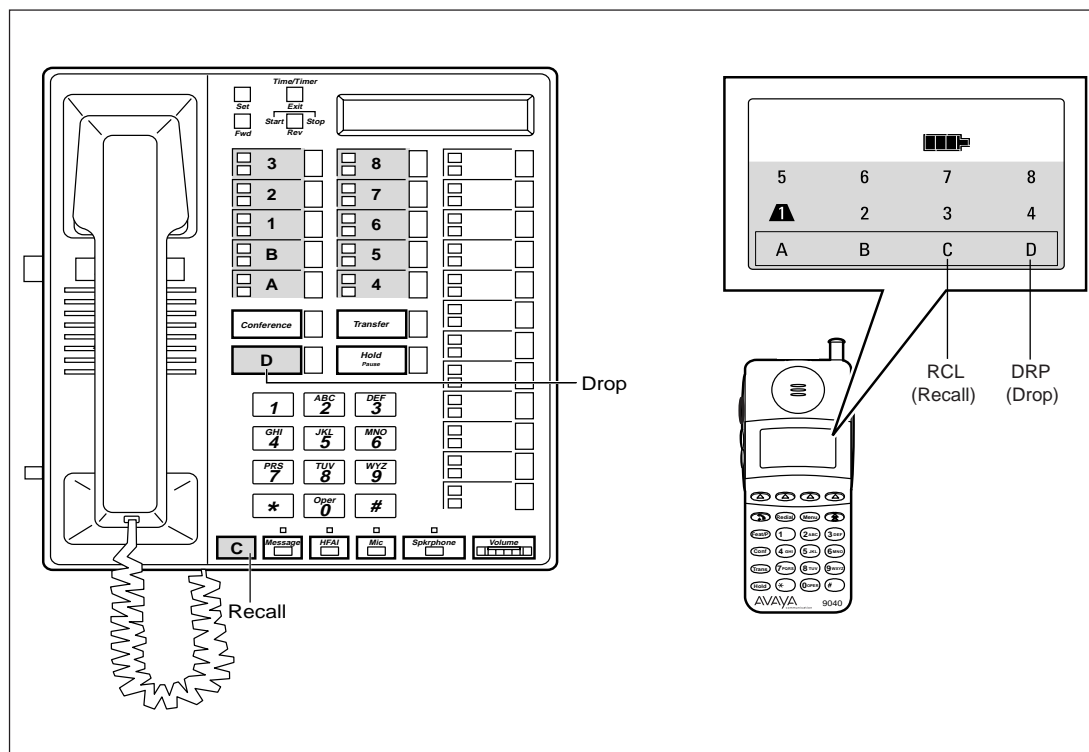

**Note:** The button labeled C and the button labeled D on the MDW 9040 Pocket Phone display automatically default to the buttons labeled C (Recall) and D (Drop), respectively, on the 7315H phones.

The MDW 9040 Pocket Phone does not have a speaker; therefore, it does not support voice announce/page calls.



**Button mapping for MERLIN 410 and MERLIN 820 systems**

The following diagram illustrates the button assignments on a BIS-22D phone used for *MERLIN 410 and 820 systems* and the corresponding assignments on the MDW 9040 Pocket Phone. (See the previous section for button mapping for other MERLIN systems. See the following sections for button mapping for MERLIN LEGEND and MERLIN MAGIX systems.)

**Figure 31. Button mapping for an MDW 9040 Pocket Phone connected to a MERLIN 410 or a MERLIN 820 system**

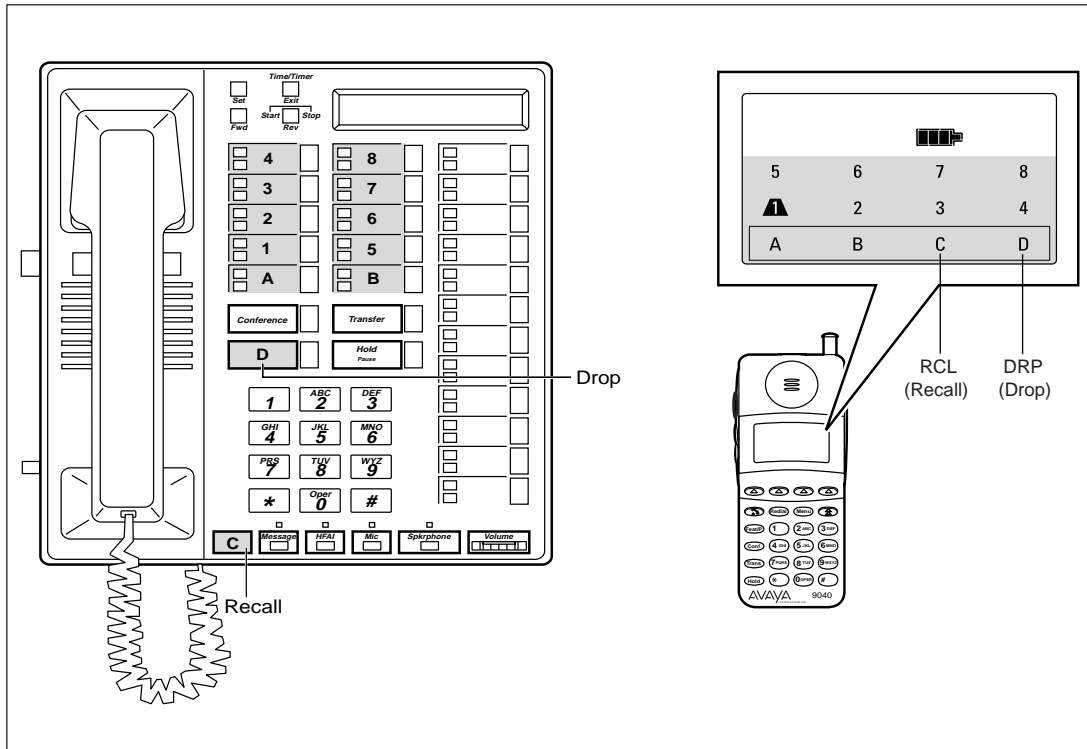

**Note:** The button labeled C and the button labeled D on the MDW 9040 Pocket Phone display automatically default to the buttons labeled C (Recall) and D (Drop), respectively, on the 7315H phones.

The MDW 9040 Pocket Phone does not have a speaker; therefore, it does not support voice announce/page calls.

### Button mapping for MERLIN LEGEND R7 systems

On the MERLIN LEGEND R7 system, the MDW 9040 emulates a PARTNER 18D telephone. The following diagram illustrates the button assignments on an 18D phone and the corresponding assignments on the MDW 9040 Pocket Phone.

**Note:** When the handset is set for one line of display, you will not be able to see the second page of display data (time and timer).

**Figure 32. Button mapping for an MDW 9040 Connected to the MERLIN LEGEND R7/ETR system**

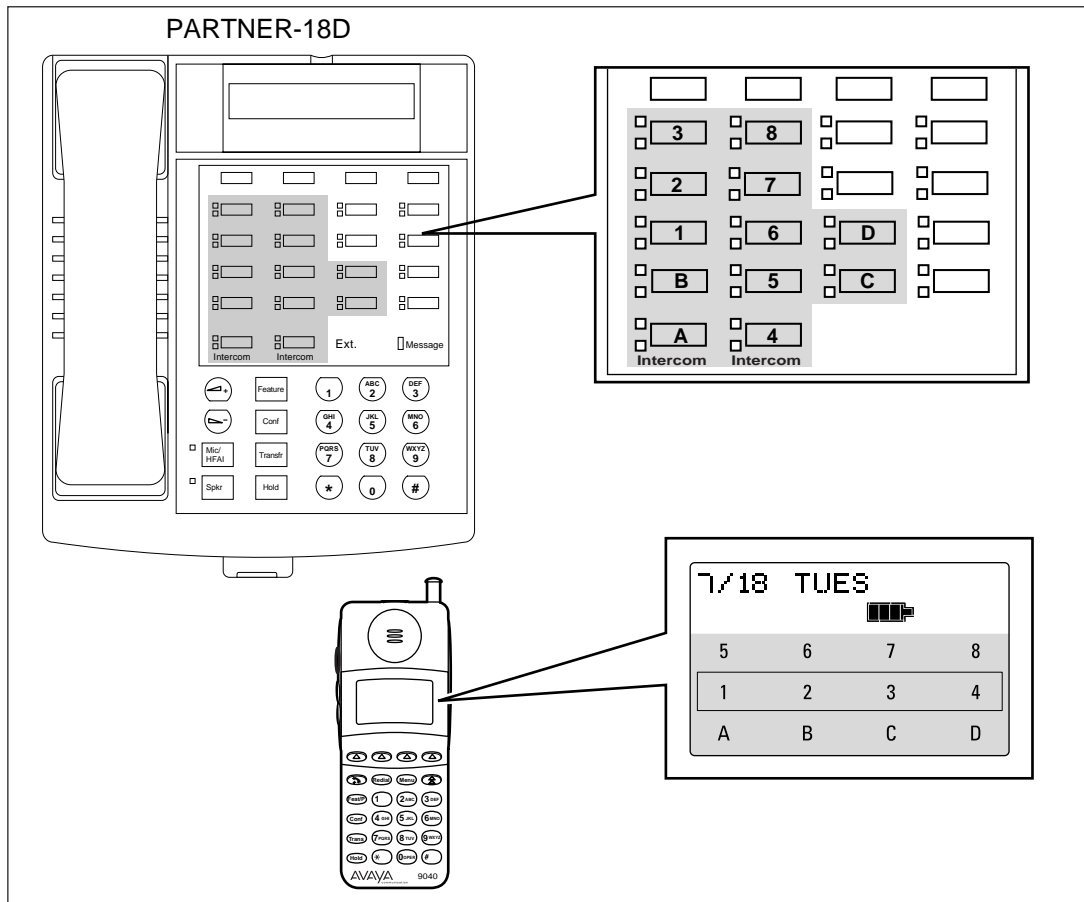

**Note:** Buttons C and D are blank programmable.

The MDW 9040 does not have a speaker; therefore, it does not support voice announce/page calls.

**Setting the Line Ringing options for MERLIN systems**

Use the following guidelines to ensure optimal voice quality when using MDW 9040 Pocket Phones with MERLIN, MERLIN Plus, and MERLIN II.

Telephone Communications System	TransTalk 9000 System with 7 – 12 Handsets	TransTalk 9000 System with 13 – 18 Handsets
MERLIN MERLIN II MERLIN Plus	<ol style="list-style-type: none"> <li><b>1</b> Set Line Ringing for the first six handsets to <b>Ring</b>.</li> <li><b>2</b> Set Line Ringing for each additional handset to <b>Delayed Ring</b>.</li> </ol>	<ol style="list-style-type: none"> <li><b>1</b> Set Line Ringing for the first six handsets to <b>Ring</b>.</li> <li><b>2</b> Set Line Ringing for handsets 7 – 12 to <b>Delayed Ring</b>.</li> <li><b>3</b> Set Line Ringing for each handset beyond the first 12 (handsets 13 – 18) to <b>No Ring</b>. (Install an external audible alert for these extensions.)</li> </ol>

**Note:** For MERLIN LEGEND systems that use pooled lines, set the Line Ringing options as described in the above table, if more than six MDW 9040 Pocket Phone handsets have the same pooled line appearance. The above Line Ringing options are not necessary for MERLIN LEGEND systems that use the TransTalk MDW 9040 Pocket Phones as PBX extensions.

## MERLIN MAGIX System

### Button mapping for MERLIN MAGIX systems

On the MERLIN MAGIX system, the MDW 9040 emulates either a 12- or a 24-button 4400 Series telephone.

**Note:** When configuring for a 12-button arrangement, only one line of information appears in the display. A scroll button allows you to switch back and forth between viewing the first and second lines of the switch message.

The figure below illustrates the button assignments on a 24-button 4400 Series set and the corresponding assignments on the MDW 9040 Pocket Phone.

**Figure 33. Button mapping for an MDW 9040 Pocket Phone connected to a MERLIN MAGIX/TDL system**

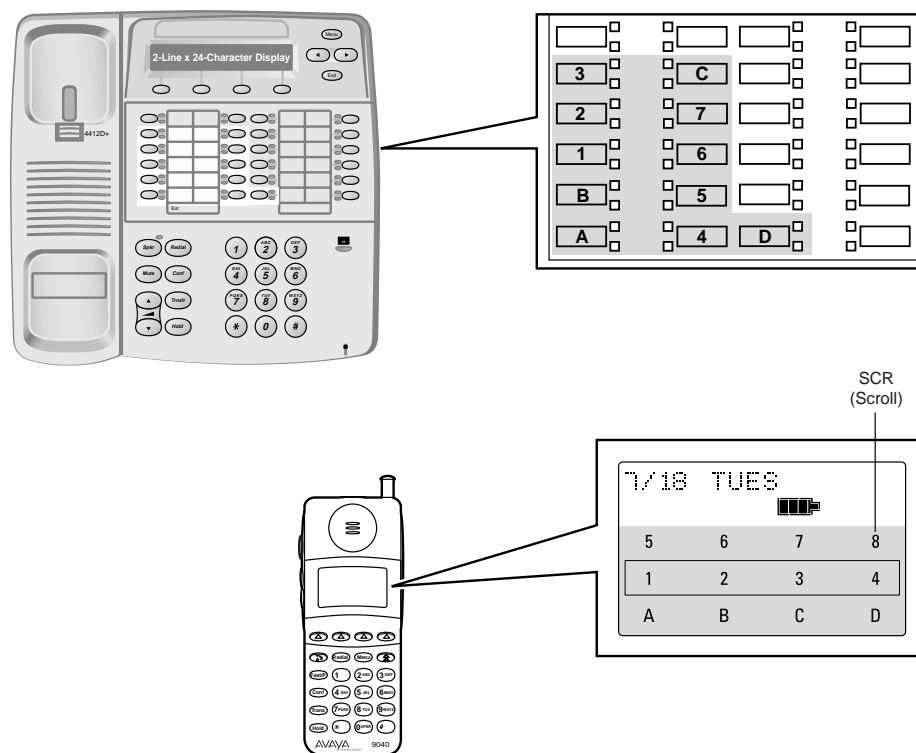

**Note:** When programmed for single line display, button “SCR” on the 9040 is the Scroll button and is non-programmable. When viewed from Centralized Programming, button “SCR” shows blank.

The MDW 9040 does not have a speaker; therefore, it does not support voice announce/page calls.

**Note:** When the handset is set for one line of display, you will not be able to see the second page of display data (time and timer).

Figure 34. Button mapping for an MDW 9040 Pocket Phone connected to a MERLIN MAGIX/ETR system

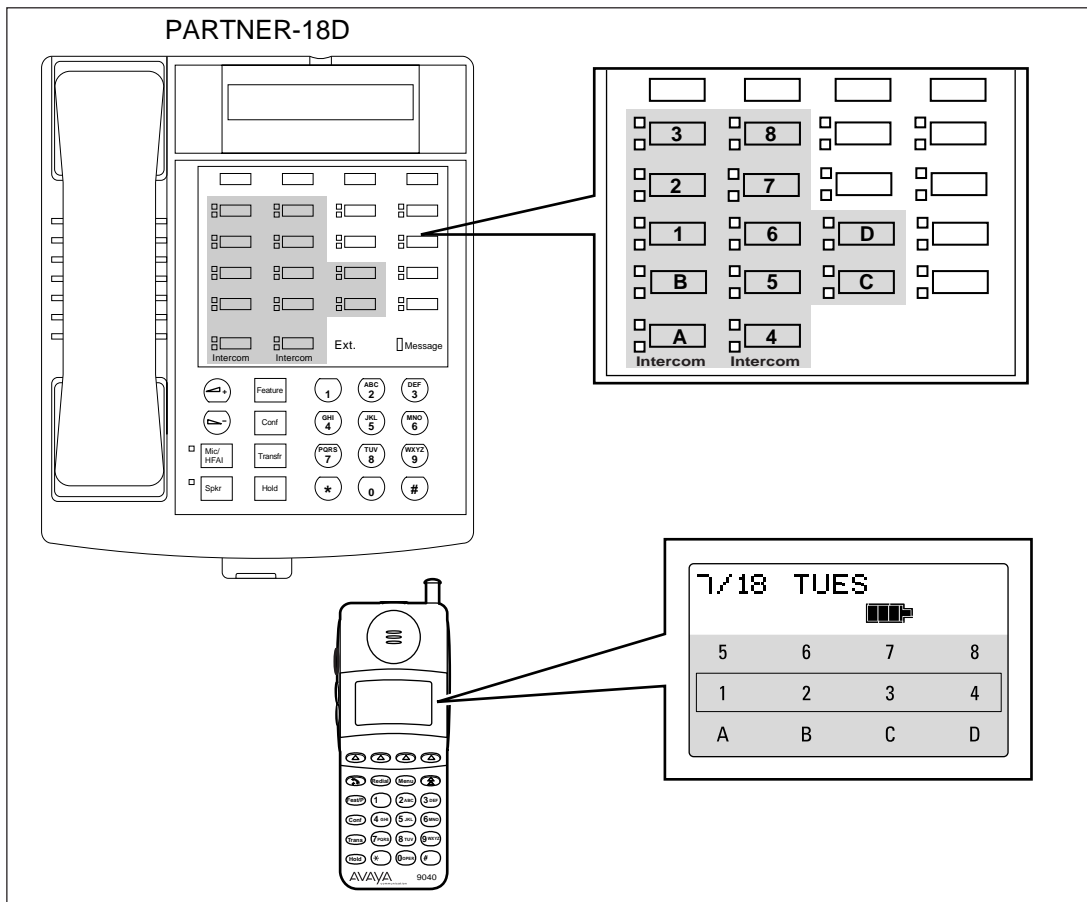

The MDW 9040 Pocket Phone does not have a speaker; therefore, it does not support voice announce/page calls.

**Setting the Line Ringing options for the MERLIN MAGIX system**

Use the following guidelines to ensure optimal voice quality when using MDW 9040 Pocket Phones with a MERLIN MAGIX switch.

Telephone Communications System	TransTalk 9000 System with More Than 6 Handsets
MERLIN MAGIX system	<ol style="list-style-type: none"> <li>1 When TransTalk 9040 handsets are configured as individual PBX extensions, no Line Ringing options are necessary.</li> <li>2 When MDW 9040 handsets are configured in Key Mode extensions (multiple 9040 handsets as members of coverage answer groups), where all incoming calls ring all handsets at the same time, refer to section "Setting the Line Ringing options for MERLIN systems" earlier in this chapter.</li> </ol>

**DEFINITY Systems**

This phone must be administered as an 8410D. Consult your DEFINITY switch administration documentation for the 8410D to program features on the MDW 9040 Pocket Phone.

**Note:** The MDW 9040 Pocket Phone works with the following circuit packs:

- TN2181 (16 port, 2-wire)
- TN2224 (24 port, 2-wire)

**Button mapping for DEFINITY systems**

On DEFINITY systems, the MDW 9040 should be aliased as an 8410D phone. The following diagram illustrates the 8410D button assignment, and the corresponding assignments on the MDW 9040 for DEFINITY systems.

Figure 35. Button mapping for an MDW 9040 Pocket Phone connected to a DEFINITY system

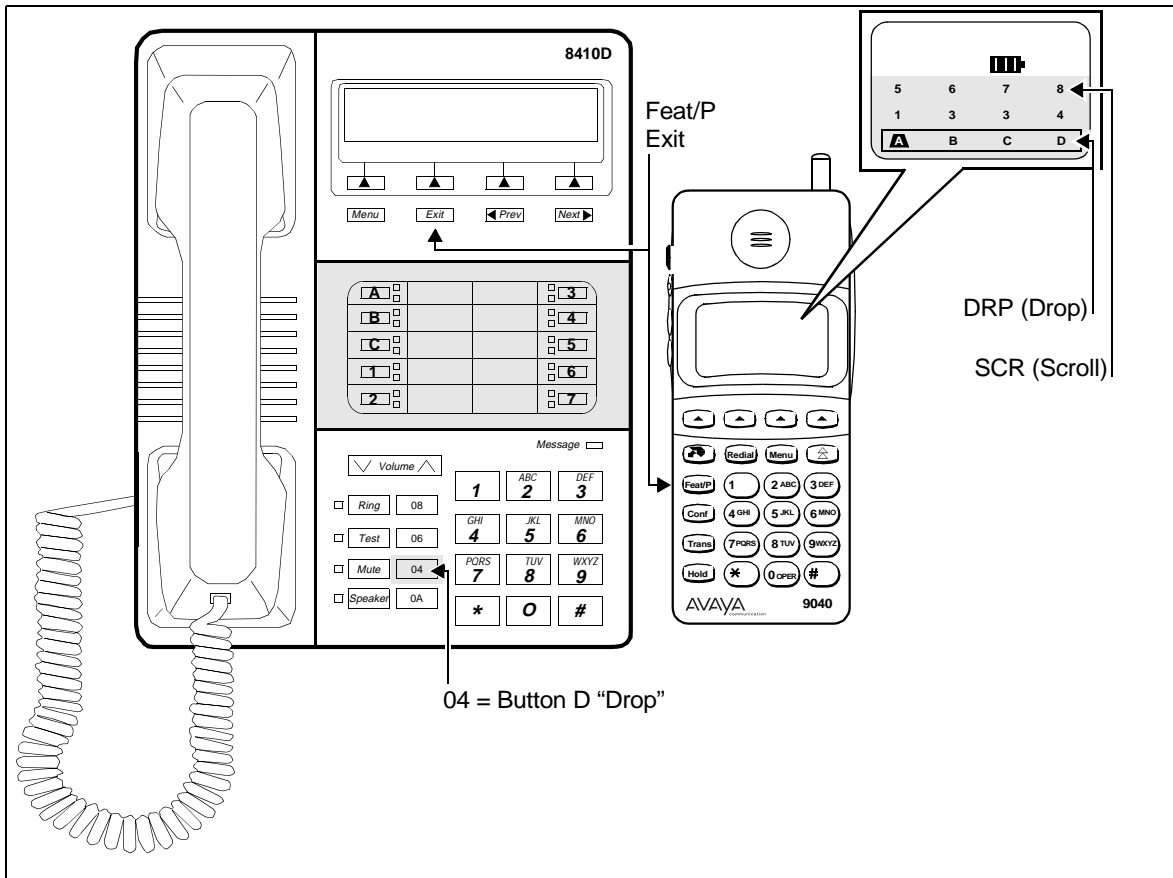

**Note:** When programmed for single line display, button “SCR” on the 9040 is the Scroll button and is non-programmable. When viewed from Centralized Programming, button “SCR” shows blank.

**Setting the Line Ringing options for DEFINITY systems**

Use the following guidelines to ensure optimal voice quality when using MDW 9040 Pocket Phones with DEFINITY systems.

Telephone Communications System	TransTalk 9000 System with More Than 6 Handsets
DEFINITY system	<ol style="list-style-type: none"> <li><b>1</b> When the MDW 9040 handsets are configured as individual PBX extensions, no Line Ringing options are necessary.</li> <li><b>2</b> When the MDW 9040 handsets are configured in pooled PBX or group PBX extensions (multiple 9040 handsets as members of coverage answer groups), where all incoming calls ring all handsets at the same time, refer to section “Setting the Line Ringing options for PARTNER systems” earlier in this chapter.</li> </ol>

**Note:** For DEFINITY systems that use pooled lines, set the Line Ringing options as described in the previous table if more than six MDW 9040 Pocket Phone handsets have the same pooled line appearance.

The 8410D phones are programmed for DEFINITY systems using four STATION Administration screens. Enter **8410D** in the Type field on the first screen to bring up the following two screens.

```

add station next                               Page 1 of 4   SPE B
                                               STATION
Extension: 30016                               Lock Messages? n      BCC: 0
Type: 8410D                                   Security Code:        TN: 1
Port:                                          Coverage Path 1:     COR: 1
Name:                                          Coverage Path 2:     COS: 1
                                               Hunt-to Station:

STATION OPTIONS
  Data Module? n                               Personalized Ringing Pattern: 1
  Speakerphone: 2-way                          Message Lamp Ext: 30016
  Display Language: english                    Mute Button Enabled? y

                                               MM Complex Data Ext:

```



```

add station next                                     Page 2 of 4 SPE B
                                                    STATION
FEATURE OPTIONS
  LWC Reception: spe                               Auto Select Any Idle Appearance? n
  LWC Activation? y                               Coverage Msg Retrieval? y
  CDR Privacy? n                                  Auto Answer: none
  Redirect Notification? y                         Data Restriction? n
  Per Button Ring Control? n                       Idle Appearance Preference? n
  Bridged Call Alerting? n                         Restrict Last Appearance? y
  Active Station Ringing: single
  H.320 Conversion? n
  Per Station CPN - Send Calling Number?
  Multimedia Early Answer? n
  Audible Message Waiting? n
  Display Client Redirection? n
  Select Last Used Appearance? n
  AUDIX Name:
  Messaging Server Name:
    
```

The following illustrations show in parentheses the MDW 9040 Pocket Phone button assignments on Pages 3 and 4 of the STATION Administration screens. The button labeled **D** on the MDW 9040 Pocket Phone display automatically defaults to the button labeled **04** (Drop) on the 8410D phones. The **Drop** button disconnects the last call connected.

```

add station next                                     Page 3 of 4 SPE B
                                                    STATION
SITE DATA
  Room:                                           Headset? n
  Jack:                                           Speaker? n
  Cable:                                          Mounting: d
  Floor:                                         Cord Length: 0
  Building:                                       Set Color:

ABBREVIATED DIALING
  List1                                           List2                                           List3:

BUTTON ASSIGNMENTS
  1:(A) call - appr                               6: (3)
  2:(B) call - appr                               7: (4)
  3:(C) call - appr                               8: (5)
  4:(1)                                           9: (6)
  5:(2)                                           10: (7)
    
```

**Note:** Page 3 above is the recommended button programming. The Feat/P (**Feat/P**) button must be pressed once to exit the Program mode (for example, exiting Directory mode). Button “8” on the MDW 9040 Pocket Phone, when used with Line Pre-Select, allows for toggling between the two lines of Display information.

```
add station next                                     Page 4 of 4 SPE B
                                                    STATION
SOFTKEY BUTTON ASSIGNMENTS
1
2:
3:
4:
5:
7:
6:
8:
9:
10:
11:
12:
```

**Note: All Softkey button assignments should be initially removed when administering an MDW 9040 terminal. Button 8 is a firmware-programmed hard Scroll button on the MDW 9040 phone.**

# A Warranty and Repair Information

## Avaya Communication Limited Warranty and Limitation of Liability

Avaya warrants to you, the customer, that your wireless telephone system will be in good working order on the date Avaya or its Authorized Dealer delivers or installs the system, whichever is later ("Warranty Date"). If you notify Avaya or its Authorized Dealer within one year of the Warranty Date that your system is not in good working order, Avaya will, without charge to you, repair or replace, at its option, the system components that are not in good working order. Repair or replacement parts may be new or refurbished and will be provided on an exchange basis. If Avaya determines that your system cannot be repaired or replaced, Avaya will remove the system and, at your option, refund the purchase price of your system or apply the purchase price towards the purchase of another Avaya system.

If you purchased your system directly from Avaya, Avaya will perform warranty repair in accordance with the terms and conditions of the specific type of Avaya maintenance coverage you selected. A written explanation of Avaya types of maintenance coverage may be obtained from Avaya by calling 1-800-247-7000 (in the continental U.S. only). If you purchased your system from a Avaya Authorized Dealer, contact your dealer for the details of the maintenance plan applicable to your system.

This Avaya limited warranty covers damage to the system caused by power surges. Unless otherwise expressly agreed to in a written agreement signed by Avaya, Avaya will not be responsible under this limited warranty for damages resulting from:

- Failure to follow Avaya's installation, operation, or maintenance instructions;
- Unauthorized system modification, movement, or alteration;
- Unauthorized use of common carrier communication services accessed through the system;
- Abuse, misuse, or negligent acts or omissions of the customer and persons under the customer's control; or
- Acts of third parties and acts of God. AVAYA'S OBLIGATION TO REPAIR, REPLACE, OR REFUND, AS SET FORTH ABOVE, IS YOUR EXCLUSIVE REMEDY.

EXCEPT AS SPECIFICALLY SET FORTH ABOVE, AVAYA, ITS AFFILIATES, SUPPLIERS, AND DEALERS MAKE NO WARRANTIES, EXPRESS OR IMPLIED, AND SPECIFICALLY DISCLAIM ANY WARRANTIES OF MERCHANTABILITY OR FITNESS FOR A PARTICULAR PURPOSE.

## Limitation of Liability

*Except as provided below, the liability of Avaya and its affiliates and suppliers for any claims, losses, damages, or expenses from any cause whatsoever (including acts or omissions of third parties), regardless of the form of action, whether in contract, tort, or otherwise, shall not exceed the lesser of:*

*(1) the direct damages proven; or (2) the repair cost, replacement cost, license fee, annual rental charge, or purchase price, as the case may be, of the equipment that directly gives rise to the claim. Except as provided below, Avaya and its affiliates and suppliers shall not be liable for any incidental, special, reliance, consequential, or indirect loss or damage incurred in connection with the equipment. As used in this paragraph, consequential damages include, but are not limited to, the following: lost profits, lost revenues, and losses arising out of unauthorized use (or charges for such use) of common carrier telecommunications services or facilities accessed through or connected to the equipment. For personal injury caused by Avaya negligence, Avaya's liability shall be limited to proven damages to person. No action or proceeding against Avaya or its affiliates or suppliers may be commenced more than twenty four (24) months after the cause of action accrues. THIS PARAGRAPH SHALL SURVIVE FAILURE OF AN EXCLUSIVE REMEDY.*

## Repair Information

Outside the continental U.S., contact your Avaya Representative or local Authorized Dealer for warranty and repair information applicable to your system.

### In-Warranty Repairs

If you purchased or leased your system directly from Avaya, Avaya will repair it free of charge during the one-year warranty period. Simply call for customer support as instructed in the Copyright and Legal Notices at the beginning of this book.

Business-Day service is standard during the warranty period. Business-Day service is performed during normal business hours. (Around-the-Clock service is not available for phones.)

If you purchased or leased your system through an Avaya Authorized Dealer, contact your dealer for repairs.

### Post-Warranty Repairs

If you purchased the system from Avaya and you have a post-warranty service contract, Avaya service is provided under the terms of that contract.

To significantly reduce unexpected repair costs after the warranty period, you can purchase a post-warranty service contract from Avaya. A contract provides to you, within the applicable coverage period and response times, service calls with no charge for parts and labor on covered repairs. To order a post-warranty service contract, call 1-800-247-7000 (in the continental U.S. only).

If you leased your system from Avaya, Business-Day service is included in your lease.

If you purchased or leased your system through an Avaya Authorized Dealer, contact your dealer for repairs.

# B Regulatory Information

This appendix contains information about the Federal Communications Commission and Industry Canada.

## FCC Part 15 Rules

The Avaya Communication MDW 9040 Wireless Pocket Phone has been tested and has been found to comply with *FCC Part 15 Rules*. These specifications are designed to provide reasonable protection against harmful interference in a commercial or residential installation. This wireless telephone generates, uses, and can radiate radio frequency energy and, if not installed and used in accordance with the instructions, may cause harmful interference to radio communications. However, there is no guarantee that interference will not occur in a particular installation. If the telephone does cause harmful interference to radio or television reception, which can be determined by turning the telephone off and on, the user is encouraged to try to correct the interference by one or more of the following measures:

- Where it can be done safely, reorient the receiving television or radio antenna.
- To the extent possible, relocate the television, radio, or other receiver with respect to the telephone.
- Plug the telephone into an electrical outlet that is not on the same circuit as one used by the radio or television.

## IC RSS-210 Compliance

This device complies with RSS-210 of Industry Canada. Operation is subject to the following two conditions:

- This device may not cause interference.
- This device must accept any interference including interference that may cause undesirable operation of the device.

The user is cautioned that modifications to this telephone, not expressly approved by Avaya, could void the user's authority to operate the equipment.

## Hearing Aid Compatibility

This wireless telephone is compatible with inductively coupled hearing aids.



# C Specifications

<b>GENERAL</b>			
<b>Model:</b>	<b>MDW 9040 Wireless Pocket Phone</b>		
<b>Dimensions and Weights:</b>	Handset	6.0" (L) x 1.0" (D) x 2.25"(W) 15.24 x 2.54 x 5.71 cm	0.33 lb 0.15 kg
	Handset w/Battery Pack	6.0" (L) x 1.0" (D) x 2.25"(W) 15.24 x 2.54 x 5.71 cm	0.55 lb 0.25 kg
	Battery Charger (BC)	9.75" (L) x 5.13" (H) x 3.94" (W) 24.77 x 13.03 x 10.01 cm	.50 lb 0.23 kg
	Battery Charger w/ Battery Pack	9.75" (L) x 5.13" (H) x 3.94" (W) 24.77 x 13.03 x 10.01 cm	.72 lb 0.32 kg
	Standard Battery Pack	3.0" (L) x .75" (H) x 2.5" (W) 7.6 x 1.9 x 6.35 cm	0.22 lb 0.10 kg
	Extended Battery Pack	3.0" (L) x .95" (H) x 2.5" (W) 7.6 x 2.4 x 6.35 cm	0.35 lb 0.16 kg
	Headset w/Cord (approx.)	10.5" (L) x 1.2" (H) x 5.6" (W) 26.67 x 3.05 x 14.22 cm	0.17 lb 0.08 kg
	Radio Module (RM)	9" (L) x 5" (H) x 6" (W) 22.86 x 12.7 x 15.24 cm	1.03 lb 0.46 kg
	Power Supply (BC)	3.35" (L) x 2.70" (H) x 2.19" (W) 8.50 x 6.85 x 5.55 cm	.74 lb 0.33 kg
	<b>Operating Temperature:</b>	Handset	Operating Temperature: <b>0 to 50°C, 15– 90% humidity</b>
Dual Radio Module		Operating Temperature: <b>-20 to 70°C, 0– 95% humidity</b>	
Batteries		Operating Temperature: <b>0 to 50°C, 15– 90% humidity</b>	
Battery Charger		Operating Temperature: <b>0 to 45°C, 15– 90% humidity</b>	

## C Specifications

<b>GENERAL</b>		
<b>Electrical Specifications: (Power)</b>	Handset	1.0 watt
	Battery Charger (BC)	6.3 watts
	Radio Module (RM)	4.0 watts
	Power Supply (BC)	13 watts (10V 1.5 A)
<b>Battery Pack Life:</b>	Standard Nickel Metal Hydride	3 hours talk time/22 hours standby time
	Extended Nickel Metal Hydride	8 hours talk time/72 hours standby time
<b>RF SYSTEM PARAMETERS:</b>		
<b>Frequency Band:</b>	902 – 928 MHz	
<b>Channel Spacing:</b>	409.6 KHz	
<b>Total Channel Capability:</b>	25 (Channels Dynamically allocated out of 64)	
<b>Duplex Method:</b>	Time Division Duplex (TDD) (Transmit and Receive on same frequency)	
<b>Transmitter Output Power:</b>	Dynamic Power Adjustment: 1mW ERP Minimum to 250mW ERP Maximum	
<b>Receiver Sensitivity:</b>	-102 dBm at Antenna Port	
<b>OTHER:</b>		
<b>Requirements For Out-Of-Building Extensions:</b>	<p>Installation of a telephone or other standard (tip/ring) device in another building requires the following In-Range Out-of-Building (IROB) to protect the switch/control unit and telephone device from surges:</p> <ul style="list-style-type: none"> <li>MDW 9040 Pocket Phone: two Avaya 146D protectors for (ETR) PARTNER; two Avaya 4C3S-75 protectors for (DCP) DEFINITY; two Avaya 146E protectors for (TDL) MERLIN MAGIX, (ATL) MERLIN LEGEND and earlier; two Avaya 146D protectors for (ETR) MERLIN MAGIX and MERLIN LEGEND R7</li> </ul>	
<b>Wiring:</b>	<ul style="list-style-type: none"> <li>MDW 9040 Pocket Phone: Avaya SYSTIMAX<sup>®</sup> or at least 2-pair (4-wire) star (“home run” not “loop”) ETR</li> <li>Avaya SYSTIMAX or at least 4-pair (8-wire) star (“homerun” not “loop”) ATL</li> <li>Bridging Adapter: Avaya 267F2 (ETR)</li> <li>Bridging Adapter: Avaya 267C (ATL)</li> <li>Range: 1,000 feet (305 m) for the Radio Module (26 AWG)</li> </ul>	



# D Ordering Replacement and Optional Parts

To order replacement parts or optional equipment in the continental U.S., call the Avaya Customer Care Center or National Parts Center toll free. When ordering, please use the part numbers shown in the following table.

Item	Customer Care Center 1-800-451-2100	National Parts Center 1-800-222-PART
<b>MDW 9040 Pocket Phone:</b> Includes Handset, battery, charger, user documents	3204-09B	108 535 998
<b>Radio Module</b> for PARTNER and vintage MERLIN: Includes radio module, cables, installation documents	3204-DRE	108 487 158
<b>Radio Module</b> for DEFINITY and MERLIN MAGIX: Includes radio module, cables, installation documents	3204-DRD	108 487 174
<b>Standard Battery:</b> Includes belt clip	3279-3BP	108 272 485
<b>Extended Use Battery:</b> Includes belt clip	3204-EBY	108 586 553
<b>Belt Clip</b> for standard battery (replacement or extra) - Quantity: 10	3204-BCS	848 172 847
<b>Belt Clip</b> for extended use battery (replacement or extra)	3204-BCX	848 441 390
<b>Retractable Antenna</b> for 9040 Handset (replacement)	NA	847 713 450
<b>Wrist Lanyard</b> (replacement)	NA	407 183 417
<b>Leather Case (black):</b> Includes belt clip and bungee cord	3204-HOL	848 350 930
<b>Battery Charger:</b> Includes Power Cord (replacement or extra)	3279-3BC	108 386 921
<b>Power Cord</b> for Battery Charger (replacement)	NA	408 082 204
<b>Auxiliary Power Supply</b> Model # 1151A1	2404-010A	108 212 952
<b>Auxiliary Power Supply</b> Model # 1151A2, with battery hold over.	2404-012A	108 212 960
<b>Synchronization Cable</b> 20 inches (50 cm), connects Dual Radio Module to Dual Radio Module	NA	848 353 173

## D Ordering Replacement and Optional Parts

---

<b>Item</b>	<b>Customer Care Center 1-800-451-2100</b>	<b>National Parts Center 1-800-222-PART</b>
<b>Synchronization Cable</b> 48 inches (121.92 cm), connects Dual Radio Module to Dual Radio Module	NA	848 426 367
<b>D8W Station Line Cord</b> 14 feet (4.2 m) 8 pin cable for DRM-E	NA	103 786 676
<b>D4BU Station Line Cord</b> 14 feet (4.2 m)	272502N	102 479 896
<b>Supra Mobility Headset Single Ear Muff</b> with headband (requires Adapter Cord 3275-DWS)	3275-SUP	407 713 718
<b>Supra Mobility Headset Dual Ear Muff</b> with headband (requires Adapter Cord 3275-DWS)	3275-SU2	408 094 746
<b>Radium Mobility Headset Behind-the-Ear</b> (requires Adapter Cord 3275-DWS)	3275-RAD	407 720 739
<b>9040 Headset Adapter Cord</b>	3275-DWS	108 267 493
<b>Bungee Cords</b> (package of 5 - replacements)	3279-BGE	NA
<b>Outdoor Box</b> (for outdoor installations)	3204-OUT	407 954 296

# E Wall-Mounting Templates

This Appendix includes two wall-mounting templates for the following:

<b>Battery Charger Wall-Mounting Template</b>	Use this template to position the screws for mounting your MDW 9040 Wireless Pocket Phone battery charger.
<b>Spacing Template for Mounting Multiple Dual Radio Modules</b>	Use this template to determine spacing for mounting more than one radio module.

## Battery Charger Wall-Mounting Template

Use the template below to position the screws for mounting your MDW 9040 Wireless Pocket Phone battery charger:

- 1 Cut out the template along the dotted line.
- 2 Lightly affix the template to the wall with tape where you want to attach the battery charger. If possible, choose a location that will position at least one of the screw holes over a wall stud.
- 3 Mark the wall.
- 4 Position a wall spacer on each of the two wood screws provided, and insert the screws in the wall as far as they will go at the places you marked.

**Note:** *If you cannot locate a wall stud for one of the screws, use molly bolts or another type of hollow-wall fastener. Be sure to place the wall spacers on the screws before inserting them permanently.*

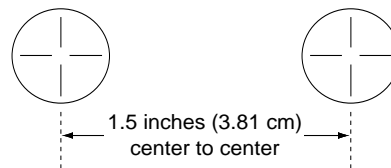



## Multiple Dual Radio Modules Spacing Wall-Mounting Template

Use the template below to position the screws for mounting multiple MDW 9040 Dual Radio Modules:

- 1 Cut out the template along the dotted line.
- 2 Lightly affix the template to the wall with tape where you want to attach the radio modules. If possible, choose a location that will position at least one of the screw holes over a wall stud.
- 3 Mark the wall.
- 4 Position the plates so they are at least 5.25 inches (13.34 cm) apart.

**Note:** *If you cannot locate a wall stud for one of the screws, use molly bolts or another type of hollow-wall fastener. Be sure to place the wall spacers on the screws before inserting them permanently.*





# Index

## A

- Adjusting Handset Volume 49
- Alerter 45
  - type 50
  - volume 49
- Answering a Call 66
  - headset 69
- Antenna
  - installation requirements 5
  - positioning 13
  - replacement 69, 97
  - using 44, 69
- Auxiliary Power Supply
  - about 11
  - Dual Radio Module 11
  - line cord connection 9
  - ordering 97
  - out-of-building installations 13
  - recommended 11
  - testing with 2
  - wiring 11

## B

- Backlighting 44, 50
- Battery Charge Level Icon 45
- Battery Charger
  - about 31
  - charging battery pack 26
  - extending life of battery pack 32
  - features 31
  - handset cradle 29
  - inserting standard battery pack 26
  - installation 24, 25–26
  - LEDs 32
  - memory effect 31
  - positioning 24
  - power supply 97
  - refresh process 32
  - refreshing 31, 32, 33
  - removing spare battery 27
  - removing the handset 30
  - replacement 97
  - spare battery compartment 31
  - wall-mounting template 99

- Battery Icon 33, 45
- Battery Life 32
- Battery Pack
  - average life 33
  - charging 26
  - disposal of 7, 24
  - extended 4
  - extending life of 32
  - handset cradle 31
  - inserting into handset 28
  - inserting standard 26
  - low battery indicator 48
  - low power indicator 48
  - memory effect 31, 32, 33
  - refreshing 31, 32, 33
  - removing from battery charger 27
  - replacement 97
  - spare (extended) 48
  - spare (standard) 48
  - spare battery compartment, inserting 26
  - standard 4
  - talk time 32, 33
  - warning 7, 24
- Belt Clip
  - fastening 70
  - removing 71
- Button Mapping 40
  - DEFINITY systems 86
  - MERLIN MAGIX systems 84
  - MERLIN systems 80, 81
  - PARTNER systems 77

## C

- Cardiac Pacemakers
  - warning instructions 6
- Carrying Case 70, 97
- Carrying Clips 70, 97
- Close Up Test 64
- Column Buttons 44, 46
- Conference Button 44
- Conference Calls 44
- Configuration Menu 50
  - activating Backlighting 55
  - alerter type 54
  - choosing to hear key clicks 57
  - message length 52
  - turning on Line Pre-Select 56
- Control LED 9, 10, 16, 19, 37
- Coverage Zone 61, 64

## D

- DEFINITY Systems
  - button mapping 40, 86
  - call-handling instructions 73
  - compatible Dual Radio Modules 8
  - line jack wiring 12
  - maximum Dual Radio Modules and handsets 16
  - setting Line Ringing options 87
  - wiring 11
- Display 44, 45
  - activating 66
  - icons 45
  - menus 50
  - test indications 60
- Dual Radio Module
  - about 1–2, 8–10
  - auxiliary power supply 11
  - circuitry 9
  - components 9
  - Control 16
  - daisy-chaining 17, 19
  - dual zone configuration 13, 17
  - expansion 16
  - installation 14
  - installing on desk or shelf 15
  - installing two or more 17
  - LED indicators 10, 37
  - line jack wiring 12
  - maximum for DEFINITY systems 16
  - maximum for key systems 16
  - maximum for MERLIN LEGEND systems 16
  - maximum for MERLIN MAGIX systems 16
  - maximum for MERLIN systems 16
  - maximum for PARTNER systems 16
  - maximum for PBX systems 16
  - mounting 12, 14
  - multiple, single zone configuration 15
  - packaging components 4
  - parts list 4
  - positioning 2, 12
  - positioning rules 12
  - power level 64
  - range 12, 14
  - registration buttons 9
  - selection table 8
  - single zone configuration 13
  - synchronization 15
  - wall mounting 14
  - wall-mounting spacing template 101

- Dual Zone Configuration
  - about 2, 13
  - administration 19–20
  - administration for DEFINITY 20
  - administration for MERLIN 410 and 820 19
  - administration for MERLIN LEGEND 20
  - administration for MERLIN MAGIX 20
  - administration for PARTNER 19
  - first zone of dual zone installation 36
  - installing multiple Dual Radio Modules 17–19
  - registration 13
  - second zone of dual zone installation 37

## E

- Edge of Range Test 64
- Environmental Requirements 7, 24
- Expansion LED 16
- Extended Battery Pack
  - talk time 32, 48

## F

- Feat/P 44
- Feature/Program Button 44

## H

- Handset
  - about 43
  - alerter 45
  - alerter volume level 49
  - answering a call 66
  - antenna 44, 69
  - backlighting 44
  - Backlighting feature 55
  - Battery Charge Level icon 45
  - Battery icon 45
  - button mapping 40
  - changing settings 50
  - column buttons 44
  - column buttons, using 46
  - conference button 44
  - display 44, 45
  - electrical specifications 95
  - fastening the belt clip 70
  - feature/program button 44
  - features 44
  - handset cradle 31
  - handset label 41
  - hold button 44
  - inserting into battery charger 29
  - lanyard 44
  - line status indicators 46



- maximum for DEFINITY systems 16
- maximum for key systems 16
- maximum for MERLIN LEGEND systems 16
- maximum for MERLIN MAGIX systems 16
- maximum for MERLIN systems 16
- maximum for PARTNER systems 16
- maximum for PBX systems 16
- menu button 44
- Message icon 45
- microphone 45
- More Options Available icon 45
- mute button 44
- Mute Status icon 45
- muting 50
- No Ring icon 45
- on/off button 44
- On/Off icon 45
- operating and storage temperature 95
- packaging components 3
- parts list 3
- placing a call 66
- quick reference for registration 39
- Radio Frequency (RF) Signal Level icon 45
- Radio Frequency icon 45
- range indicators 47
- receiver 44
- redial button 44
- registration 13, 35, 37
- registration mode 36
- registration screen 36
- removing belt clip 71
- removing from battery charger 30
- removing registration 38
- Ringer Status icon 45
- ringer volume level 49
- select button 44
- select rectangle 44, 46
- select triangle 46
- select-row button 44
- select-row button, using 46
- Softkeys 44
- transfer button 44
- turning on 48
- using features 66
- Vibrator icon 45
- Vibrator Status icon 45
- volume control 44, 49
- waking up 66
- Handset Cradle 31
  - inserting handset 29
  - removing handset 30
- Handset Label
  - filling out 41
- Handset LED 29, 31, 32, 33

- Headset
  - adapter 68
  - adapter quick disconnect plug 68
  - answering a call 69
  - connecting 68
  - microphone 45
  - on/off button 68
  - ordering or replacements 98
  - placing a call 69
  - replacement 97
  - requirements 4
  - using 68
- Headset Connector 44
- Hearing Aid Compatibility 6
- Hendset
  - registration activation button 35
- Hold Button 44

- Icon
  - On/Off 44
- Icons
  - Battery 33, 45
  - Battery Charge Level 45
  - Handset On/Off 45
  - list 45
  - Message 45
  - More Options Available 45
  - Mute Status 45
  - No Ring 45
  - Radio Frequency 45
  - Radio Frequency (RF) Signal Level 45
  - Ringer Status 45
  - Vibrator 45
  - Vibrator Status 45
- Indicators
  - Line Selection 67
  - low battery 48
  - low power 48
  - range 47
- Installation
  - battery charger 24, 25–26
  - Dual Radio Module 14
  - dual zone configuration 17
  - dual zone installation 14
  - multiple Dual Radio Modules in dual zone configuration 17
  - multiple Dual Radio Modules in single zone configuration 15
  - overview 7–8
  - single zone configuration 14
  - two or more Dual Radio Modules 17

**J**

- Jacks
  - LINE 9, 12
  - SYNC 9, 19

**K**

- Key Clicks 50
- Key Switch
  - maximum number Dual Radio Modules and handsets 16
- Key Systems
  - maximum Dual Radio Modules and handsets 16

**L**

- Lanyard 44, 70
- Lanyard Replacement 97
- LED
  - Control 9, 10, 16, 19, 37
  - Expansion 16
  - flashing 37
  - Handset 29, 31, 32, 33
  - indicators 10, 37
  - Power 9, 10, 37
  - Refresh 31, 32, 33
  - Spare 26, 31, 32, 33
  - synchronization 10
- Light Indicators 10
- Line Jacks 9, 12
  - DEFINITY systems wiring 12
  - MERLIN MAGIX systems wiring 12
  - MERLIN systems wiring 12
  - PARTNER systems wiring 12
- Line Pre-Select 50
  - using 67
- Line Selection 44, 67
- Line Status 47
  - indicators 46
- Local Test Mode 50
  - using 60

**M**

- MDW 9040 Pocket Phone
  - about 1
  - ordering replacement and optional parts 97
  - regulatory information 93
  - replacement 97
  - warranty information 91
  - What Is a Wireless Phone? 1
- Memory Effect 31, 32, 33

- Menu Button 44
- Menu Mode 44
  - Configuration Menu 50
  - Options Menu 50
  - selecting a menu item 50
  - Test Mode Menu 50
- MERLIN 410/820
  - compatible Dual Radio Modules 8
- MERLIN LEGEND
  - compatible Dual Radio Modules 8
- MERLIN LEGEND Systems
  - maximum Dual Radio Modules and handsets 16
- MERLIN MAGIX Systems
  - button mapping 40, 84
  - call-handling instructions 73
  - compatible Dual Radio Modules 8
  - line jack wiring 12
  - maximum Dual Radio Modules and handsets 16
  - setting Line Ringing options 86
  - wiring 11
- MERLIN Systems
  - administration 79
  - button mapping 40, 80, 81
  - call-handling instructions 73
  - compatible Dual Radio Modules 8
  - line jack wiring 12
  - maximum Dual Radio Modules and handsets 16
  - programming 79
  - programming features 74
  - setting Line Ringing options 83
  - wiring 11
- Message Icon 45
- Microphone 44, 45
- More Options Available Icon 45
- Mounting
  - desk or shelf 14
  - Wall 14
- Mute Button 44
- Mute Function 50
- Mute Status Icon 45
- Muting Handset Volume 50

**N**

- No Ring Icon 45

**O**

- On/Off Button 44
  - headset 68
- On/Off Icon 45
- Options Menu 50, 53
- Out-of-Building Requirements 96

## P

- Packaging Components
  - Dual Radio Module 4
  - handset 3
- PARTNER Systems
  - button mapping 40, 77
  - call-handling instructions 73
  - compatible Dual Radio Modules 8
  - line jack wiring 12
  - maximum Dual Radio Modules and handsets 16
  - programming features 74
  - setting Line Ringing options 78
  - wiring 11
- Parts
  - illustrations 4
- Parts List
  - additional parts 4
  - Dual Radio Module 4
  - handset 3
- PBX Systems
  - maximum Dual Radio Modules and handsets 16
- Placing a Call 66
  - headset 69
- Positioning
  - antenna 13
  - battery charger 24
  - Dual Radio Module 12
- Power LED 9, 10, 37
- Power Level
  - Dual Radio Module 64
  - handset 63
- Power Supply 97
- Privacy information 2
- Programmable Buttons 74
- Programming Features
  - MERLIN systems 74
  - PARTNER systems 74
- Programming Mode 44, 74

## R

- Radio Frequency (RF) Signal Level Icon 45
- Radio Frequency Icon 45
- Radio Frequency Requirement 5
- Range 12, 47, 64
  - adjusting 48
  - extending 69
  - out of 48
  - testing 61, 64
- Receiver 44
- Redial Button 44
- Refresh Button 31
- Refresh LED 31, 32, 33

- Refresh Process 31, 32, 33
- Refreshing 31, 32, 33
- Registration
  - activation button 35
  - dual zone configuration 13
  - handset 13, 35, 37
  - Line 1 9
  - Line 2 9
  - mode 36
  - overview 35
  - quick reference 39
  - removing 38
  - screen 36
  - single zone configuration 13, 36
- Registration Process
  - quick reference 39
  - removing registration 38
- Regulatory Information 93
- Repair Information 92
- Requirements
  - Out-of-Building 96
- Ringer 49
- Ringer Status Icon 45

## S

- Safety Instructions 5–7
  - cardiac pacemakers 6
  - hearing aids 6
- Select Button 44
- Select Rectangle 44, 46
- Select Triangle 46
- Selecting a Line 67
- Select-Row Button 44, 46, 50
- Setting Line Ringing Options
  - DEFINITY systems 87
  - MERLIN MAGIX systems 86
  - MERLIN systems 83
  - PARTNER systems 78
- Signal Strength
  - testing 61, 62, 64, 65
- Single Zone Configuration
  - about 13
  - installing multiple Dual Radio Modules 15
  - registration 13, 36
- Sleep Mode 66
- Softkeys 44, 50
- Sound Clarity
  - testing 61
- Spare Battery Compartment 31
  - inserting battery pack 26
- Spare Battery Compartment removing battery pack 27
- Spare LED 26, 31, 32, 33
- Specifications 95

- Standard Battery Pack
  - inserting in battery charger 26
  - replacing 97
  - talk time 33, 48, 96
- Standby Time 96
- Station Line Cord
  - ordering 98
- Station Ports 9
- Switch Wiring
  - about 11
  - auxiliary power supply 11
  - customized 12
  - DEFINITY Systems 11
  - interfaces 12
  - line jacks 12
  - MERLIN MAGIX 11
  - MERLIN Systems 11
  - PARTNER Systems 11
- Switch-Related Features
  - programming 69
- Synchronization Jacks 9, 19

**T**

- Talk Time 32, 33, 48, 96
- Test Mode
  - local 50, 60
  - wireless 50, 61
- Test Mode Menu
  - local test mode 60
  - wireless test mode 61
- Testing
  - Dual Radio Module power level 64
  - handset power level 63
  - local test mode 60
  - range 64
  - signal strength 61, 62, 64
  - sound clarity 61
  - voice quality 61, 63, 64
- Transfer Button 44
- Transferring a Call 44

**U**

- UnReg 38

**V**

- Vibrator Icon 45
- Vibrator Status Icon 45
- Voice Quality
  - improving 69
  - testing 61, 63, 64
- Volume Control 44, 49

**W**

- Waking Up the Phone 66
- Wall Mounting
  - Dual Radio Module 14
- Wall-Mounting Templates 99
- Warranty Information 91
- Wireless Test Mode 50
  - using 61
- Wiring 7, 96





## Free Manuals Download Website

<http://myh66.com>

<http://usermanuals.us>

<http://www.somanuals.com>

<http://www.4manuals.cc>

<http://www.manual-lib.com>

<http://www.404manual.com>

<http://www.luxmanual.com>

<http://aubethermostatmanual.com>

Golf course search by state

<http://golfingnear.com>

Email search by domain

<http://emailbydomain.com>

Auto manuals search

<http://auto.somanuals.com>

TV manuals search

<http://tv.somanuals.com>