



DSVIEW® 3
Installer/User Guide





DSView[®] 3

Management Software

Version 3.7

Installer/User Guide

Avocent, the Avocent logo, The Power of Being There, DSView, DSR, MergePoint, AlterPath, AutoView, OutLook, OSCAR, AVWorks, LANDesk, Dambrackas Video Compression and Cyclades are registered trademarks of Avocent Corporation or its affiliates. All other marks are the property of their respective owners.

© 2008 Avocent Corporation. 590-395-501M

TABLE OF CONTENTS

List of Figures	xiii
List of Tables	xv
Chapter 1: Product Overview	1
<i>Features and Benefits</i>	<i>1</i>
<i>System Components</i>	<i>2</i>
<i>Third party products</i>	<i>3</i>
<i>Partner products</i>	<i>3</i>
<i>Supported Units</i>	<i>4</i>
<i>Target devices</i>	<i>7</i>
<i>Power devices</i>	<i>7</i>
<i>System Configuration</i>	<i>7</i>
Chapter 2: Installation	9
<i>About Installation</i>	<i>9</i>
<i>Installing the DSView 3 Software</i>	<i>10</i>
<i>Upgrading the DSView 3 Software</i>	<i>13</i>
<i>Recommended upgrade process</i>	<i>14</i>
<i>Configuring the DSView 3 Software</i>	<i>14</i>
<i>Running the DSView 3 Software</i>	<i>16</i>
<i>Uninstalling the DSView 3 Software</i>	<i>18</i>
<i>Closing a DSView 3 Software Session</i>	<i>19</i>
<i>Java Installation</i>	<i>19</i>
<i>Avocent Viewer Plug-in Installation</i>	<i>20</i>
<i>Installing the DSR Remote Operations Software</i>	<i>21</i>
Chapter 3: DSView 3 Explorer Windows	23
<i>Accessing Target Devices</i>	<i>24</i>
<i>Using the Side Navigation Bar</i>	<i>24</i>
<i>Using Windows</i>	<i>26</i>
<i>Sorting information in a window</i>	<i>26</i>
<i>Filtering information in a window</i>	<i>26</i>
<i>Saving information in a window</i>	<i>27</i>
<i>Using the Customize link in windows</i>	<i>28</i>

<i>Displaying pages</i>	29
<i>Bookmarking a window</i>	30
<i>Printing a window</i>	30
<i>Refreshing a window</i>	30
<i>Using keyboard commands</i>	31
Chapter 4: Basic Operations	33
<i>DSView 3 Help</i>	33
<i>Configuring the DSView 3 help location</i>	33
<i>Installing DSView 3 help on a local server</i>	34
<i>Global System Properties</i>	34
<i>Legal Notice</i>	35
<i>PCI Compliance Configuration</i>	35
<i>Profiles</i>	36
<i>Changing user options</i>	36
<i>Changing the color scheme</i>	37
<i>Changing your password</i>	37
<i>Choosing the serial session application</i>	38
<i>Specifying a user certificate</i>	38
<i>Specifying an SSH key</i>	39
<i>Enabling user credential caching</i>	40
<i>Built-in User Groups</i>	40
<i>Preemption Levels</i>	41
<i>Internet Explorer Considerations</i>	42
<i>Certificates</i>	46
<i>Integrated Windows Authentication</i>	49
<i>Firewalls</i>	50
<i>VPNs</i>	51
<i>NAT Devices</i>	53
<i>Licenses</i>	54
<i>Adding a new license key</i>	56
<i>System Information</i>	56
<i>ISV Partners</i>	57
Chapter 5: DSView 3 Servers	59
<i>Server Properties</i>	59

<i>Server certificates</i>	61
<i>Avocent proxy server</i>	65
<i>Server trap destinations</i>	66
<i>Client session information</i>	66
<i>DSView 3 software modem sessions</i>	67
<i>Email</i>	68
<i>Unit status polling</i>	69
<i>Backing up and Restoring Hub Servers Manually</i>	69
<i>Spoke Servers</i>	72
<i>Replication</i>	75
Chapter 6: Authentication Services	79
<i>Supported Authentication Services</i>	79
<i>DSView 3 software internal authentication service</i>	80
<i>Active Directory external authentication service</i>	82
<i>Windows NT external authentication service</i>	87
<i>LDAP external authentication service</i>	88
<i>RADIUS external authentication service</i>	93
<i>TACACS+ external authentication service</i>	95
<i>RSA SecurID external authentication service</i>	98
<i>User Authentication Services Window</i>	100
Chapter 7: Units View Windows	103
<i>Showing and hiding units</i>	107
<i>Units View windows fields</i>	107
<i>Multiple unit operations from a Units View window</i>	111
<i>Unit Overview Windows</i>	112
<i>Unit Status Window</i>	113
Chapter 8: Adding and Deleting Units	115
<i>Adding Units</i>	115
<i>Deleting Units</i>	123
<i>Automatically deleting attached units</i>	123
Chapter 9: Synchronizing the DSView 3 Software Database	125
<i>Name Synchronization</i>	125
<i>Topology Synchronization</i>	130

<i>Automatic Discovery</i>	135
<i>Automatic Inheritance for Group Memberships and Properties</i>	135
Chapter 10: Managing Units	137
<i>Appliance Configuration Templates</i>	137
<i>Saving appliance configuration templates</i>	137
<i>Modifying appliance configuration template properties</i>	138
<i>Applying appliance configuration templates</i>	138
<i>Unit Properties</i>	139
<i>About Access Rights</i>	144
<i>Unit Access Rights</i>	146
<i>Managed Appliance Status</i>	147
<i>Managed Appliance Settings</i>	147
<i>Managed Appliance SNMP Settings</i>	149
<i>Target Device Settings</i>	150
<i>Target Device Services</i>	151
<i>Target Device Naming</i>	152
<i>IQ Module Settings</i>	153
<i>KVM Switch and Cascade Switch Settings</i>	154
<i>OSCAR interface settings</i>	156
<i>Local Account Settings</i>	157
<i>Embedded Units</i>	160
<i>Asset and Usage Reports</i>	162
<i>Asset</i>	162
<i>Usage</i>	163
Chapter 11: Power Devices and Power Device Sockets	165
<i>Power Devices</i>	165
<i>Power Device Input Feed</i>	167
<i>Power Device Sockets</i>	168
<i>Power Control of Devices Attached to Power Devices</i>	169
Chapter 12: Unit Sessions and Connections	171
<i>Managed Appliance Session Settings</i>	171
<i>Active Sessions</i>	176
<i>Active sessions on a target device</i>	178

<i>Active modem sessions</i>	179
<i>Connections to Units</i>	181
<i>Merging virtual and physical target device connections</i>	183
Chapter 13: Data Logging	185
<i>Configuring Data Logging</i>	186
<i>Enabling the SSH server</i>	187
<i>Enabling the Syslog server</i>	187
<i>Enabling and disabling data logging on units</i>	188
<i>Verifying the data logging settings for each connection</i>	188
<i>Viewing and customizing the SSH server settings</i>	189
<i>Configuring the buffer warnings events as SNMP</i>	190
<i>Specifying where data log files will be stored</i>	190
<i>Archiving and deleting data log files</i>	191
<i>Viewing Data Log Files</i>	193
Chapter 14: SSH Passthrough Sessions	195
<i>Configuring SSH Passthrough</i>	195
<i>Enabling SSH Passthrough</i>	195
<i>SSH port sharing</i>	196
<i>SSH Passthrough Sessions</i>	197
<i>Establishing an SSH Passthrough connection to a unit</i>	198
<i>Escape key sequence</i>	200
<i>Break sequences</i>	200
<i>Transferring read/write access</i>	202
<i>Disconnecting a session</i>	202
<i>Displaying session output</i>	202
<i>Supported service processor commands</i>	203
Chapter 15: Grouping Units	205
<i>Site, Department and Location Groups</i>	205
<i>Custom Fields</i>	207
<i>Unit Groups</i>	210
<i>Unit group hierarchy</i>	212
<i>Adding or deleting a unit group</i>	214
<i>Changing the unit group properties</i>	215

Chapter 16: DS Zones	219
<i>Managing and Accessing Zones</i>	219
<i>Enabling DS Zones</i>	219
<i>Creating zones</i>	219
<i>Accessing zones</i>	220
<i>Transferring units to a zone</i>	221
<i>Managing zone properties</i>	221
<i>Using Zones</i>	223
<i>Units actions in a zone</i>	223
Chapter 17: Managing User Accounts	229
<i>User Accounts Windows</i>	229
<i>Adding User Accounts</i>	231
<i>Deleting User Accounts</i>	233
<i>Unlocking User Accounts</i>	233
<i>Resetting a User Account Password</i>	233
<i>Changing User Account Properties</i>	234
<i>Username</i>	234
<i>User certificates</i>	235
<i>User SSH key</i>	235
<i>User password</i>	236
<i>User account restrictions and expiration settings</i>	236
<i>User group membership</i>	237
<i>Preemption level</i>	237
<i>Address</i>	237
<i>Phone contact</i>	238
<i>Email contact</i>	238
<i>User notes</i>	238
<i>Custom field properties</i>	239
<i>User Access Rights</i>	239
Chapter 18: User Groups	241
<i>Adding User-defined User Groups</i>	242
<i>Deleting User-defined User Groups</i>	244
<i>User Group Properties</i>	245
<i>Changing User Group Members</i>	245

<i>User Group Access Rights</i>	246
Chapter 19: Using the Video Viewer	249
<i>About the Video Viewer</i>	249
<i>Window Features</i>	250
<i>Opening a KVM Session</i>	251
<i>Closing a Video Viewer Session</i>	254
<i>KVM Session Profiles</i>	254
<i>Using Menu Commands to Manage Session Settings</i>	263
<i>Manual Video Adjustment</i>	267
<i>Saving the View</i>	270
<i>Displaying Video Viewer Users</i>	270
<i>Scan Mode</i>	271
<i>Macros</i>	274
<i>Power Control of Devices Attached to Power Devices</i>	279
<i>Using Virtual Media</i>	279
<i>Using Smart Cards</i>	283
<i>Video Viewer Troubleshooting</i>	284
Chapter 20: Using the Telnet Viewer	287
<i>About the Telnet Viewer</i>	287
<i>Telnet Viewer Window Features</i>	287
<i>Telnet Viewer window toolbar</i>	289
<i>Security Property</i>	290
<i>Opening a Session</i>	290
<i>Customizing the Telnet Viewer</i>	291
<i>Customizing Session Properties</i>	292
<i>Login scripts</i>	294
<i>Reviewing Session Data</i>	295
<i>Macros</i>	296
<i>Logging</i>	299
<i>Copying, Pasting and Printing Session Data</i>	302
<i>Power Control of Devices Attached to Power Devices</i>	303
<i>Closing a Telnet Viewer Session</i>	304
Chapter 21: Using Tools	305

<i>Using Unit Tools</i>	305
<i>Exporting units</i>	305
<i>Exporting access rights</i>	307
<i>Merging target devices</i>	307
<i>Merging target device endpoints</i>	308
<i>Importing DSVIEW 2.x software databases</i>	309
<i>Importing data</i>	312
<i>Using the Managed Appliance Tools</i>	313
<i>Rebooting</i>	313
<i>Upgrading firmware</i>	314
<i>Resynchronizing units</i>	315
<i>Saving a managed appliance configuration</i>	316
<i>Restoring a managed appliance configuration</i>	316
<i>Saving a managed appliance user database</i>	317
<i>Restoring a managed appliance user database</i>	317

Chapter 22: Using Tasks 319

<i>Using the Tasks Window</i>	319
<i>Adding tasks</i>	320
<i>Specifying when to run tasks</i>	320
<i>Adding tasks using the Add Task Wizard</i>	322
<i>Task: Backup DSVIEW 3 software database and system files</i>	323
<i>Task: Configure SNMP trap settings on a managed appliance</i>	324
<i>Task: Power control a target device</i>	324
<i>Task: Exporting an event log .csv file</i>	325
<i>Task: Migrating units</i>	326
<i>Task: Sending an IPMI chassis control command to target devices</i>	328
<i>Task: Test modem connections to selected units</i>	329
<i>Task: Updating the firmware of an appliance type</i>	329
<i>Task: Validating user accounts on an external authentication server</i>	330
<i>Task: Pull names from selected units</i>	330
<i>Task: Update topology for selected units</i>	331
<i>Task: Backup Power Manager database</i>	332
<i>Task: Restore Power Manager database</i>	333
<i>Running tasks manually</i>	334

<i>Displaying task results</i>	334
<i>Deleting tasks</i>	335
<i>Changing tasks</i>	335
<i>Firmware Management</i>	336
Chapter 23: Events and Event Logs	339
<i>Event Severity and Categories</i>	339
<i>Email Notifications</i>	340
<i>Enabling and Disabling Event Logging</i>	343
<i>Displaying the Event Log</i>	343
<i>Event states</i>	345
<i>Using the date filter</i>	346
<i>Changing the Event Log Retention Period</i>	346
<i>Creating an Event Log .csv File</i>	347
Chapter 24: Plug-ins	349
<i>Recommended Sequence for Adding/Upgrading Plug-ins</i>	349
<i>Adding Plug-ins</i>	350
<i>Displaying Plug-in Information</i>	350
<i>Managing Plug-ins</i>	352
<i>Appendix A: Technical Support</i>	355
<i>Appendix B: TCP and UDP Ports</i>	356
<i>Appendix C: DSR Remote Operations Software</i>	364
<i>Appendix D: Terminal Emulation</i>	373
<i>Appendix E: Regaining Access to the DSView 3 Software</i>	389
<i>Appendix F: Glossary</i>	390
Index	401

LIST OF FIGURES

<i>Figure 1.1: Example System Configuration</i>	8
<i>Figure 3.1: Example Avocent DSView 3 Explorer Window Areas</i>	23
<i>Figure 3.2: Example Side Navigation Bar</i>	25
<i>Figure 4.1: Typical DSView 3 Software System Firewall Configuration</i>	51
<i>Figure 4.2: DSView 3 Software System on a VPN</i>	52
<i>Figure 4.3: Single NAT Configuration (Client Only)</i>	53
<i>Figure 4.4: Double-NAT Configuration (Client and Corporate)</i>	54
<i>Figure 7.1: Alternate Actions Arrow in a Units View Window</i>	109
<i>Figure 15.1: Custom Fields Example: Side Navigation Bar</i>	210
<i>Figure 15.2: Unit Groups Structure</i>	211
<i>Figure 15.3: Unit Group Hierarchy Example</i>	212
<i>Figure 19.1: Video Viewer Window (Normal Windows Mode) (Windows OS Shown)</i>	250
<i>Figure 19.2: Manual Video Adjust Dialog Box</i>	268
<i>Figure 19.3: Thumbnail Viewer</i>	272
<i>Figure 20.1: Telnet Viewer Window</i>	288
<i>Figure B.1: Ports Used with a KVM Switch Connection Without Proxy</i>	357
<i>Figure B.2: Ports Used with a KVM Switch Proxy Server Connection (KVM)</i>	358
<i>Figure B.3: Ports Used with a Serial Console Appliance Connection (Serial) Without Proxy</i>	359
<i>Figure B.4: Ports Used with a Serial Console Appliance Proxy Server Connection (Serial)</i>	360
<i>Figure B.5: Generic Appliance Session Ports</i>	361
<i>Figure B.6: External Authentication Server Ports</i>	362
<i>Figure B.7: Ports Used by SNMP (No External SNMP Manager)</i>	362
<i>Figure B.8: Ports Used by SNMP (with External SNMP Manager)</i>	363
<i>Figure C.1: Using the DSR Remote Operations Software with a DSR Switch</i>	365
<i>Figure C.2: DSR Remote Operations Window</i>	369

LIST OF TABLES

<i>Table 1.1: DSView 3 Software System Configuration Descriptions.....</i>	8
<i>Table 3.1: DSView 3 Explorer Window Area Descriptions.....</i>	24
<i>Table 3.2: Side Navigation Bar Descriptions.....</i>	25
<i>Table 3.3: Filter Text Strings.....</i>	27
<i>Table 3.4: DSView 3 Explorer Page Navigation Buttons.....</i>	29
<i>Table 3.5: General Keyboard Commands.....</i>	31
<i>Table 3.6: Calendar Keyboard Commands.....</i>	31
<i>Table 3.7: Spinner Keyboard Commands.....</i>	31
<i>Table 4.1: Built-In User Group Allowed Operations.....</i>	40
<i>Table 4.2: User and User Group Preemption Levels.....</i>	42
<i>Table 4.3: System Certificate Policy.....</i>	48
<i>Table 4.4: Typical DSView 3 Software System Firewall Configuration Descriptions.....</i>	51
<i>Table 4.5: DSView 3 Software System on a VPN Descriptions.....</i>	52
<i>Table 4.6: Single NAT Configuration (Client Only) Descriptions.....</i>	53
<i>Table 4.7: Double-NAT Configuration (Client and Corporate) Descriptions.....</i>	54
<i>Table 4.8: License Summary Fields.....</i>	55
<i>Table 5.1: Server Properties.....</i>	59
<i>Table 5.2: DSView 3 Software Spoke Server Status.....</i>	72
<i>Table 7.1: Unit Status Values.....</i>	108
<i>Table 7.2: Action Links.....</i>	109
<i>Table 9.1: Automatic Name Push Operation Effects.....</i>	126
<i>Table 9.2: Automatic Name Pull Operation Effects.....</i>	127
<i>Table 9.3: Manual Name Pull Operation Effects.....</i>	129
<i>Table 14.1: DSView 3 Software - Supported SSH Passthrough Session Escape Keys.....</i>	200
<i>Table 14.2: DSView 3 Software - Supported SSH Passthrough Session Break Keys.....</i>	201
<i>Table 15.1: Links for Managing Sites, Departments or Location Associations.....</i>	207

Table 15.2: Custom Fields Example: Side Navigation Bar Descriptions 210

Table 15.3: Unit Groups Features..... 211

Table 15.4: Unit Group Hierarchy Example Descriptions..... 212

Table 16.1: Unit Actions in a Zone..... 223

Table 16.2: User Actions in a Zone 225

Table 16.3: Reports, Events and Data Logging Actions in a Zone 226

Table 16.4: Modifying System Settings in a Zone..... 227

Table 17.1: User Status Icons..... 229

Table 19.1: Video Viewer Window Descriptions..... 250

Table 19.2: Macintosh Keys and Keystrokes Not Supported in Keyboard Pass Through 256

Table 19.3: Manual Video Adjust Dialog Box Descriptions 268

Table 19.4: Thumbnail Viewer Descriptions..... 272

Table 19.5: Virtual Media Session Settings..... 281

Table 19.6: Smart Card Icons..... 283

Table 20.1: Telnet Viewer Window Descriptions 288

Table 20.2: Telnet Viewer Window Toolbar Icons 289

Table 20.3: Arrow Key Sequences 292

Table 20.4: Terminal Emulation and Type 293

Table 22.1: Task Status Icons 319

Table 23.1: Event Severity Levels..... 339

Table 24.1: Plug-ins Display Information..... 351

Table C.1: System Configuration Descriptions 365

Table C.2: DSR Remote Operations Descriptions..... 369

Table C.3: DSR Remote Operations Content Area Icons (Servers View) 370

Table C.4: DSR Remote Operations Content Area Icons (Power View)..... 370

Table D.1: VT Key and Keypad Numeric Codes 373

Table D.2: VT100+ Function Key Support 374

Table D.3: VT102 Receive Codes 374

<i>Table D.4: VT100 Special Keys and Control Keys</i>	375
<i>Table D.5: VT100 ANSI Set and Reset Mode Cursor Keys</i>	376
<i>Table D.6: VT100 PF1-PF4 Key Definitions</i>	377
<i>Table D.7: VT100 ANSI Mode Control Sequences</i>	377
<i>Table D.8: VT220 Encoding</i>	380
<i>Table D.9: VT220 Decoding</i>	382
<i>Table D.10: VT52 Encoding</i>	384
<i>Table D.11: VT52 Decoding</i>	384
<i>Table D.12: VT52 ANSI Mode Auxiliary Keypad Definitions</i>	385
<i>Table D.13: VT320 Encoding</i>	385
<i>Table D.14: VT320 Decoding</i>	386

Product Overview

The DSView® 3 management software version 3.7 is a secure, web browser-based, centralized enterprise management solution that allows users to remotely access, manage, monitor and control target devices through Avocent managed appliances. A session may be launched to a target device with a single point of access.

Features and Benefits

Network rebooting and troubleshooting

The DSView 3 software uses industry standard IP connections so that you can easily troubleshoot a server, or even reboot it, from the Network Operations Center (NOC), from your desk or from any location in the world. With the DSView 3 software, you can access all of your data center devices from a single screen - making complex network access and control remarkably easy. Using out-of-band management, the software can be used to reach and restart servers or other devices that are not functioning or responding to in-band commands, regardless of the state of the equipment's operating system.

Web-based access and control

The DSView 3 management software provides secure “point-and-click” browser-based access to control virtually any data center device using managed appliances from DSView 3 software clients located anywhere in the world.

Secure authentication and communication

Secure Socket Layer (SSL) encryption may be used to encrypt data traveling within the DSView 3 software system. Users may be authenticated through internal or external services such as LDAP, Active Directory, NT Domain, TACACS+, RADIUS and RSA SecurID.

Unit and user management

The DSView 3 management software provides centralized network access, control and security for managed appliances. A DSView 3 software administrator may add, remove, delete and change settings for managed appliances and target devices, including assigning permissions and per-device contact information, which are stored on the DSView 3 server. A DSView 3 software administrator

may also assign unique permissions which allow individual users or a group of users access to units or groups of units.

Proxy server access

The proxy server feature allows keyboard, video and mouse (KVM) and serial sessions to be proxied through the DSView 3 server. When a session is initiated with a target device, the viewer communicates using the Avocent Proxy Protocol (APP) and the DSView 3 server makes a direct connection to the appliance.

Virtual media

On supported KVM switches, a virtual media capable IQ module and the virtual media feature allow the client workstation user to load files onto USB2-compatible target devices when the usual network resources are unavailable.

Mapping physical drives or image files on the client system as virtual drives on the target device can accommodate critical tasks required on the target device, such as operating system installation or recovery, BIOS updating and configuration backups.

Dual stack support for IPv4 and IPv6

The DSView 3 server is a dual stack host for IPv4 and IPv6 network protocols. Several Avocent appliances support IPv6, including DSR[®] switches, ACS advanced console servers, MergePoint[®] service processor (SP) managers and OnBoard SP managers.

Virtual segregation of resources with DS Zones

DS Zones provide virtual segregation of data center resources, including appliances, target devices and virtual machines. You can manage the users, licenses and authentication services assigned to each zone, and transfer units among zones.

System Components

The DSView 3 software system contains the following components.

DSView 3 management software

The DSView 3 software resides on the DSView 3 server (host or hub computer) and provides a web gateway and services for managing units (appliances and target devices) using a web browser. The gateway allows for IP-based video, serial management, Telnet Viewer, third party Telnet viewer, web browser and other supported session types.

Users may connect to the DSView 3 server from DSView 3 software clients and use the DSView 3 Explorer windows to communicate with the system.

DSView 3 server

The DSView 3 server contains the DSView 3 management software. The server provides a centralized database for storing configuration, user, unit and system information. It also provides services for authentication, access control, logging events, monitoring and license management.

You may configure one or more spoke (backup) servers in addition to the hub server. The hub server is responsible for maintaining the master copy of the database in a DSView 3 software system. Only one server in a DSView 3 software system may be configured as the hub server.

Spoke servers perform database replication with the hub server. The hub server acts as the coordinator for database replication between itself and all of the other spoke servers in a DSView 3 software system. A hub server and a spoke server both offer the same DSView 3 software functionality to a user. The distinction of hub or spoke refers only to the database replication role that the server plays and not with the functionality that the server provides. Adding one or more spoke servers to a DSView 3 software system provides redundancy and the ability to distribute DSView 3 software functionality across multiple sites.

After the hub server and optional spoke server(s) are configured, you may create and configure the type of access levels for users within your network environment. You may also set up event logs to record full details of user access and other events.

DSView 3 software client

A DSView 3 software client is a computer with a web browser that can access the DSView 3 management software installed on the DSView 3 server.

Third party products

Third party products are not a part of the DSView 3 software, but are supported for use with it.

External authentication servers - An external authentication server enables the DSView 3 server to broker authentication requests from users requesting access to the DSView 3 software system.

SNMP managers - The SNMP (Simple Network Management Protocol) manager monitors the managed appliances and receives SNMP traps from the DSView 3 software on the server. An example of an SNMP manager is the HP OpenView product.

Third party Telnet viewers - A third party Telnet viewer may be used for serial sessions instead of the DSView 3 software Telnet Viewer.

Third party session software - Third party software such as RDP or VNC, when properly installed and configured on the target device, may be enabled for use within the DSView 3 software for initiating sessions with the target device. At the beginning of a session, the RDP viewer allows users to map local resources for use with virtual media.

NOTE: RDP is only available on supported Windows system clients.

Partner products

Environmental monitoring with Uptime Devices

DSView 3 software can help you access Uptime Devices SensorHub environmental monitoring equipment so you can quickly detect environmental conditions (equipment to track temperature, humidity, airflow, water, voltage and contact closures) that could adversely affect operation of servers and other network devices. Visit www.uptimedevices.com for ordering information.

Proactive Network Security with NetClarity Auditor Enterprise

Integrate NetClarity Auditor Enterprise with the DSView 3 software and manage one or more Auditor appliances to alert, block and correct critical IT security and compliance problems in your data center and entire enterprise network. Visit www.netclarity.net for ordering information.

Avocent DSView 3 Connector for HP® Software

The DSView 3 Connector for HP Software extends the capabilities of HP Software Network Node Manager (NNM) and Operations for Windows (OVOW). Seamless access and control allows critical management functions for dispersed IT environments. Out of band connectivity offers solutions for lights out data centers and ensures quick and efficient troubleshooting and repair from the HP console.

Supported Units

For management functions, the DSView 3 software client uses HTTPS (Hypertext Transfer Protocol with SSL encryption) to send a request to the DSView 3 server, which then sends a command to the managed appliance. The appliance then performs the requested function.

The DSView 3 software supports the managed appliances listed in this section. Other appliances may be supported by plug-ins; see the Avocent web site, www.avocent.com, for a list of plug-ins that may currently ship with the DSView 3 software and/or that can be added to the DSView 3 software. See *Plug-ins* on page 349 for information about adding and managing plug-ins in the DSView 3 software system.

Cyclades® ACS advanced console server

ACS advanced console servers allow users to access serially attached devices over a standard TCP/IP connection using the Avocent Telnet Viewer, a third party Telnet viewer or a Secure Shell (SSH) client. These serial sessions can be shared among multiple users across multiple DSView 3 servers. For more information, see the ACS console server plug-in documentation.

DSView 3 Mobile software

DSView 3 Mobile software plug-in extends DSView 3 data center solutions to enable management of Windows servers from a handheld device. Licenses may be required; see your Avocent representative or www.avocent.com for more information.

LANDesk® Server Manager

The DSView 3 management software plug-in for LANDesk Server Manager allows you to access the LANDesk Server Manager and its target devices from within the DSView 3 software. This integrated system provides complete life cycle and systems management for multiplatform server infrastructures. Use the browser-based software to manage server performance and availability, and launch sessions to target devices from a single point of access.

LANDesk Server Manager supports rack-mounted and blade servers with low-impact services that let users choose the level of management coverage – from device discovery to extended

performance analysis, security and configuration control. It enables enterprises to take inventory, provision, patch, monitor and instantly assess server health and ensure optimum availability.

DSR® switches

DSR switches allow KVM signals to be transmitted over a standard TCP/IP network connection. Some DSR switches may be connected using a modem, which provides benefits for branch offices such as low cost and dial-up performance.

The DSView 3 software supports the following DSR switch models:

800, 1010, 1020*, 1021*, 1022*, 1024*, 1030*, 1031*, 1161, 2010, 2020*, 2030*, 2035*, 2161, 4010, 4020*, 4030*, 4160, 8020*, 8030*, 8035*

*These models contain a dedicated serial port for connecting an external modem for use with the DSR Remote Operations software.

For DSR switches, a target device is first attached to an IQ module, which is then attached to a DSR switch. DSView 3 software clients communicate with target device ports using a Video Viewer connection between the client and the managed appliance.

The DSR switches allow the cascading of legacy analog KVM switches from DSR switch ports, which may be managed in a DSView 3 software system. Certain DSR switch models also allow the cascading of another switch. For more information, see the DSR Switch Installer/User Guide.

NOTE: PEM cascade devices are not supported.

MergePoint® 52xx service processor (SP) manager

The MergePoint 52xx service processor manager is a secure, centralized enterprise management solution for target devices equipped with IPMI, HP iLO and Dell DRAC service processors. You can use the DSView 3 software to access, monitor and control the MergePoint 52xx SP manager and attached target devices.

The MergePoint 52xx SP manager provides a standardized interface independent of the management protocols used to manage each target device. Management operations can be performed either by using commands or scripts over a Telnet or SSH version 2 session or by using the appliance's web interface from a standard web browser.

For more information, see the MergePoint 52xx appliance plug-in documentation.

Cyclades OnSite branch office appliance

OnSite branch office appliances may be used to access multiple traditional or headless servers, networking devices, infrastructure components or any other device with a serial console or KVM port. You can use the DSView 3 software to access, monitor and control the OnSite appliance and attached target devices. For more information, see the OnSite appliance plug-in documentation.

Virtual environments

The DSView 3 management software plug-in for Virtualization allows you to access and control virtual machines from the DSView 3 software. Supported unit types include VMware®

VirtualCenters, ESX Servers and virtual machines, as well as Citrix® XenServers™ and virtual machines. You can launch a Virtual Network Computing (VNC), Remote Desktop (RDP), Secure Shell 2 (SSH) or VMware viewer session to supported virtual machines from a single point of access. For more information, see the Virtualization plug-in documentation. Licenses may be required; see your Avocent representative or www.avocent.com for more information.

Blade chassis

The DSVIEW 3 software plug-in for Blade Chassis allows you to access multi-vendor blade chassis and blades from the DSVIEW 3 software. You can launch a KVM session to any managed blade from a single point of access. For a list of supported blade chassis and other information, see the Blade Chassis plug-in documentation.

Generic appliances

Generic appliances manage data center devices such as routers. These devices may be managed within a DSVIEW 3 software system by launching a standard web browser to the device URL or by opening a Telnet session.

Embedded units

Using the DSVIEW 3 software, you may add/delete, configure/display properties, and launch video sessions to the following versions of third party embedded units:

- IBM® ASM (Advanced System Management) RSA II (Remote Supervisor Adapter II) - Version 5, Build GRE132AUS
- DRAC 4 (Dell™ Remote Access Controller) - Version 1.0, Build 06.14
- HP iLO (Integrated Lights-Out) - Version 1.20
- NEC IPF (Itanium Processor Family) - Version 0.5.1.20

For management functions (other than launching video sessions) that are not performed by the DSVIEW 3 software, see the documentation for the unit.

Legacy units

The following legacy units are supported in the DSVIEW 3 software.

- DSI5100 IPMI proxy appliances
- EVR1500 environmental monitors
- DS1800 digital switches
- AutoView® 200-4, 200-8, 400-4, 400-8, 416, 424 and 2000-AM switches (these switches must be Flash upgraded to be added to a DSVIEW 3 software system)
- OutLook® 140ES, 180ES, 280ES, 1160ES, 2160ES and 4160ES switches
- Cyclades KVM/net KVM over IP switches
- Cyclades KVM/net Plus KVM over IP switches
- Cyclades TS appliances

- CCM console management appliances
- CPS810 and 1610 serial over IP network appliances

Target devices

Target devices encompass a wide range of data center components such as servers and routers that a DSView 3 software administrator may manage virtually through the DSView 3 software system. A target device is added automatically to your DSView 3 software system when the supported managed appliance is added. A target device may also be added individually.

Power devices

A power device is a type of target device that can be cascaded from a managed appliance.

When a DSView 3 software client sends a power control request to a target device, an HTTPS request is sent to the DSView 3 server, which then sends a command to the managed appliance. The command is converted and serially sent to the power device. The power device then performs the requested action (for example, turning a power outlet on or off).

The DSView 3 software supports the following power devices:

- Avocent SPC power control devices
- Server Technologies Sentry Switched CDU CW-8H1, CW-8H2, CW-16V1, CW-16V2, CW-24V2, CW-24V3, CW-32VD1 and CW-32VD2 (supported models may change; contact Avocent Technical Support for current information)
- Cyclades® Power Distribution Units (AlterPath® PM devices)

All of the above power devices are supported on DSR switches that contain one or more SPC ports. Avocent and Server Technologies power devices are also supported on CCM and CPS appliances.

System Configuration

Figure 1.1 illustrates an example system configuration using the DSView 3 management software. For information about the TCP ports that the DSView 3 software uses, see *TCP and UDP Ports* on page 356.

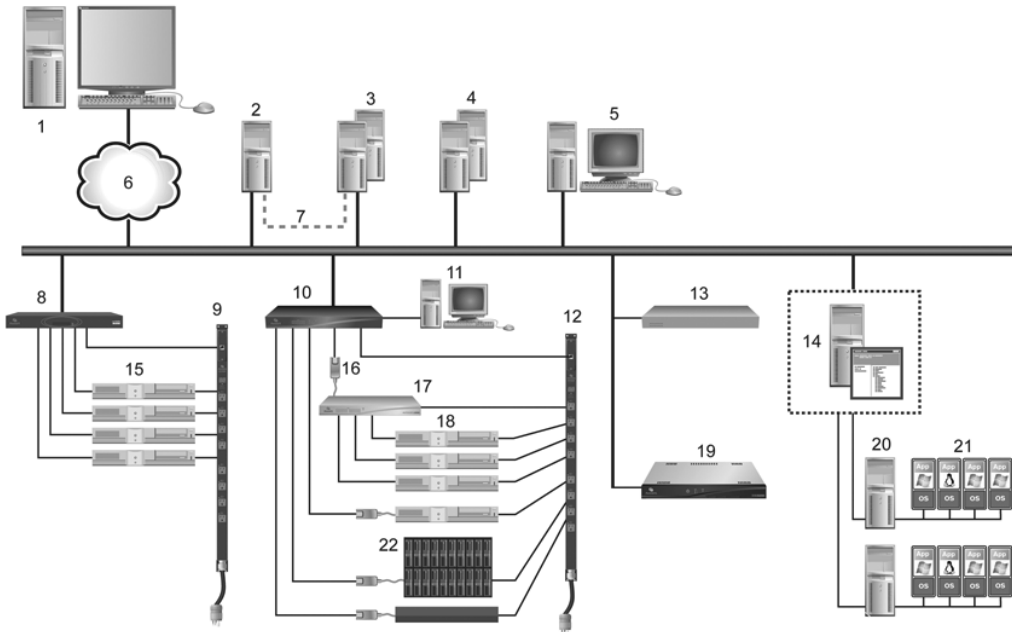

Figure 1.1: Example System Configuration

Table 1.1: DSView 3 Software System Configuration Descriptions

Number	Description	Number	Description
1	DSView 3 Software Client	12	Power Device
2	Hub DSView 3 Software Server	13	Generic Appliance
3	Spoke DSView 3 Software Servers (Optional)	14	Hypervisor Manager
4	External Authentication Servers (Optional)	15	Target Device
5	SNMP Manager (Optional)	16	IQ Module
6	TCP/IP	17	Cascade Switch
7	Replication	18	Target Devices
8	ACS Advanced Console Server	19	MergePoint SP Manager
9	Power Device	20	Hypervisor Server
10	DSR Switch	21	Virtual Machines
11	OSCAR® Interface	22	Blade Chassis

Installation

This chapter describes the following installation sequence:

- What you should do before installing the DSView 3 software
- Installing the DSView 3 software
- Configuring the DSView 3 software, plus considerations when upgrading
- Running the DSView 3 software, that is, start a client session

Final sections describe how to change your password, uninstall the software, end a DSView 3 software session and install Java.

About Installation

When the DSView 3 management software is installed, the DSView 3 software database and a hub server are also installed on the dedicated server.

The DSView 3 software may be installed on a computer containing an existing DSView 2.x software authentication server without causing any interference with the operation of the DSView 2.x software system. The DSView 2.x software authentication server and the DSView 3 software may run on the same dedicated server at the same time.

Rebooting the dedicated server is not required prior to using the DSView 3 software.

Once the DSView 3 software is installed and you have configured the hub server, users may log in at another computer as a DSView 3 software client, using a supported web browser.

You may also install the DSView 3 software on additional computers and configure them as spoke servers. See *Spoke Servers* on page 72 and *Installing the DSR Remote Operations Software* on page 21.

NOTE: A license key permits the operation of the DSView 3 software on the dedicated server. The license key also specifies the number of clients that may use the software and the number of spoke servers allowed on a system. See *Licenses* on page 54.

Minimum requirements for the DSView 3 software

The following are the minimum requirements for installing the DSView 3 software on a dedicated hub server or a computer that will function as a DSView 3 software spoke server:

- For supported Windows and Linux systems: 2 GHz Pentium or equivalent processor
- For supported Solaris systems: 1 GHz UltraSparc III processor
- 4 GB of RAM - additional memory may be needed, depending on the number of plug-ins installed and appliances supported
- 100BaseT NIC (1GByte LAN recommended)
- 10 GB of free disk space - additional disk space may be required for data logging and plug-ins
- One of the following operating systems:
 - Windows[®] 2000 Server or Advanced Server with the latest service package
 - Windows Server[®] 2003 Standard, Enterprise and Web Edition
 - Windows Server 2008 Standard, Enterprise and Datacenter Edition
 - Windows Web Server 2008
 - Red Hat[®] Enterprise Linux, Version 4 (AS, ES and WS products)
 - Red Hat Enterprise Linux, Version 5
 - Sun[®] Solaris[™] SPARC 9 and 10
 - Novell[®] SUSE[®] Linux (x86) Enterprise Server 9 or 10

NOTE: The DSVIEW 3 software is also supported on any of these operating systems running as a guest OS in a virtual environment. However, while the DSVIEW 3 software is expected to function properly on a guest OS in the virtual environment, there may be unknown performance implications.

Before installing and configuring the DSVIEW 3 software

Before installing the DSVIEW 3 management software, install the managed appliance hardware.

If the computer will be a hub server, you will need the license key obtained from Avocent and provide a username and password to use for initial log in.

If the computer will be a spoke server, you will need to identify the associated hub server and provide the name/password of the hub server's DSVIEW 3 software administrator.

To prevent potential mouse conflicts, you may configure certain settings on each server connected to a KVM switch or serial console appliance. For details, see the Mouse and Pointer Settings Technical Brief, which is available on the DSVIEW 3 software DVD and on the Avocent web site.

Installing the DSVIEW 3 Software

The DSVIEW 3 management software may be installed using the DSVIEW 3 software DVD or by downloading the software in a self-extracting .zip file from the Avocent web site.

NOTE: If you are upgrading the DSView 3 software from a previous version, it is strongly recommended that you perform a database synchronization between the hub and spoke servers; see *Replication* on page 75. You should also back up the hub server prior to upgrading the DSView 3 software; see *Backing up and Restoring Hub Servers Manually* on page 69. Failure to perform synchronization and backup may have detrimental effects. A backup should be performed both before the upgrade and immediately following the upgrade.

To install the DSView 3 software on a supported Windows system:

1. Log on to the dedicated server as Administrator.
2. To install from a DVD:
 - a. Insert the DSView 3 software DVD. An autorun file opens a menu of installation options.
 - b. Click *Install DSView 3 Software*.

-or-

If autorun is not enabled, type **<drive:>\DSView\win32\setup.exe**, where <drive:> is the letter of your DVD drive.

A dialog box will indicate that the server will be verified to ensure it meets the minimum requirements for installing the DSView 3 software.

To install from a downloaded file:

 - a. Using your web browser, download the DSView 3 software from the Avocent web site. Go to www.avocent.com and click the *Support* link. On the Technical Support page, click the *Product Upgrades* link, then select *DS Software Upgrades*.
 - b. Double-click on the downloaded installation package (setup.exe). A dialog box will indicate that the server will be verified to ensure it meets the minimum requirements for installing the DSView 3 management software.
3. If the current or an earlier version of the DSView 3 software is already installed, the Installed Product Found: Same Version message box will appear. Click *OK* to reinstall the DSView 3 software or *Cancel* to exit setup.
4. The Check for an UPDATED version window will open. (If the DSView 3 software is already installed on the dedicated server, a message box will display. Click *OK* to close the box.)
 - a. Click *Next* to reinstall the software, or click *Cancel* to stop the reinstallation.
 - b. Click *Check for UPDATES* and then click *Next* to check the Avocent web site for the most recent DSView 3 software installation package. Go to step 5.

-or-

Click *Next* to install the DVD or downloaded version of the DSView 3 software. Go to step 6.
5. If a newer version of the DSView 3 software is found, an Update Available message appears.
 - a. Click *OK* to download the latest DSView 3 software installation package. The installation will be cancelled and the server's default web browser will launch and open in the Product Upgrades and Options page of the Avocent web site.

-or-

Click *Cancel* to resume installation of the older version of the DSView 3 software. Go to step 6.

- b. Type your email address and password, and then click *Submit* to log in to the web site.
 - c. Download the DSView 3 software installation package, log out and close the web browser. Return to step 2.
6. The Introduction window will open. Click *Next*.
 7. The License Agreement window will open.
 - If you accept the terms, click *I accept the terms of the License Agreement* and then click *Next*. Go to step 8.
 - If you do not accept the terms, click *I do NOT accept the terms of the License Agreement*. A License Agreement Warning message box will appear.
 - If you click *Quit*, the installation will exit without installing the DSView 3 software.
 - If you click *Resume*, you will be returned to the License Agreement window.

The DSView 3 software license agreement may also be viewed from the User Login window by clicking the *Avocent DSView 3 End User License Agreement* link. The agreement will appear in a separate web browser window.

8. If the default TCP port used by the dedicated server hosting the DSView 3 software (TCP port 443) is not available, the Define Web Application Server TCP port window will open. Type the port you want to use in the TCP port # field, then click *Next*. (Clicking *Cancel* exits the Checking for an Updated version installation program.)
9. If the default TCP port used by the Avocent proxy server (TCP port 1078) is not available, the Define TD (target device) Session Viewer Proxy TCP port window will open. Type the port you want to use in the TCP port # field, then click *Next*.
10. If the default ports used by the SSH server and the Syslog server for data logging are not available, appropriate windows will open. Type the port you want to use, then click *Next*.
11. The Choose Destination Location window will open.
 - a. Click *Choose* and use the Browse for Folder dialog box to select a directory in which to install the DSView 3 software.
-or-
Click *Restore Default Folder* to restore the installation directory to the default (C:\Program Files\Avocent DSView 3).
 - b. Click *Install*.

The Installing... window will open and display the progress of the installation. The software will be installed in the specified folder, a Start - *Programs* - *DSView 3* shortcut menu will be generated and the DSView 3 software service startup will be verified.

If a previous version of the DSView 3 software already exists on the dedicated server, message boxes may appear, prompting you to confirm overwriting existing files. Click *Yes to All*.

12. When the software has finished installing, the Successful Service Startup message box will appear. Click *Continue*.
13. The Installation Complete window will open.
 - To begin configuration of the DSView 3 software, click *Done*; see *Configuring the DSView 3 Software* on page 14. A Security Alert dialog box will appear containing certificate information and a warning that the generator of the certificate is not trusted. This occurs because the DSView 3 server certificate created when the server is installed is a self-signed certificate. You may either import the certificate into the DSView 3 software client web browser (choosing to trust the certificate) or obtain a server certificate from a Certificate Authority (CA) trusted by the web browser.
 - To configure the DSView 3 software at a later time, click *X (Cancel)* in the top right corner of the window.

To install the DSView 3 software on a supported Linux or Solaris system:

1. Log in to the server as root.
2. Insert the DSView 3 software DVD into your DVD drive. If AutoMount is supported and enabled, open a command window and continue with step 3.

If your system does not support AutoMount, issue the following command to mount the DVD volume: **mount <device> <mount point>**, where <device> and <mount point> are the names of your server's DVD Linux or Solaris device and mount point directory, respectively.

For example, to mount the first IDE cdrom on /media/cdrom, enter the command:

```
mount /dev/cdrom /media/cdrom
```

3. Enter the following command to access the readme file:

```
less /<mount point>/DSView/readme
```

For example, the following command accesses the readme file on the /media/cdrom mount point.

```
less /media/cdrom/DSView/readme
```

4. Follow the instructions in the readme file.

Upgrading the DSView 3 Software

When upgrading to a newer version of the DSView 3 software, all DSView 3 servers should be upgraded at the same time. The DSView 3 hub server should be upgraded first, followed by each spoke server.

Before upgrading, a replication should be performed (see *Replication* on page 75), then a backup immediately before and after upgrading the DSView 3 software (see *Backing up and Restoring Hub Servers Manually* on page 69).

The firmware for the appliances may also need to be upgraded in order to support new functionality in the DSView 3 software. The DSView 3 software should work with the existing firmware

revisions, but in cases where new functionality is not supported until the firmware is upgraded, the DSView 3 software will indicate this in the GUI.

Recommended upgrade process

NOTE: In order to safely upgrade the DSView 3 software, and to provide for a roll-back path in case of upgrade failures, perform each of the following steps. If your DSView 3 configuration does not include spoke servers, skip steps that refer to spokes.

To upgrade the DSView 3 software:

1. Ensure that you are able to upgrade the hub server and any spoke servers during the same upgrade time. The expected time to perform this procedure is 30 minutes. However, due to differences in DSView 3 configurations and amounts of data, your time may vary.
2. Verify that the installer files for both the new and old versions (in case recovery is needed) are available to you.
3. Perform a replication of all spoke servers. See *Replication* on page 75.
4. Backup all hub and spoke servers. See *Backing up and Restoring Hub Servers Manually* on page 69. It is advised that all DSView 3 backup files be stored on an external device or network drive.
5. Verify basic functionality by navigating to a few DSView 3 windows and launching sessions to a few target devices.
6. Run the DSView 3 installer for the new version on the hub server.
7. Run the DSView 3 installer on all spoke servers.

NOTE: The hub server must be upgraded prior to the upgrading the spoke servers.

8. Verify basic functionality again by navigating to a few DSView 3 windows and launching sessions to a few target devices.
9. Perform another backup of the hub and spoke servers to have a baseline database of the upgraded environment. See *Backing up and Restoring Hub Servers Manually* on page 69.
10. Run replication to validate that there are no errors. Errors will either be displayed in the status panel for the replication task or in the Events Log. See *Replication* on page 75.
11. The firmware for the appliances may also need to be upgraded in order to support new functionality in the DSView 3 software. See *Upgrading firmware* on page 314.
12. Verify basic functionality one last time by navigating to a few DSView 3 window and launching sessions to a few target devices.

Configuring the DSView 3 Software

After the DSView 3 software has been installed, it must be configured using a web browser.

During configuration, you specify whether the computer will be a hub server or a spoke server. If this is your first DSView 3 server installation, *hub* should be selected in the Select DSView Server Role window. The hub server should be installed before any spoke servers are added.

What you will need

If the computer will be a hub server, you will need the license key obtained from Avocent and provide a username and password to use for initial log in.

If the computer will be a spoke server, you will need to identify the associated hub server and provide the name/password of the hub server's DSView 3 software administrator.

To configure the DSView 3 software:

1. If you are configuring the DSView 3 software during the installation process, you have already clicked *Done* in the Launch Default Browser window.
If you quit after installing the DSView 3 software installation process (by closing the window), select *Start - Programs - Avocent DSView 3 - DSView Software*.
2. A security alert box will appear containing certificate information. See *Certificates* on page 46.
3. The Select DSView Server Role window opens.
 - Click *Hub* to assign the dedicated server as the hub server, then click *Next*. Go to step 3.
 - Click *Spoke* to assign the dedicated server as a spoke server, then click *Next*. Go to step 8.
4. The Type in Master License Key window opens. Type the Avocent-provided license key for the DSView 3 software hub server, then click *Next*. (DSView 3 software license keys prior to version 3.0 are not valid.)
If you did not receive a license key, click the <http://www.avocent.com/activation> link to obtain a license key.
If the entered license is already in use on another server, a license violation will occur when you log in, and you must configure the server as a spoke server.
5. The Type in Initial Administrator Account window opens. Type a username, a password and confirm the password of the user to whom you wish to give administrator privileges. Usernames are case sensitive and may contain up to 64 characters. Click *Next*.
6. A Request in Progress message will appear. The license key will be installed and a DSView 3 software administrator account will be created. The built-in user groups will also be created.
7. The Completed Successful window will open when configuration is completed. Click *Finish*.
8. The User Login window will open in the DSView 3 Explorer.

You may now log in using the username and password specified during configuration.

If you chose to configure the server as a spoke server in the Select DSView Server Role window or if you entered a duplicate software license key in the Type in Master License Key window, continue with the following steps.

NOTE: The DSVIEW 3 software versions of the spoke server and the hub server must match in order to register the spoke server. For example, you may not register a spoke server running DSVIEW 3 software version 3.0 with a hub server running DSVIEW 3 software version 3.2.

9. The Type in Hub Server Address and Port window will open. Type the address of the DSVIEW 3 software hub server using standard dot notation (xxx.xxx.xxx.xxx) or type the DNS name in the Address field. Click *Next*.
10. The Accept DSVIEW Server Certificate window will open. Click *Next* to accept the certificate.
11. The Type in Hub Administrator Credentials window will open. Type a valid username and password for a user with DSVIEW 3 software administrator privileges on the DSVIEW 3 software hub server. Click *Next*.
12. The Registering Spoke Server window will open with the message *Request In Progress Please Wait* The configuration of the spoke server will be saved to the database of the hub server and the spoke server's certificates will be installed on the hub server.
13. The Completed Successful window will open when the spoke server has been added. Click *Finish*.

Running the DSVIEW 3 Software

DSVIEW 3 software clients access the DSVIEW 3 management software host using a supported web browser. Any software required by the client, such as applets and the Java Runtime Environment (JRE), will be automatically installed by the DSVIEW 3 server host.

The DSVIEW 3 software uses Secure Sockets Layers (SSL) encryption to send data between the DSVIEW 3 software host and the web browser on the client to ensure data integrity and privacy. When a user attempts to log in to a DSVIEW 3 software client session, the authentication service configured in the DSVIEW 3 software by the DSVIEW 3 software administrator verifies the credentials of the user. Security alerts related to the certificates on the DSVIEW 3 software host may appear. See *Certificates* on page 46.

Minimum client requirements

The following are the minimum requirements for a DSVIEW 3 software client:

- 1 GHz Pentium or equivalent processor
- 512 MB of RAM
- 10 or 100BaseT NIC (100 recommended)
- XGA video with graphics accelerator
- Desktop size setting of at least 800 x 600
- Color palette of at least 256 colors
- One of the following operating systems:
 - Windows 2000 Workstation, Server or Advanced Server with the latest service package
 - Windows XP Home Edition or Professional

- Windows 2003 Server Standard, Enterprise or Web Edition
- Windows Vista Ultimate or Business
- Red Hat Enterprise Linux, Version 4 (AS, ES and WS products)
- Red Hat Enterprise Linux, Version 5
- Sun Solaris SPARC 9 and 10
- Novell SUSE Linux (x86) Enterprise Server 9 or 10
- Macintosh OS X version 10.4 and later
- Adobe® Flash Player version 9.0 or later
- One of the following browsers:
 - Microsoft® Internet Explorer 6 or 7
 - Firefox® 2 or 3

Install the latest updates and service packs available for your browser.

If you are using Firefox, the Video Viewer and the Telnet Viewer clients require Java; see *Java Installation* on page 19.

Opening a client session

Before opening a client session

- Enable cookies and JavaScript on the client's web browser.
- Configure the web browser. If you are using Internet Explorer, see *Internet Explorer Considerations* on page 42.

To open a client session:

NOTE: If DSView 3 Software Client Certificate Authentication or DSView 3 Software Client Integrated Windows Authentication is being used, the user will not be required to log in. See *Certificates* on page 46.

1. From the DSView 3 software client web browser, enter the URL of the server host in the address bar in the format:

https://<servername>/dsview

In this case, <servername> is the DNS name of the host system, or the IP address in standard dot notation (xxx.xxx.xxx.xxx).

NOTE: To avoid multiple security warnings, enter the DNS name.

-or-

If you are opening the session on the DSView 3 server, you may select *Start - Programs - Avocent DSView 3 - DSView Software*.

2. Accept all security alerts that may appear as the client computer connects to the DSView 3 server. The DSView 3 Explorer User Login window will open.

If an RSA SecurID external authentication service has been added to the DSView 3 software, see *RSA SecurID login* below for the login procedure.

3. Type a valid username and password in the fields provided.

Depending on the settings specified by the administrator, you may be required to change your password before being allowed to complete the login process. See *Adding User Accounts* on page 231.

4. Click *Login*. The window that appears depends on the rights assigned to the DSView 3 user that is logging in.

If the client machine uses an onboard video controller and experiences video problems, be sure the BIOS is updated to the latest version.

RSA SecurID login

When an RSA SecurID external authentication service has been added to the DSView 3 software, the login credentials include a username and a passcode. The passcode includes a PIN and an RSA SecurID tokencode. The login request is sent to the RSA Authentication Manager. Depending on the user configuration and state on the RSA Authentication Manager, the user may be prompted for a second successive tokencode.

The user configuration also specifies how the 4-6 digit PIN will be generated:

- User defined - the user must enter a PIN
- System generated - the user cannot enter a PIN; it must be generated by the RSA server
- User selectable - the user may choose to enter a PIN or allow the RSA server to generate it

If a PIN has not yet been assigned to the user or if security policy requires a PIN change, the user will be prompted accordingly. If the RSA server generates the PIN, the user will be given a brief interval to memorize it.

Regaining access

If access to a DSView 3 software system is lost, see *Regaining Access to the DSView 3 Software* on page 389.

Uninstalling the DSView 3 Software

To uninstall the DSView 3 software on a supported Windows system:

1. Select *Start - Settings - Control Panel*. The Control Panel will appear.
2. From the Control Panel, click *Add/Remove Programs*. The Add/Remove Programs dialog box will appear.
3. Select *Avocent DSView 3* and then click *Change/Remove*. The Uninstall Avocent DSView window will open.
4. Click *Uninstall*.

To uninstall the DSView 3 software on a supported Linux or Solaris system:

1. Log in to the server as root.
2. Insert the DSView 3 software DVD into your DVD drive. If AutoMount is supported and enabled, open a command window and continue with step 3.

-or-

If your system does not support AutoMount, issue the following command to mount the DVD volume: **mount <device> <mount point>**, where <device> and <mount point> are the names of your server's DVD Linux or Solaris device and mount point directory, respectively.

For example, to mount a DVD which is the second IDE unit on /media/cdrom, enter the command:

```
mount /dev/cdrom /media/cdrom
```

3. Enter the following command to access the readme file.

```
less /media/cdrom/DSView/readme
```

Follow the instructions in the readme file.

Closing a DSView 3 Software Session

Files are copied to DSView 3 software clients when you log in to the DSView 3 software. When using Internet Explorer, temporary files may be removed by selecting the *Delete Temporary Internet Files* command and active web components may be uninstalled by selecting the *Remove Objects* command. See the Internet Explorer documentation for more information.

To close a DSView 3 software session:

From the DSView 3 Explorer, click *LOGOUT* or the logout icon.

Java Installation

On non-Windows clients, the Video Viewer, Telnet and VNC Viewers require Java version 1.5. The Telnet/SSH applet may work with other versions; the Video Viewer requires that version.

On Windows clients, Java is required to run the Avocent Telnet/SSH Viewer. If the Win32 PuTTY Telnet/SSH Viewer is selected in the user's profile, then Java is not required on the client. On a Windows client, it is recommended that the JRE (Java Runtime Environment) be installed in the C:\Program Files\ location. If your system automatically installs programs in another location, you may not be able to launch the Video Viewer. In this case, you can configure Java to find the JRE.

To configure Java to find the JRE:

1. Access the Java Control Panel.
2. Select the *Java* tab.
3. In the Java Application Runtime Settings panel, click *View*.
4. Change the path to the installed JRE.

5. Click *OK*.

For Windows, Linux and Solaris operating systems, the DSView 3 software client automatically downloads and installs the JRE the first time it is needed. For Macintosh operating systems, you must update Java and install the JRE using the Macintosh software updates. Refer to the Macintosh operating system documentation for more information.

To install the JRE on a Windows client:

1. In a DSView 3 software Units View window (see *Accessing Units View windows* on page 106), click an Action link.
2. A window will open, containing a link for downloading the JRE installer. Download the JRE installer, then close all browser windows.
3. Click on the JRE icon to launch the installer.
4. Restart the browser, and click an Action link.

To install the JRE on a Linux or Solaris client:

NOTE: Only one version of the JRE can be installed in the browser for DSView 3 software support. Depending on your system's configuration, you may have to log in as the root user to install the JRE. Contact your system administrator if you need help with installing software as the root user.

1. In a DSView 3 software Units View window (see *Accessing Units View windows* on page 106), click an Action link.
2. A window will open, containing a link for downloading the JRE installer. Download the JRE installer, then close all browser windows.
3. Run the installer.
4. Restart the browser, and click an Action link.

Avocent Viewer Plug-in Installation

On Windows clients, the Video Viewer, Telnet and VNC Viewers require the Avocent Viewer Plug-in. If you are using Firefox 2 or Internet Explorer, the plug-in downloads automatically from the browser window. If you are using Firefox 3, additional set up is required.

To install the Avocent Viewer Plug-in when using Firefox 3 on a Windows client:

1. In a Units View window containing the target device you want to access (see *Accessing Units View windows* on page 106), click an Action link.
2. The Installing Avocent Viewer Plug-in pop-up window opens. Click *Download Avocent Viewer Plug-in*.
3. Click *Save*, then open the saved file. The Firefox downloads window opens.
4. Click *OK*, then follow the instructions in the installer wizard to install the file.

Once the installation is complete, the viewer session starts automatically.

Installing the DSR Remote Operations Software

NOTE: Installing and using the DSR Remote Operations software is optional.

If your DSView 3 software system includes DSR1021, 1022, 1024, 1020, 1030, 1031, 2020, 2030, 2035, 4020, 4030, 8020, 8030 or 8035 switches, you may use the DSR Remote Operations software for switch access using a dial-up point to point protocol (PPP) modem connection when an Ethernet connection is unavailable.

See *DSR Remote Operations Software* on page 364 for information about installing and using the DSR Remote Operations software.

CHAPTER

3

DSView 3 Explorer Windows

When a user has been logged in and authenticated, the Avocent DSView 3 Explorer window opens. From the DSView 3 Explorer window, you may view, access and manage units.

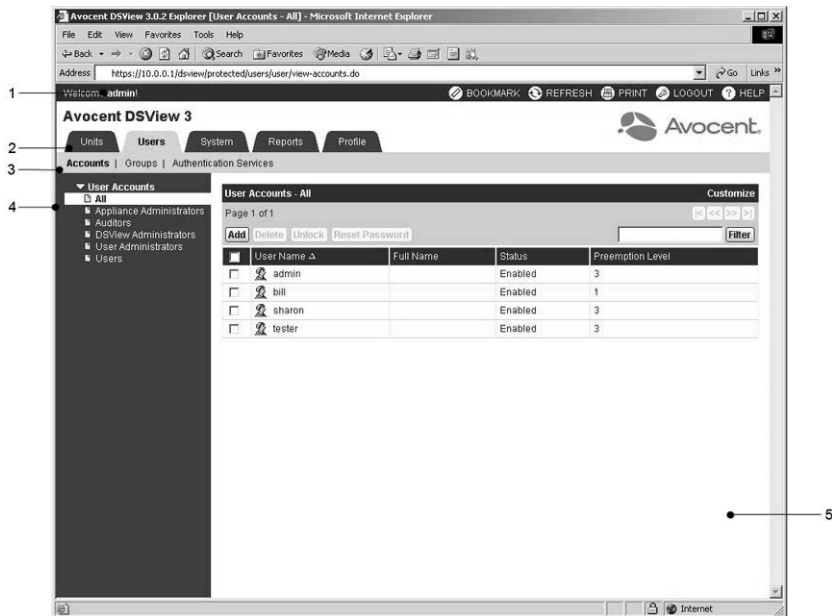

Figure 3.1: Example Avocent DSView 3 Explorer Window Areas

Table 3.1: DSView 3 Explorer Window Area Descriptions

Number	Description
1	Top option bar - Use the top option bar to bookmark a DSView 3 software window, refresh a window display, print a page, log out of a software session or access online help. The name of the logged in user appears on the left side of the top option bar.
2	Tab bar - Use the tab bar to display and manage units, user accounts, reports, system settings and session profiles.
3	Top navigation bar - The selections in the top navigation bar vary, depending on the active tab in the tab bar. Topics relevant to each selection display in the side navigation bar.
4	Side navigation bar - Use the side navigation bar to select system information to display or edit in the content area. The side navigation bar contains arrows that affect its display.
5	Content area - The information specified by the tab bar, top navigation bar and side navigation bar selections is displayed and changed in the content area.

Accessing Target Devices

Target devices (TDs) that may be accessed system-wide are displayed in a Units View window. You may initiate a session with a target device from a Units View window by clicking the link in the Action column. See *Units View Windows* on page 103.

You may also initiate a session with a target device from a Unit Overview window. See *Unit Overview Windows* on page 112.

For information about controlling the power of target devices attached to power devices, see *Power Control of Devices Attached to Power Devices* on page 169.

Using the Side Navigation Bar

The side navigation bar is used to display windows that specify settings or perform operations. The contents of the side navigation bar varies, depending on the tab and top navigation bar selections and the window that is displayed.

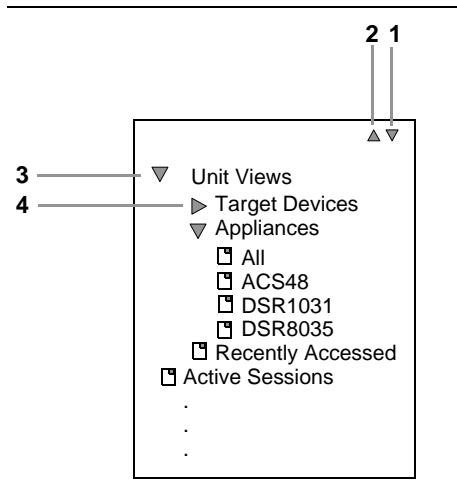

Figure 3.2: Example Side Navigation Bar

Table 3.2: Side Navigation Bar Descriptions

Number	Arrow	Description
1	▼	Expand All Nodes - Click this arrow in the upper right corner to expand all nodes and display additional links.
2	▲	Collapse All Nodes - Click this arrow in the upper right corner to collapse all nodes and their links.
3	▼	Collapse Node - Click this arrow to collapse an opened tree branch and its links.
4	▶	Expand Node - Click this arrow to expand a closed tree branch and display its links.

You may choose whether an expanded node will collapse when another Expand Node arrow is selected. See *Changing user options* on page 36.

Clicking on a link that does not contain an arrow will display its corresponding window. Some windows contain additional links, which may display another window and a side navigation bar with different content.

Using Windows

Sorting information in a window

The order of rows in a list may be changed by clicking the heading of one of the displayed columns. When you click a column heading, the order of the list rows will change to alphabetically ascending, based on that column. If you click the column heading a second time, the order will change to an alphabetically descending order. An up arrow indicates ascending order and a down arrow indicates descending order.

If you are using the topology feature in a Units View window, see *Topology view* on page 104 for sorting criteria.

Filtering information in a window

Some DSView 3 software windows allow you to filter list information by providing a text string that will be used to retrieve matching items. Filtering is useful if you have many target devices or other items that extend over many pages. Windows that allow filtering contain a text field and a Filter button in the content area, as shown in Figure 3.1 on page 23.

Filtering is performed either over the entire list of items or of specified columns, and can provide a shorter, more exact list of items. When filtering is performed, each row and column is searched for the specified text string. For example, you may wish to perform filtering to list only DSR1031 switches in the Name column, target devices with KVM connections in the Action column, idle ACS console servers in the Status column and so on. Additionally, from a Units View window, you can use the *Custom Fields and Filter* link to exclude columns from the filter and provide a more exact list of filtered items. See *Using the Customize link in windows* on page 28.

When the topology feature is enabled in a Units View window, both parent and child units will display in the filtered view. For example, if you filter for a child named target device 1 that is attached to a DSR1031 switch, target device 1 will appear below the DSR1031 switch in the filtered view.

When filtering, you may use an asterisk (*) before and/or after text strings as a wildcard. For example, typing **emailserver*** and clicking *Filter* will display items with emailserver at the beginning (such as emailserver, emailserverbackup). Typing ***emailserver*** and clicking *Filter* will display items containing emailserver in any part of the name (such as emailserver, emailserverstore, tdemailserver, tdemailserver1).

Table 3.3 lists the ways you may specify text strings for filtering.

Table 3.3: Filter Text Strings

Typed in the Filter Field	Results
<String>	Entering a string displays a filtered list of items that contain the 'word' (that is, it will find matching strings that are followed by anything other than a letter or number). For example, typing email will list any items that contain the string email, followed by a space or punctuation mark. If you enter multiple words separated by spaces but without logical operators, OR is assumed, and each word is treated separately. For example, typing email server will display items containing email or server.
"<String>"	Surrounding the string with quotation marks displays a filtered list of items containing the exact string, including spacing and punctuation. For example, typing " email server " will display items that contain email server. The DSView 3 software will provide a closing quotation mark if it is omitted.
<String1> AND <String2>	Using the AND logical operator displays the items that contain both strings. For example, typing email and server will display items named email-server-3, email-server-2, server email and so on.
<String1> OR <String2>	Using the OR logical operator displays the items that contain at least one of the strings. For example, typing email or server will find any items that contain the string email or the string server.
(<String>)	Parentheses may be used to override the default (left to right) order of precedence during evaluation of a filter string. For example, searching for email and server or service would be the equivalent of ((email and server) or service), which may not be the intended search. The user may choose instead to change the order of precedence by grouping the search terms with parentheses, such as (email) and (server or service) .
NOT <String>	Preceding the string with NOT displays all items that do not contain the string. For example, typing not email will display all items except those containing email (email, email server, email-server-1 and so on will not display).

To filter the list in a window:

1. In a window containing a Filter field, type a text string in the field. Searches are not case sensitive.
2. Click *Filter*. A filtered list of the information in the window will be displayed.
3. Click *Clear* to return to a non-filtered list.

Saving information in a window

When you change information in a window, you must click *Save* in order to apply the changes. By default, a message box will appear if you click *Close* or try to exit the window by clicking a link in the top bar, top navigation bar or side navigation bar without first clicking *Save*.

Clicking *OK* in the message box will exit the current window without saving the changes. If you want to save the changes you have made, click *Cancel* in the message box, then click *Save* in the window.

You may choose whether you will be reminded to save changes made in windows before exiting them. See *Changing user options* on page 36.

Using the Customize link in windows

Windows that contain a *Customize* or *Customize Fields and Filter* link allow you to change the following information:

- The number of items displayed per page in the window
- Which columns of information are displayed in Units View windows
- Which columns are included in a filter from a Units View window (available from the *Customize Fields and Filter* link only)

By clicking the *Customize* link, you can also show units that have been hidden in a Units View window.

NOTE: If you are in a Units View window, the link is displayed as “Custom Fields and Filter” and this window contains additional filtering options. On any other window, the link is displayed as “Customize”. The term “Customize link” is used throughout this document to refer to both links.

The items available for customizing and methods for changing them will vary, depending on the window being customized. Although the items that appear in windows may vary, the items that do appear are modified identically regardless of the window in which you clicked the *Customize* link.

DSView 3 software administrators may also configure the default display for customizable windows, that is, which columns will be displayed and how many items will be displayed per page by default. The default values will be used by all new users and by existing users who have not already customized their views.

To customize a window using the Customize link:

1. In a window containing a *Customize* link in the upper right corner, click the link. A View Customization window will open.
2. Add, remove or move fields in the window display:
 - To add one or more fields to the window display, select the fields in the Available Fields list, then click *Add*. The fields will be moved to the Fields to Show list.
 - To remove one or more fields from the window display, select the fields in the Fields to Show list, then click *Remove*. The fields will be moved to the Available Fields list.
 - To change the order that fields display from left to right in the window, select one or more fields in the Fields to Show list. Use the up or down arrow to change its order in the list.
3. To specify the number of items that appear in a window, use the arrow keys in the Items per Page field to select a number or type a number (1-2000). In Units View windows that have the

- topology view enabled, the number of items per page includes children, even if the display is collapsed and the children are not visible.
4. To show hidden items in a Units View window (see *Showing and hiding units* on page 107).
 - a. Check the *Show hidden items* checkbox.
 - b. Select *Visibility* from the Available Fields column, and then click *Add*. Visibility will move to the Fields to Show list.
 5. To show group descendants in windows that display unit groups (see *Unit group hierarchy* on page 212), click the *Show group descendants* checkbox.
 6. To expand a topology view automatically in a Units View window (see *Topology view* on page 104), click the *Expand view automatically* checkbox.
 7. (Units View windows only) To specify which fields are included in a filter, select the field(s) from the Available Fields list and click the *Add* button. To remove fields from a filter, select the fields from the *Filter on these fields* list and click *Remove*.
 8. To set the Fields to Show and List Items as the default, click *Set as Default*. This button will appear only if you are a DSView 3 software administrator. You will be prompted to confirm setting these values as the default. Confirm or cancel.
 9. Click *Save* and then click *Finish*. The window being customized will open with the changes.

Displaying pages

Multiple page windows contain navigation buttons which may be used to quickly move among pages.

Table 3.4: DSView 3 Explorer Page Navigation Buttons

Button	Description
<	First Page - Navigates to the beginning of a list displayed in a window.
<<	Previous Page - Navigates to the previous page of a list displayed in a window.
>>	Next Page - Navigates to the next page of a list displayed in a window.
>	Last Page - Navigates to the end of a list displayed in a window.

The page navigation buttons are enabled only if there are enough pages available to make them necessary.

The number of items that display in a window page is specified by using the *Customize* link (see *Using the Customize link in windows* on page 28). If a page's content cannot fit vertically and/or horizontally in the window, scroll bars will appear. The current page and total number of pages appear in the top left corner of the window.

Many operations allow you to select all items on a page by enabling a checkbox located to the left of the column headings in the window. Enabling this checkbox selects all the items listed on a page

(whether or not the entire page is visible). However, for multi-page displays, items listed on other pages will not be included in the selection.

The only time you can select all items on all pages of a multipage display in one step is when you are setting access rights from a Units View windows. For this operation, if you click *Rights* in a Units View window with no units selected, all units on all pages will be affected by the operation.

Bookmarking a window

Many windows contain a bookmark icon and text in the top option bar. Bookmarking a window will add a link to the window in the Favorites menu. You may select the link at any time to quickly access the bookmarked window.

If you bookmark a window and information related to the window changes, this new information will appear in the window when you next display the bookmarked window. For example, if you bookmark the Recently Accessed window and then access other units, the bookmarked window will contain these other units the next time you display the bookmarked page.

If you click *BOOKMARK* or the bookmark icon after the DSView 3 server session has timed out, the User Login window will open and you must log in again. After you log in, you will be redirected to the bookmarked page.

To bookmark a window:

1. In the top option bar, click *BOOKMARK* or the bookmark icon. The Add Favorite dialog box will appear.
2. Optionally, type a name for the window. You may also click *Create in* to create or specify a folder in which to place the window.
3. Click *OK* to close the Add Favorite dialog box.

Printing a window

All windows contain a print icon and text in the top option bar. When you print a window, all the information on the page is printed, not just the visible portion.

To print a window:

1. In the top option bar, click *PRINT* or the print icon. The Print dialog box will appear.
2. Specify options to use, then click *Print* to print the window and close the Print dialog box.

Refreshing a window

A window may be refreshed at any time by clicking *REFRESH* or the refresh icon in the top option bar.

By default, status information automatically refreshes every 30 seconds. This interval may be changed or disabled. See *Changing user options* on page 36.

Using keyboard commands

In addition to using a mouse, certain keyboard commands may be used to select and change items in windows.

Table 3.5: General Keyboard Commands

Key	Description
Tab	Transfers focus to the next control in the window, including the calendar
Shift-Tab	Transfers focus to the previous HTML control

Table 3.6 lists the keyboard commands that may be used when a calendar is enabled and has focus.

Table 3.6: Calendar Keyboard Commands

Key	Description
Enter or Space	Displays or closes the calendar.
Esc	Closes the calendar.
Page Up	Decrements the month by one month and selects the first day of the month.
Page Down	Increases the month by one month and selects the first day of the month.
Right Arrow	Increments the day by one day. If the last day of the month is selected and the Right Arrow key is pressed, the month is incremented to the next month.
Left Arrow	Decrements the day by one day. If the first day of the month is selected and the Left Arrow key is pressed, the month is decremented to the previous month.
Up Arrow	Decrements the weekday by one week. If the first weekday type of the month is selected and the Up Arrow key is pressed, the month is decremented to the previous month.
Down Arrow	Increments the weekday by one week. If the last weekday type of the month is selected and the Down Arrow key is pressed, the month is incremented to the next month.

Table 3.7 lists the keyboard commands that may be used when a spinner is enabled and has focus.

Table 3.7: Spinner Keyboard Commands

Key	Description
Up Arrow	Increments the spinner number by one
Down Arrow	Decrements the spinner number by one

Basic Operations

This chapter describes basic operations and settings, including global system properties, profiles, built-in user groups and preemption levels.

DSView 3 Help

NOTE: The *DSView 3 Help* section only applies to DSView 3 software versions 3.5 or later.

The DSView 3 help is hosted on the Avocent web site. If you do not have continuous access to the Internet, you may wish to install the help on the local DSView 3 server.

NOTE: Help for DSView 3 software plug-ins is automatically installed on your local server and is not available from the Avocent web site.

Configuring the DSView 3 help location

DSView 3 administrators can change the DSView 3 help location at any time. Help is configured independently for each DSView 3 hub and spoke server.

To configure the DSView 3 help location:

1. Click the *System* tab, then click *DSView 3 Server*.
2. Click *Properties - Help Configuration* in the side navigation bar.
3. Specify the location of the help that will be accessed each time *Help - DSView 3 Management Software Help* is clicked.

Select *View help from the Avocent web site* to access the latest help for your DSView 3 software version from the Avocent web site (Internet connection required).

-or-

Select *View help from this DSView 3 server help location* to access the downloaded help from your local server. Complete the following procedure for *Installing DSView 3 help on a local server*.

4. Click *Save*.

NOTE: If your DSView 3 software version is several versions prior to the current version, the help may not be available on the Avocent web site. In this case, when you access the help from the web, you are prompted to save a .zip file of the help to the local device. Complete the *Installing DSView 3 help on a local server* procedure.

Installing DSView 3 help on a local server

You can automatically download the help from the Avocent web site using the DSView 3 software, or you can visit www.avocent.com/dsview3help to browse for the appropriate version and save a .zip file of the help to local media.

To download or update DSView 3 help on the local server:

1. Click the *System* tab, then click *DSView 3 Server*.
2. Click *Properties - Help Configuration* in the side navigation bar.
3. Click the *Download Latest Help* button. The DSView 3 Help Download Wizard opens.
4. Select *From the Avocent web site* to download the latest help for your DSView 3 software version from the Avocent web site.

-or-

Select *From a local device* to retrieve the help from local media. To specify the location, click *Browse* or type the path in the field.

5. Click *Next*.
6. The Completed Successful window opens. Click *Finish*.

NOTE: If you reinstall or upgrade the DSView 3 software, the DSView 3 help location is reset to *From the Avocent web site*. Complete the *Installing DSView 3 help on a local server* procedure if you want to access the help from the local server.

Global System Properties

Global system properties affect all DSView 3 servers in the system. That is, when global system properties are changed on a DSView 3 server, the next replication operation will apply those changes to all other DSView 3 servers in the system; see *Replication* on page 75.

Global system properties include:

- Video session properties - see *Video Viewer session properties* on page 253
- User credential properties - see *Specifying a user certificate* on page 38 and *Specifying an SSH key* on page 39
- Legal notice - see *Legal Notice* on page 35
- Target device naming - see *Target Device Naming* on page 152
- Automatic inheritance - see *Automatic Inheritance for Group Memberships and Properties* on page 135

Legal Notice

You may enable or disable the display of a legal caption and disclaimer prior to users logging in to the DSView 3 software. When enabled, the legal disclaimer is displayed every time a user logs in. The legal notice feature affects all DSView 3 servers in the system after replication; see *Replication* on page 75.

Only DSView 3 software administrators may configure the legal notice.

To enable or disable and configure the legal notice:

1. Click the *System* tab.
2. Click *Global Properties* in the top navigation bar.
3. Click *Legal Notice* in the side navigation bar. The DSView 3 System Logon Legal Notice window will open.
4. To enable the legal notice display:
 - a. Check the *Enable Legal Notice* checkbox.
 - b. Enter up to 80 characters in the Caption field. This is a required field.
 - c. Enter up to 512 characters in the Text field. Carriage returns may be used to separate lines. This is a required field.
 - d. Click *Save*.
5. To disable the legal notice display, uncheck the *Enable Legal Notice* checkbox and then click *Save*.

PCI Compliance Configuration

The DSView 3 software may be configured as Payment Card Industry (PCI) compliant. When PCI compliance is enabled, three settings are affected:

- Browser caching of secure web pages is disabled. This setting prevents the potential loss of confidential client data; however, this setting may not work effectively if older browsers are used.
- The browser prompt to save passwords is disabled. This setting prevents the potential loss of confidential client data.
- Weak SSL ciphers are disabled. This setting prevents the potential loss of data integrity.

These three settings may be enabled at once on the Global Properties page, or may be enabled/disabled individually.

NOTE: When PCI compliance is enabled, the exporting of the DSView 3 server CSR files, PEM certificates and SSH keys does not submit the request to the client's browser; instead the files are saved in the DSView 3 server user's home directory. The CSR filename is the name of the DSView server with extension .p10, the PEM certificate filename is DSView System Certificate.pem, and the SSH key filename is DSView System Certificate.pub. For example, if the server is running on Windows XP and the name of the server is WinXPServer, the files are saved to [rootdrive]\Documents and Settings\[username] and the names are:

- CSR file = WinXPServer.p10
 - PEM certificate = DSView System Certificate.pem
 - SSH key = DSView System Certificate.pub
-

To enable PCI compliance:

1. Click the *System* tab.
 2. Click *Global Properties* in the top navigation bar.
 3. Click *PCI Compliance* in the side navigation bar. The PCI Compliance Properties window will open.
 4. To enable PCI compliance, select *Make DSView Server PCI Compliant*. Click *Save*.
 5. Restart the DSView 3 server.
 6. Run the MSI installer to push the Video Viewer files to the Internet Explorer clients accessing the DSView 3 software; follow the procedure in *Managing ActiveX® controls* on page 43.
-

NOTE: The PCI compliance setting is not replicated to other DSView 3 servers. You must configure PCI compliance settings individually for each server that you wish to be PCI compliant.

Profiles

Profile information contains features and tasks that may affect actions when using the DSView 3 software. These include:

- User options
 - Color scheme
 - Changing a password
 - Choice of serial session application
 - Specifying a user certificate
 - Specifying a user SSH key
-

NOTE: You may also set up KVM session profiles for use with the Video Viewer; see *KVM Session Profiles* on page 254.

Changing user options

To change user options:

1. Click the *Profile* tab. The Options window will open.
2. In the Navigation Tree Behavior area, select one option:

- If you select *Automatically collapse navigation tree nodes*, a currently-expanded tree node will be collapsed when you select another tree node.
 - If you select *Preserve navigation tree state*, a currently-expanded tree node will remain expanded when you select another tree node.
 - If you select *Automatically fully expand navigation tree nodes*, all tree nodes will be expanded. This is equivalent to clicking the *Expand All Nodes* arrow in the side navigation bar; see *Using the Side Navigation Bar* on page 24.
3. Enable or disable prompts when leaving pages with unsaved changes:
 - Check *Skip prompt when leaving pages with unsaved changes*, if you do not want a message box to prompt you to save modified information when you leave a window.
 - Uncheck *Skip prompt when leaving pages with unsaved changes* if you want a message box to prompt you to save modified information when you leave a window.
 4. Select a refresh rate or *Never*. By default, windows automatically refresh every 30 seconds. If you select *Never*, windows will only be refreshed when you click the *REFRESH* icon or text in the top option bar.
 5. Click *Save*.

Changing the color scheme

When the color scheme is changed, it is changed only for the logged in user.

To change the color scheme:

1. Click the *Profile* tab.
2. Click *Preferences* in the top navigation bar.
3. Click *Color Scheme* in the side navigation bar. The Color Scheme window will open.
4. Click a color scheme to use. If the System Colors scheme is selected, the DSView 3 Explorer window will match the user's desktop color scheme.
5. Click *Save*. The color scheme will be applied to the DSView 3 Explorer window.

Changing your password

When the DSView 3 software internal authentication service is used, user accounts will indicate if users are allowed to change their password; see *User account restrictions and expiration settings* on page 236.

By default, passwords must contain at least three characters and will never expire. A different minimum character length and an expiration date may be configured; see *DSView 3 software internal authentication service* on page 80.

To change your password:

1. Click the *Profile* tab.
2. Click *Preferences* in the top navigation bar.

3. Click *Change Password* in the side navigation bar. The Change Password window will open.
4. Type your current password.
5. Type and confirm the new password.
6. Click *Save*.

Choosing the serial session application

You may specify the application to be used for serial sessions to target devices.

- DSView 3 software Telnet Viewer (Avocent Session Viewer)
- Win32 PuTTY Telnet/SSH application
- Third party application

NOTE: If you use a third party Telnet application, the first time you attempt to launch a session, you will be prompted to confirm the use of that application. If you do not confirm the use of that application, the session will not be launched.

NOTE: Only the DSView 3 software Telnet Viewer is supported on Macintosh system clients.

To specify the serial session application:

1. Click the *Profile* tab.
2. Click *Applications* in the side navigation bar.
3. Check the checkbox for the application you want to use for serial sessions.
4. If you check *3rd Party Application*, enter the path and executable name of the application (maximum 256 characters) in the Serial Application field.

Specify any of the following parameters (up to 128 characters) in the Command Line Arguments field. When the serial session is launched, the actual values will be substituted.

%ADDRESS% - The IP address will be substituted.

%PORT% - The port number will be substituted.

%TNAME% - The target name will be substituted.

If the third party application does not automatically launch a command window, check the *Launch in Command Window* checkbox.

5. Click *Save*.

Specifying a user certificate

This property may be changed only for internal authentication users. See *DSView 3 software internal authentication service* on page 80.

A user may specify a certificate if the administrator has allowed it; see the procedure below. If the system certificate policy is enabled for user certificates (see *System certificate policy and trust store* on page 47), the user certificate used at login must meet the policy requirements.

As an alternative, the administrator may specify the certificate in the user account properties. See *User certificates* on page 235.

To enable user settable certificates:

NOTE: Only DSView 3 software administrators may access this procedure.

1. Check the *Allow user to set own certificate* checkbox.
2. Click *Save*.

To specify a user certificate:

NOTE: A user may access this procedure only if a DSView 3 software administrator has allowed it.

1. Click the *Profile* tab. Preferences will automatically be selected in the top navigation bar.
2. Click *Credentials* in the side navigation bar, then click *Certificate*.
3. Type the path and name of the certificate or browse to the certificate location.
4. Click *Save*. An updated Certificate window will open.

Specifying an SSH key

A user may specify an SSH key if the administrator has allowed it.

As an alternative to this method, the administrator may specify the SSH key in the user account properties. See *User SSH key* on page 235.

To enable user settable SSH keys:

NOTE: Only DSView 3 software administrators may access this procedure.

1. Click the *System* tab.
2. Click *User Credential Properties* in the side navigation bar.
3. Check the *Allow user to set own SSH key* checkbox.
4. Click *Save*.

To specify an SSH key:

NOTE: A user may access this procedure only if a DSView 3 software administrator has enabled it.

1. Click the *Profile* tab. Preferences will automatically be selected in the top navigation bar.
2. Click *Credentials* in the side navigation bar, then select *SSH Key*.
3. Type the 1-256 character name of the file containing the public SSH key that was generated by a third party key generator or browse to the file location.
4. Click *Save*. An updated SSH Key window will open. The SSH key file will be uploaded to the DSView 3 server for use in authenticating the user.

Enabling user credential caching

User credential caching provides a single sign-on method for accessing units supported by certain plug-ins. If enabled, the credentials used to log in to the DSVIEW 3 software are maintained in a secure internal cache. A supported plug-in, such as the Virtualization plug-in, can retrieve these credentials to log in to connected units.

To enable user credential caching:

NOTE: Only DSVIEW 3 software administrators may access this procedure.

1. Click the *System* tab.
2. Click *User Credential Properties* in the side navigation bar.
3. Check the *Enable credential caching* checkbox.
4. Click *Save*.

Any currently logged in users must log out and log in again for their credentials to be cached.

Built-in User Groups

When a user account is added to the DSVIEW 3 software system, the user may be assigned to any of the following built-in user groups:

- DSVIEW 3 software administrators
- Appliance administrators
- User administrators
- Auditors
- Users

Table 4.1 lists the operations allowed for the built-in user groups.

Table 4.1: Built-In User Group Allowed Operations

Operation	Built-In User Group				
	Software Administrator	User Administrator	Appliance Administrator	Auditors	Users
Configure DSVIEW 3 software system-level settings	Yes	No	No	No	No
Add, change, import and delete DSVIEW 3 software	Yes	Yes	No	No	No
Backup and restore the DSVIEW 3 software database	Yes	No	No	No	No
Register a spoke server	Yes	No	No	No	No

Table 4.1: Built-In User Group Allowed Operations (Continued)

Operation	Built-In User Group				
	Software Administrator	User Administrator	Appliance Administrator	Auditors	Users
Add, change and delete units	Yes	No	Yes	No	No
Add, change and delete unit groups	Yes	Yes	Yes	No	No
Configure access rights	Yes	Yes	No	No	No
Add, change and delete sites, departments and locations	Yes	No	Yes	No	No
Add, change and delete external authentication services	Yes	Yes	No	No	No
Add, change, delete user accounts and user-defined user groups	Yes	Yes	No	No	No
All event-related operation	Yes	No	No	Yes	No
Change your own password	Yes	Yes	Yes	Yes	Yes

In addition to the built-in user groups, the DSView 3 software supports user-defined user groups; see *Grouping Units* on page 205.

Preemption Levels

The preemption level of users determines whether they may interrupt or disconnect another user's serial or video (KVM) session with a target device. This also applies to virtual media sessions, which are initiated from the Video Viewer.

DSView 3 software administrators and user administrators may specify the preemption level for user accounts or user-defined user groups when an account or group is created. The preemption level may be changed later. See *Preemption level* on page 237 or *User Group Properties* on page 245.

By default, the preemption level used by the DSView 3 management software (the effective user preemption level) is the highest level of all of the user groups to which the user belongs. Preemption levels range from 1-4, with 4 being the highest level. For example, a user or a user

group with a preemption level of 4 may preempt other level 4 users or user groups, as well as those with a level 1, 2 or 3 setting.

Table 4.2: User and User Group Preemption Levels

Preemption Level	Description
4	The default preemption level for a new local user of a KVM switch or serial console appliance.
3	The default preemption level for the DSView 3 software administrator and appliance administrator user groups.
2	The default preemption level for the user administrator user group.
1	The default preemption level for the users and auditors groups.

The preemption levels may be used in the following ways:

- **User preemption level** - This is the preemption level assigned to a user by a DSView 3 software administrator or user administrator. If this value is larger than the highest preemption level of the user group to which the user belongs, the value will be used as the effective user preemption level.
- **Group preemption level** - This is the preemption level assigned to user groups to which the user belongs. If the user is assigned to multiple user groups with different preemption levels, this will be the preemption level of the user group with the highest level. For example, if a user belongs to the administrators (level 3) and auditors (level 1) user groups, this value will be defined as 3. If this value is larger than the highest preemption level of the user, the value will be used as the effective user preemption level.
- **Effective user preemption level** - This is the largest value between the user and group preemption level, and is the actual preemption level that will be recognized by the DSView 3 software when the user attempts to preempt another user's session. For example, if user belongs to the auditors group (level 1) but is assigned a user preemption level of 4, the user will have an effective user preemption level of 4. Although a member of the auditors group, this user would also be able to preempt the session of a user belonging to the administrators or appliance administrators user groups.

An administrator or user administrator may also specify an OSCAR graphical user interface preemption level that is applied to users accessing target devices through the OSCAR interface. See *KVM Switch and Cascade Switch Settings* on page 154.

Internet Explorer Considerations

When the Internet Explorer web browser is used, specific settings are required to enable the DSView 3 software to operate correctly.

- **SSL (Secure Sockets Layer) certificates** - Used for secure authentication between the DSView 3 software client and DSView 3 software hub server; see *Certificates* on page 46.

- ActiveX controls - Used to display Telnet application, serial and KVM sessions.
- Security Zones - Used to control the actions that may be performed within Internet Explorer. For example, the operation of JavaScript, which is used by the DSView 3 software, is dependent on security zone settings.
- Advanced Internet options - Used for miscellaneous settings that enhance the use of the DSView 3 software.

Managing ActiveX® controls

The DSView 3 software uses ActiveX controls to provide interactive content for viewers. (The Avocent Telnet Viewer uses Java; see *Java Installation* on page 19 for information.)

The functionality of the ActiveX controls is determined by the settings for the security zone being used by the DSView 3 software. See *Security zones* on page 44.

Administrators may prevent users from installing software on their computers. In this case, the Windows domain administrators may choose to “push” an MSI installer using a Group Policy. This will silently install the Avocent Session Viewers without requiring the user to install the software themselves. This will install only the viewers for Internet Explorer. The MSI file is located on the DSView 3 software DVD and in the webapp/applets directory on the DSView 3 server.

Use the following procedures if you are permitted to install software.

To download an ActiveX control on a DSView 3 software hub server using Windows (all operating systems except Windows XP with Service Pack 2):

1. In a Units View window that contains target devices (see *Accessing Units View windows* on page 106), click the link in the Action field or select an alternate action, if available.
You can also access a Unit Overview window for a target device and click the icon or link for the session type.
If this is the first time the ActiveX control has been requested by the DSView 3 software, an Avocent Session Viewer message box will appear, followed by a Security Warning dialog box.
2. Select *Always trust content from Avocent Huntsville Corporation*.
3. Click *Yes* to download the ActiveX control. When the control has been downloaded, a KVM session will start in a Video Viewer window or a serial session will start in a Telnet Viewer window, depending on the supported action for the managed appliance.

If the required ActiveX control could not be loaded, a red X will appear in the Avocent Session Viewer message box. The ActiveX control may fail to load for one of the following reasons:

- The user did not select *Always trust content from Avocent Huntsville Corporation*.
- The DSView 3 software client security zone settings are not correct.
- The ActiveX control failed to properly install.

To download an ActiveX control on a DSVIEW 3 software hub server using Windows XP with Service Pack 2:

1. In a Units View window that contains target devices (see *Accessing Units View windows* on page 106), click the link in the Action field or select an alternate action, if available.
You can also access a Unit Overview window for a target device and click the icon or link for the session type (see *Unit Overview Windows* on page 112).
If this is the first time the ActiveX control has been requested by the DSVIEW 3 software, an Avocent Session Viewer message box will appear.
2. Click in the top yellow bar. A pop-up menu will appear. Click *Install*. A Security Warning dialog box will appear.
3. Click *Install* to install the ActiveX control.

Security zones

Internet Explorer restricts actions performed by the web browser, based on the security zone membership of the web site being accessed. Each security zone typically has its own security restrictions. The following four security zones are available in Internet Explorer:

- Trusted Sites - Web sites contained in the list of trusted sites.
- Restricted Sites - Web sites contained in the list of restricted sites.
- Local Intranet - Web sites accessed using a host name (for example, <https://sun-e2-callisto>).
- Internet - All other web sites, including those accessed using standard dot notation (for example, <https://10.0.0.1>).

By default, the DSVIEW 3 software operates correctly in the Internet, Local Intranet and Trusted Sites security zones when accessing a hub server.

NOTE: A DSVIEW 3 software hub server installed on a PC running the Windows 2003 Server will not operate correctly in the Internet security zone.

The current security zone appears in the lower right corner of the DSVIEW 3 Explorer window.

To ensure that the DSVIEW 3 software works correctly in security zones:

Specify settings for the Local Intranet and Internet security zones. When a DSVIEW 3 software client accesses a hub server using a host name (for example, <https://avocent>), the Local Intranet security zone will be used. When a client accesses a hub server using a web address with periods (for example, <https://www.avocent.com>), the Internet security zone will be used.

-or-

Add the DSVIEW 3 software hub server to the Trusted Sites list. The DSVIEW 3 software client will always connect to the hub server using the Trusted Sites security zone. The Trusted Sites zone contains very low security settings and ensures successful communication between the client and the hub server.

To display or change the restrictions of a security zone:

1. In Internet Explorer, select *Tools - Internet Options*. The Internet Options dialog box appears.
2. Click the *Security* tab.
3. Select the security zone you wish to view.
4. Click *Custom Level*. The Security Settings dialog box appears.
5. Ensure that the following security settings are set to Enabled or Prompt. The Active Scripting setting should be set to Enabled.
 - Download Signed ActiveX Controls
 - Run ActiveX Controls and Plug-Ins
 - Launching Programs and Files in an IFRAME
 - Active Scripting
6. Click *OK* to save the settings and close the Security Settings dialog box.
7. Click *OK* to close the Internet Options dialog box.

To add a hub server to the Trusted Sites list:

NOTE: If Trusted Sites security zone settings have been modified from their defaults, ensure that the correct settings required for the DSView 3 software are specified, as indicated above.

1. In Internet Explorer, select *Tools - Internet Options*. The Internet Options dialog box appears.
2. Click the *Security* tab.
3. Click *Trusted Sites*, then click *Sites*. The Trusted Sites dialog box appears.
4. Type the web site address, in standard dot notation (xxx.xxx.xxx.xxx), for the DSView 3 software hub server (for example, https://10.0.0.1).
5. Click *Add*. The web site address will appear in the web sites list box.
6. Ensure that *Require server verification (https:) for all sites in this zone* is selected.
7. Click *OK* to save the settings and close the Trusted Sites dialog box.
8. Click *OK* to close the Internet Options dialog box.

Advanced Internet options

Internet Explorer contains advanced settings that may be specified to enhance use of the DSView 3 software. Changing these settings is not required, but is recommended for optimum results.

To specify advanced Internet options for the DSView 3 software:

1. In Internet Explorer, select *Tools - Internet Options*. The Internet Options dialog box appears.
2. Click the *Advanced* tab.
3. Select the following settings:
 - Always send URLs as UTF-8

- Disable script debugging
 - Play animations in web pages
 - Show pictures
 - Print background colors and images
 - Use SSL 2.0
 - Use SSL 3.0
4. Select *Enable Integrated Windows Authentication* if the DSView 3 software is using Integrated Windows Authentication. See *Integrated Windows Authentication* on page 49.
 5. Uncheck the following settings:
 - Always expand ALT text for images
 - Display a notification about every script error
 6. Click *OK* to save the settings and close the dialog box.

Certificates

The DSView 3 software system uses certificates to provide secure transactions between components and to uniquely identify components in the system.

System certificate and SSH key

The DSView 3 software system generates and manages a system certificate and SSH key. The system certificate or SSH key may be exported to a local directory - the certificate's public key may then be used to validate the signature of data log files. See *Verifying data log file digital signatures* on page 194.

To view or export the system certificate or SSH key:

1. Click the *System* tab.
2. Click *Global Properties* in the top navigation bar.
3. In the side navigation bar, click *X.509 Certificates*, and then click *System Certificate*. The System Certificate window will open.
4. To export the system certificate in PEM format to a local directory, click *Export Certificate*. A pop-up window will open. The content of this window is browser-dependent, but it will usually prompt you to confirm the export operation. Confirm or cancel.

-or-

To export the SSH key in PUB format to a local directory, click *Export SSH Key*. A pop-up window will open. The content of this window is browser-dependent, but it will usually prompt you to confirm the export operation. Confirm or cancel.

Server certificates

A DSView 3 server certificate:

- Uniquely identifies the DSView 3 server to DSView 3 software clients connecting to the server using web browsers
- Uniquely identifies the DSView 3 server to other DSView 3 servers in the system and provides for secure transactions between them
- Provides for secure transactions between DSView 3 software clients and the DSView 3 software server

A Security Alert dialog box may appear if there are server certificate issues. See *Server certificates* on page 61 for information about certificate alerts and updating server certificates.

Client certificates

DSView 3 software client certificates (also known as user certificates) are used to authenticate client users during login when the DSView 3 software internal authentication service is configured in their user accounts. See *Adding User Accounts* on page 231.

To use DSView 3 software client certificates for authentication, a DSView 3 software administrator must first enable certificate authentication; see *Client session information* on page 66. Once this is enabled, the DSView 3 server will prompt the client web browser to send its user certificates.

The DSView 3 software client certificate must first be loaded into the client web browser and be associated with a user account. There are two ways to do this:

- The certificate location can be specified in a user account - see *User certificates* on page 235
- The DSView 3 software administrator may enable user-settable certificates, then the user may specify the certificate location - see *Specifying a user certificate* on page 38

If the system certificate policy (see below) is enabled for user certificates, the certificate used at login must meet the policy requirements.

Managed appliance certificates

Certificates are also used for authenticating and authorizing managed appliance sessions when a managed appliance is added in secure mode. See *Adding Units* on page 115.

System certificate policy and trust store

DSView 3 software administrators may configure the certificate policy by enabling/disabling settings. The trust store contains a list of all trusted certificate authorities known to the DSView 3 software. You may add, remove or modify the location of trust store entries.

To configure certificate policy settings:

1. Click the *System* tab.
2. Click *Global Properties* in the top navigation bar.
3. Click *X.509 Certificates* in the side navigation bar. The System Certificate Policy window will open.

4. Enable/disable checkboxes or select values as indicated for each setting.

Table 4.3: System Certificate Policy

Feature	Value when enabled
Chain Building	
Authority Info Access (AIA)	Permits the DSView 3 software to use the AIA certificate extension to locate a certificate's issuer.
Max chain length	Maximum allowable number of certificates (inclusive) between the leaf certificate and a trusted certificate. Valid range is 1-16.
Chain Validation	
Partial chains	Allows partial chains. (If disabled, partial chains will be considered invalid, even if the chain contains a trusted certificate.)
Usage flags	A certificate may be used only for the reasons dictated in the certificate. For example, a certificate must be flagged as CA (Certificate Authority) to be considered a valid certificate issuer.
Validity period	The current date and time on the server must be within the window on each certificate in the chain.
Verify signatures	The signatures within the certificate chain are checked for validity.
Certificate Revocation Lists (CRL)	
CRL checks	If CRLs are available, they are checked to determine a certificate's revocation status.
Distribution points	CRLs may be located using the distribution point certificate extension.
Reject on error	The DSView 3 software will reject a certificate chain if a CRL is specified (either in the certificate or the DSView 3 trust store) and it cannot be read or is invalid.
Secure Sockets Layer (SSL)	
Name verification	Outbound SSL connections will verify server names.
Subject alternative names	The server names may match the certificate common name or one of the subject alternative names.
User Certificates	
Verify using trust store	User certificates presented to the DSView 3 software are verified using the System Trust Store.

5. Click *Save*.

To display and manage the trust store:

1. Click the *System* tab.
2. Click *Global Properties* in the top navigation bar.
3. In the side navigation bar, click *X.509 Certificates*, and then click *Trust Store*. The System Trust Store window will open, listing all trusted certificate authorities known to the DSView 3 software. By default, the list contains the standard CAs from Java.
4. To view or change information about a certificate, click on its name. The System Trust Store Entry window will open. You may change the CRL Location, which indicates where the CRL should be obtained for that CA. If you change the location, click *Save*. Then click *Close*.
5. To delete one or more certificates:
 - a. Click the checkbox to the left of the certificate name. To delete all certificates on the page, click the checkbox to the left of Name at the top of the list.
 - b. Click *Delete*.
 - c. You are prompted to confirm the deletion. Confirm or cancel the deletion.
6. To add a certificate:
 - a. Click *Add*. The New System Trust Store Entry window will open.
 - b. In the Certificate File field, enter the name of the file containing the X.509 certificate to upload into the trust store. The file may be binary or Base64 encoded.
 - c. In the CRL Location field, you may enter the location of the CRL for the uploaded certificate (maximum 256 characters). The supported protocols are http://and ldap://.
 - d. Click *Add*.

Integrated Windows Authentication

The DSView 3 management software allows DSView 3 software clients to authenticate against Microsoft Windows NT domain and Microsoft Active Directory external authentication servers using Integrated Windows Authentication. This feature allows Single Sign-On (SSO) and is disabled by default. When running Windows Server 2003 or 2008 with Kerberos and NTLM authentication protocols, SSO is supported but it must first be configured in the web browser and AD server; see the documentation included with your browser and AD server or contact an Avocent technical support representative for assistance.

NOTE: When accessing the DSView 3 client using Integrated Windows Authentication, the browser URL must include the DSView 3 intranet name.

To use Integrated Windows Authentication for authentication, a DSView 3 software administrator must first enable it. See *Client session information* on page 66.

Firewalls

In a typical network configuration, as shown in Figure 4.1, the DSVIEW 3 software client is located outside of the firewall and the DSVIEW 3 server and managed appliances reside inside the firewall. In this case, the firewall must be configured to allow two TCP/IP ports inside the firewall.

One TCP port (default=443) is used for the HTTPS web browser connection between the DSVIEW 3 software client and the DSVIEW 3 server. The other TCP port (default=1078) is used for the Avocent Proxy Protocol to tunnel video and Telnet traffic. Both ports are configurable.

If you are using the DSVIEW 3 management software through a firewall, we recommend the following:

- Place the DSVIEW 3 server and all managed appliances within the same firewall Demilitarized Zone (DMZ). If the managed appliances are not in the same DMZ with the DSVIEW 3 server, you must configure the firewall so all data may pass between the zones using TCP/IP ports 22 (SSH), 3211, 2068, 8192 and 3871. You must also configure the User Datagram Protocol (UDP) port 3211 so it may pass through the firewall for initial network discovery of appliances that do not have an IP address.

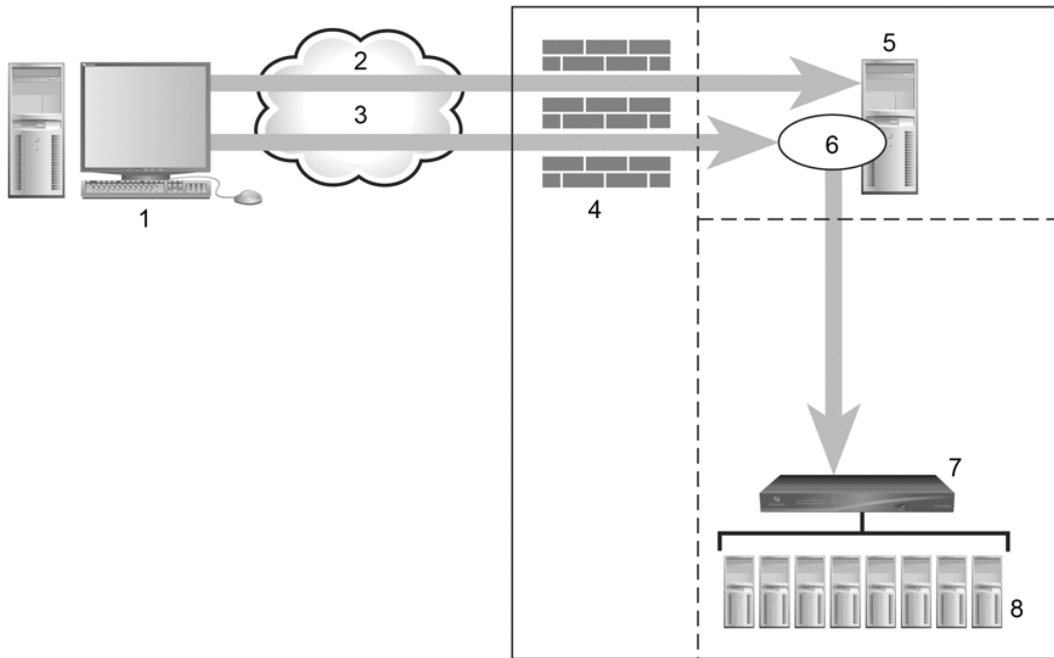

Figure 4.1: Typical DSView 3 Software System Firewall Configuration

Table 4.4: Typical DSView 3 Software System Firewall Configuration Descriptions

Number	Description	Number	Description
1	DSView 3 Software Client	5	DSView 3 Server
2	HTTPS	6	Proxy
3	Proxy	7	KVM Switch or Serial Console Appliance
4	Firewall	8	Target Devices

VPNs

A Virtual Private Network (VPN) is a secure network that uses public infrastructure and typically includes several Wide Area Network (WAN) components that may impact performance of the VPN.

Typically, two sites are connected in a VPN network using WANs and a router. This setup provides a secure network between the two sites, but processing is slow.

Several factors related to the network setup, including the DSView 3 software database replication schedule and methods of device access, can affect the speed of a multi-site VPN network. The trade-off must be made based on the network setup.

Frequent replication of the DSView 3 software database will increase WAN/VPN traffic but provide steady data reception at the local sites. Infrequent database replication made at the various sites decreases the WAN/VPN traffic but delays the reception of changes at the local site.

In addition, the methods used to access devices affects network speed. VPN access of a managed appliance is always slower than local access.

The DSView 3 management software supports VPNs that provide full transparency for IP addresses, as well as ports between sites and many VPNs that perform network address translation (NAT) between sites. For example, the VPN in Figure 4.2 could use NAT if Site A and Site B are separate companies that merged but have not resolved their IP addresses. See *NAT Devices* on page 53.

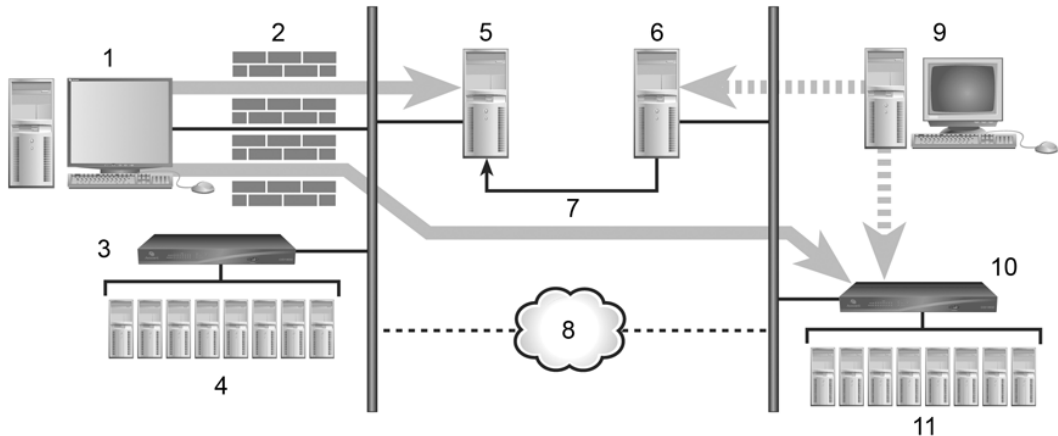

Figure 4.2: DSView 3 Software System on a VPN

Table 4.5: DSView 3 Software System on a VPN Descriptions

Number	Description	Number	Description
1	DSView 3 Software Client	7	Replication
2	Firewall	8	VPN
3	Site A	9	DSView 3 Software Client
4	Target Devices	10	Site B
5	Hub Server	11	Target Devices
6	Spoke Server		

NAT Devices

NAT devices enable a company to use more internal IP addresses than they have assigned to managed appliances. The IP addresses are not exposed outside of the NAT device.

NAT devices are typically used with a DSL broadband router. A DSView 3 software client is connected to the NAT device, as shown in Figure 1.6, which then connects to the corporate network using a VPN.

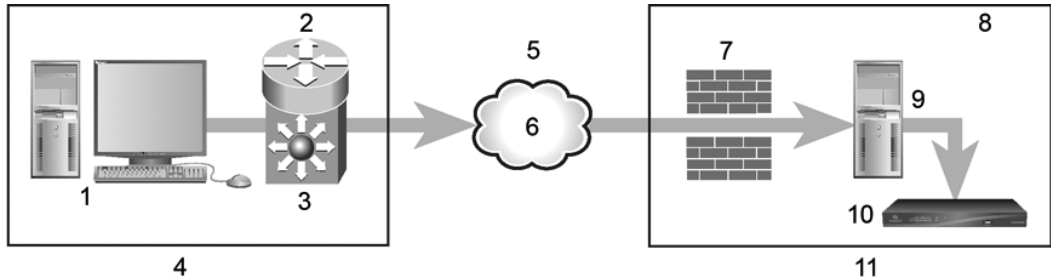

Figure 4.3: Single NAT Configuration (Client Only)

Table 4.6: Single NAT Configuration (Client Only) Descriptions

Number	Description	Number	Description
1	DSView 3 Software Client	7	Firewall
2	Private	8	Private
3	NAT Device	9	DSView 3 Server
4	Client	10	Managed Appliance
5	Public	11	Corporate
6	VPN		

Another scenario, shown in Figure 4.4 on page 54, is when the corporate site also uses a NAT device to save IP addresses (double-NAT). Since the DSView 3 software client is trying to access a private resource inside the corporate site, the TCP/IP ports used for HTTPS and the proxy server must be configured to be exposed on the corporate NAT device.

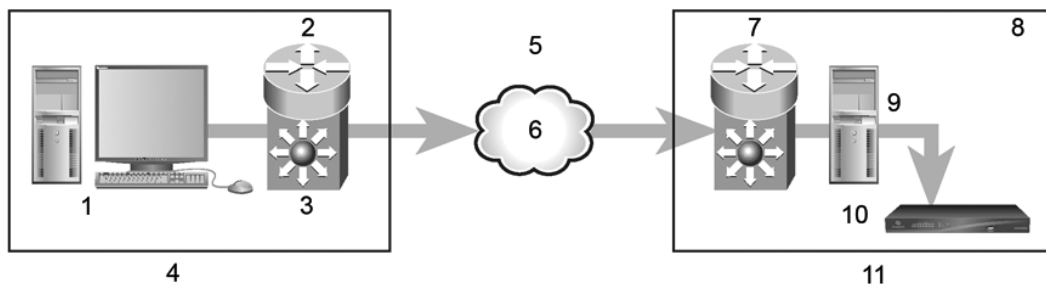

Figure 4.4: Double-NAT Configuration (Client and Corporate)

Table 4.7: Double-NAT Configuration (Client and Corporate) Descriptions

Number	Description	Number	Description
1	DSView 3 Software Client	7	NAT Device
2	Private	8	Private
3	NAT Device	9	DSView 3 Software Server
4	Client	10	Managed Appliance
5	Public	11	Corporate
6	VPN		

NOTE: NAT devices may not be connected between the DSVIEW 3 server and any managed appliances.

Licenses

License keys permit the operation of the DSVIEW 3 management software on the hub server. They also specify the number of managed devices that may be controlled by the software and spoke servers allowed on a system. Managed devices include physical servers, routers, switches, firewalls, blade chassis, hypervisor managers, hypervisor servers, virtual machines and any other target device that can be managed by the DSVIEW 3 software. If a managed device is available through multiple connection methods, the managed device requires only one license as long as it is merged into a single connection in the DSVIEW 3 software.

Licenses may also be required to enable additional features. See Table 4.8 on page 55 for more information.

A demonstration (demo) license key may also be used for a trial period. When the trial elapses, login attempts will fail. A demo license key may be replaced with another demo license key or a permanent license. If additional license keys are added during the trial and the demo key expires, the add-on keys will have to be re-entered when a new license key is installed.

Contact Avocent for information about obtaining licenses.

To display license information:

1. Click the *System* tab.
2. Click *Licenses* in the top navigation bar.
3. Click *Summary* in the side navigation bar. The License Summary window will open. Table 4.8 describes the window fields.

Table 4.8: License Summary Fields

Section	Field	Description
Installation Key or Demo Install Key	Serial Number	Serial number encoded in the license key for the DSView 3 software hub.
Managed Devices	Currently in Use	The total number of licenses for managed devices that can be added to and managed by the DSView 3 system.
Spoke Servers	Licensed	Total number of licenses for spoke DSView 3 servers.
	Currently in Use	Number of licenses for spoke DSView 3 servers currently in use.
Third Party Power Devices	Licensed	Total number of licenses for third party power devices. Unlimited indicates there are no restrictions on the number of power devices that can be added.
	Currently In Use	Number of licenses for third party power devices currently in use.
Plug-ins	Licensed	Total number of license IDs for plug-ins.
	Currently In Use	Number of license IDs for plug-ins currently in use.
Auditor Appliances	Licensed	Total number of Auditor appliances licensed to be added as managed appliances.
	Currently in Use	Number of Auditor appliance licenses currently enabled.
Web Services API	Licensed	Status of the Web Services API licensing; may be enabled or disabled. For more information, see the DSView 3 SDK GUI Access API and Web Services API Installer/User Guide.
Child Zones	Licensed	Total number of zones that can be created.
AVR Appliances	Licensed	Total number of non-Avocent KVM switches that can be managed. These switches are supported by plug-ins; see the corresponding plug-in documentation for specific requirements.

To display license keys:

1. Click the *System* tab.
2. Click *Licenses* in the top navigation bar.

3. Click *License Keys* in the side navigation bar. The License Keys window will open and list each installed license key and a description of the key. One of the following descriptions will display beside each key:
 - Adds <number> Backup Server(s) - Adds <N> backup (spoke) DSView 3 servers.
 - Adds <number> Backup Server(s) and Unlimited Client Sessions - Combines the keys for Adds <N> Backup Server(s) and Client Session Site License.
 - Installation Key - Enables first use of the DSView 3 software and sets the initial number of backup DSView 3 servers.
 - Demo License Key - Enables first use of the DSView 3 software for a certain period of time.
 - Third Party Power Devices Site License - Increases the number of third party power devices that can be added to unlimited.
 - Add <number> Third Party Power Devices - Increases the number of third party power devices.
 - Add <number> Managed Devices - Increases the number of licensed managed devices.
 - Plug-in Id <number> License Key - Enables use of a plug-in for a specific appliance type.

Adding a new license key

To add a new license key:

1. Click the *System* tab.
2. Click *Licenses* in the top navigation bar.
3. Click *License Keys* in the side navigation bar. The License Keys window will open.
4. Click *Add*. The Add License Key window will open.
5. If you did not receive a license key, click the <http://www.avocent.com/activation> link to obtain a license key.
6. Type a valid new add-on license key in the License Key field. (License keys from a DSView software release prior to version 3.0 are not valid.)
7. Click *Save*. The License Keys window opens, containing a new row with the new license key.

System Information

The System Information window displays the total number of client sessions in use and the DSView 3 software version currently installed.

To view system information:

1. Click the *System* tab.
2. Click *Global Properties* in the top navigation bar.
3. Click *System Information* in the side navigation bar. The System Information window opens.

ISV Partners

The Avocent Independent Software Vendors (ISV) partners program supports configuring and launching a browser from within the DSView 3 software to the console of the Ipswitch WhatsUp Professional.

Only members of the DSView 3 administrators user group may configure ISV partner URLs. See the Avocent web site for more information about the ISV partners program.

To add or change the partner URLs:

1. Click the *Units* tab.
2. Click *Partners* in the top navigation bar.
3. If partner URLs have not already been configured, click *Properties* in the side navigation bar.
4. The Partner Properties window will open. Enter the URLs for launching a browser to the partner product. Separate multiple URLs with a line break. The maximum length in each field is 512 characters.
5. Click *Save*. A button icon and link will appear for each configured URL on the Partner Tools page.

To launch a browser session to a partner URL:

1. Click the *Units* tab.
2. Click *Partners* in the top navigation bar.
3. The Partner Tools window will open. (This window exists only if at least one URL has been defined in the Partner Properties window.)
4. Click on the button or link to launch the browser window to the specified URL.

DSView 3 Servers

This chapter describes how to configure DSView 3 server properties, backup and restore hub servers and manage spoke servers.

Server Properties

Table 5.1 lists the DSView 3 server properties.

Table 5.1: Server Properties

Property	Description
Identity	Name of the DSView 3 server and the server's role (hub or spoke).
Network	<p>IP address (*) and port used by clients to access the server using the HTTPS (SSL) protocol. You may change the port number used for the HTTPS connection.</p> <p>NOTE: When the DSView 3 server is running on a Linux system, the IP address field may contain the loopback address. If this is not desired, edit the /etc/hosts file on the Linux system. Add a new line above the line that defines the loopback address. The new line should contain the IP address, followed by the host name. For example, the following new line adds the IP address 172.30.20.206 for the host name sun-jcv-fc3.avocent.com, above the existing line that defines the loopback address (127.0.0.1).</p> <pre>172.30.20.206 sun-jcv-fc3.avocent.com 127.0.0.1 localhost.localdomain sun-jcv-fc3.avocent.com localhost sun-jcv-fc3</pre>
Certificate	DSView 3 server certificate presented to DSView 3 software client web browsers.
Proxy Server	<p>When the Avocent proxy server is used, DSView 3 software client KVM and serial session requests are sent through the DSView 3 server rather than directly to the KVM switch or serial console appliance, which prevents the exposure of the internal address of the managed appliance. You may change the proxy server configuration.</p> <p>NOTE: EVR1500 environmental monitor, DSI5100 IPMI and generic appliance sessions are not sent through the DSView 3 server, even when the proxy is enabled.</p>
SSH Server	Enables/disables the SSH server and specifies the port it uses.

Table 5.1: Server Properties (Continued)

Property	Description
Trap Destinations	<p>The DSVIEW 3 server polls KVM switches or serial console appliances to determine if they are responding. If the managed appliance does not respond, the DSVIEW 3 server sends an SNMP Loss Of Communication (LCM) trap or alert to the external SNMP manager. When the DSVIEW 3 server detects that the appliance is once again communicating, a Regained Communication (RCM) trap is sent from the DSVIEW 3 software server.</p> <p>When a response change occurs during communication between the DSVIEW 3 server and a managed appliance, the DSVIEW 3 software writes the event to the event log and sends an SNMP trap to the configured trap destinations.</p> <p>Trap destinations may also be specified by clicking on a managed appliance and changing the SNMP appliance settings.</p>
DSVIEW Client Sessions	Settings for inactivity time-out, authentication policy, Single Sign-On (SSO) for the session or restrictions to use specific IP addresses to start the sessions. Also displayed the number of client sessions currently in use.
DSVIEW Modem Session	Settings for dial-up sessions, including inactivity time-out, time to wait for a connection and dial-back number.
Email	IP address of the SMTP (Simple Mail Transfer Protocol) server that is used by the DSVIEW 3 software to send email notifications.
Unit Status Polling	Enables/disables unit status polling for the DSVIEW 3 server, and specifies the delay between polling cycles and the number of managed appliances that will be concurrently polled.
Spoke Servers	Enables you to manage the DSVIEW 3 software spoke servers in your system.
Data Logging	Settings for data log file location, archiving and Syslog server.

To display server properties:

Click the *System* tab. *DSVIEW Server* will automatically be selected in the top navigation bar and *Identity* will automatically be selected in the side navigation bar. The DSVIEW Server Identity Properties window will open. The top of the side navigation bar will indicate the name of the DSVIEW 3 software server.

To change server network properties:

1. Click the *System* tab.
2. Click *Network* in the side navigation bar. The DSVIEW Server Network Properties window will open.
3. Type a new DSVIEW 3 server port number in the HTTPS Port field.

If the default value (443) is modified, the port number in the URL must be specified when accessing the DSVIEW 3 software. For example, if the IP address of the hub server is 10.0.0.1 and the port number is changed to 444, **https://10.0.0.1:444/dsview** must be typed in the Address field of the web browser to access the DSVIEW 3 software.

The selected port must be available on the DSView 3 server. If DSView 3 software clients are located on an external connection, the specified port must be open on the firewall.

4. Click *Save*. A confirmation dialog box will appear.

A web browser error message will appear when *Save* is clicked. This error message is a normal occurrence. To reestablish connection to the DSView 3 software, you must reconnect to the hub server by typing the URL with the new port number. For example, if you changed the port number to 334 for a hub server with an IP address of 10.0.0.1, type **https://10.0.0.1:334/dsview** to access the DSView 3 management software.

5. Confirm or cancel the change.

Server certificates

DSView 3 software administrators manage server certificates. See *Certificates* on page 46 for a description of certificate types and procedures to manage certificate policy and the system trust store.

Security alerts

The DSView 3 software uses SSL (Secure Sockets Layer) to securely communicate between the DSView 3 software hub server and DSView 3 software clients. SSL provides secure authentication using certificates, which is data that identifies the PC with which communication will occur. A certificate is typically verified by another certificate from a trusted certificate authority.

When the DSView 3 software is initially installed, it generates a self-signed certificate for use with DSView 3 software clients. To replace this, a DSView 3 software administrator may create a Certificate Signing Request (CSR) to submit to a trusted third party Certificate Authority (CA) for signature. The administrator may then replace the generated certificate with the new one. If the generated certificate is not replaced, the web browser will prompt a user whether to trust the generated certificate when a DSView 3 software client session is started.

Three tests are performed on a certificate each time a DSView 3 software client connects to the DSView 3 software hub server:

- Does the client web browser trust the certificate issuer?
- Has the certificate expired?
- Does the name on the DSView 3 server certificate match the name the DSView 3 software client used to access the DSView 3 server?

A Security Alert dialog box will appear if the answer to any of the three questions is No. To prevent the Security Alert message box from appearing when you connect to a the DSView 3 software hub server, all three questions must be answered Yes. When a Security Alert dialog box appears, you have the following choices:

- If you click *Yes*, a connection will be made with the DSView 3 software hub server and the DSView 3 software login window will appear, but the Security Alert dialog box will continue to appear each time you connect to the hub server.
- If you click *No*, a connection will not be made with the DSView 3 software hub server.

- If you click *View Certificate*, you may install the certificate; see below.

To correct certificate security alerts for client and hub server connections:

1. From the DSView 3 software client, open a client session; see *Opening a client session* on page 17. The Security Alert dialog box will appear.
2. Click *View Certificate*. The Certificate dialog box will appear.
3. Click *Install Certificate*. See the Internet Explorer documentation for more information.
4. Once the certificate is installed, ensure that the time setting on the DSView 3 software client PC is within the Valid from...to... dates and that the Issued to and Issued by fields exactly match.

Invalid to...from dates typically occur when the DSView 3 software is installed on a server that is set to an invalid time. When a DSView 3 software client that is set to a valid time connects to the DSView 3 server that is set to an invalid time, the following warning will appear in the Security Alert dialog box: "The security certificate date is invalid."

Serial session security alerts

The Serial Session Viewer, which is used during a serial session, is a Java-based applet. Three certificate tests are performed by Java when the DSView 3 software connects to a serial device:

- Does the serial device trust the certificate issuer?
- Has the certificate expired?
- Does the name on the serial device certificate match the name of the DSView 3 software hub server certificate?

A warning dialog box will appear if the answer to all three questions is No. To prevent this warning dialog box from appearing when you connect to a serial device, all three questions must be answered Yes.

To correct certificate security alerts when connecting to a serial session:

1. In a Units View window that contains serial console appliance target devices (see *Accessing Units View windows* on page 106), click the *Serial Session* link in the Action field.
You can also access a Unit Overview window for a target device and click the *Serial Session* icon or link for the session type (see *Unit Overview Windows* on page 112).
2. If the certificate is trusted and has not expired, but there is a mismatch of the name on the DSView 3 software client certificate and the name on the DSView 3 software hub server certificate, a Warning - HTTPS dialog box will appear. Contact the issuer of your certificate.
3. When a Warning - Security dialog box appears, you have the following choices:
 - If you click *Yes*, a connection will be made with the appliance and the viewer will open, but the warning dialog box will continue to appear each time you connect to the serial console appliance.
 - If you click *No*, a connection will not be made with the serial console appliance.
 - If you click *Always*, the certificate will be added to the Java certificate store.

To create a CSR:

1. Click the *System* tab.
2. Click *Certificate* in the side navigation bar. The DSView Server Certificate Properties window will open.
3. Click *Get CSR*. A File Download dialog box will appear.
4. Click *Open*. The CSR is downloaded and displays in the configured text editor.
-or-
Click *Save*. The Save As dialog box will appear. Select a directory and filename and click *Save* to save the CSR.
5. Submit the CSR generated request to a CA to obtain a signed server certificate.
6. Update the DSView 3 server to use the certificate created by the CA.

To update certificate information on the DSView 3 server:

NOTE: You may also update a spoke server certificate on a hub server and update a hub server certificate on a spoke server; see *Managing hub and spoke server certificates* on page 64.

1. Click the *System* tab.
2. Click *Certificate* in the side navigation bar. The DSView Server Certificate Properties window will appear.
3. Click *Update*. The Update DSView Server Certificate Wizard will appear.
4. The Select Operation to Perform window will open.
 - Select *Create a new self-signed SSL server certificate* to create a minimal security SSL certificate without incurring the costs and overhead involved with a Certificate Authority (CA). Click *Next*, then go to step 5.
 - Select *Import a signed SSL server certificate* to import a more secure SSL certificate that has been approved (perhaps by a CA). The public key of the imported certificate must match the public key in the certificate that the DSView 3 server is currently using. This requires that both certificates be made on the same DSView 3 server. Click *Next*, then go to step 6.
5. The Type in Certificate Information window will open.
 - a. Type the name of the computer that will serve as the DSView 3 server on your intranet in the Common Name field. If the DSView 3 server is outside the intranet, type the server's full domain name in dot notation format (xxx.xxx.xxx.xxx).
 - b. Type the name of the organization (or country).
 - c. Type the name of the organizational division or name under which the organization is doing business.
 - d. Type the complete city or location name. The City or Location field is required for organizations registered only at the local level.

- e. Type the complete name of the state or province where the organization is located.
 - f. Type the two-character ISO country code for the country where the organization is located.
 - g. Click *Next*. Go to step 7.
6. The Select Certificate to Import window will open.
Type the full directory and filename for the SSL certificate file you wish to import to the DSView 3 server or browse to the file location.
The name of the SSL certificate file must be entered in case sensitive text if your operating system supports case sensitive filenames.
Imported certificates must have been generated from a CSR created on the same DSView 3 server to which you are importing the certificate.
- h. Click *Next*.
7. The Completed Successful window will open.
8. Click *Finish*. The DSView Server Certificate Properties window will open, containing updated certificate information.

Managing hub and spoke server certificates

When a spoke server is registered with a hub server, a certificate trust relationship is established between the two servers. Certificate information must match on the hub server and the spoke servers for communication to take place between the servers. If the spoke server certificate is subsequently changed, a certificate mismatch will occur.

To update the certificate of a spoke server on the hub server:

NOTE: Certificates may only be viewed by DSView 3 software administrators and user administrators.

1. On the hub server, click the *System* tab. *DSView Server* will automatically be selected in the top navigation bar and the name of the DSView 3 software hub server will appear at the top of the side navigation bar.
2. Click *Spoke Servers* in the side navigation bar. The Spoke Servers window will open.
3. In the Spoke Servers window, click *Certificate*. The Spoke Server Certificate window will open including information about the spoke server certificate (Actual Certificate) and the certificate registered for this spoke server on the hub server (Registered Certificate).
4. The window displays the certificate on the spoke server and the certificate registered on the hub server.

If the DSView 3 management software cannot obtain the certificate information from the spoke server, a message will appear at the bottom of the DSView Server Certificate - Spoke Server window. The message states: *Remote server is not responding. Information displayed may not match remote side.*

- If the certificate information does not match, go to step 5.

- If the certificate information matches, go to step 6.
5. Click *Update*. The spoke server certificate information will be updated on the hub server.
 6. Click *Close*. The Spoke Servers window will open.

To update the certificate of a hub server on a spoke server:

1. On the spoke server, click the *System* tab. *DSView Server* will automatically be selected in the top navigation bar and the name of the spoke server will appear at the top of the side navigation bar.
2. Click *Hub Server* in the side navigation bar. The Hub Server window will open.
3. In the Hub Server window, click *Certificate*. The Hub Server Certificate window will open including information about the spoke server certificate (Actual Certificate) and the certificate registered for this spoke server on the hub server (Registered Certificate).

If the DSView 3 software cannot obtain the certificate information from the hub server, a message will appear at the bottom of the DSView Server Certificate - Hub Server window. The message states: *Remote server is not responding. Information displayed may not match remote side.*

If the certificate information does not match, go to step 4.

4. Click *Update*. The hub server certificate information will be updated on the spoke server.

Avocent proxy server

The Avocent proxy server is valid on supported KVM switches or serial console appliances.

NOTE: The Avocent proxy server is not supported when using the IPv6 network protocol on Windows platforms.

To specify the Avocent proxy server:

1. Click the *System* tab.
2. Click *Proxy Server* in the side navigation bar. The DSView Server Proxy Properties window will open.
 - a. The preset port 1078 is used for DSView 3 software client communication with the Avocent proxy to the logged in DSView 3 server. If you wish to change the port, enter a port value in the range 1-65535 in the Port field.

If DSView 3 software clients are located on an external connection, the specified TCP/IP proxy port must be opened on your firewall.
 - b. Select the type of Proxy Invocation:
 - Click *Disable the proxy server* to allow all internal and external DSView 3 software clients to communicate directly with the managed appliances. (This is the default.)
 - Click *Use the proxy server for all KVM, serial and virtual media sessions* to enable all DSView 3 clients to communicate with the managed appliances using the DSView 3 software proxy server.

- Click *Use the proxy server only for clients not on the same network as this DSView Server* to enable all external and internal clients on a different network than the current DSView 3 server to communicate with the managed appliances using the DSView 3 proxy server. All other external and internal clients will communicate directly with the managed appliances.
- Click *Use the proxy server only for clients connecting with the following addresses* to enable only DSView 3 software clients with IP addresses entered in the Address List to communicate with the managed appliances using the DSView 3 proxy server. All other clients communicate directly with the managed appliances.

NOTE: Changing the Proxy Port or Proxy Invocation setting will disconnect active DSView 3 client sessions.

3. Click *Save*. A confirmation dialog box will appear.
4. Confirm or cancel the action.

Server trap destinations

To specify trap destinations:

1. Click the *System* tab.
2. Click *Trap Destinations* in the side navigation bar. The DSView Server Trap Destinations window will open.
3. In each address field, type the IP addresses in standard dot notation (xxx.xxx.xxx.xxx) or the domain name for the computer that handles traps. Up to four computers may be specified.
4. Click *Save* to store the trap information in the DSView 3 software database on the host.

Client session information

To specify client session information:

1. Click the *System* tab.
2. Click *DSView Client Sessions* in the side navigation bar. The DSView Server Client Session Properties window opens. The number of client sessions currently in use is displayed.
3. Use the arrows to specify a time-out value (from 5-60 minutes) for inactivity of a DSView 3 user client session. The default is 15 minutes. When the time-out value has been exceeded, the session will end and the user must log in again.
4. Check the *Enable certificate authentication* checkbox to allow the DSView 3 software to automatically log in internal users if the user certificate (X.509 digital ID) installed in the DSView 3 software client web browser matches the certificate configured for the user. Certificates for users may be modified. See *User certificates* on page 235.

Web browser settings may need to be modified to allow users to automatically log in using certificates; see your web browser documentation.

-or-

Check the *Enable Integrated Windows® Authentication* checkbox to automatically log a user into the DSView 3 software using the Windows user's computer credentials.

Web browser settings may need to be modified to allow users to automatically log in using Integrated Windows Authentication; see your web browser documentation.

5. To enable only DSView 3 software clients with IP addresses entered in the Address List to communicate with managed appliances, check the *Restrict by address range* checkbox. To disable address restrictions for logging into the DSView 3 software, uncheck this checkbox.
6. Enable or disable *Allow login when user is a member of more than one authentication service* as desired. The preset value is disabled. When enabled, if a user belongs to multiple authentication services, the DSView 3 server uses the first authentication service found to log the user in. When disabled, if a user belongs to multiple authentication services, the attempt to log in to the DSView 3 software fails.

When enabled, if a user has different access rights within each authentication service he belongs to, the user is granted access rights based on the first authentication service found by the DSView 3 server. In this case, a user may be granted different access rights at different login times.

NOTE: The *Allow login when user is a member of more than one authentication service* setting does not replicate to spoke servers. It is recommended that you uniformly enable or disable this setting on each DSView 3 hub and spoke server.

7. Click *Save* to store client session information in the DSView 3 software database on the host.

DSView 3 software modem sessions

For more information about modem sessions, see *Active modem sessions* on page 179.

NOTE: Modem sessions are available on supported ACS console servers.

To specify modem session properties:

1. Click the *System* tab.
2. Click *DSView Modem Sessions* in the side navigation bar. The DSView Server Modem Session Properties window will open.
3. Specify the following Session Timeout properties:
 - a. Inactive dial-up session timeout - in the drop-down menu, specify the number of seconds in the range of 60-3600 after which the session will be terminated. The default value is 120 seconds.
 - b. Dial-up connection attempt timeout - in the drop-down menu, specify the number of seconds in the range of 60-600 after which the attempt will be terminated. The default value is 120 seconds.
 - c. Dial-back connection attempt timeout - in the drop-down menu, specify the number of seconds in the range of 60-600 after which the modem will be removed from listening mode. The default value is 120 seconds.

4. Specify the following Dial Up settings:
 - a. In the Server Prefix field, type the dial-up prefix for the DSView 3 server to obtain an outside line. This prefix will be added to the unit phone number.
 - b. Enter the IP address range to be used in dial-up connections in the From address and To address fields.
5. Specify the following Dial Back Settings:
 - a. In the Analog phone number field, type the analog phone number for the appliance to dial-back to the DSView 3 server. This number will be stored in the DSView 3 software database and automatically updated on the ACS console server.
 - b. In the Analog on hook time field, specify the on hook interval in the range of 0-25 seconds. The default value is 4 seconds. The on hook interval is the amount of time after the initial dial-up connection is dropped before the modems on the DSView 3 server will receive incoming calls.
 - c. Use the ISDN controller map field to define the map of Multiple Subscriber Numbers (MSNs) to ISDN channels. Enter the controller map definition for each port sequentially on a separate row in the text field. Use the following format:
<port number>:<MSN1>,<MSN2>
For example, if an Eicon card has one port, and MSN 21 is assigned to ISDN channel 1 on port 1, and MSN 22 is assigned to ISDN channel 2 on port 1, the text in the ISDN controller map field would be:
1:21,22
A controller map definition must be provided for each ISDN dial-back phone number.
 - d. In the ISDN phone number field, enter the Integrated Services Digital Network (ISDN) phone number for the appliance to dial-back to the DSView 3 server. You may enter multiple dial-back phone numbers each separated by a comma. The number(s) will be stored in the DSView 3 software database and automatically updated on the ACS console server.
 - e. In the ISDN on hook time field, specify the on hook interval in the range of 2-10 seconds. The default value is 2 seconds. The on hook interval is the amount of time after the initial dial-up connection is dropped before the modems on the DSView 3 server will receive incoming calls.

NOTE: If your DSView 3 server is on Windows, the ACS console server username and password must be configured as a user in Windows before a dial-back connection can be established.

6. Click *Save*.

Email

To specify email properties:

1. Click the *System* tab.

2. Click *Email* in the side navigation bar. The DSView Server Email Server Properties window will open.
3. Type a new address for the SMTP server that sends email notifications as a domain name or an IP address in standard dot notation (xxx.xxx.xxx.xxx).
4. If your SMTP server requires login credentials, select *Login required to access SMTP server* and type a username and password, then confirm the password.
5. Click *Save* to store DSView 3 software email property information in the DSView 3 software database on the host.

Unit status polling

To use unit status polling:

1. Click the *System* tab.
2. Click *Unit Status Polling* in the side navigation bar. The DSView Server Unit Status Polling Properties window will open.
3. Select *Enable unit status polling*.
4. Type the number of seconds to wait between polling cycles (from 30-999 seconds). The default is 900 seconds (15 minutes). A smaller value results in greater accuracy.
5. Type the number of managed appliances that may simultaneously be polled to obtain status information (from 1-25 units). The default is 5. A larger number results in faster speed.
6. Click *Save* to store unit status information in the DSView 3 software database on the host.

Backing up and Restoring Hub Servers Manually

You may manually create a backup of your hub server. Two methods are available:

- From a command line in an MS-DOS window. This method may be used for DSView 3 software hub servers on supported Windows or Linux systems.
- Using the Backup and Restore Utility delivered with the DSView 3 software. The backup is saved as a .zip file containing the files needed to restore the DSView 3 management software. This method may be used for DSView 3 software hub servers on supported Windows systems only.

Client sessions will be temporarily disconnected during a manual backup. The sessions will be automatically reconnected when the backup is completed.

Hub server backups may also be automatically created as a task within the DSView 3 software. If you use the Backup DSView database and system files task, client sessions will not be temporarily disconnected. See *Task: Backup DSView 3 software database and system files* on page 323.

Manual backup and restore procedures require DSView 3 software administrator privileges.

To manually backup or restore a hub server using a command line on a supported Windows system:

1. In the Start menu on your desktop, select *Start - Programs - Accessories - Command Prompt*. A command prompt window will open.
2. Change directories to the directory in which the DSView 3 software is installed (typically `C:\Program Files\Avocent DSView 3\bin`).
3. Enter **DSViewBackupRestore** to display the DSView 3 Backup/Restore Utility dialog box. Follow the directions in *To manually back up a hub server using the Backup and Restore Utility dialog box* to back up the hub server using the dialog box or *To manually restore a hub server using the Backup and Restore Utility dialog box* to restore the hub server using the dialog box. (These procedures are described later in this section.)

-or-

To backup the DSView 3 software hub server, enter **DSViewBackupRestore -backup -archive "<archive name>" -passwd <password>**.

-or-

To restore the DSView 3 software hub server, enter **DSViewBackupRestore -restore -archive "<archive name>" -passwd <password>**.

"<archive name>" - Name of the archive, which must be enclosed by quotation marks (for example, "myarchive"). The -archive option and an archive name are required.

<password> - A password that encrypts the archive. The password is optional when creating a backup. If a password is specified when creating the backup, it will be required when restoring the backup.

To display help information, type **DSViewBackupRestore -h** or **DSViewBackupRestore -help**.

For example, entering the following in a command prompt window will create a backup named db.zip with the password test.

```
DSViewBackupRestore.exe -backup -archive "db.zip" -passwd test
```

Entering the following in a command prompt window will restore a backup named db.zip with the password test.

```
DSViewBackupRestore.exe -restore -archive "db.zip" -passwd test
```

To manually backup or restore a hub server using a command line on a supported Linux or Solaris system:

1. Access the command prompt on your system.
2. Change directories to the directory where the DSView 3 software is installed, which is typically `/usr/local/dsviewserver/bin`.
3. To backup the DSView 3 software hub server, enter **DSViewBackupRestore.sh -backup -archive <archive name> -passwd <password> -overwrite**.

- To restore the DSView 3 software hub server, enter **DSViewBackupRestore.sh -restore -archive <archive name> -passwd <password>**.

<archive name> - Name of the archive. The -archive option and an archive name are required.

<password> - A password that encrypts the archive. The password is optional when creating a backup. If a password is specified when creating the backup, it will be required when restoring the backup.

-overwrite - Enables overwriting of an existing archive during backup. If this parameter is omitted, no overwriting will occur.

To display help information, type **DSViewBackupRestore.sh -help**.

For example, entering the following in a command prompt window will create a backup named `dbasebackup.zip` with the password `test1`.

```
DSViewBackupRestore.sh backup -archive dbasebackup.zip -passwd test1
```

Entering the following in a command prompt window will restore a backup named `dbasebackup.zip` with the password `test1`.

```
DSViewBackupRestore.sh restore -archive dbasebackup.zip -passwd test1
```

To manually back up a hub server using the Backup and Restore Utility dialog box on a supported Windows system:

- In the Start menu on your desktop, select *Start - Programs - Avocent DSView 3 - Backup and Restore Utility*. The DSView 3 Backup/Restore Utility dialog box will appear.
- Click *Backup Database to a file*.
- To password-protect the backup file, click *Enabled* and type a password in the Password field.
- Click *Browse* and use the Save As dialog box to specify a directory and name for the backup file. Click *Save* when you are finished.
- Click *Backup*. The DSView 3 software system backup files are saved.
- Click *Close* to close the DSView 3 Backup/Restore Utility dialog box.

To manually restore a hub server using the Backup and Restore Utility on a supported Windows system:

- In the Start menu on your desktop, select *Start - Programs - Avocent DSView 3 - Backup and Restore Utility*. The DSView 3 Backup/Restore Utility dialog box will appear.
- From the DSView 3 Backup/Restore Utility dialog box, click *Restore the database from a file*.
- If the backup file is password-protected, click *Enabled* and type its password in the Password field.
- Click *Browse* and use the Save As dialog box to find the backup file.
- Click *Restore*. The DSView 3 software system is restored from the backup files.
- Click *Close* to close the DSView 3 Backup/Restore Utility dialog box.

Spoke Servers

Information on the hub server is replicated on one or more spoke servers. Information about each spoke server, such as IP address, port number and certificate, is stored in the hub server's database.

You may specify up to 15 computers as spoke servers. Contact Avocent for information about spoke server licenses. To install licenses, see *Licenses* on page 54.

NOTE: The DSView 3 management software versions of the spoke server and hub server must match in order to register a spoke server. For example, you may not register a spoke server running DSView 3 software version 3.1 with a hub server running DSView 3 software version 3.2.

A spoke server may be created by:

- Specifying a spoke server when installing the DSView 3 software.
- Converting a hub server to a spoke server by registering it as a spoke to another DSView 3 software hub server. The DSView 3 software system data on the hub server being converted will be lost and the converted hub server will replicate the data of the new specified hub server.

You may also change the properties of a spoke server or remove spoke servers from your system.

To display a list of spoke servers:

NOTE: The Spoke Servers window is only available on the hub server.

1. Click the *System* tab.
2. Click *DSView Server* in the top navigation bar. The side navigation bar will include the name of the server to which you are logged in.
3. Click *Properties* in the side navigation bar, and then click *Spoke Servers*. The Spoke Servers window will open.

You may change the fields that display by using the *Customize* link. See *Using the Customize link in windows* on page 28.

Each spoke server in the list includes status.

Table 5.2: DSView 3 Software Spoke Server Status

Status	Cause
Responding	Normal operation. The hub and spoke servers are communicating with each other using HTTPS.
Not responding	The hub and spoke servers cannot communicate with each other using HTTPS. This typically indicates a network communication error. Ensure that network connectivity is occurring between the two servers.
Hub/Spoke Versions Not Compatible	The versions of DSView 3 software on the hub and spoke servers are not compatible.

Table 5.2: DSView 3 Software Spoke Server Status (Continued)

Status	Cause
Certificates Do Not Match	Certificates on the hub server and spoke servers do not match. See <i>Managing hub and spoke server certificates</i> on page 64 for information about updating the server certificates so that they will match.
Invalid Server or Versions Not Compatible	A server responded, but it is not compatible with the DSView 3 software. This typically occurs when communication is attempted with a server that does not contain the software, or if either server contains an older version of the software. Ensure that both servers are running the same DSView 3 software version.

To add a spoke server:

1. Install the DSView 3 software on the computer that will be used as a spoke server. See *Installing the DSView 3 Software* on page 10.
2. Configure the computer as a spoke server. See *Configuring the DSView 3 Software* on page 14.

To register a hub server as a spoke server:

Only DSView 3 software administrators may access this procedure.

NOTE: When registering a hub server as a spoke server on another DSView 3 software system, the information on the hub server being registered will be lost. Its database will be updated to match the new hub server to which it is being registered.

1. Click the *System* tab.
2. Click *DSView Server* in the top navigation bar. The side navigation bar will include the name of the server to which you are logged in.
3. Select *Tools* in the side navigation bar. The DSView Server Tools window will open.
4. Click the *Register as Spoke Server* icon or text. The Register Spoke Server Wizard will appear.
5. The Type in Hub DSView Server Address window will open.
 - a. Type the IP address of the hub server in standard dot notation (xxx.xxx.xxx.xxx) or the domain name of the hub server.
 - b. Type the port number for the hub server.
 If the default hub server port value (443) is modified, you must specify it when registering a spoke server so that register requests will be sent to the correct port on the hub server. For example, if the IP address of the hub server is 10.0.0.1 and the port number is changed to 444, type **https://10.0.0.1:444/dsview** in the Address field of the Register Spoke Server Wizard.
 - c. Click *Next*.
6. The Operation in Progress window will open briefly, followed by the Accept Hub DSView Server Certificate window. Click *Next*.
7. The Type in Hub DSView Server Administrator Credentials window will open. Click *Next*.

8. Type the name of a user with DSView 3 software administrator privileges on the hub server. Type a password for the user. Click *Next*.
9. The Operation In Progress window will open. The configuration of the spoke server will be saved to the database of the hub server and the spoke server's certificates will be installed on the hub server.
10. The Completed Successful window will open when the spoke server has been added.
11. Click *Finish*.

To change spoke server network properties:

NOTE: Spoke server network settings may need to be changed by DSView 3 software administrators when network settings are changed and the hub server did not automatically detect the changes. When changing the network settings, ensure that a port mismatch does not occur between the hub server and the spoke server.

1. On the hub server, click the *System* tab.
2. Click *DSView Server* in the top navigation bar. The side navigation bar will include the name of the server to which you are logged in.
3. Click *Properties* in the side navigation bar, and then click *Spoke Servers*. The Spoke Servers window will open.
4. Click on the name of the spoke server whose network properties you wish to change. The Spoke Server Network Properties window will open.
5. Change any of the following network settings:
 - Type a new computer name to use as the spoke server.
 - Type a new address in standard dot notation (xxx.xxx.xxx.xxx) for the spoke server.
 - Type a new port number for the spoke server.
6. Click *Save* and then click *Close*. The Spoke Servers window will open.

To delete a spoke server:

1. On the hub server, click the *System* tab.
2. Click *DSView Server* in the top navigation bar. The side navigation bar will include the name of the server to which you are logged in.
3. Click *Properties* in the side navigation bar, and then click *Spoke Servers*. The Spoke Servers window will open.
4. Click the checkbox to the left of the spoke servers you wish to delete. To delete all spoke servers, click the checkbox to the left of Name at the top of the list.
5. Click *Delete*. A confirmation dialog box will appear.
6. Confirm or cancel the deletion.

NOTE: When a spoke server is deleted, it is no longer allowed to communicate with the hub server. Only spoke servers that are no longer active should be deleted. If a spoke server is still active, it may be re-registered using the Register Spoke Server wizard.

Promoting spoke servers

Promoting a spoke server to be a hub server is usually done only if the current hub server is no longer operational and will not be brought back into service. (For less severe problems with a hub server, the backup and restore operations can be used.)

If a spoke server must be promoted, be sure to run the replication task, if possible (see *Replication* on page 75) on all other spoke servers, then on the spoke server being promoted, immediately before the promotion. This will prevent loss of data from the other spoke servers.

(After the promotion of a spoke server to a hub, if the server that was originally the hub becomes operational again, it will have to register as a spoke server, since a system can have only one hub server.)

To promote a spoke server to be a hub server:

1. On the spoke server, click the *System* tab.
2. Click *Tools* in the side navigation bar.
3. Click *Promote to hub server*. The Promote Hub Server Wizard will appear.
4. Follow the prompts and heed the cautionary warnings in the wizard. The spoke server on which the wizard is running will become the hub server, and the other spoke servers will be advised of the changed configuration.

Replication

Replication is a task that synchronizes the hub and spoke server databases. By default, replication runs every 12 hours on each spoke server. A spoke server's first replication occurs automatically when the spoke server is added to the DSView 3 software system. You may change the interval that the replication task runs on each spoke server, or you may initiate an immediate replication.

During replication, the spoke server sends all of its database changes since the last replication to the hub server. The hub server then incorporates those changes and sends all of its database changes since the last replication to the spoke server (excluding the changes that spoke server just sent to the hub server).

If an item is added on a spoke server, and another item with the same name (but perhaps with different configuration parameters) is added on the hub server, then after replication, both items will appear on both the hub and spoke servers, with a tilde (~) and a number added to one of the names. The administrator should handle the issue appropriately - in some cases, the duplicate item may need to be renamed; in others, the duplicate item should be deleted.

When different changes are made to one existing item, two outcomes are possible. For example, assume an item is added and configured on the hub server and is then replicated to the spoke server. Later, an administrator changes something about the item on the spoke server. Another administrator then changes something about the item on the hub server. When the replication task runs, two things may happen.

In a few instances where no conflict occurs, both changes will be incorporated and replicated. For example, if the hub server's administrator adds username JaneDoe to the existing user-defined user

group Accounting and the spoke server's administrator adds username JohnDoe to the Accounting user group, both names will be added and replicated.

In most other instances where the changes are mutually exclusive or some other conflict occurs, the most recent change will be the only change accepted and replicated. For example, if the hub server's administrator associates a unit with the Miami site, and the spoke server's administrator associates the same unit with the Chicago site, the change that was made closest to the time of replication (that is, the most recent change) will be accepted and replicated.

This emphasizes the importance of ensuring the hub and spoke servers' clocks are synchronized.

The exception to the last-change rule is when one of the actions deletes an item - in that case, the deletion is accepted and replicated, regardless of timing. For example, if a unit was deleted on the hub server, and then the contact information for the same unit was changed on the spoke server a minute later, the unit will be deleted when the replication task is run.

On a spoke server, you may enable a replication task property that forces the spoke server to retrieve a snapshot of the hub database rather than synchronizing changes back and forth. The snapshot is a copy of the hub at the time of the operation. This feature is not normally used; it is intended to help recover a system when replication has failed.

To display replication results and/or change the replication schedule for a spoke server:

1. On the spoke server, click the *System* tab.
2. Click *Tasks* in the top navigation bar. The Tasks window will open.
3. Select the *Database Replication* task. The Task Results - Database Replication window will open. This window contains the results of the most recent replication.
4. To display or change the replication schedule, click *Schedule* in the side navigation bar. The Task Schedule - Database Replication window will open.

By default, the replication task runs every 12 hours. You may change the schedule type, start time, date and interval.

5. To force the spoke server to retrieve a snapshot of the hub database rather than synchronizing changes, click *Properties* in the side navigation bar and then click the *Perform a hub database snapshot the next time this task executes* checkbox. This setting will be reset to unchecked after the operation completes.
6. If you made any changes, click *Save* and then *Close*.

You may also display the replication schedule from the hub server, but you cannot change it.

To initiate an immediate replication on a spoke server:

1. On the spoke server, click the *System* tab.
2. Click *Tasks* in the top navigation bar. The Tasks window will open.
3. Check the checkbox to the left of the Database Replication task and then click *Run Now*.

To display the replication schedule for a spoke server from the hub server:

1. On the hub server, click the *System* tab.
2. Click *Tasks* in the top navigation bar.
3. Select the *Database Replication* task for the spoke server you wish to view. The Task Schedule - Database Replication window will open.

Authentication Services

Users must be authenticated before they may access or perform any tasks in the DSView 3 management software system.

When users log in, they will be prompted for a username and password. The DSView 3 software will look up the login, determine the authentication service to use and forward the login credentials to the appropriate authentication service for verification. All authentication is performed over an HTTPS (SSL) encrypted link.

Some web browsers may store password information; see your web browser documentation.

Supported Authentication Services

The DSView 3 software is delivered with the DSView internal authentication service, which verifies a log in and password against user account information stored in the database on the DSView 3 software server.

The DSView 3 software also supports the following external authentication services:

- Microsoft Active Directory® *
- IBM® SecureWay® Directory Server *
- Novell® LDAP Services *
- Sun Solaris R9 LDAP Directory Server *
- Sun ONE™ LDAP Directory Server *
- Microsoft Windows NT domain
- Cisco® Secure ACS 3.3 for Windows 2000/2003 server
- Microsoft IAS for Windows 2000/2003 server
- FreeRADIUS for Red Hat RHL3
- Cisco Secure ACS 3.3 for Windows 2000/2003 server
- RSA SecurID®

* Uses LDAP V3

If the DSView 3 server is configured for external authentication, login requests are re-directed to the configured external authentication server.

The DSView 3 software obtains external group membership and external user information when a user logs in. If a user's group membership changes or the user is deleted externally, the DSView 3 software will not see these changes until the next time the user logs in.

You may schedule a task that will automatically verify LDAP, Active Directory and NT external authentication servers to ensure that accounts are still valid; see *Task: Validating user accounts on an external authentication server* on page 330.

Authentication services may be managed only by DSView 3 software administrators and user administrators.

To display configured authentication services:

1. Click the *Users* tab.
2. Click *Authentication Services* in the top navigation bar. The User Authentication Services window will open.

The User Authentication Services window may be customized by using the Customize link. See *Using the Customize link in windows* on page 28.

To remove authentication services:

NOTE: The internal authentication service cannot be removed.

1. Click the *Users* tab.
2. Click *Authentication Services* in the top navigation bar. The User Authentication Services window will open.
3. Check the checkbox to the left of the authentication service(s) to delete. To delete all external authentication services on the page, check the checkbox to the left of Name at the top of the list.
4. Click *Delete*. A confirmation dialog box will appear.
5. Confirm or cancel the deletion.

DSView 3 software internal authentication service

To change the DSView 3 internal authentication service account policies:

1. Click the *Users* tab.
2. Click *Authentication Services* in the top navigation bar. The User Authentication Services window will open.
3. Click *DSView Internal*. The side navigation bar will change to include DSView Internal at the top and, below the name, the information you may define.
4. Click *Account Policies*. The Authentication Service User Account Policies - DSView Internal window will open.
5. Specify the password policies for the authentication service:

- a. Type a number (from 1-64) in the Minimum Password Length field, or click the arrows to select a number.
 - b. Check the *Passwords Expire* checkbox to require a user to change the password after a certain number of days. Specify a number (from 1-365) in the Maximum Expiration (days) field, or select a number.
 - c. Select *Passwords must contain both alpha and numeric characters* if new passwords must contain at least one letter and one number.
 - d. Select *Passwords must contain both lower and upper case characters* if new passwords must contain at least one uppercase and one lowercase letter.
6. Specify the lockout policy for the authentication service:

To assign a specific number of user login attempts, check the *Lockout users after invalid login attempts* checkbox, then continue with step a.

If you leave this checkbox unchecked, unlimited user login attempts will be allowed. Skip to the last step.

- a. Type the number of allowable user login failures (from 1-25) in the Maximum Login Failures field, or select it from the menu.
- b. To permit user logins after a certain period of time, check the *Automatically unlock users after the lockout period* checkbox. Specify the lockout period (in minutes) by typing a number from 1-1,440 in the Maximum Lockout Period (minutes) field, or choose a value from the menu (1,440 minutes is equivalent to 24 hours).

If you leave this checkbox unchecked, locked user accounts must be manually unlocked by a DSView 3 software administrator or user administrator.

See *Unlocking User Accounts* on page 233.

7. Click *Save* and then click *Close*. The User Authentication Services window will open.

To change custom field labels for user accounts that use internal authentication:

1. Click the *Users* tab.
2. Click *Authentication Services* in the top navigation bar. The User Authentication Services window will open.
3. Click *DSView Internal*. The side navigation bar will change to include DSView Internal at the top and, below the name, information you may define.
4. Click *Custom Field Labels* in the side navigation bar. The Authentication Service User Account Custom Field Labels - DSView Internal window will open.
5. Type the text that you wish to appear in each of the six custom field labels.
6. Click *Save* and then click *Close*. The User Authentication Services window will open.

By default, the custom field labels do not display in the User Accounts - All window, but they may be added to the display (or added to the default display by an administrator), using the *Customize* link. See *Using the Customize link in windows* on page 28.

Active Directory external authentication service

NOTE: When adding an Active Directory external authentication service, you can allow trusted forests to be discovered. A forest is a group of domains, and a forest may have a trusted relationship with other forests. In some configurations, a user may belong to one forest but be assigned to groups in another forest. The DSView 3 server needs access to both forests to authenticate and authorize this user.

To add an Active Directory external authentication service:

1. Click the *Users* tab.
2. Click *Authentication Services* in the top navigation bar. The User Authentication Services window will open.
3. Click *Add*. The Add Authentication Service Wizard will appear.
4. The Provide Authentication Service Name and Type window will open.
 - a. Type a name for the external authentication service.
 - b. Select *Active Directory* from the menu.
 - c. Click *Next*.
5. The Specify Active Directory Connection Settings window will open.
 - a. Type the Active Directory domain name for the domain you wish to add in the AD Domain Name field.
 - b. In the User Container field, specify the name of the container to search for user accounts. This will limit the search scope to that container. The name may be entered in several forms, optionally including a sub-domain. Valid forms are explained below by example. Assume an Active Directory domain name of “sunrise.mycompany.com” with users in subfolder “sun/myusers.” The User Container field may be entered as:

Example 1 (no sub-domain): “sun.myusers”
Example 2 (no sub-domain): “ou=myusers,ou=sun”

If users are contained in a sub-domain such as “mktg.sunrise.mycompany.com”, valid forms are:

Example 1 (with sub-domain): “mktg.sunrise.mycompany.com/sun/myusers”
Example 2 (with sub-domain and no container specified):
“mktg.sunrise.mycompany.com/”
Example 3 (with sub-domain):
“ou=myusers,ou=sun,dc=mktg,dc=sunrise,dc=mycompany,dc=com”
 - c. In the Group Container field, specify the name of the container to search for user groups. This will limit the search scope to that container. The name may be entered in several forms, optionally including a sub-domain. Valid forms are explained in step 5b above.
 - d. In the Username Type menu, select the type of username. Each choice in the menu contains an example.

A Full Windows 2000 username is specified as username@domain.

A Partial Windows 2000 username is specified as username.

A Full Pre-Windows 2000 username is specified as domain\username.

A Partial Pre-Windows 2000 username is specified as username.

This option may only be configured for new authentication servers; it cannot be modified. Existing authentication servers are set to the Partial Windows 2000 Username type for compatibility.

- e. Specify a Secure Socket Layer (SSL) encryption mode:
 - Click *Do Not Use SSL* to have authentication performed using unencrypted clear text instead of SSL encryption. This method is the least secure.
 - Click *Use SSL in Trust All Mode* to use SSL encryption for data transmission. All server certificates will be trusted and automatically accepted by the DSView 3 software for transmitting data. This SSL method provides medium security.
This encryption mode is not recommended for wide area networks (WANs).
 - Click *Use SSL in Certificate-based Trust Mode* to use SSL encryption for data transmission. The DSView 3 management software will approve the server and then the certificate before transmitting data. This SSL method provides maximum security.
- f. Click *Use Kerberos for User Authentication* to use the Kerberos protocol for authentication requests, including the browsing. If enabled, you must use DES encryption types for this account. If an account was created prior to Active Directory, the user's password must be changed after this setting is changed. In addition, the Active Directory server addresses must be resolvable to their host names via DNS.
When this is not checked, the LDAP protocol will be used.
- g. Click *Enable Chasing of Referrals* to allow the Active Directory server to refer DSView 3 software clients to additional directory servers.
- h. Click *Use an Active Directory Global Catalog* to have the AD service access the global catalog for the specified domain name.
- i. Click *Allow users and groups from newly discovered trusted forests* to allow logins by users that belong to the authentication service forest or its discovered trusted forests. If enabled, the DSView 3 will discover all trusted forests in the Active Directory service.
- j. Click *Next*.

If you selected *Use SSL in Certificate-based Trust Mode*, go to step 6.

If you selected *Do Not Use SSL* or *Use SSL in Trust All Mode*, go to step 8.

6. The DSView 3 server will try to find a server that has a trusted certificate chain (see *System certificate policy and trust store* on page 47). If no trusted certificate chain is found, then the Accept Certificate window will open and list all servers that belong to the domain. It will also list the reasons for rejection of the certificate chain.
7. Click *Next* to accept the certificate.
8. The Select Browsing Method window will open.

Click *Browse Anonymously* to browse users on the external Active Directory authentication server.

-or-

Click *Browse with user credentials* to browse users on the external Active Directory authentication based on credentials configured on the server. If this option is selected, do the following:

- a. Type the username for an Active Directory account that has browse rights in the User Name field. The login ID must be entered in case sensitive text if the Active Directory server is set up to use Kerberos. When using Kerberos, the browse account cannot be specified in the Full Pre-Windows 2000 Username form (domain\username). If the username is in a sub-domain of the Active Directory domain (specified in step 3a), then the username should be specified as <username>@<subdomain>.
 - b. Type the password for an Active Directory account that has browse rights in the Password field.
 - c. Click *Next*.
9. The Establish Connection with Authentication Service window will open briefly. If the external authentication service is added successfully, the Completed Successful window will open.
10. Click *Finish*. The User Authentication Services window will open with the new service listed.

NOTE: If the authentication service has trusted forests, the settings configured for the authentication service in the Add Authentication Service Wizard will be applied to the discovered trusted forests. However, the settings for each trusted forest can later be changed in the Authentication Service Connection Settings window.

See *User Authentication Services Window* on page 100 for more information about trusted forests.

To change settings for the Active Directory external authentication service:

1. Click the *Users* tab.
2. Click *Authentication Services* in the top navigation bar. The User Authentication Services window will open.
3. Click the name of the Active Directory (AD) service. The side navigation bar will change to include the name of the AD service at the top and, below the name, the information you may define.
4. Click *Connection* in the side navigation bar. The Authentication Service Connection Settings - AD window will open.
5. Type a name in the Service Name field to change the name of the service that appears in the Name column of the User Authentication Services window.
6. Type the domain name of the Active Directory service in the AD Domain Name field.
7. In the User Container field, specify the name of the container to search for user accounts. This will limit the search scope to that container. The name may be entered in several forms,

optionally including a sub-domain. See *To add an Active Directory external authentication service*: on page 82 for an explanation of the valid forms.

8. In the Group Container field, specify the name of the container to search for user groups. This will limit the search scope to that container. The name may be entered in several forms, optionally including a sub-domain. See *To add an Active Directory external authentication service*: on page 82 for an explanation of the valid forms.
9. Specify a Secure Socket Layer (SSL) Encryption mode:
 - Click *Do Not Use SSL* to have authentication performed using unencrypted clear text instead of SSL encryption. This method is the least secure.
 - Click *Use SSL in Trust All Mode* to use SSL encryption for data transmission. All server certificates will be trusted and automatically accepted by the DSView 3 software for transmitting data. This SSL method provides medium security.
This encryption mode is not recommended for wide area networks (WANs).
 - Click *Use SSL in Certificate-based Trust Mode* to use SSL encryption for data transmission. The DSView 3 software will approve the server and then the certificate before transmitting data. This SSL method provides maximum security.
10. Click *Use an Active Directory Global Catalog* to have the AD service access the global catalog for the specified domain name.
11. Click *Use Kerberos for User Authentication* to use the Kerberos protocol for authentication requests, including the browsing. If enabled, you must use DES encryption types for this account. If an account was created prior to Active Directory, the user's password must be changed after this setting is changed. In addition, the Active Directory server addresses must be resolvable to their host names via DNS.
When this is not checked, the LDAP protocol will be used.
12. Click *Allow use of Users/Groups from Trusted Forests* to allow logins by users belonging to a forest that are assigned to groups in a different forest. If enabled, the DSView 3 will query all trusted forests in the Active Directory service to find the user and user groups to which the authenticated user belongs.
If you deselect *Allow use of Users/Groups from Trusted Forests*, any previously discovered trusted forests will be hidden from the User Authentication Services window and users belonging to trusted forests will not be permitted to log in.
13. Click *Save* to save your changes.
 - If you selected *Use SSL in Certificate-based Trust Mode*, the Certificates heading will appear in the side navigation bar. Go to step 13.
 - If you selected *Do Not Use SSL* or *Use SSL in Trust All Mode*, go to step 16.
14. Click *Certificates*. The Authentication Service Certificate Management - AD window opens and list all servers in that domain. A status of Trusted indicates the certificate is trusted, based on the certificate policy (see *System certificate policy and trust store* on page 47); Untrusted indicates the certificate cannot be trusted.

15. To register certificates:
 - a. To select one or more certificates, click the checkbox to the left of the server IP addresses. To select all certificates on the page, click the checkbox to the left of the IP Address heading.
 - b. Click *Register* above the IP Address list to register the certificates. The Accept SSL Certificate window will open.
 - c. Click *Save* to store the certificate values to the DSView 3 software database on the host or click *Close* if you do not wish to save the certificate values.

The Authentication Service Certificate Management window will open if only one certificate was selected. If more than one certificate was selected, each will appear in order in subsequent Accept SSL Certificate windows.
16. To unregister certificates:
 - a. To select one or more certificates, click the checkbox to the left of the server IP addresses. To unregister all certificates, click the checkbox to the left of the IP Address heading.
 - b. Click *Unregister* to unregister the certificates.
 - c. A confirmation message box will appear. Confirm or cancel the operation.
17. Click *Close*. The User Authentication Services window will open.

To change user browsing settings for the Active Directory external authentication service:

1. Click the *Users* tab.
2. Click *Authentication Services* in the top navigation bar. The User Authentication Services window will open.
3. Click the name of the AD service. The side navigation bar will change to include the name of the AD service at the top and, below the name, the information you may define.
4. From the side navigation bar, click *User Browsing*. The Authentication Service User Browsing - AD window will open.
5. Click *Browse Anonymously* to browse users on the external Active Directory authentication server.

-or-

Click *Browse with User Credentials* to browse users on the external Active Directory authentication based on credentials configured on the server. If this option is selected, do the following:

- a. Type the username for an Active Directory account that has browse rights in the User Name field. The log in ID must be entered in case sensitive text if the Active Directory server is set up to use Kerberos.
- b. Type the password for an Active Directory account that has browse rights in the Password field.

NOTE: The DSView 3 server verifies that the new credentials are valid for the AD service. If the credentials are invalid, an error message is displayed.

6. Click *Save* and then click *Close*. The User Authentication Services dialog box will appear.

Windows NT external authentication service

To add a Windows NT external authentication service:

1. Click the *Users* tab.
2. Click *Authentication Services* in the top navigation bar. The User Authentication Services window will open.
3. Click *Add*. The Add Authentication Service Wizard will appear.
4. The Provide Authentication Service Name and Type window will open.
 - a. Type a name for the external authentication service.
 - b. Select *Windows NT Domain* from the menu.
 - c. Click *Next*.
5. The Specify Windows NT Connection Settings window will open. Type the Windows NT domain name you wish to add in the Domain Name field, and then click *Next*.
6. The Select Browsing Method window will open.

Click *Browse Anonymously* to browse users on the external Windows NT authentication server.

-or-

Click *Browse with user credentials* to browse users on the external Windows NT authentication based on credentials configured on the server. If this option is selected, do the following:

 - a. Type the username for a Windows NT account that has browse rights in the User Name field.
 - b. Type the password for a Windows NT account that has browse rights in the Password field.
 - c. Click *Next*.
7. The Establish Connection with Authentication Service window will briefly appear. If the external authentication service is added successfully, the Completed Successful window will open.
8. Click *Finish*. The User Authentication Services window will open with the new service listed.

To change connection settings for the Windows NT external authentication service:

1. Click the *Users* tab.
2. Click *Authentication Services* in the top navigation bar. The User Authentication Services window will open.

3. Click the name of the Windows NT service. The side navigation bar will change to include the name of the service at the top and, below the name, the information you may define.
4. Click *Connection* in the side navigation bar. The Authentication Service Connection Settings - NT window will open.
5. Type a name in the Service Name field to change the name of the service that appears in the Name column of the User Authentication Services window.
6. Type the name of the Windows NT domain in the Domain Name field.
7. Click *Save* and then click *Close*. The User Authentication Services window will open.

To change user browsing settings for Windows NT external authentication services:

1. Click the *Users* tab.
2. Click *Authentication Services* in the top navigation bar. The User Authentication Services window will open.
3. Click the name of the Windows NT service. The side navigation bar will change to include the name of the Windows NT service at the top and, below the name, the information you may define.
4. Click *User Browsing* in the side navigation bar. The Authentication Service User Browsing - NT window will open.
5. Click *Browse Anonymously* to anonymously browse users on the external Windows NT authentication server.

-or-

Click *Browse with User Credentials* to browse users on the external Windows NT authentication based on credentials configured. If this option is selected, do the following:

- a. Type the username for an NT domain account that has browse rights in the User Name field.
 - b. Type the password for an NT domain account that has browse rights in the Password field.
6. Click *Save* and then click *Close*. The User Authentication Services dialog box will appear.

LDAP external authentication service

To add an LDAP external authentication service:

1. Click the *Users* tab.
2. Click *Authentication Services* in the top navigation bar. The User Authentication Services window will open.
3. Click *Add*. The Add Authentication Service Wizard will appear.
4. The Provide Authentication Service Name and Type window will open.
 - a. Type a name for the external authentication service.
 - b. Select *LDAP* from the Type menu.

- c. Click *Next*.
5. The Specify LDAP Connection Settings window will open.
 - a. Type the address of the LDAP host in dot notation format (xxx.xxx.xxx.xxx) or type the DNS host name in the Host Address field.
 - b. Type the number of the port for connecting to the LDAP host in the Port Number field.
 - c. Specify an SSL encryption mode:
 - Click *Do Not Use SSL* to have authentication performed using unencrypted clear text instead of SSL encryption. This method is the least secure and automatically sets the Port Number field to a default port number of 389.
 - Click *Use SSL in Trust All Mode* to use SSL encryption for data transmission. All server certificates will be trusted and automatically accepted by the DSView 3 software for transmitting data. This SSL method provides medium security and automatically sets the Port Number field to a default port number of 636.
This encryption mode is not recommended for wide area networks (WANs).
 - Click *Use SSL in Certificate-based Trust Mode* to use SSL encryption for data transmission. The DSView 3 software will approve the server and then the certificate before transmitting data. This SSL method provides maximum security and automatically sets the Port Number field to a default port number of 636.
 - d. Click *Enable Chasing of Referrals* if you wish to allow the LDAP server to refer DSView 3 software clients to additional directory servers.
 - e. Click *Next*.

If you selected *Use SSL in Certificate-based Trust Mode*, go to step 6.

If you selected *Do Not Use SSL* or *Use SSL in Trust All Mode*, go to step 10.
6. The DSView 3 server will try to find a server that has a trusted certificate chain (see *System certificate policy and trust store* on page 47). If no trusted certificate chain is found, then the Accept Certificate window will open and list all servers that belong to the domain. It will also list the reasons for rejection of the certificate chain.
7. Click *Next* to accept the certificate.
8. The Specify LDAP User Schema window will open.
 - a. Type the Base distinguished name (DN) from which to begin searches. This is a required field unless the Directory Service has been configured to allow anonymous search. Each Search DN value must be separated by a comma.
 - b. Type the key attribute. The default value is common name (cn).
 - c. Type the object class. The default value is person.
 - d. Type the full name attribute. The default value is surname (sn).
 - e. Click *Next*.
9. The Specify LDAP Group Schema window will open.

- a. Type the Base distinguished name (DN) from which to begin searches. This is a required field unless the Directory Service has been configured to allow anonymous search. Each Search DN value must be separated by a comma.
 - b. Type the object class. The default value is group.
 - c. Type the member attribute. The default value is member.
 - d. Type the username member attribute (only the username, not the full LDAP object DN). The user's group membership will be located using this attribute in addition to the member attribute. This attribute is primarily used with NIS-like schemas.
 - e. Click *Next*.
10. The Select Browsing Method window will open.
- Click *Browse Anonymously* to browse users on the external LDAP authentication server.
- or-
- Click *Browse with user credentials* to browse users on the external LDAP authentication based on credentials configured on the server. If this option is selected, do the following:
- a. Type a log in ID in the User Name field, in one of two forms: a fully qualified distinguished name or the username of an account in the base user DN.
 - b. Type the password for the LDAP user account in the Password field.
 - c. Click *Next*.
11. The Establish Connection with Authentication Service window will open briefly. If the external authentication service is added successfully, the Completed Successful window will open.
12. Click *Finish*. The User Authentication Services window will open with the new service listed.

To change connection settings for the LDAP external authentication service:

1. Click the *Users* tab.
2. Click *Authentication Services* in the top navigation bar. The User Authentication Services window will open.
3. Click the name of the LDAP service. The side navigation bar will change to include the name of the LDAP service at the top and, below the name, the information you may define.
4. Click *Connection* in the side navigation bar. The Authentication Service Connection Settings - LDAP window will open.
5. Type a name in the Service Name field to change the name of the service that appears in the Name column of the User Authentication Services window.
6. Type the address of the LDAP host, in dot notation format (xxx.xxx.xxx.xxx) in the Host Address field.
7. Type the number of the port you wish to use for connecting to the LDAP host in the Port Number field.
8. Specify a Secure Socket Layer (SSL) Encryption mode:

- Click *Do Not Use SSL* to have authentication performed using unencrypted clear text instead of SSL encryption. This method is the least secure and automatically sets the Port Number field to a default port number of 389.
- Click *Use SSL in Trust All Mode* to use SSL encryption for data transmission. All server certificates will be trusted and automatically accepted by the DSView 3 software for transmitting data. This SSL method provides medium security and automatically sets the Port Number field to a default port number of 636.
This encryption mode is not recommended for wide area networks (WANs).
- Click *Use SSL in Certificate-based Trust Mode* to use SSL encryption for data transmission. The DSView 3 software will approve the server and then the certificate before transmitting data. This SSL method provides maximum security and automatically sets the Port Number field to a default port number of 636.

9. Click *Save* to save your changes.

If you selected *Use SSL in Certificate-based Trust Mode*, the Certificates heading will appear in the side navigation bar. Go to step 8.

If you selected *Do Not Use SSL* or *Use SSL in Trust All Mode*, go to step 15.

10. Click *Certificates*. The Authentication Service Certificate Management - LDAP window will open and list all servers that belong to the domain. A status of Trusted indicates the certificate is trusted, based on the certificate policy (see *System certificate policy and trust store* on page 47); Untrusted indicates the certificate cannot be trusted.
11. To register certificates, click the checkbox to the left of the server IP address(es). To select all server IP addresses on the page, click the checkbox to the left of the IP Address heading.
12. Click *Register* to register the certificates. The Accept SSL Certificate window will appear.
13. Click *Save* to store the certificate values to the DSView 3 software database on the host.
The Certificate Management window will open if only one certificate was selected. If more than one certificate was selected, each will appear in order in subsequent Accept SSL Certificate windows.
14. To unregister one or more certificates, check the checkbox to the left of the server IP address(es). To select all server IP addresses on the page, click the checkbox to the left of the IP Address heading.
15. Click *Unregister* to unregister the certificates.
16. A confirmation message box will appear. Confirm or cancel the operation.
17. Click *Close*. The User Authentication Services window will open.

To change user schema settings for the LDAP external authentication service:

1. Click the *Users* tab.
2. Click *Authentication Services* in the top navigation bar. The User Authentication Services window will open.

3. Click the name of the LDAP service. The side navigation bar will change to include the name of the LDAP service at the top and, below the name, the information you may define.
4. Click *Schema* in the side navigation bar. *Users* will automatically be selected and the Authentication Service User Schema - LDAP window will open.
5. Type the Base distinguished name (DN) from which to begin searches. This is a required field unless the Directory Service has been configured to allow anonymous search. Each Search DN value must be separated by a comma.
6. Type the key attribute. The default value is common name (cn).
7. Type the object class. The default value is person.
8. Type the full name attribute for the user. The default value is surname (sn).
9. Click *Save* and then click *Close*. The User Authentication Services dialog box will appear.

To change group schema settings for the LDAP external authentication service:

1. Click the *Users* tab.
2. Click *Authentication Services* in the top navigation bar. The User Authentication Services window will open.
3. Click the name of the LDAP service. The side navigation bar will change to include the name of the LDAP service at the top and, below the name, the information you may define.
4. Click *Schema* in the side navigation bar, and then click *Groups*. The Authentication Service Group Schema - LDAP window will open.
5. Type the Base distinguished name (DN) from which to begin searches. This is a required field unless the Directory Service has been configured to allow anonymous search.
6. Type the object class. The default value is groupOfNames.
7. Type the members attribute. The default value is member.
8. Type the username member attribute (only the username, not the full LDAP object DN). The user's group membership will be located using this attribute in addition to the member attribute. This attribute is primarily used with NIS-like schemas.
9. Click *Save* and then click *Close*. The User Authentication Services dialog box will appear.

To change user browsing settings for the LDAP external authentication service:

1. Click the *Users* tab.
2. Click *Authentication Services* in the top navigation bar. The User Authentication Services window will open.
3. Click the name of the LDAP service. The side navigation bar will change to include the name of the LDAP service at the top and, below the name, the information you may define.
4. Click *User Browsing* in the side navigation bar. The Authentication Service User Browsing - LDAP window will open.
5. Click *Browse Anonymously* to browse users on the external LDAP authentication server.

-or-

Click *Browse with User Credentials* to browse users on the external LDAP authentication based on credentials configured on the server. If this option is selected, do the following:

- a. Type a log in ID in the User Name field, in one of two forms: a fully qualified distinguished name or the username of an account in the base user DN.
 - b. Type the password for the LDAP user account in the *Password* field.
6. Click *Save* and then click *Close*. The User Authentication Services dialog box will appear.

RADIUS external authentication service

To add a RADIUS external authentication service:

1. On the RADIUS server that will be used as an external authentication service, add the DSView 3 server as a RADIUS client. Make a note of the configured shared secret and the available authentication type(s) on the RADIUS server.
2. From the DSView 3 Explorer, Click the *Users* tab.
3. Click *Authentication Services* in the top navigation bar. The User Authentication Services window will open.
4. Click *Add*. The Add Authentication Service Wizard will appear.
5. The Provide Authentication Service Name and Type window will open.
 - a. Type a 1-64 character name for the RADIUS authentication service.
 - b. Select *RADIUS* from the Type menu.
 - c. Click *Next*.
6. The Specify RADIUS Connection Settings window will open.
 - a. Type the address of the RADIUS host in dot notation format (xxx.xxx.xxx.xxx) or type the DNS host name in the Server Address field.
 - b. Type the number of the port (from 1-65535) for connecting to the RADIUS host in the Port Number field. The default is port 1812.
 - c. Click *Next*.
7. The Establish Connection with Authentication Service window will open briefly. If the external authentication service is contacted successfully, the Specify RADIUS Authentication Settings window will open.
 - a. Select the authentication type from the Authentication Type menu. Make sure it is one of the available authentication types noted in step 1.
 - PAP - Password Authentication Protocol
 - CHAP - Challenge Handshake Authentication Protocol (default)
 - MS-CHAP - Microsoft Challenge Handshake Authentication Protocol
 - MS-CHAP v2 - Microsoft Challenge Handshake Authentication Protocol Version 2

- b. In the Shared Secret field, type the shared secret (that was configured on the RADIUS server in step 1), which is a password protected field. Microsoft's implementation allows up to 128 ASCII characters for the shared secret; other servers may have a different limit.
 - c. Re-enter the shared secret in the Confirm Shared Secret field.
 - d. Click *Next*.
8. If the external authentication service is added successfully, the Completed Successful window will open.
9. Click *Finish*. The User Authentication Services window will open with the new service listed.

To change settings for the RADIUS external authentication service:

1. Click the *Users* tab.
2. Click *Authentication Services* in the top navigation bar. The User Authentication Services window will open.
3. Click the name of the RADIUS service. The side navigation bar will change to include the name of the RADIUS service at the top and, below the name, the information you may define.
4. Click *Connection* in the side navigation bar. The Authentication Service Connection Settings - RADIUS window will open.
 - a. Type a 1-64 character name for the RADIUS authentication service.
 - b. Type the address of the RADIUS host in dot notation format (xxx.xxx.xxx.xxx) or type the DNS host name in the Server Address field.
 - c. Type the number of the port (from 1-65535) for connecting to the RADIUS host in the Port Number field. The default is port 1812.
 - d. Click *Save*.
5. To change the authentication type and/or shared secret, click *Settings* in the side navigation bar. The Authentication Service Authentication Settings - RADIUS window will open.
 - a. Select the authentication type from the Authentication Type menu.
 - PAP - Password Authentication Protocol
 - CHAP - Challenge Handshake Authentication Protocol (default)
 - MS-CHAP - Microsoft Challenge Handshake Authentication Protocol
 - MS-CHAP v2 - Microsoft Challenge Handshake Authentication Protocol Version 2
 - b. In the Shared Secret field, type the shared secret, which is a password protected field. Microsoft's implementation allows up to 128 ASCII characters for the shared secret; other servers may have a different limit.
 - c. Re-enter the shared secret in the Confirm Shared Secret field.
 - d. Click *Save*.
6. Click *Close*. The User Authentication Services dialog box will appear.

TACACS+ external authentication service

DSView 3 software supports TACACS+ external authentication. Once the TACACS+ authentication service is added, you may map TACACS+ users to the DSView 3 software database by using the Add User Account wizard. The username added in the DSView 3 software should match the username configured in the TACACS+ server. For more information about adding users, see *Adding User Accounts* on page 231.

You may choose to associate users with internal DSView 3 software groups to control group level access rights. Or, you may choose to map users to external TACACS+ groups and control group level access rights using the TACACS+ service. There are two types of external TACACS+ groups that can be used: the TACACS+ standard privilege level attribute, or a custom group name attribute. To map users to external TACACS+ groups, use the DSView 3 software Add User Group wizard and specify the group type. For more information, see *Adding User-defined User Groups* on page 242.

To add a TACACS+ external authentication service:

1. On the TACACS+ server that will be used as an external authentication service, add the DSView 3 server as a TACACS+ client. Make a note of the configured shared secret and the available authentication type(s) on the TACACS+ server.
2. From the DSView 3 Explorer, Click the *Users* tab.
3. Click *Authentication Services* in the top navigation bar. The User Authentication Services window will open.
4. Click *Add*. The Add Authentication Service Wizard will appear.
5. The Provide Authentication Service Name and Type window will open.
 - a. Type a 1-64 character name for the TACACS+ authentication service.
 - b. Select *TACACS+* from the Type menu.
 - c. Click *Next*.
6. The Specify TACACS+ Connection Settings window will open.
 - a. Type the address of the TACACS+ host or type the DNS host name in the Server Address field.
 - b. Type the number of the port (from 1-65535) connecting to the TACACS+ host in the Port Number field. The default port is 49.
 - c. Click *Next*.
7. The Establish Connection with Authentication Service window will open briefly. If the external authentication service is contacted successfully, the Specify TACACS+ Authentication Settings window will open.
 - a. Select the authentication type from the Authentication Type menu. Make sure it is one of the available authentication types noted in step 1.
PAP - Password Authentication Protocol
CHAP - Challenge Handshake Authentication Protocol (default)

MS-CHAP - Microsoft Challenge Handshake Authentication Protocol

- b. In the Shared Secret field, type the shared secret (configured on the TACACS+ server in step 1), which is a password protected field. (For the shared secret, Microsoft's implementation allows up to 128 ASCII characters and Cisco's implementation allows up to 32 ASCII characters; other servers may have a different limit.)

NOTE: If you change the authentication type, you will be required to enter the shared secret.

- c. Re-enter the shared secret in the Confirm Shared Secret field.
 - d. Click *Next*.
8. The Specify TACACS+ Group Authorization Method window will open.
- a. Click the corresponding radio button to choose one of the following options to manage group authorization:
 - DSView internal groups: Choose this option if you plan to associate TACACS+ users with DSView 3 software internal user groups.
 - TACACS+ privilege level attribute: Choose this option if you plan to associate TACACS+ users with external TACACS+ groups using the privilege level attribute.
 - TACACS+ custom attribute for group names: Choose this option if you plan to associate TACACS+ users with external TACACS+ groups using the custom group names attribute.
 - b. Click *Next*.
9. If you selected DSView internal groups and the external authentication service was added successfully, the Completed Successful window will open.

-or-

If you selected any other option, the Specify TACACS+ Server Group Authorization Settings window will open.

- a. In the Service field, type the appropriate TACACS+ service.

If you selected the privilege level attribute method in step 8, the default value shell will appear in the field by default.

If you selected the group name custom attribute method in step 8, the default value raccess will appear in the field by default.
- b. If the TACACS+ service requires a protocol for authorization requests, type the protocol in the Protocol field.
- c. In the Attribute Name field, type the attribute name that the DSView 3 server will receive after an authorization request.

If you selected the privilege level attribute method in step 8, the default value priv-lvl will appear by default.

If you selected the group name custom attribute method in step 8, the default value group_name will appear by default.

NOTE: The Cyclades ACS advanced console server uses the service “raccess” and the attribute “group_name” for TACACS+ group implementation.

10. Click *Next*. If the external authentication service is added successfully, the Completed Successful window will open.
11. Click *Finish*. The User Authentication Services window will open with the new service listed.

To change settings for the TACACS+ external authentication service:

1. Click the *Users* tab.
2. Click *Authentication Services* in the top navigation bar. The User Authentication Services window will open.
3. Click the name of the TACACS+ service. The side navigation bar will change to include the name of the TACACS+ service at the top and, below the name, the information you may define.
4. Click *Connection* in the side navigation bar. The Authentication Service Connection Settings - TACACS+ window will open.
 - a. Type a 1-64 character name for the TACACS+ authentication service.
 - b. Type the address of the TACACS+ host in dot notation format (xxx.xxx.xxx.xxx) or type the DNS host name in the Server Address field.
 - c. Type the number of the port (from 1-65535) for connecting to the TACACS+ host in the Port Number field. The default is port 49.
 - d. Click *Save*.
5. To change the authentication type and/or shared secret, click *Settings* in the side navigation bar. The Authentication Service Authentication Settings - TACACS+ window will open.
 - a. Select the authentication type from the Authentication Type menu.
 - PAP - Password Authentication Protocol
 - CHAP - Challenge Handshake Authentication Protocol (default)
 - MS-CHAP - Microsoft Challenge Handshake Authentication Protocol
 - b. In the Shared Secret field, type the shared secret, which is a password protected field. (For the shared secret, Microsoft’s implementation allows up to 128 ASCII characters and Cisco’s implementation allows up to 32 ASCII characters; other servers may have a different limit.)

NOTE: If you change the authentication type, you will be required to enter the shared secret.

- c. Re-enter the shared secret in the Confirm Shared Secret field.
 - d. Click *Save*.
6. To change the group authorization settings, click *Group Authorization* in the side navigation bar.

The Method field will display the group authorization method configured when the TACACS+ authentication service was added. This field cannot be changed.

- a. In the Service field, type the appropriate TACACS+ service.
If TACACS+ privilege level attribute is the method, the default value is shell.
If TACACS+ custom attribute for group names is the method, the default value is raccess.
 - b. If the TACACS+ service requires a protocol for authorization requests, type the protocol in the Protocol field.
 - c. In the Attribute Name field, type the attribute name that the DSVIEW 3 server will receive after an authorization request.
If TACACS+ privilege level attribute is the method, the default value is priv-lvl.
If TACACS+ custom attribute for group names is the method, the default value is group_name.
 - d. Click *Save*.
7. Click *Close*. The User Authentication Services dialog box will appear.

RSA SecurID external authentication service

When an RSA SecurID external authentication service is added, the DSVIEW 3 software obtains user authentication information and relays it to the RSA Authentication Manager. The RSA Authentication Manager's validation results are then relayed to the user. The DSVIEW 3 software also supports new PIN operations, next tokencode operations, RSA Authentication Manager Replica functionality and name locking. The DSVIEW 3 software is the agent type Net OS Agent. See *RSA SecurID login* on page 18 for information about the login process when an RSA SecurID external authentication service is used. Consult the RSA Authentication Manager documentation for additional details.

For complete information about what is needed on the RSA server, see the RSA Secured Partner Solutions Directory on the RSA web site (rsasecurity.com).

To add an RSA SecurID external authentication service:

1. On the RSA server that will be used as an external authentication service, add the DSVIEW 3 server as an RSA Agent Host.
2. From the DSVIEW 3 Explorer, Click the *Users* tab.
3. Click *Authentication Services* in the top navigation bar. The User Authentication Services window will open.
4. Click *Add*. The Add Authentication Service Wizard will appear.
5. The Provide Authentication Service Name and Type window will open.
 - a. In the Name field, type a 1-64 character name for the RSA authentication service.
 - b. Select *RSA SecurID* from the Type menu.
 - c. Click *Next*.

6. The Specify RSA SecurID Connection Settings window will open. Type the 1-512 character path to the `sdconf.rec` file, or browse to the file location. (This file is created by the RSA Authentication Manager, but is located on the DSView 3 software client machine.) Then, click *Next*.

The `sdconf.rec` file will be uploaded from the DSView 3 software client to the DSView 3 server. This file will be used as the initial RSA configuration file for all DSView 3 software servers.

If some DSView 3 servers require a different configuration, a different `sdconf.rec` file must be configured. Additionally, some installations may require an advanced option file (`sdopts.rec`) for load balancing. You may specify these files using the procedure to change settings for the RSA SecurID external authentication service.

7. The Establish Connection with Authentication Service window will open briefly. If the external authentication service is added successfully, the Completed Successful window will open.

Click *Finish*. The User Authentication Services window will open with the new service listed.

After the service is added, one or more RSA user accounts must be added to the DSView 3 software.

NOTE: The node secret file for the server will not be created until the first RSA user logs into the DSView 3 software.

To change settings for the RSA SecurID external authentication service:

1. Click the *Users* tab.
2. Click *Authentication Services* in the top navigation bar. The User Authentication Services window will open.
3. Click on the name of the SecurID service.
4. Click *Connection* in the side navigation bar. The Authentication Service Connection Settings window will open.
5. To change the name of the service:
 - a. Type a 1-64 character name in the Service Name field.
 - b. Click *Save*.
 - c. If that is the only change you are entering, click *Close*. Otherwise, continue with the next steps.
6. To clear the RSA SecurID node secret for one or more DSView 3 servers:
 - a. Click the checkbox to the left of the server name. To select all DSView 3 servers on the page, click the checkbox to the left of DSView Server at the top of the list.
 - b. Click *Clear Node Secret*. A confirmation dialog box will appear.
 - c. Confirm or cancel the operation.

7. To update the RSA configuration files used by one or more DSVIEW 3 servers to communicate with the RSA Authentication Manager software:
 - a. Click the checkbox to the left of the server name. To select all DSVIEW 3 servers on the page, click the checkbox to the left of DSVIEW Server at the top of the list.
 - b. Click *Update*. The Update RSA Configuration File window will open.
 - c. To change the sdconf.rec configuration file, enter the path in the sdconf.rec field or browse to the location.
 - d. To specify the advanced option sdopts.rec file for manual load balancing, enter the path in the sdopts.rec field or browse to the location.
 - e. Click *Save* and then click *Close*.

The DSVIEW Service may need to be restarted when the RSA configuration is updated

User Authentication Services Window

Once added, the authentication services are listed in the User Authentication Services window. To view the window, click the *User* tab, then click *Authentication Services*. The authentication service name, type, enabled status and host name are displayed in the list.

If *Allow users and groups from newly discovered trusted forests* is enabled for an AD service, the discovered forests are displayed as a subset of the primary authentication service in the User Authentication Services window. The type is displayed as Active Directory - Trusted Forest.

The Enabled column displays a value of Yes or No. If the value is Yes, the users and groups of the authentication service are considered when the DSVIEW 3 server attempts to authenticate and authorize a user; if the value is No, the authentication service is ignored. If the same username exists in multiple authentication services, you can use the Enabled status to control which authentication service will be used to find a user.

To enable or disable an authentication service:

1. Click the *User* tab, then click *Authentication Services* to open the User Authentication Services window.
2. Select the checkbox next to the authentication service you want to enable or disable.
3. To enable the trusted forest, click *Enable*.

-or-

To disable the trusted forest service, click *Disable*.

NOTE: All new authentication services are enabled by default, with the exception of new trusted forests which are disabled by default.

To refresh trusted forests:

NOTE: Refresh Trusted Forests is only applicable for Active Directory services for which discovering trusted forests was enabled.

1. Click the *User* tab, then click *Authentication Services* to open the User Authentication Services window.
2. Select the checkbox next to the primary AD authentication service.
3. Click *Refresh Trusted Forests*. New trusted forests are displayed in the list.

Units View Windows

Units View windows display list of units that have been added to the DSView 3 software database.

A user must have unit view access rights to open Units View windows; see *About Access Rights* on page 144. Also, units will not display if they are hidden; see *Showing and hiding units* on page 107.

Each Units View window contains one or more information fields; see *Units View windows fields* on page 107.

Units are displayed in a table format with column headings. Use the checkbox to the left of each unit name to select/deselect the unit for an operation. To select all the units on a page, click the checkbox at the left of all the column headings at the top of the list - this is usually to the left of the Name column. Clicking this Select All checkbox will automatically enable the checkboxes for all units on that page. To deselect items that were previously selected, click on the checkbox.

When you click the checkbox at the top of the list, all units on the current page are selected (or deselected if they were previously all selected). If the list of units spans more than one page, units on subsequent pages will not be selected. You can specify how many items will appear on a Units View page (that is, the number of rows); see *Using the Customize link in windows* on page 28.

Types of Units View windows

There are four types of Units View windows, which are accessed by clicking tabs and side navigation bar links. Additional Units View windows, such as Virtualization or Blade Chassis, may be added by plug-ins; see the plug-in documentation for more information. For information about using the collapse/expand icons in the side navigation bar, see *Using the Side Navigation Bar* on page 24.

Any Units View window that contains managed appliances may also be viewed using the topology feature, which displays a hierarchical structure; see *Topology view* on page 104.

- All Appliances: The Appliances - All window lists all managed appliances.
- Appliance Type: Appliance Type windows list all managed appliances of a particular type (for example, DSR1031 switches). The Appliance Type links in the side navigation bar are listed under Appliances - All.

An appliance type will only be listed in the side navigation bar if an appliance of that type has been added to the DSView 3 software database and the user has access to it. For example, if a DSR1021 switch has not been added, that type will not appear in the side navigation bar.

- **Target Devices:** If target device types have been created, their links in the side navigation bar are listed under Target Devices - All.
- **Unmanaged Appliances (for DSR switches only):** Lists all DSR switches that have been automatically discovered. These units will not be available from the Units View appliances window until they are moved to the managed appliance list. See *Managed Appliance Status* on page 147.
- **Mixed Views:** Mixed view windows may contain managed appliances, target devices or both. Several links in the side navigation bar will open mixed view Units View windows.
 - **Recently Accessed -** Units that the user has accessed most recently.
 - **Groups -** Units that have been assigned to a personal or global unit group.
 - **Sites -** Units that have been assigned to a site.
 - **Departments -** Units that have been assigned to a department.
 - **Locations -** Units that have been assigned to a location.
 - **Custom fields -** Units that have been assigned to custom groups. These group names may also have custom field labels.

See Chapter 15 beginning on page 205 for information about creating and managing groups.

Topology view

Units View windows that contain managed appliances support a topology feature that can be enabled/disabled. A topology view is a series of parent-child hierarchies. A parent is a managed appliance; children can be target devices, cascade switches (with target device children of their own) and power control devices (with socket children of their own).

When the topology feature is enabled in a Units View window that contains appliances, an arrow will appear next to each appliance. This arrow can be used to expand (open) an appliance display to list all the appliance ports. A Port column will be added next to the Name column. The port value is the port number on the appliance (or “SPC” if a power device is attached to an SPC port on a DSR switch), the port number on a cascaded switch or the socket number on a cascaded power device (for example, A1). By default, the topology view sorts by the Port column. The Port column is sorted by type, number and then unit name.

Expanding and collapsing the display follows the same rules as the side navigation bar. If the arrow is pointing right, clicking it causes the children to be displayed (expanding/opening the item). If the arrow is pointing down, clicking it causes the children to be hidden (collapsing/closing the item).

If a port has a cascade switch or power control device attached, the unit name for that port will include an arrow that can be used to expand/collapse the display of either all the ports on the cascade switch or all the sockets on the power control device.

Ports on an appliance or a cascade switch that do not have units attached are also listed. The Status column will indicate No Device Attached and the Type column will indicate the default valid connection type for that port. The Action column will indicate Attach Device; see the procedure in this section for how to attach device from this link.

If a target device is connected to multiple managed appliances, it will appear multiple times in a topology view. If you select one occurrence of an item, all other occurrences are also selected.

If you expand a display and select one or more child items, collapsing the display will hide those children and deselect them.

The Select All checkbox at the top of the list will only select displayed items on the current page. Items that are hidden in a collapsed unit cannot be selected with the Select All checkbox.

In a topology view, the number of items per page value applies to appliances and children, even if the display is collapsed and the children are not visible. You may also specify that the topology view expand automatically when the Topology button is clicked. See *Using the Customize link in windows* on page 28.

If you filter the display (see *Filtering information in a window* on page 26), and a child matches the filter criteria, the parent(s) automatically open. If only an appliance matches the filter criteria, the appliance is closed (unless the Expand View Automatically option is enabled).

To enable or disable a topology view:

In a Units View window (see *Accessing Units View windows* on page 106), click *Topology*.

Although you can enable the topology view in all Units View windows, it is only meaningful in windows that contain managed appliances (parent units that have children). If you enable topology view in a Units View window that contains only target devices, the only change will be the addition of the Port column to the display.

To attach a device from a topology view:

1. In a Units View window containing appliances (see *Accessing Units View windows* on page 106), enable the topology view by clicking *Topology*.
2. The Topology checkbox will appear pressed and the Port column will be added to the display.
3. Click the arrow next to the appliance. If the port is located on a cascade switch, click the arrow next to the cascade switch.
4. In the Action field of the port where you want to attach the target device, click *Attach Device*. The Attach Device Wizard will open.
5. The Select a Method for Attachment window will open.
 - To create a new target device and attach it, enable the *Create a New Target Device* radio button, enter a unique name (up to 64 characters) in the Device Name field and then click *Next*.

- To attach a target device that has already been added to the DSView 3 software system, enable the *Attach to an Existing Target Device* radio button, enter the name in the Device Name field and then click *Next*.
 - To browse for a target device that has already been added to the DSView 3 software system, enable the *Browse for an Existing Target Device* radio button. The Browse for an Existing Target Device window will open, listing all target devices (or the first 2000), sorted alphabetically. To tailor the list, enter a valid filter string and click *Filter*. Select a target device from the list and then click *Next*.
6. The Completed Successful window will open. Click *Finish*.

Accessing Units View windows

To enable a topology view in a Units View window, click *Topology* (see *Topology view* on page 104).

To access Units View windows:

Click the *Units* tab.

- To display target devices:
 - a. Click *Target Devices* in the side navigation bar. The Target Devices - All window will open. This window lists all target devices in the system.
 - b. Click one of the target device type links (if available) in the side navigation bar. Target device types are user-defined. If a type has been assigned to a target device, the type name will appear under Target Devices in the side navigation bar. For example, if you assign a type of “Windows 2000” to three target devices, a Windows 2000 link will appear in the side navigation bar. Clicking on the link will display the three target devices, as well as any other target devices assigned that type.
- To display managed appliances:
 - a. Click *Appliances* in the side navigation bar. The Appliances - All window will open.
 - b. To display an Appliance Type window, click one of the appliance type links in the side navigation bar.
- To display a list of units that you have accessed most recently, click *Recently Accessed* in the side navigation bar.
- To display units by groupings (if available), click the link in the side navigation bar.
 - Click *Sites* to open the Units in Sites window.
 - Click *Departments* to open the Units in Departments window.
 - Click *Locations* to open the Units in Locations window.
 - Click *Custom Field Labels* to display the Units in Custom Field window.

Showing and hiding units

Hiding turns off the display of units in the window, but does not remove the units from the DSView 3 software system.

To hide a unit:

1. In a Units View window (see *Accessing Units View windows* on page 106), click *Customize*. The Units View Customization window will open.
2. Click *Visibility* in the Available Fields column and then click *Add*. Visibility will be moved to the Fields to Show column.
3. Enable the *Show hidden items* checkbox if you wish to display hidden units in the Units View Customization window with a transparent icon.
4. Click *Save* and then click *Close*. The window will open, containing the Visibility column. The Visibility column will display Hide for each unit.
5. Click *Hide* for each unit.

The display of the selected unit will be turned off in the Units View window if *Show hidden items* was not selected in the Units View Customization window.

If *Show hidden items* was selected, the hidden unit will appear with a transparent icon.

To hide multiple units with one operation:

1. In a Units View window (see *Accessing Units View windows* on page 106), click the checkbox next to the units you want to hide from display. To select all units on the page, click the checkbox to the left of Name at the top of the list.
2. Click *Operations*, then select *Hide Units* from the drop-down menu.

To show hidden units:







1. In a Units View window (see *Accessing Units View windows* on page 106) click *Customize*. The Units View Customization window will open.
2. Click *Visibility* in the Available Fields column and then click *Add*. Visibility will be moved to the Fields to Show column.
3. Click *Show hidden items*.
4. Click *Save* and then click *Close*. The Units View window will open, containing the hidden items and the Visibility column. Hidden items will have a transparent icon and the Visibility field will contain Show.
5. Click *Show* in the Visibility column for the unit(s) you want to display. The unit will be made visible, the icon will no longer be transparent and the Visibility field will change to Hide.

Units View windows fields

The following fields may appear in Units View windows. You may enable or disable a field's display using the Customize link. See *Using the Customize link in windows* on page 28.

- Name in Appliance - Name of the unit as defined in the appliance. Click on the name to display or change unit information.
- Name in DSView - Name of the unit as defined in the DSView 3 software database.
- Type - Type of target device or managed appliance model. Managed appliance types cannot be changed; to assign a type to a target device, see *Unit Overview Windows* on page 112.
- Status - Current activity level of a unit. Table 7.1 lists and describes the possible values.

Table 7.1: Unit Status Values

Unit type	Status and Icon	Icon	Description
Any unit	Idle	N/A	The unit is powered up with no connection.
Any unit	In Use		The unit has at least one active connection.
Any unit	Status Unknown		The status of the unit was reported to the software but cannot be obtained for an unknown reason.
Target devices	No Power		The target device is powered down.
Target devices	KVM Blocked		The connection path to the target device is blocked because a cascade switch is already in use.
Target devices	No device attached (topology view only)	N/A	The port does not have a target device attached.
Target devices	Partial Power		The DSView 3 software cannot determine the power state of the target device, or the software received a mixed power state from the target device. For example, if a target device has a KVM connection and a power device connection, the software will prompt for a power status for both of these connections. If both connections do not reply with ON or OFF, the power status will display as Partial Power.
Managed appliances	Not Responding		The managed appliance did not provide status information. This may occur for multiple reasons, such as the appliance is not powered up or it is disconnected from the DSView 3 software system.

- Action - Type of session that may be initiated. Although a unit may have multiple actions that may be performed (for example, you may be able to access a target device using a browser session or a Telnet session), only one action will be displayed.

NOTE: Actions are also available from Connections windows.

For example, a target device that is only attached to a serial console appliance will not contain a KVM Session link. If a target device has a connection to both a serial console appliance and a KVM switch, a KVM Session link will appear.

As shown in Figure 7.1, other available actions that have been enabled may be accessed by clicking the *Alternate Actions* arrow to the right of the action with the highest precedence. Clicking on one of the displayed links will launch the corresponding window type.

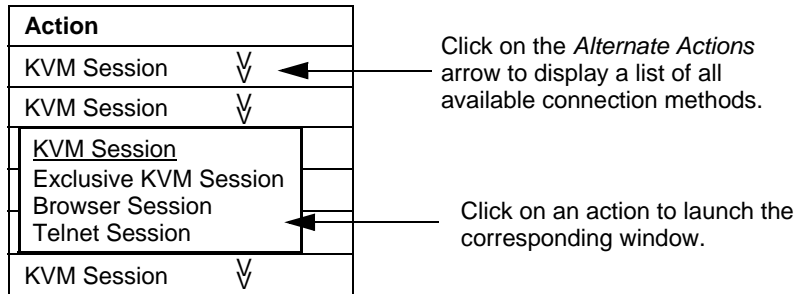

Figure 7.1: Alternate Actions Arrow in a Units View Window

Table 7.2: Action Links

Action link	Displays	Valid for*
KVM Session	Video Viewer window	TDs attached to KVM switch channels/ ports
Exclusive KVM Session	Video Viewer window (this link only appears when Alternate Action arrow is selected)	TDs attached to KVM switch channels/ ports
Embedded Session	Viewer window	Supported versions of IBM ASM RSA II, DRAC 4 and NEC IPF embedded units
IPMI Session	IPMI Viewer window	IPMI TDs
Serial Session	Opens a Telnet session window using the configured application	Target devices
Browser Session	Web browser	EVR1500 environmental monitors, generic appliances, standalone TDs and TDs attached to serial console appliances, HP iLO embedded unit or KVM switch ports
Telnet Session	Telnet Viewer window or third party Telnet view window	EVR1500 environmental monitors, generic appliances, standalone TDs and TDs attached to serial console appliances, HP iLO embedded unit or KVM switch ports

Table 7.2: Action Links (Continued)

Action link	Displays	Valid for*
<Service Name>	Service interface	Target devices; see <i>Target Device Services</i> on page 151
<Connection Name>	Session interface	Appliances and/or TDs supported by plug-ins that define this connection type.

* In addition to the units listed in this column, one or more of these connection types may be valid for units supported by plug-ins. See the plug-in documentation for details.

- Site - See *Site, Department and Location Groups* on page 205.
- Browser URL - URL that may be used to access a target device, EVR1500 environmental monitor or generic appliance. This field will be empty if a URL is not available.
- Custom Field 1-3 - Custom fields assigned to units. If these fields have been defined with new names, the defined names will appear instead of the place holder names (Custom Field 1, Custom Field 2 and so on). See *Custom Fields* on page 207.
- Department - See *Site, Department and Location Groups* on page 205.
- DSView Software Server - Name of the server associated with the units.
- Location - Location assigned to the units. See *Site, Department and Location Groups* on page 205.
- Migration Status - Whether units imported from a DSView 2.x database or AlterPath® Manager software require migration to be operational in the DSView 3 software. See *Task: Migrating units* on page 326.
- Model Number - See *Unit Properties* on page 139.
- Part Number - See *Unit Properties* on page 139.
- Primary Contact, Primary Contact Phone, Secondary Contact and Secondary Contact Phone - Name and phone number of person(s) responsible for a unit. See *Unit Properties* on page 139.
- Serial Number - See *Unit Properties* on page 139.
- Telnet Port - Port number used for a Telnet connection to a target device. See *Unit Properties* on page 139.
- Visibility - Whether to display (Show) or not display (Hide) a unit in the Units View windows. See *Showing and hiding units* on page 107.
- Secure Mode - Displays a locked icon if secure mode is enabled on an appliance or an unlocked icon if it is not. Secure mode is set when an appliance is added (see *Adding Units* on page 115) and can be changed from the Operations menu (see *Managed Appliance Settings* on page 147).

NOTE: OSCAR status and DCHP status fields are also available for supported DSR switches; see the DSR switch plug-in help for more information.

Multiple unit operations from a Units View window

From a Units View window, you may delete one or more units (see *Deleting Units* on page 123) or assign access rights for one or more units (see *About Access Rights* on page 144).

You may also use the Operations button/menu to initiate certain actions on one or more units.

- Hiding units from view - see *Showing and hiding units* on page 107
- Reboot - see *Rebooting* on page 313
- Show version - see *Managed Appliance Settings* on page 147
- Push or pull names to/from the appliance - see *Manual name push* on page 128 and *Manual name pull* on page 129
- Wall power on, off or cycle - see *Power Device Sockets* on page 168
- Change unit properties - see *Unit Properties* on page 139

Custom operations defined in plug-ins may also be listed in the Operations menu.

A given action will be available only if at least one of the selected units supports the action. If a selected unit does not support the operation, it will be reported as such in the results window.

When one of these multiple unit operations is initiated and confirmed (if needed), a system task is created that will perform the operation on each unit. The Multiple Unit Operation window will open, indicating the operation has been submitted. This window contains a link that directs the user to the Operations Results window for the task.

To initiate and view results from multiple unit operations from a Units View window:

1. In a Units View window (see *Accessing Units View windows* on page 106), initiate the multiple unit operation as described in the procedures referenced above. If prompted, confirm the operation.
2. The Multiple Unit Operation window will open, indicating the operation has been submitted. If you do not want to view the results of the operation, click *Close* and skip the rest of this procedure.

To view the results of the operation, click *Click here to view results*.

3. The Operations Results window will open, listing all multiple unit operations and any unit tasks that have been initiated (see *Using Tasks* on page 319). The entry for each operation includes:
 - Name of the operation
 - When the operation started
 - When the operation finished (blank if not yet complete)
 - Status or result of the operation

You may also access this window at any time by clicking the *Units* tab, then clicking *Operation Results* in the side navigation bar.

4. To view the results for an individual operation, click on the name. The Operation Results window for that operation type will open, indicating:
 - Status - Current status of the task
 - Summary - Number of successful/failed/total unit operations (for example, the summary of an operation with a status of 'Rebooting the unit(s)' might contain a 2/0/3 summary - 2 successful, 0 failed and 3 total units)
 - Name of the operation
 - Type of unit
 - When the operation started
 - How long the operation took
 - Status or result of the operation on the unit
5. Click *Close*.

Unit Overview Windows

The Unit Overview window contains the following information about an individual unit:

- Target Devices - Name, type and icon associated with the target device. You may also use this window to connect to the target device. The available connection methods are determined by the type of target device.

Power information appears only if the target device is a power device and the user has power control rights. In this case, the user may power up, power down or cycle the power of the target device.
- Managed appliances - Name and type of managed appliances and the tools that may be used to:
 - Reboot
 - Upgrade firmware
 - Resynchronize
 - Save or restore the configuration (valid only for supported KVM switches and serial console appliances)
 - Save or restore the user database (valid only for supported KVM switches and serial console appliances)

The available tasks depend on the type of managed appliance and the user's access rights on the managed appliance. (Custom tools defined by a plug-in may also be available.)
- EVR1500 environmental monitor or generic appliance - Name and type of EVR1500 environmental monitor or generic appliance and links for establishing a connection to it.

You may change the overview information for one target device from a Unit Overview window. From a Units View window, you can change the type or icon for several target devices in one operation. This may be helpful when you want to assign the same values to several units. See *Unit Properties* on page 139.

Other types of Unit Overview windows may be supported by plug-ins; see the plug-in documentation for more information.

To change overview information for a target device:

1. In a Units View window containing target devices (see *Accessing Units View windows* on page 106), click on the name of a target device. The Unit Overview window will open.
2. Enter a name for the target device.
3. Enter a type for the target device.
4. Select a new icon for the target device using the arrows.
5. Click *Save* and then click *Close*. The Units View window will open. If you added a type that was not previously defined, it will appear under Target Devices in the side navigation bar.

To initiate a session with a target device from the Unit Overview window:

1. In a Units View window containing target devices (see *Accessing Units View windows* on page 106), click on the name of a target device. The Unit Overview window will open.
2. Click on the icon or name of the session type you wish to start.

To change the power state of a target device from the Unit Overview window:

NOTE: A user must have power control access rights and the target device must be connected to and powered by a supported power device; see Chapter 11 beginning on page 165.

1. In a Units View window containing target devices (see *Accessing Units View windows* on page 106), click on the name of a target device. The Unit Overview window will open.
2. Click the checkbox to the left of the power device outlet(s). To select all device outlets on the page, click the checkbox to the left of Connection at the top of the list.
3. Click *On*, *Off* or *Cycle* to power up, power down, or power cycle (power down and then power up) the power device outlets.

To change the name of a managed appliance from the Unit Overview window:

1. In a Units View window containing appliances (see *Accessing Units View windows* on page 106), click on the name of an appliance. The Unit Overview window will open.
2. Type a name for the managed appliance. (You cannot change the type.)
3. Click *Save* and then click *Close*. The Units View window will open.

Unit Status Window

To use the Unit Status window:

1. Click the *Units* tab, then click *Unit Status* in the side navigation bar.
2. The Unit Status window opens.

3. You can filter what units are displayed by selecting a status from the Filter menu. Each unit status is color-coded. The default filtered status is Active Status which displays only currently active units.
4. You can select how often the Unit Status is updated by selecting a time from the Interval menu.
5. You can view the Unit Overview window by double-clicking the unit name, or right-clicking the unit name and selecting *Show Unit Overview*.

Adding and Deleting Units

This chapter describes how to add and delete units in the DSView 3 software.

Adding Units

You may add:

- A single managed appliance
- A single embedded appliance
- Multiple managed appliances based on a range of IP addresses
- A generic appliance or an EVR1500 environmental monitor
- A single target device that is not attached to a managed appliance

When a managed appliance is added, DSView 3 software administrator, user administrator and appliance administrator privileges are automatically assigned to the managed appliance. A user with any of these privileges may:

- Reboot a managed appliance and disconnect sessions
- Administer local user accounts on the managed appliance
- Control target device power
- Establish sessions with target devices from KVM switches, serial console appliances or other supported units.

Appliance administrators and DSView 3 software administrators may also Flash upgrade a managed appliance and configure settings for a managed appliance.

Managed appliance rights may be changed. See *About Access Rights* on page 144.

When you add a KVM switch or serial console appliance, attached target devices are also added.

If you add a KVM switch or serial console appliance that has an attached power device, the power device is automatically added to the DSView 3 software database. Any target devices plugged into the power device outlets (sockets) are also added, based on the options selected.

The applicable X.509 certificate is automatically copied from the DSView 3 software to the unit being added. A certificate is a unique identifier of an individual managed appliance. (EVR1500

environmental monitors and generic appliances do not support certificates and may be added to multiple DSView 3 software systems.)

IPv4 and IPv6 network protocols

The DSView 3 software is a dual stack host that simultaneously supports both IPv4 and IPv6 network protocols. For example, the DSView 3 software can communicate with a DSR switch that has an IPv6 address and with an ACS console server that has an IPv4 address. Several Avocent appliances support IPv6, including DSR switches, ACS console servers, MergePoint SP managers and OnBoard appliances.

NOTE: IPv6 is not supported by all appliance models. See the corresponding product or plug-in documentation for a list of specific appliance models that support IPv6.

Wizards that add units

In a Units View window, clicking *Add* invokes a wizard that guides you through the process of adding managed appliances and target devices to the DSView 3 software system. The units that are visible in the current Units View window determines which wizard will be invoked when you click *Add*.

- If you are in the Appliances - All window, you can add managed appliances of any type. You cannot add target devices from that window.
- If you are in the Units View window for a specific appliance type (such as Appliances - DSR4030), you can only add more appliances of that type (DSR4030 appliances). You cannot add appliances of any other type or any target devices.
- If you are in the Target Devices - All window or any of the target device type windows (such as Target Devices - Linux Servers), you can add target devices. You cannot add appliances from that window.
- If you are in the Recently Accessed window, you can add a managed appliance or a target device.

When a unit is added to the DSView 3 software database, it is also added to the current Units View. For example, if you are viewing units in the department named Accounting and click *Add*, the newly added unit will automatically be added to the Accounting department.

You can also automatically discover supported KVM switches. See *Automatic Discovery* on page 135.

Adding a single managed appliance

This procedure is valid for supported KVM switches. It may also be valid for appliances supported by a plug-in; see the appropriate documentation.

To add a single managed appliance:

1. In a Units View window containing managed appliances (see *Accessing Units View windows* on page 106), click *Add*. The Add Appliance Wizard opens.

2. If you were not in an appliance type Units View window when you clicked *Add* in the first step, the Select Appliance Type window opens. Select *Add a single appliance by type*, then select a managed appliance from the product list. Click *Next*.
If you were in an appliance type Units View window when you clicked *Add* in the first step, go to the next step.
3. Enter the IP address for the appliance in the field provided.
If the appliance has already been configured with this IP address, click *Next*.
-or-
If the appliance has not yet been configured with an IP address, select *Appliance does not have an IP address assigned yet*. Complete the following steps:
 - a. Plug in the appliance and turn it on.
 - b. (IPv4 addresses) Type the subnet mask in the field provided.
 - c. Enter a gateway in the field provided.
 - d. (IPv6 addresses) Select the prefix length from the menu. The preset value is 64 bits.
 - e. Click *Next*.
4. The Select Options window will open. (For more information about the options that affect adding target devices connected to the appliance, see *Topology Synchronization* on page 130.)
For appliances supported by plug-ins, the content of this window may differ; see the appropriate documentation.
 - a. Enable the *Enable secure mode* checkbox if you want the managed appliance to only be accessible by this DSView 3 software system. In non-secure mode, the managed appliance may be added to multiple DSView 3 software systems.
This checkbox will not appear when adding a DSI5100 appliance, which may only be added in Secure mode.
 - b. Enable the *Allow target devices with the same name to be merged into a single target device* checkbox if you wish to merge a target device that has multiple connections into a single target device.
 - c. Under *Allow target devices that contain default names to be added for these type of connections*, you may enable the checkboxes for one or more connection types. Any target devices that contain default names in the managed appliance and support the enabled connection type in the managed appliance will be added to the DSView 3 software database.
This option has no effect when adding a DSI5100 appliance, since default target device names are not supported. A target device is named when it is added as a BMC port using the Add IPMI BMC Wizard.
 - d. Click *Next*.
5. If automatic inheritance is enabled, the Select Group(s) to Inherit window opens. Select the groups to which the appliance will belong and click *Add*. Attached target devices will inherit

these group memberships. Click *Next*. For more information, see *Automatic Inheritance for Group Memberships and Properties* on page 135.

-or-

If you do not want to select groups at this time, click *Do not inherit group membership*.

6. If one or more cascade switches are connected to the managed appliance, the Configure Cascade Switches window will open.
 - a. Select the type of cascade switch for each row from the menu in the Cascade Switch Type column.
 - b. Optionally, type a name for each row in the Name column.
 - c. If two or more rows of a multiuser cascade switch are discovered, you can merge the rows by selecting the checkboxes of those rows and clicking *Merge*. To undo the merge, click the row of the merged switch and click *Split*. For information about other methods for merging cascade switches, see *Topology Synchronization* on page 130.
 - d. Click *Next*.
7. The Apply Configuration Template window opens.

If you want to apply a configuration template to the appliance, select a template from the list and click *Next*.

-or-

If you do not want to apply a configuration template to the appliance, select *None* and click *Next*.

NOTE: For more information about configuration templates, see *Appliance Configuration Templates* on page 137.

8. Click *Finish*.

Adding a single embedded appliance

This procedure is valid only for IBM ASM RSA II, DRAC 4, HP iLO and NEC IPF embedded appliances.

To add a single embedded appliance:

1. In a Units View window containing managed appliances (see *Accessing Units View windows* on page 106), click *Add*. The Add Appliance Wizard will open.
2. The Select Add Unit Procedure window will open. Click *Add a single appliance*, then click *Next*.
3. If you were not in an appliance type Units View window when you clicked *Add* in the first step, the Select Appliance Type window will open. Select an embedded appliance from the product list, then click *Next*.
 - For an IBM ASM RSA II embedded appliance, go to step 4.
 - For a DRAC 4 embedded appliance, go to step 5.

- For an HP iLO embedded appliance, go to step 6.
 - For an NEC IPF embedded appliance, go to step 7.
4. For IBM ASM RSA II embedded appliances:
 - a. The Configure IBM ASM RSA II Settings window will open.
 - b. In the Appliance Name field, type a 1-64 character appliance name. The name is not case sensitive.
 - c. In the Address field, type a 1-256 character IP address in dot notation form or a DNS name. The address is not case sensitive.
 - d. In the Username field, type a 1-64 character username to be used to log in to the embedded appliance. Usernames are case sensitive.
 - e. In the Password field, type a 1-64 character password to be used to log in to the embedded appliance. Passwords are case sensitive.
 - f. Click *Next*.
 - g. The embedded device discovery will verify that a web server exists at the specified IP address. If successful, the Select Option window will open.
 - h. Enable or disable the *Allow target devices with the same name to be merged into a single target device* checkbox.
 - i. Click *Next*. Go to step 8.
 5. For DRAC 4 embedded appliances:
 - a. The Configure DELL DRAC4 Settings window will open.
 - b. In the Appliance Name field, type a 1-64 character appliance name. The name is not case sensitive.
 - c. In the Address field, type a 1-256 character IP address in dot notation form or a DNS name. The address is not case sensitive.
 - d. In the Port field, type a TCP port number in the range 0-65535 where the appliance will listen.
 - e. In the Username field, type a 1-64 character username to be used to log in to the embedded appliance. Usernames are case sensitive.
 - f. In the Password field, type a 1-64 character password to be used to log in to the embedded appliance. Passwords are case sensitive.
 - g. Click *Next*.
 - h. The embedded device discovery will verify that a web server exists at the specified IP address. If successful, the Select Option window will open.
 - i. Enable or disable the *Allow target devices with the same name to be merged into a single target device* checkbox.
 - j. Click *Next*. Go to step 8.
 6. For HP iLO embedded appliances:

- a. The Configure HP iLO Settings window will open.
 - b. In the Appliance Name field, type a 1-64 character appliance name. The name is not case sensitive.
 - c. In the Address field, type a 1-256 character IP address in dot notation form or a DNS name. The address is not case sensitive.
 - d. Click *Next*. Go to step 8.
7. For NEC IPF embedded appliances:
- a. The Configure NEC IPF Settings window will open.
 - b. In the Address field, type a 1-256 character IP address in dot notation form or a DNS name. The address is not case sensitive.
 - c. In the Username field, type a 1-64 character username to be used to log in to the embedded appliance. Usernames are case sensitive.
 - d. In the Password field, type a 1-64 character password to be used to log in to the embedded appliance. Passwords are case sensitive.
 - e. Click *Next*.
 - f. The embedded device discovery will verify that the embedded appliance's product ID matches the appliance type. If successful, the Select Options window will open.
 - g. The Appliance Name field contains the name stored in the embedded appliance. You may change this to a 1-256 character unique name. Names are not case sensitive.
 - h. Enable or disable the *Allow target devices with the same name to be merged into a single target device* checkbox.
 - i. Click *Next*.
8. Click *Finish*.

Adding managed appliances from a range or list of IP addresses

This procedure is valid for supported KVM switches and serial console appliances. It may also be valid for appliances supported by a plug-in; see the appropriate documentation.

To add a managed appliance from a range or list of IP addresses:

1. In a Units View window containing managed appliances (see *Accessing Units View windows* on page 106), click *Add*. The Add Appliance Wizard will open.
2. The Select Add Unit Procedure window will open.
3. To enter IP addresses as a delimited list, click *Add multiple appliances*, then click *Next*. Enter IPv4 and/or IPv6 addresses, separated by either a comma (,) or a semi-colon (;).

-or-

To enter an IP address range, click *Discover appliances on the network from an IPv4 address range or an IPv6 subnet*, then click *Next*. Select *Use IPv4 address range* and type the IP address from which to begin and end the search in the corresponding fields, or select *Use IPv6 subnet* and type the IPv6 network prefix in the corresponding field. Click *Next*.

4. The DSView 3 software will search for managed appliances within the IP address range. When the search is completed, the Select Appliances to Add window will open, listing the results.
5. Add or remove appliances.
 - To add one or more managed appliances, select the managed appliances in the Appliances found list, then click *Add*. The managed appliances will be moved to the Appliances to Add list.
 - To remove one or more managed appliances, select the managed appliances in the Appliances to Add list, then click *Remove*. The managed appliances will be moved to the Appliances found list.

Click *Next*.

6. The Select Options window will open. (For more information about the options that affect adding target devices connected to the appliance, see *Topology Synchronization* on page 130.) For appliances that are supported by plug-ins, the content of this window may differ; see the appropriate documentation.
 - a. Click *Enable secure mode* if you want the managed appliance to only be accessible by this DSView 3 software system. In non-secure mode, the managed appliance may be added to multiple DSView 3 software systems.

NOTE: For appliances that require Secure mode, this checkbox will not be visible and the appliance will enable Secure mode automatically.

- b. Click *Allow target devices with the same name to be merged into a single target device* if you wish to merge a target device that has multiple connections into a single target device.
 - c. Under *Allow target devices that contain default names to be added for these type of connections*, you may enable one or more connection types. Any target devices that contain default names in the managed appliance and support the enabled connection type in the managed appliance will be added to the DSView 3 software database.
This option has no effect when adding a DSI5100 appliance, since default target device names are not supported. A target device is named when it is added as a BMC port using the Add IPMI BMC Wizard.
 - d. Click *Next*.
7. The Adding Appliances window will open while the selected managed appliances are added to the DSView 3 software system.
8. The Apply Configuration Template window opens.
If you want to apply a configuration template to the appliance, select a template from the list and click *Next*.
-or-
If you do not want to apply a configuration template to the appliance, select *None* and click *Next*.

NOTE: For more information about configuration templates, see *Appliance Configuration Templates* on page 137.

9. Click *Finish*.

Adding a generic appliance or an EVR1500 environmental monitor

To add a single EVR1500 environmental monitor or generic appliance:

1. Click *Add* in a Units View window. The Add Unit Wizard will open.
2. The Select Add Unit Procedure window will open. Click *Add a single appliance*, then click *Next*.
3. The Select Appliance Type window will open. Select *EVR1500* or *Generic* from the product list, then click *Next*.
4. A Configure Generic Appliance Settings window will open.
 - a. Type the name.
 - b. Type either the address or the fully qualified domain name.
 - c. Type the Telnet port.
 - d. Type the web browser URL.
 - e. Click *Next*.
5. Click *Finish*.

Adding a target device

You may add a target device using the Add Target Device Wizard, which is described in this section. You may also add a target device using the Attach Target Device Wizard, which is available from a Units View window that has the topology view enabled. See *Topology view* on page 104.

To add a power device, see *Power Devices* on page 165. To add BMCs, see the DSI5100 Operations for the DSView 3 Software Technical Bulletin, available on the Avocent web site.

To add a target device:

1. In a Units View window containing target devices (see *Accessing Units View windows* on page 106), click *Add*. If you are in a target device view window, the Add Target Device Wizard will open. If you are in a mixed view window, the Add Unit Wizard will open.
2. If you were in a mixed view window when you clicked *Add*, the Select Add Unit Procedure window will open. Click *Add a single target device*. Click *Next*.
If you were in a target device view window when you clicked *Add*, go to the next step.
3. The Type in Device Settings window will open, where you may enter optional information: name, address or fully qualified domain name, Telnet port and web browser URL.
4. Click *Finish*.

Deleting Units

When you delete a unit, it is removed from the DSView 3 software database, and all associated connections will also be deleted.

You may also choose to delete target devices that are no longer connected when you run the Resync Wizard; see *Topology synchronization options in the Resync Wizard* on page 132.

To delete a power device, see *Power Devices* on page 165.

To delete a unit:

1. In a Units View window (see *Accessing Units View windows* on page 106), click the checkbox next to the unit name. To delete all units on the page, click the checkbox to the left of Name at the top of the list.
2. Click *Delete*. You are prompted to confirm the deletion.
3. Confirm or cancel the deletion.

Automatically deleting attached units

For target devices exclusively managed by a single appliance, you may specify that the target devices are automatically deleted when the managing appliance is deleted.

To modify target device delete policy settings:

1. Click the *System* tab.
2. Click *Global Properties* in the top navigation bar. Click *Units*, then click *Deletion* in the side navigation bar.
3. If you want target devices automatically deleted, select *Delete target devices that no longer have connection*.

-or-

If you do not want target devices automatically deleted, select *Do not delete the target devices*.

Synchronizing the DSView 3 Software Database

This chapter describes how to synchronize the DSView 3 software database with changes that occur on units.

Name Synchronization

Units and connections in the DSView 3 software system have a “Name in DSView”, which is the name stored in the DSView 3 software database. Some units (appliance serial ports, cascade switches, target devices, power devices and power device sockets) may also have a “Name in Appliance,” which is the name stored in the managed appliance.

The DSView 3 software name synchronization feature will “push” and/or “pull” names. You may enable the name push and name pull operations to run automatically. You may also push and pull names manually.

Name push

When the name of a target device or cascade device is changed in the DSView 3 software database, a push operation will update the target device, cascade device, serial port and power device socket names in the appliance.

You may also rename units associated with a single connection to a target device in the DSView 3 software database. The name push operation will then push the new unit names to the appliance.

Name pull

When the name of a target device, cascade device, serial port or power device socket is changed in a managed appliance, a pull operation will update the target device and cascade device names in the DSView 3 software database.

You may enable/disable automatic name push and automatic name pull. You may also manually initiate a push or pull operation at any time.

Automatic name push

When automatic name push is enabled, the name push operation occurs automatically when a name is changed in the DSView 3 software.

Table 9.1: Automatic Name Push Operation Effects

Unit	Effect
Appliance serial ports	If the target device for the serial port in the DSView 3 software database has a single appliance connection, the target device name will be pushed to the appliance.
	If the target device for the serial port in the DSView 3 software database has multiple appliance connections, the target device name will be pushed to the appliance for each appliance connection (for connection type(s) enabled in the Automatic Name Push Properties window).
Power devices	The power device name in the DSView 3 software database will be pushed to the appliance.
Power device sockets	If the target device for the power device socket in the DSView 3 software database has a single appliance connection, the target device name will be pushed to the appliance.
	If the target device for the power device socket in the DSView 3 software database has multiple appliance connections, the target device name will be pushed to each appliance for each appliance connection (for connection type(s) enabled in the Automatic Name Push Properties window).
Target devices	If the target device in the DSView 3 software database has a single appliance connection, the target device name will be pushed to the appliance.
	If the target device in the DSView 3 software database has multiple appliance connections, the target device name will be pushed to the appliance for each appliance connection (for connection type(s) enabled in the Automatic Name Push Properties window).
Cascade switches	If the cascade switch in the DSView 3 software database has a single appliance connection, the name will be pulled from the appliance to update the cascade switch name in the DSView 3 software database.
	If the cascade switch in the DSView 3 software database has multiple appliance connections to the same appliance (a multiuser cascade switch), the cascade switch name will be pulled from the appliance connection with the lowest port number to update the cascade switch in the DSView 3 software database. (Multiuser cascade switches are treated as separate cascade switches by the appliance.)

To enable or disable automatic name push:

1. Click the *System* tab.
2. Click *Global Properties* in the top navigation bar.
3. Click *Units - Synchronization* in the side navigation bar, then click *Auto Name Push*.

4. The Automatic Name Push Properties window will open. To enable automatic name push, enable the *Push Names from DSView to appliances automatically* checkbox.
To disable automatic name push, disable the *Push Names from DSView to appliances automatically* checkbox and go to the last step.
5. Enable the checkboxes for one or more appliance connection types. The name in the DSView 3 software will be pushed to the appliance if the target device has a connection that matches the selected type.
6. Click *Save*.

Automatic name pull

When automatic name pull is enabled, the name pull operation occurs automatically when an appliance name is changed.

Table 9.2: Automatic Name Pull Operation Effects

Unit	Effect
Appliance serial ports	<p>If the target device for the serial port in the DSView 3 software database has a single appliance connection, the target device name will be pulled from the appliance to update the target device name in the DSView 3 software database.</p> <p>If the target device for the serial port in the DSView 3 software database has multiple appliance connections, the target device name will be pulled from one of the appliance connections (based on the configured connection type priority) to update the target device name in the DSView 3 software database.</p>
Power devices	<p>The power device name will be pulled from the appliance to update the power device name in the DSView 3 software database.</p>
Power device sockets	<p>If the target device for the power device socket in the DSView 3 software database has a single appliance connection, the target device name will be pulled from the appliance to update the target device name in the DSView 3 software database.</p> <p>If the target device for the power device socket in the DSView 3 software database has multiple appliance connections, the target device name will be pulled from one of the appliance connections (based on the configured connection type priority) to update the target device name in the DSView 3 software database.</p>
Target devices	<p>If the target device in the DSView 3 software database has a single appliance connection, the name will be pulled from the appliance to update the target device name in the DSView 3 software database.</p> <p>If the target device in the DSView 3 software database has multiple appliance connections, the target device name will be pulled from one of the appliance connections (based on the configured connection type priority) to update the target device name in the DSView 3 software database.</p>

Table 9.2: Automatic Name Pull Operation Effects (Continued)

Unit	Effect
Cascade switches	<p>If the cascade switch in the DSView 3 software database has a single appliance connection, the name will be pulled from the appliance to update the cascade switch name in the DSView 3 software database.</p> <p>If the cascade switch in the DSView 3 software database has multiple appliance connections to the same appliance (a multiuser cascade switch), the cascade switch name will be pulled from the appliance connection with the lowest port number to update the cascade switch in the DSView 3 software database. (Multiuser cascade switches are treated as separate cascade switches by the appliance.)</p>

The following sections describe how to change a unit's Name in Appliance:

- Power device - see *Power Devices* on page 165
- Power device socket - see *Power Device Sockets* on page 168
- Cascade switch - see *KVM Switch and Cascade Switch Settings* on page 154
- Target device - see *Target Device Settings* on page 150

To enable or disable automatic name pull:

1. Click the *System* tab.
2. Click *Global Properties* in the top navigation bar.
3. Click *Units - Synchronization* in the side navigation bar, then click *Auto Name Pull*.
4. The Automatic Name Pull Properties window will open. To enable automatic name pull, enable the *Pull Names from appliances to DSView automatically* checkbox.
To disable automatic name pull, disable the *Pull Names from appliances to DSView automatically* checkbox and go to the last step.
5. For target devices that have multiple connections, you may set the connection type priority by using the arrows to re-order the available types. This order determines which target device name will be pulled from one or more appliances to update the DSView 3 software database. The name will be pulled from only one appliance.
6. Click *Save*.

Manual name push

You may initiate a manual name push from a Units View window (see below) and from the following windows:

- Target Devices window - see *Target Device Settings* on page 150
- Power Device window - see *Power Devices* on page 165
- Power Device Sockets window - see *Power Device Sockets* on page 168

- Appliance cascade switches window - see *KVM Switch and Cascade Switch Settings* on page 154

To initiate a name push operation from a Units View window:

1. In a Units View window (see *Accessing Units View windows* on page 106), click the checkboxes next to one or more units. To select all units on the page, click the checkbox to the left of the heading at the top of the list.
2. Click *Operations*, then select *Push Names to Appliance* from the drop-down menu.
3. The Multiple Unit Operations window will open, containing a link to the Operation Results window; see *Multiple unit operations from a Units View window* on page 111.

Manual name pull

Table 9.3 describes what occurs when a name pull operation is initiated.

Table 9.3: Manual Name Pull Operation Effects

When pull is initiated for one or more:	The effect is
Appliance serial ports	The target device name will be pulled from the appliance to update the target device name in the DSView 3 software database.
Power devices	The power device name will be pulled from the appliance to update the power device name in the DSView 3 software database.
Power device sockets	The target device name will be pulled from the appliance to update the target device name in the DSView 3 software database.
Target devices	The target device name will be pulled from the appliance to update the target device name in the DSView 3 software database.
Cascade switches	The cascade switch name will be pulled from the appliance to update the cascade switch name in the DSView 3 software database. If the cascade switch in the DSView 3 software database has multiple appliance connections to the same appliance (a multiuser cascade switch), the cascade switch name will be pulled from the appliance connection with the lowest port number to update the cascade switch in the DSView 3 software database. Multiuser cascade switches are treated as separate cascade switches by the managed appliance.

You may initiate a manual name pull from a Units View window and from the following windows:

- Target Devices window - see *Target Device Settings* on page 150
- Power Device window - see *Power Devices* on page 165
- Power Device Sockets window - see *Power Device Sockets* on page 168
- Appliance cascade switches window - see *KVM Switch and Cascade Switch Settings* on page 154

To initiate a name pull operation from a Units View window:

1. In a Units View window (see *Accessing Units View windows* on page 106), click the checkboxes next to one or more units. To select all units on the page, click the checkbox to the left of the heading at the top of the list.
2. Click *Operations*, then select *Pull Names from Appliance* from the drop-down menu.
3. The Multiple Unit Operations window will open, containing a link to the Operation Results window; see *Multiple unit operations from a Units View window* on page 111.

Topology Synchronization

The topology synchronization operation updates the DSVIEW 3 software database when a change occurs in a managed appliance. Examples of changes are the adding/removing of an IQ adaptor, cascade switch or power device.

Synchronization options include:

- Merge target device names - A target device that has connections to more than one appliance managed by the DSVIEW 3 software can appear as two different devices when the appliances are added to the DSVIEW 3 software database. For example, a server may have a serial console port connected to a serial console appliance, which is used during the boot process. The same server may also have a KVM connection to a KVM switch that is accessible after the server is up and running. You may configure that target device to appear only once, and the DSVIEW 3 software will provide the valid Action choices for accessing the device.
- Default target device names allowed for connection types - If a target device has a default name, you may indicate that it can be added to the DSVIEW 3 software database only if it supports specific connection type(s) in the appliance - for example, KVM, serial or power.
- You may enable/disable deleting target devices that no longer have connections from the DSVIEW 3 software database.

You may enable or disable automatic topology synchronization. You may also control topology synchronization manually by:

- Enabling or disabling options when the Add Unit Wizard runs.
- Enabling or disabling options when the Resync Wizard runs.
- Initiating a target device or cascade switch merge operation from a Unit Overview window.
- Initiating a target device merge operation from the Unit Tools window (see *Merging target devices* on page 307).
- Initiating a cascade switch merge operation on two multiuser cascade switches in the same appliance from a Units View window.
- Scheduling or manually running the update topology task (see *Task: Update topology for selected units* on page 331).

Automatic topology synchronization

NOTE: Automatic topology synchronization is not supported on some managed appliances, including the LANDesk® Server Manager. Alternatively, you may schedule the update topology task to keep these appliances synchronized with the DSView 3 software. See *Task: Update topology for selected units* on page 331.

To enable or disable automatic topology synchronization:

1. Click the *System* tab.
2. Click *Global Properties* in the top navigation bar.
3. Click *Units - Synchronization* in the side navigation bar, then click *Auto Topology*.
4. The Automatic Topology Properties window will open. To enable automatic topology synchronization, enable the *Update DSView with topology changes from appliances automatically* checkbox.

To disable automatic topology synchronization, disable the *Update DSView with topology changes from appliances automatically* checkbox and go to the last step.

5. If you enable the *Allow target devices with the same name to be merged into a single target device* checkbox, the connection to a target device in the appliance will be merged with the connection(s) to an existing target device in the DSView 3 software database.
6. If you enable the *Delete Target Devices that no longer have connections* checkbox, target devices that no longer have connections will be permanently deleted from the DSView 3 software database.
7. If you enable the *Add a target device to new connections* checkbox, a target device in the appliance will be added to a new unit (appliance, power device or cascade switch) connection in the DSView 3 software database.

If you disable this checkbox, the target device in the appliance will not be added automatically to a new unit connection in the DSView 3 software database. However, you can add it manually; see *Topology view* on page 104.
8. If you enable the *Allow target devices that contain default names to be added for these type of connections* checkbox, you may then enable one or more connection type checkboxes. Any target devices that contain default names in the appliance will be added to the DSView 3 software database only if the connection type in the appliance matches an enabled connection type in this window.
9. Click *Save*.

Topology synchronization options in the Add Unit Wizard

The Select Options window in the Add Unit Wizard allows you to specify the access mode and certain topology synchronization options.

- Enable/disable secure mode
- Merge target device names

- Default target names allowed for connection types

This window is described in *Adding Units* on page 115.

Each of these options has a default value, which you may change.

To change the default values of the options in the Add Unit Wizard:

1. Click the *System* tab.
2. Click *Global Properties* in the top navigation bar.
3. Click *Wizard Defaults* in the side navigation bar, then click *Add Unit Wizard*.
4. The Add Unit Wizard Default Options window will open.
5. If you enable the *Enable secure mode* checkbox, by default, the unit will only be accessible by this DSView 3 software system. In non-secure mode, the unit may be added to multiple DSView 3 software systems.
6. If you enable the *Allow target devices with the same name to be merged into a single target device* checkbox, by default, the connection to a target device in the appliance will be merged with the connection(s) to an existing target device in the DSView 3 software database.
7. If a target device has a default name, you may indicate that, by default, it can be added to the DSView 3 software database only if it supports specific connection type(s) in the appliance. Enable the checkboxes for the specific connection types.
8. Click *Save*.

Topology synchronization options in the Resync Wizard

The Select Resync Options window in the Resync Wizard allows you to specify certain topology synchronization options.

- Remove offline connections
- Delete target devices that no longer have connections
- Merge target device names
- Default target names allowed for connection types

This window is described in *Resynchronizing units* on page 315.

Each of these options has a default value, which you may change.

To change the default values of the options in the Resync Wizard:

1. Click the *System* tab.
2. Click *Global Properties* in the top navigation bar.
3. Click *Wizard Defaults* in the side navigation bar, then click *Resync Wizard*.
4. The Resync Wizard Default Options window will open.
 - If you enable the *Remove offline connections* checkbox, by default, any appliance connections that are reported as offline in the appliance will be deleted from the DSView 3

software database. The Resync Wizard does not add offline connections to the DSView 3 software database.

- If you enable the *Delete target devices that no longer have connections* checkbox, by default, any target devices that no longer have connections are permanently deleted from the DSView 3 software database.
- If you enable the *Allow target devices with the same name to be merged into a single target device* checkbox, by default, the connection to a target device in the appliance will be merged with the connection(s) to an existing target device in the DSView 3 software database.
- If a target device has a default name, you may indicate that, by default, it can be added to the DSView 3 software database only if it supports specific connection type(s) in the appliance. Enable the checkboxes for the specific connection types.

5. Click *Save*.

Merging target devices

Merging target devices may be necessary if a target device is connected to one or more managed appliances. For example, if a target device is connected to both a DSR switch and an ACS console server, this tool will merge the target devices (that were created when the managed appliances were added) into a single target device that contains all of the target actions.

You may also merge target devices from a Unit Tools window, see *Merging target devices* on page 307.

To merge target devices from a Units View window:

1. In a Units View window containing target devices (see *Accessing Units View windows* on page 106), click on the target device name. The Unit Overview window will open.
2. Click the *Merge Target Devices* icon or link. The Merge Target Devices Wizard will appear.
3. The Select Target Devices to Merge window will open. The selected target device will be listed in the Target Devices to Merge list.
 - To add one or more target devices to the merge list, select the target device(s) in the Available Target Devices list, then click *Add*. The target devices will be moved to the Target Devices to Merge list.
 - To remove one or more target devices from the merge list, select the target device(s) from the Target Devices to Merge list, then click *Remove*. The target devices will be moved to the Available Target Devices list.
 - To merge target devices in a particular order, select one or more target devices in the Target Devices to Merge list and use the up and down arrows to move the selected target devices up or down in the listing. Once the order has been specified, select *Merge missing properties to the target device based on the order of the devices in the "Target Devices to Merge" list*.

The merged target devices will contain the name of the first target device in the Target Device to Merge list. For example, if you are merging two target devices named TD1 and TD2, and TD2 is listed before TD1, the merged target device will be named TD2.

Click *Next*.

4. The Confirm Target Device Merge window will open. Click *Next* to confirm merging the connection paths into the specified destination target device. See *Connections to Units* on page 181.
5. The Completed Successful window will open.
6. Click *Finish*.

To merge target devices from a Units View window:

1. In a Units View window containing target devices (see *Accessing Units View windows* on page 106), select the checkbox next to the target devices that you want to merge.
2. From the Operations menu, select *Merge Target Devices*. The Merge Target Devices window opens.
3. Select the target devices to be merged from the Available Targets list. The merged target devices will contain the name of the first target device in the Target Device to Merge list. For example, if you are merging two target devices named TD1 and TD2, and TD2 is listed before TD1, the merged target device will be named TD2. The Connection Path(s) list displays the appliance and the specified destination target device.
4. (Optional) To merge target devices in a particular order, select one or more target devices in the Target Devices to Merge list and use the up and down arrows to move the selected target devices up or down in the listing. Once the order has been specified, select *Merge missing properties to the target device based on the order of the devices in the "Target Devices to Merge" list*.
5. Click *Merge*.

Merging or splitting cascade switches

You may use the Merge Cascade Switch wizard to modify the name/type of one or more cascade switches that belong to the same appliance in the DSView 3 software database. You may also merge or split two or more multi-user cascade switches from the same appliance.

To merge or split cascade switches:

1. In a Units View window containing cascade switches (see *Accessing Units View windows* on page 106), click on the cascade switch name. The Unit Overview window will open.
2. Click the *Merge Target Devices* icon or link. The Merge Cascade Switches Wizard will appear.
3. The Cascade Switch Configuration window will open. The Appliance Port column lists the ports in the appliance that are connected to cascade switches.

4. You may change the cascade switch type by selecting from the drop-down menu. If you change the cascade switch name, it must contain 1-64 characters and must not exist in the DSView 3 software database unless it is associated with a multi-user cascade switch.
5. To merge cascade switches, click the checkboxes to the left of the entries, then click *Merge*.
6. To split a previously merged set of cascade switches, click the checkbox to the left of the entry, then click *Split*.
7. Click *Next*. The Operation in Progress window will open, followed by the Completed Successful window.
8. Click *Finish*.

Automatic Discovery

NOTE: Automatic discovery is only supported for DSR switches. To be available for automatic discovery, discovery settings on the DSR switch must be configured with the DSView 3 Server IP address. For more information, see the DSR Installer/User Guide.

To enable or disable automatic discovery:

1. Click the *System* tab.
2. Click *Global Properties* in the top navigation bar.
3. Click *Units - Synchronization* in the side navigation bar, then click *Auto Discovery*.
4. Enable the *Enable Auto Discovery* checkbox if you want the DSView 3 software to automatically discover supported appliances.
5. Enable the *Enable secure mode* checkbox if you want the managed appliance to only be accessible by this DSView 3 system. In non-secure mode, the managed appliance may be added to multiple DSView 3 systems.
6. If you enable the *Allow target devices with the same name to be merged into a single target device* checkbox, by default, the connection to a target device in the appliance will be merged with the connection(s) to an existing target device in the DSView 3 database.

Successful or failed automatic discovery generates a DSView 3 event.

Automatic Inheritance for Group Memberships and Properties

You can allow new target devices to inherit group memberships and some properties from the appliances to which the target devices are attached. Only location, contacts, notes and custom field properties are inherited. For information about assigning properties to a unit, see *Unit Properties* on page 139.

To enable automatic inheritance:

1. Click the *System* tab.
2. Click *Global Properties* in the top navigation bar.

3. Click *Automatic Inheritance* in the side navigation bar.
4. To allow new target devices to inherit group membership and properties from the appliance, select *Allow new target devices to inherit the group memberships and properties from the corresponding appliance*.
5. Click *Save*.

When automatic inheritance is enabled, the following occurs:

- When you use the Add Unit Wizard to add an appliance, you can specify the group for which you want the appliance to belong. Attached target devices will inherit these group memberships. Or, you can select *Do not inherit group membership*. See *Adding a single managed appliance* on page 116. Properties are not inherited at this time because the new appliance does not yet have any properties assigned.
- When new attached target devices are discovered using automatic topology synchronization, the Resync Wizard or the update topology task, the new target devices inherit group memberships and location, contacts, notes and custom field properties from the appliance. For more information about these operations, see *Automatic topology synchronization* on page 131, *Resynchronizing units* on page 315 and *Task: Update topology for selected units* on page 331.

Managing Units

This chapter describes how to manage unit properties and settings, access rights and local account settings, and how to view unit asset and usage reports.

Appliance Configuration Templates

Appliance configuration templates allow DSView 3 administrators to quickly configure new units or replace failed units. You can create an appliance configuration template based on any supported unit in the DSView 3 software system. The appliance configuration template saves the properties of the model unit so that they can be applied to other units. Two classifications of settings are saved in appliance configuration templates:

- Personality data is specific to a single unit and is only applied during a replace appliance operation. An example of personality data is an IP address.
- Fixed data is specific to the unit family (such as DSR 8035 switches) but is not specific to a single unit. Fixed unit data, such as session time-outs, is applied during both an apply appliance configuration template operation and a replace appliance operation.

You can also create appliance configuration templates that are specific to a single unit. For example, once the unit is configured, you may wish to use the Save Last Known Good Configuration Template operation to create an appliance configuration template of the unit in that state. You can also use the Save Current Configuration Template to create an appliance configuration template of the unit in its current state. These templates can later be applied to the unit if needed.

NOTE: For appliances that do not support appliance configuration templates, the related buttons and links are not displayed.

Saving appliance configuration templates

Saving an appliance configuration template generates a DSView 3 event.

To save an appliance configuration template:

NOTE: This procedure creates an appliance configuration template than can be applied to any unit of the same family as the model unit.

1. In a Units View window containing appliances (see *Accessing Units View windows* on page 106), select the appliance you want to use as the model for the appliance configuration template. The Unit Overview window opens.
2. Click the *Save Configuration Template* icon or link. The Save Appliance Configuration Template Wizard opens.
3. Enter a name for the appliance configuration template. Click *Next*.
4. The Completed Successful window opens. Click *Finish*.

To save the last known good or current configuration template:

NOTE: This procedure creates appliance configuration templates that can only be applied to the selected unit.

In a Units View window containing appliances (see *Accessing Units View windows* on page 106), select the appliance for which you want to save an appliance configuration template. Click the *Save Last Known Good Configuration Template* or *Save Current Configuration Template* icon or link.

-or-

In a Units View window containing appliances, select the checkbox next to the appliance for which you want to apply the appliance configuration template. From the Operations menu, select *Save Last Known Good Configuration Template* or *Save Current Configuration Template*.

Modifying appliance configuration template properties

To view, modify or delete appliance configuration template files:

NOTE: Administrator rights are required to view and delete appliance configuration template files.

1. Click the *System* tab.
2. Click *Appliance Files* in the top navigation bar.
3. Click *Configuration Template* in the side navigation bar. A list of configuration templates is displayed.
4. To delete an appliance configuration template, select the checkbox next to the template(s) and click *Delete*.
5. To view the properties of an appliance configuration template, click the name of the template.
6. The appliance configuration template properties are displayed, including the name, supported unit type, creation date and the unit that created the template. To change the name, enter a new name and click *Save*.
7. Click *Close*.

Applying appliance configuration templates

Applying appliance configuration templates generates a DSView 3 event.

To apply an appliance configuration template to a new appliance:

1. In a Units View window containing appliances (see *Accessing Units View windows* on page 106), select the appliance for which you want to apply the appliance configuration template. The Unit Overview window opens. Click the *Apply Configuration Template* icon or link. The Save Appliance Configuration Template Wizard opens.

-or-

In a Units View window containing appliances, select the checkbox next to the appliance for which you want to apply the appliance configuration template. From the Operations menu, select *Apply Configuration Template*.

2. From the list, select the appliance configuration template you want to apply. Click *Save*.

-or-

Select *Apply Last Known Good Configuration Template*.

-or-

Select *Apply Current Configuration Template*.

3. The Completed Successful window opens. Click *Finish*.

Or, to apply the appliance configuration template during the Add Unit Wizard, see *Adding Units* on page 115.

To replace a failed appliance:

1. In a Units View window containing appliances (see *Accessing Units View windows* on page 106), select the appliance for which you want to apply the appliance configuration template. The Unit Overview window opens. Click the *Appliance Replacement* icon or link. The Save Appliance Configuration Template Wizard opens.

-or-

In a Units View window containing appliances, select the checkbox next to the appliance for which you want to apply the appliance configuration template. From the Operations menu, select *Appliance Replacement*.

2. Enter the IP address of the failed appliance.
3. From the list, select the appliance configuration template you want to apply. Click *Save*.
4. The *Completed Successful* window opens. Click *Finish*.

Unit Properties

A user with access rights may change the following properties for a unit:

- Overview - Specify the type and icon for a target device.
- Identity - May be helpful for quickly identifying information about a unit.
- Location (site, department and location) - May be helpful for identifying where a unit is. See *Site, Department and Location Groups* on page 205.

- Contacts - Identify the primary and secondary contacts may be helpful for quickly identifying the people to notify if an issue or question arises about a particular unit.
- Custom fields - Ten custom fields are available, in which you may specify any information you wish. For example, you may wish to define custom fields such as Program Manager, Building Number and so on. See *Custom Fields* on page 207.
- Notes.
- Network.
- KVM session profile. See *Managing KVM session profiles* on page 259.

You may specify which properties display in a Units View window by using the *Customize* link. See *Using the Customize link in windows* on page 28.

You may change a single property for one or more units at a time, or you may change multiple properties for multiple units by using the Properties - Bulk Edit operation.

To change multiple properties for multiple units using the Properties - Bulk Edit operation:

1. In a Units View window (see *Accessing Units View windows* on page 106), select the checkboxes next to the appliances or target devices that you want to edit.
2. Click *Operations*, then select *Properties - Bulk Edit* from the drop-down menu.
3. The Bulk Edit Unit Properties window opens. The unit names are displayed in the left column, and the properties are displayed in the adjacent columns. You can scroll to view columns, or specify which columns are displayed by clicking *Select Columns*. Select the properties that you want to be displayed, click *Add*, then click *Save*.
4. To edit unit properties, type the values in the appropriate fields. To quickly navigate the spreadsheet, use the **Tab** and **Shift + Tab** keystrokes to move right and left and the **Enter** and **Shift + Enter** keystrokes to move down and up.
5. Click *Save*.

To change overview information for one or more target devices:

1. In a Units View window containing target devices (see *Accessing Units View windows* on page 106), click the checkbox next to one or more target devices. To change overview information for all target devices in the page, click the checkbox to the left of Name at the top of the list.
2. Click *Operations*, then select *Properties* from the drop-down menu.
3. The Multiple Unit Properties window will open. Click *Unit Overview*.
4. Enter a new type for the target devices.
5. Select a new icon for the target devices using the arrows.
6. Click *Save* and then click *Close*. The Units View window will open. If you added a type that was not previously defined, it will appear under Target Devices in the side navigation bar.

To change the identity properties for a unit:

NOTE: Identity properties are visual representations only. Defining incorrect information may cause confusion (for example, mistyping a serial number).

1. In a Units View window (see *Accessing Units View windows* on page 106), click on the appliance or target device name.
2. Click *Properties* in the side navigation bar. The Unit Identification Properties window will open. To change information, type a part number, serial number, model number and/or asset tag number.
3. Click *Save* and then click *Close*. The Units View window will open.

To change the location properties for a unit:

NOTE: Location properties are visual representations only. Defining incorrect information may cause confusion (for example, a mistyped room number).

1. In a Units View window (see *Accessing Units View windows* on page 106), click on the appliance or target device name.
2. Click *Properties* in the side navigation bar and then click *Location* in the side navigation bar. The Unit Location Properties window will open.
3. Type or use the menus to select the site, department and/or location for the unit.
4. Click *Save* and then click *Close*. The Units View window will open.

To change the location properties for one or more units from a Units View window:

1. In a Units View window (see *Accessing Units View windows* on page 106), click the checkbox next to the unit(s). To change location properties for all units in the page, click the checkbox to the left of Name at the top of the list. (If the page contains units that do not support location properties, they will not be affected.)
2. Click *Operations*, then select *Properties* from the drop-down menu.
3. The Multiple Unit Properties window will open. Click *Location*.
4. Type or use the menus to specify the site, department and/or location for the units.
5. Click *Save* and then click *Close*. The Units View window will open.

To change the contact properties for a unit:

1. In a Units View window (see *Accessing Units View windows* on page 106), click on the appliance or target device name.
2. Click *Properties* in the side navigation bar and then click *Contacts* in the side navigation bar. The Unit Contacts window will open. Type the names and phone numbers of the primary and secondary contacts.
3. Click *Save* and then click *Close*. The Units View window will open.

To change the contact properties for one or more units from a Units View window:

1. In a Units View window (see *Accessing Units View windows* on page 106), click the checkbox next to the unit(s). To change contact properties for all units in the page, click the checkbox to the left of Name at the top of the list. (If the page contains units that do not support contact properties, they will not be affected.)
2. Click *Operations*, then select *Properties* from the drop-down menu.
3. The Multiple Unit Properties window will open.
 - To change the primary contact information, click *Primary Contact*. Type names and phone numbers for the primary contact.
 - To change the secondary contact information, click *Secondary Contact*. Type names and phone numbers for the secondary contact.
4. Click *Save* and then click *Close*. The Units View window will open.

To change the custom fields for a unit:

1. In a Units View window (see *Accessing Units View windows* on page 106), click on the appliance or target device name.
2. Click *Properties* in the side navigation bar, then click *Custom Fields* in the side navigation bar. The Unit Custom Fields window will open. To change information, type the information in each of the custom fields.
3. Click *Save* and then click *Close*. The Units View window will open.

To change the custom fields for one or more units from a Units View window:

1. In a Units View window (see *Accessing Units View windows* on page 106), click the checkbox next to the unit(s). To change custom fields for all units in the page, click the checkbox to the left of Name at the top of the list. (If the page contains units that do not support custom fields, they will not be affected.)
2. Click *Operations*, then select *Properties* from the drop-down menu.
3. The Multiple Unit Properties window will open. Click *Custom Fields*.
4. Type the information in each of the custom fields.
5. Click *Save* and then click *Close*. The Units View window will open.

To change the note properties for a unit:

1. In a Units View window (see *Accessing Units View windows* on page 106), click on the appliance or target device name.
2. Click *Properties* in the side navigation bar and then click *Notes* in the side navigation bar. The Unit Notes window will open. Type description, accounting and comment information.
3. Click *Save* and then click *Close*. The Units View window will open.

To change the note properties for one or more units from a Units View window:

1. In a Units View window (see *Accessing Units View windows* on page 106), click the checkbox next to the unit(s). To change note properties for all units in the page, click the checkbox to the left of Name at the top of the list. (If the page contains units that do not support note properties, they will not be affected.)
2. Click *Operations*, then select *Properties* from the drop-down menu.
3. The Multiple Unit Properties window will open. Click *Notes*.
4. Type description, accounting and comment information.
5. Click *Save* and then click *Close*. The Units View window will open.

To change the network properties for a target device:

NOTE: Defining incorrect information for these properties may cause network connection errors.

1. In a Units View window containing target devices (see *Accessing Units View windows* on page 106), click on the target device name.
2. Click *Properties* in the side navigation bar and then click *Network* in the side navigation bar. The Unit Network Properties window will open.
 - Type the address or the fully qualified domain name for the target device.
 - Type the Telnet port number to use for Telnet connections to the target device. If this field is left blank, Telnet will not be enabled for the target device.
 - Type the URL for a web browser connection to the target device.
 - Select the DSView 3 server that is in charge of the target device.
3. Click *Save* and then click *Close*. The Units View window will open.

To change the network properties for a managed appliance:

1. In a Units View window containing appliances (see *Accessing Units View windows* on page 106) click on the appliance name.
2. Click *Properties* in the side navigation bar and then click *Network* in the side navigation bar. The Unit Network Properties window will open.
 - Type the address or the fully qualified domain name.
If you are changing the appliance IP address, you should first change it in the Appliance Network Settings window before changing it in the Unit Network Properties window. See *Managed Appliance Settings* on page 147.
 - Select the DSView 3 server in charge of the managed appliance.
3. Click *Save* and then click *Close*. The Units View window will open.

To change the DSView 3 server network property for one or more units from a Units View window:

1. In a Units View window (see *Accessing Units View windows* on page 106), click the checkbox next to the unit(s). To change the DSView 3 server property for all units in the page, click the checkbox to the left of Name at the top of the list. (If the page contains units that do not support note properties, they will not be affected.)
2. Click *Operations*, then select *Properties* from the drop-down menu.
3. The Multiple Unit Properties window will open. Click *Network*. Select the DSView 3 server in charge of the units.
4. Click *Save* and then click *Close*. The Units View window will open.

To change the network properties for an EVR1500 environmental monitor or generic appliance:

1. In a Units View window containing appliances (see *Accessing Units View windows* on page 106), click on the appliance name.
2. Click *Properties* in the side navigation bar and then click *Network* in the side navigation bar. The Unit Network Properties window will open.
 - Type the address or the fully qualified domain name.
 - Type a Telnet port number.
 - Type a web browser address.
 - Select the DSView 3 server in charge of the EVR1500 environmental monitor or generic appliance.
3. Click *Save* and then click *Close*. The Units View window will open.

About Access Rights

Access rights indicate which users and user groups may access units in the DSView 3 software system. Access rights also indicate which actions are allowed.

For target devices, you may specify whether a user or members of a user group are allowed to:

- View the unit in a Units View window (this right is enabled automatically if any other access right for the target device is enabled)
- Establish viewer sessions (Video Viewer or serial, as supported on the device)
- Control target device power
- Establish virtual media sessions to target devices (since virtual media sessions are launched from a Video Viewer session, if you select this option, you should also select *Establish Viewer Sessions*)
- Establish reserved virtual media sessions to target devices (since virtual media sessions are launched from a Video Viewer session, if you select this option, you should also select *Establish Viewer Sessions*)

- Configure unit settings - see *Target Device Settings* on page 150
- View data logging - this access right can be set only for target devices connected to appliances that support data logging; see Chapter 13 beginning on page 185

For certain managed appliances, you may specify whether a user or members of a user group are allowed to:

- View the appliance in Units View windows (this right is enabled automatically if any other access right for the managed appliance is enabled)
- Reboot appliance and disconnect sessions - see *Rebooting* on page 313 and *Active Sessions* on page 176
- Flash upgrade appliance - see *Upgrading firmware* on page 314
- Configure unit settings - see *Managed Appliance Settings* on page 147
- Configure appliance local user accounts - see *Local Account Settings* on page 157 (this option will not appear for managed appliances that do not support local user accounts)
- View data logging - this access right can be set only for appliances that support data logging; see Chapter 13 beginning on page 185

For example, you may allow users to configure settings on a managed appliance, but not allow them to reboot and disconnect sessions on it. Instead, you may allow a user who has appliance administrator privileges on the target devices to establish a Video Viewer session, but not allow that user to perform power control operations. Access rights may also be specified for all units in the DSView 3 software system or for a specific unit.

By default, supported embedded units have the same access rights as generic units.

About target device access rights

When you assign access rights to a target device, any available session types may be selected, even if the target device does not support them. For example, you may enable Video Viewer and virtual media sessions to a target device that is attached to a serial console appliance, which does not support virtual media. The target device access rights are not based on the valid type of connection to that target device - the ability to establish a particular session type exists only when the target device (through its managed appliance) supports it. Using the above example, if the target device that was attached to the serial console appliance was later moved to a managed appliance that supported virtual media sessions, the target device could then be accessed by that method.

Each access right is independent of other access rights. For example, you may enable virtual media session access to a target device that supports it, but not enable KVM (Video Viewer) session access to that target device. Since a virtual media session is launched from a KVM session, that user would, in fact, not be able to open a virtual media session with that target device. The access right only indicates that the user is allowed to perform the operation; it does not mean that the operation can actually be performed.

How access rights can be assigned

There are several ways you may assign access rights.

- You may assign access control rights from a unit perspective. From this perspective, you select one or more units, specify the users/user groups for which rights will be assigned, then allow/deny the permission to perform the action for each user/user group. See *Unit Access Rights* on page 146.
- You may also assign access control rights from a unit group perspective. This is similar to assigning access control rights for a unit, except all units that belong to the selected unit group will be affected. See *Changing the unit group properties* on page 215.
- You may also assign access control rights from a user perspective. You select a user account, specify the units for which rights will be assigned, then indicate the permission to perform the action (none, allow, deny or inherit) for each unit. See *User Access Rights* on page 239.
- You may assign access control rights from a user group perspective. This is similar to assigning access control rights for a user, except all users who are members of the selected user group will be affected. See *User Group Access Rights* on page 246.

Unit Access Rights

DSView 3 software administrators may assign unit access rights.

To add or remove access rights from a Units View window:

1. In a Units View window (see *Accessing Units View windows* on page 106):
 - To add/remove access to one or more units, click the checkboxes next to the units, and then click *Rights*.
 - To add/remove access to all units on the page, click the checkbox to the left of Name at the top of the list, and then click *Rights*.
2. The Unit Access Rights window will open. To add or remove a user or user group from the Access Rights Assignment list, click *Edit List*. The Unit Access Rights User Selection window will open.
 - To add one or more users or user groups, select the users or user groups from the Available list, then click *Add*. The users and/or user groups will be moved to the List to Update list.
 - To remove one or more users or user groups, select the users or user groups from the List to Update list, then click *Remove*. The users and user groups will be moved to the Available list.

Click *OK*. The Unit Access Rights window will contain the current list of users/user groups. When a user/user group is added to the list, default access rights will be displayed.

3. To set access rights, select a user or user group from the User and User Groups list, then enable or disable a checkbox in the Access Rights table for each access right.
 - Allow - the access right is allowed for the user/group.
 - Deny - the access right is denied for the user/group.
 - Inherit - the access right is inherited from the unit group(s) to which the selected user/group belongs. When Inherit is selected, the Allow and Deny checkboxes will become

gray and unchangeable, and indicate the inherited value. If the inherited settings indicated both Allow and Deny, the inherited value is Deny, which takes precedence.

To disable the inherit functionality, uncheck the Inherit checkbox.

- If none of the checkboxes are checked, the access right is neither allowed nor denied.
4. Repeat the preceding step to change access rights for other users/user groups.
 5. Click *Save* and then click *Close*. The Units View window will open.

Managed Appliance Status

All DSR switches that have been automatically discovered are initially listed as Unmanaged Units.

To move a DSR switch to the managed units list:

1. In a Units View window, select *Unmanaged Appliances*.
2. Select one or more DSR switches.
3. Click *Operations*, then select *Move to Managed Devices*. The DSR switches are now available from Units View windows containing appliances.

If an automatically discovered DSR switch that has been set as a managed appliance is deleted, the DSView 3 software attempts to automatically discover the DSR switch again and add it to the Unmanaged Appliances list. The automatic discovery process continues unless the DSR switch is turned off or has the DSView 3 server address removed.

Managed Appliance Settings

To change the network settings of a managed appliance:

NOTE: The MAC address cannot be changed.

1. In a Units View window containing appliances (see *Accessing Units View windows* on page 106), click on the appliance name.
2. Click *Appliance Settings* in the side navigation bar and then click *Network*. The Appliance Network Settings window will open. To change information:
 - Type an IP address, in standard dot notation (xxx.xxx.xxx.xxx).
If you change the appliance IP address in the Appliance Network Settings window, you must then also change the address in the Unit Network Properties window. See *Unit Properties* on page 139. (When changing an IP address, always change it in the Appliance Network Settings window before changing it in the Unit Network Properties window.)
 - Type a subnet, in standard dot notation (xxx.xxx.xxx.xxx).
 - Type a gateway, in standard dot notation (xxx.xxx.xxx.xxx).
 - Specify a LAN speed. This network setting will not appear for CPS appliances.
 - Enable or disable DHCP or BootP (KVM switches).
 - Enable or disable ICMP ping reply.

3. Click *Save* and then click *Close*. The Units View window will open.

To change the IP addresses of DSView 3 servers used for managed appliance authentication:

1. In a Units View window containing appliances (see *Accessing Units View windows* on page 106), click on the appliance name.
2. Click *Appliance Settings* in the side navigation bar and then click *Authentication Servers*. The Appliance Authentication Servers Settings window will open. To change information, type an IP address, in standard dot notation (xxx.xxx.xxx.xxx), for up to four DSView 3 servers the managed appliance will use for authentication.
3. Click *Save* and then click *Close*. The Units View window will open.

To display version information for one or more managed appliances from a Units View window:

1. In a Units View window containing appliances (see *Accessing Units View windows* on page 106), click the checkbox next to the unit(s). To display information about all units in the page, click the checkbox to the left of Name at the top of the list.
2. Click *Operations*, then select *Show Versions* from the drop-down menu.
3. A Multiple Unit Operation window will open, containing a link to view results; see *Multiple unit operations from a Units View window* on page 111.

The results window includes the unit name, type and when the version information retrieval began.

The Appliance Version field will contain the main firmware version; if a unit did not or cannot report a firmware version, dashes are displayed.

The Boot Version field contains the boot firmware version. If a unit does not support a boot version but has an appliance version, N/A will be displayed. Dashes will be displayed if a unit does not support either appliance or boot firmware.

The Status field indicates the result of the display (for example, Show Versions complete or Show Versions not supported).

To display version information for a managed appliance:

1. In a Units View window containing appliances (see *Accessing Units View windows* on page 106), click on an appliance name.
2. Click *Appliance Settings* in the side navigation bar and then *Versions*. The Appliance Version Information window will open, containing the following information:
 - For KVM switches - application, boot and video FPGA
May also include application, boot, video FPGA, matrix FPGA, UART FPGA, digital/application, digital/digitizer, digital/FPGA and OSCAR FPGA
 - For serial console appliances - bootstrap and application versions
3. Click *Close*. The Units View window will open.

To enable or disable secure mode on an appliance:

1. In a Units View window containing appliances (see *Accessing Units View windows* on page 106), click the checkbox next to the unit(s).
2. Click *Operations*, then select *Enable Secure Mode* from the drop-down menu.

Managed Appliance SNMP Settings

This procedure is valid for supported KVM switches and serial console appliances. It may also be valid for appliances supported by a plug-in; see the appropriate documentation.

The SNMP protocol is used to communicate management information between network management applications and DSView 3 software managed appliances using TCP/IP and IPX protocols. Other external SNMP managers (such as Tivoli® and HP OpenView) may communicate with your managed appliances by accessing MIB-II (Management Information Base) and the public portion of the enterprise MIB. MIB-II is a standard MIB that many SNMP target devices support. The managed appliances will send their traps directly to the external SNMP manager in addition to sending it to the server.

The following settings appear under SNMP in the side navigation bar:

- System - Enables/disables SNMP. When you enable SNMP, the managed appliance will log SNMP received messages over UDP (User Datagram Protocol) port 161. UDP port 162 is used to listen for incoming traps.
- Managers - Stations that can manage the managed appliance.
- Community - Communities to which the traps belong.
- Destinations - Stations that can receive SNMP traps.
- Traps - Available traps and enabled/disabled traps.

The traps must be also configured on each managed appliance using the Command Line Interface (CLI). The address of the server running the DSView 3 software must be configured as a trap recipient, the proper community must be set and each desired trap must be enabled.

SNMP traps are logged in the event log file. See *Displaying the Event Log* on page 343. SNMP traps may also be configured from a system task. See *Task: Configure SNMP trap settings on a managed appliance* on page 324.

To change SNMP settings for a managed appliance:

1. In a Units View window containing appliances (see *Accessing Units View windows* on page 106), click on the appliance name.
2. Click *Appliance Settings* in the side navigation bar and then click *SNMP* in the side navigation bar. The Appliance SNMP System Settings window will open.
3. To enable SNMP, select *Enabled* in the Enable SNMP menu. If desired, change the name and description of the managed appliance and type a contact. Then, click *Save*.

4. To enable SNMP manager settings, click *Managers* in the side navigation bar. The Appliance SNMP Manager Settings window will open. Type the IP addresses, in standard dot notation (xxx.xxx.xxx.xxx), for up to four SNMP managers. Then, click *Save*.
5. To specify SNMP community settings, click *Community* in the side navigation bar. The Appliance SNMP Community Settings window will open. Type the SNMP community names for reading, writing and SNMP traps. Then, click *Save*.
6. To specify SNMP destination settings, click *Destinations* in the side navigation bar. The Appliance SNMP Destination Settings window will open. Type the IP addresses, in standard dot notation (xxx.xxx.xxx.xxx), for up to four SNMP destinations. Then, click *Save*.
7. To enable or disable SNMP traps, click *Traps* in the side navigation bar. The Appliance SNMP Trap Settings window will open. Select one of the following:
 - *Enabled* turns a trap on; *Disabled* turns a trap off.
 - *Enable All* turns all traps on; *Disable All* turns all traps off.
8. Click *Save* and then click *Close*. The Units View window will open.

Target Device Settings

For information about power device settings, see *Power Devices* on page 165.

To display a list of target devices that are attached to a managed appliance or initiate a push/pull name operation:

1. In a Units View window containing appliances (see *Accessing Units View windows* on page 106), click on the name of an appliance.
2. Click *Appliance Settings* in the side navigation bar, then click *Target Devices*.
3. The Target Devices window will open.
4. To initiate a pull or push name operation (see *Name Synchronization* on page 125), click the checkboxes to the left of one or more device names. To select all names on the page, click the box to the left of Appliance Name at the top of the list.
 - For a pull operation, click *Pull Name*.
 - For a push operation, click *Push Name*.

Customizing the Target Devices window

The following fields may be displayed in the Target Devices window. Use the Customize link to add or remove fields in the display. See *Using the Customize link in windows* on page 28.

- Name in Appliance - Name of the target device in the appliance.
- Name in DSView - Name of the target device in the DSView 3 software database.
- Connection - Connection path to the target device in the appliance.

To change the appliance name for a target device:

1. In a Units View window containing appliances, click on the name of an appliance.

2. Click *Appliance Settings* in the side navigation bar, then click *Target Devices*.
3. The Target Devices window will open. Click on a target device name.
4. Change the appliance name for the target device. If the automatic name pull feature is enabled, see *Automatic name pull* on page 127 for the effect.

Target Device Services

You may add or remove support on a target device for third party services such as Terminal Services and VNC. Before adding support for a service, the service must be properly installed and configured on the target device.

Once support for a service has been added, you can launch a session for that service using several methods:

- Clicking the name or icon for the service in the target device's Unit Overview window.
- Selecting the session link for that service in the Action field's Alternate Action menu in Units View windows that list that target device.
- Clicking the Action field in the Unit Services window for that service.

Service options may include actions to be performed if a problem is detected with the service. This may include automatically launching a KVM session, prompting the user or no action.

To add support for services on a target device:

1. In a Units View window containing target devices (see *Accessing Units View windows* on page 106), click on a target device name.
2. In the side navigation bar, click *Services*. The Unit Services window will open, listing the services that are supported.
3. Click *Add*. The Add Service Wizard will appear.
4. If the target device does not have an address in the DSView 3 software database, you will be prompted to enter it. After you enter the name, click *Next*.
5. The Select the Procedure window will open. You may add support for the service either by discovery of services running on the target device or by selecting from all available services. Enable the radio button for adding with discovery or without discovery, then click *Next*.
If you chose to add a service by discovery, a Request in Progress display will appear before the next window opens.
6. The Select Service window will open. Select the services from the Available Services (or Services Found) list, then click *Add*. The selected services will be moved to the Services to Assign list.
To remove services from the Services to Assign list, select the services, then click *Remove*. The selected services will be moved to the Available Services (or Services Found) list.
Click *Next*.
7. The Completed Successful window will open. Click *Close*.

To change service options:

1. In a Units View window containing target devices (see *Accessing Units View windows* on page 106), click on a target device name.
2. In the side navigation bar, click *Properties*, then click *Services*. The Unit Services window will open.
3. Click on a service name.
4. Enable the radio buttons to enable options, then click *Save*.

To remove support for a service on a target device:

1. In a Units View window containing target devices (see *Accessing Units View windows* on page 106), click on a target device name.
2. In the side navigation bar, click *Properties*, then click *Services*. The Unit Services window will open, listing the services that are supported.
3. Click the checkbox next to the services to be removed. To remove all services on the page, click the checkbox to the left of Service at the top of the list.
4. Click *Delete*. A confirmation dialog box will appear.
5. Confirm or cancel the deletion.

Target Device Naming

You can specify a fixed target device name for each port on an appliance. Up to 48 port names can be specified for a single appliance. The fixed name and location name are combined to create the target device name. See *Unit Properties* on page 139 for more information about location names.

Target device naming is a global system property and affects all DSView 3 servers in the system. Target device naming is not supported for all appliances; if it is not supported, the related buttons and links are not displayed.

To enable and specify fixed target device names:

1. Click the *System* tab.
2. Click *Global Properties* in the top navigation bar.
3. Click *Units - Target Device Naming* in the side navigation bar.
4. Select the checkbox under Target Device Naming to enable target device naming.
5. Select *Target device name begins with the fixed name followed by the target device location* if you want the fixed name to be applied as prefix to the location name.

-or-

Select *Target device name begins with the target device location followed by the fixed name* if you want the fixed name to be applied as a suffix to the location name.

6. A list displays 48 ports and a Fixed Name field next to each port. Enter a unique target device name for each port.

7. Click *Save*.

To adjust target device names:

1. In a Units View window containing appliances, select the appliance(s) for which you want to adjust target device names.
2. Select *Adjust Target Device Names* from the Operations menu.
3. Select a location name from the menu for each appliance.
-or-
Enter a new location name in the field for each appliance.

NOTE: Each appliance must have a unique location name.

4. Click *Submit*.

The fixed name and location name are combined to create new target devices names. It is recommended that automatic name push is enabled so that appliances are automatically updated with the new target device names; see *Automatic name push* on page 126. You can also use the manual name push feature to manually update target device names; see *Manual name push* on page 128.

The location is updated in the Unit Properties for the appliance and attached target devices. However, the Unit Properties are not updated for target devices that are attached to a cascade KVM switch or cascade power device.

IQ Module Settings

IQ modules are connected to supported KVM switches.

To display IQ module information:

1. In a Units View window containing appliances (see *Accessing Units View windows* on page 106), click on the KVM switch name.
2. Click *Appliance Settings*, click *Ports* and then click *IQ Modules* in the side navigation bar. The Appliance IQ Modules window will open. This window lists all modules with their EID, status, port number, application version, hardware version, interface type and USB speed.
3. To display an individual module's settings, click on an IQ module. The Appliance IQ Module Settings window will open.

To delete offline IQ modules:

NOTE: Any offline module will have a red circle and an "X" to the left of its EID. An online module will have a green circle to the left of its EID.

1. In a Units View window containing appliances (see *Accessing Units View windows* on page 106), click on the KVM switch name.

2. Click *Appliance Settings*, click *Ports* and then click *IQ Modules* in the side navigation bar. The Appliance IQ Modules window will open.
3. Click *Delete Offline*. A confirmation dialog box will appear.
4. Confirm or cancel the deletion.

To upgrade IQ modules:

NOTE: Offline IQ modules may not be selected for upgrading.

1. In a Units View window containing appliances, click on the KVM switch name.
2. Click *Appliance Settings*, click *Ports* and then click *IQ Modules* in the side navigation bar. The Appliance IQ Modules window will open.
3. Click the checkbox to the left of the IQ modules you wish to upgrade. To select all IQ modules on the page, click the checkbox to the left of EID at the top of the list.
4. Click *Upgrade*. A confirmation dialog box will appear.
5. Confirm or cancel the upgrade.

If the upgrade is confirmed, a yellow LED icon will appear to the left of the upgrading modules. You may click on the name of an IQ module in the EID column to display its upgrade status in the Appliance Settings - Ports - IQ Modules - Settings window. When the upgrade is completed, a green circle will appear next to the modules and they may once again be selected.

To set the USB speed for IQ modules:

NOTE: The USB speed may only be set for supported USB2 and PS2M IQ modules.

1. In a Units View window containing appliances, click on the KVM switch name.
2. Click *Appliance Settings*, click *Ports* and then click *IQ Modules* in the side navigation bar. The Appliance IQ Modules window will open.
3. Click the checkbox to the left of the IQ modules you wish to modify. To select all IQ modules on the page, click the checkbox to the left of EID at the top of the list.

NOTE: If any IQ module in the list is not supported, the set USB speed buttons will be disabled.

4. Click *Set USB 1.1 Speed* or *Set USB 2.0 Speed*. The USB speed for the selected IQ modules will be set.

KVM Switch and Cascade Switch Settings

- For information about the SPC ports and managing power devices, see *Power Devices* on page 165.
- To merge or split multi-user cascade switches from the same appliance, see *Merging or splitting cascade switches* on page 134.

To display cascade switch port settings and initiate a push/pull name operation:

1. In a Units View window containing appliances (see *Accessing Units View windows* on page 106), click on the KVM switch name.
2. Click *Appliance Settings* in the side navigation bar. Click *Ports* and then click *Cascade Switches*. The Appliance Cascade Switches window will open.
3. To initiate a pull or push name operation (see *Name Synchronization* on page 125), click the checkboxes to the left of one or more device name(s). To select all names on the page, click the box to the left of Appliance Name at the top of the list.
 - For a pull operation, click *Pull Name*.
 - For a push operation, click *Push Name*.

To change the name in appliance for a cascade switch:

1. In a Units View window containing appliances (see *Accessing Units View windows* on page 106), click on the KVM switch name.
2. Click *Appliance Settings* in the side navigation bar. Click *Ports* and then click *Cascade Switches*. The Appliance Cascade Switches window will open.
3. Click on a cascade switch name. The Cascade Switch Settings window will open.
4. Change the name in the appliance. If the automatic name pull feature is enabled, see *Automatic name pull* on page 127 for the effect.
5. If you changed the appliance name, click *Save*.
6. Click *Close* when you are finished.

To change the Name in DSView for a cascade switch:

1. In a Units View window containing appliances and using the topology feature (see *Accessing Units View windows* on page 106 and *Topology view* on page 104), click on the name of a cascade switch. The Unit Overview window will open.
2. In the Name field, change the name that will be used in the DSView 3 software.
3. If the cascade switch is uniquely identified (for example, a power device or an AutoView 2000 switch), that type will automatically be entered in the Type field and cannot be changed.

If the appliance cannot uniquely identify the cascade switch type, the Type field will include a list of compatible units from which you may choose. A compatible unit will have at least as many inputs and outputs as the DSView 3 software indicates in its database for the cascade switch.

For example, if the DSView 3 software database indicates the cascade switch has more than one connection to the same appliance, only switches with two or more inputs will be included in the list. The target side ports are also checked; if a cascade switch has a target device on port 14, only types that support 14 or more ports will be displayed.

4. Click *Save* and then click *Close*.

You may also change the name of a cascade switch in the DSView 3 software database by using the Merge Cascade Switch wizard; see *Merging or splitting cascade switches* on page 134.

You may also change cascade device properties (identity, location, contacts, custom fields and notes) by clicking the property in the side navigation bar. These windows operate identically to those described in *Unit Properties* on page 139.

OSCAR interface settings

DSR switches can be configured either from the local OSCAR interface or from the DSView 3 software. For increased security, DSView 3 administrators can disable switch configuration through the OSCAR interface and only allow specified DSView 3 user groups to configure DSR switches. From the DSView 3 Units View windows, you can see if OSCAR interface configuration is enabled or disabled on a DSR switch; see the DSR switch plug-in help for more information.

To change local OSCAR interface settings:

NOTE: This procedure is valid for the following managed appliances: all DSR switches except the DSR 800, 1161, 2161 and 4160 switches.

1. In a Units View window containing appliances (see *Accessing Units View windows* on page 106), click on the DSR switch name.
2. Click *Appliance Settings* in the side navigation bar, then click *Ports* and then click *OSCAR*. The Appliance OSCAR Settings window will open.
3. Click *Disable OSCAR Authentication* to prevent the supported DSR switch from performing internal or external authentication. If the Disable OSCAR Authentication checkbox is not selected, the supported DSR switch will attempt external authentication using the list of authentication servers that reside in the switch. If the authentication fails, the supported DSR switch will use its internal user tables.
4. Specify a preemption level for the DSR switch (1-4).
5. The Long Name Display Mode is used when cascade switch or target device names contain more than 15 characters. Select the radio button to specify whether the OSCAR interface will display the first 15 characters or the last 15 characters.
6. If you want to prevent local users from configuring the DSR switch through the OSCAR interface, select *Disable Configuration* under Local OSCAR Configuration.
7. Click *Save* and then click *Close*. The Units View window will open.

To change modem port settings:

NOTE: This procedure is valid for the following managed appliances: DSR1020, 1021, 1022, 1024, 1030, 2020, 2030, 2035, 4020, 4030, 8020, 8030 and 8035 switches.

1. In a Units View window containing appliances (see *Accessing Units View windows* on page 106), click on the DSR switch name.

2. Click *Appliance Settings* in the side navigation bar and then click *Ports* and then click *Modems*. The Appliance Modem Settings window will open.
3. Select *Modem sessions can preempt digital sessions* to enable a modem session to disconnect an existing Ethernet connection to the DSR switch.
4. Type an authentication time-out for the modem in the range of 30-300 seconds.
5. Type an inactivity time-out for the modem connection in the range of 1-60 minutes.
6. Click *Save* and then click *Close*. The Units View window will open.

Local Account Settings

This procedure is valid on KVM switches and serial console appliances that support local accounts.

Local accounts allow a user to log in to a managed appliance locally if it has a server configured as an authentication server. You may assign the user administrator, appliance administrator or user level to a local user. See *Built-in User Groups* on page 40.

You must have Configure Local Accounts rights to add, modify or delete local user accounts. See *About Access Rights* on page 144.

To display the Appliance Local User Accounts window:

1. In a Units View window containing appliances (see *Accessing Units View windows* on page 106), click on the appliance name.
2. Click *Appliance Settings* in the side navigation bar and then click *Local Accounts*. The Appliance Local User Accounts window will open.

To change access control method for local user accounts:

1. In a Units View window containing appliances (see *Accessing Units View windows* on page 106), click on the appliance name.
2. Click *Appliance Settings* in the side navigation bar, click *Local Accounts* and then *Settings*. The Appliance Local User Access Method window will open.
3. Enable the *Port* or *Port group* radio button.
4. Click *Save*.

Customizing the Appliance Local User Accounts window

The preemption level and access level fields may be displayed in the Appliance Local User Accounts window. Use the Customize link to add or remove fields in the display. See *Using the Customize link in windows* on page 28.

To add a local user account:

1. In a Units View window containing appliances (see *Accessing Units View windows* on page 106), click on the appliance name.

2. Click *Appliance Settings* in the side navigation bar, click *Local Accounts* and then *Users*. The Appliance Local User Accounts window will open.
3. Click *Add*. The Add Local User Account Wizard will appear.
4. The Type in Local User Credentials window will open.
 - a. Type the name of the local user account.
 - b. Type a password for the local user account.
 - c. Confirm the password for the local user account.
 - d. Click *Next*.
5. The Select Preemption Level window will open. Select a preemption level (1-4) for the local user. This will be used for KVM, serial and virtual media sessions. (See *Preemption Levels* on page 41.) Click *Next*.
6. The Select Access Level window will open. Select an access level from the menu: Appliance Administrator, User or User Administrator. (DSR1010, DSR2010 and DSR4010 switches support local accounts, but the Appliance Administrator access level cannot be changed, so this menu will not appear for these switches.)
7. Click *Next*.

If you selected *User*, go to step 8.

If you selected *Appliance Administrator* or *User Administrator*, go to step 9.
8. The Assign target devices window will open. Add or remove user access rights to a target device:
 - a. To add user access rights to one or more target devices, select the target device(s) in the Available Target Devices list, then click *Add*. The target devices will be moved to the Assigned Target Devices list.
 - b. To delete user access rights to one or more target devices, select the target device(s) in the Assigned Target Devices list, then click *Remove*. The target devices will be moved to the Available Target Devices list.
9. Click *Next*. The Completed Successful window will open.
10. Click *Finish*. The Appliance Local User Accounts window will open.

To delete a local user account:

1. In a Units View window containing appliances (see *Accessing Units View windows* on page 106), click on the appliance name.
2. Click *Appliance Settings* in the side navigation bar and then click *Local Accounts*. The Appliance Local User Accounts window will open.
3. Click the checkbox to the left of the local usernames to be deleted. To delete all local user accounts, click the checkbox to the left of Name at the top of the list.
4. Click *Delete*. A confirmation dialog box will appear.
5. Confirm or cancel the deletion.

To change the settings of a local user account:

1. In a Units View window containing appliances (see *Accessing Units View windows* on page 106), click on the appliance name.
2. Click *Appliance Settings* in the side navigation bar and then click *Local Accounts*. The Appliance Local User Accounts window will open.
3. Click on the name of a local user account. The Appliance Local User Account Settings window will open.
4. Type a new name for the local user.
5. Select a preemption level (1-4) for the local user. See *Preemption Levels* on page 41.
6. If available, select an access level: User Administrator, Appliance Administrator or User.
7. Type a new password for the local account and then confirm the password.
8. Click *Save* and then click *Close*. The Appliances window will open.

To change target device access rights to a local account:

1. In a Units View window containing appliances (see *Accessing Units View windows* on page 106), click on the appliance name.
2. Click *Appliance Settings* in the side navigation bar and then click *Local Accounts*. The Appliance Local User Accounts window will open.
3. Click on the name of a local account. The Appliance Local User Account Settings window will open. (If the local user has Configure Local Accounts rights, a message will indicate that the local user may access all target devices in the system.)
4. For all managed appliances except CCM appliances: click *Access Rights* in the side navigation bar. The Appliance Local User Account Access Rights window will open.
 - To add local user account access to one or more target devices, select the target device(s) in the Available Target Devices list. Click *Add*. The target devices will be moved to the Assigned Target Devices list.
 - To remove local user account access to one or more target devices, select the target device(s) in the Assigned Target Devices list. Click *Remove*. The target devices will be moved to the Available Target Devices list.
5. For CCM appliances:
 - To change local user account access by port, click *Access Rights* in the side navigation bar and then *Port*. Select the ports in the Available list and then click *Add*. The selected ports will be moved to the Assigned list.
 - To change local user account access by group, click *Access Rights* in the side navigation bar and then *Group*. Select the groups in the Available list and then click *Add*. The selected groups will be moved to the Assigned list.
6. Click *Save* and then click *Close*. The Appliance Local User Accounts window will open.

Embedded Units

The IBM ASM RSA II and the DRAC 4 embedded units have one target port and one appliance for each embedded appliance.

The NEC IPF embedded unit has nine target ports and one appliance for each embedded appliance. Port names default to “Blade” plus the port number.

The HP iLO embedded unit has one target device.

In the DSVIEW 3 software, each of these appliance types will contain specific information about the target as well as the embedded appliance itself. All KVM connections are initiated through the target port/device.

After an embedded appliance type is added to the DSVIEW 3 software, an appliance type is added under the Appliances link in the side navigation bar.

Updating firmware, changing device settings and rebooting embedded units must be done manually. See the embedded unit documentation for further information.

Launching embedded unit sessions

From the Target Devices window, users may launch a KVM or browser session to the embedded devices. Each session is handled by the embedded unit and is launched in a separate window browser. HP iLO, NEC IPF, IBM ASM RSA II and DRAC 4 viewers are proprietary to their owners, and the DSVIEW 3 software has little control of their look, feel and configuration.

There is no status polling for these sessions (status is idle by default); nor are there connection types. All embedded KVM browsers have their own certificate authentication. Users must accept certificate authentication to launch embedded unit video sessions.

Users must manually close the window to close a session. In all cases, exiting or logging out of the DSVIEW 3 software will not shut the KVM/browser session.

- The DRAC 4 KVM session launches a standalone launch browser which in turn launches a KVM applet. To leave the session, the user must exit the KVM session applet and the standalone launch browser.
- The IBM ASM RSA II KVM session launches a KVM session applet within a browser. To leave the session, users must exit the KVM browser session.
- The NEC IPF KVM session launches a standalone KVM session applet. To leave the session, users must exit the standalone KVM session.
- The HP iLO session will launch a browser session to the login page of the embedded device server. Users must log in to the web server to access the target device’s KVM session. To leave the session, users must exit the KVM browser session.

See the embedded units’ documentation for further information.

Changing embedded unit credentials

You may change the login credentials for the IBM ASM RSA II, DRAC 4 and NEC IPF embedded units.

To change login credentials for an IBM ASM RSA II embedded appliance:

1. Click the *Units* tab.
2. Click *Appliances* in the side navigation bar, and then click on the appliance type in the side navigation bar.
3. Click on the embedded appliance name.
4. Click the *Credentials* link in the side navigation bar and then click *Credentials* in the side navigation bar.
5. The IBM ASM RSA II Settings window will open. To change information:
 - In the Appliance Name field, type a 1-64 character appliance name. The name is not case sensitive.
 - In the Username field, type a 1-64 character username to be used to log in to the embedded appliance. Usernames are case sensitive.
 - In the Password field, type a 1-64 character password to be used to log in to the embedded appliance. Passwords are case sensitive.
6. Click *Save* and then click *Close*.

To change login credentials for a DRAC 4 embedded appliance:

1. Click the *Units* tab.
2. Click *Appliances* in the side navigation bar and then click on the appliance type in the side navigation bar.
3. Click the embedded appliance name.
4. Click the *Credentials* link in the side navigation bar and then click *Credentials* in the side navigation bar.
5. The DELL DRAC4 Settings window will open. To change information:
 - In the Appliance Name field, type a 1-64 character appliance name. The name is not case sensitive.
 - In the Port field, type a TCP port number in the range 0-65535 where the appliance will listen.
 - In the Username field, type a 1-64 character username to be used to log in to the embedded appliance. Usernames are case sensitive.
 - In the Password field, type a 1-64 character password to be used to log in to the embedded appliance. Passwords are case sensitive.
6. Click *Save* and then click *Close*.

To change login credentials for an NEC IPF embedded appliance:

1. Click the *Units* tab.
2. Click *Appliances* in the side navigation bar.
3. Click the embedded appliance name.
4. Click the *Credentials* link in the side navigation bar and then click *Credentials* in the side navigation bar.
5. The NEC IPF Settings window will open. To change information:
 - In the Name field, type a 1-64 character appliance name. The name is not case sensitive.
 - In the Username field, type a 1-64 character username to be used to log in to the embedded appliance. Usernames are case sensitive.
 - In the Password field, type a 1-64 character password to be used to log in to the embedded appliance. Passwords are case sensitive.

Click *Save* and then click *Close*.

Asset and Usage Reports

You can view Asset and Usage reports as a pie chart, bar chart or table by clicking the appropriate button. If multiple charts are tiled on the screen, you can change the size of the charts by dragging the triangle on the Size bar to the right or left. To print a report in a printer-friendly format, click the printer icon.

Asset

To view Asset reports:

1. Click the *Reports* tab, then click *Asset* in the top navigation bar.
2. Select one of the following reports in the side navigation bar:
 - *Appliance Models* - Displays the number of units for each appliance model the user has added to the DSView 3 software.
 - *Port Types* - Displays the number of ports for each type of port connected to the DSView 3 software. Port types include KVM (Keyboard Video Mouse), Serial, Power, SPC (an Avocent power control device), SoL (Serial over LAN) and LDSM (LANDesk Server Manager).
 - *Appliance Versions* - Displays the firmware version(s) for each appliance model managed by the DSView 3 software.
 - *Target Devices* - Displays the total number of target devices, sorted by type.
 - *Units* - Displays the total number of units, sorted by type.

Usage

To view Usage reports:

1. Click the *Reports* tab, then click *Usage* in the top navigation bar.
2. Select one of the following reports in the side navigation bar:
 - *Sessions Per Day* - Displays the number of sessions opened to a target device from the DSView 3 software each day during the last seven days.
 - *Frequently Accessed Targets* - Displays the number of sessions opened from the DSView 3 software for each target device during the last seven days.

Power Devices and Power Device Sockets

See *Power devices* on page 7 for information about the power device types and models that are supported on Avocent appliances. See *Licenses* on page 54 for information about third party power device licenses.

Power Devices

To display a list of power devices attached to an appliance or initiate a push/pull name operation:

1. In a Units View window containing appliances (see *Accessing Units View windows* on page 106), click on the appliance name.
2. Click *Appliance Settings* in the side navigation bar and then click *Ports* and then click *Power device*. The Power Devices Attached to Appliance window will open. (For DSR switches that have two SPC ports, one row will appear for each power device.)
3. To initiate a pull or push name operation (see *Name Synchronization* on page 125), click the checkboxes to the left of one or more device name(s). To select all names on the page, click the box to the left of Appliance Name at the top of the list.
 - For a pull operation, click *Pull Name*.
 - For a push operation, click *Push Name*.

Customizing the Power Devices Attached to Appliance window

The display fields and content of the Power Devices Attached to Appliance window will differ according to the power device type and models. For details, see the product documentation. Use the *Customize* link to add or remove fields in the display; see *Using the Customize link in windows* on page 28.

The following fields are always displayed, regardless of the power device type and model.

- Name in Appliance - Name of the power device in the appliance
- Name in DSView - Name of the power device in the DSView 3 software database
- Status

To add or remove a power device:

NOTE: To successfully add or remove a power device, the power device must be in the online state. Additionally, to add a power device other than an Avocent SPC or Cyclades power device, you must have a valid third party license; see *Licenses* on page 54.

1. In a Units View window containing appliances (see *Accessing Units View windows* on page 106), click on the appliance name. The Unit Overview window will open.
2. Click *Manage Power Devices* in the Tools area. The Power Management Wizard will appear. (You may also access the Power Management Wizard by clicking the following sequence in the side navigation bar: *Appliance Settings - Ports - Power Devices - Manage*.)
3. The Select Action window will open.
 - To add a power device, enable the *Add Power Devices* radio button.
 - To remove a power device, enable the *Remove Power Devices* radio button.Click *Next*.
4. The Select Parameters window will open.
 - a. In the Port menu, select the port where the power device will be added or removed.
 - For a DSR switch containing one SPC port, the Port menu will indicate SPC and cannot be changed. For a DSR switch containing more than one SPC port, the Port menu will contain entries for each (for example, SPC 1 and SPC 2).
 - For a serial console appliance, select the physical port number in the Port menu.
 - For an appliance supported by a plug-in, select the appropriate port value.
 - b. If you are adding a power device, select the type in the Power Device Type menu.
 - c. Click *Next*.
5. A Completed Successful or Completed Unsuccessful window will open, indicating the results of the addition or removal. Click *Finish*.

To change power device settings:

1. In a Units View window containing appliances (see *Accessing Units View windows* on page 106), click on the appliance name.
2. Click *Appliance Settings* in the side navigation bar, click *Ports* and then *Power device* in the side navigation bar. The Power Devices Attached to Appliance window will open. (For DSR switches that have two SPC ports, one row will appear for each power device.)
3. Click on the name of a power device. The Power Device Settings window will open. Some fields are read-only. For fields that can be modified, enter or select new values. (If you change the appliance name and the automatic name pull feature is enabled, see *Automatic name pull* on page 127 for the effect.)
4. (Optional) If the power management plug-in is installed, select a voltage and enter a power factor in the fields provided. These values are required if you wish to monitor power data on a power device.

5. Click *Save* and then click *Close*. The Power Devices Attached to Appliances window will open.
6. Click *Close*. The Units View window will open.

Upgrading the firmware of a Cyclades power device

You may upgrade the firmware of a Cyclades power device attached to a DSR switch. There are two ways to do this:

- From a Unit Overview window, using the Upgrade Firmware wizard - see *Upgrading firmware* on page 314.
- Using the Task wizard - see *Task: Updating the firmware of an appliance type* on page 329.
 - In the Select Task to Add window, select *Upgrade firmware of selected units*.
 - In the Select Unit Type window, you may select by product family (Cyclades Power Devices) or unit type (specific power device types)

If multiple power devices are installed in a daisy chain configuration, the most remote power device will be upgraded first.

Power Device Input Feed

The ability to display and change power device input feed information is currently supported on Avocent SPC power control devices, Server Technology power devices and Cyclades PM Intelligent Power Distribution Units (IPDU).

To display power device input feed information:

1. In a Units View window containing appliances (see *Accessing Units View windows* on page 106), click on the appliance name.
2. Click *Appliance Settings* in the side navigation bar, click *Ports* and then *Power device* in the side navigation bar. The Power Devices Attached to Appliance window will open. (For DSR switches that have two SPC ports, one row will appear for each power device.)
3. Click on the name of a power device.
4. Click *Input Feeds* in the side navigation bar. The Power Device Input Feeds window will open.

Customizing the Power Device Input Feeds window

The following fields may be displayed in the Power Device Input Feeds window. For detailed field descriptions, see the product documentation. Use the *Customize* link to add or remove fields in the display. See *Using the Customize link in windows* on page 28.

- Input Feed Name
- Status - Unknown, on, off, cycling, pending off, pending on, pending cycle or no status
- Load
- Alarm Threshold - a trap will be sent if the Load value reaches the Alarm Threshold value
- Load Max - a trap will be sent if the Load value is greater than the Load Max value

- Load Min - a trap will be sent if the Load value is less than the Load Min value

To change power device input feed information:

1. In a Units View window containing appliances (see *Accessing Units View windows* on page 106), click on the appliance name.
2. Click *Appliance Settings*, click *Ports* and then *Power devices* in the side navigation bar. The Power Devices Attached to Appliance window will open.
3. Click on the name of a power device.
4. Click *Input Feeds* in the side navigation bar. The Power Device Input Feeds window will open.
5. Click on an input feed name. The Power Device Input Feed Settings window will open. Some fields are read-only. For fields that can be modified, enter or select new values.
6. Click *Save* and then click *Close*. The Power Device Sockets window will open.
7. Click *Close*. The Power Devices Attached to Appliance window will open.
8. Click *Close*. The Units View window will open.

Power Device Sockets

To display information about power device sockets or initiate a push/pull operation:

1. In a Units View window containing appliances (see *Accessing Units View windows* on page 106), click on the appliance name.
2. Click *Appliance Settings*, click *Ports* and then *Power devices* in the side navigation bar. The Power Devices Attached to Appliance window will open.
3. Click on the name of a power device.
4. Click *Sockets* in the side navigation bar. The Power Device Sockets window will open.

If you change the IP address of a managed appliance that is attached to a power device, the appliance may need rebooting. In this case, a Reboot Required icon will be displayed in the top left corner of the Power Device Sockets window. Click the icon to reboot the managed appliance.
5. To initiate a pull or push name operation (see *Name Synchronization* on page 125):
 - a. Click the checkboxes to the left of one or more device name(s). To select all names on the page, click the box to the left of Appliance Name at the top of the list.
 - b. For a pull operation, click *Pull Name*.
 - c. For a push operation, click *Push Name*.

Customizing the Power Device Sockets window

The display fields and content of the Power Device Sockets window will differ according to the power device type and models. For details, see the product documentation. Use the *Customize* link to add or remove fields in the display. See *Using the Customize link in windows* on page 28.

The following fields are always displayed, regardless of the power device type and model.

- Socket - Socket (outlet) number.
- Appliance Name - Name of the power device socket in the appliance.
- Unit Name - Name of the power device socket in the DSView 3 software database.

To change power device socket settings:

1. In a Units View window containing appliances (see *Accessing Units View windows* on page 106), click on the appliance name.
2. Click *Appliance Settings* in the side navigation bar, click *Ports* and then *Power device* in the side navigation bar. The Power Devices Attached to Appliance window will open.
3. Click on the name of a power device.
4. Click *Sockets* in the side navigation bar. The Power Device Sockets window will open.
5. Click on a power device socket. The Power Device Socket Settings window will open.
Some fields are read-only. For fields that can be modified, enter or select new values. (If you change the appliance name and the automatic name pull feature is enabled, see *Automatic name pull* on page 127 for the effect.)
6. Click *Save* and then click *Close*. The Power Device Sockets window will open.
7. Click *Close*. The Power Devices Attached to Appliance window will open.
8. Click *Close*. The Units View window will open.

Power Control of Devices Attached to Power Devices

There are several ways to power up, power down or power cycle a target device that is attached to a power device socket.

- From a Power Device Sockets window - see the procedure in this section
- From a Units View window containing power devices - see the procedure in this section
- From the Video Viewer - see *Power Control of Devices Attached to Power Devices* on page 279
- From the Telnet Viewer - see *Power Control of Devices Attached to Power Devices* on page 303
- From the DSR Remote Operations software - see *Power control of devices attached to power device sockets* on page 371

To control power from a Power Device Sockets window:

1. In a Units View window containing appliances (see *Accessing Units View windows* on page 106), click on the appliance name.
2. Click *Appliance Settings* in the side navigation bar, click *Ports* and then *Power device* in the side navigation bar. The Power Devices Attached to Appliance window will open.
3. Click on the name of a power device.

4. Click *Sockets*. The Power Device Sockets window will open.
5. Click the checkbox to the left of the power device socket(s). To select all sockets on the page, click the checkbox to the left of Socket at the top of the list.
6. Click *On*, *Off* or *Cycle* to power up, power down or power cycle (off and then on) the selected power device sockets. The Power field for the selected sockets will reflect the state.
7. For certain power device types and models, administrators may also lock or unlock a socket's current state by clicking *Lock* or *Unlock*. This sets the control field of the selected socket(s) to the specified value; users other than administrators cannot change the state. The default value is Unlock.

To control power from a Units View window:

1. In a Units View window containing power devices (see *Accessing Units View windows* on page 106), click the checkbox next to the power device(s). To select all power devices in the page, click the checkbox to the left of Name at the top of the list. (If any of the selected units are not power devices, the operation will be ignored for them.)
2. Click *Operations*, then select *Wall Power On*, *Wall Power Off* or *Wall Power Cycle* from the drop-down menu.
3. A Multiple Unit Operation window will open, containing a link to view results; see *Multiple unit operations from a Units View window* on page 111.

Unit Sessions and Connections

This chapter describes how to view and manage unit sessions and connections.

Managed Appliance Session Settings

From the Appliance Sessions window, you may display session information and change appliance session settings.

Exit macros may be used by and reside on certain switches.

Customizing the Appliance Sessions window

The following fields may be displayed in the Appliance Sessions window for managed appliances. Use the Customize link to add or remove fields in the display. See *Using the Customize link in windows* on page 28.

- Duration - Length of the DSView 3 software session.
- User - Name of user who initiated the DSView 3 software session.
- (KVM switches that support virtual media) Type - Session type: KVM or Virtual Media.
- (KVM switches that support virtual media) Lock Status - When there is a KVM and a virtual media session to the same target device and the appliance setting Virtual Media Locked to KVM Session is enabled, Locked will be displayed in this field.
- (KVM switches) Channel - Channel being used by the managed appliance to connect to the DSView 3 software session.
- (KVM switches) Client - Proxy address if the proxy is enabled.
- (KVM switches) IQ Module - EID of the target device IQ module.
- (KVM switches) Mode - Mode of the session, which may change during the session. Available modes are:
 - Normal - An interactive session that may be shared with other users. When two or more users are sharing the session, the mode will change to Sharing Interactive.
 - Exclusive - A private session that does not allow sharing by other users.

- **Sharing Interactive** - A session that is being shared by two or more users. Interactive users have full control of the video, mouse and keyboard. Passive users may also share the session, but may only display the session and have a mode of Sharing Passive.

A user may display the usernames of other users sharing the session if *View identity of shared connections* is checked in the Video Viewer Session Properties dialog box or if the user is a member of the administrators user group. Users viewing the session in Stealth mode will not be listed. If users disconnect from the session and a single user remains connected, the mode will change to Normal.

- **Sharing Passive** - A session that is being shared by two or more users. Passive users may only display the DSView 3 software session. Interactive users may also share the session, but have full control of the video, mouse and keyboard and have a state of Sharing Interactive.

A user may display the usernames of other users sharing the software session if *View identity of shared connections* is checked in the Video Viewer Session Properties dialog box or if the user is a member of the built-in administrators user group. Users viewing the session in Stealth mode will not be listed. If other users disconnect from the session and a single user remains connected, the mode will change to Normal.

- **Scan** - A temporary non-exclusive DSView 3 software session that displays connected target devices in a thumbnail viewer.
- **(KVM switches) Owner** - Username of the logged in user that owns the session connected to the managed appliance.
- **(KVM switches) Port** - Managed appliance port number connected to the session.
- **Preemption Level** - Effective user preemption level for the user that is connected to the appliance port. See *Preemption Levels* on page 41.
- **(serial console appliances) Client** - IP address of the DSView 3 software client computer connected to the appliance in a non-proxied connection. The IP address of the DSView 3 proxy will display in this column if the client is connected to the appliance using a proxy connection.
- **(serial console appliances) Interface** - Interface to which the session is connected, which is either a serial port or the network CLI.

To display session information:

This procedure is valid for supported KVM switches and serial console appliances. It may also be valid for appliances supported by a plug-in; see the appropriate documentation.

1. In a Units View window containing appliances (see *Accessing Units View windows* on page 106), click on the appliance name.
2. Click *Appliance Settings* in the side navigation bar and then click *Sessions*. The Appliance Sessions window will open.
3. To display information about a specific session, click on the name of the KVM, virtual media or serial session. The Active Session Information window will open, including information about the active session.

4. Click *Close*. The Appliance Sessions window will open.
5. Click *Close*. The Units View window will open.

To display or change the session settings for a serial console appliance:

1. In a Units View window containing appliances (see *Accessing Units View windows* on page 106), click on the serial console appliance name.
2. Click *Appliance Settings* in the side navigation bar and then click *Sessions*. The Appliance Sessions window will open.
3. Click *Settings* in the side navigation bar. The Appliance Settings - Sessions - Settings window will open. The display includes SSH settings for the appliance.
4. Specify how the most recent 64K bytes of online and offline data (history) from a serial port will be controlled:
 - Auto - Displays the history buffer content to a Telnet window.
 - Hold - Saves the buffer contents. To display the contents, you must access the appliance CLI and issue a Port History command.
5. Click *Enable Inactivity Timeout* and use the arrows to specify a value (from 1-90 minutes) that the managed appliance will wait during inactive intervals until the session is closed and the user must log back into the managed appliance.
6. (CCM appliances only) In the Serial Session Share Mode area, enable one of the radio buttons: Disable, Auto or Query.
7. Click *Save* and then click *Close*. The Units View window will open.

To change the KVM session settings for a supported KVM switch:

1. In a Units View window containing appliances (see *Accessing Units View windows* on page 106), click on the KVM switch name.
2. Click *Appliance Settings* in the side navigation bar and then click *Sessions*. The Appliance Sessions window will open.
3. Click *Settings* in the side navigation bar and then click KVM. The Appliance KVM Session Settings window will open.
4. In the Inactivity Timeout area, click *Enable Inactivity Timeout* and use the arrows to specify a time-out value (from 1-90 minutes) that the managed appliance will wait during inactive intervals until the session is closed and the user must log back into the managed appliance.
5. To enable video noise compensation, click the *Enable Video Noise Compensation* checkbox.
6. In the Encryption Level area, specify an encryption level for the keyboard and mouse and also for the video:
 - DES - SSL Single DES encryption
 - 3DES - SSL Triple DES encryption
 - 128-Bit SSL - 128-bit encryption which used an ARCFOUR (RC4®) SSL cipher
 - AES - AES encryption

At least one encryption level must be specified for the keyboard and mouse. When you specify more than one SSL encryption type, the switch negotiates the strongest algorithm that is supported by both sides. The strongest algorithm is AES, followed by 128 bit, 3DES and DES.

7. Click *Save* and then click *Close*. The Units View window will open.

To change the virtual media session settings on a KVM switch:

This procedure is valid for KVM switches that support virtual media.

1. In a Units View window containing appliances (see *Accessing Units View windows* on page 106), click on the KVM switch name.
2. Click *Appliance Settings* in the side navigation bar and then click *Sessions*. The Appliance Sessions window will open.
3. Click *Settings* in the side navigation bar and then click *Virtual Media*. The Appliance Virtual Media Session Settings window will open.
4. In the Session Lock area, enable the *Virtual Media locked to KVM session* checkbox if you wish to close the virtual media session when the associated KVM session is closed. When this feature is disabled an active virtual media session will remain active when the associated KVM session is closed.
5. In the Drive Mappings area, choose an access mode from the Virtual Media Access Mode menu: read-only or read-write.

When the access mode is read-only, the user will not be able to write data to the mapped drive on the client machine. When the access mode is read-write, the user will be able to read and write data to the mapped drive.

If the drive is a read-only drive (for example, CD/DVD drives or ISO images), the access mode setting will be ignored. If the drive on the client machine is read-write (for example, a mass storage device or USB removal media), setting read-only access mode will prevent the user from writing data to the client machine.

6. In the Encryption Level area, enable one or more encryption levels for the virtual media session: DES, 3DES, 128-Bit SSL or AES. Any combination of selections (or no selection) is valid.
7. If the KVM switch supports virtual media, the Virtual Media Access per IQ Module section lists all USB2 or PS2M IQ modules. The list includes details about each IQ module, including a virtual media status of Enabled or Disabled. The list of IQ modules may require multiple pages; you can filter the list by column or click the arrows to move to a page. You can also click *Customize* to specify what is displayed in this section. For information about filtering and customizing, see *Using Windows* on page 26.

Select the checkbox next to each IQ module for which you want to enable/disable virtual media and click *Enable VM* or *Disable VM* respectively. The preset virtual media status is enabled.

NOTE: If the KVM switch does not support virtual media, the Virtual Media Access Per IQ module and associated buttons and links are not displayed.

8. Click *Save* and then click *Close*. The Units View window will open.

Defining exit macros

Since clients are running remotely on PCs, certain commands must be sent to the controlled target device using keyboard macros. For example, pressing **Ctrl+Alt+Delete** on your keyboard resets the PC running the client rather than resetting the target device. To reset the target device, a macro is needed. The DSView 3 management software provides numerous sequences pre-configured for ease of operation.

Three kinds of macros are available: personal, global and exit. Personal macros and global macros are created using the Video Viewer window. See *Macros* on page 274.

Exit macros are supported on DS1800 digital switches and the following DSR switches: DSR1010, 1021, 1022, 1024, 1030, 1031, 2010, 2020, 2030, 2035, 4010, 4020, 4030, 8020, 8030 and 8035 switches.

Exit macros allow software administrators to create a macro that returns a target device to a known state. They reside on the managed appliances and are executed whenever a DSView 3 software session is terminated. For example, if a user is connected to a target device and the user closes the Video Viewer session, an exit macro may be executed that resets the target device to a known state by logging the user out of the target device session.

Exit macros may be created and maintained by any user with Configure Unit Settings access rights. Different groups of exit macros may be created for each managed appliance in your system.

To define exit macros:

1. In a Units View window containing appliances (see *Accessing Units View windows* on page 106), click on the appliance name.
2. Click *Appliance Settings* in the side navigation bar and then click *Sessions*. The Appliance Sessions window will open.
3. Click *Exit Macros* in the side navigation bar. The Appliance Exit Macros window will open.
4. Click the number of a macro. The Appliance Exit Macro Settings window will open.
5. Enter a unique description for the global macro in the Name field.
6. In the Select Keyboard field, select the country configuration of your keyboard. The keyboard graphic in the window will update to reflect your selection.
7. Click on the buttons in the keyboard graphic to create the macro. As a button is clicked, it will appear in the list box to the left of the keyboard graphic.

You may type or use the arrow buttons to specify a delay between buttons you selected from the keyboard graphic. First, click the button in the list box after which you want to insert a delay. Then, click *Delay* to insert the delay in the list box.

8. To specify one or more target devices on which you wish to use the macro, select the device(s) in the Available list, then click *Add*. The target devices will be moved to the Assigned list.
9. To remove one or more target devices on which you wish to use the macro, select the device(s) from the Assigned list, then click *Remove*. The target devices will be moved to the Available list.
10. Click *Save* and then click *Close*. The Units View window will open.

Example: Creating a macro

The following example creates an exit macro where the **Ctrl** key is held while **F1-F2-F3** are typed:

1. Type **ControlF1-F2-F3** in the Name field. This is the name of the macro that will appear in the Appliance Exit Macros window.
2. Click the left or right *Ctrl* key in the keyboard graphic in the window. Ctrl Left - PRESS or Ctrl Right - PRESS will appear in the list box to the left of the keyboard graphic.
3. Click *F1*, *F2* and *F3* in the keyboard graphic in the window. The keystrokes will appear in the list box to the left of the keyboard graphic.
4. Click the same left or right *Ctrl* key in the graphic that you pressed in step 2. Ctrl Left - RELEASE or Ctrl Right - RELEASE will appear in the list box to the left of the keyboard graphic.
5. In the Assigned to Macro area, select the target devices to which you want to assign the macro.
6. Click *Save* and then click *Close*.

Active Sessions

There are two types of active session displays: all active sessions in your system and active session information for each target device.

All active sessions

To display information about all active sessions:

1. Click the *Units* tab.
2. Click *Active Sessions* in the side navigation bar. The Active Sessions window will open.
3. To display information about a session, click on the name in the Start-Date-Time column. The Active Session Information window will open.
4. Click *Close* to close the window and return to the Active Sessions window.

Customizing the Active Sessions window for all sessions

The Start-Date-Time field, which indicates when the target device session was started, is always displayed in the Active Sessions window:

The following fields may be displayed in the Active Sessions window. Use the *Customize* link to add or remove fields in the display. See *Using the Customize link in windows* on page 28.

- Duration - Length of the DSView 3 software session.
- User - User who initiated the session, which may be a user, a local port user or a user with a local user account.
- Target Device - Name of the target device being used for the session.
- Type - Session type, which may be KVM, virtual media or serial.
- Client - IP address of the client computer connected to the session for a non-proxy connection. For a proxy connection, the IP address of the DSView 3 proxy will appear in this field.
- Connection - Connection path from the target device to the managed appliance. See *Connections to Units* on page 181.
- Mode - Session mode, which may change during the session. See *Customizing the Appliance Sessions window* on page 171 for a description of the available modes.
- Owner - Name of the user who launched the session, which may be a user, a local port user or a user with a local user account.
- Preemption Level - Effective user preemption level for the user that is connected to the target device session. See *Preemption Levels* on page 41.

To remove an active session from the (all) Active Sessions window:

NOTE: Removing an active session from the Active Sessions window does not disconnect the session.

1. Click the *Units* tab.
2. Click *Active Sessions* in the side navigation bar. The Active Sessions window will open.
3. Click the checkbox to the left of the session. To remove all active sessions on the page, click the checkbox to the left of Start-Date-Time at the top of the list.
4. Click *Remove*. A confirmation dialog box will appear.
5. Confirm or cancel the removal.

To disconnect an active session from an appliance window:

This procedure is valid for supported KVM switches and serial console appliances. It may also be valid for appliances supported by a plug-in; see the appropriate documentation. You must have the Reboot Appliance and Disconnect Sessions unit access right. See *About Access Rights* on page 144. Additionally, your preemption level must be higher than the preemption level of the active session user. See *Preemption Levels* on page 41.

1. In a Units View window containing appliances (see *Accessing Units View windows* on page 106), click on the appliance name.
2. Click *Appliance Settings* in the side navigation bar. Then click *Sessions* in the side navigation bar, then *Active*. The Appliance Sessions window will open.
3. To disconnect one or more sessions, click the checkbox to the left of the sessions. To disconnect all sessions on the page, click the checkbox to the left of Start-Date-Time at the top of the list.

4. Click *Disconnect*. A confirmation dialog box will appear.

For virtual media sessions on supported KVM switches - If you attempt to disconnect an active virtual media session or a KVM session that is locked to a virtual media session, a confirmation message is displayed, indicating that any virtual media mappings will be disconnected. Confirm or cancel. See *Using Virtual Media* on page 279.

5. Confirm or cancel the disconnect.

Active sessions on a target device

To display information about active sessions on a target device:

In a Units View window containing target devices (see *Accessing Units View windows* on page 106), click on a target device Status field. The Active Sessions window for that target device will open.

You may also display active session information for a target device by clicking on a target device name in a Units View window, which will open the Unit Overview window. Then, click *Active Sessions* in the side navigation bar, and the Active Sessions window for that target device will open. The first method above saves a step.

Customizing a target device Active Sessions window

The following fields are always displayed in the Active Sessions window.

- Duration - Elapsed time since the session started, in hours:minutes:seconds.
- User - Name of current user. This field will be blank for users who do not have Appliance Administrator or User Administrator access rights when the Video Viewer session property “view identity of shared connections” is not set. See *Video Viewer session properties* on page 253.
- Type - Session type, which may be KVM, virtual media or serial.
- Connection - Connection path from the managed appliance to the target device. See *Connections to Units* on page 181.

The following fields may be displayed in the Active Sessions window. Use the Customize link to add or remove fields in the display. See *Using the Customize link in windows* on page 28.

- Owner - Owner of the session, when it is shared. This field will be blank for users who do not have Appliance Administrator or User Administrator access rights when the Video Viewer session property “view identity of shared connections” is not set. See *Video Viewer session properties* on page 253.
- Preemption Level - Effective user preemption level for the session user. See *Preemption Levels* on page 41.
- Channel - Channel number when connection includes a cascade switch (valid only for KVM or virtual media sessions).
- Client - IP address of client who is connected to this session (valid only for KVM or virtual media sessions).

- IQ Module - IQ module ID associated with the session (valid only for KVM or virtual media sessions).
- Lock Status - Whether KVM and virtual media sessions are locked. See *Virtual media session settings* on page 281.
- Mode - Session mode, which may change during the session. See *Customizing the Appliance Sessions window* on page 171 for a description of the available modes.
- Port - Port associated with the session.

To disconnect one or more target device active sessions:

NOTE: To disconnect a session, a user must have unit view access rights and a preemption level that is greater than or equal to the session user.

1. In a Units View window containing target devices (see *Accessing Units View windows* on page 106), click on a target device Status field. The Active Sessions window for that target device will open.
2. Click the checkbox to the left of the sessions. To disconnect all sessions, click the checkbox to the left of Duration at the top of the list. (If you do not have permission to disconnect an active session, you will not be able to select its checkbox or the checkbox at the top of the list.)
3. Click *Disconnect*. A confirmation dialog box will appear.
For virtual media sessions on supported KVM switches - If you attempt to disconnect an active virtual media session or a KVM session that is locked to a virtual media session, a confirmation message is displayed, indicating that any virtual media mappings will be disconnected. Confirm or cancel. See *Using Virtual Media* on page 279.
4. Confirm or cancel the disconnect.

Active modem sessions

In the event the primary network fails, you may establish a session to an ACS console server through a modem/ISDN dial-up connection method. This connection may be established using the SSH Passthrough client or the ACS console server plug-in. To configure the SSH Passthrough settings, see *Enabling SSH Passthrough* on page 195. To configure the ACS console server plug-in settings, see the ACS console server plug-in online help.

Secure connections

During the initial dial-up connection attempt, the DSView 3 DialUp service will authenticate the ACS console server and establish a connection using a Point-to-Point Protocol (PPP). Password Authentication Protocol (PAP) and Challenge Handshake Authentication Protocol (CHAP) are supported. In addition to the PAP and CHAP methods, a One Time Password (OTP) authentication may also be used for analog modem dial-up connections. (OTP is not supported on ISDN modems.) A secret password will be generated for every dial-up request, and each password will only be valid for a single attempt. Once authenticated, a secure connection will be established.

For added security, the ACS console server plug-in may also be configured for dial-back connections. Once authenticated, the dial-up connection will be dropped, and the ACS console server will dial-back to the DSView 3 server to establish a secure connection. This method does not support OTP. To configure dial-back settings on the DSView 3 server, see *DSView 3 software modem sessions* on page 67.

Only DSView 3 software administrators may access the Active Modem Sessions window.

Supported modems

The following modems and serial PCI cards are supported by the DSView 3 software, provided the modems are supported on the DSView 3 server operating system.

- Perle PCI-RAS 4 and PCI-RAS 8, which are backwards compatible with Perle V90 Modem
- Equinox SST MM 4p Modem
- Equinox SST 4p Serial
- Eicon DS series ISDN BRI-2M
- Eicon DS series ISDN 4BRI-8M

The DSView 3 software also supports the USR3453B - Courier 56k external modem.

NOTE: The modems listed are not supported on Sun Solaris SPARC operating systems.

Customizing the Active Modem Sessions window for all sessions

The Start-Date-Time field, which indicates when the target device session was started, is always displayed in the Active Modem Sessions window.

The Unit field, which indicates the units that are connected by dial-up, is always displayed in the Active Modem Sessions window.

The following fields may be displayed in the Active Modem Sessions window. Use the Customize link to add or remove fields in the display. See *Using the Customize link in windows* on page 28.

- Duration - Length of the DSView 3 software dial-up connection to the unit.
- IP Address - IP address of the dial-up connection to the unit.
- Status - Status of the dial-up connection. Status values include Established, indicating that a dial-up connection is established; or Establish/Primary, indicating that a dial-up connection is established but the primary network connection is also available; or Disconnecting, which indicates that a DSView 3 software administrator is closing the session.
- Dial-back - Identifies if the connection used a dial-back connection.
- Unit Phone Number - Phone number dialed to connect the unit.

To disconnect one or more target device active modem sessions:

NOTE: Only DSView 3 software administrators may disconnect active modem sessions.

1. In a Units View window containing target devices (see *Accessing Units View windows* on page 106), click *Active Modem Sessions* in the side navigation bar. The Active Modem Sessions window will open.
2. Click the checkbox to the left of the sessions. To disconnect all sessions, click the checkbox to the left of Duration at the top of the list. (If you do not have permission to disconnect an active session, you will not be able to select its checkbox or the checkbox at the top of the list.)
3. Click *Disconnect*. A confirmation dialog box will appear. Confirm or cancel the disconnect.

Connections to Units

The *Connections* link displays either target device or managed appliance connections.

- The Target Device Connections window lists all connections to the target device. You may also use this window to add or delete a connection to or from the target device.
- The Appliance Connections window lists all connections from the managed appliance to cascade switches or target devices. You may rename the units which are part of the connection path through this window.

NOTE: Merged target devices appear as separate connections in the Connections window.

Connection display format

Connections typically appear in a format similar to the following for connections to target devices, cascade switches and power devices:

<Managed appliance name>(<Port>) → <EID Number> → <target device>

<Managed appliance name>(<Port>) → <EID Number> → switch one <Port>→<target device>

<Managed appliance name>(<Port>) → <Power Device> (<Port>) → <target device>

<DSI5100 Appliance Name>(<Port>)→<target device>

The following examples illustrate typical connections that may appear in your DSView 3 software.

Example: Target device connections

In the following example, there are three target devices connected to ports 3, 4 and 8 of a DSR1021 switch named dsr-1021-huntsville. The DSR1021 switch ports are connected to the three target devices using IQ modules. The IQ module with an EID of 520255-044F6F is connected to target device td-john, while 520255-03F757 is connected to td-mary and 520255-016BE0 is connected to td-tim.

dsr-1021-huntsville(3)→520255-044F6F→td-john

dsr-1021-huntsville(4)→520255-03F757→td-mary

dsr-1021-huntsville(8)→520255-016BE0→td-tim

Example: Cascade switch connection

In the following example, an AutoView 200 1 x 8 switch is connected to port one of a DSR1021 switch named dsr-1021-huntsville, using an IQ module with an EID of 520255-023FB7. Each port of the AutoView 200 switch is connected to a different target device (520255-023FB701 through 520255-023FB708).

```
dsr-1021-huntsville(1)→520255-023FB7→switch one (1)→520255-023FB701
dsr-1021-huntsville(1)→520255-023FB7→switch one (2)→520255-023FB702
dsr-1021-huntsville(1)→520255-023FB7→switch one (3)→520255-023FB703
dsr-1021-huntsville(1)→520255-023FB7→switch one (4)→520255-023FB704
dsr-1021-huntsville(1)→520255-023FB7→switch one (5)→520255-023FB705
dsr-1021-huntsville(1)→520255-023FB7→switch one (6)→520255-023FB706
dsr-1021-huntsville(1)→520255-023FB7→switch one (7)→520255-023FB707
dsr-1021-huntsville(1)→520255-023FB7→switch one (8)→520255-023FB708
```

Example: Power device connection

In the following example, an Avocent SPC power device is connected to the SPC port of a DSR1021 switch named dsr-1021-huntsville. SPC device outlet A1 is connected to target device 02-17-F2 SPC A1.

```
dsr-1021-huntsville(SPC)→02-17-F2 SPC (A1)→02-17-F2 SPC A1
```

To display a connections window:

1. In a Units View window (see *Accessing Units View windows* on page 106) click on a unit name. The Unit Overview window will open.
2. Click *Connections* in the side navigation bar.
 - If you selected a target device, the Target Device Connections window will open, including all connections to the target device.
 - If you selected a managed appliance, the Appliance Connections window will open, including all connections to the managed appliance.
3. (Optional) Click *Table* to view the connections as a table, or click *Graphical* to view the connections as an illustration.

Renaming a managed appliance connection**To rename a managed appliance connection:**

1. In a Units View window containing appliances (see *Accessing Units View windows* on page 106), click on the appliance name.
2. Click *Connections* in the side navigation bar. The Appliance Connections window will open.

3. Click on a connection. The Appliance Connections - Rename window will open.
4. Type in new name for one or more items in the connection chain.
If you modify a name and the automatic name push feature is enabled, the new name will be pushed to the appliance, based on the configured push properties. See *Automatic name push* on page 126.
5. Click *Save* and then click *Close*. The Appliance Connections window will open.

Adding and deleting target device connections

To add a target device connection:

1. In a Units View window containing target devices (see *Accessing Units View windows* on page 106), click on the name of a target device.
2. Click *Connections* in the side navigation bar. The Target Device Connections window will open.
3. Click *Add*. The Add Target Device Connection Wizard will open.
4. Select the appropriate target device connection type from the list.
5. Click *Next*. The Select Appliance with Available Ports window will open.
6. Select a managed appliance, then click *Next*.
7. The Select Available Connection window will open. Select a connection, then click *Next*.
8. The Completed Successful window will open. Click *Finish*. The Target Device Connections window will open.

To delete a target device connection:

1. In a Units View window containing target devices (see *Accessing Units View windows* on page 106), click on the name of a target device.
2. Click *Connections* in the side navigation bar. The Target Device Connections window will open.
3. Click the checkbox to the left of the target device connection(s) to delete. To delete all target device connections on the page, click the checkbox to the left of Connection at the top of the list.
4. Click *Delete*. A confirmation dialog box will appear.
5. Confirm or cancel the deletion.

Merging virtual and physical target device connections

From the DSView 3 software, you can merge virtual device connections with physical target device connections. Merging the unit connections allows all possible actions to be available from a single view, while the physical and virtual target devices remain distinct entities within the DSView 3 database. For example, a MergePoint® service processor (SP) manager may be connected to a blade server that hosts an ESX Server. By merging the physical blade server connections with the virtual

ESX Server connections, you could launch a KVM session to the blade server or VI Client session to the ESX Server from the same view with the DSView 3 software.

To merge virtual and physical target device connections:

1. In a Units View window containing Virtualization units, click the name of a hypervisor manager or server. The Unit Overview window opens.
2. Click *Connections*. The Connections window opens.
3. Click *Add*. The Add Unit Connection Wizard opens.
4. From the menu, select a target device to be merged with the hypervisor manager or server. Click *Next*.
5. Click *Finish*. The new connection is displayed.

To delete merged connections:

1. In a Units View window containing Virtualization units, click the name of a hypervisor manager or server. The Unit Overview window opens.
2. Click *Connections*. The Connections window opens.
3. Select the connection from the list. Click *Delete*, then click *Yes* to confirm.

Data Logging

The DSView 3 software supports logging of serial session console data from certain appliances and their target devices, using the Syslog protocol.

NOTE: Navigation links, configuration pages and display pages for data logging will only be visible for appliances and target devices that support Syslog messaging.

The DSView 3 software has an SSH server that supports SSH2; this server must be enabled in the DSView 3 software to use the data logging feature. An appliance establishes an SSH connection to the DSView 3 server (using its X.509 appliance certificate) on demand when it has Syslog messages to send. The SSH server then forwards valid messages to the Syslog server; this server must be enabled in the DSView 3 software to use the data logging feature.

There are two types of Syslog messages:

- Data log messages - Contain serial console data that will be stored in files on the DSView 3 server. The files may then be viewed.
- Events - When a defined event occurs on the appliance, a Syslog message is sent to the appliance, and then to the DSView 3 software system event database (for information about events, see *Events and Event Logs* on page 339). Also, when the appliance detects a port alert string on a serial port, it can send a syslog event message.

Data session logging is enabled per connection on the appliance, subject to license availability (see *Data log licenses* on page 186). The DSView 3 server supports up to 2048 enabled data logging sessions on each DSView 3 server (assuming sufficient licenses are available).

Data log files

Syslog messages that contain data log session information are stored in individual ASCII files. Syslog data messages that contain appliance and port values are linked with a target device; those with only appliance values are linked with an appliance. The maximum number of data log files that can be written simultaneously is determined by the number of data log session licenses available.

A data log filename includes the name of the appliance and/or target device, plus the system data and time when the file was created. Current files have a .txt file name extension. If a port supports session sharing, concurrent sessions on that port will be written to a single log file.

Data log files are not backed up by the DSView 3 software backup utility.

When a data log file is created, a companion signature file with the same name is created, but with a .sig file name extension. This file is digitally signed using the DSView 3 software private key. When a user wants to display the content of a data log file, the DSView 3 software will first verify the digital signature to ensure the file has not been altered.

You may also export the DSView 3 system X.509 certificate and use its public key to validate the signature of files, using external tools. See *System certificate and SSH key* on page 46.

Data log licenses

A data log license is used for each enabled data log port connection. A direct SSH/Telnet session to an appliance will not require or use a data log license for the DSView 3 software to capture data logs for that appliance session. Only sessions related to appliance ports require a data log license.

A data log license is used when data logging is enabled on a port connection. When data logging is disabled on a port connection, that license is freed and returned to the available pool.

The DSView 3 software ships with 32 available data log licenses - that is, 32 data logging sessions may be enabled on appliance connections that support data logging. An add-on license key may be obtained to support a certain number of additional data logging sessions or an unlimited number of data logging sessions (site license). See *Licenses* on page 54 for more information.

Configuring Data Logging

Complete the following steps to configure DSView 3 software data logging.

- Make sure you have sufficient data log licenses - one per port connection for which you want to log session data; see *Data log licenses* on page 186.
- Enable the SSH server; see *Enabling the SSH server* on page 187.
- Enable the Syslog server; see *Enabling the Syslog server* on page 187.
- Enable data logging on appliance and/or target device connections; see *Enabling and disabling data logging on units* on page 188.
- Verify the data logging settings for each connection; see *Verifying the data logging settings for each connection* on page 188.
- Customize the SSH server settings; see *Viewing and customizing the SSH server settings* on page 189.
- Configure the notification mode for buffer warning events as SNMP; see *Configuring the buffer warnings events as SNMP* on page 190.
- Specify where the data log files will be stored; see *Specifying where data log files will be stored* on page 190.
- Specify archiving properties; see *Archiving and deleting data log files* on page 191.

Only DSView 3 software administrators may enable the SSH and Syslog servers, specify where the data log files will be stored and specify archiving properties. You must have the Configure Unit Settings access right to enable/disable data logging.

Enabling the SSH server

The SSH server must be enabled in the DSView 3 software to use the data logging and SSH Passthrough features.

To enable the SSH server:

1. Click the *System* tab.
2. Click *DSView Server* in the top navigation bar.
3. Click *SSH Server* in the side navigation bar. The SSH Properties window will open.
4. Click the *Enable SSH Server* checkbox. The preset TCP port is 4122. If you wish to change the port, enter a port value in the range 1-65535 in the Port field.
5. (Optional - IPv6 only) Select *IPv6 Proxy Port* to use the IPv6 protocol to connect to the SSH server. The preset port is 4123; typically, the IPv6 proxy port number is one increment higher than the SSH server port. If you wish to change the port, enter a port value in the range 1-65535 in the Port field.

If DSView 3 clients are located on an external connection, the specified SSH server port must be opened on your firewall.

6. Click *Save*.
7. If you changed the port value, you are prompted to confirm the change. Confirm or cancel the change.

Enabling or disabling the SSH server will generate a DSView 3 software system event.

Enabling the Syslog server

The Syslog server must be enabled in the DSView 3 software to use the data logging feature. You may change the TCP port where the DSView 3 software will listen for Syslog messages forwarded by the SSH server.

To enable or disable Syslog server port:

1. Click the *System* tab.
2. Click *DSView Server* in the top navigation bar.
3. In the side navigation bar, click *Data Logging*, then *Server Settings*. The Syslog Properties window will open.
4. Click the *Enable Syslog Server* checkbox. The preset TCP port is 4514. If you wish to change the port, enter a port value in the range 1-65535 in the Port field.

If DSView 3 clients are located on an external connection, the specified SSH server port must be opened on your firewall.

5. Click *Save*. You are prompted to confirm the change. Confirm or cancel the change.

6. If you have not already done so, click the *SSH server page* link and enable the SSH server. See *Enabling the SSH server* for more information.

Enabling or disabling the Syslog server will generate a DSView 3 software system event.

Enabling and disabling data logging on units

Data logging is enabled and disabled per connection. Depending on the appliance type, you may enable or disable data logging on target device connections, appliance connections or both.

You must have the Configure Unit Settings access right to enable/disable data logging.

To enable or disable data logging on a unit:

NOTE: The exact name and content of configuration pages are specific to the appliance type; see the appropriate documentation.

1. In a Units View window containing the appliance or target device (see *Accessing Units View windows* on page 106), click on the unit name.
2. Click *Appliance Settings*, click *Data Logging* and then *Configure* in the side navigation bar. The Data Logging Configuration window for that unit will open. The display lists all connections. The Status field may contain the following values:
 - Enabled - Data logging is enabled in the appliance for the corresponding port connection and a data log license has been allocated for it (data logging for a direct session to an appliance does not require or use a license).
 - Disabled - Data logging is disabled in the appliance for the corresponding port.
 - Unlicensed - Data logging is enabled in the appliance for the corresponding port connection, but there is no data log license allocated for it.
3. To enable data logging on one or more connections:
 - a. Click the checkbox next to the connection name(s). To select all connections on the page, click the checkbox at the top of the list.
 - b. Click *Enable*. If sufficient data log licenses are available, logging will be enabled on the selected connections and the Status field will indicate Enabled. If insufficient licenses are available, a warning will be displayed, and the Status field will indicate either Enabled or Unlicensed.
4. To disable data logging on one or more connections:
 - a. Click the checkbox next to the connection name(s). To select all connections on the page, click the checkbox at the top of the list.
 - a. Click *Disable*. Data logging will be stopped on the selected connections, and the data log licenses used by those connections will be returned to the available pool.

Verifying the data logging settings for each connection

After enabling data logging on the appliance, verify that DSView Data Log is enabled for each connection.

To check the data logging settings for connections:

1. In a Units View window, click on the appliance name.
2. Click *Appliance Settings*, click *Ports* and then *Serial* in the side navigation bar. The Serial window will open.
3. Click on the appropriate port.

NOTE: If the Status is Disabled, you will not be able to click on the connection. To change the status to Enabled, see *Enabling and disabling data logging on units* on page 188.

4. In the side navigation bar, click *Data Logging*.
5. If not already selected, click the radio button next to Enable DSView Data Log. Any previous data logging settings will be lost.
6. If available, click the *Flash Required* button to ensure that these settings remain even if power is interrupted. If the Flash Required button is not displayed, the settings have been saved to non-volatile Flash memory on the appliance.

Viewing and customizing the SSH server settings**To view and customize the SSH server settings:**

1. In a Units View window, click on the appliance name.
2. Click *Appliance Settings*, click *Data Logging* and then *Syslog SSH Server* in the side navigation bar.
3. In the DSView Server IP field, enter the IP address for the DSView 3 server that will receive data logs. This may be either the hub or a spoke server.
4. In the Syslog Server Port field, enter the Syslog port that you set in *Enabling the Syslog server* on page 187.
5. In the SSH Server Port field, enter the SSH port that you set in *Enabling the SSH server* on page 187.

NOTE: It is recommended that no more than 2048 data logging and SSH Passthrough sessions be open concurrently.

6. The Appliance Configuration Section contains several fields for managing the SSH sessions and buffer warning events. Each field contains the Avocent recommended value, but you may change these values if needed.
 - **SSH Idle Timeout (seconds):** If the SSH session is inactive for the specified amount of time, it will be closed. The default time-out is 15 seconds.
 - **SSH Start Threshold (bytes):** The appliance will log data in its local memory. Once it meets the threshold specified in this field, it will attempt to open an SSH session to the DSView 3 server. The default threshold is 10 KB.

- **SSH Tunnel Buffer Size (bytes):** If the SSH session cannot be opened, the appliance will continue to store data logs in its local memory until it reaches the size specified in this field. The default buffer size is 1 MB.

NOTE: The appliance may be prevented from opening an SSH session if a firewall is blocking traffic, the DSView SSH service is disabled or the IP address and TCP port settings are incorrect.

- **Buffer Full First Warning (bytes):** If an SSH session cannot be opened, a first warning will be sent once the appliance local memory reaches the size specified in this field. The recommended first warning size is 500KB.
- **Buffer Full Second Warning (bytes):** If an SSH session cannot be opened, a second warning will be sent once the appliance local memory reaches the size specified in this field. The recommended second warning size is 700 KB.

Configuring the buffer warnings events as SNMP

If the appliance fails to open an SSH connection to the DSView 3 server, the appliance will continue to store data logs in local memory. To ensure that the administrator receives buffer warnings events if the SSH connection fails, change the notification mode from Syslog to SNMP.

To configure the buffer warnings as SNMP:

1. In a Units View window, click on the appliance name.
2. Select *Appliance Settings - Events - Traps/Syslog*.
3. Click the checkbox next to the following events: Appliance Data Log Buffer Full First Warning, Appliance Data Log Buffer Full Second Warning and Appliance Data Log Loss.
4. Click the *Enable SNMP Trap* button.
5. The Notification Mode for the events changes from Syslog Enabled to SNMP Trap Enabled.

If available, click the *Flash Required* button to ensure that these settings remain even if power is interrupted. If the Flash Required button is not displayed, the settings have been saved to non-volatile Flash memory on the appliance.

To begin receiving buffer warning events, configure the DSView 3 software for email notifications. See *Email Notifications* in the DSView 3 software online help for more information.

Specifying where data log files will be stored

To specify where data log files will be stored:

1. Click the *System* tab.
2. Click *DSView Server* in the top navigation bar.
3. In the side navigation bar, click *Data Logging*, then *Location*. The Data Logging Location Properties window will open.

4. In the Location field, enter a local or network shared location, using a UNC (Universal Naming Convention) path of up to 256 characters. You cannot specify a mapped network drive. If the operating system supports case sensitive file names, use case sensitive text.
The default location is %<DSView 3 software installation directory>%\datalogs.
If you change the location at a later time, any data log files in the previous location will no longer be viewable or accessible through the DSView 3 software.
Data log files are not backed up by the DSView 3 software backup utility.
5. If a login will not be required to access the file location, disable the *Login required to access shared drive location* checkbox.
If a login will be required to access the file location:
 - a. Enable the *Login required to access shared drive location* checkbox.
 - b. In the Username field, enter the username (up to 256 characters) to access the file location.
 - c. In the Password field, enter the password (up to 64 characters).
 - d. Repeat the password in the Confirm Password field.
6. Click *Save*.

Archiving and deleting data log files

Data log files are archived at specified intervals or when a file reaches a specified size. You may also archive files dynamically. Archived files retain the same name with a .zip file name extension.

Each time a file is archived, it is considered a version for that particular connection/port. You may indicate the number of versions that will be retained in the file system - when this value is exceeded for a connection/port, the oldest archived file version will automatically be deleted. You may also delete archived files dynamically.

If an appliance or target device name is changed, any current log files associated with the original name will be closed and archived with their original name. Those files will be viewable only from the Reports - Data Log Session Files window. Subsequent incoming data log messages will be written to a new file that has the new unit name.

Similarly, if a target device or appliance is deleted from the DSView 3 software system, any current log files associated with the unit (and its target devices if the deleted unit is an appliance) will be closed and archived. These files will be viewable only from the Reports - Data Log Session Files window.

To specify archiving properties:

1. Click the *System* tab.
2. Click *DSView Server* in the top navigation bar.
3. In the side navigation bar, click *Data Logging*, then *Archiving*. The Data Logging Archiving Properties window will open.

4. In the Archive by frequency field, select the interval for archiving current data log files: daily (every day at midnight local time), weekly (every Sunday at midnight) or monthly (the first day of each month at midnight).
5. In the Archive by size field, enter a size from 1-2000 MB. When a current file reaches this size, it will be closed and archived.
6. In the Number of archived versions field, select a value (1-10). This specifies the maximum number of archived versions of a file (based on the file name) that will be retained. When this number is exceeded, the oldest archived file will be deleted.

For example, if a value of 5 is specified, up to five archived versions of each file will be retained. When a subsequent archive operation occurs for that log file (triggered either by the archive frequency or size value being reached), the oldest archived version will be deleted.

Changing this value affects all archived files.

7. Click *Save*.

Dynamically archiving and deleting data log files

Data log files are automatically archived and deleted according to the properties specified in the preceding procedure. You may also archive current files or delete archived files at any time.

To archive data log files dynamically:

1. Click the *Reports* tab.
2. Click *Data Log Session Files* in the top navigation bar. The Data Log Session Files window will open.
3. Click the checkboxes to the left of current log files to be archived. To select all files on the page, click the checkbox at the top of the list. (The status for all selected files must be Current.)
4. Click *Archive Now*. A confirmation dialog box will appear.
5. Confirm or cancel the archiving.

To delete data log files dynamically:

NOTE: Always use this procedure to delete data log files dynamically, rather than using other methods to delete files.

1. Click the *Reports* tab.
2. Click *Data Log Session Files* in the top navigation bar. The Data Log Session Files window will open.
3. Click the checkboxes to the left of log files to be deleted. To select all files on the page, click the checkbox at the top of the list.
4. Click *Delete*. A confirmation dialog box will appear.
5. Confirm or cancel the deletion.

Viewing Data Log Files

Displaying lists of data log files

Each row in the display table contains the following information about a single log file:

- Log file name
- Name of the DSView 3 server where the file was created and stored
- When the file was created
- When the file was last modified
- File size in megabytes
- Status - Archived, Current, File not Found or Pending

The Size and Last Modified fields are optional; use the Customize link to add or remove them from the display; see *Using the Customize link in windows* on page 28.

To display information about log files for a single unit, you must have View Data Logging access rights. To display information about all data log files in the DSView 3 software system, you must be a member of the DSView 3 software administrators or auditor user group.

To display a list of data log files for a single unit:

1. In a Units View window containing the appliance/target device (see *Accessing Units View windows* on page 106), click on the unit name.
2. In the side navigation bar, click *Data Logging*, then click *Session Files*. The Data Logging Session Files window for that unit will open.
3. To view a file's content, click on the file name. See *Displaying data log file content*.

To display a list of all data log files in the DSView 3 software system:

NOTE: This is the only procedure that will include log files for units that have been renamed or deleted from the DSView 3 software system.

1. Click the *Reports* tab.
2. Click *Data Log Session Files* in the top navigation bar. The Data Log Session Files window will open.

You may dynamically archive or delete data log files from this window; see *Dynamically archiving and deleting data log files* on page 192.

3. To view a file's content, click on the file name. See *Displaying data log file content* below.

Displaying data log file content

When you click on a file name in a Data Log Session Files window, the file is transferred to the browser. It will be opened as a text file, using the default text viewer on the DSView 3 software client's computer.

Before the file is transferred to the browser, the DSView 3 software will verify the file's digital signature. If the computed digital signature does not match the actual file's digital signature, the content of the file will be preceded with a warning, indicating that digital signature verification failed and the file content may have been altered.

If you select a log file that does not reside on the DSView 3 server to which you're logged in, the log file is transferred from the appropriate server.

You may also validate the signature of data log files by exporting the system certificate; see *System certificate and SSH key* on page 46 and *Verifying data log file digital signatures*.

Verifying data log file digital signatures

The DSView 3 software computes hashes for data log files using the SHA1 digest algorithm. After a hash is computed for a file, it is signed using the RSA public key algorithm and the DSView 3 software X.509 system certificate private key.

To verify the signature, you may use standard tools (such as OpenSSL) and the DSView 3 software system X.509 certificate public key. (To view or export the system certificate, see *System certificate and SSH key* on page 46.)

For example, assume the following:

- A data log file is created with the name `cisco-router-session-2006-04-02-12:12:01.txt`.
- The DSView 3 software signs the data log file and creates a signature file with the name `cisco-router-session-2006-04-02-12:12:01.sig`.
- The DSView 3 software system certificate has been exported with the name `sun-jdoe.p10`.

The OpenSSL command to verify the signature (and a successful response) is:

```
c:\>openssl dgst -sha1 -verify sun-jdoe.p10 -signature cisco-router-  
session-2006-04-02-12:12:01.sig cisco-router-session-2006-04-02-  
12:12:01.txt  
c:\>Verification OK
```

SSH Passthrough Sessions

An SSH Passthrough session is a serial session opened to a unit without the use of a web browser. From an SSH client, a user with access rights can establish a connection to any serial unit managed by the DSView 3 software that supports Secure Shell 2 (SSH2) and Avocent DS Authentication 2 Protocol (ADSAP2) protocol.

The DSView 3 server provides user authentication and, if events are enabled, logs SSH Passthrough session events. You can also share SSH Passthrough sessions with multiple users across multiple DSView 3 servers. Serial sessions initiated from the DSView 3 client software may also be shared if the Avocent Session Viewer is preconfigured as the serial viewer.

Shared serial sessions provide server redundancy. If a DSView 3 server is no longer available, a user may establish an SSH Passthrough session to a different DSView 3 server.

Client licenses

A client license is required for each user operating SSH Passthrough sessions. However, a user can open any number of SSH Passthrough sessions without increasing the license counter, provided the username is identical, and resides on the same DSView 3 server and network source address for each SSH Passthrough session. Once the user closes all SSH Passthrough sessions, the client session license is freed. If the available number of client session licenses is exceeded three times, users will be prevented from establishing a new SSH Passthrough session. See *Licenses* on page 54 for more information.

Configuring SSH Passthrough

- Enable the SSH server; see *Enabling the SSH server* on page 187.
- Enable SSH Passthrough; see *Enabling SSH Passthrough* on page 195.
- (Optional) Enable SSH port sharing; see *SSH port sharing* on page 196.

Only DSView 3 software administrators may enable the SSH servers, SSH Passthrough and SSH port sharing.

Enabling SSH Passthrough

To enable or disable SSH Passthrough:

1. Click the *System* tab.

2. Click *DSView Server* in the top navigation bar.
3. Click *SSH Passthrough* in the side navigation bar. The SSH Passthrough Properties window opens.
4. To enable SSH Passthrough, select the *Enable SSH Passthrough* checkbox.
-or-
To disable SSH Passthrough, uncheck the *Enable SSH Passthrough* checkbox.
5. In the event of a network failure, you may establish an SSH Passthrough session to the target device through Modem Dial-Up. To allow this capability, select the *Enable Modem Dial-Up Connections* checkbox. If the main network connection is unavailable when trying to open an SSH Passthrough session, you will be notified that the network is unreachable and a connection over modem dial-up is being established.
-or-
To prevent connections through Modem Dial-Up, uncheck the *Enable Modem Dial-Up Connections* checkbox. If the main network connection fails, the SSH Passthrough connection will fail without attempting an alternate connection.

NOTE: Modem dial-up connections are only available on supported ACS console servers.

6. Click *Save*.
7. If you have not already done so, click the *SSH Server page* link and enable the SSH server. See *Enabling SSH Passthrough* on page 195 for more information.

Enabling or disabling SSH Passthrough will generate a DSView 3 software system event.

SSH port sharing

SSH Passthrough sessions and/or Avocent Session Viewer sessions can be shared to allow other users to view the session data. You can also enable hub/spoke forwarding to allow sessions from multiple DSView 3 servers to be shared simultaneously. The first user to open an SSH Passthrough or Avocent Session Viewer session has read/write access; all subsequent users who share the session have read-only access. Users can enter a command to obtain read/write access, but only one user at a time can possess read/write access.

To configure SSH Passthrough port sharing:

1. Click the *System* tab.
2. Click *DSView Server* in the top navigation bar.
3. Click *SSH Passthrough* in the side navigation bar. The SSH Passthrough Properties window opens.
4. To enable shared SSH Passthrough sessions, select the *Enable Port Sharing* checkbox.
5. To allow simultaneous shared SSH Passthrough sessions from multiple DSView 3 servers, select the *Enable Hub/Spoke Forwarding* checkbox.

If hub/spoke forwarding is enabled, shared SSH Passthrough sessions are centralized to the DSView 3 server that owns the appliance to which the session is opened.

NOTE: The appliance is owned by the DSView 3 server to which it was first added. To determine which DSView 3 server owns an appliance, go the appliance Unit Overview Page and click *Properties - Network*. The DSView Server menu displays the name of the server that owns the appliance. See *Unit Properties* on page 139 for more information.

6. To allow sharing among SSH Passthrough sessions and Avocent Session Viewer sessions, select the *Enable DSView Client Serial Sessions* checkbox.
7. Click *Save*.

Configuring the Avocent Session Viewer

To allow sharing among sessions initiated from the DSView 3 client software, you must preconfigure the Avocent Session Viewer as the serial viewer.

To configure the Avocent Session Viewer:

1. Click the *Profile* tab.
2. Click *Applications* in the side navigation bar.
3. Select the *Avocent Session Viewer* checkbox.
4. Click *Save*.

For more information about serial session applications, see *Choosing the serial session application* on page 38.

SSH Passthrough Sessions

You may establish an SSH connection to a target device or an appliance console by specifying the appropriate name in the SSH command. You may also establish an SSH session to a target device with multiple connections, but the appliance name and port number must be entered in place of the target device name.

NOTE: It is recommended that no more than 2048 concurrent data logging and SSH Passthrough sessions be open.

Preemption

Your SSH session may be interrupted or disconnected based on the appliance preemption levels. If the appliance supports DSView 3 software preemption levels, then user preemption rights will be determined based on the preemption levels set in the DSView 3 software. For more information, see *Preemption Levels* on page 41.

Logging in with a User SSH key

A user SSH key may be used instead of a password to authenticate the user before establishing an SSH Passthrough session. See *User SSH key* on page 235 to configure the key.

Establishing an SSH Passthrough connection to a unit

To establish an SSH Passthrough connection to a target device or appliance console:

NOTE: If you are using the Linux or Unix SSH command, you will need to specify the port by entering **-p** and the port number. The default port number is 4122. For more information or to change the port number, see *Enabling SSH Passthrough* on page 195.

1. To connect to a target device or appliance console, open your SSH client and enter the following values in the provided text fields:
 - **<zone1/username>:**
Specify the highest level zone for which you have access rights. If a zone is not specified for the username, the top level zone is assumed. If you do not have access to this zone, the connection attempt fails.
 - **<zone2/targetdevicename>@** (to connect to a target device)
-or-
<zone2/appliancename>@ (to connect to an appliance console)
If the appliance resides in a zone below your highest level zone, specify a zone. If a zone is not specified, it is assumed that unit belongs to the zone specified for the username. If the unit does not reside in this zone, the connection attempt fails.
 - host name or IP address of the DSView 3 server

NOTE: If DS Zones are not enabled, you do not need to specify a zone for the username or appliance. For more information about zones, see *DS Zones* on page 219.

To connect to a target device using the Linux or Unix SSH command, enter a command in the following format:

<zone1/username>:<zone2/target device name>@<host name or IP address of DSView 3 server>

For example, a command to open an SSH session to a target device may look like this:

```
ssh -p 4122 zone1/jsmith:zone2/Boston@172.30.19.101
```

To connect to an appliance console using the Linux or Unix SSH command, enter a command in the following format:

<username>:<appliance name:>@<host name or IP address of DSView 3 server>

For example, a command to open an SSH session to an appliance console may look like this:

```
ssh -p 4122 zone1/jsmith:zone2/ACS_Lab:@172.30.19.101
```

NOTE: The colon is used to delimit different arguments; however, if a colon is contained within the name, then a double backslash may be used as an escape sequence to include the colon in the name. For example, if the username is "sanders:", a command to open an SSH session to a target device may look like this:

```
ssh -p 4122 zone1/sanders\\\:zone2/Boston:5@172.26.5.100
```

2. If a user SSH key has been configured, the session is automatically authenticated based on the key. The user SSH key must be stored on the DSView 3 server specified in step 1.

-or-

When prompted, enter the password for the username. If you enter an incorrect password three times, the login failed event will be generated and the SSH session will be closed.

The user credentials for the target device are validated by the DSView 3 server. If the user is valid, the DSView 3 software database determines the IP address of the appliance and the X.509 certificate for establishing the connection. If the user is invalid, the session closes immediately.

3. If more than one connection exists to the target device, the SSH connection attempt fails and the DSView 3 software informs the user of the failure reason. To connect to a target device with multiple connections, specify the appliance name and port instead of the target device name. The appliance name must be identical to the appliance name in the DSView 3 software database, and the port must be the exact port number that appears in the Units view in the DSView 3 software.

To connect to a target device with multiple connections, open your SSH client and enter the following values in the provided text fields:

- **<zone1/username>:**
- **<zone2/appliancename>:port@**
- host name or IP address of the DSView 3 server

To connect to a target device with multiple connections using the Linux or Unix SSH command, enter a command in the following format:

<zone1/username>:<zone2/appliance name>:port>@<host name or IP address of DSView 3 server>

4. The SSH client attempts to establish an SSH connection to the appliance or target device. If a successful connection is established, the DSView 3 server acts as a proxy between the user and target device.

If an SSH Passthrough session to the same appliance or target device is already open, your session is shared with the previously connected users. You have read-only access to the session, but you may enter a command to obtain read/write access. See *Transferring read/write access* on page 202.

5. If the console port on the target device requires additional authentication, the user is prompted to log in.

Escape key sequence

An escape key sequence is a combination of characters that can be sent to the DSVIEW 3 server to affect an SSH Passthrough or Avocent Session Viewer session. The default escape sequence is **^Ec**, which can be followed by an escape key to send a command to a target device. Some escape key sequences are limited to only the user with read/write access.

In this chapter, the preset escape Sequence **^Ec** is used in all examples to indicate the configured escape sequence.

Table 14.1: DSVIEW 3 Software - Supported SSH Passthrough Session Escape Keys

Escape Keys	Description	Escape Keys	Description
.	Disconnect	?	Print this message
a	Attach read/write rights	e	Change escape sequence [the preset value is ^Ec]
I?	Displays break sequence list*	0-9	Send specific break sequence*
r	Replay last 30 lines of log	<cr>	Ignore/abort command

*Only users with read/write access can send these escape key sequences.

To modify the escape sequence:

From an SSH Passthrough session, enter the following command:

^Ece[new escape sequence]

For example: **^Ece^Ac** changes the escape sequence from **^Ec** to **^Ac**.

To enter an escape key sequence:

From an SSH Passthrough session, enter a command in the following format:

^Ec[escape key]

For example: **^EcI?** displays the break sequence list.

After entering an escape key sequence, the SSH client displays a message indicating success or failure.

Break sequences

NOTE: SSH port sharing must be enabled before you can configure break sequences.

A break sequence is a user-defined combination of characters that can be sent as a command to a target device during an SSH Passthrough or Avocent Session Viewer session. A break sequence is sent when the corresponding escape key sequence is typed by the user. The DSVIEW 3 software

supports ASCII and UTF-8 characters and special break keys. Only the user with read/write access to the SSH session can send a break sequence to a target device.

You can configure up to 10 break sequences to be used in SSH Passthrough sessions.

The following special break keys are supported:

Table 14.2: DSView 3 Software - Supported SSH Passthrough Session Break Keys

Break Character	Description	Break Character	Description
\a	Alert	\z	Serial break [defined as Telnet break: IAC(\37), BREAK(\363)]
\b	Backspace	\\	Backslash
\d	Delay [preset value is 250 milliseconds]	\^	Circumflex
\f	Form-feed	\ooo	Octal representation of a character (where ooo is one to three octal digits)
\n	New line	\c	Character c
\r	Carriage return	^?	Delete
\t	Tab	^c	Control character (c is "and"ed with 0x1f)
\v	Vertical tab	[UTF-8]	Any utf8 character

To configure break sequences:

1. Click the *System* tab.
2. Click *DSView Server* in the top navigation bar.
3. Click *SSH Passthrough* in the side navigation bar. The SSH Passthrough Properties window opens.
4. In the Delay field, you may enter the number of milliseconds to delay a command if **\d** is entered.
5. Enter the break sequence description in the Description field, then enter the break sequence in the Break Sequence field. Descriptions and break sequences are limited to 64 characters. Field numbers 0-9 are available for up to 10 break sequences.

To send a break sequence:

1. From an SSH Passthrough session, enter the escape sequence for the break sequence definition in the following format:
^Ecl[break sequence number 0-9]
 For example: ^Ec15
2. The break sequence is sent to the target device and a confirmation message appears.

-or-

The SSH client indicates that the break sequence is invalid or contains a syntax error. You can correct the error and resend the break sequence.

Transferring read/write access

Only one user at a time can have read/write access to a shared SSH Passthrough or Avocent Session Viewer session. The first user who opens the session has read/write access. If that user exits a shared session, read/write access is granted to a randomly selected user who is sharing the session. A user with read-only access can enter a command to obtain read/write access.

To obtain read/write access:

1. From a shared SSH Passthrough or Avocent Session Viewer session where you have read-only access, enter the following command:
^Eca
2. The user with read/write access receives a message that read/write access has been transferred to the specified user.
3. You receive a message that the user has lost read/write access.

You now have sole read/write privileges to the SSH Passthrough or Avocent Session Viewer session. Transferring read/write access generates DSView 3 software system events.

Disconnecting a session

To disconnect an SSH session:

1. From an SSH Passthrough session, enter the following command:
^Ec.
2. Your session is closed. If you had read/write access to the session, read/write access is granted to a randomly selected user who is sharing the session.

Displaying session output

If a data log was created for the SSH Passthrough session, you can enter a command to display the last 30 lines (limited to 16384 characters) of the data log on the SSH client. The last 30 lines may include previous SSH sessions, but will only display target device output, not user actions.

NOTE: To display session output, data logging must be enabled and the user must have access rights to unit. See *Data Logging* on page 185 and *User Access Rights* on page 239.

To display session output:

1. From an SSH Passthrough session, enter the following command:
^Ecr

2. The client displays the last 30 lines of the data log.

-or-

If you do not have access rights or if a data log was not created, an error message is displayed.

Supported service processor commands

NOTE: SSH Passthrough port sharing is not supported if a server processor command is included at the end of the SSH command.

When opening an SSH Passthrough session to a target device connected to a supported MergePoint 52xx manager, you may include a service processor (SP) command at the end of the SSH command. If the SP command is not present at the end of the SSH command, the appliance may provide the user with a menu of SP commands to choose from.

To include an SP command, open your SSH client and enter a command in the following format:

**<username>:<target device name>@<host name or IP address of the DSView 3 server>
[spcommand]**

NOTE: Enter a space between <host name or IP address of the DSView 3 server> and [spcommand].

The first part of the command will establish an SSH session to the MergePoint 52xx SP manager. If a supported SP command is present at the end of the SSH command, the SP command will be passed through to the service processor on the appliance. The appliance will validate and execute the command.

For example, a command to open an SSH session to a MergePoint 52xx SP manager and execute an SP command may look like this:

```
ssh -p 4122 zone1/jsmith:zone2/MGP@172.30.19.122 poweron
```

For more information and a list of supported SP commands, see the documentation included with the MergePoint 52xx SP manager.

Grouping Units

The DSView 3 Explorer automatically groups managed appliances by the type of appliance (DSR switch, ACS console server and so on). Target devices are automatically grouped based on the type to which they are assigned.

You may also add and change the following types of groups:

- Sites
- Departments
- Locations
- Custom fields - Custom fields allow a user to create groupings of units which are accessed by all DSView 3 software users
- Personal and global unit groups - Global unit groups may be seen by all users; personal unit groups are visible only to the user who created the group

Site, Department and Location Groups

You may create one or more site, department and location names and then associate units with them. For example, you could create sites names such as Austin and Sunrise, department names such as Software Development and Human Resources or location names such as Lab Room 101 and System Administrator's Office.

Site, Department and/or Location columns may be included in a Units View window display, using the Customize link. See *Using the Customize link in windows* on page 28.

To group units by site, department or location, you first create a site/department/location, then associate units with it. Sites/departments/locations that contain units to which a user does not have access rights will not appear in the side navigation bar. The site/department/location must also have at least one unit associated with it to be displayed in the side navigation bar.

To add a site, department or location:

1. Click the *Units* tab.
2. To add a site, click *Sites* in the top navigation bar. The Sites window will open.

To add a department, click *Departments* in the top navigation bar. The Departments window will open.

To add a location, click *Locations* in the top navigation bar. The Locations window will open.

3. Click *Add*. The Add Site, Add Department or Add Location window will open.
4. Type a name, then click *Add*. The Sites, Departments or Locations window will open.

A site, department or location will not be listed in the side navigation bar until a unit has been associated with it.

To delete a site, department or location:

1. Click the *Units* tab.

2. To delete a site click *Sites* in the top navigation bar. The Sites window will open.

To delete a department, click *Departments* in the top navigation bar. The Departments window will open.

To delete a location, click *Locations* in the top navigation bar. The Locations window will open.

3. Click the checkbox to the left of one or more sites/departments/locations. To delete all sites/departments/locations in the page, click the checkbox to the left of Name at the top of the list.
4. Click *Delete*. A confirmation dialog box will appear.
5. Confirm or cancel the deletion.

To change the name of a site, department or location:

1. Click the *Units* tab.

2. To change the name of a site, click *Sites* in the top navigation bar. The Sites window will open.

To change the name of a department, click *Departments* in the top navigation bar. The Departments window will open.

To change the name of a location, click *Locations* in the top navigation bar. The Locations window will open.

3. Click on the name of a site/department/location. The Site/Department/Location Name window will open.
4. Type a new 1-64 character name.
5. Click *Save* and then click *Close*. The Sites, Departments or Locations window will open.

To associate or change the association of an existing unit to a site, department or location:

1. Click the *Units* tab.

2. Click one of the links listed in Table 15.1 in the side navigation bar to display the corresponding window for the units you wish to associate, change or remove the association.

Table 15.1: Links for Managing Sites, Departments or Location Associations

Link	Window	Changes Site Associations For
A link under Target Devices	Target Devices	Target devices only
A link under Appliances	Appliances	Managed appliances only
Sites	Units in Site	Units
Groups	Units in Group	Units
A link under Custom Field	Units in Custom Fields	Units
Recently Accessed	Recently Accessed Units	Units

3. Click on the name of a unit. The Unit Overview window will open.
4. Click *Properties* in the side navigation bar, then click *Location*.
5. From the menus, select the site, department and/or location to associate with the unit. If you do not wish to associate the unit with any site, department or location choose the top (empty) item from the menu.
6. Click *Save* and then click *Close*.

To display the units associated with a site, department or location:

1. Click the *Units* tab.
2. To display units associated with a site, click *Sites* in the side navigation bar. The Units in Site window will open, with a list of units associated with the first alphabetically-listed site.
To display units associated with a department, click *Departments* in the side navigation bar. The Units in Departments window will open, with a list of units associated with the first alphabetically-listed department.
To display units associated with a location, click *Locations* in the side navigation bar. The Units in Location window will open, with a list of units associated with the first alphabetically-listed location.
3. Click on a site, department, location link in the side navigation bar to display another entry in the unit list.

Custom Fields

Ten custom fields are available. To use the custom fields, first change the default labels on the fields (Custom Field 1, Custom Field 2 and Custom Field 3) and then associate a custom label with a unit. The custom fields may be displayed in Units View windows using the Customize link. See *Using the Customize link in windows* on page 28.

To define custom fields:

NOTE: You must have Software Administrator or Appliance Administrator access to define custom fields.

1. Click the *Units* tab.
2. Click *Custom Field Labels* in the side navigation bar. The Unit Custom Field Labels window will open.
3. For each custom field, type the 1-64 character name for the first custom field label. The first and second level custom fields for units will appear under this heading in the side navigation bar; all other custom fields will not appear in the side navigation bar but may be displayed in the content area by clicking *Customize* and adding the field.
4. Click *Save*.

The Custom Field Labels name will continue to appear in the side navigation bar until you associate the custom label with a unit.

To associate a custom label with a unit:

1. In a Units View window (see *Accessing Units View windows* on page 106), click on a unit. The Unit Overview window will open.
2. Click *Properties* in the side navigation bar and then click *Custom Fields*. The Unit Custom Fields window will open.
3. In the each field, type the 1-64 character name to associate with the corresponding label. You may also leave the field blank.
4. Click *Save* and then click *Close*. The Appliance - All window will open. The side navigation bar will include the names of the defined and associated custom fields.

Example: Custom fields

In the following example, a DSView 3 software administrator wants to examine a unit test configuration. The units will be placed in one of two categories: an initial configuration or a final configuration category. The administrator also wants to identify the unit's managers. At the present time, the DSView 3 software administrator has one DSR1021 switch and one EVR1500 environmental monitor to add to the test configuration category and one generic appliance to add to the final configuration category.

1. First, the DSView 3 software administrator will define the custom fields.
 - a. Click the *Units* tab.
 - b. Click *Custom Field Labels* in the side navigation bar. The Unit Custom Field Labels window will open.
 - c. In Label 1, type **Test Configuration**. All first-level custom fields for units will appear under this heading in the side navigation bar.
 - d. In Label 2, type **Appliances and target devices**. All second-level custom fields for units will appear under this heading in the side navigation bar.

- e. In Label 3, type **Manager**. This custom field will not appear in the side navigation bar, but may be displayed in the content area by using the *Customize* link.
 - f. Click *Save* to save the changes.
Custom Field Labels will still appear in the side navigation bar because the administrator has not yet defined any custom fields for the units.
2. A DSR1021 switch has been added to the system, but will need to go into a category named **Initial Configuration**, since it has not yet been verified for the final configuration. The administrator will associate the DSR1021 switch managed by John Smith to the custom fields as follows:
 - a. Click *Appliances* in the side navigation bar. The Appliances - All window will open.
 - b. Click on the DSR1021 switch. The Unit Overview window will open.
 - c. Click *Properties* in the side navigation bar and then click *Custom Fields*. The Unit Custom Fields window will open, including the custom field names defined in step 1.
 - d. In the Test Configuration field, type **Initial Configuration**.
 - e. In the Appliances and target devices field, type **DSR1021 Switches**.
 - f. In the Manager field, type **John Smith**.
 - g. Click *Save* and then click *Close*. The Appliance - All window will open. The side navigation bar will now include Test Configuration instead of Custom Field Labels.
 3. The test configuration will also include an EVR1500 environmental monitor that is managed by Mary Jones. The EVR1500 environmental monitor has also not been verified for the final configuration, so the administrator will include it in the Initial Configuration category.
 - a. In the Appliances - All window, click on the EVR1500 environmental monitor. The Unit Overview window will open.
 - b. Click *Properties* in the side navigation bar and then click *Custom Fields*. The Unit Custom Fields window will open, including the custom field names defined in step 1.
 - c. In the Test Configuration field, type **Initial Configuration**.
 - d. In the Appliances and target devices field, type **EVR1500 Environmental Monitors**.
 - e. In the Manager field, type **Mary Jones**.
 - f. Click *Save* and then click *Close*. The Appliance - All window will open.
 4. The configuration of a generic appliance has been verified, so the administrator wants to create a category named **Final Configuration** that will contain the final test units. The category will contain one generic appliance managed by Tim Brown.
 - a. In the Appliances - All window, click on the generic appliance. The Unit Overview window will open.
 - b. Click *Properties* in the side navigation bar and then click *Custom Fields*. The Unit Custom Fields window will open, including the custom field names you defined in step 1.
 - c. In the Test Configuration field, type **Final Configuration**.
 - d. In the Appliances and target devices field, type **Generic Appliances**.

- e. In the Manager field, type **Tim Brown**.
- f. Click *Save* and then click *Close*. The Appliance - All window will open.

Figure 15.1 indicates how the side navigation bar will appear after the example procedure. Clicking on a custom field link displays the units associated with that custom field.

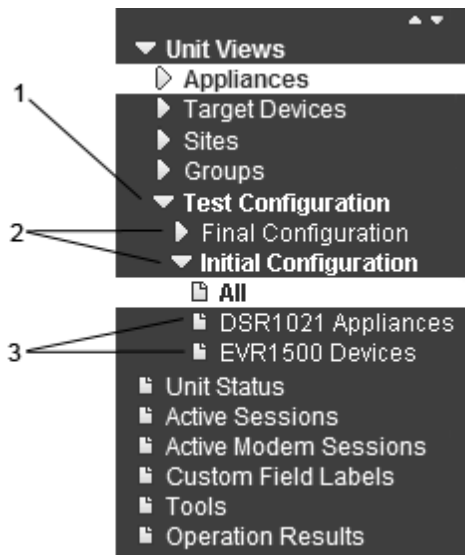

Figure 15.1: Custom Fields Example: Side Navigation Bar

Table 15.2: Custom Fields Example: Side Navigation Bar Descriptions

Number	Description
1	System-wide first-level custom field label
2	Unit first-level custom field labels
3	Unit second-level custom field labels

Unit Groups

Unit groups may be used to organize units. You may create nested unit groups (unit groups within unit groups) to organize units hierarchically. Units may belong to multiple groups. For example, you may have a DSR switch that belongs to two global groups and three personal groups.

There are two types of unit groups: global and personal. A global unit group can be viewed by any user logged into the DSView 3 software. A personal unit group may only be viewed by the person who created it. Up to 32 personal unit groups may be created by a user.

There are two top-level system-defined unit group containers: global root and personal root. These group containers cannot be deleted. They can contain other unit groups, but not individual units. All global unit groups are descendents of global root. All personal unit groups are descendents of personal root.

There is also a system-defined unit group named Unassigned, which is a descendent of the global root. This unit group automatically contains all units that are not assigned to any other global unit groups. This group cannot be deleted, and you cannot add subgroups (children) to the Unassigned unit group.

Global unit groups may only be created, modified or deleted by users with DSView 3 software administrator, user administrator or appliance administrator privileges. The global root, personal root and unassigned unit groups cannot be deleted.

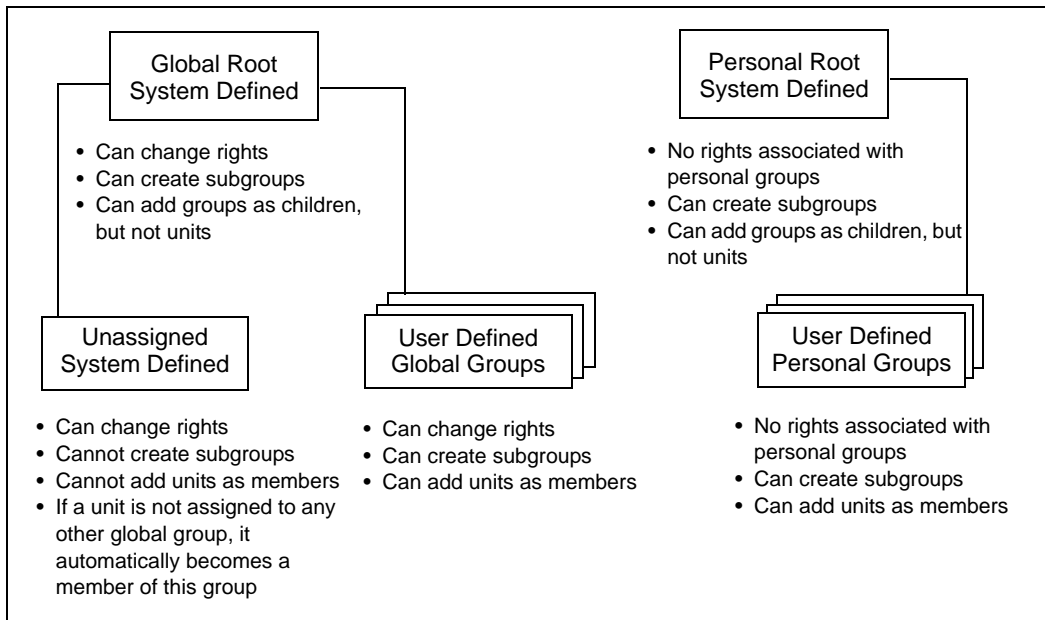

Figure 15.2: Unit Groups Structure

Table 15.3: Unit Groups Features

Group Type	Can change rights?	Can have subgroups?	Can add units as members?
System Defined			
Global Root	Yes	Yes	No, can only add groups
Unassigned	Yes	No	No
Personal Root	No	Yes	No, can only add groups

Table 15.3: Unit Groups Features

Group Type	Can change rights?	Can have subgroups?	Can add units as members?
User Defined			
Global Groups	Yes	Yes	Yes
Personal Groups	No	Yes	Yes

Unit group hierarchy

There are two primary ways to view unit groups:

- Unit Groups window - clicking the *Units* tab and then *Groups* in the top navigation bar
- Units View Groups window - clicking the *Units* tab and then *Groups* in the side navigation bar

Global groups that contain units the user cannot access will not be displayed, unless there are descendent groups containing units the user is allowed to access.

All personal unit groups are displayed in the Unit Groups window, even if they do not contain any units. In Units View Groups windows, groups will not be listed unless they have assigned units.

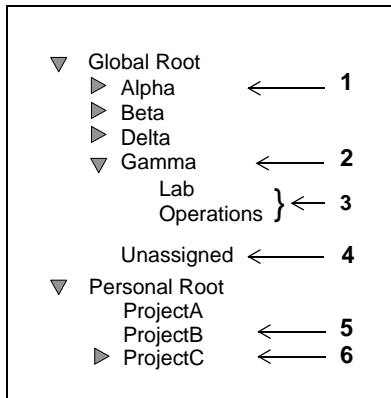

Figure 15.3: Unit Group Hierarchy Example

Table 15.4: Unit Group Hierarchy Example Descriptions

Number	Description	Number	Description
1	Global unit group Alpha has one or more subgroups	4	Global unit group Unassigned has all units that are not assigned to a group; it cannot have subgroups
2	Global Unit group Gamma has two subgroups	5	Personal unit group ProjectB has no subgroups

Table 15.4: Unit Group Hierarchy Example Descriptions

Number	Description	Number	Description
3	These unit groups do not have subgroups (in a Units view Group window, a document icon will appear to the left)	6	Personal unit group ProjectC has one or more subgroups

In the example, four unit groups have been created in the global root group, and each of those four unit groups contain groups. The unit group Gamma has been selected, and indicates it has two subgroups, Lab and Operations. The Unassigned global group will contain any units that are not assigned to another global unit group.

Three personal unit groups have been created. The ProjectA and ProjectB unit groups do not have subgroups. The ProjectC unit group has one or more subgroups.

To display a list of unit groups in the Unit Groups window:

1. Click the *Units* tab.
2. Click *Groups* in the top navigation bar. The Unit Groups window will open. If a unit group has subgroups (children), an arrow will be displayed next to its name.
 - To display a list of groups in the global root group, click *Global Root*. The first global unit group listed will automatically be selected. Click on the arrow next to a group to expand it and display subgroup names.
 - To display a list of groups in the personal root group, click *Personal Root*. The first personal unit group listed will automatically be selected. Click on the arrow next to a group to expand it and display subgroup names.

You may customize the number of items per page that appear in this window; see *Using the Customize link in windows* on page 28.

To display a list of unit groups in a Units View window:

NOTE: When you create a unit group, you may indicate whether it (and any of its child unit groups) will be displayed in the side navigation bar.

1. Click the *Units* tab.
2. Click *Groups* in the side navigation bar. The Groups - Global Root window will open.
 - If a unit group has subgroups (children), an arrow will be displayed next to its name. When a selected group has subgroups, the window will display either the immediate children of the unit group or all descendents of the unit group, depending on the Show group descendants setting.
 - If a unit group does not have subgroups, a document icon will be displayed next to its name in the side navigation bar.

When you click on a unit group in the side navigation bar that has a document icon (that is, it has no subgroups), a window will open, listing the units in the group. This window can include the same fields as other Units View windows; see *Units View windows fields* on page 107. You may enable or disable a field display using the Customize link. See *Using the Customize link in windows* on page 28.

When you customize this window, you may also enable/disable the display of descendants. When enabled and a unit group is selected in a side navigation bar, the window will display all descendants of the group. When disabled, only the immediate children of the selected group will be displayed.

To display information about a unit group:

1. Click the *Units* tab.
2. Click *Groups* in the top navigation bar.
3. Click the group container or the parent group of the unit group you want to display information about.
4. Click on the unit group name.
5. The side navigation bar will contain information links about the selected unit group.
 - Click *Name* in the side navigation bar to display the unit group name.
 - Click *Members* in the side navigation bar to display the unit group members.
 - Click *Groups* to display a list of groups that are members of the unit group.
 - Click *Units* to display a list of units that are members of the unit group.
 - Click *Access Rights* in the side navigation bar to display the unit group access rights.
6. Click *Close*.

Adding or deleting a unit group

To add a unit group:

1. Click the *Units* tab.
2. Click *Groups* in the top navigation bar. The Unit Groups window will open.
3. Click the checkbox next to the group container (Global Root or Personal Root) or the group name that you want to be the parent of the new unit group.
4. Click *Add*. The Add Unit Group window will open.
5. Type a 1-64 character name for the unit group. The name must be unique within the parent group. For example, two groups can be named “development” but they cannot both be members of the unit group “Huntsville.” (This unique name restriction does not apply to personal unit groups that are owned by different users.)
6. If you do not want the unit group (or any of its child unit groups) to appear in the side navigation bar, enable the *Do not display this unit group nor any child unit groups as unit views* checkbox.

7. If you do not want the units in the unit group to belong to any other unit group, select *Exclusive*.
 8. If you want to add another unit group in the same hierarchy, click *Add/New*. The Add Unit Group window opens.
- or-
- If you do not want to add another group, click *Add/Close*. The Unit Groups window opens.

To delete a unit group:

NOTE: Deleting a unit group deletes the group only; the units still exist in the DSView 3 software system. You cannot delete any system-defined unit groups (global root, personal root and unassigned.)

1. Click the *Units* tab.
2. Click *Groups* in the top navigation bar. The Unit Groups window will open.
3. Click the checkbox next to the unit group to be deleted.
4. Click *Delete*. A confirmation dialog box will appear.
5. Confirm or cancel the deletion.

Changing the unit group properties

Access rights indicate which users and user groups may access units in the DSView 3 software system. Access rights also indicate which actions are allowed. See *About Access Rights* on page 144. You can assign access rights from a unit group perspective, as described in this section. Using this method, selected users and members of selected user groups are allowed or prohibited from initiating certain actions on all units in the unit group.

Access rights for a unit group default to inherit if they are not explicitly granted to a user or user group. For example, if you create unit group A and subgroup B, by default any access rights you assign to group A will be propagated to group B.

There are other ways to assign access rights; see *How access rights can be assigned* on page 145.

To change unit group properties:

1. Click the *Units* tab.
2. Click *Groups* in the top navigation bar. The Unit Groups window will open.
3. Click on the name of a unit group. The Unit Group Name window will open.
4. Type a new 1-64 character name in the Group field. The name must be unique within the parent group. For example, two groups can be named “development” but they cannot both be members of the unit group “Huntsville.” (This unique name restriction does not apply to personal unit groups that are owned by different users.)
5. If you do not want the unit group (or any of its child unit groups) to appear in the side navigation bar, enable the *Do not display this unit group nor any child unit groups as unit views* checkbox.

6. If you do not want the units in the unit group to belong to any other unit group, select *Exclusive*.
7. Click *Save* and then click *Close*.

To add or remove members in a unit group:

NOTE: Removing a unit group or unit member from a unit group does not delete the group/unit from the DSView 3 software system or any other group to which it belongs.

1. Click the *Units* tab.
2. Click *Groups* in the top navigation bar. The Unit Groups window will open.
3. To add or remove a group member of the unit group, click *Members* in the side navigation bar and then click *Groups*.

To add or remove a unit member of the unit group, click *Members* in the side navigation bar, and then click *Units*.

NOTE: If you select a group container (Global Root or Personal Root), you can only add unit groups as members - you cannot add units; therefore, when you click *Members* in the side navigation bar, *Groups* is the only choice. You cannot add units or groups to the global unassigned unit group.

4. The Unit Group Members (Units) or Unit Group Members (Groups) window will open. Click *Assign*.
5. The Assign Units to Unit Group window will open.

NOTE: Once a unit is added to an exclusive unit group, it cannot be added to any other groups. If a unit is already a member of a non-exclusive group and is then added to an exclusive group, the unit is automatically removed from the non-exclusive group.

- To add one or more units to the unit group, select the unit(s) from the Available Units list, then click *Add*. The units will be moved to the Units to Assign list.
 - To remove one or more units already assigned to the unit group, select the unit(s) from the Units to Assign list, then click *Remove*. The units will be moved to the Available Units list.
6. Click *Save* and then click *Close*. The Unit Group Members window will open.
 7. Click *Close*. The Unit Groups window will open.

To add or remove access rights for one or more unit groups:

1. Click the *Units* tab.
2. Click *Groups* in the top navigation bar. The Unit Groups window will open.
3. Click the checkbox to the left of one or more unit groups, then click *Rights*. The Unit Group Access Rights window will open.

If you are setting access rights for one unit group, you may click on the unit group name, then click *Access Rights* in the side navigation bar to access the Unit Group Access Rights window.

4. To add or remove a user or user group from the User and User Groups list:

- a. Click *Edit List*. The Unit Access Rights User Selection window will open.
 - To add one or more users or user groups, select the user(s) or user group(s) from the Available list, then click *Add*. The users and/or user groups will be moved to the List to Update list.
 - To remove one or more users or user groups, select the user(s) or user group(s) from the List to Update list, then click *Remove*. The users and user groups will be moved to the Available list. (Inherited users and user groups can only be removed from the first unit group that specified any access rights other than inherit.)
 - b. Click *OK*. The Unit Access Rights window will display the current list of users and/or user groups. When a user or user group is added to the list, the default access rights will be displayed.
5. To set access rights, select a user or user group from the User and User Groups list, then enable or disable a checkbox in the Access Rights table for each access right.
- Allow - the access right is allowed for the user/user group.
 - Deny - the access right is denied for the user/user group.
 - Inherit - the access right is inherited from the unit group(s) to which the selected user/user group belongs. When Inherit is selected, the Allow and Deny checkboxes will become gray and unchangeable, and indicate the inherited value. If the inherited settings indicated both Allow and Deny, the inherited value is Deny, which takes precedence.
- To disable the inherit functionality, uncheck the Inherit checkbox.
- If none of the checkboxes are checked, the access right is neither allowed nor denied.
- If the unit group contains both appliances and target devices, all rights will be displayed and may be enabled, even though they may not necessarily be valid for the unit.
6. Repeat the preceding steps to change access rights for other users or user groups.
 7. Click *Save* and then click *Close*. If a connection or power control action is enabled, the appropriate link will appear in the Action column of Units Views windows containing that group or units in that group.

DS Zones provide virtual segregation of data center resources, including appliances, target devices and virtual machines. Each zone operates as an independent subset of the DSView 3 software system, and units can be transferred to different zones. Users belong to a single zone, but may switch to other zones if they have access rights. You can restrict a user's access to a zone, preventing the user from viewing or accessing other zone's resources, or you can grant a user access to multiple zones. To prevent one zone from starving another of licenses, manage the distribution of licenses and add-on features by assigning a number of licenses to each zone.

Managing and Accessing Zones

Enabling DS Zones

Before you can create or access zones, you must add a DS Zones license key to the DSView 3 software (see *Adding a new license key* on page 56). The license key specifies the number of zones that can exist in the DSView 3 software. This number cannot be exceeded; if you need additional zones, you must purchase another license key or delete existing zones to free licenses.

NOTE: If you do not have a DS Zones license enabled, the DSView 3 software does not display any windows or links related to zones.

Creating zones

Once the DS Zones license key is enabled, the DSView 3 software automatically includes a top level zone. You can create up to two sublevels of zones below the top level zone, but you cannot create additional top level zones. You can create as many individual zones as your license key allows.

To create a new zone:

1. Click the *System* tab, then click *Zones*. The *Zones* window opens and lists any previously created zones.
2. Select the checkbox next to the zone to which you want to add a sublevel zone. Click *Add*. The *Add Zone Wizard* opens.
3. Enter a unique zone name. Click *Next*.

4. The Assign Zone Licenses window opens. For each license type, enter the number of licenses that can be used by this zone in the Assigned Licenses field. The number of available licenses is listed in the Available Licenses column. For details on zone licenses, see *Assigning zone licenses* on page 222.
5. Click *Next*.
6. The Assign Zone Rights window opens. For each access rights group, select *Allow* or *Deny*. For details on zone rights, see *Managing zone access rights* on page 222.
7. Click *Next*.
8. The *Completed Successful* window opens. Click *Finish*.

Accessing zones

When logging into the DSView 3 software, specify the highest level zone for which you have access rights. If your access rights include other zones, you may switch to those zones once logged in.

When in a zone, you cannot view or access units that belong to another zone. The zone you are currently in is referred to as the active zone and is displayed in the top option bar.

To specify zone log in options:

1. Click the *System* tab, then click *Global Properties*.
2. Select *Zones* in the side navigation bar.
3. Select *List all Zones as drop-down menu* to allow the user to select a zone from a list.
-or-
Select *Request the Zone as text field* to require the user to type the zone name in text field when logging in.
4. Click *Save*.

To log in to a zone:

1. Enter the URL of the DSView 3 server host in the address bar of a web browser.
2. Enter a valid username and password in the fields provided.
3. Specify the highest level zone for which you have access rights by typing the zone in the Zone field.
-or-
Specify the highest level zone for which you have access rights by selecting a zone name from the Zone menu.

NOTE: If you do not specify a zone, DSView 3 software attempts to log you in to the top level zone. If you do not have access rights to the top level zone, the login attempt fails.

4. Click *Login*.

To switch zones:

Click the *System* tab, then click *Zones*. The *Zones* window opens and lists all created zones. Select the checkbox next to the zone to which you want to switch and click *Switch*.

-or-

In the top left corner of the window, your username and the active zone list is displayed. Click the name of the zone to open a pop-up menu, then select the zone to which you want to switch.

Transferring units to a zone

You can transfer managed appliances, blade chassis, hypervisor managers or hypervisor servers to zones for which you have access rights. All associated target devices are transferred with the unit, and any merged target device connections are split. You cannot independently move a target device.

NOTE: If you are transferring units that require licenses, such as a VMware ESX Server, the zone to which you are moving the units must be assigned the appropriate licenses (see *Assigning zone licenses* on page 222). If the zone does not have sufficient licenses, the transfer fails.

1. In a *Units View* window (see *Accessing Units View windows* on page 106), click the checkbox next to the unit(s) you wish to move.
2. Click *Operations*, then select *Move Units to Zone* from the drop-down menu. The *Move Units Wizard* opens.
3. From the list provided, select the zone to which you wish to move the unit(s). Click *Next*.
4. The *Completed Successful* window opens. Click *Finish*.

You can access the units and associated target devices when you are active in the zone that owns the units.

Managing zone properties

Once you have created a zone, you can modify the zone name, license distribution and access rights.

To modify the zone name:

1. Click the *System* tab, then click *Global Properties*.
2. Select *Zones* in the side navigation bar.
3. Click the name of zone you wish to modify.
4. Click *Name* in the side navigation bar.
5. Enter a unique zone name in the field. The current zone path in relation to higher level zones is displayed.
6. Click *Save*.

Assigning zone licenses

You can manage the distribution of licenses among zones. Assigning licenses to each zone prevents one zone from starving other zones of licenses. You can control which add-on features a zone may use, how many licenses of each feature a zone may use, and how many sublevel zones can be created.

You must specify at least one client session license for each zone, including the top level zone; for other license types, you may specify an assigned license value of zero. The number of licenses assigned to one zone cannot exceed the number of licenses assigned to the parent zone. In addition, the total number of assigned licenses for all zones cannot exceed the number of licenses in the DSView 3 software system.

NOTE: For more information on what operations each license type allows, see *Licenses* on page 54.

To assign zone licenses:

1. Click the *System* tab, then click *Global Properties*.
2. Select *Zones* in the side navigation bar.
3. Click the name of zone you wish to modify.
4. Click *Licenses* in the side navigation bar.
5. The Assign Zone Licenses window opens. For each license type, enter the number of licenses that can be used by this zone in the Assigned Licenses field. The number of available licenses in the zone is listed in the Available Licenses column.
6. Click *Save*.

Managing zone access rights

When operating a DSView 3 software system with zones, there are multiple layers of access rights to consider.

First, you can allow or deny access rights per zone. If you deny an access right group for a zone, no users in that zone, including administrative users, can perform the associated actions. In addition, a user cannot create a sublevel zone with access rights that were denied in the parent zone. If you allow an access right group for a zone, specified users in this zone and sublevel zones can perform the associated actions.

The next layers of access rights are user groups and users. Within a zone, you can assign specific access rights to user groups. For example, for a zone with Firmware Management allowed, you could choose to only allow the administrative user group to manage firmware, and prevent other user groups from managing firmware by restricting the group access rights. To further control user access rights, you can also assign access rights to individual users.

An administrative user in the top level zone is considered a super user and can manage access rights for any user in any zone. Administrative users in sublevel zones with appropriate access rights can manage user access rights for their zone and other zones for which they have access.

When enabled for a zone, these access right groups permit qualified users to perform the following actions:

- Zone Management - Create zones and modify zone properties from the System - Zones window. Users with access rights can also switch to other zones.
- User and User Groups Management - Add or delete users and user groups, and perform other user and user group management operations from the Users tab.
- Unit and Unit Groups Management - Add or delete units and unit groups, and perform other unit and unit group management operations from the Units tab.
- File Management - Add or delete appliance files from the System - Appliance Files window.
- Tasks Management - View, schedule and run tasks from the System - Tasks window.
- Firmware Management - Upgrade appliance firmware.
- System Management - View and modify some system settings.
- Log Viewing - View event logs, data logs and reports under the Reports tab.

To allow or deny access rights for a zone:

1. Click the *System* tab, then click *Global Properties*.
2. Select *Zones* in the side navigation bar.
3. Click the name of zone you wish to modify.
4. Click *Access Rights* in the side navigation bar.
5. The Assign Zone Rights window opens. For each access rights group, select *Allow* or *Deny*.
6. Click *Save*.

Using Zones

Zones operate as independent subsets of the DSView 3 software system. When logged into a zone, most actions only affect your active zone, even if you have access rights to other zones. However, some actions are restricted or are only available to super users (administrative users belonging to the top level zone). All actions require appropriate zone access rights. Users must also be qualified with user and user group access rights. The following sections describe under what circumstances an action may be performed and how it affects the DSView 3 software system.

Units actions in a zone

NOTE: As an exception, a modem is still available to all zones even if it is moved to a sublevel zone.

Table 16.1: Unit Actions in a Zone

Action	User Status Required for Action	Zone(s) Affected
View units	Any qualified user	Active zone only.

Table 16.1: Unit Actions in a Zone (Continued)

Action	User Status Required for Action	Zone(s) Affected
Add or delete units	Any qualified user	Active zone only.
Update unit properties	Any qualified user	Active zone only. NOTE: Appliance IP addresses must be unique across all zones.
Move units to another zone	Any qualified user	To other zones for which he has access rights.
Use unit operations and tools	Any qualified user	Active zone only. NOTE: If the operation or tool involves multiple units, all units must be in the same zone.
View unit groups	Any qualified user	Active zone only.
Add unit groups	Any qualified user	Active zone only. NOTE: The user group name must be unique within the active zone, but can be duplicated in other zones. When a zone is created, three groups are automatically created: global root, unassigned and personal root.
Delete unit groups	Any qualified user	Active zone only. NOTE: The global root, unassigned and personal root groups cannot be deleted.
Assign units to unit groups	Any qualified user	Active zone only.
Add or remove sites, departments or locations	Any qualified user	Active zone only. NOTE: The site, department or location name must be unique within the active zone, but can be duplicated in other zones. If a unit is moved to another zone, any associated sites, departments or locations are deleted.
Import or export units, unit groups, users, user groups and associated relationships	Any qualified user	To or from the active zone only.

User actions in a zone

Table 16.2: User Actions in a Zone

Action	User Status Required for Action	Zone(s) Affected
View user accounts	Any qualified user	Active zone only.
Add or delete users	Any qualified user	Active zone only. NOTE: When adding a user, the username must be unique within the active zone, but can be duplicated in other zones. When using the Add User Wizard, only authentication services and groups that belong to the active zone can be selected.
Move users or user groups to a zone	Not permitted for any user	Users and user groups cannot be moved user to another zone. NOTE: A user or user group is permanently owned by the zone that was active when the user was added, but a user can visit (switch to) other zones. If necessary, you can delete a user or user group from its zone and recreate it in another zone.
View user groups	Any qualified user	Active zone only.
Add or delete user groups	Any qualified user NOTE: Built-in user groups cannot be deleted.	Active zone only. NOTE: The user group name must be unique within the active zone, but can be duplicated in other zones. When using the Add User Group Wizard, only authentication services that belong to the active zone can be selected.
View or export authentication services	Any qualified user	Active zone only.

Table 16.2: User Actions in a Zone (Continued)

Action	User Status Required for Action	Zone(s) Affected
Add authentication services	Any qualified user	Active zone only. NOTE: The same authentication service cannot be reused in multiple zones. The authentication service must be added to each zone where it will be used. As a result, virtual users may end up in multiple zones, but each instance of the user in a zone is treated as unique user in the DSView 3 software system.
Move authentication services	Not permitted for any user	An authentication service cannot be moved to another zone. NOTE: An authentication service is permanently owned by the zone that was active when the authentication services was added. If necessary, you can delete an authentication service from its zone and recreate it in another zone
Assign unit access rights to users	Any qualified user	Active zone only. Both the user and unit must belong to the active zone.
Assign users to groups	Any qualified user	Active zone only. Both the user and group must belong to the active zone.
View effective rights for users	Any qualified user	Active zone only.

Reports, events and data logging actions in a zone

Table 16.3: Reports, Events and Data Logging Actions in a Zone

Action	User Status Required for Action	Zone(s) Affected
View system logs and events	Any qualified user	For all zones for which he has access rights.
View or export data logs	Any qualified user	Active zone only.
View and modify email notifications	Any qualified user	Active zone only.
Modify log retention	Super users only	All zones.
Modify events	Super users only	All zones.
View usage and asset reports	Any qualified user	Active zone only.

Modifying system settings in a zone

Table 16.4: Modifying System Settings in a Zone

Action	User Status Required for Action	Zone(s) Affected
Modify DSView 3 server settings	Super users only	All zones.
Modify global properties	Super users only	All zones.
Back up the DSView 3 server database and system files	Super users only	All zones.
Schedule power control	Any qualified user	All zones.
Export event log	Any qualified user	Active zone only.
Migrate units	Any qualified user	Active zone only.
Pull names from selected units	Any qualified user	Active zone only.
Test modem connection	Any qualified user	All zones.
Update topology	Any qualified user	Active zone only.
Upgrade firmware	Any qualified user	Active zone only.
Validate external authentication services user accounts	Any qualified user	Active zone only.
View appliance files	Any qualified user	Active zone only.
Manage plug-ins	Super users only	All zones.
Configure SNMP trap settings	Any qualified user	Active zone only.
Import system settings	Super users only	To the top level zone only. The top level zone must be active at the time of import.

Managing User Accounts

The DSView 3 software allows you to:

- Add, change and delete user accounts
- Unlock user accounts
- Specify user account restrictions
- Change user group membership
- Display user and user group access rights to target devices and managed appliances
- Add and delete user-defined user groups
- Display, assign and remove user group members from built-in or user-defined user groups

User Accounts Windows

User accounts are displayed and managed through User Accounts windows.

To display the User Accounts window:

1. Click the *Users* tab. The User Accounts - All window will open.
2. To display the names of users in a built-in or user-defined user group, click the group name link under User Accounts in the side navigation bar. The User Accounts window for that group will open, listing all the users in the group.
3. To select a user, click on a username in a User Accounts window.

Customizing the User Accounts window

The User Name field is usually displayed in the User Accounts window. One of the icons in Table 17.1 will appear to the left of the usernames and represent the status of each DSView 3 software user.

Table 17.1: User Status Icons

Icon	Authentication Method	Status
Face	All	Enabled - The user can log in and use the DSView 3 software.

Table 17.1: User Status Icons (Continued)

Icon	Authentication Method	Status
Face with a red X	Internal	Disabled - The user cannot log in to the DSView 3 software. See <i>User account restrictions and expiration settings</i> on page 236.
Padlock	Internal	Locked - The user account has been locked; the user cannot log in to the DSView 3 software because the maximum number of log in failures has been exceeded. See <i>Authentication Services</i> on page 79 and <i>Unlocking User Accounts</i> on page 233.
Question mark	External	Suspicious - The user account exists, but the external authentication server no longer contains the account.
Face with a clock	All	Expired - The user account is configured with an expiration date, which has passed. Expired user accounts remain in the system until deleted. See <i>User account restrictions and expiration settings</i> on page 236.

The following fields may be displayed in the User Accounts window. Use the Customize link to add or remove fields in the display. See *Using the Customize link in windows* on page 28.

- Full Name - Another name for a user. For example, a user may have a username of Sunrise1 and a full name defined as Mary Jones. See *Username* on page 234.
- Status - User account status: Enabled, Disabled, Locked, Suspicious or Expired. One of the user status icons in Table 17.1 will appear to the left of the username.
- Preemption Level - Effective preemption level of a user. See *Preemption Levels* on page 41. When a User Accounts window contains this column or a Group Preemption Level column, values are not displayed for external users (users validated with external authentication services). To display an external user's effective and group preemption level, select the user's name and then click *Preemption Levels* in the side navigation bar.
- Authentication Server - Name of the internal or external authentication server. See *Authentication Services* on page 79.
- Business Address - Business address defined in the user's properties. See *Address* on page 237.
- Business Mobile - Business mobile phone number defined in the user's properties. See *Phone contact* on page 238.
- Business Phone - Business phone number defined in the user's properties. See *Phone contact* on page 238.
- Default E-Mail - Default email account defined in the user's properties. See *Email contact* on page 238.
- E-Mail 1-E-Mail 5 - Up to five additional email accounts defined in the user's properties. See *Email contact* on page 238.

- Custom Field 1- Custom Field 6 - Custom fields for the user. If you have specified text for a custom field, that text will display when you display the field. See *Custom field properties* on page 239.
- Group Preemption Level - Highest preemption level of all groups to which the user belongs. For example, if a user belongs to appliance administrators (with a group preemption level of 3) and auditors (with a group preemption level of 1), this field will display 3. See *Preemption Levels* on page 41.

When a User Accounts window contains this column or a Preemption Level column, values are not displayed for external users (users validated with external authentication services). You may display an external user's effective and group preemption level by selecting the user's name and then clicking *Preemption Levels* in the side navigation bar.

- Home Address - Home address defined in the user's properties. See *Address* on page 237.
- Home Phone - Home phone number defined in the user's properties. See *Phone contact* on page 238.
- Mobile Phone - Mobile phone number defined in the user's properties. See *Phone contact* on page 238.
- Pager - Pager number defined in the user's properties. See *Phone contact* on page 238.
- User Preemption Level - User preemption level defined in the user's properties. See *Preemption Levels* on page 41 and *Preemption level* on page 237.

Adding User Accounts

The following information is configured when a user account is created:

- Whether the user will be authenticated using the DSView 3 software internal authentication or an external authentication server. See *Authentication Services* on page 79.
- The user groups in which the user will be included. Each user group contains specific access rights that allow a user to perform specific actions. See *User Groups* on page 241.
- The preemption level for interrupting or disconnecting serial or KVM sessions. See *Preemption Levels* on page 41.

You must have DSView 3 software administrator or user administrator rights to add a user.

To add a user account:

1. Click the *Users* tab.
2. Click *Add*. The Add User Account Wizard will appear.
3. The Select Authentication Service window will open. This window lists the DSView 3 software internal service and all the external authentication services that have been added, which may be used to authenticate users when they log in. See *Authentication Services* on page 79.

Select an authentication service and then click *Next*.

- If you selected *DSView Internal*, go to step 4.

- If you selected any other authentication service, go to step 5.
4. The Type in User Credentials window will open.
 - a. Type a username, password and confirm the password of the user you are adding.

Username may contain up to 256 non-case sensitive characters (if a RADIUS external authentication service will be used, the limit is 253 characters). Usernames are case-preserving. For example, if an account named JDoe is created, it will be saved as JDoe in the DSView 3 server, but a user may log in as JDoe, jdoe, JDOe and so on.

Passwords may contain 3-64 characters. Passwords will never expire unless *User must change password at next login* is selected in the Unit Password window, or Passwords Expire information is specified in the Authentication Service User Account Policies window. A DSView 3 software administrator may specify a different minimum character length and change expiration criteria. See *Authentication Services* on page 79.
 - b. To enable users to set their own passwords when they log in to the DSView 3 software, click *User must change password at next login*.
 - c. To designate the account as a service account, select the *Service Account* checkbox. A service account cannot be used to log in to the DSView 3 software. A service account can be used to impersonate another user over the Web Services API or GUI Access API. For more information, see the DSView 3 software SDK online help.

NOTE: A service account may only be created if you selected the DSView 3 software internal authentication service in step 3.

- d. Click *Next*. Go to step 6.
5. The Specify User Name window will open.

If you selected RADIUS, TACACS+ or RSA SecurID in step 3:

 - a. Enable the *Specify user on external authentication service* radio button.
 - b. Type the username that is configured on the RADIUS, TACACS+ or RSA SecurID server.
 - c. Click *Next*.

If you selected any other type of external authentication service in step 3, you may either specify the username or find the user on the external authentication service.

- To specify the user, enable the *Specify user on external authentication service* radio button and type the name of the user. Then click *Next*.

Usernames may contain up to 256 characters. Usernames may or may not be case sensitive, depending on the requirements of the external authentication server.

- To find the user, enable the *Find user on external authentication service* radio button. The Select User from External Authentication Service window will open.

If the list of users contains more than 5000 entries, a message will indicate that not all items are displayed. You may filter the list by using the Filter button and the adjacent text field. Specifying a username in the text field will return all valid matches. If filtering on

another item (such as full name), you must include a wildcard. See *Filtering information in a window* on page 26.

Select one or more users from the list, then click *Next*.

6. Assign the user to user groups from the Available Groups list, which includes all built-in and user-defined groups. Select one or more groups and click *Add*. The group names will move to the Member Of list, and the new user(s) will be added to those groups. Click *Next*.
7. From the Preemption Levels menu, select a preemption level from 1-4; the higher the number, the higher the preemption level. See *Preemption Levels* on page 41.
8. Click *Finish*. The user(s) have been added.

The DSView 3 software obtains external group membership and external user information when a user logs in. If a user's group membership changes or the user is deleted externally, the DSView 3 software will not see those changes until the next time that user logs in.

Deleting User Accounts

To delete one or more user accounts:

1. Click the *Users* tab.
2. Click the checkbox to the left of the username(s). To delete all users on the page, click the checkbox to the left of User Name at the top of the list.
3. Click *Delete*. A confirmation dialog box will appear.
4. Confirm or cancel the deletion.

Unlocking User Accounts

If lock-out settings have been specified for the DSView 3 internal authentication service and a user exceeds these settings, the user will not be allowed to attempt another log in until a certain amount of time has passed. Users that have been locked out will appear with a lock next to their name in the User Accounts window and *Locked* will appear in the Status column.

User administrators or administrators may manually unlock the user accounts.

To unlock one or more user accounts:

1. Click the *Users* tab.
2. In a User Accounts window, click the checkbox to the left of the username(s).
3. Click *Unlock*.

Resetting a User Account Password

A DSView 3 software administrator or user administrator may reset a user's password. When a password is reset, the user will be required to login by typing **password** as their password, then

enter and verify a new password for their account the next time they start a new DSView 3 software session.

To reset a user account password:

1. Click the *Users* tab.
2. Click the checkbox to the left of the user(s) to reset the password.
3. Click *Reset Password*. A confirmation dialog box will appear.
4. Confirm or cancel the reset.

Changing User Account Properties

If you have DSView 3 software administrator or user administrator privileges, you may change the following account properties for a user:

- The user (login) name and full name
- The certificate associated with the user
- The SSH key associated with the user
- Login password
- Account login restrictions and expiration settings
- The user groups to which the user is assigned
- User preemption levels
- Home and business addresses
- Home, business, mobile and pager phone numbers
- Primary email address and up to five additional email addresses
- Notes you wish to add about the user
- Up to six custom fields

Some properties may be changed only if the user account will be using the DSView 3 software internal authentication service. See *Authentication Services* on page 79.

Username

The username information that you may specify for a user includes:

- User Name - The name that the DSView 3 software uses to log in and identify the user.
- Full Name - The actual name of the user.

For example, you may use Engr10 as the username and Jonathan Z. Smith as the full name to identify the person associated with the username.

To change the name of a user:

1. Click the *Users* tab.
2. Click on a username. The User Name window will open.

3. Type the username for the user.
4. Type the full name of the user.
5. Click *Save* and then click *Close*.

User certificates

Certificates may be changed only for internal authentication users. If the system certificate policy is enabled for user certificates (see *System certificate policy and trust store* on page 47), the user certificate used at login must meet the policy requirements.

As an alternative to using this method, the user may change the certificate in the profile settings, but only if the administrator has enabled a global setting to allow it. See *Specifying a user certificate* on page 38.

To change the certificate associated with a user:

1. Click the *Users* tab.
2. Click on a username. The User Name window will open.
3. Click *Credentials* in the side navigation bar and then click *Certificate*. The User Certificate window will open. If a certificate has failed a test required in the system certificate policy, the failure information is displayed.
4. Type the path and name of the certificate or browse to the certificate location.
5. Click *Save* and then click *Close*.

User SSH key

A configurable SSH key may be used by a serial console appliance to authenticate a DSView 3 software user who is using an out of band client (for example, someone using a PuTTY SSH client that was not started by the DSView 3 software). The user supplies the public/private SSH key when connecting to the serial console appliance (only RSA keys with a maximum length of 1024 bits are allowed). The appliance then verifies the public key against the one stored for the user in the DSView 3 software.

As an alternative to using this method, the user may specify the SSH key in the profile settings, but only if the administrator has enabled a global setting to allow it. See *Specifying an SSH key* on page 39.

To specify a user SSH key:

1. Click the *Users* tab.
2. Click on a username. The User Name window will open.
3. Click *Credentials* in the side navigation bar and then click *SSH Key*. The User SSH Key window will open.
4. Type the 1-256 character name of the file containing the public SSH key that was generated by a third party key generator or browse to the file location.

5. Click *Save* and then click *Close*. The SSH key file will be uploaded to the DSView 3 server for use in authenticating the user.

User password

A user's password may be changed or you may specify that a user must enter a new password during the next login. The password may be changed only for internal authentication users.

To change a user password or force a new password:

1. Click the *Users* tab.
2. In a User Accounts window, click on a username. The User Name window will open.
3. Click *Password* in the side navigation bar. The User Password window will open.
4. Type the new password for the user and verify the new password.
5. To force a user to define a new password during the next login, enable the *User must change password at next login* checkbox.
6. Click *Save* and then click *Close*.

User account restrictions and expiration settings

Account restriction and expiration settings may be changed only for internal authentication users.

To change user account restrictions and expiration settings:

1. Click the *Users* tab.
2. Click on a username. The User Name window will open.
3. Click *Restrictions* in the side navigation bar. The User Account Restrictions window will open.
4. To change account restrictions:
 - To prevent the user from logging into the DSView 3 software, enable the *Disable user account* checkbox. (Users with open sessions will remain logged in.) To re-enable the user account, uncheck the *Disable user account* checkbox.
 - To force a user to define a new password during the next login, enable the *User must change password at next login* checkbox.
 - To prevent the user from changing the password, enable the *User cannot change password* checkbox.
 - To prevent a user's password from expiring, enable the *Password never expires* checkbox.
 - To designate the account as a service account, enable the *Service Account* checkbox. A service account cannot be used to log in to the DSView 3 software. A service account can be used to impersonate another user over the Web Services API or GUI Access API. For more information, see the DSView 3 software SDK online help.

NOTE: A service account may only be created if you are using the DSView 3 software internal authentication service.

5. To change account expiration settings:
 - To indicate no expiration date, enable the *Never* radio button.
 - To specify an expiration date, enable the *End of* radio button. Then click the button to the right of the adjacent field, and a calendar will be displayed. Select the date when the user account will expire.

When a user account expires, it remains in the DSView 3 software system until the account is deleted.
6. Click *Save* and then click *Close*.

User group membership

See *User Groups* on page 241.

To change the group membership of a user:

1. Click the *Users* tab.
2. Click on a username. The User Name window will open.
3. Click *User Groups* in the side navigation bar. The User Group Membership window will open.
4. To add a user to one or more groups, select the group(s) in the Available Groups list, then click *Add*. The columns will be moved to the Member Of list.
5. To remove the user from one or more groups, select the group(s) in the Member Of list, then click *Remove*. The groups will be moved to the Available Groups list.
6. Click *Save* and then click *Close*.

The DSView 3 software obtains external group membership and external user information when a user logs in. If a user's group membership changes or the user is deleted externally, the DSView 3 software will not see those changes until the next time that user logs in.

Preemption level

See *Preemption Levels* on page 41.

To change the preemption level of a user:

1. Click the *Users* tab.
2. Click on a username. The User Name window will open.
3. Click *Preemption Levels* in the side navigation bar. The User Preemption Level window will open.
4. Select a preemption level (1-4) from the menu.
5. Click *Save* and then click *Close*.

Address

The user address may be changed only for internal authentication users.

To specify address information for a user:

1. Click the *Users* tab.
2. Click on a username. The User Name window will open.
3. Click *Addresses* in the side navigation bar. The User Address Properties window will open.
4. Type the home address and business address of the user.
5. Click *Save* and then click *Close*.

Phone contact

The phone contact may be changed only for internal authentication users.

To specify phone contact information for a user:

1. Click the *Users* tab.
2. Click on a username. The User Name window will open.
3. Click *Telephones* in the side navigation bar. The User Telephone Properties window will open.
4. Type the home phone number, business phone number, mobile phone number, mobile business phone number and/or pager number of the user.
5. Click *Save* and then click *Close*.

Email contact

Email contacts may be changed only for internal authentication users.

To specify email contact information for user:

1. Click the *Users* tab.
2. In a User Accounts window, click on a username. The User Name window will open.
3. Click *E-Mail Addresses* in the side navigation bar. The User E-Mail Properties window will open.
4. Type the primary email address of the user and up to five additional email addresses.
5. Click *Save* and then click *Close*.

User notes

User notes may be changed only for internal authentication users.

To specify notes about a user:

1. Click the *Users* tab.
2. Click on a username. The User Name window will open.
3. Click *Notes* in the side navigation bar. The User Notes window will open.
4. Type any information you wish.
5. Click *Save* and then click *Close*.

Custom field properties

You may specify any information you wish in the six custom fields. Custom field properties may be changed only for internal authentication users.

To change the custom fields:

1. Click the *Users* tab.
2. Click on a username.
3. Click *Custom Fields* in the side navigation bar. The User Custom Fields window will open.
4. Type information in the fields.
5. Click *Save* and then click *Close*.

User Access Rights

Access rights indicate whether a user is allowed to perform certain actions on a unit in the DSView 3 software system. See *About Access Rights* on page 144 for detailed information and a list of actions that can be enabled/disabled for target devices and managed appliances.

You may assign access control rights from a user perspective. You select a user account, specify the units for which rights will be assigned, then indicate the permission to perform the action (none, allow, deny or inherit) for each unit. That procedure is described in this section.

There are other ways to assign access rights:

- From a user group perspective - see *User Group Access Rights* on page 246
- From a unit perspective - see *Unit Access Rights* on page 146
- From a unit group perspective - see *Changing the unit group properties* on page 215

To display a user's access rights:

1. Click the *Users* tab.
2. Click on a username. The User Name window will open.
3. Click *Effective Rights* in the side navigation bar and then click *All Units, Target Devices* or *Appliances*. The Target Device Effective Rights or Appliance Effective Rights window will open. Columns indicate the available actions for the unit.
 - Black check mark - The user has been granted access for this right.
 - Gray check mark - A group to which the user belongs has been granted access for this right.
 - Black X - The user has been denied access for this right.
 - Gray X - A group to which the user belongs has been denied access for this right.
 - No check mark - No access has been granted or denied for this right.

The access rights display for a target device may contain information that appears invalid. For example, virtual media access can be enabled to a target device that does not support it.

Similarly, virtual media access to a target device could be enabled but KVM (Video Viewer) access may be disabled. See *About target device access rights* on page 145 for more information.

4. Click *Close* when you are finished reviewing the access rights. The User Accounts window will open.

Customizing Appliance and Target Device Access Rights windows

The Name field is always displayed in the Target Device Access Rights and Appliance Access Rights windows. The action fields may also be displayed (see *About Access Rights* on page 144). Use the Customize link to add or remove fields in the display. See *Using the Customize link in windows* on page 28.

To add or remove access rights through a user account:

1. Click the *Users* tab.
2. Click on a username.
3. Click *Access Rights* in the side navigation bar. The User Access Rights window will open.
4. To add or remove a unit or unit group from the Unit and Unit Groups list, click *Edit List*. The User Access Rights Unit Selection window will open.
 - To add one or more units/unit groups, select the units/groups in the Available list, then click Add. The units/unit groups will be moved to the List to Update list.
 - To remove one or more units/unit groups, select the units/groups in the List to Update list, then click Remove. The units/unit groups will be moved to the Available list. (Inherited users and user groups can only be removed from the first unit group that specified any access rights other than inherit.)
5. Click *OK*. The User Access Rights window will display the current list of units/unit groups.
6. To add/remove access rights for a unit/unit group, select a unit or unit group from the Unit and Unit Groups list, then enable or disable a checkbox in the Access Rights table for each access right.
 - Allow - the access right is allowed for the user.
 - Deny - the access right is denied for the user.
 - Inherit - the access right is inherited from the unit group(s) to which the selected unit/unit group belongs. When *Inherit* is selected, the Allow and Deny checkboxes will become gray and unchangeable, and indicate the inherited value. If the inherited settings indicated both Allow and Deny, the inherited value is Deny, which takes precedence.

To disable the inherit functionality, uncheck the Inherit checkbox.
 - If none of the checkboxes are checked, the access right is neither allowed nor denied.
7. Repeat the preceding step for other units/unit groups.
8. Click *Save* and then click *Close*.

User Groups

Users that have been added to the DSView 3 software system may be added to the following two types of user groups:

- **Built-In** - The DSView 3 management software is delivered with six predefined user groups: Appliance Administrators, Auditors, DSView 3 software administrators, Everyone, User Administrators and Users. All users are automatically included in the Everyone user group when they are added to the DSView 3 software system. Users may be added to any of the other user groups. The privileges that a user has to perform tasks on the DSView 3 software system is dependent on the built-in user group to which the user is a member. See *Built-in User Groups* on page 40.
- **User-defined** - You may also define custom groups, based on any criteria you wish. For example, you may want to define groups based on user administrators with read-only access, software developers at a specific location, global network infrastructure personnel based on job title and so on.

Built-in user groups appear in the User Groups - Built-in window and user-defined user groups appear in the User Groups - User Defined window. The Preemption Level column will indicate the preemption level of each user group. The windows may also display the following fields. Use the Customize link to add or remove fields in the display: See *Using the Customize link in windows* on page 28.

- **Authentication Server** - Name of the authentication server assigned to the user. See *Authentication Services* on page 79.
- **Role** - Role of a user-defined user group, which may be None, User, Auditor, Appliance Administrator, User Administrator or DSView Administrator. The role column for a built-in user group or a user-defined user group with a role of None will be empty.
- **Type** - Type of user group, which will be built-in or user-defined.

To display user groups:

1. Click the *Users* tab.
2. Click *Groups* in the top navigation bar. *Built-In* will automatically be selected in the side navigation bar and the User Groups - Built-in window will open. To display the user-defined groups, click *User-Defined* in the side navigation bar. The User Groups - User Defined window will open.

Group naming in external authentication services

Groups in Active Directory (AD) external authentication services are specified using a combination of their Active Directory folder and group name, minus the group container specified in the DSView 3 software.

The group container defaults to the AD domain root if it is unspecified.

For example, if you have an AD external authentication service for the “sw.eng.mydomain.com” domain with no group container specified, the “Domain Users” group in the “sw.eng.mydomain.com/Users” folder will have a DSView 3 software equivalent of “Users/Domain Users”.

Using the same example, but with a group container of “Users”, the DSView 3 software equivalent is “Domain Users”.

Using the same example, but with a group container of “mydomain.com”, the DSView 3 software equivalent is “eng/sw/Users/Domain Users”.

Groups in LDAP external authentication services are specified using a modified distinguishedName of their LDAP object, minus the group base DN specified in the DSView 3 software.

For example, if you have an LDAP external authentication service with a group base DN of “ou=myldap,c=US”, the “cn=Admin Users,ou=Users,o=myldap,c=US” group will have a DSView 3 software equivalent of “Admin Users”.

Using the same example, but with the “cn=Admin Users,c=Sunrise,ou=Users,o=myldap,c=US” group, the DSView 3 software equivalent is “Sunrise/Admin Users”.

Adding User-defined User Groups

If you are using DSView 3 software internal authentication, you may add your own custom user-defined user groups and then add other users that use DSView 3 internal authentication as members.

External user-defined user groups (on external authentication servers) may be added, but their membership is not controlled by the DSView 3 software.

NOTE: You must have DSView 3 software administrator or user administrator rights to add user-defined user groups.

DSView 3 software internal, RADIUS, LDAP, Windows NT or Active Directory authentication services

To add a user-defined user group:

1. Click the *Users* tab. Click *Groups* in the top navigation bar. Click *User-Defined* in the side navigation bar. The User Groups - User Defined window will open.
2. Click *Add*. The Add User Group wizard will appear.

3. The Select Authentication Service window will open. This window lists all authentication services that may be used to authenticate the user group when the user logs in. See *Authentication Services* on page 79.

Click on the name of an authentication service and then click *Next*.

- If you selected *DSView Internal* as the authentication service, go to step 4.
- If you selected any other type of authentication service, go to step 5.

NOTE: If you are adding a group to the TACACS+ authentication service, see *TACACS+ external authentication services* on page 244 for more information.

4. The Type in Internal Group Name window will open. Type the name for the new user group you wish to create. User-defined user group names may contain up to 256 characters. User-defined user group names are case-preserving. Go to step 6.
5. The Specify External Group window opens. Complete one of the following steps, then click *Next*:

- Click *Specify a group on external authentication service* and type the name of the group in the field.

User group names may contain up to 256 non-case sensitive characters. User group names are case-preserving if the user group on the external authentication server is case sensitive. See *Group naming in external authentication services* on page 242.

- Click *Import the external group - Everyone* to consider any user on the external authentication server as a member of this user group.
- Click *Find a group on external authentication service* to choose from the list of groups on the external authentication service. If the list of groups contains more than 5000 entries, a message will indicate that not all items are displayed.

You may filter the list by using the Filter button and the adjacent text field. If you are using an Active Directory Server, you can choose the filter method.

Click *Filter in DSView 3 Server (legacy)* to use a traditional filtering method; see *Filtering information in a window* on page 26.

-or-

Click *Filter in Active Directory Server* to use a modified filtering method that only provides matches to the filter string based on the common name (CN) of the group. This filter uses LDAP search syntax. This method passes the filter to the AD server allowing the AD server to return the matches, which provides faster results than the legacy filter method.

Select one or more external authentication service groups from the list.

6. Select a role for the user group(s). See *Built-in User Groups* on page 40 for information about user roles.
7. From the Preemption Levels menu, select a preemption level from 1-4; the higher the number, the higher the preemption level. See *Preemption Levels* on page 41.

8. Click *Finish*.

TACACS+ external authentication services

To add a TACACS+ user group:

1. Click the *Users* tab. Click *Groups* in the top navigation bar. Click *User-Defined* in the side navigation bar. The User Groups - User Defined window will open.
2. Click *Add*. The Add User Group wizard will appear.
3. The Select Authentication Service window will open. This window lists all authentication services that may be used to authenticate the user group when the user logs in. Select an appropriate TACACS+ authentication service from the list. Click *Next*.
4. If the TACACS+ service you selected is configured to use the privilege level attribute method, the Specify External Group Name window will open and display a list of privilege levels 0-15 (the higher the number, the higher the level of access).

Select a privilege level from the list. The DSView 3 server will assign a group name based on the privilege level you select. For example, if you choose level 7, the group name will be Privilege Level 7.

Click *Next*.

-or-

If the TACACS+ service you selected is configured to use the group name custom attribute method, the Specify External Group Name window will open and display a Name field. Type the name for the external user group on the external authentication service. The group name must correspond to one of the values configured in the TACACS+ service.

Click *Next*.

5. Select a role for the user group(s), then click *Next*. See *Built-in User Groups* on page 40 for information about user roles.
6. From the Preemption Levels menu, select a preemption level from 1-4; the higher the number, the higher the preemption level. See *Preemption Levels* on page 41.
7. Click *Finish*.

Deleting User-defined User Groups

You may delete any user-defined user groups that have been created in the DSView 3 software system. You must have DSView 3 software administrator or user administrator rights to delete user-defined user groups.

To delete a user-defined user group:

1. Click the *Users* tab. Click *Groups* in the top navigation bar. Click *User-Defined* in the side navigation bar. The User Groups - User Defined window will open.
2. Click the checkbox to the left of the user group(s) to be deleted. To delete all user groups listed in the window, click the checkbox to the left of Name at the top of the list.

3. Click *Delete*. A confirmation dialog box will appear.
4. Confirm or cancel the deletion.

User Group Properties

To display the properties of a built-in user group:

1. Click the *Users* tab. Click *Groups* in the top navigation bar. *Built-In* will automatically be selected in the side navigation bar and the User Groups - Built-in window will open.
2. Click on a user group name. The User Group Properties window will open. The display includes read-only properties for each group: name, type and preemption level.
3. Click *Close* when you are finished. The User Groups - Built-in window will open.

To display or change the properties of a user-defined user group:

1. Click the *Users* tab. Click *Groups* in the top navigation bar. Click *User-Defined* in the side navigation bar. The User Groups - User Defined window will open.
2. Click on a user group name. The User Group Properties window will open.
3. To change the name of the user group, type a new 1-256 character name in the Name field.

NOTE: If the user group belongs to a TACACS+ service that uses the privilege level attribute method, the Name field will be disabled.

4. To change the preemption level, type a number (from 1-4; the higher the number, the higher the preemption level) in the Preemption Level field or select a value from the menu. See *Preemption Levels* on page 41.
5. To change the role of the user group, select a role from the menu. If you do not wish to assign a role to the user group, select *None*.
6. Click *Save* and then click *Close*. The User Groups - User Defined window will open.

Changing User Group Members

When users are created, they may be assigned to one or more built-in or user-defined user groups. You may add or remove users to or from the built-in and user-defined user groups.

To add or remove user group members:

NOTE: Members may only be assigned to or removed from user groups defined on the internal DSView 3 authentication service.

1. Click the *Users* tab.
2. Click *Groups* in the top navigation bar. *Built-In* will automatically be selected in the side navigation bar and the User Groups - Built-in window will open. To display the User Groups - User Defined window, click *User-Defined* in the side navigation bar.
3. Click on a user group name. The User Group Properties window will open.

4. Click *Members* in the side navigation bar. The User Group Members window will open.
5. Click *Assign*. The Assign Users to User Group window will open.
6. To add one or more users to the user group, select the user(s) in the Available Users list, then click *Add*. The users will be moved to the Members list.
7. To remove one or more users from the user group, select the user(s) in the Members list, then click *Remove*. The users will be moved to the Available Users list.
8. Click *Save* and then click *Close*. The User Group Members window will open.
9. Click *Close*. The User Groups - Built-In or User Groups - User Defined window will open (depending on which groups you were working with).

You may also add or remove a user from a built-in or user-defined user group by clicking on a username in a User Accounts window and changing its user group membership. See *Changing User Group Members* on page 245.

User Group Access Rights

Access rights indicate whether a user is allowed to perform certain actions on a unit in the DSView 3 software system. See *About Access Rights* on page 144 for detailed information and a list of actions that are available for target devices and managed appliances.

You may assign access control rights from a user group perspective. You select a user group, specify the units for which rights will be assigned, then indicate the permission to perform the action (none, allow, deny or inherit) for each unit. That procedure is described in this section.

There are other ways to assign access rights:

- From a user perspective - see *User Access Rights* on page 239
- From a unit perspective - see *Unit Access Rights* on page 146
- From a unit group perspective - see *Changing the unit group properties* on page 215

To display user group access rights:

1. Click the *Users* tab.
2. Click *Groups* in the top navigation bar. *Built-In* will automatically be selected in the side navigation bar and the User Groups - Built-in window will open. To display the User Groups - User Defined window, click *User-Defined* in the side navigation bar.
3. Click on a user group name. The User Group Properties window will open.
4. Click *Effective Rights* in the side navigation bar and then click *All Units*, *Target Devices* or *Appliances*. The Target Devices Effective Rights window or Appliance Effective Rights window will open. Columns indicate the available actions for the unit.
 - Black check mark - the user has been granted access for this right
 - Gray check mark - a group to which the user belongs has been granted access for this right
 - Black X - the user has been denied access for this right
 - Gray X - a group to which the user belongs has been denied access for this right

- No check mark - no access has been granted or denied for this right

The access rights display may contain information that appears invalid. For example, virtual media access can be enabled to a target device that does not support it. Similarly, virtual media access could be enabled but KVM (Video Viewer) access may be disabled. See *About target device access rights* on page 145 for an explanation.

5. Click *Close* when you are finished. The User Accounts - All window will open.

To add or remove user group access rights:

1. Click the *Users* tab.
2. Click *Groups* in the top navigation bar.
3. *Built-In* will automatically be selected in the side navigation bar and the User Groups - Built-in window will open. To display the User Groups - User Defined window, click *User-Defined* in the side navigation bar.
4. Click on a user group name.
5. Click *Access Rights* in the side navigation bar. The User Group Access Rights window will open.
6. To add or remove a unit or unit group from the Unit and Unit Groups list, click *Edit List*. The User Group Access Rights Unit Selection window will open.
 - To add one or more units/unit groups, select the units/groups in the Available list, then click Add. The units/unit groups will be moved to the List to Update list.
 - To remove one or more units/unit groups, select the units/groups in the List to Update list, then click Remove. The units/unit groups will be moved to the Available list.
7. Click *OK*. The User Group Access Rights window will display the current list of units/unit groups.
8. To add/remove access rights for a unit/unit group, select a unit or unit group from the Unit and Unit Groups list, then enable or disable a checkbox in the Access Rights table for each access right.
 - Allow - the access right is allowed for members of the user group.
 - Deny - the access right is denied for members of the user group.
 - Inherit - the access right is inherited from the unit group(s) to which the selected unit/unit group belongs. When *Inherit* is selected, the Allow and Deny checkboxes will become gray and unchangeable, and indicate the inherited value. If the inherited settings indicated both Allow and Deny, the inherited value is Deny, which takes precedence.
To disable the inherit functionality, uncheck the Inherit checkbox.
 - If none of the checkboxes are checked, the access right is neither allowed nor denied.
9. Repeat the preceding step for other units/unit groups.
10. Click *Save* and then click *Close*.

Using the Video Viewer

The Video Viewer is used to conduct a KVM session with one or more target devices attached to one or more KVM switches. You may optionally use KVM session profiles to control session behavior on target devices. When you connect to a device using the Video Viewer, the target device desktop appears in a separate window. The Video Viewer window supports either a 3 or 5 button mouse.

Virtual media sessions, which are supported on certain KVM switches, are opened from the Video Viewer.

About the Video Viewer

The DS View 3 management software uses either a Java-based program or an ActiveX applet to display the Video Viewer window. The Java-based Video Viewer is launched from the Mozilla and Firefox based clients when a KVM session is requested. The ActiveX Video Viewer is launched from Internet Explorer on Windows.

KVM sessions may be launched to devices from any supported KVM switch. Each KVM session will be established using the configured encryption level. See *Managed Appliance Session Settings* on page 171.

To launch a KVM session, a user must have been assigned rights or belong to a user group which has been assigned rights to establish a KVM session. See *About Access Rights* on page 144.

The DSView 3 software uses system memory to store and display images within Video Viewer windows. Each opened Video Viewer window requires additional system memory. An 8-bit color setting on the client PC requires 1.4 MB of memory per Video Viewer window, a 16-bit color setting requires 2.4 MB and a 32-bit color setting requires 6.8 MB. Opening more than four simultaneous Video Viewer windows may affect system performance and is not recommended. If you attempt to open more Video Viewer windows than your system memory allows, you will receive an out of memory error and the requested Video Viewer window will not open.

When using a non-proxied connection, video performance over a slower network connection may be less than optimal. Since certain color settings use less network bandwidth than others, changing the color settings may increase video performance. For optimal video performance over a slower network connection, a color setting such as Grayscale/Best Compression or Low Color/High Compression is recommended. See *Color depth* on page 258.

The Video Viewer client requires Java when launched from Mozilla or Firefox browsers. The supported Java version is 1.5.0_02. The Video Viewer requires this version. The DSView 3 software client automatically downloads and installs the JRE (Java Runtime Environment) the first time the Video Viewer or Telnet Viewer is launched. See *Java Installation* on page 19.

See the DSR Installer/User Guide for information about how the keys on a standard Type 5 Sun keyboard are emulated on a PS/2 keyboard.

Window Features

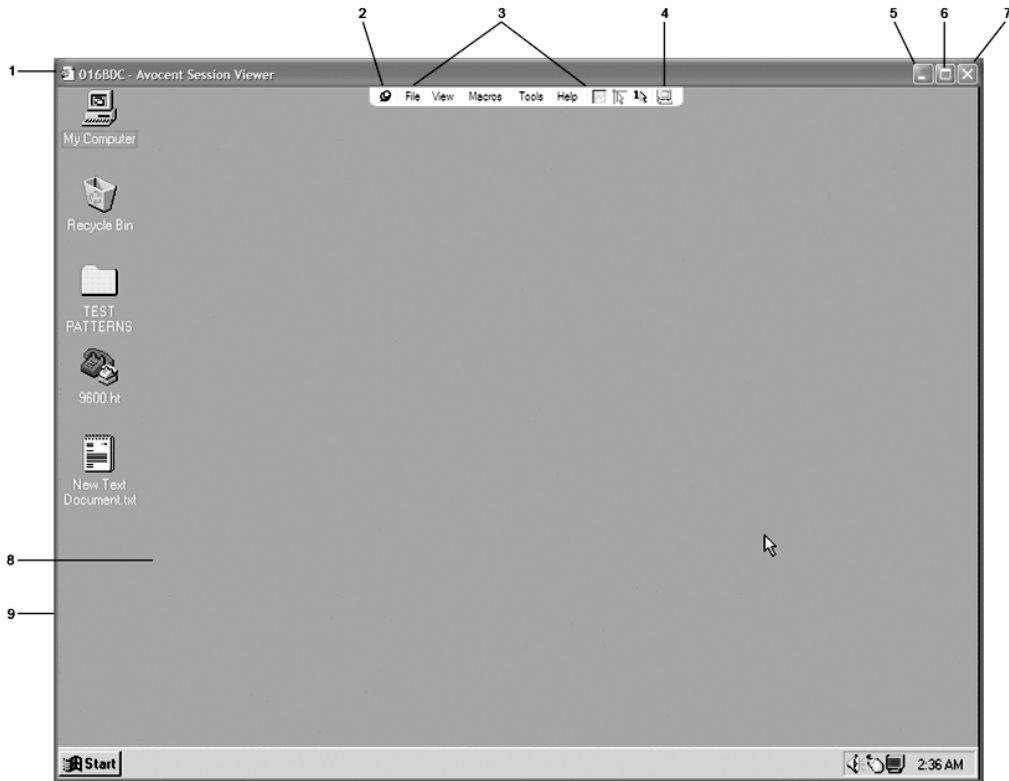

Figure 19.1: Video Viewer Window (Normal Windows Mode) (Windows OS Shown)

Table 19.1: Video Viewer Window Descriptions

Number	Description
1	Title Bar: Displays the name of the server being viewed. When in Full Screen mode, the title bar disappears and the server name appears between the menu and toolbar.
2	Thumbtack: Locks the display of the menu and toolbar so that it is visible at all times.

Table 19.1: Video Viewer Window Descriptions (Continued)

Number	Description
3	Menu and toolbar: Allows you to access many of the features in the Video Viewer window. The menu and toolbar will be in a show/hide state if the thumbtack has not been used. Place your cursor over the toolbar to display the menu and toolbar. Up to ten commands and/or macro group buttons may be displayed on the toolbar. By default, the Single Cursor Mode, Refresh, Automatic Video Adjust and Align Local Cursor buttons appear on the toolbar. See <i>Toolbar profile settings</i> on page 258 and <i>Macros</i> on page 274.
4	Macro button: Displays when a user specifies icons for macros and indicates that the icons should appear on the toolbar. See <i>Macros</i> on page 274.
5	Minimize button: Minimizes the display of the Video Viewer window into the task bar at the bottom of the local computer.
6	Maximize button: Changes the window to Full Screen mode, which expands the accessed device desktop to fill the entire screen. When you expand the window, the following occurs: <ul style="list-style-type: none"> • The title bar disappears. • The server name appears between the menu and toolbar. • The Maximize button is changed to a Normal Window Mode button and it appears on the toolbar. Clicking the button will toggle the Video Viewer window to Normal Window mode. • The Close button appears on the toolbar.
7	Close button: Closes the Video Viewer window. This button may not be present on all operating systems.
8	Accessed device desktop: Interacts with your device through this window.
9	Frame: Resizes the Video Viewer window by clicking and holding on the frame.
<p>NOTE: On supported Macintosh system clients, the placement of some buttons is different. The Minimize, Maximize and Close buttons are located on the left side of the screen, and the frame can be resized by clicking in the lower right corner.</p>	
<p>NOTE: On supported Macintosh system clients, the Video Viewer opens in a self-contained window and is not included in the Macintosh Application Menu.</p>	

Opening a KVM Session

See *Connecting to an existing session* on page 252 for information about what occurs if the device you are attempting to access is currently being viewed by another user.

To open a KVM session from the DSView 3 Explorer:

In a Units View window containing the target device you want to access (see *Accessing Units View windows* on page 106), click the *KVM Session* link in the Action column of the target device you wish to view.

The Video Viewer launches in a new window.

To open a KVM session using the Unit Overview window:

1. In a Units View window containing the target device you want to access (see *Accessing Units View windows* on page 106), click on the name of the target device. The Unit Overview window will open.
2. Click on the *KVM Session* name or icon.
The Video Viewer launches in a new window.

Opening an exclusive KVM session

An exclusive KVM connection is used when you need to access a port while excluding all other users. When a port is selected with the Exclusive KVM connection setting enabled, no other user in the system may switch to that port.

To open an exclusive (non-shared) KVM session from the DSView 3 Explorer:

1. In a Units View window containing the target device you want to access (see *Accessing Units View windows* on page 106), click the alternate actions arrow in the Action column of the target device. A list of actions will appear.
2. Click the *Exclusive KVM Session* link.

The Video Viewer launches in a new window. A yellow dot will appear next to the icon of the target device in the Units View windows to indicate an Exclusive KVM connection. Other users may not share that session.

To open an exclusive (non-shared) KVM session in the Unit Overview window:

1. In a Units View window containing the target device you want to access (see *Accessing Units View windows* on page 106), click on the name of the target device. The Unit Overview window will open.
2. Click *Exclusive KVM Session*.
3. Click the *KVM Session* icon or link in the Unit Overview window.

The Video Viewer launches in a new window. A yellow dot will appear next to the icon of the target device in the Units View windows to indicate an Exclusive KVM connection. Other users may not share the session.

Connecting to an existing session

When you attempt to connect to a port already in use by another user, the Cannot connect to the server dialog box displays and states that the port is in use along with the name of the current user(s). At this point, you may request to share access to the port with the current user(s).

You may be presented with one or more of the following options:

- Actively share a connection - When you are prompted to share a connection and you click *Share with the other user* but do not click *Passive Share*, an active connection will be established. When sharing access to a port actively, all users may monitor the port and take control if no other user is currently active.

When you click *OK*, the primary user who is currently active will receive a request to allow sharing unless *Allow shared connections automatically* has been enabled (see *Video Viewer session properties* on page 253). If the user confirms, then you will be given active access to the port.

- Passively share a connection - When you are prompted to share a connection and you click *Share with the other user* and also click *Passive Share*, a passive connection will be established. When sharing access to a port passively, you may only view what occurs on the target device, without controlling the keyboard or mouse.

When you click *OK*, the primary user who is currently active will receive a request to allow sharing unless *Allow shared connections automatically* has been enabled (see *Video Viewer session properties* on page 253). If the user confirms, then you will be given passive access to the port.

- Preempt a user's connection (DSView 3 software administrators and user administrators only) - When you are prompted to preempt the user's session and you click *Preempt the other user*, the user requesting access to the target device will be connected and existing user(s) will lose their connection to the target device. The existing user(s) will be notified that their sessions have been preempted.

You cannot preempt a local user who is in broadcast mode. See the DSR Installer/User Guide for more information.

- Make a stealth connection (DSView 3 software administrators and user administrators only) - When you are prompted to connect using Stealth mode and you click *Stealth mode*, a Video Viewer window session will be started but you will only be able to view what occurs on the target device, without controlling the keyboard or mouse. The user who is currently active will not be notified that access is being shared and no request to authorize sharing will be made.

Up to 12 users may share a single port at one time. If a 13th user attempts to connect, an error message will inform the user that no sessions are available.

To display a list of users sharing their port or channel, select *View - List of Shared Users* in the Video Viewer window. Users in stealth mode are excluded from this display.

Video Viewer session properties

Session properties specify whether users may share Video Viewer sessions automatically and whether shared connections may be viewed with the Video Viewer View - Connected Users command.

To change Video Viewer session properties:

You must have DSView 3 software administrator or user administrator privileges to configure Video Viewer session properties.

1. Click the *System* tab in the DSView 3 Explorer.
2. Click *Global Properties* in the top navigation bar. The Video Viewer Session Properties window will open.

3. To allow other users to share a Video Viewer session automatically, enable the *Allow shared connections automatically* checkbox. You will not be notified that they wish to connect to the session and will not be able to accept or reject the connection.
Disable the checkbox if you want to be notified when other users want to share the Video Viewer session. When a user attempts to connect to the session, you will be notified and prompted to accept or reject the connection request.
4. To display a list of shared connections using the *View - Connected Users* command in the Video Viewer window, enable the *View identity of shared connections* checkbox. See *Displaying Video Viewer Users* on page 270.
5. To specify if smart card connections can be used in Video Viewer sessions, enable or disable *Allow Smart Cards to be used in Video Viewer sessions*.
6. To specify if a single available smart card can be automatically mapped, enable or disable *Automatically map the Smart Card when a single card is present*.
7. Click *Save* and then click *Close*.

Session time-out

A remote session may time-out if there has been no activity in a session window for a specified time. The session time-out value is configured by the DSView 3 software administrator at the switch level. See *Managed Appliance Settings* on page 147.

You may override this value within the DSView 3 Explorer. If you specify a new time-out value, it will be used the next time the DSView 3 software is started.

Closing a Video Viewer Session

To close a Video Viewer session:

Select *File - Exit* from the Video Viewer menu.

KVM Session Profiles

KVM session profiles provide a convenient method of controlling KVM session behavior on a target device. DSView 3 software appliance administrators may add, change and delete KVM session profiles. A profile is then assigned to a target device. Appliance administrators or users with unit configure or unit edit rights may assign a profile to one or more target devices.

There is always one KVM session profile, named the Default KVM Session Profile. (This profile is called the “default profile” for the remainder of this section.) Its configuration may be changed, but the default profile cannot be deleted. The default profile is used when the profile assigned to a target device is deleted. It is also used when a target device is added to the DSView 3 software system and no other profile is assigned.

NOTE: For DSView 3 software systems that are upgraded to version 3.2 or later from an earlier version, existing target devices will not be assigned a profile.

You may create any number of additional KVM session profiles and then assign them to target devices. When a new profile is created, it has all settings configured to Inherit Default Settings; that is, it uses all the settings from the default profile. The appliance administrator may then change only those settings that differ from the default profile. For example, a new profile may be identical to the default profile, except with different toolbar settings.

Some settings have a profile override option, which indicates whether users may override the profile information by using Video Viewer menu commands (see *Using Menu Commands to Manage Session Settings* on page 263). If the override option is disabled for a setting in the profile, the Video Viewer menu selection for that setting will be disabled for the target device using that profile. If a target device is not assigned a profile, a user with a Video Viewer connection to that target device may use the Video Viewer menu commands to control their session.

In addition to the profile override option, the color depth and video scaling settings have an option that can be enabled to prohibit the user from setting a higher value than the current setting. Enabling this option can improve bandwidth management.

A KVM session profile contains general, cursor, toolbar and video settings.

General profile settings

Name

A KVM session profile name uniquely identifies the profile. Profile names may contain 1-64 characters. No two KVM session profiles may have the same name.

Default macro group

The default macro group setting allows you to choose which global macro group will appear in the Video Viewer Macros menu. See *Macros* on page 274.

If you enable *Allow users to override this setting*, or if no profile is assigned to the target device, users may specify the default macro group using Video Viewer menu commands.

Keyboard pass through mode

The keyboard pass through mode setting enables or disables keyboard pass through.





Keystrokes that a user enters may be interpreted in two ways, depending on the screen mode of the Video Viewer window.

- If a Video Viewer window is in full screen mode, keystrokes and keyboard combinations are sent to the remote server being viewed.
- If a Video Viewer window is in regular desktop mode, keyboard pass through mode allows you to control whether the remote server or local computer will recognize certain keystrokes or keystroke combinations.

When keyboard pass through mode is enabled, keystrokes and keystroke combinations are sent to the remote server being viewed when the Video Viewer window is active. For Windows, Linux and Solaris operating systems, all keystrokes and keystroke combinations are supported except **Ctrl-Alt-**

Del. For Macintosh operating systems, the following table lists keystrokes and keystroke combinations that are not supported.

Table 19.2: Macintosh Keys and Keystrokes Not Supported in Keyboard Pass Through

Keystrokes and Keystroke Combinations	Description
F13	Function Key
F14	Brightness Up
F15	Brightness Down
F16	Function Key
	Volume Down
	Volume Up
	Mute
	Eject
Command-Option-Eject	Sleep Immediately
Command-Control-Eject	Restart
Command-Option-Control-Eject	Shut Down
Option-Command-D	Display/Hide Dock

When the local desktop is active, keystrokes and keystroke combinations entered by the user affect the local computer.

In full-screen mode, keystrokes are always passed to the target device, regardless of the keyboard pass through mode setting.

The **Ctrl-Alt-Delete** keyboard combination can only be sent to a remote server by using a macro. See *Macros* on page 274.

The Japanese keyboard **ALT-Han/Zen** keystroke combination is always sent to a remote server, regardless of the screen mode or keyboard pass through setting.

If you enable *Allow users to override this setting*, or if no profile is assigned to the target device, users may enable/disable pass through mode using Video Viewer menu commands. You may also enable/disable full screen mode. See *General commands* on page 263.

Menu activation keystroke

The menu activation keystroke setting specifies the keystroke that can be used to activate the Video Viewer menu. When the menu and toolbar display are hidden, pressing this key re-enables the display.

If you enable *Allow users to override this setting*, or if no profile is assigned to the target device, users may specify the menu activation keystroke using Video Viewer menu commands. See *General commands* on page 263.

Cursor profile settings

To prevent potential mouse conflicts, you may configure certain settings on each server connected to a managed appliance. For details, see the Mouse and Pointer Settings Technical Brief, which is available on the DSView 3 software DVD and on the Avocent web site.

Local cursor

The local cursor setting specifies the appearance of the local mouse cursor. There are five appearance choices. You may also choose no cursor or the default cursor.

If you enable *Allow users to override this setting*, or if no profile is assigned to the target device, users may specify the local cursor setting using Video Viewer menu commands. See *Cursor commands* on page 264.

Single cursor mode - session startup

NOTE: Single cursor mode is available only on supported Windows system clients.

The single cursor mode - session startup setting indicates whether the Video Viewer starts up in single cursor mode.

In single cursor mode, the display of the local (second) cursor in the Video Viewer window is turned off and only the target device mouse pointer will be visible. The only mouse movements that will appear are those of the target device remote cursor. Single cursor mode is used when there is no need for a local cursor.

The cursor mode status of the Video Viewer window displays in the title bar, including the keystroke that can be used to exit single cursor mode.

If you enable *Allow users to override this setting*, or if no profile is assigned to the target device, users may enter and exit single cursor mode using Video Viewer menu commands. See *Cursor commands* on page 264.

Single cursor mode - release keystroke

The single cursor mode - release keystroke setting indicates the keystroke that can be used to release the Video Viewer single cursor mode.

When using a device that captures keystrokes before they reach the client, you should avoid using those keys to restore the mouse pointer.

If you enable *Allow users to override this setting*, or if no profile is assigned to the target device, users may specify the cursor release keystroke using Video Viewer menu commands. See *Cursor commands* on page 264.

Toolbar profile settings

Hide delay

The hide delay setting indicates the number of seconds before the toolbar hides in the Video Viewer window when it is in show/hide state (that is, not locked in place by the thumbtack).

If you enable *Allow users to override this setting*, or if no profile is assigned to the target device, users may specify the hide delay using Video Viewer menu commands. See *Toolbar commands* on page 265.

Available/enabled items lists

The Available items and Enabled items columns indicate which toolbar functions and macros can and will be displayed in the Video Viewer window.

If you enable *Allow users to override this setting*, or if no profile is assigned to the target device, users may specify the items to display using Video Viewer menu commands. See *Toolbar commands* on page 265.

Video profile settings

Color depth

The color depth setting indicates the color depth the Video Viewer will use.

The Dambrackas Video Compression™ (DVC) algorithm allows you to display more colors for the best fidelity, or fewer colors to reduce the volume of data transferred on the network.

The choices are (in descending color quantity): Best Color, Medium Color/Medium Compression, Low Color/High Compression or Gray Scale/Best Compression.

If you enable *Allow users to override this setting*, you may also control whether they may select a value higher than the profile setting. For example, when this control is enabled, if the color depth setting in the profile is Low Color/High Compression, users on a target device using that profile will not be able to select Best Color. However, they could select a lower color depth such as Gray Scale/Best Compression.

If you enable *Allow users to override this setting*, or if no profile is assigned to the target device, users may specify the color depth using Video Viewer menu commands. See *Video commands* on page 265.

Video scaling

The video scaling setting indicates the Video Viewer window resolution. You may choose absolute values, auto scale or full scale.

When autoscaling is enabled, the DSView 3 software will automatically adjust the display if the window size changes during a session. When a user accesses a channel using sharing, the display

will be adjusted to match the input resolution selected by the primary user of that channel. This will prevent the primary user's display from being affected. If the target device resolution changes any time during a session, the display will be adjusted automatically.

When full scaling is enabled, the display window is sized to match the resolution of the server being viewed.

If users are allowed to override this profile setting, you may also control whether they may select a value higher than the profile setting. For example, when this control is enabled, if the video scaling setting in the profile is 768 x 576, users on a target device using that profile will not be able to select 1024 x 768. However, they could select a lower resolution such as 640 x 480.

If you enable *Allow users to override this setting*, or if no profile is assigned to the target device, users may specify the video scaling using Video Viewer menu commands. See *Video commands* on page 265.

Background refresh

The background refresh setting enables or disables background refresh.

When background refresh is enabled, a small portion of video data is constantly sent by the KVM switch to background refresh the Video Viewer window. When background refresh is disabled, the Video Viewer window is updated by the switch only when it determines that the target device video image has changed.

NOTE: This option is not available if the switch does not support background refresh or if the DSR Remote Operations software is being used to connect to the DSR switch viewing the target device. See *DSR Remote Operations Software* on page 364.

If you enable *Allow users to override this setting*, or if no profile is assigned to the target device, users may enable/disable background refresh using Video Viewer menu commands. Users may also use the Refresh Image command. See *Video commands* on page 265.

Managing KVM session profiles

Only appliance administrators may display, add, change or delete a KVM session profile. To assign a profile to a target device, the user must either be an appliance administrator or have unit configure or edit rights. These operations are all performed in the DSView 3 Explorer.

To display KVM session profile names and settings:

1. Click the *Units* tab.
2. Click *Profiles* in the top navigation bar. The KVM Session Profiles window will open, listing the profile names.
3. To view a profile's settings, click the profile name, then click *General*, *Cursor*, *Toolbar* or *Video* in the side navigation bar to view the settings.
4. Click *Close*.

To add a KVM session profile:

1. Click the *Units* tab.
2. Click *Profiles* in the top navigation bar. The KVM Session Profiles window will open.
3. Click *Add*. The Add KVM Session Profile window will open.
4. Enter a 1-64 character name for the new profile. The name cannot be the same as the name of an existing KVM session profile.
5. Click *Add*. The new profile will be created with all values set to *Inherit Default Settings*.

To change a KVM session profile:

1. Click the *Units* tab.
2. Click *Profiles* in the top navigation bar. The KVM Session Profiles window will open.
3. Click the profile name.
4. Change the desired settings.
 - For many settings, the choices will include *Inherit Default Settings*, if you are changing any profile other than the default profile. When you select *Inherit Default Settings*, the fields for that setting will automatically be filled with values from the Default KVM Session Profile; these values cannot be changed.
 - Several settings also allow you to enable/disable an *Allow users to override these settings* checkbox. When enabled, users may override that profile setting using a Video Viewer menu command or button. When disabled, users cannot override the setting.
For all profiles other than the default profile, if a setting is configured with *Inherit Default Settings*, the *Allow users to override these settings* checkbox for that setting will not be available (it will be disabled).
5. To change general settings (see *General profile settings* on page 255):
 - a. Click *General* in the side navigation bar. The General Settings window will open.
 - b. In the Name field, enter a 1-64 character name. This cannot be the same name as an existing KVM session profile.
 - c. In the Default Macro Group field, select the macro group that will appear in the Video Viewer Macros menu. Enable or disable the *Allow users to override this setting* checkbox.
 - d. In the Keyboard Pass Through Mode field, enable or disable keyboard pass through. Enable or disable the *Allow users to override this setting* checkbox. As noted in the window, in full screen mode, keystrokes are always passed to the target device, regardless of this setting.
 - e. In the Menu Activation Keystroke field, select the keystroke that will activate the Video Viewer menu. Enable or disable the *Allow users to override this setting* checkbox.
 - f. If you changed any settings, click *Save*.
6. To change cursor settings (see *Cursor profile settings* on page 257):
 - a. Click *Cursor* in the side navigation bar. The Cursor Settings window will open.

- b. In the Local Cursor field, if you do not check the Inherit Default Settings checkbox, enable the radio button for the desired cursor type. Check or uncheck the *Allow users to override this setting* checkbox.
 - c. In the Single Cursor Mode menu, indicate whether the Video Viewer will start up in single cursor mode. Enable or disable the *Allow users to override these settings* checkbox.
 - d. In the Release Keystroke menu, select the keystroke that will release the Video Viewer single cursor mode. Enable or disable the *Allow users to override these settings* checkbox.
 - e. In the Avocent Mouse Sync menu, select *Enable* or *Disable*. Enabling Avocent Mouse Sync provides improved mouse tracking on the target device on supported system configurations. If Avocent Mouse Sync is enabled, it is not necessary to disable mouse acceleration on the target device. Enable or disable the *Allow users to override these settings* checkbox.
 - f. In the Avocent Mouse Sync Notification, select *Display Notification* or *Do Not Display Notification* to indicate if you want the mouse acceleration pop-up warning to display when a user launches a KVM session. Users cannot override this setting.
 - g. If you changed any settings, click *Save*.
7. To change toolbar settings (see *Toolbar profile settings* on page 258):
- a. Click *Toolbar* in the side navigation bar. The Toolbar Settings window will open.
 - b. If this is not the default profile, the Inherit Default Settings checkbox may be enabled or disabled. When enabled, no other settings in this window may be changed.
 - c. In the Hide Delay field, select the number of seconds for the toolbar hide delay.
 - d. To add functions to be displayed in the toolbar, select one or more functions from the Available Functions column, then click *Add*. The selected items will move to the Enabled Functions column.

To add macros to be displayed in the toolbar, select one or more macros from the Available Macros column, then click *Add*. The selected items will move to the Enabled Macros column.

To remove functions or macros from display in the toolbar, select one or more items from the Enabled Functions or Enabled Macros column, then click *Remove*. The selected items will move to the Available Functions or Available Macros column.
 - e. Enable or disable the *Allow users to override these settings* checkbox.
 - f. If you changed any settings, click *Save*. The enabled functions will be displayed first in the toolbar, followed by the enabled macros.
8. To change video settings (see *Video profile settings* on page 258):
- a. Click *Video* in the side navigation bar. The Video Settings window will open.
 - b. In the Color Depth field, choose the desired value. Enable or disable the *Allow users to override these settings* checkbox.

If users are allowed to override this setting, you may also enable or disable the *Prohibit users from selecting a higher value* checkbox. When enabled, users may select a higher

- color depth value than the current setting. When disabled, users may not select a higher value, but they may select a lower value.
- c. In the Video Scaling field, choose the desired value. Enable or disable the *Allow users to override these settings* checkbox.
If users are allowed to override this setting, you may also enable or disable the *Prohibit users from selecting a higher value* checkbox. When enabled, users may select a higher video scaling value than the current setting. When disabled, users may not select a higher value, but they may select a lower value.
 - d. In the Background Refresh field, enable or disable background refresh. Enable or disable the *Allow users to override these settings* checkbox.
 - e. If you changed any settings, click *Save*.
9. Click *Close*.

To delete one or more KVM session profiles:

NOTE: The default KVM Session Profile cannot be deleted.

1. Click the *Units* tab.
2. Click *Profiles* in the top navigation bar.
3. To delete one or more profiles, click the checkbox to the left of the profile name. To delete all profiles except the Default KVM Session Profile, click the checkbox to the left of Name at the top of the list.
4. Click *Delete*. A confirmation dialog box will appear.
5. Confirm or cancel the deletion.

To assign a KVM session profile to a target device:

1. In a Units View window containing target devices (see *Accessing Units View windows* on page 106), click on the target device name.
2. Click *Properties* in the side navigation bar, then click *Profiles* in the side navigation bar. The Profiles window will open.
3. Select the desired profile.
4. Click *Save* and then click *Close*.

To assign a KVM session profile to multiple target devices:

1. In a Units View window containing target devices (see *Accessing Units View windows* on page 106), click the checkbox next to one or more target devices. To change the KVM session profile for all target devices in the page, click the checkbox to the left of Name at the top of the list.
2. Click *Operations*, then select *Properties* from the drop-down menu.
3. The Multiple Unit Properties window will open. Click *Profile*.

4. Select a KVM session profile from the menu.
5. Click *Save* and then click *Close*.

Using Menu Commands to Manage Session Settings

KVM session profiles contain settings for the many following operations. In a profile, if the Allow users to override this setting checkbox is enabled for a setting, or if a profile has not been assigned to a target device, Video Viewer users connected to that target device may use the Video Viewer menu commands/buttons described in this section.

General commands

All of the following commands except enabling/disabling full screen mode may also be specified in a KVM session profile; see *General profile settings* on page 255.

To specify a key for toggling activation of the menu and toolbar:

1. Select *Tools - Session Options* from the Video Viewer menu or click the *Session Options* button. The Session Options dialog box appears.
2. Click the *General* tab.
3. In the Menu Activation Keystroke field, select a keystroke from the menu.
4. Click *OK*. When you disable the menu and toolbar display, pressing the specified key reenables the display.

To enable keyboard pass through:

1. Select *Tools - Session Options* from the Video Viewer menu or click the *Session Options* button. The Session Options dialog box appears.
2. Click the *General* tab.
3. Select *Pass-through all keystrokes in regular window mode*.
4. Click *OK*.

To enable or disable full screen mode:

NOTE: The View - Full Screen command may only be used by the primary user. The command is not available to non-primary users who are sharing the session.

1. To enable full screen mode, click the *Maximize* button or select *View - Full Screen* from the Video Viewer menu. The desktop window will disappear and only the accessed device desktop will be visible. The screen will be resized up to a maximum of 1024 x 768. If the desktop has a higher resolution, then a black background will surround the full screen image. The floating toolbar will appear.
2. To disable full screen mode, click the *Full Screen Mode* button on the floating toolbar to return to the desktop window.

Cursor commands

The mouse cursor and key for exiting single cursor mode commands may also be specified in a KVM session profile; see *Cursor profile settings* on page 257.

The commands to enter and exit single cursor mode and the command to align the mouse cursors cannot be set in a KVM session profile.

NOTE: If the target device does not support the ability to disconnect and reconnect the mouse (almost all newer PCs do), then the mouse will become disabled and the device will have to be rebooted.

To prevent potential mouse conflicts, you may configure certain settings on each server connected to a managed appliance. For details, see the Mouse and Pointer Settings Technical Brief, which is available on the DSView 3 software DVD and on the Avocent web site.

To change the mouse cursor setting:

1. Select *Tools - Session Options* from the Video Viewer menu or click the *Session Options* button. The Session Options dialog box appears.
2. Click the *Mouse* tab.
3. In the Local Cursor panel, select a mouse cursor type.
4. Click *OK*.

To enter single cursor mode:

Select *Tools - Single Cursor Mode* from the Video Viewer menu or click the *Single Cursor Mode* button. The local cursor will not appear and all movements will be relative to the target device.

NOTE: Single cursor mode is only available on supported Windows system clients.

To specify a key for exiting single cursor mode:

1. Select *Tools - Session Options* from the Video Viewer menu or click the *Session Options* button. The Session Options dialog box appears.
2. Click the *Mouse* tab.
3. In the Single Cursor mode field, select a key from the menu.
4. Click *OK*. The key will be displayed in the title bar. When single cursor mode is enabled, pressing the specified key returns the session to regular desktop mode.

To exit single cursor mode:

Press the key identified in the title bar.

To align the mouse cursors:

NOTE: The DSView 3 software cannot get constant feedback from the mouse, so occasionally the mouse on the switch may lose sync with the mouse on the host system. If your mouse or keyboard no longer responds properly, align the mouse to re-establish proper tracking. Alignment causes the local cursor to be aligned with the

cursor on the remote server. Resetting causes the appliance to simulate a mouse and keyboard reconnect at the device as if you had disconnected and then reconnected them.

Click the *Align Local Cursor* button in the Video Viewer toolbar. The local cursor will align with the cursor on the remote device.

If cursors drift out of alignment, turn off mouse acceleration in the device.

Toolbar commands

These commands may also be specified in a KVM session profile; see *Toolbar profile settings* on page 258.

To specify a toolbar hide time:

1. Select *Tools - Session Options* from the Video Viewer menu or click the *Session Options* button. The Session Options dialog box appears.
2. Click the *Toolbar* tab.
3. Use the arrow keys to specify the number of seconds to delay the hiding of the toolbar.
4. Click *OK* to save the changes and close the dialog box.

To add or remove items in the toolbar:

1. Select *Tools - Session Options* from the Video Viewer menu or click the *Session Options* button. The Session Options dialog box appears.
2. Click the *Toolbar* tab.
3. Enable the checkboxes for the items to display in the toolbar. Disable the checkboxes for the items to remove from the toolbar.
4. Click *OK* to save the changes and close the dialog box.

Video commands

The color depth, scaling and background refresh commands may also be specified in a KVM session profile; see *Video profile settings* on page 258. The refresh image button/command cannot be set in a KVM session profile.

To adjust the color depth:

Select *View - Color Depth* from the Video Viewer menu, then select the desired depth.

To change the Video Viewer window resolution:

NOTE: The *View - Scaling* command is not available if the Video Viewer window is in full screen mode or to non-primary users of a shared session.

Select the *View - Scaling* command, then select the desired resolution. The default is 1024 x 768.

To enable or disable background refresh:

1. Select *Tools - Session Options* from the Video Viewer menu or click the *Session Options* button. The Session Options dialog box appears.
2. Click the *General* tab.
3. Enable or disable the *Background Refresh* checkbox.
4. Click *OK*.

You may also use the Refresh Image command.

To refresh the screen:

Click the *Refresh Image* button in the Video Viewer toolbar or select *View - Refresh* from the Video Viewer menu. The digitized video image will be completely regenerated.

Mouse scaling command

Mouse scaling cannot be specified in a KVM session profile.

To prevent potential mouse conflicts, you may configure certain settings on each server connected to a managed appliance. For details, see the Mouse and Pointer Settings Technical Brief, which is available on the DSView 3 software DVD and on the Avocent web site.

To set mouse scaling:

1. Select *Tools - Session Options* from the Video Viewer menu or click the *Session Options* button. The Session Options dialog box appears.
2. Click the *Mouse* tab.
3. To use one of the preconfigured settings, enable a radio button.
 - In the Default 1:1 scaling ratio, every mouse movement on the desktop window will send an equivalent mouse movement to the server.
 - In the High 2:1 scaling ratio, the same mouse movement will send a 2X mouse movement.
 - In the Low 1:2 scaling ratio, the value will be 1/2X.
4. To set custom scaling, click the *Custom* radio button. The X and Y fields become enabled. Type a mouse scaling value in the X and Y fields. For every mouse input, the mouse movements are multiplied by the respective X and Y scaling factors. Valid input ranges are 0.25-3.00.

Avocent Mouse Sync

Enabling Avocent Mouse Sync in the KVM session profile provides improved mouse tracking on the target device. If Avocent Mouse Sync is enabled, it is not necessary to disable mouse acceleration on the target device.

If overrides are allowed (see *Managing KVM session profiles* on page 259), the primary user can require the Video Viewer to override the profile settings.

NOTE: Avocent Mouse Sync is supported on Windows or Macintosh target devices connected with a USB2 IQ module.

To set Avocent Mouse Sync from the Video Viewer:

1. Select *Tools - Session Options* from the Video Viewer menu or click the *Session Options* button. The Session Options dialog box appears.
2. Click the *Mouse* tab.
3. In the Avocent Mouse Sync section, the current status is shown. Enable or disable the *Enable Synchronization* checkbox.

NOTE: On supported system configurations, the Avocent Mouse Sync status is Available. If the target device is running a supported operating system but is not connected with a USB2 IQ module, the status is Not Supported. If the target device is connected with USB2 IQ module but is not running a Windows or Macintosh operating system, the status is Unavailable.

4. Click *OK*.

Manual Video Adjustment

Generally, the Video Viewer window automatic adjustment features will optimize the video for the best possible view. However, users may fine tune the video with the help of Avocent Technical Support by using the *Tools - Manual Video Adjust* command in the Video Viewer menu or clicking the *Manual Video Adjust* button. This displays the Manual Video Adjust dialog box.

Video adjustment is a per target setting and applies to each target device you access.

Modified video settings are written to the KVM switch. Settings are also stored per port/channel session on a system when they are made and saved so they may be used during a non-shared session as follows:

- If sharing is not enabled, the video settings made on the local KVM switch during the session are used.
- If sharing is enabled for the non-primary user, video settings are read from the KVM switch.

See *Connecting to an existing session* on page 252 for information about session sharing.

Users may verify the level of packets per second required to support a static screen by observing the packet rate which is located in the lower left-hand corner of the dialog box.

To manually adjust the video quality of the window:

NOTE: The following video adjustments should be made only on the advice and with the help of Avocent Technical Support.

1. Select *Tools - Manual Video Adjust* from the Video Viewer menu or click the *Manual Video Adjust* button. The Manual Video Adjust dialog box appears.
2. Click the icon for the feature you wish to adjust.
3. Move the slider bar and then fine tune the setting by clicking the *Min (-)* or *Max (+)* buttons to adjust the parameter for each icon pressed. The adjustments will display immediately in the Video Viewer window.
4. When finished, click *Close*.

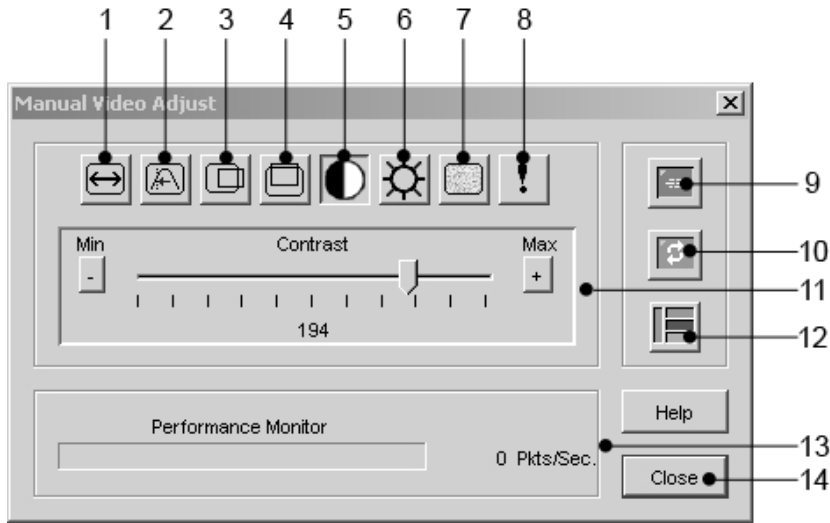

Figure 19.2: Manual Video Adjust Dialog Box

Table 19.3: Manual Video Adjust Dialog Box Descriptions

Number	Description	Number	Description
A	Image Capture Width	H	Pixel Noise Threshold
B	Pixel Sampling/Fine Adjust	I	Automatic Video Adjustment
C	Image Capture Horizontal Position	J	Refresh Image
D	Image Capture Vertical Position	K	Adjustment bar
E	Contrast	L	Video Test Pattern
F	Brightness	M	Performance Monitor
G	Block Noise Threshold	N	Close button

Image capture width, pixel sampling/fine adjust, image capture horizontal position and image capture vertical position

The Image Capture Width, Pixel Sampling/Fine Adjust, Image Capture Horizontal Position and Image Capture Vertical Position adjustments affect how the target video is captured and digitized and are seldom changed.

The image capture parameters are automatically changed by the Automatic Adjustment function. A special image is required on the target in order to make accurate adjustments independently.

Contrast and brightness

If the image in the Video Viewer window is too dark or too light, select *Tools - Automatic Video Adjust* or click the *Automatic Video Adjust* button. This command is also available in the Video Adjustments dialog box. In most cases, this will correct video problems. In those cases where clicking on Auto Adjust several times does not set the contrast and brightness as desired, adjusting the contrast and brightness manually may help.

First, increase the brightness. Do not go more than 10 increments before moving the contrast. Generally, the contrast should be moved very little.

Detection thresholds

In some cases, noise in the video transmission keeps the packets/sec count up. This may be seen when little dots change in the area of the cursor when it is moved. Varying the threshold values may result in “quieter” screens and improved cursor tracking.

Noise Threshold and Priority Threshold values may be modified if you are using standard video compression. Block Noise Threshold and Pixel Noise Threshold values may be modified if you are using the KVM switch DVC algorithm upgrade. Default threshold values can be restored by clicking *Auto Adjust Video*.

Block noise threshold and pixel noise threshold

The Block Noise Threshold and Pixel Noise Threshold values set the minimum color levels in terms of changed video blocks and pixels per thousand that are allowed.

- The Block Noise Threshold sets the minimum color change that will occur in a single video block. Increasing the value will reduce the network bandwidth. Decreasing the value will make the size of these artifacts smaller.
- The Pixel Noise Threshold sets the minimum color change in a single pixel. Decreasing the value will reduce the number of low-contrast artifacts, but will increase network bandwidth.

Automatic video adjustment

NOTE: You may also select *Tools - Automatic Video Adjust* from the Video Viewer menu or click the *Automatic Video Adjust* toolbar icon to automatically adjust the video.

In most cases, you will not need to alter the Video Settings from the default. The system will automatically adjust and use the optimal video parameters. The DSView 3 management software performs best when the video parameters are set such that no (0) video packets are transmitted for a static screen.

You may easily adjust your video parameters by clicking on the *Auto Adjust Video* button in the Manual Video Adjust dialog box, which instructs the KVM switch to optimize the video to ideal settings.

A green screen with yellow lettering may appear during auto-adjustment.

Refresh image

Clicking the *Refresh Image* button in the Manual Video Adjust dialog box will completely regenerate the digitized video image.

You may also select *View - Refresh* from the Video Viewer menu to refresh the image.

Video test pattern

Clicking the *Video Test Pattern* button in the Manual Video Adjust dialog box will toggle a display of a video test pattern. Click the *Video Test Pattern* button again to toggle back to a normal video image.

Saving the View

The display of a Video Viewer window may be saved to a file or to the clipboard for pasting into another program.

NOTE: Saving the view is only supported on Windows clients. The Capture to File menu option and link are disabled on non-Windows clients.

To capture the Video Viewer window to a file:

1. Select *File - Capture to File* from the Video Viewer menu or click the *Capture to File* button. The Save As dialog box appears.
2. Enter a filename and choose a location to save the file.
3. Click *Save*.

To capture the Video Viewer window to your clipboard:

Select *File - Capture to Clipboard* from the Video Viewer menu or click the *Capture to Clipboard* button. The image data is saved to the clipboard.

Displaying Video Viewer Users

NOTE: This procedure is not available if the DSR Remote Operations software is being used.

To display current Video Viewer users:

1. Select *View - Connected Users* from the Video Viewer menu or click the *Connected Users* button. The Users Connected to <device - Video Session number> dialog box appears, containing a list of all users connected to the Video Viewer window session.
2. Click *OK* to close the dialog box.

To display a list of users sharing a port or channel:

Select *View - List of Shared Users* in the Video Viewer menu. Users in stealth mode are excluded from this display.

Scan Mode

To start scan mode:

In a Units View window (see *Accessing Units View windows* on page 106), select two or more target devices that support KVM connections, then click Scan.

Scan mode will start and the Video Viewer windows will appear in the Thumbnail Viewer. A series of thumbnail frames appear in the Thumbnail Viewer, each containing a small, scaled, non-interactive version of a target device screen image.

About scan mode

Scan mode moves from one thumbnail image to the next, logging into a device and displaying an updated device image for a specified length of time (View Time Per Server), before logging out of that device and moving on to the next thumbnail image. You may specify a scan delay between thumbnails (Time Between Servers). During the delay, you will see the last thumbnail image for all devices in the scan sequence, though you won't be logged into any devices.

When you first launch the Thumbnail Viewer, each frame will be filled with a white background until a device image is displayed. An indicator light at the bottom of each frame displays the device status. The default thumbnail size is based on the number of devices in the scan list.

Scan mode has a lower priority than an active connection. If you or another user are connected to a device, that device will be skipped in the scan sequence, and scan mode will proceed to the next device unless the Shared Connections Automatically option has been selected, in which case target devices may be shared and will not be skipped in the scan sequence. No login error messages will appear. After your interactive session is closed, the thumbnail will be included in the scan sequence again.

You may disable a device thumbnail from the scan sequence. The thumbnail image remains, but it is not updated until it is once again enabled.

When running scan mode, it is recommended that logging of the following events (enabled by default) be disabled in the DSView 3 software system. Each thumbnail scan will result in the logging of these events. The event log could grow to a huge size if the following events are enabled and scan mode is run continuously for a lengthy amount of time:

- | | |
|----------------------------------|----------------------------------|
| Appliance Change Of State | Viewer Session Stopped |
| Viewer Session Started | Appliance Viewer Session Stopped |
| Appliance Viewer Session Started | |

Thumbnail Viewer features

Figure 19.3 shows the Thumbnail Viewer areas, and descriptions follow in Table 19.4.

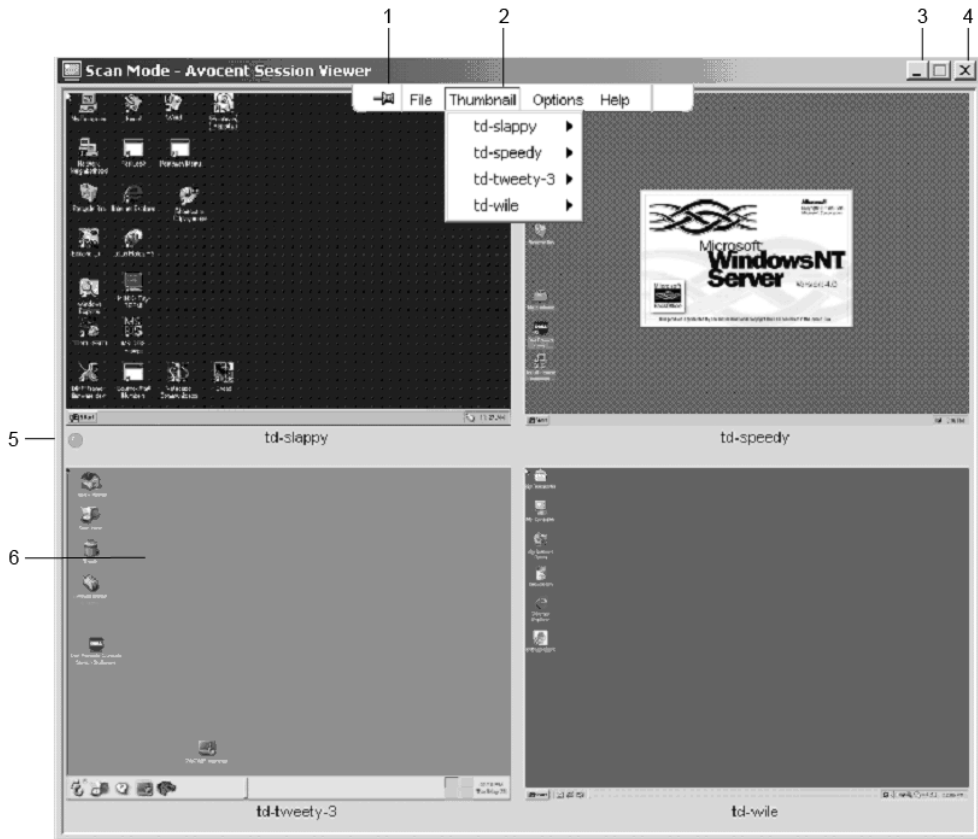

Figure 19.3: Thumbnail Viewer

Table 19.4: Thumbnail Viewer Descriptions

Number	Description
1	Thumbtack: Locks the display of the menu so that it is visible at all times.
2	Menu: Allows access to Thumbnail Viewer features. The menu will be in a show/hide state if the thumbtack has not been used. Place your cursor over the toolbar to display the menu.
3	Minimize button: Minimizes the display of the Thumbnail Viewer window into the toolbar at the bottom of the local computer.
4	Close button: Closes the Thumbnail Viewer and all thumbnails being viewed. The Close button may not be present on all operating systems.

Table 19.4: Thumbnail Viewer Descriptions (Continued)

Number	Description
5	<p>Status indicator: The device name and status indicator appear below each thumbnail:</p> <ul style="list-style-type: none"> • A green LED indicates that a device is currently being scanned. • A red X indicates that the last scan of the device was not successful. The scan may have failed due to a credential or path failure (for example, the device path on the appliance was not available). The tool tip for the LED indicates the reason for the failure.
6	Thumbnail image: Interacts with your device through this window.

Performing Thumbnail Viewer tasks

To set scan preferences:

1. Select *Options - Preferences* from the Thumbnail Viewer menu. The Scan Mode Preferences dialog box appears.
2. In the View Time Per Server field, enter the time each thumbnail will be active during the scan, in the range 10-60 seconds.
3. In the Time Between Server field, enter the time the scan will stop between each device, in the range 5-60 seconds.
4. Click *OK*.

To pause or restart a scan sequence:

Select *Options - Pause Scan* from the Thumbnail Viewer menu. The scan sequence will pause at the current thumbnail if the Thumbnail Viewer has a scan in progress or will restart the scan if currently paused.

To change the thumbnail size:

Select *Options - Thumbnail Size* from the Thumbnail Viewer menu. Choose the desired thumbnail size from the cascade menu.

To disable a device thumbnail in the scan sequence:

Select a device thumbnail. Select *Thumbnail - <device name> - Disable* from the Thumbnail Viewer menu or right-click on a device thumbnail and select *Disable* from the pop-up menu. Updating of the thumbnail image will stop until it is enabled.

To enable a device thumbnail in the scan sequence:

Select a device thumbnail. Select *Thumbnail - <device name> - Enable* from the Thumbnail Viewer menu or right-click on a device thumbnail and select *Enable* from the pop-up menu. Updating of that thumbnail image will resume.

To launch a session to a device from the Thumbnail Viewer:

Select a device thumbnail. Select *Thumbnail - <device name> - View Interactive Session* from the Thumbnail Viewer menu.

-or-

Right-click on a device thumbnail and select *View Interactive Session* from the Thumbnail Viewer menu. That target device desktop will appear in a Video Viewer window.

-or-

Double-click on the thumbnail image.

To exit the Thumbnail Viewer:

Select *File - Exit* from the Thumbnail Viewer menu or click the *Close* button.

Macros

NOTE: Macros may not be created, edited, copied or deleted if the DSR Remote Operations software is being used to connect to the DSR appliance viewing the target device.

Three types of macros are available in the DSVIEW 3 management software. Exit macros are used by and located on DS1800 digital switches and DSR switches. See *Defining exit macros* on page 175.

The other two types, global macros and personal macros, are created and used by the Video Viewer. Global macros are created and maintained by users with appliance administrator privileges and are stored on the hub server and any specified spoke servers. See *Managed Appliance Session Settings* on page 171.

Global and personal macros may also be created in the Telnet Viewer window. Macros created using the Telnet Viewer window are not compatible with the Video Viewer and may only be used with target devices connected to serial console appliances.

Users may create personal macros for their own use. These macros can be accessed on the local computer using the Video Viewer window. Personal macros may be customized and grouped in any manner you wish with the exception of being included in a Global Macro group.

When a session is started in the DSVIEW 3 software, global and personal macros are retrieved from the DSVIEW 3 server. Then, when a Video Viewer window session is started, the macros are loaded. A user may choose to use either personal macros or global macros and switch between using them at any time during the session.

Both personal and global macros may be added to the Video Viewer window toolbar. A user may then execute the macro by clicking the button on the toolbar. See *Toolbar profile settings* on page 258.

The Video Viewer window macro function allows you to:

- Send multiple keystrokes to a device, including keystrokes that you cannot generate without affecting your local system, such as **Ctrl-Alt-Delete**.

- Send a macro from a predefined macro group. Macro groups for Windows, Novell and Sun are already defined.
- Create, edit and delete your own macros. When you create or edit a macro, you may type the desired keystrokes or you may select from among several available categories of keystrokes. Each category contains a set of keystroke combinations. Selecting from the available categories and keystrokes saves time and eliminates the risk of typographical errors.

Since the DSView 3 software may be used to access different computer platforms, you may find it helpful to assign distinct macro groups to Global Macros or Personal Macros on individual systems. You may specify the macro group to display in the Macro Groups dialog box. The Macro Groups dialog box may also be used to switch between using Global and Personal Macros at any time during a session.

The Video Viewer window contains grouping commands that allow you to create, edit and delete your own macro groups. A user with software administrator or user administrator privileges may also change the predefined macro groups.

Macro group settings are device-specific; that is, they may be set differently for each device.

To send a macro:

1. Select *Macros* - <desired macro> from the Video Viewer menu.
-or-
Select Macros - Configure - Macros (this menu item is not available if you are using the DSR Remote Operations software.)
-or-
Click the *Macros* button.
The Macros dialog box appears.
2. Select one of the following: *All* - displays both personal and global macros, *Personal* - displays only personal macros or *Global* - displays only global macros.
3. Select the desired macro from the Defined Macros list and then click *Run*.
4. Click *Close*.

To create or edit a macro:

1. Select *Macros - Configure - Macros* from the Video Viewer menu or click the *Macros* button. The Macros dialog box appears.
2. To create a macro, click *Create*. The Create Macro dialog box appears.
To edit a macro, click *Edit*. The Edit Macro dialog box appears.
3. If you are creating a macro, type a 1-32 character name in the Macro Name field.
4. Select whether you wish to edit or create a personal or global macro from the Macro Type area.
5. Select the type of keyboard to create or edit the macro from the Keyboard Type menu. Available keyboard types are: U.S. English, Dutch, Danish, German, French, Italian, Spanish and Japanese.

6. Select an icon to associate with the macro from the Macro Icon menu.
7. To build the macro, click the keys on the virtual keyboard in the dialog box. The keys of the virtual keyboard operate like a physical keyboard. As a key is clicked, it will appear in the Keystrokes list box to the left of the virtual keyboard.

You may type or press the **arrow** keys to specify a delay between keys. First, click the key in the list box after which you wish to place a delay. Next, click *Delay* to insert the delay in the list box.

Keystrokes unique to Sun keyboards may be added to the macro by selecting the key type from the menu to the right of the Sun Key button and clicking the button.

8. If necessary, use the following keys to change the entries in the Keystrokes list box.
 - Click *Reset* to remove all entries from the list box.
 - Click on an entry and then click *Remove* to remove it from the list box.
 - Click on an entry and then click *Move Up* to promote the entry in the list box.
 - Click on an entry and then click *Move Down* to demote the entry in the list box.
9. Click *OK* to accept the changes and return to the Macros dialog box.

To delete a macro:

1. Select *Macros - Configure - Macros* from the Video Viewer menu or click the *Macros* button. The Macros dialog box appears.
2. Select one of the following: *All* - displays both personal and global macros, *Personal* - displays only personal macros or *Global* - displays only global macros.
3. Select the desired macro from the Defined Macros list and then click *Delete*. You are prompted to confirm the deletion.
4. Confirm or cancel the deletion.
5. Click *Close*.

To copy a macro:

1. Select *Macros - Configure - Macros* from the Video Viewer menu or click the *Macros* button. The Macros dialog box appears.
2. Select one of the following: *All* - displays both personal and global macros, *Personal* - displays only personal macros or *Global* - displays only global macros.
3. Select the desired macro from the Defined Macros list and then click *Copy*. The Copy Macro dialog box will appear.
4. Type a 1-32 character name in the Name of copied macro field.
5. Select whether you wish to make the copied macro a personal or global macro from the Macro Type area.
6. Click *OK* to copy the macro. The Copy Macro dialog box is closed and the copied macro will appear in the Macros dialog box.

7. Click *Close*.

Macro groups

Macro groups may not be displayed, created, edited, renamed, copied or deleted if you are using the DSR Remote Operations software.

To create a macro group:

1. Select *Macros - Configure - Macro Groups* from the Video Viewer menu or click the *Macro Groups* button. The Macro Groups dialog box appears.
2. Click *Create*. The Create/Edit Macro Group dialog box will appear.
3. In the Macro Group Name field, enter a 1-32 character unique macro group name.
4. In the Group Type area, click *Global* if you wish to create a global macro group or click *Personal* if you wish to create a personal macro group.
5. Click *OK* to save the name and return to the Macro Groups dialog box.
6. Click *Close*.

To add or delete macros in an existing macro group:

1. Select *Macros - Configure - Macro Groups* from the Video Viewer menu or click the *Macro Groups* button. The Macros Groups dialog box appears.
2. Select one of the following: *All* - displays both personal and global macro groups, *Personal* - displays only personal macro groups or *Global* - displays only global macro groups.
3. Select the macro group to be altered from the Defined Groups list box. Windows and Sun are the default macro groups. If you have created new groups, they will also be displayed.
4. Click *Edit*. The Create/Edit Macro Groups dialog box will appear.
5. If you are editing a Personal Macro group, select one of the following from the View area: *All* - displays both personal and global macros, *Personal* - displays only personal macros or *Global* - displays only global macros.
6. To add macros to the group, select the macro from the Macros Available list. Click the *Add* button. The macro moves to the Macros in Group list. Use the *Move Up* and *Move Down* buttons to move the macro up or down in relation to the other macros.
7. To remove macros from the group, select the macro from the Macros in Group list. Click the *Remove* button. The macro moves to the Macros Available list.
8. Repeat steps 6 and 7 until the Macros in Group list contains all the desired macros.
9. Click *OK* to accept the macro group and return to the Macro Groups dialog box.
10. Click *Close*.

To rename a macro group:

1. Select *Macros - Configure - Macro Groups* from the Video Viewer menu or click the *Macro Groups* button. The Macro Groups dialog box appears.

2. Select one of the following: *All* - displays both personal and global macro groups, *Personal* - displays only personal macro groups or *Global* - displays only global macro groups.
3. Select the macro group to be altered from the Defined Groups list box. Windows and Sun are the default macro groups. If you have created new groups, they will also be displayed.
4. Click *Edit*. The Create/Edit Macro Groups dialog box will appear.
5. In the Macro Group Name field, enter a 1-32 character unique macro group name.
6. Click *OK* to save the name and return to the Macro Groups dialog box.
7. Click *Close*.

To delete a macro group:

1. Select *Macros - Configure - Macro Groups* from the Video Viewer menu or click the *Macro Groups* button. The Macro Groups dialog box appears.
2. Select one of the following: *All* - displays both personal and global macro groups, *Personal* - displays only personal macro groups or *Global* - displays only global macro groups.
3. Select the macro group to be deleted from the Defined Groups list box.
4. Click the *Delete* button. You are prompted to confirm the deletion.
5. Confirm or cancel the deletion.
6. Click *Close*.

To copy a macro group:

1. Select *Macros - Configure - Macro Groups* from the Video Viewer menu or click the *Macro Groups* button. The Macro Groups dialog box appears.
2. Select one of the following: *All* - displays both personal and global macros, *Personal* - displays only personal macros or *Global* - displays only global macros.
3. Select the desired macro group from the Defined Groups list and then click *Copy*. The Copy Macro Group dialog box will appear.
4. Type a 1-32 character name in the Name of copied macro group field.
5. Select whether you wish to make the copied macro group a personal or global macro from the Macro Type area.
6. Click *OK* to copy the macro group. The Copy Macro Group dialog box is closed and the copied macro group will appear in the Macro Groups dialog box.
7. Click *Close*.

To change the macro group to be displayed in the Macros menu:

1. Select *Macros - Configure - Macro Groups* from the Video Viewer menu or click the *Macro Groups* button. The Macro Groups dialog box appears.
2. Select one of the following: *All* - displays both personal and global macro groups, *Personal* - displays only personal macro groups or *Global* - displays only global macro groups.
3. Select the macro group to be displayed from the Defined Groups list box.

4. Select *Display on Menu*.
5. Click *Close* to exit the Macro Groups dialog box.

Macros in the selected group will appear in the Video Viewer window Macros menu.

To display a predefined macro group:

Select *Macros - Display on Menu* and then select one of the macro groups Sun or Windows.

Power Control of Devices Attached to Power Devices

NOTE: You must have Appliance Administrator privileges to issue a power control command.

If a target device is connected to a power device outlet (socket), you may power up, power down or cycle (power up and then power down) the target device using the Power Control dialog box.

To power up, power down or power cycle a target device:

1. Select *Tools - Power Control* from the Video Viewer menu. The Power Control dialog box will appear.
2. Click the *Power On the Server*, *Power Off the Server* or *Power Cycle the Server* button.
3. A warning dialog box will appear. Confirm or cancel the operation.
4. Click *Close* to close the dialog box.

Using Virtual Media

The virtual media feature allows the user on the client workstation to map a physical drive on that machine as a virtual drive on a target device. The client may also add and map an ISO or floppy image file as a virtual drive on the target device.

You may have one CD drive and one mass storage device mapped concurrently.

- A CD/DVD drive, disk image file (such as an ISO or floppy image file) is mapped as a virtual CD drive.
- A floppy drive, USB memory device or other media type is mapped as a virtual mass storage device.

For additional information, see *Understanding and Using Virtual Media*, which is available on the DSVIEW 3 software DVD and on the Avocent web site.

Requirements

The target device must be connected to the KVM switch that supports virtual media with an IQ module that supports virtual media.

The target device must be intrinsically able to use the types of USB2-compatible media that you virtually map. In other words, if the target device does not support a portable USB memory device, you cannot map that on the client machine as a virtual media drive on the target device.

The user (or user group to which the user belongs) must have permission to establish virtual media sessions and/or reserved virtual media sessions to the target device. See *About Access Rights* on page 144.

Only one virtual media session may be active to a target device at one time.

You may not use the virtual media feature with the DSR Remote Operations software.

Sharing and preemption considerations

The KVM and virtual media sessions are separate; therefore, there are many options for sharing, reserving or preempting sessions. The DSVIEW 3 software has the flexibility to accommodate the system needs.

For example, the KVM and virtual media sessions may be locked together. In this mode, when a KVM session is disconnected, so is the associated virtual media session. If the sessions are not locked together, the KVM session can be closed but the virtual media session will remain active. This could be desirable if a user is performing a time-intensive task using the virtual media session (such as an operating system load), and wants to establish a KVM session with a different target device to perform other functions while the operating system load progresses.

Once a target device has an active virtual media session without an associated active KVM session, two situations can occur - the original user (User A) can reconnect or a different user (User B) can connect to that channel. You may set an option in the Virtual Media dialog box (Reserved) that allows only the User A to access that channel with a KVM session.

If User B is allowed to access that session (the Reserved option is not enabled), User B could control the media that is being used in the virtual media session. In some environments, this may not be desirable.

By using the Reserved option in a tiered environment, only User A could access the lower switch and the KVM channel between the upper switch and lower switch would be reserved for User A.

Preemption levels offer additional flexibility of combinations. See *Opening an exclusive KVM session* on page 252 and *Connecting to an existing session* on page 252. The preemption modes described in those sections also apply to virtual media session.

Virtual Media dialog box

The Virtual Media dialog box is a program that manages the mapping and unmapping of virtual media. The dialog box displays all the physical drives on the client's workstation that can be mapped as virtual drives. You may also add ISO and floppy image files and then map them using the Virtual Media dialog box.

After a device is mapped, the Virtual Media dialog box Details View displays information about the amount of data transferred and the time elapsed since the device was mapped.

You may specify that the virtual media session is reserved. When a session is reserved, and the associated KVM session is closed, another user cannot launch a KVM session to that target device. If a session is not reserved, another KVM session may be launched.

You may also reset the USB2 IQ module from the Virtual Media dialog box. This action will reset every form of USB media on the target device, and should therefore be used with caution, and only when the target device is not responding.

Virtual media session settings

Virtual media session settings include locking, mapped drives access mode and encryption level. See *Managed Appliance Session Settings* on page 171.

Table 19.5 describes the virtual media session settings on the supported KVM switch.

Table 19.5: Virtual Media Session Settings

Setting	Description
Locking	The locking option specifies whether a virtual media session is locked to the KVM session on the target device. When locking is enabled (which is the default) and the KVM session is closed, the virtual media session will also be closed. When locking is disabled and the KVM session is closed, the virtual media session will remain active.
Mapped drives access mode	You may set the access mode for mapped drives to read-only or read-write. When the access mode is read-only, the user will not be able to write data to the mapped drive on the client workstation. When the access mode is read-write, the user will be able to read and write data from/to the mapped drive. If the mapped drive is read-only by design (for example, certain CD/DVD drives or ISO images), the configured read-write access mode will be ignored. Setting the read-only mode can be helpful when a read-write drive such as a mass storage device or a USB removable media is mapped, and you wish to prevent the user from writing data to it.
Encryption level	You may configure up to three encryption levels (or none) for virtual media sessions. Any combination is valid. The choices are: DES, 3DES, 128-bit SSL and AES. The default is no encryption (no encryption levels selected).

Opening a virtual media session

To launch a virtual media session:

Select *Tools - Virtual Media* from the Video Viewer menu. The Virtual Media dialog box will appear.

To make this a reserved session, click *Details*, then enable the *Reserved* checkbox.

To map a virtual media drives:

1. Open a virtual media session from the Video Viewer menu by selecting *Tools - Virtual Media*.
2. To map a physical drive as a virtual media drive:
 - a. In the Virtual Media dialog box, click the *Mapped* checkbox next to the drive(s) you wish to map.
 - b. If you wish to limit the mapped drive to read-only access, click the *Read Only* checkbox next to the drive. If the virtual media session settings were previously configured so that

all mapped drives must be read only, this checkbox will already be enabled and cannot be changed.

You might wish to enable the *Read Only* checkbox if the session settings enabled read and write access, but you wished to limit a particular drive's access to read only.

3. To add and map an ISO or floppy image as a virtual media drive:
 - a. In the Virtual Media dialog box, click *Add Image*.
 - b. The common file dialog box will appear, with the directory containing disk image files (that is, those ending in .iso or .img) displayed. Select the desired ISO or floppy image file and click *Open*.

-or-

If the client workstation's operating system supports drag-and-drop, select the desired ISO or floppy image file from the common file dialog box and drag it onto the Virtual Media dialog box.

- c. The file's header is checked to ensure it is correct. If it is, the common file dialog box will close and the chosen image file will appear in the Virtual Media dialog box, where it can be mapped by clicking the *Mapped* checkbox.
 - d. Repeat steps a through c for any additional ISO or floppy images you wish to add. You may add any number of image files (up to the limits imposed by memory), but you may only have one virtual CD or virtual mass storage mapped concurrently.

If you attempt to map too many drives (one CD and one mass storage device) or too many drives of a particular type (more than one CD or mass storage device), a message will be displayed. If you still wish to map a new drive, you must first unmap an existing mapped drive, then map the new drive.

After a physical drive or image is mapped, it may be used on the target device.

To unmap a virtual media drive:

1. In the Virtual Media dialog box, uncheck the *Mapped* checkbox next to the drive you wish to unmap.
2. You will be prompted to confirm. Confirm or cancel the unmapping.
3. Repeat for any additional virtual media drives you wish to unmap.

To display virtual media drive details:

In the Virtual Media dialog box, click *Details*. The dialog box expands to display the Details table. Each row indicates:

- Target Drive - Name used for the mapped drive, such as Virtual CD 1 or Virtual CD 2.
- Mapped to - Identical to Drive information that appears in the Client View Drive column.
- Read Bytes and Write Bytes - Amount of data transferred since the mapping.
- Duration - Elapsed time since the drive was mapped.

To close the Details view, click *Details* again.

To reset all USB devices on the target device:

NOTE: The USB reset feature resets every USB device on the target device, including the mouse and keyboard. It should only be used when the target device is not responding.

1. In the Virtual Media dialog box, click *Details*.
2. The Details View will appear. Click *USB Reset*.
3. A warning message will appear, indicating the possible effects of the reset. Confirm or cancel the reset.
4. To close the Details view, click *Details* again.

Closing a virtual media session

To close the Virtual Media dialog box:

1. Click *Exit*.
2. If you have any mapped drives, a message is displayed, indicating that the drives will be unmapped. Confirm or cancel the operation.

If a user attempts to disconnect a virtual media session or an active KVM session that has an associated locked virtual media session, a confirmation message is displayed, indicating that any virtual media mappings will be lost.

See *Sharing and preemption considerations* on page 280 and *Active Sessions* on page 176 for information about other factors that may affect virtual media session closings.

Using Smart Cards

You can connect a smart card reader to the client server and access attached target devices on a supported KVM switch system. You can then launch a KVM session to open the Video Viewer and map a smart card.

NOTE: To specify smart card session and mapping options for Video Viewer sessions, see *Video Viewer session properties* on page 253.

The smart card status is indicated by the smart card icon at the far right of the Video Viewer toolbar. The following table describes the smart card status icons.

Table 19.6: Smart Card Icons



Icon	Description
	Disabled - A smart card reader is not available, the IQ module does not support smart card readers, or smart card access is disabled in the DSView 3 software.
	Not mapped - A smart card reader is available but has not been mapped yet.

Table 19.6: Smart Card Icons (Continued)

Icon	Description
	Available - A smart card is mapped and available.

To map a smart card:

1. Open a KVM session to display the Video Viewer window menu.
2. Insert a smart card into the smart card reader attached to your client server.
3. Click *Tools - Map Smart Card* on the Video Viewer window menu.
4. If no smart card is mapped to the target device, the No Card Mapped option will have a dot beside it. Select your smart card, listed below this option, to map the smart card.

To unmap a smart card:

Close out the KVM session by clicking *X* in the Video Viewer window menu.

-or-

Select *Tools - No Card Mapped*.

-or-

Remove the smart card from the smart card reader.

-or-

Disconnect the smart card reader from the client server.

Video Viewer Troubleshooting

If the Video Viewer or the Virtual Media dialog box does not start, the local Java cache may be corrupted. You can easily clear the cache without losing any data.

To clear the local Java cache:

1. Start the Java Control panel.
 - On supported Windows and Macintosh systems, this will be an item in the Control Panel.
 - On supported Linux systems, from a shell prompt, change directory to the bin directory where Java is installed. Then type **.JControlPanel**.

For example:

```
cd /usr/java/avocent/jrel.5.0_02/bin
./ControlPanel
```
2. Select the *General* tab.
3. Click the *Settings* button.

4. Click the *View Applications* button.
5. Select any *DSView Video Viewer Application* items.
6. Click the *Remove Selected Entries* button (this button may also be named *Remove Selected Application*).

If this does not solve the problem, repeat step 1, then click the *Delete Files* button.

NOTE: Clicking the *Delete Files* button will remove all applications installed with Java Web Start.

Using the Telnet Viewer

The DSView 3 management software ships bundled with a built-in proprietary Telnet Viewer that provides features unavailable in many other Telnet programs. These features include configurable session properties tailored for each device, configurable user preferences for all sessions, a scripting function for automatic device login, a macro function and a logging function.

About the Telnet Viewer

DSView 3 software clients may use the DSView 3 management software Telnet Viewer to access CPS810 and 1610 appliances and their ports, CCM 850, 1650 and 4850 appliances and their ports, or any generic appliance that supports Telnet Viewer connections.

NOTE: Throughout this chapter, the term “appliance” or “managed appliance” will be used to indicate a supported CPS appliance, CCM appliance or generic appliance that supports Telnet Viewer connections.

When a session is established with a supported appliance, the Telnet client switches to SSH (Secure Shell) mode and opens an SSH shell to/through the appliance. The SSH shell can use any of the Telnet client’s terminal emulations. See *Security Property* on page 290.

The Telnet Viewer uses the credentials provided by the DSView 3 software to establish a session and will automatically accept the appliance server key. The username and password provided by the users when they log in are authenticated by the authentication service configured in the DSView 3 software.

Requirements

The Telnet Viewer is actually an applet that runs within the Java 1.5.0_02 plug-in (JRE). The Telnet Viewer may also work with other Java versions. The DSView 3 software client automatically downloads and installs the JRE (Java Runtime Environment) the first time the Video Viewer or the Telnet Viewer is launched. See *Java Installation* on page 19 for information about user interaction with the JRE installer.

Telnet Viewer Window Features

A new Telnet Viewer window will open for each new Telnet session established by a user. The Telnet Viewer window contains menus, a toolbar and a window that provides virtual terminal emulation.

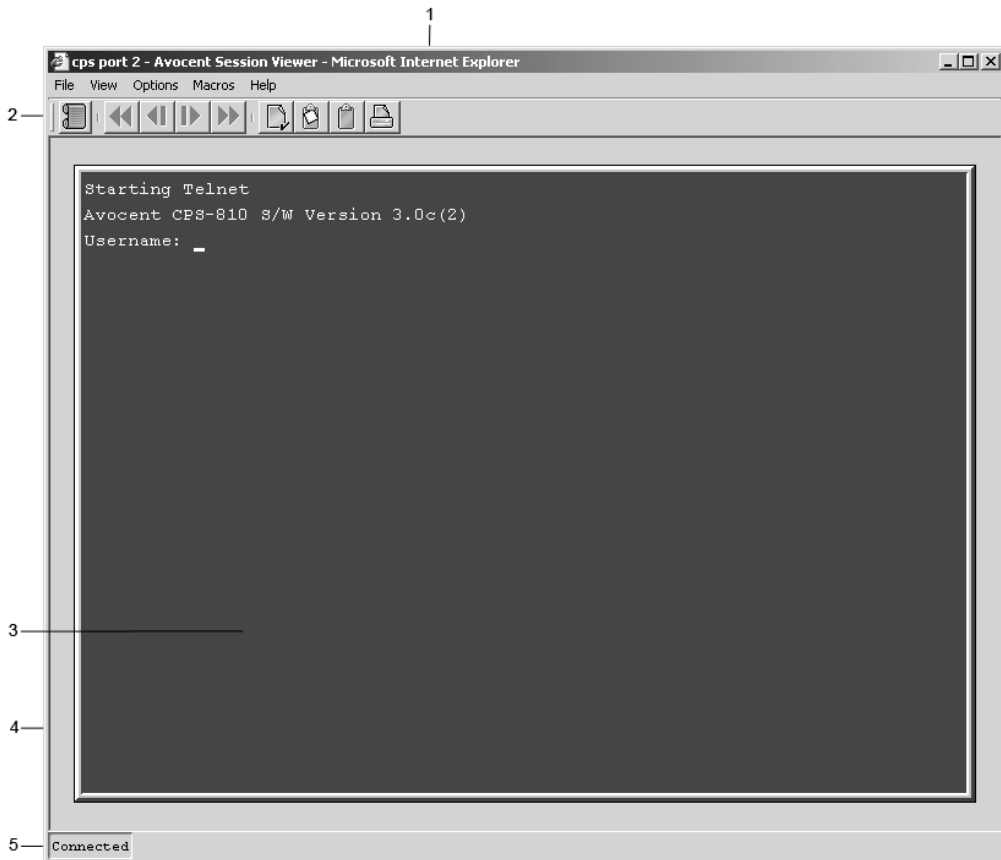

Figure 20.1: Telnet Viewer Window

Table 20.1: Telnet Viewer Window Descriptions

Number	Description
1	Title Bar: Displays the name of the target device being viewed.
2	Toolbar: Allows you to access many of the features in the Telnet Viewer. See Table 20.2 for a description of the toolbar icons.
3	Virtual Terminal window: Interacts with your target device through this window. By default the window size is 80 characters x 24 lines.
4	Viewer window: Resizes the window when you click and hold on the frame. Although the window may be resized, the Virtual Terminal window will remain the same size.









Table 20.1: Telnet Viewer Window Descriptions (Continued)

Number	Description
5	Status Bar: Displays one of the following: Connected - Displays during normal terminal emulation in a Telnet Viewer session. Logging - Displays when logging is enabled. Logging Paused - Displays when logging is paused.
NOTE: The Close button may not be present on all operating systems.	
NOTE: On supported Macintosh system clients, the Telnet Viewer opens in a self-contained window and is not included in the Application Menu.	

Telnet Viewer window toolbar

Table 20.2 describes the Telnet Viewer window's toolbar icons.

Table 20.2: Telnet Viewer Window Toolbar Icons

Icon	Description
	Session Settings - Displays the Session Properties dialog box
	Help - Displays the DSView 3 software help
	Copy Screen - Copies a screen of Telnet Viewer session data to the system clipboard
	Copy Buffer - Copies the contents of the Telnet Viewer session buffer to the system clipboard
	Copy Text - Copies highlighted text in a Telnet Viewer session screen to the system clipboard
	Restore - Restores the ability to highlight screen text when autoscaling is enabled and the virtual terminal window has been scaled
	Paste - Pastes the contents of the system clipboard into a Telnet Viewer session
	Prints a screen of Telnet Viewer session data

Security Property

A fully functional SSH2 (Secure Shell Version 2) Client is built into the Telnet Viewer. The SSH2 Client is Java-based and provides a secure method for accessing target devices.

The Telnet Viewer provides the following security features:

- Strict host key checking
- Support ciphers for AES (128-, 192-, 256-bit), Blowfish, Twofish, Cast, 3DES and Arcfour
- Diffie-Hellman key exchange support
- SSH-RSA key types
- Supported for hmac-md5, hmac-sha1, hmac-sha1-96, hmac-md5-96 and hmac-ripemd160

The DSView 3 software will determine whether to create a Telnet or SSH2 connection when you start a session with an appliance. A serial connection provides SSH2 serial access to the target device from the appliance. Terminal emulation options are supported using both types of connections.

The SSH2 client is started when you initiate a session with an appliance port from the DSView 3 Explorer. The DSView 3 server is contacted, which in turn contacts the target device connected to the appliance port and exchanges X.509 certificates with the target device. The target device also supplies a session certificate, private key and appliance certificate.

These certificates are then passed back to the SSH2 client, which uses them to determine the SSH2 host key and the user SSH2 key. The Telnet Viewer will then establish a session with the target device (or through the proxy server if there is a proxy server connection). The Telnet Viewer then passes the RSA public key from the session certificate when establishing the SSH connection. Finally, the virtual terminal window will open using an SSH2 shell over SSH connection.

SSH2 settings may be viewed by clicking on an appliance name in the DSView 3 Explorer and selecting *Appliance Settings - Sessions - Settings* in the side navigation bar to display the Properties - Sessions - Settings window.

Opening a Session

A DSView 3 management software Telnet Viewer session is opened using the DSView 3 Explorer by clicking on *Telnet Session* or *Serial Session* in the Action column of the target device. If the target device is attached to an appliance port, Telnet Session will appear. If the target device is attached to an appliance that is also attached to a serial device, Serial Session will appear.

NOTE: If multiple connection methods are available, an alternate actions arrow will appear to the right of the action. Clicking the alternate action arrow will display a list of other actions, in descending order of priority, which may be selected to launch the corresponding window type.

To open a Telnet Viewer session:

In a Units View window containing target devices (see *Accessing Units View windows* on page 106), click *Telnet Session* or *Serial Session* in the Action field or the Alternate Action menu.

Alternative, you can click the Telnet Session or Serial Session icon in the Unit Overview window for the target device (see *Unit Overview Windows* on page 112).

The Telnet Viewer window will open.

NOTE: You can share a Telnet Viewer session with an SSH serial session. See *SSH Passthrough Sessions* on page 195.

Customizing the Telnet Viewer

You may specify preferences that will be used for every Telnet Viewer session, regardless of the device to which you connect. These application preferences are entered from the Telnet Viewer window when you are connected to a device or port. After the preferences are entered, they are applied to devices/ports during subsequent sessions.

To change the window background and/or text color:

1. Select *Options - Preferences* from the menu. The Preferences dialog box will appear.
2. To change the background color, click the *Background/Normal Mode* box in the Colors section and select a color. The default color is blue.
3. To change the text color, click the *Text/Normal Mode* box in the Colors section and select a color. The default color is white.

To change the cursor appearance:

1. Select *Options - Preferences* from the menu. The Preferences dialog box will appear.
2. In the Caret list, choose *Block* to display the cursor as a block or choose *Underline* to display the cursor as an underline. The default value is Underline.

To enable/disable an exit warning prompt for Telnet Viewer sessions:

1. Select *Options - Preferences* from the menu. The Preferences dialog box will appear.
2. Enable or disable the *Prompt on Exit* checkbox. When the exit warning prompt is enabled, a message appears when you select *Telnet - Exit*. You may then choose to exit or continue the session. When disabled, the session closes without further prompting. The default value is enabled.

To enable/disable autoscaling:

1. Select *Options - Preferences* from the menu. The Preferences dialog box will appear.
2. Enable or disable the *Auto Scale* checkbox. When autoscaling is enabled, the user may reduce or expand the virtual terminal window by dragging a corner of the window. When autoscaling is disabled, the virtual terminal window will not scale when the view is changed; instead, scroll bars will appear around the window. The default value is enabled.

Customizing Session Properties

When you are connected to an appliance or port using the DSVIEW 3 software Telnet Viewer, you may specify session properties that will be stored and reused every time you connect to the selected appliance or port. When you select *Options - Session Properties* in the DSVIEW 3 software Telnet Viewer, the Session Properties dialog box will appear containing Terminal, Login Scripts and Logging tabs.

To change the terminal window size:

1. Select *Options - Session Properties* from the menu or click the *Session Settings* icon in the toolbar. The Session Properties dialog box will appear.
2. Click the *Terminal* tab.
3. In the Rows list, choose a value of 24 or 48. The default value is 24.
4. In the Columns list, choose a value of 80 or 132. The default value is 80.

To change the terminal emulation mode:

1. Select *Options - Session Properties* from the menu or click the *Session Settings* icon in the toolbar. The Session Properties dialog box will appear.
2. Click the *Terminal* tab.
3. From the Terminal Emulation list, choose one option. The default value is VT100. *Terminal Emulation* on page 373 contains encoding and decoding information for each of the terminal emulation types.

NOTE: When connecting to an appliance, the terminal type setting must match the terminal emulation type.

To change the Telnet Viewer Arrow key sequences:

When the Terminal Emulation mode is VT100, VT100+, VT102, VT52, VT220 or VT320, you may specify either VT100 or ANSI **Arrow** key sequences.

Table 20.3: Arrow Key Sequences

Key	VT100	ANSI	VT52
Up Arrow	<Esc> [A	<Esc> OA	<Esc> A
Down Arrow	<Esc> [B	<Esc> OB	<Esc> B
Right Arrow	<Esc> [C	<Esc> OC	<Esc> C
Left Arrow	<Esc> [D	<Esc> OD	<Esc> D

NOTE: When the Terminal Emulation mode is VT52, the **Arrow** keys are interpreted as indicated in this column, regardless of the value in the Arrow Keys list.

1. Select *Options - Session Properties* from the menu or click the *Session Settings* icon in the toolbar. The Session Properties dialog box will appear.
2. Click the *Terminal* tab.
3. In the Arrow Keys list, choose either *VT100* or *ANSI*. The default value is *VT100*.

To change the terminal type:

1. Select *Options - Session Properties* from the menu or click the *Session Settings* icon in the toolbar. The Session Properties dialog box will appear.
2. Click the *Terminal* tab.
3. In the Terminal Type box, enter a value of up to 40 characters, beginning with a letter and ending with a letter or digit. Valid characters are the letters A-Z, digits 0-9, forward slash, dash, left parenthesis and right parenthesis. The terminal type must be entered in the Terminal Type field exactly as shown in Table 20.4.

Table 20.4: Terminal Emulation and Type

Terminal Emulation	Terminal Type
VT52	DEC-VT52
VT100	DEC-VT100
VT100+	DEC-VT100
VT102	DEC-VT102
VT220	DEC-VT220
VT320	DEC-VT320

To change the linefeed settings:

1. Select *Options - Session Properties* from the menu or click the *Session Settings* icon in the toolbar. The Session Properties dialog box will appear.
2. Click the *Terminal* tab.
3. When connecting to devices that do not insert a carriage return in incoming or outgoing data, automatically inserting a line after each line of data can prevent overwriting data when a new line is received.

If the *New Line Mode - Inbound* box is checked, an inbound carriage return from the device will be treated as if both a carriage return and a linefeed were received. If not checked, a linefeed is not added to an inbound carriage return.

If the *New Line Mode - Outbound* box is checked, an outbound carriage return to the device will always be followed by a linefeed character. If not checked, a linefeed is not sent with a carriage return. The default value is disabled for inbound and outbound.

To enable/disable line wrap:

1. Select *Options - Session Properties* from the menu or click the *Session Settings* icon in the toolbar. The Session Properties dialog box will appear.
2. Click the *Terminal* tab.
3. Enable or disable the *Auto wrap line* checkbox. When line wrap is enabled, characters wrap onto the next line when a new character is received and the cursor is at the end of the line. When disabled, new characters will overwrite the last character on the current line when the cursor is at the end of the line. The default value is enabled.

To enable/disable local echo:

1. Select *Options - Session Properties* from the menu or click the *Session Settings* icon in the toolbar. The Session Properties dialog box will appear.
2. Click the *Terminal* tab.
3. When you are connected to a device that does not repeat or echo the data that you type, you may enable Local Echo mode. Otherwise, the Telnet Viewer will not display the text you type. However, if you are connected to a device that echoes data, and you are in Local Echo mode, all of the data you type will appear on your terminal twice.
Enable or disable the *Local echo* checkbox. The default value is disabled.

To enable/disable 7-bit ASCII:

1. Select *Options - Session Properties* from the menu or click the *Session Settings* icon in the toolbar. The Session Properties dialog box will appear.
2. Click the *Terminal* tab.
3. Enable or disable the *Strip 8th bit* checkbox. The default value is disabled.

Login scripts

The Telnet Viewer has a login scripting function that enables you to automatically log in to a device. A login script is built with a sequence of expect and send strings, and initial transmission characters that work with them. To use a login script, you must enable automatic login in a checkbox.

The first Initial character (that is, the first entry in the Initial character column) specifies what is sent to the device as soon as the Telnet Viewer session is established. This is selected from a list containing the choices: None, CR (carriage return), CR+LF (carriage return and linefeed), ESC (Escape) and CTRL+P (Control and P).

The first Expect string indicates what the device will send as its first prompt.

The first Send string indicates what the login script will send to the device after it receives the first Expect string.

You may then build additional Expect and Send strings according to what the particular device will prompt for and what will be sent in response.

To build a login script and enable/disable automatic login:

1. Select *Options - Session Properties* from the menu or click the *Session Settings* icon in the toolbar. The Session Properties dialog box will appear.
2. Click the *Login Scripts* tab.
3. Enable or disable the *Automate login* checkbox. The default value is disabled.
4. In the Initial Character list, select one option: CR (carriage return), CR+LF (carriage return and linefeed), ESC (Escape), CTRL+P (Control+P sequence, 0X10 in hex) or None (no initial transmission character).
5. In the Expect box, type the 1-32 alphanumeric character string that you expect from the device. Spaces are allowed.
6. In the Send box, type the 0-32 alphanumeric character string that you wish to send in response to the Expect string. Spaces are allowed, and a blank field is valid. A CR or CR+LF is appended to the string, based on the New Line Mode - Outbound setting.
7. Repeat the Expect and Send entries as needed, to a maximum of four each.

Reviewing Session Data

During a Telnet Viewer session, you may review the accumulated screen contents by using the scroll bar or the **Arrow** keys. To return to the current session location, press **Enter**. The size of the buffer containing session data that can be reviewed is configurable.

You may optionally choose to change the color of the text and/or the background when you are reviewing session data. When you return to the current session location, the colors will return to those specified in the Telnet Viewer's configuration (see *Customizing the Telnet Viewer* on page 291).

While you are reviewing collected data, new incoming data is buffered, but it will not be displayed until you return to the current session location. You may not enter outgoing data.

To change the maximum number of lines in the session buffer:

1. Select *Options - Session Properties* from the menu or click the *Session Settings* icon in the toolbar. The Session Properties dialog box will appear.
2. Click the *Terminal* tab.
3. In the History Buffer Size box, type a value from 1-1000. The default value is 256.

To change the background and/or text color when reviewing session data:

1. Select *Options - Preferences* from the menu. The Preferences dialog box will appear.
2. To change the background color, click the *Background/History Mode* box in the Colors section and select a color. The default color is blue.
3. To change the text color, click the *Text/History Mode* box in the Colors section and select a color. The default color is white.

Macros

NOTE: Three additional types of macros are available in the DSVIEW 3 management software. Exit macros, created within the DSVIEW 3 Explorer, reside on DS1800 digital switches and DSR switches and are used by these switches. Global macros and personal macros are created using the Video Viewer window and are used with KVM sessions with target devices attached to DS1800 digital switches and DSR switches. None of these macros may be used or are compatible with a Telnet Viewer.

The DSVIEW 3 software Telnet Viewer has a macro function that allows you to create and use macros during Telnet Viewer sessions. A macro comprises a series of keystrokes that you define. Additionally, you may specify a hotkey in the macro's definition. When you define a macro and enable its inclusion in the Macros menu, you may execute the macro during a Telnet Viewer session either by selecting it from the Macros menu or by pressing the defined hotkey on your keyboard.

You may also define one or more global macro or personal macro groups, then add macros to the groups. Personal macro groups may be created by any user and are only available for use on the target device on which they are created. Global macros may only be created by a DSVIEW 3 software administrator and are available for use by any user on the DSVIEW 3 software system.

A macro may belong to more than one macro group or belong to both personal and global macro groups; however, a macro does not have to belong to a macro group. Selecting *Macros - Configure - Groups* takes you to the Configure Macro Groups dialog box which contains a list of defined macro groups from which you may select one group or all defined groups. The macros in the selected group(s) are then available for use during subsequent Telnet Viewer sessions with that device/port.

After defining a macro or a macro group, you may edit or delete it at any time. When you delete a macro or macro group, you are prompted for confirmation. When you change a macro group name, each macro belonging to the changed macro group is updated, but the change is not visible until the next Telnet Viewer session is established. When you delete a macro group, you delete only its name - the individual macros in the group are not affected.

To create a macro:

1. Select *Macros - Configure - Macros* from the menu. The Configure Macros dialog box appears.
2. Click *Create*. The Configure Macros dialog box expands to display an Edit Macro area.
3. In the Macro Name field, Type a 1-64 character name for the macro.
4. To define a hotkey for the macro, choose one from the Key list. To add a modifier to the hotkey, check the *Control*, *Shift* or *Alt* boxes. (A macro's hotkey is accessible only when the macro belongs to the active macro group.)
5. By default, the *Include in Menu* box is checked, indicating the macro will appear in the Macros menu. If you do not wish to include the macro in the Macros menu, uncheck this box. In this case, if the macro definition includes a hotkey, you will still be able to use the hotkey to run the macro, even if the macro's name does not appear in the Macros menu.

6. Type the macro string in the Keystrokes box. For non-printing and special character code sequences, use the following escape sequences:
 - New line: \n
 - Carriage return: \r
 - Form feed: \f
 - Horizontal tab: \t
 - Backspace: \b
 - Delay character (500 ms): \d
 - Hexadecimal code sequence: \0x<NN>, where <NN> is the hexadecimal byte. For example, the **Ctrl+D** character sequence may be sent by using 0x04.
 - Octal code sequence: \0<NNN>, where <NNN> is the octal byte. For example, the **Ctrl+D** character sequence may be sent by using 0004.
7. From the Control Code menu, select the sequence to invoke with the selected characters.
8. In the Access Rights area, specify whether you wish for the macro to be a global macro (available to all users) or a personal macro (available only to the current user).

You must have DSView 3 software administrator privileges to use the Access Rights area.
9. Click *OK*. The Configure Macros dialog box returns to its abbreviated display and the macro appears in the Macros area.
10. Click *OK* to close the Configure Macros dialog box.

To edit an existing macro:

NOTE: You must have DSView 3 software administrator privileges to edit Global Macros.

1. Select *Macros - Configure - Macros* from the menu. The Configure Macros dialog box appears.
2. In the Macros table, select the macro you wish to edit.
3. Click *Edit*. The Configure Macros dialog box expands to display an Edit Macro area containing the information defined for the macro.
4. Edit the macro properties as needed.
5. Click *OK*. The changes are saved and the Configure Macros dialog box returns to its abbreviated view.
6. Repeat steps 2-5 to edit additional macros.
7. Click *OK* to close the Configure Macros dialog box.

To delete a macro:

NOTE: You must have DSView 3 software administrator privileges to delete Global Macros.

1. Select *Macros - Configure - Macros* from the menu. The Configure Macros dialog box appears.

2. Select the macro in the Macros table that you wish to delete.
3. Click *Delete*. A dialog box appears, prompting you to confirm the deletion.
4. Confirm or cancel the deletion.

To use a macro:

1. Select the macro from the Macros menu (if the macro's definition includes a hotkey, press the hotkey or hotkey sequence. A macro's hotkey is accessible only when the macro belongs to the active macro group) or select *Macros - Configure - Macros* from the menu. The Configure Macros dialog box appears.
2. Select the macro in the Macros table that you wish to run.
3. Click *Run*.

Macro groups

To create a macro group:

1. Select *Macros - Configure - Groups* from the menu. The Configure Macro Groups dialog box appears.
2. Click the *Create* button. The Configure Macros dialog box expands to display a Create Group area.
3. In the Group Name field, type a 1-64 character name for the macro group.
4. To add one or more macros to the macro group, select the macro(s) from the Macros Available list, then click *Add*. The macros will be moved to the Macros In Group list.
5. To remove one or more macros from the macro group, select the macro(s) from the Macros In Group list, then click *Remove*. The macros will be moved to the Macros Available list.
6. In the Access Rights area, specify whether you want the macro group to be a Global Macro group (available to all users) or a Personal Macro group (available only to the current user). You must have DSView 3 software administrator privileges to assign access rights.
7. Click *OK*. The Configure Macro Groups dialog box returns to its abbreviated view.
8. Click *OK* to close the Configure Macro Groups dialog box.

To enable a macro group for use during Telnet Viewer sessions:

NOTE: You must have DSView 3 software administrator privileges to enable a macro group.

1. Select *Macros - Configure - Groups* from the menu. The Configure Macro Groups dialog box appears.
2. In the Macro Groups table, select the macro group you wish to enable.
3. Click the *Edit* button. The Configure Macro Groups dialog box expands to display an Edit Group area containing the information defined for the macro.
4. Enable the *Active Group* checkbox.

5. Click *OK*. The changes are saved and the Configure Macro Groups dialog box returns to its abbreviated view.

To edit an existing macro group:

NOTE: You must have DSView 3 software administrator privileges to edit global macro groups.

1. Select *Macros - Configure - Groups* from the menu. The Configure Macro Groups dialog box appears.
2. In the Macro Groups table, select the macro group you wish to edit.
3. Click the *Edit* button. The Configure Macro Groups dialog box expands to display an Edit Group area containing the information defined for the macro.
4. Edit the macro group properties as needed.
5. Click *OK*. The changes are saved and the Configure Macro Groups dialog box returns to its abbreviated view.
6. Repeat steps 2-5 to edit additional macro groups.
7. Click *OK* to close the Configure Macro Groups dialog box.

To delete a macro group:

NOTE: You must have DSView 3 software administrator privileges to delete global macro groups.

1. Select *Macros - Configure - Groups* from the menu. The Configure Macro Groups dialog box appears.
2. Select the macro group in the Macro Groups table that you wish to delete.
3. Click the *Delete* button. A dialog box appears, prompting you to confirm the deletion.
4. Confirm or cancel the deletion.

Logging

The Telnet Viewer has a logging function that saves the contents of a Telnet Viewer session to a file. You may enable automatic logging or dynamically start logging at any time. Additionally, you may pause, resume and stop logging, regardless of whether it was started automatically or dynamically.

While logging is occurring or when it is paused, a Logging Status label appears in the status panel at the bottom of the DSView 3 management software Telnet Viewer window.

NOTE: When you enable or disable automatic logging, the logging will begin or end at the start of the next DSView 3 software Telnet Viewer session to that device. If you change the default log file directory used for automatic logging, the change does not take effect until the next session to that device.

Log files

The format of log filenames is shown below, where <mmddy> represents the month, day and year, and <hhmmss> represents the current hour, minute and second in military time:

```
scvTelnet<mmddy>_<hhmmss>.log
```

The default log directory is session-specific, that is, each Telnet Viewer session may have its own location for storing logfiles. You may change the name of the file and the location of the directory that stores the logfiles. If you do not change the default directory, logfiles are stored in your home directory.

You may display a log file at any time, using a standard text editor. The screen buffer is written to the log file when the buffer is full, or when logging is paused or stopped. To ensure the log file is up-to-date, either pause or stop the logging.

To change the default log file directory:

1. Select *Options - Session Properties* from the menu or click the *Session Settings* icon in the toolbar. The Session Properties dialog box will appear.
2. Click the *Logging* tab. The Default Directory field displays the current default location for logfiles.
3. Click the *Browse* button. The Set Directory dialog box appears.
4. Select a directory from the Look in list or create a new directory. To create a new directory:
 - a. Click the *Create New Folder* button. A new directory named New Folder appears in the directory list.
 - b. Click the *New Folder* entry in the directory list to highlight it. Then, click the entry again to edit its name. Type in a new name. Press **Enter**. The directory appears in alphabetical order in the directory list.
 - c. Select the newly-created directory in the directory list. The Filename field will now contain the name of the new directory.
5. Click the *Set Directory* button to select the newly-created or selected directory as the default log file directory. The Set Directory dialog box will close.
6. The Default Directory field now contains the name of the newly-created or selected directory. Click *OK* to save the new information.

To enable automatic logging:

1. Select *Options - Session Properties* from the menu or click the *Session Settings* icon in the toolbar. The Session Properties dialog box will appear.
2. Click the *Logging* tab.
3. Enable the *Logging* checkbox.
4. The Default Directory field displays the current default location for logfiles. If that is the desired directory, click *OK*. (You may change the default directory.)

Automatic logging will begin when you initiate the next Telnet Viewer session to that device. At that time, the Logging Status label will indicate *Logging*.

To disable automatic logging:

1. Select *Options - Session Properties* from the menu or click the *Session Settings* icon in the toolbar. The Session Properties dialog box will appear.
2. Click the *Logging* tab.
3. Disable the *Logging* checkbox.
4. Click *OK*.

Automatic logging will stop when you close the Telnet Viewer session. When logging stops, the Logging Status label disappears.

To start dynamic logging:

1. Select *Options - Logging - Start* from the menu. The Log dialog box appears.
2. The Look in list contains the default log file directory and the Filename field contains the default log filename. Using this filename format is recommended; however, you may change it for the duration of this Telnet Viewer session. If you choose to use the default log filename, skip to step 4.
3. To change the default log filename for the duration of the dynamic logging session, you may select a directory from the Look in list. The directory list may contain directories and files. To create a new directory:
 - a. Click the *Create New Folder* button. A new directory named New Folder appears in the directory list.
 - b. Click the *New Folder* entry in the directory list to highlight it. Then click the entry again to edit its name. Type in a new name. Press **Enter**. The directory appears in alphabetical order in the directory list.
 - c. Double-click the newly-created directory in the directory list. The Filename field will now contain the name of the new directory.
 - d. Type a new filename in the Filename field. If you enter a filename that already exists, the new file will overwrite the old file.
4. You are prompted to confirm the directory selection and begin logging. Confirm or cancel the logging start.

When logging begins, the Logging Status label will indicate *Logging*.

To pause logging:

Select *Options - Logging - Pause* from the menu. The Logging Status label will change to *Logging Paused*.

To resume logging:

Select *Options - Logging - Resume* from the menu. The Logging Status label will change to *Logging*.

To stop logging:

Select *Options - Logging - Stop* from the menu. The Logging Status label will disappear.

Copying, Pasting and Printing Session Data

In the Telnet Viewer you may:

- Copy a screen of Telnet Viewer session data to the system clipboard
- Copy all of the Telnet Viewer session buffer contents to the system clipboard
- Copy a highlighted portion of the Telnet Viewer session data to the system clipboard
- Paste the contents of the system clipboard into a Telnet Viewer session or into another application
- Print a screen of the Telnet Viewer session data

Information that is copied from a DSView 3 software Telnet Viewer session may be pasted into other applications. Similarly, information copied from other applications may be pasted into a Telnet Viewer session.

NOTE: Only textual data may be copied and pasted in the DSView 3 software Telnet Viewer.

To copy a Telnet Viewer session window screen:

Select *Options - Copy Screen* from the menu or click the *Copy Screen* icon in the toolbar.

The screen contents will be saved to the system clipboard. You may then paste the clipboard contents into a Telnet Viewer session or into another application.

To copy all of the Telnet Viewer session buffer contents:

Select *Options - Copy Buffer* from the menu or click the *Copy Buffer* icon in the toolbar.

The entire buffer will be copied to the system clipboard (regardless of the amount of data in it. You may then paste the clipboard contents into a Telnet Viewer session or into another application.

To highlight and copy a portion of a Telnet Viewer window screen:

NOTE: When autoscaling has been enabled and the window has been scaled, you will not be able to highlight text until you click the *Restore* icon in the toolbar.

1. Use the mouse to drag-select the portion of the screen text you wish to copy.
2. Select *Options - Copy Text* from the menu.

-or-

Click the *Copy Text* icon in the toolbar.

-or-

Right-click and select *Copy Text* from the pop-up menu.

The highlighted text will be copied to the system clipboard. You may then paste the clipboard contents into a Telnet Viewer session or into another application.

To paste system clipboard contents:

1. Place textual data on the system clipboard, using a text editor or other application.
2. Initiate a Telnet Viewer session.
3. At the point where you wish to paste the clipboard contents, select *Options - Paste* from the menu or click the *Paste* icon in the toolbar.

To print a Telnet Viewer window screen:

1. Select *Options - Print Screen* from the menu or click the *Print Screen* icon in the toolbar.
2. The operating system's print dialog box appears. Make the appropriate settings. The screen contents will then be sent to the printer.

Power Control of Devices Attached to Power Devices

NOTE: A user must have DSView 3 software administrator privileges to control the power of a target device.

If a target device attached to an appliance port is connected to a power device outlet and the target device has been accessed in a serial session, you may power up, power down or cycle (power down and then power up) the target device using the Power Control dialog box.

NOTE: This operation is valid only during serial sessions.

The Options - Power menu option will not be available if the target device cannot be power controlled using the DSView 3 software, or if the user does not have power control access rights.

The current state of the power device outlet appears in the Current Power Status area of the dialog box. As you change the power state, the information is updated in real time.

Depending on the configuration of a power device outlet, it may not immediately respond to a power change request (for example, it may be configured to remain off for a specific period of time).

To power up, power down, or power cycle a target device:

1. Select *Options - Power* from the Telnet Viewer main window. The Power Control dialog box will appear.
2. Click *On*, *Off* or *Cycle*.
3. Click *Close* to close the dialog box.

Closing a Telnet Viewer Session

To close a Telnet Viewer session:

Select *File - Exit* from the Telnet Viewer window.

Using Tools

The DSView 3 management software contains tools that may be used to perform various actions on units. This chapter describes the available tools and how to use them.

Using Unit Tools

The Unit Tools window contains tools that allow a user to:

- Export unit information to a .csv (comma separated value) file
- Export unit access rights information to a .csv file
- Merge two or more target devices into a single target device
- Simultaneously merge multiple target devices and power outlets
- Import a DSView 2.x software database into the DSView 3 management software (valid only when the DSView 3 software is installed on supported Windows systems)
- Import data in an XML format into the DSView 3 software database

To display the Units Tools window:

1. Click the *Units* tab.
2. Click *Tools* in the side navigation bar. The Unit Tools window will open.

Exporting units

The Export Units tool will export information about units into a .csv file. Unit names are always exported. The following unit properties may be selected for export:

Action (default action)	Primary contact phone
Browser URL	Secondary contact
Custom field 1-3	Secondary contact phone
Department	Serial number
DSView server name	Site
IP address	Status (at time of export)
Location	Telnet port
Model number	Type
Part number	Visibility (show or hide)

Primary contact

You may also export a topology report, regardless of any properties selected for export. A topology report contains the following columns:

- Port - (target devices or cascade switches only) Port number on the appliance to which the target device or cascade switch is connected.
- Type - (managed appliances only) Appliance type, if known.
- Level - Level of connection from the appliance. A managed appliance is level 0. A target device attached to a managed appliance is 1, and so on.

The output .csv file may be viewed in a text editor or spreadsheet application, such as Microsoft Excel.

To export units:

1. Click the *Units* tab.
2. Click *Tools* in the side navigation bar. The Unit Tools window will open.
3. Click the *Export Units* icon or link. The Export Units Wizard will appear.
4. To add one or more properties to be exported, select the properties in the Available Properties list, then click *Add*. The properties will be moved to the Properties to Export list.
5. To remove one or more properties to be exported, select the properties from the Properties to Export list, then click *Remove*. The properties will be moved to the Available Properties list.
6. To change the order in which properties are listed in the output .csv file, select one or more properties in the Properties to Export list and use the up and down arrows to move the selected properties up or down in the listing.
7. To create a topology report, enable the *Export Topology* checkbox. If any properties are also being exported, they will be listed after the topology information in the report.
8. Click *Next*.
9. The Save Process window will open. Click *Next*.
10. The Completed Successful window will open, along with a File Download dialog box.
11. Click *Open*. The file will download and open. By default, .csv files are configured to open in Microsoft Excel. If Microsoft Excel is not installed on your computer, you will be prompted to select a text editor to use for opening the .csv file.

The default filename of the .csv file is unitproperties.csv. Subsequent files that you export will be incremented (unitproperties[1].csv, unitproperties[2].csv and so on).

-or-

Click *Save*. The Save As dialog box will appear. Select a directory and filename and click *Save* to save the .csv file.

12. Click *Finish*. The Units Tools window will open.

Exporting access rights

The Export Access Rights tool will export permission information about units from the DSView 3 management software host. The unit name and the user/user group to which the unit has access rights will be exported. Additionally, the unit access right settings will be exported; see *About Access Rights* on page 144.

The output .csv file may be viewed in a text editor or spreadsheet application, such as Microsoft Excel.

To export access rights:

1. Click the *Units* tab.
2. Click *Tools* in the side navigation bar. The Unit Tools window will open.
3. Click the *Export Access Rights* icon or link. The Export Access Rights Wizard will appear.
4. Select either *All Units*, *Appliances*, *Target Devices* or *Unit Groups*, for the unit type and click *Next*.
5. The Save Process window will open. Read the text, then click *Next*.
6. When prompted, enter the location and filename where the exported access rights will be saved.
7. The Completed Successful window will open, along with a File Download dialog box.
8. Click *Open*. The file will download and open. By default, .csv files are configured to open in Microsoft Excel. If Microsoft Excel is not installed on your computer, you will be prompted to select a text editor to use for opening the .csv file.

The default filename of the .csv file is `appliance_rights.csv` if you are exporting managed appliance rights or `target_device_rights.csv` if you are exporting target device rights. Subsequent files that you export will be incremented (`target_device_rights[1].csv`, `target_device_rights[2].csv` and so on).

-or-

Click *Save*. The Save As dialog box will appear. Select a directory and filename and click *Save* to save the .csv file.

9. Click *Finish*. The Units Tools window will open.

Merging target devices

Using the Merge Target Devices tool may be necessary if a target device is connected to one or more managed appliances. For example, if a target device is connected to both a DSR switch and an ACS console server, this tool will merge the target devices (that were created when the managed appliances were added) into a single target device that contains all of the target actions.

You may also merge one or more target devices from a Unit Overview window; see *Merging target devices* on page 133.

To merge target devices:

1. Click the *Units* tab.
2. Click *Tools* in the side navigation bar. The Unit Tools window will open.
3. Click the *Merge Target Devices* icon or link. The Merge Target Devices Wizard will appear.
4. The Select Target Devices to Merge window will open.
 - To add one or more target devices to the merge list, select the target device(s) in the Available Target Devices list, then click *Add*. The target devices will be moved to the Target Devices to Merge list.
 - To remove one or more target devices from the merge list, select the target device(s) from the Target Devices to Merge list, then click *Remove*. The target devices will be moved to the Available Target Devices list.
 - To merge target devices in a particular order, select one or more target devices in the Target Devices to Merge list and use the up and down arrows to move the selected target devices up or down in the listing. Once the order has been specified, select *Merge missing properties to the target device based on the order of the devices in the "Target Devices to Merge" list*.

The merged target devices will contain the name of the first target device in the Target Device to Merge list. For example, if you are merging two target devices named TD1 and TD2, and TD2 is listed before TD1, the merged target device will be named TD2.

Click *Next*.

5. The Confirm Target Device Merge window will open. Click *Next* to confirm merging the connection paths into the specified destination target device. See *Connections to Units* on page 181.
6. The Completed Successful window will open.
7. Click *Finish*. The Units Tools window will open.

Merging target device endpoints

As an alternative to merging target device connections one at a time, the Merge Target EndPoints Wizard allows you to simultaneously merge multiple target devices and power outlets. The target device endpoint is defined as the target device or power outlet at the end of the connection path. For more information about connections, see *Connections to Units* on page 181.

To merge target device endpoints:

1. Click the *Units* tab.
2. Click *Tools* in the side navigation bar. The Unit Tools window will open.
3. Click the *Merge Target EndPoints* icon or link. The Merge Target EndPoints window will appear.
4. From the Available Power Devices list, select the power devices that contain power connections to be merged with target devices and click *Add*.

5. Click *Refresh* to display a list of power connections.
6. For each power connection you wish to merge, type the name of the target device you wish to merge with the power connection. The target device name entered must match the name of the target device in the DSView 3 database; target device names are case-sensitive and 1-64 characters long.
7. Click *Merge*.

Importing DSView 2.x software databases

NOTE: This procedure is available only when the DSView 3 software is installed on a supported Windows system.

The Import DSView 2.x software database tool allows you to import an existing DSView 2.x software database into the DSView 3 software system. When a database is imported, the following items will be imported:

- Units, including attached cascade switches, power devices and target devices
- Users and user groups with unit access rights
- Authentication services, including Windows NT domains, LDAP and local accounts
- System settings, including the ability to display connected users, connection sharing, status polling and delay rates and when the event log is deleted

The following actions occur when a DSView 2.x software database is imported into the DSView 3 management software system:

- A global unit group is created in the system for each group found in the DSView 2.x software database. The DSView 3 software does not provide DSView 2.x software Topology unit group nesting. Unit group names added to the system are a concatenation of the hierarchical names found in the DSView 2.x software, including the truncation of names when necessary.
- If a user had Admin rights in the DSView 2.x software for all nodes in the tree (including the Topology node), the user will be added as a member and inherit the access rights of a DSView administrator user group member in the DSView 3 software.

If a user had Admin rights in the DSView 2.x software for all nodes in the tree except for the Topology node, the user will be added as a member and inherit the access rights of an appliance administrator user group member in the DSView 3 software.

If a user had any other type rights in the DSView 2.x software, the user will be added as a member of the user group in the DSView 3 software. Access rights are set for units to which the user has access as follows:

- A user with User rights to a target device in the DSView 2.x software will be assigned the Establish Viewer Sessions access right in the DSView 3 software.
- A user with Admin rights to a target device in the DSView 2.x software will be assigned the Configure Unit Settings, Establish Viewer Sessions and Control Target Device Power access rights in the DSView 3 software.

- A user with User rights to a DS1800 digital switch, CPS appliance or DSR switch in the DSVIEW 2.x software will not be assigned any access rights in the DSVIEW 3 software.
- A user with Admin rights to a DS1800 digital switch, CPS appliance or DSR switch in the DSVIEW 2.x software will be assigned the Reboot Appliance, Flash Upgrade Appliance and Configure Appliance Settings access rights in the DSVIEW 3 software.
- Cascade switch types in the DSVIEW 2.x software database cannot be determined during the import process and are added as Generic 1 x <n> switches, based on the number of found switch channels. After importing the DSVIEW 2.x software database and running the Migrate DSVIEW 2.X Units task, you may run the Resync Wizard on individual CPS appliances, DS1800 digital switches and DSR switches to specify switch types and merge multiuser switches. See *Resynchronizing units* on page 315.
- Internal users and built-in user groups with DSVIEW 2.x software permissions residing on the computer that ran the DSAuth server will be imported into the DSVIEW 3 software system. An external NT authentication service with the same name as the DSAuth server will be added to the DSVIEW 3 software system. The DSVIEW 2.x software users and user groups will be associated with the authentication service added to the DSVIEW 3 software system.
- The DSVIEW 2.x software Everyone user group cannot be imported into DSVIEW 3 software systems.

Before using the Import DSVIEW 2.x Software Database tool

To use the Import DSVIEW 2.x Software Database tool, you must create a backup of the database using the DSAuth Migration Utility. The database is saved as a .zip file which may then be imported into the DSVIEW 3 software system using the Import DSVIEW 2.x Database tool.

The DSAuth Migration Utility will shut down the DSVIEW 2.x DSAuth service as it runs and will restart the service upon completion.

To backup the database:

1. On the computer containing the DSVIEW 2.x software database (that is, the DSAuth Server) that you wish to migrate, insert the DSVIEW 3 software DVD. An autorun file will display the DSVIEW 3 management software screen.
2. Click *Run DSVIEW 2.x Migration*.
-or-
If autorun is not enabled, type **<drive:>Migration Utility\DSMigration.exe**, where <drive:> is the letter of your DVD drive. The DSAuth Migration Utility dialog box will appear.
3. Click *Backup*. The Save As dialog box will appear.
4. Select a directory and filename and click *Save*. The Status area of the DSAuth Migration Utility dialog box will contain messages as the backup is created. A Finished message box will appear when the backup is completed.
5. Click *OK*.

To import DSView 2.x software databases:

1. In the Units Tools window, click the *Import DSView 2.x Database* icon or link. The Import DSView 2.x Database Wizard will appear.
2. Use the *Browse* button to locate the .zip backup file of the DSView 2.x software database you created, then click *Next*.
3. The Select Import Options window will open.
 - a. Select *Import DSView 2.x system settings and apply them to this system* to allow the following settings to be imported from the DSView 2.x software database migration file into your DSView 3 software system:
 - Whether connected users may be viewed. See *Video Viewer session properties* on page 253.
 - Whether connections are automatically shared when a KVM session is started. See *Video Viewer session properties* on page 253.
 - Whether polling is enabled or disabled. See *Unit status polling* on page 69.
 - The delay between polling cycles. See *Unit status polling* on page 69.
 - The retention time of the event log. See *Changing the Event Log Retention Period* on page 346.
 - b. Select *Allow Target Devices to be added for nodes that have a default name* to allow target devices to be added to your DSView 3 software system for nodes in the DSView 2.x software migration file that have default names. In DSView 2.x software, a default name is considered to be a name such as Port 1, Channel 1 and Socket 1.
All default names are adjusted when they are imported to include the name of each CPS appliance, DS1800 digital switch and DSR switch.
 - c. Select *Allow nodes with the same name to be merged into the same target device* if you wish to merge a target device that has multiple connections into a single target device. For example, a target device may be connected to both a DSR switch and a power device.
 - d. Select *Add Active Directory authentication services instead of NT authentication services when Active Directory is detected* to add an Active Directory service when an Active Directory domain is detected in the DSView 2.x software database migration file. If this option is not selected, the service will be added to the DSView 3 software system as a Windows NT Domain service.
 - e. Type the case-insensitive names of any DSView 2.x software database nodes that you do not wish to import, separated by commas (,), in the *Node Names to Ignore* field. Any children within the parent nodes listed in the field are also ignored (that is, not imported). You may import a node containing a comma on its name by enclosing the node name in quotation marks. For example, to import a node named node, two (containing a comma) and a node named nodeone, type “**node,two**”,**nodeone** in the Node Names to Ignore field.
 - f. Click *Next*.

4. The Import in Progress window will open, displaying the current step being performed, as the DSView 2.x software database is importing. When the import completes, the Completed Successful window will open with a summary of the import, including the number of authentication services, users, user groups, units and unit groups added.
5. Click *Finish*. The Units Tools window will open.

After running the Import DSView 2.x Database tool

Units requiring migration will contain *Migration Needed* in the Migration Status field of Units View windows.

Although the managed appliances have been imported from the DSView 2.x software database into the DSView 3 software system, they are not yet compatible with the DSView 3 software. To complete the configuration and update the firmware on each type of managed appliance, you must use the Migrate Units task. See *Task: Migrating units* on page 326.

Importing data

You can use the Import Data Wizard to migrate data from the AlterPath[®] Manager to the DSView 3 software. First, you will need to export the data from the AlterPath Manager into an XML format that is recognized by DSView 3 software. See the AlterPath Manager Data Migration Technical Bulletin for more information.

To import data:

1. Click the *Units* tab.
2. Click *Tools* in the side navigation bar. The Unit Tools window will open.
3. Click the *Import Data* icon or link. The Import Data Wizard will appear.
4. In the File field, type the path and name of the import file or browse to the file location. The file must be a valid DSView 3 software data import file in an XML format. Click *Next*.
5. The Select Import Options window will open. Specify the User Password Options. Select *Set the user's password to the user's username* or *Set the user's password to a default value*. If you choose a default password value, type a 3-64 character password in the Password and Confirm Password fields.
6. Specify the Account Options. Depending on which options you choose, you may select multiple checkboxes. Only valid combinations will be enabled. You may choose from the following options:
 - Disable user account
 - User must change password at next login
 - User cannot change password
 - Password never expires
7. Click *Next*. The Import In Progress message will display until the import attempt is complete. If the import is successful, the Completed Successful window will open and display a summary of the results.

If the import was not successful, the Completed Unsuccessful window will open and display the errors that caused the import to fail. If some items could not be imported, a message will direct you to a .csv file with more information. You may attempt to import the data again.

8. Click *Finish*.

Although data has been imported from the AlterPath Manager to the DSView 3 software system, the units are not yet compatible with the DSView 3 software. To complete the configuration and import process, you must use the Migrate Units task. When creating the Migrate Units task, it is recommend that you select *Enable Secure Mode* for the units. See *Task: Migrating units* on page 326.

Using the Managed Appliance Tools

The DSView 3 management software contains tools that allow you to perform the following actions on a supported KVM switch or serial console appliance:

- Reboot
- Upgrade the firmware
- Resynchronize the managed appliance so that it reflects the current DSView 3 software system configuration
- Save or restore the configuration
- Save or restore the database of local users

To access the managed appliance tools:

1. Click the *Units* tab. In the side navigation bar, click one of the following:
 - *Appliances* - The Appliances - All window will open. You may also click on a link below Appliances to display only specific types of managed appliances in an Appliances window.
 - *Sites* and then click on a site link - A Units in Site window will open.
 - A custom field label and then the label you specified for the managed appliance - The Units in Custom Fields window will open.
 - *Recently Accessed* - The Recently Accessed Units window will open.
2. Click on the name of a managed appliance. The Unit Overview window will open. The tools are listed in the Tools section of the window.

Rebooting

To reboot one or more managed appliances from a Units View window:

1. In a Units View window (see *Accessing Units View windows* on page 106), click the checkbox next to the appliance. To reboot all managed appliances in the page, click the checkbox to the left of Name at the top of the list. (If the page lists units other than managed appliances, they will not be affected.)

2. Click *Operations*, then select *Reboot* from the menu. A confirmation dialog box will appear.
3. Confirm or cancel the reboot. If confirmed, all active sessions will be disconnected. A Multiple Unit Operation window will open, containing a link to another window where results may be viewed; see *Multiple unit operations from a Units View window* on page 111.

To reboot a managed appliance from a Unit Overview window:

NOTE: To reboot a KVM switch or serial console appliance, you must have Reboot Appliance access rights. By default, users who are members of the DSView 3 software administrators, user administrators and appliance administrators built-in groups have this access right. See *About Access Rights* on page 144.

1. In the Unit Overview window, click the *Reboot* icon or link. A confirmation dialog box will appear.
2. Confirm or cancel the reboot. If confirmed, all active sessions will be disconnected.

Upgrading firmware

To upgrade the firmware on a managed appliance:

NOTE: A valid Flash file must exist in the DSView 3 server's firmware repository for the KVM switch or serial console appliance to use this command. Optionally, one or more managed appliances may be Flash upgraded as a task. See *Task: Updating the firmware of an appliance type* on page 329.

1. In the Unit Overview window, click the *Upgrade Firmware* icon or link. The Upgrade Appliance Firmware Wizard will appear.
2. The Select Firmware Files window will open.
 - To add one or more Flash files to the update list, select the file(s) in the Available Firmware Files list, then click *Add*. The properties will be moved to the Firmware Files to Update list.
 - To remove one or more firmware files from the update list, select the file(s) from the Firmware Files to Update list, then click *Remove*. The firmware files will be moved to the Available Firmware Files list.
 - The firmware on each managed appliance will be upgraded in the order shown in the Update list. A reboot will be automatically performed between each firmware update. To change the order in which firmware files are installed on the managed appliance, select one or more firmware files in the Firmware Files to Update list and use the up and down arrows to move the selected firmware files up or down in the listing.

Click *Next*.

3. The Type in Task Name window will open. Type a 1-64 character name for the upgrade firmware task, then click *Next*.
4. The Completed Successful window will open. To check the progress of the upgrade task, click the *Click here to view results* link. (You may also check the upgrade task progress while the task is running by clicking the *System* tab and then clicking *Tasks* in the top navigation bar; however, the upgrade task will be removed from the task list when it completes.)

5. Click *Finish*. The Unit Overview window will open.

Resynchronizing units

When a unit changes its configuration, it may not be properly represented in the DSView 3 software system. For example, a target device may be added, removed or moved. Resynchronizing will update these and other changes made to the unit within the DSView 3 software system.

Resynchronizing will force a check of the entire DSView 3 software system. The process requires a large amount of time and network bandwidth and should only be performed when necessary.

Alternatively, you may use the automatic topology synchronization feature or synchronize selected units manually from a Units View window. See *Topology Synchronization* on page 130.

To resynchronize a unit:

1. In the Unit Overview window, click the *Resync* icon or link. The Resync Unit Wizard will appear.
2. The Select Resync Options window will open. (For more information about the resync options, see *Topology synchronization options in the Resync Wizard* on page 132.)
 - a. Enable the *Remove offline connections* checkbox to remove from the DSView 3 software database any connections to target devices that are reported as offline in the appliance. The Resync Wizard does not add offline connections to the DSView 3 software database.
 - b. Enable the *Delete target devices that no longer have connections* checkbox to delete those target devices permanently from the DSView 3 software database.
 - c. Enable the *Allow target devices with the same name to be merged into a single target device* checkbox to allow the DSView 3 software to treat multiple target devices with the same name as one unit with multiple access methods.
 - d. Enable the *Allow target devices that contain default names to be added* checkbox to allow target devices that have default names in the managed appliances to be added to the DSView 3 software database.
 - e. Click *Next*.
3. If the unit does not require resynchronizing, the Completed Successful window will open. If the unit requires resynchronizing, the Changes Detected in Appliance window will open. Click *Next* and go to step 7.

If one or more cascade switches are attached to the KVM switch, the Cascade Switch Configuration window will open. Go to step 4.
4. Select the type of each detected cascade switch.
5. Type a name for each cascade switch.
6. Optionally, combine any multiuser cascade switches. Click the checkboxes of the cascade switches that you wish to merge, and then click *Merge*.

To unmerge any cascade switches that you have merged, click the checkbox of the merged cascade switch and then click *Split*.

7. Click *Next*. The Completed Successful window will open.
8. Click *Finish*. The Unit Overview window will open.

Saving a managed appliance configuration

You may save the configuration of a KVM switch or serial console appliance to a file. The configuration file will contain information about the managed appliance, including the following:

- Global settings
- Port settings
- SNMP trap settings
- SNMP manager settings
- The names of connected target devices

For information on restoring a configuration file, see *Restoring a managed appliance configuration* on page 316.

To save a managed appliance configuration to a file:

1. In the Unit Overview window, click the *Save Configuration* icon or link. The Save Appliance Configuration Wizard will appear.
2. Type a description of the configuration that will be saved and may be used if you wish to restore the configuration at a later time, and then click *Next*.
3. The Completed Successful window will open.
4. Click *Finish*. The Unit Overview window will open.

Restoring a managed appliance configuration

You may restore the configuration of a KVM switch or serial console appliance. To restore the configuration, a previously-saved configuration file must exist. See *Saving a managed appliance configuration* on page 316.

Appliance configuration files are stored in the DSView 3 server appliance files repository. You may display the available configuration files by clicking the *System* tab, clicking *Appliance Files* in the top navigation bar and clicking *Configuration* in the side navigation bar.

To restore a managed appliance configuration:

1. In the Unit Overview window, click the *Restore Configuration* icon or link. The Restore Appliance Configuration Wizard will appear.
2. Click the radio button to the left of the file containing the configuration you wish to restore, and then click *Next*.
3. The Completed Successful window will open.
4. Click *Finish*. The Unit Overview window will open.
5. Reboot the managed appliance to enable the restored configuration. See *Rebooting* on page 313.

Saving a managed appliance user database

NOTE: You may not save the user database of a DS1800 digital switch or DSR1161, DSR2161, DSR4160, DSR800 switch.

You may save the local user database on a KVM switch or serial console appliance. For information on restoring a user database, see *Restoring a managed appliance user database* on page 317.

To save the user database of a managed appliance:

1. In the Unit Overview window, click the *Save User Database* icon or link. The Save Appliance User Database Wizard will appear.
2. Type a description of the user database that will be saved and can be used if you wish to restore the database, and then click *Next*.
3. The Completed Successful window will open.
4. Click *Finish*. The Unit Overview window will open.

Restoring a managed appliance user database

NOTE: You may not restore the user database of a DS1800 digital switch or DSR1161, DSR2161, DSR4160 or DSR800 switch.

You may restore the local user database of a KVM switch or serial console appliance. To restore the user database, a previously saved user database file must exist. See *Saving a managed appliance user database* on page 317.

User database files are stored in the DSView 3 server appliance files repository. You may display the available database files by clicking the *System* tab, clicking *Appliance Files* in the top navigation bar and clicking *User Database* in the side navigation bar.

To restore the user database of a managed appliance:

1. In the Unit Overview window, click the *Restore User Database* icon or link. The Restore Appliance User Database Wizard will appear.
2. Click the radio button to the left of the managed appliance user database you wish to restore, and then click *Next*.
3. The Completed Successful window will open.
4. Click *Finish*. The Unit Overview window will open.
5. Reboot the managed appliance to enable the restored user database. See *Rebooting* on page 313.

Using Tasks

You may add, delete and change tasks from the Tasks window. The Tasks window lists all tasks configured in the DSView 3 management software system and allows you to manually run tasks.

Using the Tasks Window

To display the Tasks window:

1. Click the *System* tab.
2. Click *Tasks* in the top navigation bar. The Tasks window will open.

Customizing the Tasks window

The following fields may be displayed in the Tasks window: Use the *Customize* link to add or remove fields in the display. See *Using the Customize link in windows* on page 28.

- **Runs On** - Server(s) on which the task will run.
- **Next Run** - Next date and time on which the task is scheduled to run. This field will be blank for a task scheduled on a remote DSView 3 server.
- **Last Run** - Date and time of the last run of the task. This field will be blank for a task scheduled on a remote DSView 3 server.
- **Schedule** - How often and when the task is scheduled.
- **Status** - Status of a task. An icon in the Name column also indicates the task status.

Table 22.1: Task Status Icons





Icon	Task
	Idle - Task is not currently running
	Running - Task is currently running
	Stopping - Task has run but has not completely stopped

Table 22.1: Task Status Icons (Continued)

Icon	Task
	Disabled - Task was prevented from executing
	Remote - Task is scheduled on a remote DSView 3 server

Adding tasks

You may use the Add Task Wizard to run the following tasks:

- Backup the DSView 3 software database and system files
- Configure SNMP trap settings on appliance
- Control power of target devices
- Export event log to comma separated values (.csv) file
- Migrate units (configures and upgrades DSView 2.x or AlterPath Manager software units)
- Send IPMI chassis control command to target devices
- Test modem connections to selected units
- Upgrade firmware of selected appliances of the same type
- Validate external authentication server user accounts
- Pull names from selected units
- Update topology for selected units
- Backup the Power Manager database
- Restore the Power Manager database

Specifying when to run tasks

You may choose to run tasks at the following times:

- Run task now - Runs the task immediately after you click *Finish* when adding the task in the Add Task Wizard. The Status column will indicate Running and the running icon will appear to the left of the task name.
- One time only - Runs the task once at a specific time on a specific date.
- Periodic - Runs the task a certain number of times per hour or day, beginning at a specific time on a specific date.
- Daily - Runs the task once every day, once Monday-Friday or regularly for a certain number of days (every 2 days, every 3 days and so on), beginning at a specific time on a specific date.

- **Weekly** - Runs the task once each week or regularly over a certain number of weeks (every 2 weeks, every 3 weeks and so on), beginning at a specific time on a specific date. You may also specify which days you wish for the task to run.
- **Monthly** - Runs the task once each month or regularly over a certain number of months (every 2 months, every 3 months and so on) beginning at a specific time on a specific date. You may also specify specific months for the task to run.

To run a task periodically:

1. In the Select When to Run the Task window of the Add Task Wizard, click *Periodic*.
2. The Specify Periodic Schedule window will open.
 - a. Select the hour, minute and AM or PM to indicate when to begin running the task.
 - b. Click *Every (minutes)* and select a number of minutes or click *Every (hours)* and select a number of hours.
 - c. Click on the calendar button or the field to the left of the calendar button and select a date to begin running the task. To use the calendar:
 - Click on the year and select a year.
 - Click on the month name and select a month or use the arrows at the top of the calendar to move forward and backward by month.
 - Click on a day in the calendar to close the calendar and fill the field to the left of the calendar with the date you have selected.

To run a task daily:

1. In the Select When to Run the Task window of the Add Task Wizard, click *Daily*.
2. The Specify Daily Schedule window will open.
 - a. Select the hour, minute and AM or PM to indicate when to begin running the task.
 - b. Click *Every Day* to run the task each day of the week (Sunday-Saturday).
-or-
Click *Weekdays* to run the task once each weekday (Monday-Friday).
-or-
Click *Every (days)* and select the number of consecutive days (1-365).
 - c. Click on the calendar button or the field to the left of the calendar button and select a date to begin running the task. To use the calendar:
 - Click on the year and select a year.
 - Click on the month name and select a month or use the arrows at the top of the calendar to move forward and backward by month.
 - Click on a day in the calendar to close the calendar and fill the field to the left of the calendar with the date you have selected.

To run a task weekly:

1. In the Select When to Run the Task window of the Add Task Wizard, click *Weekly*.
2. The Specify Weekly Schedule window will open.
 - a. Select the hour, minute and AM or PM to indicate when to begin running the task.
 - b. Click *Every (weeks)* and select the number of consecutive weeks (1-52).
 - c. Select the day of week to run the task from the list box. Multiple weeks may be selected by pressing **Ctrl** while clicking on the weeks.
 - d. Click on the calendar button or the field to the left of the calendar button and select a date to begin running the task. To use the calendar:
 - Click on the year and select a year.
 - Click on the month name and select a month or use the arrows at the top of the calendar to move forward and backward by month.
 - Click on a day in the calendar. The calendar will close and fill the field to the left of the calendar with the selected date.

To run a task monthly:

1. In the Select When to Run the Task window of the Add Task Wizard, click *Monthly*.
2. The Specify Monthly Schedule window will open.
 - a. Select the hour, minute and AM or PM to indicate when to begin running the task.
 - b. Click *Day* and select the day of the month to run the task.

-or-

Click *The* and select a week and a day of the week to run the task. For example, if you wish to run the task each second Tuesday of the month, select *second* from the first menu and *Tuesday* from the second menu.
 - c. Select the month to run the task from the list box. Multiple months may be selected by pressing **Ctrl** while clicking on the months.
 - d. Click on the calendar button or the field to the left of the calendar button and select a date to begin running the task. To use the calendar:
 - Click on the year and select a year.
 - Click on the month name and select a month or use the arrows at the top of the calendar to move forward and backward by month.
 - Click on a day in the calendar. The calendar will close and fill the field to the left of the calendar with the selected date.

Adding tasks using the Add Task Wizard

Tasks may be added only by DSView 3 software administrators.

Task: Backup DSView 3 software database and system files

This task creates a compressed .zip file containing a backup of your DSView 3 software system. The backup file contains everything necessary to fully restore the DSView 3 software hub server. The backup file is named `dsviewBackup.zip` by default, but you may also append the date and time to the end of the backup filename.

If a backup is restored to a server with a different IP address, managed appliances may not be able to authenticate until the new DSView 3 server IP address has been programmed into the managed appliances.

Once this task is added, you may run it on demand at any time; see *Running tasks manually* on page 334. You may also create a backup manually; see *Backing up and Restoring Hub Servers Manually* on page 69.

To add the task:

1. Click the *System* tab.
2. Click *Tasks* in the top navigation bar. The Tasks window will open.
3. Click *Add*. The Add Task Wizard will appear.
4. Select *Backup DSView database and system files* from the drop-down menu. Type a 1-64 character name for the task.
5. Select a time to run the task, then click *Next*. See *Specifying when to run tasks* on page 320.
6. The Specify DSView System Backup Properties dialog box will appear.
 - a. Type the directory location in which to create the system backup, which may be a physical local drive on the DSView 3 server or a shared network location specified by a UNC (Universal Naming Convention) path. The Location field cannot be set to a mapped network drive. The directory name must be entered in case sensitive text if your operating system supports case sensitive filenames.
 - b. If the specified directory location is a network path that requires a login, enable the *Login required to access shared drive location* checkbox. Then type the username and password and confirm the password of a user account that has read/write access to the network share location.
 - c. To encrypt the created system backup file, enable the *Encrypt Backup File* checkbox, then type a password to lock and unlock the encrypted file.
 - d. To append the date and time (in military time) to the end of the system backup filename, enable the *Use date and time for file naming* checkbox. For example, if you are creating the backup file on October 1, 2005 at 10:04 pm, the file created will be named `dsviewBackup1001052204.zip`.
 If a system backup file already exists in the specified directory and this option is not enabled, the existing backup file will be overwritten when the new backup file is created.
7. Click *Finish*.

Task: Configure SNMP trap settings on a managed appliance

This task turns SNMP traps on or off for one or more managed appliances of a particular type. To specify SNMP trap settings for other types of managed appliances, you must create additional tasks.

Once this task is added, you may run it on demand at any time; see *Running tasks manually* on page 334. You may also configure SNMP trap settings manually; see *Managed Appliance SNMP Settings* on page 149.

To add the task:

1. Click the *System* tab.
2. Click *Tasks* in the top navigation bar. The Tasks window will open.
3. Click *Add*. The Add Task Wizard will appear.
4. Select *Configure SNMP trap settings on appliance* from the drop-down menu. Type a 1-64 character name for the task.
5. Select a time to run the task (see *Specifying when to run tasks* on page 320), then click *Next*.
6. The Select Unit Group window will open. Select *All Appliances* or select a unit group, then click *Next*.
7. The Select Appliance Type window will open. Select the type of managed appliance for which to configure SNMP traps, then click *Next*.
8. The Select Appliances window will open. Select one or more managed appliances from the Available Appliances list, then click *Add*. The unit(s) will be moved to the Appliances to Configure list. Then click *Next*.
9. The Configure SNMP Traps window will open. Change the trap state by selecting one of the following from each trap menu, then click *Next*.
 - *No Change* - uses the trap on/off state already configured.
 - *Enable* - turns the trap on.
 - *Disable* - turns the trap off.-or-

Click one of the following buttons:

 - *No Change All* - uses the on/off states already configured.
 - *Enable All* - turns all traps on.
 - *Disable All* - turns all traps off.
10. Click *Finish*.

Task: Power control a target device

This task powers up, powers down or cycles the power (powers down and then powers up) of one or more target devices.

Once this task is added, you may run it on demand at any time; see *Running tasks manually* on page 334. There are other ways to power control a target device; see *Power Control of Devices Attached to Power Devices* on page 169.

To add the task:

1. Click the *System* tab.
2. Click *Tasks* in the top navigation bar. The Tasks window will open.
3. Click *Add*. The Add Task Wizard will appear.
4. Select *Control power of Target Devices* from the drop-down menu. Type a 1-64 character name for the task.
5. Select a time to run the task (see *Specifying when to run tasks* on page 320), then click *Next*.
6. The Select Unit Group window will open. Select *All Target Devices* to configure the power control settings on all target devices or select a particular unit group to configure. See *Unit Groups* on page 210. Then click *Next*.
7. The Select Target Devices window will open. Select one or more target devices in the Available Target Devices list, then click *Add*. The target device(s) will be moved to the Target Devices to Control list. Then click *Next*.
8. The Select Power Control Function window will open. Select the power control function to be performed on the target devices, and then click *Next*.
 - Turn Power On* - powers up the specified target devices.
 - Turn Power Off* - powers down the specified target devices.
 - Cycle Power* - powers down and then powers up the specified target devices.
9. Click *Finish*.

Task: Exporting an event log .csv file

This task exports selected fields from the DSView 3 software system event log to a .csv file. The exported event log may be stored on a local or network drive. The event log is named eventlog.csv by default, but you may also append the date and time to the end of the event log. The output .csv file may be viewed in a text editor or spreadsheet application, such as Microsoft Excel.

Once this task is added, you may run it on demand at any time; see *Running tasks manually* on page 334. You may also save an event log using the Export Event Log tool. See *Creating an Event Log .csv File* on page 347.

To add the task:

1. Click the *System* tab.
2. Click *Tasks* in the top navigation bar. The Tasks window will open.
3. Click *Add*. The Add Task Wizard will appear.
4. Select *Export event log to a comma separated values (.CSV) file* from the drop-down menu. Type a 1-64 character name for the task.

5. Select a time to run the task (see *Specifying when to run tasks* on page 320), then click *Next*.
6. The Specify Export Event Log Properties window will open.
 - a. Type the directory in which to create the event log, which may be a physical local drive on the DSView 3 server or at a shared network location specified by a UNC path. The location cannot be set to a mapped network drive. The directory name must be entered in case sensitive text if your operating system supports case sensitive filenames.
 - b. If the specified directory location is a network drive that requires a log in, enable the *Login required to access shared drive location* checkbox. Then, type the username and password and confirm the password of a user account that has read/write access to the network share location.
 - c. To append the date and time (in military time) to the end of the event log file, enable the *Use date and time for file naming* checkbox. For example, if you are creating the event log file on October 1, 2005 at 10:04 pm, the file created will be named eventlog1001052204.csv.

If an event log exists in the specified directory and you do not enable this option, it will be overwritten when the new event log is created.
 - d. Click *Next*.
7. The Select Event Log Columns to Export window will open.
8. To add one or more columns to export, select the column(s) from the Available Columns list, then click *Add*. The column(s) will be moved to the Columns to Export list.
9. To remove one or more columns to export, select the column(s) from the Columns to Export list, then click *Remove*. The column(s) will be moved to the Available Columns list.
10. To change the order in which exported columns are listed in the output .csv file, select one or more columns in the Columns to Export list and use the up and down arrows to move the selected columns up or down in the listing.
11. Click *Finish*.

Task: Migrating units

NOTE: This task is valid only when the DSView 3 software is installed on a supported Windows system.

This task may be used to migrate units from a DSView 2.x software database or from the AlterPath Manager.

Migrating DSView 2.x software units

This task updates DS1800 digital switches, CPS appliances or DSR switches within the unit group, or any of those managed appliances using firmware compatible with DSView 2.x software to firmware that is compatible with the DSView 3 management software.

The managed appliances should not be Flash upgraded from DSView 2.x firmware to firmware that supports DSView 3 software before using the Migrate Units command. The recommended procedure is to first import the DSView 2.x software database to the new DSView 3 software

system using the Import DSView 2.x Database tool (see *Importing DSView 2.x software databases* on page 309), followed by running the Migrate Units task on each managed appliance.

A CPS appliance or DSR switch that has been migrated to DSView 3 software compatible firmware may be returned to DSView 2.x compatibility.

Migrating AlterPath Manager software units

This task updates units that have been imported from the AlterPath Manager to be compatible with the DSView 3 management software.

The recommended procedure is to first export data from the AlterPath Manager into an XML format that can be read by DSView 3 software (see the AlterPath Manager Data Migration Technical Bulletin). Then, import the AlterPath Manager data to the DSView 3 software system using the Import Data Wizard (see *Importing data* on page 312), followed by running the Migrate Units task on each managed appliance. When creating the Migrate Units task, it is recommend that you select *Enable Secure Mode* for the units.

To add the task:

1. Click the *System* tab.
2. Click *Tasks* in the top navigation bar. The Tasks window will open.
3. Click *Add*. The Add Task Wizard will appear.
4. Select *Migrate Units* from the drop-down menu. Type a 1-64 character name for the task.
5. Select a time to run the task (see *Specifying when to run tasks* on page 320), then click *Next*.
6. The Select Unit Group window will open. Select *Units Needing Migration* or a particular unit group from the menu.
7. Click *Select by Product Family* then select a family from the menu.
-or-
Click *Select by Unit Type* then select a type from the menu.
Click *Next*. You must create a separate task for each product family or type of managed appliance you wish to migrate.
8. The Select Units window will open. The Available Units list will contain only units with a status of Migration Needed that match the selected type found in the unit group specified in the previous step. Select one or more managed appliance to migrate from the Available Appliances list, then Click *Add*. The switches or appliances will be moved to the Appliances to Configure list. Click *Next*.
9. If you are migrating DSView 2.x software units, select the firmware files for migration.
 - a. Type the host name or the address of the TFTP server, in standard dot notation (xxx.xxx.xxx.xxx) containing the DS1800 digital switch, CPS appliance or DSR switch firmware files required for migration to DSView 3 management software compatibility.
 - b. Type the name of each firmware image.
 - c. Click *Next*.

10. If you want the managed appliances you are migrating to be accessible only by this DSView 3 server, enable the *Enable secure mode* checkbox. If you want the managed appliances you are migrating to be accessible by any DSView 3 software system, disable the *Enable secure mode* checkbox. Click *Next*.

NOTE: If you are migrating units from the AlterPath Manager, enabling secure mode is recommended.

11. Click *Finish*. The Tasks window will open. You may display the current progress of the migration task by clicking on the name of the task.
12. Repeat the preceding steps for each type of managed appliance that you wish to migrate. Units successfully migrated into the DSView 3 software system will appear in Units View windows and the Migration Status field for these units will indicate Migration Completed.

Task: Sending an IPMI chassis control command to target devices

This command powers up, powers down, cycles the power (power down and then power up), performs a gentle shutdown or resets one or more IPMI target devices.

You must have Control Target Device Power rights to send an IPMI chassis control command. See *About Access Rights* on page 144.

Once this task is added, you may run it on demand at any time; see *Running tasks manually* on page 334.

To add the task:

1. Click the *System* tab.
2. Click *Tasks* in the top navigation bar. The Tasks window will open.
3. Click *Add*. The Add Task Wizard will appear.
4. Select *Send IPMI chassis control command to target devices* from the drop-down menu. Type a 1-64 character name for the task.
5. Select a time to run the task (see *Specifying when to run tasks* on page 320). Click *Next*.
6. The Select Unit Group window will open. Select *All Target Devices* or select a particular unit group to configure from the menu. See *Grouping Units* on page 205. Then click *Next*.
7. The Select Target Devices window will open. Select one or more IPMI target devices to chassis control from the Available Target Devices list, then click *Add*. The IPMI target devices will be moved to the Target Devices to Control list. Click *Next*.
8. The Select IPMI Control Function window will open. Select the power control function you wish to perform on the IPMI target devices, then click *Next*.

Turn Power On - powers up the specified devices.

Turn Power Off - powers down the specified devices.

Cycle Power - powers down and then power up the specified devices. *

Reset - performs a hard reset of the specified devices.

Graceful Shutdown - performs a graceful shutdown of the specified devices. *

* The availability of the Cycle Power and Graceful Shutdown options is dependent on the BMC implementation. If one of these options is selected for a task but the BMC implementation does not support the option, the task will fail when run and be reported in the Task Results window.

9. Click *Finish*.

Task: Test modem connections to selected units

This task tests modem connections to ACS console servers that have been configured to support modem dial-up or modem dial-back.

For more information about modem connections, see *Active modem sessions* on page 179.

To add the task:

1. Click the *System* tab.
2. Click *Tasks* in the top navigation bar. The Tasks window will open.
3. Click *Add*. The Add Task Wizard will appear.
4. Select *Test modem connections to selected units* from the drop-down menu. Type a 1-64 character name for the task.
5. Select a time to run the task (see *Specifying when to run tasks* on page 320), and then click *Next*.
6. The Select Unit Group window will open. Select a group from the menu.
7. Click *Select by Product Family* and select *ACS Firmware* from the drop-down menu.
-or-
Click *Select by Unit Type* and choose a specific ACS console server model from the drop-down menu.
Then click *Next*.
8. The Select Unit window will open. Select the units that you wish to test and click *Add*.
9. Click *Finish*.

Task: Updating the firmware of an appliance type

This task upgrades the firmware of selected DS1800 digital switches, DSI5100, CPS or CCM appliances or DSR switches. To upgrade other types of managed appliances, you must create additional tasks.

Firmware must be available before using this command. See *Firmware Management* on page 336.

Once this task is added, you may run it on demand at any time; see *Running tasks manually* on page 334.

To add the task:

1. Click the *System* tab.
2. Click *Tasks* in the top navigation bar. The Tasks window will open.

3. Click *Add*. The Add Task Wizard will appear.
4. Select *Upgrade firmware of selected appliances of the same type* from the drop-down menu. Type a 1-64 character name for the task.
5. Select a time to run the task (see *Specifying when to run tasks* on page 320), and then click *Next*.
6. The Select Unit Group window will open. Select *All Appliances* or select a particular unit group to upgrade from the menu. See *Unit Groups* on page 210. Then click *Next*.
7. The Select Appliance Type window will open. Select the type of managed appliance that you wish to upgrade, then click *Next*.
8. The Select Appliances window will open. Select one or more managed appliance to be upgraded from the Available Appliances list, then click *Add*. The appliances will be moved to the Appliances to Configure list.
9. Click *Finish*.

Task: Validating user accounts on an external authentication server

This task may be used to ensure that LDAP, Active Directory and NT external authentication services contain accounts for users. Any user accounts not found on the external authentication server will be flagged as suspicious (a question mark icon will appear to the left of the user's name). Suspicious accounts are indicated in event log files.

Once this task is added, you may run it on demand at any time; see *Running tasks manually* on page 334.

To add the task:

1. Click the *System* tab.
2. Click *Tasks* in the top navigation bar. The Tasks window will open.
3. Click *Add*. The Add Task Wizard will appear.
4. Select *Validate external authentication server user accounts* from the drop-down menu. Type a 1-64 character name for the task.
5. Select a time to run the task (see *Specifying when to run tasks* on page 320).
6. Click *Finish*.

Task: Pull names from selected units

Automatic name pull (see *Automatic name pull* on page 127) is not supported on some managed appliances, including the LANDesk Server Manager. To keep these appliances synchronized with the DSView 3 software, you may instead schedule the pull names task.

NOTE: For more information about LANDesk Server Manager integration, see the DSView 3 Software Plug-in for LANDesk Server Manager online help.

This task may be used to pull names from a managed appliance and update the DSView 3 software database. This task performs the same operations as the Pull Names from Appliance option in the Operations menu (see *Name Synchronization* on page 125).

Once this task is added, you may run it on demand at any time; see *Running tasks manually* on page 334.

To add the task:

1. Click the *System* tab.
2. Click *Tasks* in the top navigation bar. The Tasks window opens.
3. Click *Add*. The Add Task Wizard appears.
4. Select *Pull Names from selected units* from the drop-down menu. Type a 1-64 character name for the task.
5. Select a time to run the task (see *Specifying when to run tasks* on page 320), then click *Next*.
6. The Select Unit Group window opens. Select *All Units* or select a unit group, then click *Next*.
7. The Select Unit window opens. Select the units to be included in the topology update, click *Add*.
8. Click *Finish*.

Task: Update topology for selected units

Automatic topology synchronization (see *Automatic topology synchronization* on page 131) is not supported on some units supported by plug-ins. To keep these units synchronized with the DSView 3 software, you may instead schedule the update topology task.

This task updates the DSView 3 software database when a change occurs in a units. Examples of changes are the adding/removing of an IQ adaptor, cascade switch or power device. This task performs the same operations as the Resync Unit Wizard (see *Resynchronizing units* on page 315).

Once this task is added, you may run it on demand at any time; see *Running tasks manually* on page 334.

To add the task:

1. Click the *System* tab.
2. Click *Tasks* in the top navigation bar. The Tasks window opens.
3. Click *Add*. The Add Task Wizard appears.
4. Select *Update Topology for selected units* from the drop-down menu. Type a 1-64 character name for the task.
5. Select a time to run the task (see *Specifying when to run tasks* on page 320), then click *Next*.
6. The Select Unit Group window opens. Select *All Units* or select a unit group, then click *Next*.
7. The Select Unit window opens. Select the units to be included in the topology update, click *Add*, then click *Next*.
8. The Select Options window opens.

- a. If you enable the *Remove offline connections* checkbox, any units connections that are reported as offline in the unit will be deleted from the DSVIEW 3 software database. The Update topology for selected units task does not add offline connections to the DSVIEW 3 software database
 - b. If you enable the *Delete target devices that no longer have connections* checkbox, target devices that no longer have connections will be permanently deleted from the DSVIEW 3 software database.
 - c. If you enable the *Allow target devices with the same name to be merged into a single target device* checkbox, the connection to a target device in the unit will be merged with the connection(s) to an existing target device in the DSVIEW 3 software database.
 - d. If you enable the *Allow target devices that contain default names to be added for these type of connections* checkbox, you may then enable one or more connection type checkboxes. Any target devices that contain default names in the unit will be added to the DSVIEW 3 software database only if the connection type in the unit matches an enabled connection type in this window.
9. Click *Finish*.

Task: Backup Power Manager database

This task creates a compressed .zip file containing a backup of the Power Manager database. The backup file contains everything necessary to fully restore the Power Manager database if needed. The backup file is named `dsviewPluginBackup.zip` by default, but you may also append the date and time to the end of the backup filename.

Once this task is added, you may run it on demand at any time; see *Running tasks manually* on page 334.

NOTE: Power management features require the Power Manager plug-in. For more information about using power management, see the Power Manager Plug-in help.

To add the task:

1. Click the *System* tab.
2. Click *Tasks* in the top navigation bar. The Tasks window will open.
3. Click *Add*. The Add Task Wizard will appear.
4. Select *Backup Power Manager database* from the drop-down menu. Type a 1-64 character name for the task.
5. Select a time to run the task, then click *Next*. See *Specifying when to run tasks* on page 320.
6. The Specify Power Manager Database Backup Properties window will open.
 - a. Type the directory location in which to create the backup file, which may be a physical local drive on the DSVIEW 3 server or a shared network location specified by a UNC (Universal Naming Convention) path. The Location field cannot be set to a mapped

network drive. The directory name must be entered in case sensitive text if your operating system supports case sensitive filenames.

- b. If the specified directory location is a network path that requires a login, enable the *Login required to access shared drive location* checkbox. Then type the username and password and confirm the password of a user account that has read/write access to the network share location.
- c. To encrypt the created system backup file, enable the *Encrypt Backup File* checkbox, then type a password to lock and unlock the encrypted file.
- d. To append the date and time (in military time) to the end of the system backup filename, enable the *Use date and time for file naming* checkbox. For example, if you are creating the backup file on October 1, 2005 at 10:04 pm, the file created will be named `dsviewBackup1001052204.zip`.

If a backup file already exists in the specified directory and the *Use date and time for file naming* option is not enabled, the existing backup file will be overwritten when the new backup file is created.

7. Click *Finish*.

Task: Restore Power Manager database

This task restores the Power Manager database using the backup file created with *Task: Backup Power Manager database* on page 332. The backup file contains everything necessary to fully restore the Power Manager database if needed. The backup file is named `dsviewPluginBackup.zip` by default, but you may also append the date and time to the end of the backup filename.

Once this task is added, you may run it on demand at any time; see *Running tasks manually* on page 334.

NOTE: Power management features require the Power Manager plug-in. For more information about using power management, see the Power Manager Plug-in help.

To add the task:

1. Click the *System* tab.
2. Click *Tasks* in the top navigation bar. The Tasks window will open.
3. Click *Add*. The Add Task Wizard will appear.
4. Select *Restore Power Manager database* from the drop-down menu. Type a 1-64 character name for the task.
5. Select a time to run the task, then click *Next*. See *Specifying when to run tasks* on page 320.
6. The Specify Power Manager Restore Backup Properties window will open.
 - a. Type the directory location from which to retrieve the backup file, which must be a logical or mapped drive on the DSView 3 server. The directory name must be entered in case sensitive text if your operating system supports case sensitive filenames.

- b. If the specified directory location is a network path that requires a login, enable the *Login required to access shared drive location* checkbox. Then type the username and password and confirm the password of a user account that has read/write access to the network share location.
 - c. If the backup file is encrypted, enable the *Backup File is encrypted* checkbox, then type a password to unlock the encrypted file.
7. Click *Finish*.

Running tasks manually

Although tasks are scheduled to run at particular times using the Add Task Wizard, you may run an existing task at any time.

To manually run tasks:

1. Click the *System* tab.
2. Click *Tasks* in the top navigation bar. The Tasks window will open.
3. Click the checkbox to the left of the task(s) you wish to run. To select all tasks on the page, click the checkbox to the left of Name at the top of the list.

Remote tasks that are scheduled on another DSView 3 server may not be run from the DSView 3 server to which you are logged in. To run a remote task, you must log in to the DSView 3 server on which the task was created.

4. Click *Run Now*. The icon to the left of the task name will change to the running icon and the status of the task will change to Running.

Displaying task results

The Task Results window displays the status of the most current run of tasks, including successful and unsuccessful runs and information on each run.

The following fields display in the Task Results window for the Configure SNMP trap settings on appliance, Control power of target devices, Migrate Units, Send IPMI chassis control command to target devices and Upgrade firmware of selected appliances of the same type tasks:

- Name - Names of the unit on which the task is running or has been run
- Start Time - Exact time at which each task run occurred
- Duration - Date and time of the task run
- Status - Result of the task run

To display the results of a task:

1. Click the *System* tab.
2. Click *Tasks* in the top navigation bar. The Tasks window will open.
3. Click the name of the task. The Task Results window will display, containing information about the task.

Deleting tasks

NOTE: Remote tasks, which are scheduled on another DSView 3 server, may not be deleted from the DSView 3 server to which you are logged in. To delete a remote task, you must log in to the DSView 3 server on which the task was created.

To delete a task:

1. Click the *System* tab.
2. Click *Tasks* in the top navigation bar. The Tasks window will open.
3. Click the checkbox to the left of the task(s) you wish to delete. To delete all tasks on the page, click the checkbox to the left of Name column at the top of the list.
4. Click *Delete*. A confirmation dialog box will appear.
5. Confirm or cancel the deletion.

Changing tasks

NOTE: Remote tasks, which are scheduled on another DSView 3 server, may not be modified from the DSView 3 server to which you are logged in. To change a remote task, you must log in to the DSView 3 server on which the task was created.

You may change the schedule and properties for existing tasks. (The Validate external authentication server user accounts task does not contain properties.)

To change a task schedule:

1. Click the *System* tab.
2. Click *Tasks* in the top navigation bar. The Tasks window will open.
3. Click on the name of the task.
4. Click *Schedule* in the side navigation bar. The Task Schedule window will open. Select the type of task you wish to schedule and complete the information. See *Specifying when to run tasks* on page 320.

To change the properties of a task:

1. Click the *System* tab.
2. Click *Tasks* in the top navigation bar. The Tasks window will open.
3. Click on the name of the task.
4. Click *Properties* in the side navigation bar. The Task Properties window will open.
5. Change the properties of the task. See the operating sequence for the task type in *Adding tasks using the Add Task Wizard* on page 322.

Firmware Management

The Flash firmware files for DS1800 digital switches, DSI5100, CPS and CCM appliances and DSR switches may be added, viewed and deleted using the Appliance Firmware Files window. Once a Flash firmware file(s) has been added, you may use the file(s) to upgrade the managed appliance.

To display the Appliance Firmware Files window:

1. Click the *System* tab.
2. Click *Appliance Files* in the top navigation bar. The Appliance Firmware Files window will open.

Customizing the Appliance Firmware Files window

The Version, firmware Type, Appliance Type, Creation Date and Time, Description, Language and Country fields may appear in the display. Use the Customize link to add or remove fields in the display. See *Using the Customize link in windows* on page 28.

To add a firmware file:

1. Click the *System* tab.
2. Click *Appliance Files* in the top navigation bar. The Appliance Firmware Files window will open.
3. Click *Add*. The Add Firmware File Wizard will appear.
4. Enter the directory and filename (or browse to the location) of the firmware file you want to add to the DSView 3 software appliance files repository.
5. Type a description of the firmware file in the Description field.
6. Click *Next*. The firmware is added and the Completed Successful window appears.
7. Click *Finish*. The Appliance Firmware Files window will open.

NOTE: Once the file is uploaded, it is no longer needed on the DSView 3 software client from which it was uploaded.

To display firmware information:

1. Click the *System* tab.
2. Click *Appliance Files* in the top navigation bar. The Appliance Firmware Files window will open.
3. Click on the version of a firmware file. The Firmware File Properties window will open.
4. The display includes the firmware version, appliance type, firmware creation date, country and language of the firmware. If you wish, you may change the description of the firmware file in the Description field.

5. Click *Save* and then click *Close*. The Appliance Firmware - All window will open and contain the firmware information if you saved the changes.

To delete firmware:

1. Click the *System* tab.
2. Click *Appliance Files* in the top navigation bar. The Appliance Firmware Files window will open.
3. Click the checkbox next to the firmware you want to delete.
4. Click *Delete*. A confirmation dialog box will appear.
5. Confirm or cancel the deletion.

Events and Event Logs

When an enabled, defined event occurs in the DSView 3 software system, it is saved in the event log. You may display the event log content, view details about an individual event log entry or delete an event log entry. You may have an email notification sent to one or more addresses when an event occurs. You may change the event log's retention period and export the event log's content.

NOTE: You must be a member of the DSView 3 software administrator or auditor user group to access event configuration and display windows.

Event Severity and Categories

Events are classified by severity and category.

Event severity

Table 23.1 describes the event severity levels. The icon appears in event log displays.

Table 23.1: Event Severity Levels







Severity	Icon	Description
Monitor		Events that are periodic and expected.
Information		Events that are neither periodic nor problematic.
OK		Events that are in a normal or cleared state. This value typically appears at event start up or after leaving a previous event state.
Non-critical		Abnormal events that require correcting at a later time.
Critical		Abnormal events of a more serious nature that may require quicker action, such as the failure of a scheduled task or loss of communication

Table 23.1: Event Severity Levels (Continued)

Severity	Icon	Description
Non-recoverable		Severe abnormal events impacting your DSView 3 management software session and requires immediate corrective action.

Severity icons

For users who are members of the DSView 3 software administrators or auditor user groups, the non-critical, critical and non-recoverable icons also appear near the right edge of the top navigation bar in the DSView Explorer window when events of that severity occur. Each icon is accompanied by a total count of new events of that severity. The counter is decremented when an event of that severity is deleted from the event log or when an event's state is changed from New to Acknowledged (see *Event states* on page 345). The counter is incremented when a new event of that severity is added to the log or when an event's state is changed from Acknowledged to New.

Event categories

Defined events can be classified in the following categories:

- Access control
- Appliance
- Authentication
- Data logging
- External
- IPMI
- Modem
- Sessions
- SSH Passthrough
- System
- Tasks
- Units
- Unit status
- Users

Email Notifications

The DSView 3 software may be configured to send one or more users an email notification when an enabled event occurs.

- You may specify which events will trigger an email notification.

- You may also specify one or more unit groups - an email notification will be sent only when a specified unit-related event occurs on a unit that is a member of the specified unit group(s).
If a specified event that is not tied to a unit occurs (for example, DSView server started), an email notification will be sent, regardless of the any specified unit groups.

NOTE: A mail server that supports Simple Mail Transfer Protocol (SMTP) must be configured to receive email event notifications.

Customizing the Email Notifications window

The Email Subject column is always displayed in the Email Notifications window: The display may include From Address and To Address fields. Use the Customize link to add or remove fields in the display. See *Using the Customize link in windows* on page 28.

To configure an email notification:

1. Click the *Reports* tab.
2. Click *Email Notifications* in the side navigation bar. The Email Notifications window will open.
3. Click *Add*. The Add Email Notification Wizard will appear.
4. The Specify Email Properties window will open.
 - a. In the Send To field, type the email addresses of the persons you want to notify. Separate multiple addresses with a comma (.). This field has a limit of 1024 characters.
 - b. In the From field, type the email address (up to 64 characters) of the person you wish to designate as the sender of the notification.
 - c. In the Subject field, type a subject heading (up to 64 characters) for the notification.
 - d. Click *Next*.
5. The Select Events to Trigger Email Notification window will open.
 - To add one or more events, select the event(s) from the Available Events list, then click *Add*. The event(s) will be moved to the Events To Notify list.
 - To remove one or more events, select the event(s) from the Events To Notify list, then click *Remove*. The event(s) will be moved to the Available Events list.Click *Next*.
6. The Select Unit Groups to Trigger Email Notification window will open.
 - To add one or more unit groups, select the unit group(s) from the Available Unit Groups list, then click *Add*. The unit group(s) will be moved to the Selected Unit Groups list.
 - To remove one or more unit groups, select the unit group(s) from the Selected Unit Groups list, then click *Remove*. The unit group(s) will be moved to the Available Unit Groups list.Click *Next*.
7. The Completed Successful window will open. Click *Finish*.

To change an email notification:

1. Click *Email Notifications* in the side navigation bar. The Email Notifications window will open.
2. Click on the email subject of the notification you wish to change. The Email Notification Properties window will appear.
3. To change the notification information:
 - a. In the Send To field, enter or remove the email addresses of persons you want to notify. Separate multiple addresses with a comma (.). This field has a limit of 1024 characters.
 - b. In the From field, change the email address (up to 64 characters) of the person you wish to designate as the sender of the notification.
 - c. In the Subject field, change the subject heading (up to 64 characters) for the notification
4. To change the events:
 - To add one or more events, select the event(s) from the Available Events list, then click *Add*. The events will be moved to the Events To Notify list.
 - To remove one or more events, select the event(s) from the Events To Notify list, then click *Remove*. The events will be moved to the Available Events list.
5. To change the unit groups:
 - To add one or more unit groups, select the unit group(s) from the Available Unit Groups list, then click *Add*. The unit group(s) will be moved to the Selected Unit Groups list.
 - To remove one or more unit groups, select the unit group(s) from the Selected Unit Groups list, then click *Remove*. The unit group(s) will be moved to the Available Unit Groups list.
6. Click *Save* and then click *Close*. The Email Notifications window will open.

To test an email notification:

Once an email notification has been created, you may send a test message to ensure that the notification is delivered to the specified recipients.

1. Click *Email Notifications* in the side navigation bar. The Email Notifications window will open.
2. Click the checkbox to the left of the notification(s) to be tested. To select all notifications on the page, click the checkbox to the left of Email Subject at the top of the list.
3. Click *Test*. You will be prompted to confirm the test.
4. Confirm or cancel the test.

To delete an email notification:

1. Click *Email Notifications* in the side navigation bar. The Email Notifications window will appear.
2. Click the checkbox to the left of the notifications to delete. To select all notifications on the page, click the checkbox to the left of Email Subject at the top of the list.

3. Click *Delete*. You will be prompted to confirm the deletion.
4. Confirm or cancel the deletion.

Enabling and Disabling Event Logging

The logging of individual events that occur in the DSView 3 software system may be enabled or disabled. When an enabled event occurs, it is written to the event log. When an event is disabled, its occurrence will not be logged until the event is enabled.

By default the Enabled Log Events window lists the event name and whether it is enabled or disabled. (The enabled/disabled state differs from an event's state in the event log; see *Event states* on page 345.) You may change which fields and the number of items per page that will be displayed in the Enabled Log Events window by clicking the *Customize* link (see *Using the Customize link in windows* on page 28). This may be helpful if you want to sort the list by a field such as category or event ID.

To enable or disable logging of one or more events:

1. Click the *Reports* tab.
2. Click *Enabled Events* in the side navigation bar. The Enabled Log Events window will open, listing all enabled and disabled log events. If you want to display only the events in a particular category, click the category link in the side navigation bar.
3. Click the checkbox to the left of one or more events. To select all events on the page, click the checkbox to the left of Log Event at the top of the list.
4. Click *Enable* or *Disable*. (Events cannot be enabled unless they are already disabled. Similarly, events cannot be disabled unless they are already enabled).

The Enabled Log Events window will refresh with the new information.

Displaying the Event Log

There are several ways to customize event log displays.

- You may display all events (or at least the most recent 5000) in the log.
- You may display events of a particular severity or a particular category.
- You may display events that occurred during a specified interval.
- You may display events based on their state; see *Event states* on page 345.

Event log display fields

The following fields are always displayed in the Event Log window:

- **Severity** - See *Event severity* on page 339. Clicking this field will display the Event Information window, which contains details about the event.
- **Date/Time** - Displays the date and time of an event in the client computer's time zone.
- **Description** - Short description of an event.

The following fields may be displayed. Use the Customize link to add or remove fields in the display. See *Using the Customize link in windows* on page 28.

- State - New or Acknowledged. See *Event states* on page 345. This field is displayed only when the Show All button is enabled. Its display is not affected by customization.
- Category - Category of an event log entry.
- Detailed Description - Detailed information, which may include the name of a target device, session type, user and so on. For example, a MIB-II interface link up trap might contain *Appliance change of state* in the Description column, while the Detailed Description column contains *Generic link up interface 1*.
- DSView Server - Name of the DSView 3 server where the event was logged.
- Event ID - Unique event identifier, which can be useful for sorting displays.
- Trap Enterprise - Enterprise object identifier for a received SNMP trap. (The Trap Enterprise field in an Event Log window is named Enterprise OID in the Event Information window.)
- Unit - Name of a managed appliance for the event.
- User - User associated with the event. For example, when a Unit Deleted event is detected, this field contains the username of the initiator.

To display the event log:

Click the *Reports* tab. The Event Log - All window will open.

- To display event log entries by severity, click *Severity Level* in the side navigation bar, and then click one of the levels. (See the Note below for an alternative way to display the event log by certain severity levels.)
- To display event log entries by category, click *Event Category* in the side navigation bar, and then click one of the categories.
- To display event log entries that occurred during a specified interval, see *Using the date filter* on page 346.
- By default, the display includes event log entries with a state of New (see *Event states* on page 345) and the State column is not displayed. To view events with an Acknowledged state in the display, enable the *Show All* button. The State column will be added to the display, and the list will include events with any state (New or Acknowledged). Acknowledged events will be grayed-out to differentiate them from New events, but any event can be selected.

To remove events with an Acknowledged state from the display, disable the *Show All* button. The State column will be removed from the display, and only unacknowledged (state = New) events will appear.

NOTE: You may also display a list of only the new non-critical, critical or non-recoverable event log entries by clicking the appropriate icon in the right portion of the top navigation bar (see Table 23.1 for pictures).

To display details of an event log entry:

1. Click the *Reports* tab.

2. In an Event Log window, click on a link in the Severity column. The Event Information window will open.

See *Event log display fields* on page 343 for descriptions of information in the Event Details section of the display.

The Event History table contains any state change information. This includes when the state was changed, the type of change (for example, Changed from New to Acknowledged), and who (username) made the state change.

3. Click *Close*. The Event Log window will open.

To delete one or more event log entries:

1. In an Event Log window, click the checkbox to the left of the event(s) to delete. To select all events on the page, click the checkbox to the left of Severity at the top of the list.
2. Click *Delete*. A confirmation dialog box will appear.
3. Confirm or cancel the deletion.

Event states

When an event first occurs and is placed in the event log, it is considered to be in a New state. You may delete the event, which will remove it from displays and from the event log. However, if you wish to prevent an event from being displayed but not delete it from the event log, you may acknowledge the event, which will change its state from New to Acknowledged.

You may also change an event's state from Acknowledged to New again. This can be useful if you mistakenly changed an event's state to Acknowledged. The Event Information window for each event contains an Event History that indicates when that event's state was changed and by whom.

When you change a non-recoverable, critical or non-critical event's state to Acknowledged, the counter next to that severity icon in the top navigation bar will be decremented. If you change one of these events from Acknowledged to New, the counter is incremented.

In an event log display, if the Show All button is not enabled, the display will only include events with a New state. If the Show All button is enabled, events in any state (New or Acknowledged) will be included. Acknowledged events will be grayed-out.

To change the state of one or more event log entries:

1. Click the *Reports* tab. The Event Log - All window will open. You may tailor the display by severity, category or date, if desired.
2. Click the checkbox to the left of the events whose state you wish to change. To select all events on the page, click the checkbox in the heading at the top of the list.
3. Click *Set State* and then select *Acknowledged* or *New* from the drop-down list.

Using the date filter

The event log retains all events occurring in the DSView 3 software system for the specified retention time. By default, the 5000 most recent events are displayed. You may use the date filter to display older events or to display events from any interval in the retention time.

To use the date filter:

1. Click the *Reports* tab.
2. In any Event Log window, click *Date Filter*. The Date Filter window will open.
3. In the first drop-down menu in the From line, select *Events On* to select the start date and time.
4. Click on the calendar button or the field to the left of the calendar button and select a start date.
To use the calendar:
 - a. Click on the year and select a year from the drop-down menu.
 - b. Click on the month name and select a month from the drop-down menu, or use the arrows at the top of the calendar to move forward and backward by month.
 - c. Click on a day in the calendar to close the calendar and fill the field to the left of the calendar with the date you have selected.
5. Select an hour, minute and which half of the day for the start date.
6. In the first drop-down menu in the To line, select *Events On* to select the end date and time.
7. Repeat steps 4 and 5 to specify the end date.
8. Click *Apply*. The previous event log view window will open with the event range specified in the Filter Date window.

The Clear Date Filter button will appear in the event log view window. To clear date filtering, click this button.

Changing the Event Log Retention Period

By default, an event log is retained for seven days (one week). You may specify a retention period of up to 365 days (one year).

NOTE: Event log information is stored in the DSView 3 software database and is replicated. Increasing the event log retention time may impact the performance of the DSView 3 software system. It is recommended that old event log entries be archived to .csv files by scheduling tasks; see *Task: Exporting an event log .csv file* on page 325. You may also export event logs at any time; see *Creating an Event Log .csv File* on page 347.

To change the event log retention period:

1. Click the *Reports* tab.
2. Click *Log Retention* in the side navigation bar. The Event Log Retention Time window will open.
3. Type a number of days (from 1-365) in the Days field, or select it using the menu.
4. Click *Save*.

Creating an Event Log .csv File

All or selected columns of the event log can be exported as a comma separated values (.csv) file. The output event log file is named eventlog.csv by default, but you may change the name when it is saved. The .csv file may be viewed in a text editor or spreadsheet application, such as Microsoft Excel.

NOTE: To create a task to export the event log to a .csv file, see *Task: Exporting an event log .csv file* on page 325.

To create an event log .csv file:

1. Click the *Reports* tab.
2. Click *Tools* in the side navigation bar. The Event Log Tools window will open.
3. Click the *Export Event Log* icon or text. The Export Event Log Wizard will appear.
4. The Select Columns to Export window will open.
 - To add one or more columns to export, select the column(s) from the Available Columns list, then click *Add*. The columns will be moved to the Columns to Export list.
 - To remove one or more columns, select the column(s) from the Columns to Export list, then click *Remove*. The columns will be moved to the Available Columns list.
 - To change the order in which exported columns are listed in the output .csv file, select one or more columns in the Columns to Export list and use the up and down arrows to move the selected columns up or down in the listing.

Click *Next*.

5. The Save Process window will open, explaining how the file will be saved. Click *Next*.
6. The Completed Successful window will open, along with a File Download dialog box.
7. From the File Download dialog box, click *Open*. The file will be downloaded and will open on the DSView 3 software client. By default, .csv files are configured to open in Microsoft Excel. If Microsoft Excel is not installed on your computer, you will be prompted to select a text editor to open the .csv file.

-or-

From the File Download dialog box, click *Save*. The Save As dialog box will appear. Select a directory and filename and click *Save* to save the .csv file.

8. Click *Finish*. The Event Log Tools window will open.

A plug-in provides support for a specific appliance type (model) in the DSView 3 software. A plug-in is packaged into a single archive file that can be shipped and added independently of the DSView 3 software. You may add plug-ins to the DSView 3 software version 3.3 or later.

Although plug-ins are created independently, a particular DSView 3 software release may include one or more plug-ins that have already been added to the software. The release notes will indicate if any plug-ins are included. If a plug-in is included, you will not need to add it to the hub or spoke servers.

This chapter describes how to add and manage plug-ins in the DSView 3 software. Once you successfully complete the sequence for adding a plug-in, you may add appliances of that type and initiate other operations from the DSView 3 software that are supported in that plug-in.

NOTE: You must have DSView 3 software administrator access rights to view, add and manage plug-ins.

Plug-ins are created using the Plug-in API in the DSView 3 Software Development Kit (SDK).

Recommended Sequence for Adding/Upgrading Plug-ins

To add or upgrade a plug-in:

1. Ensure that scheduled replication will not occur during the adding or upgrading of plug-ins - you may need to change the replication schedule temporarily.
2. Perform a replication operation on every spoke server. See *Replication* on page 75.
3. Perform a backup of the DSView 3 software database. See *Backing up and Restoring Hub Servers Manually* on page 69.
4. Add or upgrade the plug-in on the hub server.
 - To add a plug-in, see *Adding Plug-ins* on page 350.
 - To upgrade a plug-in, see *Upgrading a plug-in* on page 352.
5. Add or upgrade the plug-in on each spoke server. All spoke servers should have the same plug-ins at the same version.
6. Perform a replication operation on every spoke server.
7. Perform a backup of the DSView 3 software database.
8. If you changed the replication schedule in step 1, you may change it back to its original values.

Adding Plug-ins

For optimal operation, the hub and all of the spoke servers should have the same version of a plug-in installed. Follow the steps described in *Recommended Sequence for Adding/Upgrading Plug-ins* on page 349.

During the add operation on the hub server, new data types defined in the plug-in are registered in the DSView 3 software database. After the plug-in is added to the spoke server and a replication operation is initiated, the registration information on the hub server is propagated to the spoke server.

On the hub server, a new plug-in becomes active when it is added. On a spoke server, a new plug-in becomes active only after the plug-in is added to the hub and then to the spoke and a subsequent replication completes successfully.

For some plug-ins, you may need to add a license key to the DSView 3 software system before adding the plug-in to any server. See the documentation included with the plug-in or contact your Avocent representative to determine if a key is needed. To add a license, see *Licenses* on page 54.

To add a plug-in:

1. Click the *System* tab.
2. Click *Plug-ins* in the top navigation bar.
3. Click *Add*. The Add Plug-in Wizard will open.
4. The Select Plug-in window will open. Enter the name or browse to the location of the plug-in file, then click *Next*.
5. The Overview window will open. This window contains read-only information about the plug-in. Click *Next*.
6. The Adding Plug-in page will open while the plug-in is added to the DSView 3 software system.
7. The Completed Successful window will open. Click *Finish*.

NOTE: If you added a plug-in for a Cyclades appliance, you must disable the Cyclades Web Manager to maintain security standards. For information about how to disable the Cyclades Web Manager, see the online help for the Cyclades appliance plug-in.

Displaying Plug-in Information

You may display information about all plug-ins that have been added as well as information about a single plug-in on the DSView 3 server where you are logged in.

To display plug-in information:

1. Click the *System* tab.
2. Click *Plug-ins* in the top navigation bar. The Plug-ins window will open.

- To display information about one plug-in, click the plug-in name. The Plug-in overview window will open.

Information in the Overview area is read-only.

The DSView Servers table lists the status of the plug-in on each DSView 3 server. Each row includes the name of the server and the plug-in version plus the administrative and operational status of the plug-in on that server.

Table 24.1: Plug-ins Display Information

Field	Description
Name	Plug-in name, acquired from the plug-in.
Version	Plug-in version (on this server), acquired from the plug-in when it was added or upgraded.
Overall Status	<ul style="list-style-type: none"> Same - The plug-in's operational status, administrative status and version is the same on all DSView 3 servers. Mixed - The plus-in's operational status, administrative status and version is not the same on all DSView 3 servers.
Administrative Status	<p>Administrative status on this server. Valid values are:</p> <ul style="list-style-type: none"> DSView server not responding - (<i>This value is valid only when a single plug-in has been selected.</i>) The DSView 3 software could not obtain plug-in status on this server. To examine server status, click the <i>System</i> tab, then <i>DSView Server</i> in the top navigation bar. If you are on a hub server, click <i>Spoke Servers</i> in the side navigation bar and then select the appropriate server. If you are on a spoke server, click <i>Hub Server</i> in the side navigation bar. Replication needed - The plug-in has been added, but replication is required before the plug-in can be used. Active - The plug-in is registered and operational. Disabled - The plug-in has been disabled. Not installed - The plug-in has not been added to this server. If the DSView 3 software can obtain information from the status service about this plug-in (from other servers where it is installed), the Name field will contain the plug-in's name. If the status service does not provide this information, the Name field will contain the plug-in's domain and ID.
Operational Status	<p>Operational status on this server. Valid values are:</p> <ul style="list-style-type: none"> Inactive - The plug-in is not running. Active - The plug-in is running. Initializing - The plug-in is starting up. Shutting down - The plug-in is stopping. Upgrading - The plug-in is in the upgrade process.
Detailed Operational Status *	Detailed status acquired from the plug-in.

Table 24.1: Plug-ins Display Information (Continued)

Field	Description
Description *	Descriptive information acquired from the plug-in.
Languages *	Language information acquired from the plug-in.
Appliance Type *	Appliance type information acquired from the plug-in.
Vendor *	Owning vendor of the plug-in, according to information acquired from the plug-in.

* By default, these fields are not displayed in the Plug-ins window. Use the [Customize](#) link to specify which fields you want to display; see *Using the Customize link in windows* on page 28. These fields are always displayed in the individual plug-ins' overview windows.

Managing Plug-ins

After a plug-in has been added, you may upgrade it to another (generally, newer) version. You may also disable a plug-in if necessary for troubleshooting, and then (re)activate it.

- You may initiate an action only for plug-ins on the DSVIEW 3 server you are currently logged into.
- The plug-in must currently have an administrative status that allows the action (for example, you can activate a plug-in only if its current administrative status is disabled).

Upgrading a plug-in

When you upgrade the existing version of a plug-in, follow the steps described in *Recommended Sequence for Adding/Upgrading Plug-ins* on page 349.

To upgrade a plug-in:

1. Click the *System* tab.
2. Click *Plug-ins* in the top navigation bar. The Plug-ins window will open.
3. Click on the name of plug-in to be upgraded. The plug-in overview window will open.
4. In the DSVIEW Servers area, click the checkbox next to the DSVIEW 3 server you are currently logged into.
5. Click *Upgrade*. The Upgrade Plug-in Wizard will open.
6. Enter the name or browse to the location of the plug-in file, then click *Next*.
7. The Overview window will open. This window contains read-only information about the plug-in. Click *Next*.
8. The Upgrading Plug-in page will open while the plug-in is being upgraded.
9. The Completed Successful window will open. Click *Finish*.

Disabling and activating a plug-in

When a plug-in is disabled, you cannot use any features and operations supported by that plug-in. Appliances and target devices that were added to the DSView 3 software system before the plug-in was disabled will still appear in Units View windows, but you will not be able to acquire status from those units, and links that initiate connections to those units will not be available. You will not be able to add more appliances of that type until the plug-in is (re)activated.

A disabled plug-in will remain disabled if the DSView 3 software is restarted.

To disable a plug-in:

1. Click the *System* tab.
2. Click *Plug-ins* in the top navigation bar. The Plug-ins window will open.
3. Click on the name of plug-in to be disabled. The plug-in overview window will open.
4. In the DSView Servers area, click the checkbox next to the DSView 3 server you are currently logged into.
5. Click *Disable*. A confirmation dialog box will appear.
6. Confirm or cancel the action.

To activate a plug-in:

1. Click the *System* tab.
2. Click *Plug-ins* in the top navigation bar. The Plug-ins window will open.
3. Click on the name of plug-in to be activated. The plug-in overview window will open.
4. In the DSView Servers area, click the checkbox next to the DSView 3 server you are currently logged into.
5. Click *Activate*. A confirmation dialog box will appear.
6. Confirm or cancel the action.

APPENDICES

Appendix A: Technical Support

Our Technical Support staff is ready to assist you with any installation or operating issues you encounter with your Avocent product. If an issue should develop, follow the steps below for the fastest possible service:

To resolve an issue:

1. Check the pertinent section of the manual to see if the issue can be resolved by following the procedures outlined.
2. Check our web site at www.avocent.com/support to search the knowledge base or use the online service request.
3. Call the Avocent Technical Support location nearest you.

Appendix B: TCP and UDP Ports

The DSVIEW 3 software client accesses the server and performs commands using a standard web browser. The communication protocol used between the client web browser and the server is the HTTPS protocol. By default, TCP/IP port 443 is used for HTTPS connections, but you may change the port using the DSVIEW Server Network Properties window.

NOTE: The port used for the HTTPS connection may be changed using the DSVIEW Server Network Properties window. The HTTPS port must be specified in the web browser URL if changed from the default (port 443). See *Server Properties* on page 59.

DSVIEW 3 software clients may communicate with the DSVIEW 3 server through a standard connection or using a proxy server. By default, TCP/IP port 1078 is used for proxied connections. If a proxy connection has not been created, TCP ports 22, 2068 and 8192 must be configured as open on your firewall.

When data logging is used, the SSH server port, 4122, and the Syslog server port, 4514, must be configured as open on your firewall.

NOTE: You can change the SSH server port and Syslog server port. See *Enabling the SSH server* on page 187 and *Enabling the Syslog server* on page 187.

KVM switch ports

A user may initiate a KVM session with a target device on a KVM switch by clicking *KVM Session* for the appropriate target device or by clicking the *KVM Session* icon or text from a Unit Overview window.

The client contacts the DSVIEW 3 server, which checks the permissions of the target device. If the logged in user has permissions to establish Video Viewer sessions to the selected target device, the server will establish a connection to the KVM switch using TCP/IP port 3871 to authorize the session. The KVM data is sent to the KVM switch using ports 8192 and 3871. Port 8192 contains the video portion of the KVM data. Port 2068 contains the keyboard and mouse portion of the KVM data.

In a non-proxied connection, the video data from port 8192 and the keyboard and mouse data from port 2068 are sent directly from the client to the KVM switch. Figure B.1 illustrates the ports used with a non-proxied KVM switch connection.

UDP port 3211 is used by the DSVIEW 3 server to initialize the IP configuration of KVM switches. TCP/IP port 3211 is also used by the DSVIEW 3 server to perform management functions on KVM switches, such as configuring settings.

NOTE: When using a non-proxied connection, video performance over a slower network connection may be less than optimal. Since certain color settings (such as grayscale) use less network bandwidth than others (such as Best Color), changing the color settings may increase video performance. For optimal video performance over a slower network connection, a color setting such as grayscale/Best Compression or Low Color/High Compression is recommended. See *Color depth* on page 258.

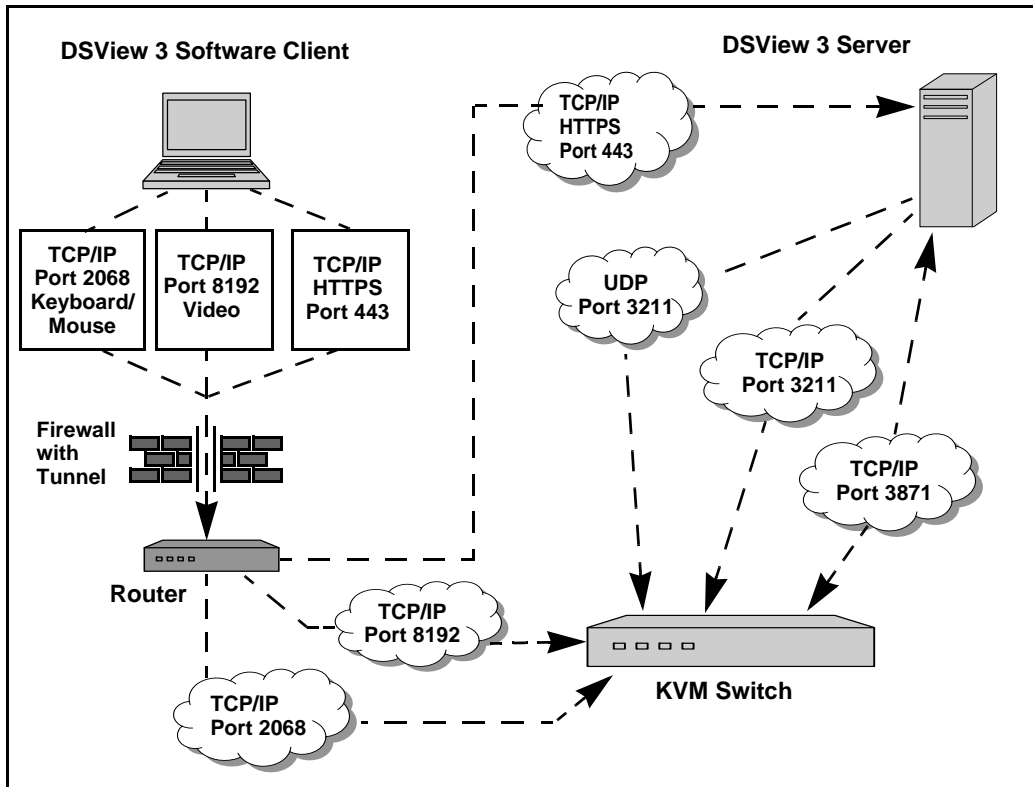

Figure B.1: Ports Used with a KVM Switch Connection Without Proxy

In a proxied connection, communication with TCP/IP ports 8192 and 2068 occurs between the server and the KVM switch instead of directly between the client and the KVM switch. The client receives information by communicating back and forth with the server using port 1078.

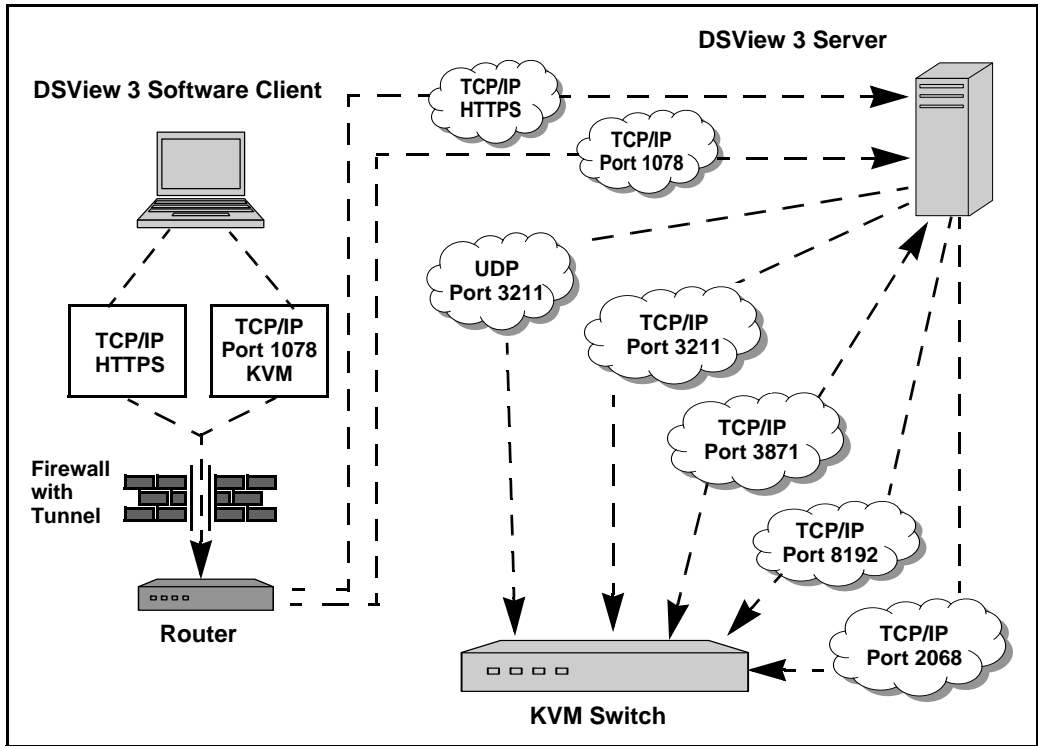

Figure B.2: Ports Used with a KVM Switch Proxy Server Connection (KVM)

If the user wishes to establish a session with another port on the KVM switch, the same process is used.

For debugging purposes, connection details may be seen by using the console port to place the KVM switch into Debug mode.

Serial console appliance ports

Like a KVM switch, a serial console appliance may use a non-proxied or a proxied connection. Serial console appliances use a Secure Shell Protocol (SSH).

The client contacts the server, which checks the permissions of the target device. If the logged in user has permissions to establish sessions to the selected target device, the server will establish a connection to the appliance using TCP/IP port 3871 to authorize the session.

In a non-proxied SSH connection, the client communicates directly with the appliance using port 22.

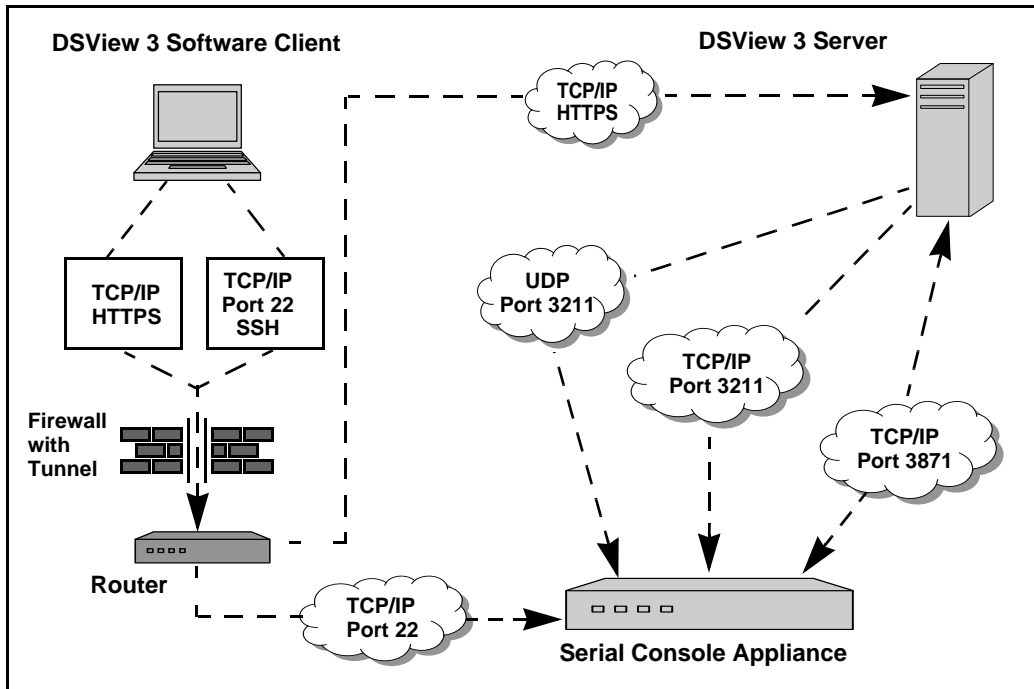

Figure B.3: Ports Used with a Serial Console Appliance Connection (Serial) Without Proxy

In a proxied connection, communication between the DSView 3 server and serial console appliance occurs over port 22. The SSH connection between the client and the DSView 3 server is tunneled over port 1078.

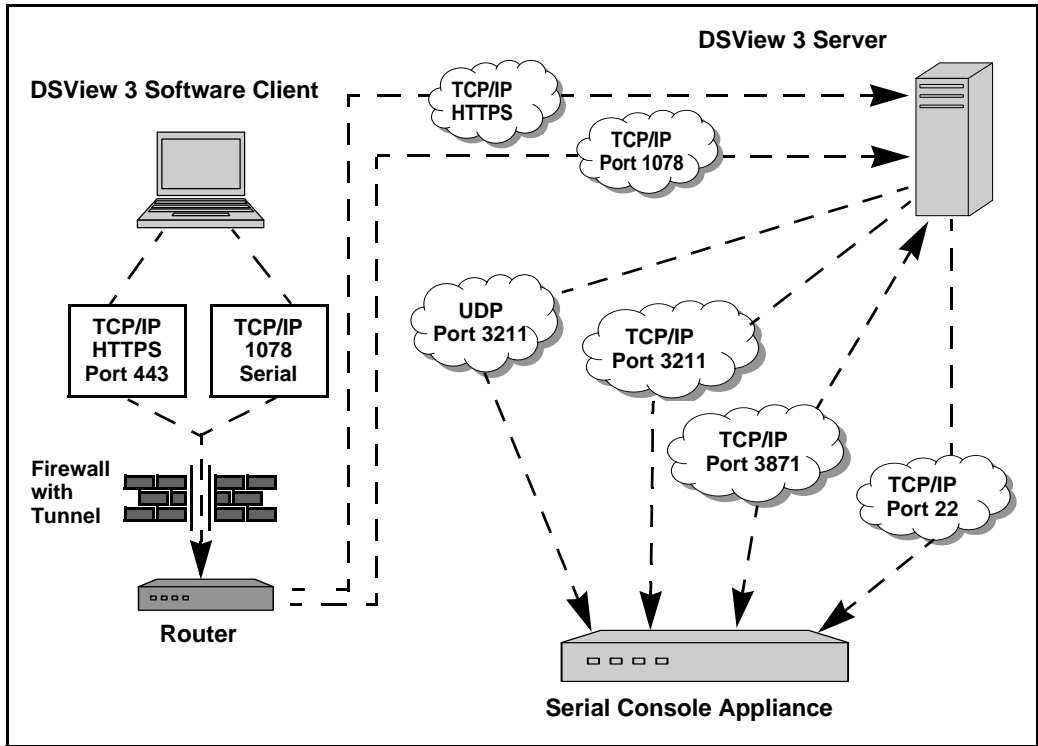

Figure B.4: Ports Used with a Serial Console Appliance Proxy Server Connection (Serial)

DSView 3 server ports

The DSView 3 server uses the HTTPS port for communication with clients and spoke servers. Changes made to the browse list through the DSView 3 management software are transmitted back to the DSView 3 server host, which refreshes its browse list view over the TCP/IP port 443 connection. Changes to the DSView 3 software are also copied to and from the DSView 3 software hub server over the specified HTTPS port.

Generic appliance ports

If you are using a generic appliance in your DSView 3 software system, you may use a Telnet connection through TCP/IP port 23, or an HTTP connection through TCP/IP port 80. The connection is made directly between the client and the generic appliance.

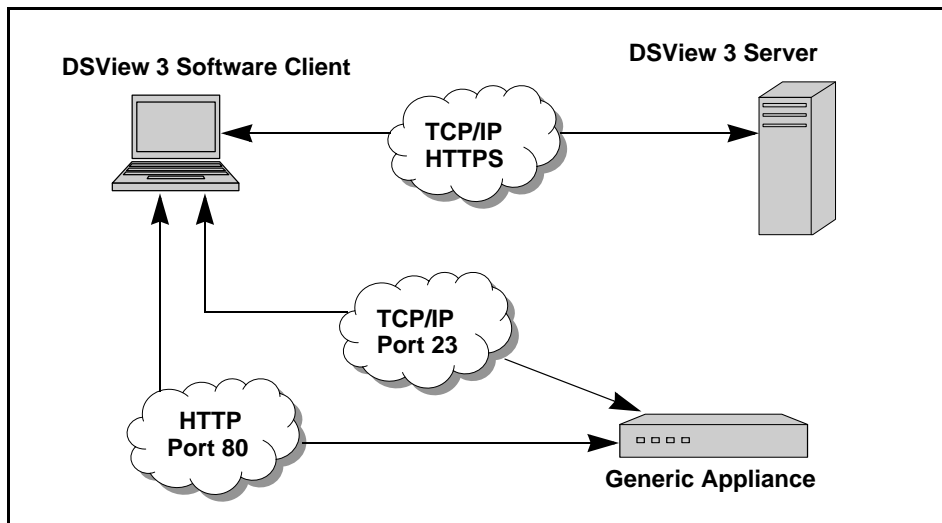

Figure B.5: Generic Appliance Session Ports

If Active Directory or LDAP external authentication is being used within your DSView 3 software system, TCP/IP ports 389 and 636 are used for connections between the DSView 3 server and the external authentication server. Port 389 is typically used for non-SSL connections and port 636 is used for SSL connections. You may configure the ports used by an Active Directory or LDAP external authentication server using the Authentication Service Connection Settings window. See *Authentication Services* on page 60.

External authentication ports

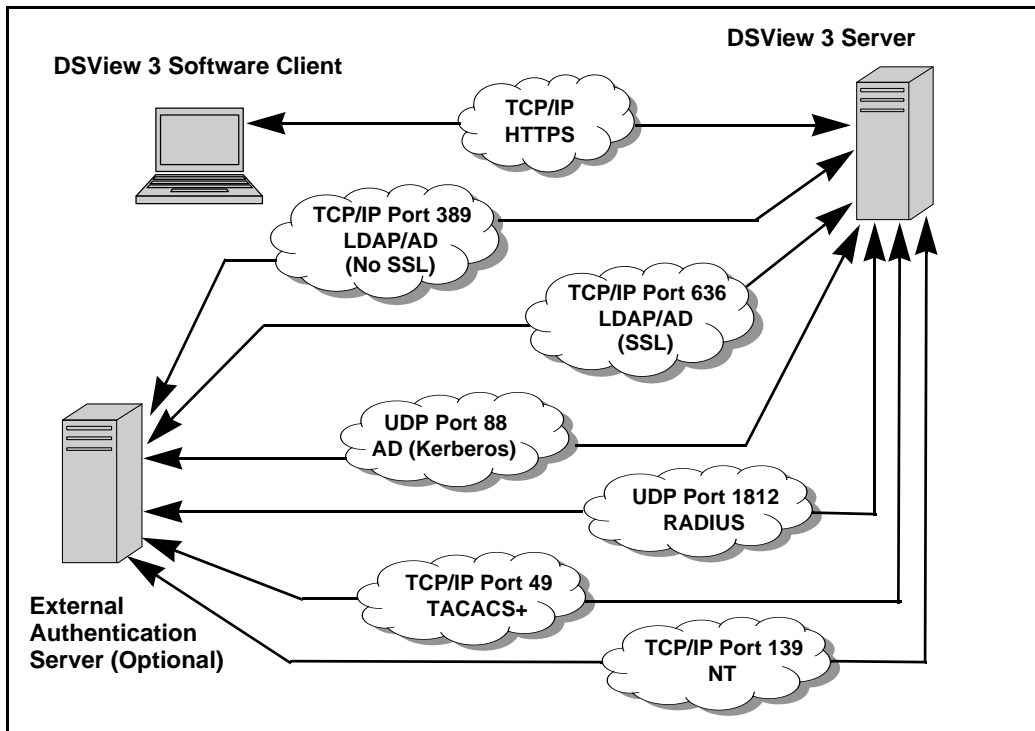

Figure B.6: External Authentication Server Ports

SNMP ports

A supported KVM switch or serial console appliance may be configured to send SNMP traps to the DSView 3 server in addition to an external SNMP manager.

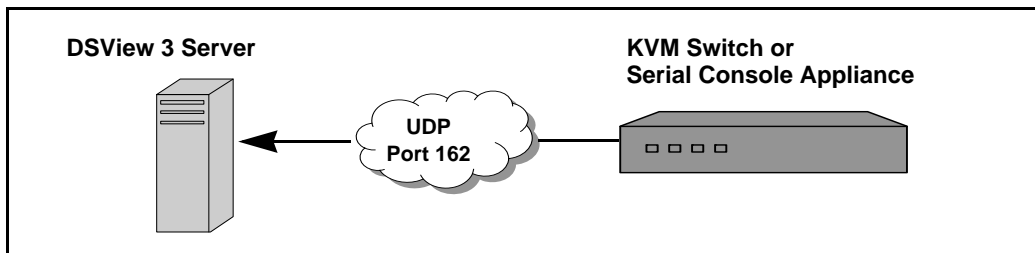

Figure B.7: Ports Used by SNMP (No External SNMP Manager)

If an external SNMP manager has been added to your DSView 3 software system, communication occurs between the SNMP manager and the KVM switch or serial console appliance as shown in Figure B.8.

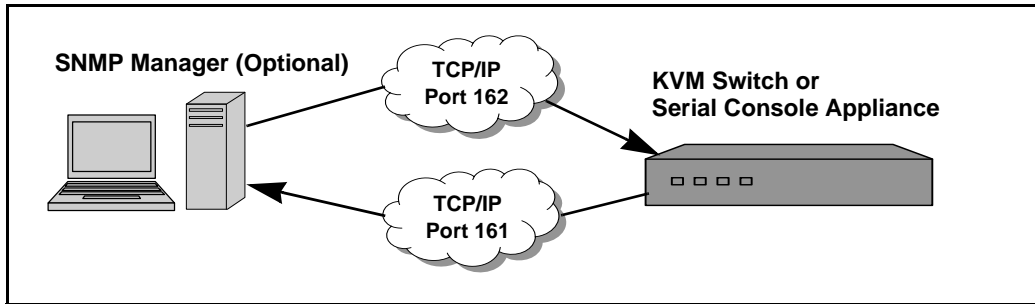

Figure B.8: Ports Used by SNMP (with External SNMP Manager)

Appendix C: DSR Remote Operations Software

NOTE: The DSR Remote Operations software is supported only on the following DSR switches: DSR1020, 1021, 1022, 1024, 1030, 1031, 2020, 2030, 2035, 4020, 4030, 8020, 8030 and 8035 switches.

The DSR Remote Operations software provides a subset of DSView 3 management software functionality that allows access to a supported DSR switch when an Ethernet connection is not available. For example, if you are in a branch office and your Ethernet network is down, you may still access your remote server network by attaching a v.34, v.90 or v.92-compatible modem to the modem port on a supported DSR switch for KVM access, administration and flexible server management control from anywhere in the world.

NOTE: The DSR Remote Operations software uses the IPv4 protocol for communication, so the IPv4 protocol must be enabled on the client server. The IPv6 protocol may also be active on the client server but has no impact upon DSR Remote Operations.

The following DSView 3 software operations are supported:

- Establishing a KVM session to a target device connected to the switch
- Controlling the power sockets of a power device attached to the DSR switch SPC port
- Rebooting the switch
- Retrieving and displaying the switch version

All other DSView 3 software options (including using virtual media) are not available when using the DSR Remote Operations software.

The following Video Viewer window commands are not available when using the DSR Remote Operations software:

- Displaying connected user information
- Creating, editing, copying and deleting macros
Only the default Windows and Sun macro groups are available when using the Remote Operations software.
- Background refresh

The DSR Remote Operations software uses an SSL-based connection to the DSR switch to authenticate the user.

NOTE: Users may be managed within the internal database of the DSR switch using the PPP Configuration menu. See the installer/user guide for your DSR switch for more information.

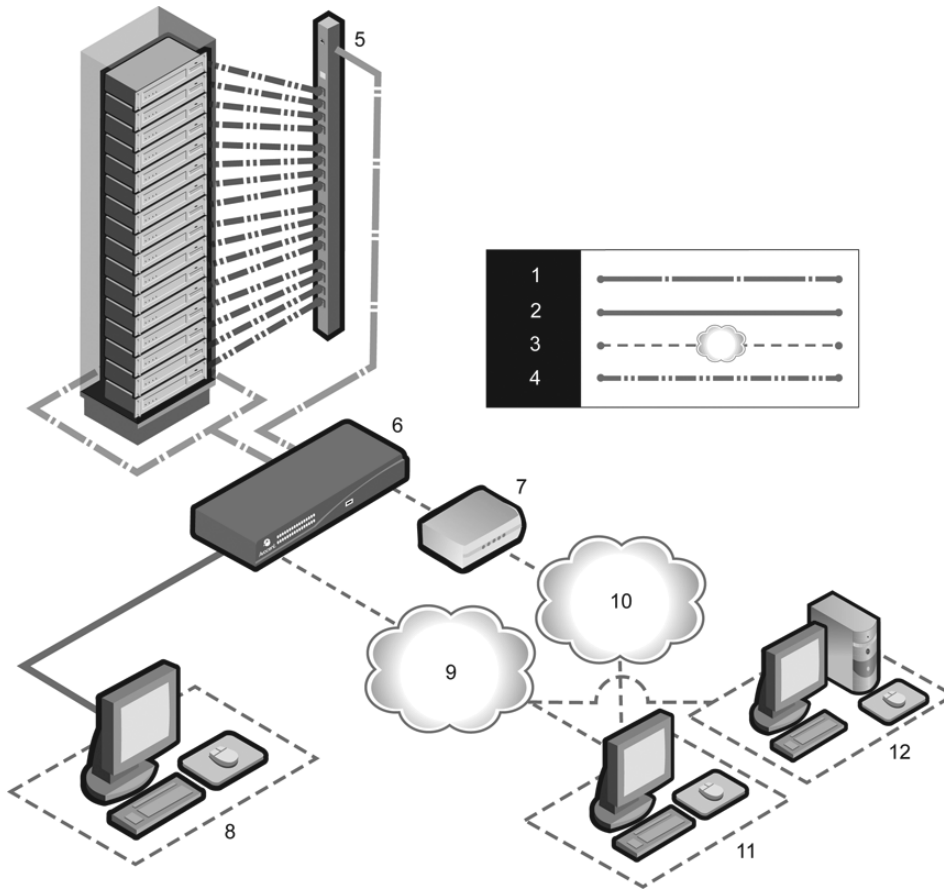

Figure C.1: Using the DSR Remote Operations Software with a DSR Switch

Table C.1: System Configuration Descriptions

Number	Description	Number	Description
1	CAT 5 Connection	7	Modem
2	KVM Connection to Switch	8	Analog User (OSCAR Interface)
3	Remote IP Connection	9	Ethernet
4	AC Power Cord	10	Telephone Network
5	Power Device	11	DSR Remote Operations Client
6	DSR Switch	12	DSView 3 Software Server (Authentication)

Before using the DSR Remote Operations software

The following actions should be performed before using the DSR Remote Operations software:

- Ensure that the switch is configured. See the installer/user guide for the DSR switch for more information.
- Ensure that users have been added to the internal database of the DSR switch. If the DSView 3 server is not available, the appliance database is used for appliance authentication. If neither are available, authentication cannot be performed for the switch and an error will be displayed by the DSR Remote Operations software. See the installer/user guide for the DSR switch for more information.
- An external modem must be attached to the PPP modem interface (modem port) of the DSR switch. A modem/PPP dial-up connection must be established before the DSR Remote Operations software may be started. The modem port should have auto-answer turned off (typically a modem's default setting). The dial-up connection options should be set to 115200 baud, 8 bits, 1 stop bit, no parity and enabled hardware flow control. The DSR Remote Operations application must be started within the authentication time-out specified in the Terminal Applications menu of the DSR switch or the PPP (modem) link will be disconnected.
- Ensure that the PC containing the client interface has dial-up software and that the software is configured properly. See the operating system documentation for more information.
- Install the DSR Remote Operations software.

Installing the DSR Remote Operations software

In this procedure, the DSR Remote Operations software plus its online help and the JRE (Java Runtime Environment) will be installed.

Minimum requirements for the DSR Remote Operations software

The following are the minimum requirements for installing the DSR Remote Operations software as a DSView 3 software client:

- 1 GHz Pentium or equivalent processor
- 512 MB RAM
- XGA video with graphics accelerator
- Desktop size setting of at least 800 x 600
- Color palette of at least 256 colors
- One of the following operating systems:
 - Windows 2000 Workstation or Server with Service Pack 2 or later
 - Windows XP Home Edition or Professional

The DSR Remote Operations software is installed from the DSView 3 software DVD.

To install the DSR Remote Operations software:

1. Log on to the host system as Administrator.

2. Insert the DSView 3 software DVD. An autorun file opens a menu of installation options.
3. Click *Install DSR Remote Operations*.
-or-
If autorun is not enabled, type **<drive:>\DSR Remote Operations\win32\setup.exe**, where <drive:> is the letter of your DVD drive.
4. An installation preparation dialog box displays and the installation program will verify that the client computer meets the minimum requirements for installing the DSR Remote Operations Software.
5. The Introduction window will open. Click *Next*.
6. The License Agreement window will open.
 - If you accept the terms, click *I accept the terms of the License Agreement* and then click *Next*. Go to step 7.
 - If you do not accept the terms, click *I do NOT accept the terms of the License Agreement*. A License Agreement Warning message box will appear.
 - If you click *Quit*, the installation will exit without installing the DSR Remote Operations software.
 - If you click *Resume*, you will be returned to the License Agreement window.
7. The Choose Destination Location window will open.
 - a. Click *Choose* and use the Browse for Folder dialog box to select a directory in which to install the DSR Remote Operations software.
-or-
Click *Restore Default Folder* to restore the installation directory to the default (C:\Program Files\Avocent DSView 3\DSR Remote Operations).
 - b. Click *Next*.
8. The Installing... window will open and displays the progress of the installation. The software will be installed in the specified folder and a Start - Programs - Avocent DSView 3 - DSR Remote Operations shortcut menu will be created.
If a previous version of the DSR Remote Operations software already exists on the Client computer, message boxes may appear asking if you want to overwrite existing files. Click *Yes to All*.
9. When the software has finished installing, the DSR Remote Operations Installation window will open.
 - a. To start the DSR Remote Operations, select *Click here to invoke the DSR Remote Operations application*.
 - b. Click *Done* when you are finished.

Using the DSR Remote Operations software

To start the DSR Remote Operations software:

1. Establish a dial-up connection to the switch from the PC containing the DSR remote operations software.

Windows displays a dialog box that prompts the user for a username and password when a dial-up connection is established. It is not necessary to enter a username or password in the dialog box. When this dialog box appears, click *OK* to close the dialog box.

2. Once the connection has been established, select *Start - Programs - Avocent DSView 3 - DSR Remote Operations* to start the DSR Remote Operations software on the PC. The Login dialog box will appear. Log in using a valid username and password to establish a DSR Remote Operations software session with the DSR switch over the modem link

The switch will disconnect the modem connection if a user does not log in within the time period specified by the authentication time-out value. The default authentication time-out value (120 seconds) may be changed using the Terminal Applications menu. See the installer/user guide for the DSR switch for more information.

The DSR switch will attempt to contact the DSView 3 server to authenticate the user. If the DSView 3 server is unavailable, the switch will use its internal database to authenticate the user.

3. Type the username and password to which you wish to connect and then click *OK*. If authentication is successful, the DSR Remote Operations window will open.

NOTE: The switch will disconnect the modem connection if there is no activity on the modem connection for the time period specified by the inactivity time-out value. The default inactivity time-out value (15 minutes) may be changed using the Terminal Applications menu. See the installer/user guide for the DSR switch for more information.

To exit the DSR Remote Operations software:

Select *File - Exit* from the menu.

Window features

When you have launched the software and successfully logged in, the DSR Remote Operations window will display the list of DSView 3 servers connected to the DSR switch. Figure C.2 shows the DSR Remote Operations window areas, and descriptions follow in Table C.2.

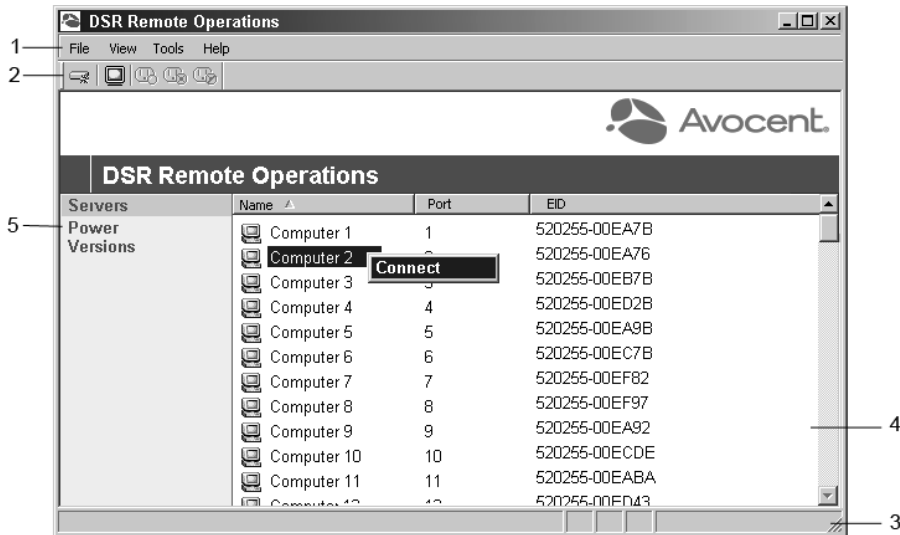

Figure C.2: DSR Remote Operations Window

Table C.2: DSR Remote Operations Descriptions

Number	Description
1	Menu bar: Allows you to access many of the features in the DSR Remote Operations window.
2	Toolbar: Provides shortcut buttons for quickly accessing commands in the Tools menu.
3	Status Bar: Displays the tips for selected menu items and the progress of operations.
4	Content Area: Use this area to display information from the DSR switch and control and start DSView 3 software sessions to the DSR switch.
5	Side Navigation Bar: Displays the DSR switching system information you wish to access, which displays in the Content Area.

The items displayed in the content area of the DSR Remote Operations window will vary, depending on the link selected in the side navigation bar. You may refresh any view by selecting *View - Refresh* from the menu.





Servers view

Selecting *Servers* in the side navigation bar of the DSR Remote Operations window displays a list of servers attached to the switch. The following items for each server will appear in the content area:

- Name - The name of the server
- Port - The switch port to which the server is attached

- EID - The Electronic ID (EID) number of the IQ module attached to the server.





Table C.3: DSR Remote Operations Content Area Icons (Servers View)

Icon	Description
	A target device that is powered up and has no established KVM Video Viewer sessions
	A target device that has an active KVM Video Viewer session
	A target device that is not powered up
	A target device that is powered up but cannot establish a KVM connection because the path to the target device is blocked (for example, a cascade switch has only one user port and that port is already connected to another target device)

Power view

Selecting *Power* in the side navigation bar of the DSR Remote Operations window will display a list of power device sockets attached to the switch and their status.

Table C.4: DSR Remote Operations Content Area Icons (Power View)

Icon	Description
	The power device socket is powered up
	The power device socket is powered down
	The power device socket is cycling
	The socket is unlocked (supported only on certain power device types)
	The socket is locked (supported only on certain power device types)

Version view

Selecting *Version* in the side navigation bar of the DSR Remote Operations window will display version information for the following items:

- Application

- Boot
- Digital/Application
- Digital/Hardware
- Hardware

Rebooting a switch

NOTE: Users with a User level account may not reboot a switch.

To reboot the switch:

1. From the menu, select *Tools - Reboot Appliance*. A confirmation dialog box will appear.
2. Confirm or cancel the reboot.

Managing servers

To connect to a server:

NOTE: Users with a User level account may connect to a server only when given access to a switch.

Select *View - Servers* from the menu or click *Servers* in the side navigation bar. Select a server and select *Tools - Connect* from the menu.

-or-

Select a server and click the *Connect* toolbar button.

-or-

Right-click on a server and select *Connect* from the shortcut menu.

A Video Viewer window will open. See *Using the Video Viewer* on page 249.

Power control of devices attached to power device sockets

Users with User level account privileges cannot change the power state of power device sockets.

Use the Power view to manage power device sockets attached to the switch. See *Power view* on page 370.

To control the power of a device attached to a power device socket:

1. Select *View - Power* from the menu or click *Power* in the side navigation bar. A list of power device sockets attached to the switch will appear in the content area.
2. To power up a device attached to a power device socket, choose one of the following actions:
 - Select a socket that has not been powered up and select *Tools - Power On* from the menu bar.
 - Select a socket that has not been powered up and click the *Power On* toolbar button.
 - Right-click on a socket that has not been powered up and select *Power On* from the shortcut menu.

The socket will power up and the icon for the socket in the content area will change.

3. To power down a device attached to a power device socket, choose one of the following actions:
 - Select a socket that has not been powered down and select *Tools - Power Off* from the menu bar.
 - Select a socket that has not been powered down and click the *Power Off* toolbar button.
 - Right-click on a socket that has not been powered down and select *Power Off* from the shortcut menu.

The socket will power down and the icon for the socket in the content area will change.

4. To cycle the power of a device attached to a power device socket, choose one of the following actions:
 - Select a socket that is powered up and select *Tools - Cycle Power* from the menu bar.
 - Select a socket that is powered up and click the *Cycle Power* toolbar button.
 - Right-click on a socket that is powered up and select *Cycle Power* from the shortcut menu.

The socket will power down, then power up and the icon for the socket in the content area will change accordingly.

5. To lock or unlock the current state of a power device socket, choose one of the following actions:
 - Select a socket and select *Tools - Lock* or *Tools - Unlock* from the menu bar.
 - Select a socket that and click the *Lock* or *Unlock* toolbar button.
 - Right-click on a socket and select *Lock* or *Unlock* from the shortcut menu.

Appendix D: Terminal Emulation

This appendix contains information about the keys, sequences, encoding and decoding for the DSView 3 management software terminal emulation modes when using the Telnet Viewer. Encode refers to how the client interface processes typed keys. Decode refers to how the client interface processes data coming from the target device.

The terminal emulation mode is set by selecting *Options - Session Properties* in the Telnet Viewer window and then using the Terminal Emulation drop-down menu in the Session Properties dialog box. See *Customizing Session Properties* on page 292.

VT terminal emulation

Table D.1 lists the VT key and keypad numeric codes. Avocent encodes all applicable keys as numeric; decoding is not supported.

Table D.1: VT Key and Keypad Numeric Codes

Key	Keypad Numeric Code
0	0
1	1
2	2
3	3
4	4
5	5
6	6
7	7
8	8
9	9
- (dash)	- (dash)
, (comma)	, (comma)
. (period)	. (period)
Enter	Same as Return key

VT100+ terminal emulation

The VT100+ emulation provides compatibility with the Microsoft headless server EMS serial port interface. The DSVIEW 3 software Telnet Viewer VT100+ terminal emulation works identically to VT100, with the exception of support for the function keys listed in Table D.2.

Table D.2: VT100+ Function Key Support

Function	Sequence	Function	Sequence
Home	<Esc> h	F4 **	<Esc> 4
End	<Esc> k	F5	<Esc> 5
Insert	<Esc> +	F6	<Esc> 6
Delete *	<Esc> -	F7	<Esc> 7
Page Up	<Esc> ?	F8	<Esc> 8
Page Down	<Esc> /	F9	<Esc> 9
F1 **	<Esc> 1	F10	<Esc> 0
F2 **	<Esc> 2	F11	<Esc> !
F3 **	<Esc> 3	F12	<Esc> @

* ASCII, VT52, VT100, VT102, VT220 and VT320 modes send hex 7F when the **Delete** key is pressed.
 ** VT100, VT102, VT220 and VT320 modes map the **F1-F4** keys to the **PF1-PF4** keys.

VT102 terminal emulation

VT102 terminal emulation works identically to VT100 with additional support for decoding receive codes as described in Table D.3.

Table D.3: VT102 Receive Codes

VT102 Receive Code	Action
Delete Character (DHC)	Deletes n characters starting with the character at the current cursor position, and moves all remaining characters left n positions. n spaces are inserted at the right margin.
Insert Line (IL)	Inserts n lines at the line where the cursor is currently positioned. Lines displayed below the cursor position move down. Lines moved past the bottom margin are lost.
Delete Line (DL)	Deletes n lines starting with the line where the cursor is currently positioned. As lines are deleted, lines below the cursor position move up.

VT100 terminal emulation

Table D.4 lists the VT100 special key and control (**Ctrl**) key combinations and indicates Avocent encoding/decoding support, where Yes = supported and No = not supported.

Table D.4: VT100 Special Keys and Control Keys

Keys	Hex Code	Function Mnemonic	Encode/Decode
Return	0D	CR	Yes/Yes
Linefeed	0A	LF	Yes/Yes
Backspace	08	BS	Yes/Yes
Tab	09	HT	Yes/Yes
Spacebar	20	(SP)	Yes/Yes
Esc	1B	Esc	Yes/No
Ctrl+Spacebar	00	NUL	Yes/No
Ctrl+A	01	SOH	Yes/No
Ctrl+B	02	STX	Yes/No
Ctrl+C	03	ETX	Yes/No
Ctrl+D	04	EOT	Yes/No
Ctrl+E	05	ENO	Yes/No
Ctrl+F	06	ACK	Yes/No
Ctrl+G	07	BELL	Yes/Yes
Ctrl+H	08	BS	Yes/Yes
Ctrl+I	09	HT	Yes/Yes
Ctrl+J	0A	LF	Yes/Yes
Ctrl+K	0B	VT	Yes/No
Ctrl+L	0C	FF	Yes/No
Ctrl+M	0D	CR	Yes/No
Ctrl+N	0E	SO	Yes/No
Ctrl+O	0F	SI	Yes/No
Ctrl+P	10	DLE	Yes/No
Ctrl+Q	11	DC1 or XON	Yes/No

Table D.4: VT100 Special Keys and Control Keys (Continued)

Keys	Hex Code	Function Mnemonic	Encode/Decode
Ctrl+R	12	DC2	Yes/No
Ctrl+S	13	DC3 or XOFF	Yes/No
Ctrl+T	14	DO4	Yes/No
Ctrl+U	15	NAK	Yes/No
Ctrl+V	16	SYN	Yes/No
Ctrl+W	17	ETB	Yes/No
Ctrl+X	18	CAN	Yes/No
Ctrl+Y	19	EM	Yes/No
Ctrl+Z	1A	SUB	Yes/No
Ctrl+[1B	Esc	Yes/No
Ctrl+\	1C	FS	Yes/No
Ctrl+]	1D	GS	Yes/No
Ctrl+^	1E	RS	Yes/No
Ctrl+_	1F	US	Yes/No

Table D.5 lists the VT100 ANSI mode and cursor keys for set and reset modes. Encoding and decoding is supported for all the cursor keys listed.

Table D.5: VT100 ANSI Set and Reset Mode Cursor Keys

Cursor Key	Mode Reset	Mode Set
Up	Esc [A	Esc O A
Down	Esc [B	Esc O B
Right	Esc [C	Esc O C
Left	Esc [D	Esc O D

Table D.6 lists the VT100 PF1-PF4 key definitions. Encoding of each listed key is supported; decoding is not applicable.

Table D.6: VT100 PF1-PF4 Key Definitions

Key	Code Sequence
F1	Esc [O P
F2	Esc [O Q
F3	Esc [O R
F4	Esc [O S

Table D.7 lists the ANSI mode control sequences for VT100 terminal emulation and indicates Avocent encoding/decoding support, where Yes = supported and No = not supported.

Table D.7: VT100 ANSI Mode Control Sequences

Control Sequence	Definition	Encode/Decode
Esc [Pn; Pn R	Cursor Position Report	No/No
Esc [Pn D	Cursor Backward	No/Yes
Esc [Pn B	Cursor Down	No/Yes
Esc [Pn C	Cursor Forward	No/Yes
Esc [Pn; Pn H	Cursor Position	No/Yes
Esc [Pn A	Cursor Up	No/Yes
Esc [Pn c	Device Attributes	No/No
Esc # 8	Screen Alignment Display	No/Yes
Esc # 3	Double Height Line - Top Half	No/No
Esc # 4	Double Height Line - Bottom Half	No/No
Esc # 6	Double Width Line	No/No
Esc Z	Identify Terminal	No/No
Esc =	Keypad Application Mode	No/No
Esc >	Keypad Numeric Mode	No/No
Esc [Ps q	Load LEDs	No/No
Esc 8	Restore Cursor	No/Yes

Table D.7: VT100 ANSI Mode Control Sequences (Continued)

Control Sequence	Definition	Encode/Decode
Esc [<sol>; <par>;	Report Terminal Parameters <nbits>; <xspeed>; <rspeed>; <clkmul>; <flags>x	No/No
Esc [<sol> x	Request Terminal Parameters	No/No
Esc 7	Save Cursor	No/Yes
Esc [Pn; Pn r	Set Top and Bottom Margins	Yes/Yes
Esc # 5	Single Width Line	No/No
Esc [2; Ps y	Invoke Confidence Test	No/No
Esc [Ps n	Device Status Report	No/Yes
Esc [Ps J	Erase in Display	No/Yes
Esc [Ps K	Erase in Line	No/Yes
Esc H	Horizontal Tabulation Set	Yes/Yes
Esc [Pn; Pn f	Horizontal and Vertical Position	No/Yes
Esc D	Index	No/Yes
Esc E	Next Line	No/Yes
Esc M	Reverse Index	No/Yes
Esc c	Reset to Initial State	No/No
Esc [Ps; Ps,..;Ps 1	Reset Mode	No/No
Esc (A	Select Character Set G0 U.K.	No/No
Esc) A	Select Character Set G1 U.K.	No/No
Esc (B	Select Character Set G0 ASCII	Yes/Yes
Esc) B	Select Character Set G1 ASCII	Yes/Yes (limited support)
Esc (0	Select Character Set G0 Spec. Graphics	Yes/Yes (limited support)
Esc) 0	Select Character Set G1 Spec. Graphics	Yes/Yes (limited support)
Esc (1	Select Character Set G0 Alt. Character ROM Standard Character Set	No/No
Esc) 1	Select Character Set G1 Alt. Character ROM Standard Character Set	No/No
Esc (2	Select Character Set G0 Alt. Character ROM Special Graphics	No/No

Table D.7: VT100 ANSI Mode Control Sequences (Continued)

Control Sequence	Definition	Encode/Decode
Esc) 2	Select Character Set G1 Alt. Character ROM Special Graphics	No/No
Esc [Ps;...; Ps m	Select Graphic Rendition	No/No
Esc Ps;...;Ps h	Set Mode	No/No
Esc [Ps g	Tabulation Clear	No/No
Esc [Ps;Ps;...; Ps m	Character Attributes 7 - Reverse Video On	No/Reverse Video only
Esc [K or Esc [0 K	Erase from cursor to end of line	No/Yes
Esc [1 K	Erase from beginning of line to cursor	No/No
Esc [2 K	Erase entire line containing cursor	No/No
Esc [J or Esc [0 J	Erase from cursor to end of screen	No/Yes
Esc [1 J	Erase from beginning of screen to cursor	No/No
Esc [2 J	Erase entire screen	No/No
Esc [Ps;Ps;...Ps q	Programmable LEDs	No/No
Esc [Pt; Pb r	Scrolling Region	No/No
Esc [g or Esc [0 g	Clear tab at current column	Yes/Yes
Esc [3 g	Clear all tabs	Yes/Yes
Esc [2 0 h	Modes to Set - New Line - Only supports Linefeed/ New Line Column mode wraparound	No/Yes
Esc [2 0 l	Modes to Reset - Linefeed - Only supports Linefeed/ New Line Column mode wraparound	No/Yes
Esc [? 1 h	Modes to Set - Cursor Key Mode Appl.	No/No
Esc [? 1 l	Modes to Reset - Cursor Key Mode Cursor	No/No
Esc [? 2 l	Modes to Reset VT52	No/No
Esc [? 3 h	Modes to Set - 132 columns	No/No
Esc [? 3 l	Modes to Reset - 80 columns	No/No
Esc [? 4 h	Modes to Set - Smooth Scroll	No/No
Esc [? 4 l	Modes to Reset - Jump Scroll	No/No
Esc [? 5 h	Modes to Set - Reverse Screen Mode	No/No

Table D.7: VT100 ANSI Mode Control Sequences (Continued)

Control Sequence	Definition	Encode/Decode
Esc [? 5 l	Modes to Reset - Normal Screen Mode	No/No
Esc [? 6 h	Modes to Set - Relative Origin Mode	No/No
Esc [? 6 l	Modes to Reset - Absolute Origin Mode	No/No
Esc [? 7 h	Modes to Set - Wraparound On	No/No
Esc [? 7 l	Modes to Reset - Wraparound Off	No/No
Esc [? 8 h	Modes to Set - Auto Repeat On	No/No
Esc [? 8 l	Modes to Reset - Auto Repeat Off	No/No
Esc [? 9 h	Modes to Set - Interlace On	No/No
Esc [? 9 l	Modes to Reset - Interlace Off	No/No
Esc [6 n	Report Cursor Position - Invoked by	No/No
Esc [P1; Pc R	Report Cursor Position - Response is	No/No
Esc [5 n	Status Report - Invoked by	No/No
Esc [0 n	Status Report - Response is terminal OK	No/No
Esc [3 n	Status Report - Response is terminal not OK	No/No
Esc [x or Esc [0 c	What are you? Invoked by	No/Yes
Esc [? 1; Ps c	What are you? Response is	No/Yes
Esc c	Reset	No/No
Esc # 8	Fill screen with Es	No/Yes
Esc [2; Ps y	Invoke Test(s)	No/No

VT220 terminal emulation

Table D.8 lists the keystroke mapping (encoding) for VT220 emulation.

Table D.8: VT220 Encoding

VT220 Keyboard	PC Keyboard	VT220 Keyboard Byte Sequence
Delete	Delete	0x7F
Left Arrow	Left Arrow	Esc [D

Table D.8: VT220 Encoding (Continued)

VT220 Keyboard	PC Keyboard	VT220 Keyboard Byte Sequence
Right Arrow	Right Arrow	Esc [C
Up Arrow	Up Arrow	Esc [A
Down Arrow	Down Arrow	Esc [B
Keypad /	Keypad /	/
Keypad *	Keypad *	*
Keypad -	Keypad -	-
Keypad +	Keypad +	+
Keypad .	Keypad .	.
Keypad 0..9	Keypad 0..9	0..9
F1	F1	Esc O P
F2	F2	Esc O Q
F3	F3	Esc O R
F4	F4	Esc O S
F6	F6	Esc [1 7 ~
F7	F7	Esc [1 8 ~
F8	F8	Esc [1 9 ~
F9	F9	Esc [2 0 ~
F10	F10	Esc [2 1 ~
F11	F11	Esc [2 3 ~
F12	F12	Esc [2 4 ~
F13	Ctrl - F5	Esc [2 5 ~
F14	Ctrl - F6	Esc [2 6 ~
F15	Ctrl - F7	Esc [2 8 ~
F16	Ctrl - F8	Esc [2 9 ~
F17	Ctrl - F9	Esc [3 1 ~
F18	Ctrl - F10	Esc [3 2 ~
F19	Ctrl - F11	Esc [3 3 ~

Table D.8: VT220 Encoding (Continued)

VT220 Keyboard	PC Keyboard	VT220 Keyboard Byte Sequence
F20	Ctrl - F12	Esc [3 4 ~

Table D.9 lists the decoding for VT220 terminal emulation.

Table D.9: VT220 Decoding

VT220 Keyboard Function	VT220 Keyboard Byte Sequence
Index	Esc D
New Line	Esc E
Reverse Index	Esc M
Escape	Esc O
Save cursor and attributes	Esc 7
Restore cursor and attributes	Esc 8
Up Arrow	Esc [A
Down Arrow	Esc [B
Right Arrow	Esc [C
Left Arrow	Esc [D
Set cursor to home position	Esc [H
Set cursor to home position	Esc [f
Character attributes	Esc [m
Erase from cursor to end of line	Esc [K
Erase from cursor to end of screen	Esc [j
Programmable LEDs	Esc [q
What are You?	Esc [c
Set Mode	Esc [?
Delete 1 Character	Esc [P
Insert 1 Line	Esc [L
Delete 1 Line	Esc [M
Up Arrow	Esc [O A

Table D.9: VT220 Decoding (Continued)

VT220 Keyboard Function	VT220 Keyboard Byte Sequence
Down Arrow	Esc [O B
Right Arrow	Esc [O C
Left Arrow	Esc [O D
Fill Screen with Es	Esc # 8
Up Arrow amount specified by Pn	Esc [Pn A
Down Arrow amount specified by Pn	Esc [Pn B
Right Arrow amount specified by Pn	Esc [Pn C
Left Arrow amount specified by Pn	Esc [Pn D
Erase parts of current line	Esc [Pn K
Erase parts of current screen	Esc [Pn J
Direct Cursor Addressing	Esc [Pn H
Direct Cursor Addressing	Esc [Pn f
Programmable LEDs	Esc [Pn q
Scrolling Region	Esc [Pn r
Clear tabs	Esc [Pn g
Device status report	Esc [Pn n
What are you?	Esc [Pn c
Sat Mode	Esc [Pn h
Delete Pn Characters	Esc [Pn P
Insert Pn Characters	Esc [Pn L
Delete Pn Lines	Esc [Pn M
Insert Character	Esc [Pn @
Erase Pn Characters	Esc [Pn X

VT52 terminal emulation

Table D.10 lists the keystroke mapping (encoding) for VT52 terminal emulation.

Table D.10: VT52 Encoding

VT52 Keyboard	PC Character Sequence	VT52 Keyboard Byte Sequence
Delete	Delete	0x7F
Up Arrow	Up Arrow	Esc A
Down Arrow	Down Arrow	Esc B
Right Arrow	Right Arrow	Esc C
Left Arrow	Left Arrow	Esc D
Shift-F1	PF1	Esc P
Shift-F2	PF2	Esc Q
Shift-F3	PF3	Esc R
Shift-F4	PF4	Esc S

Table D.11 lists the decoding for VT52 terminal emulation.

Table D.11: VT52 Decoding

VT52 Keyboard Function	VT52 Keyboard Byte Sequence
Cursor Up	Esc A
Cursor Down	Esc B
Cursor Right	Esc C
Cursor Left	Esc D
Cursor Home	Esc H
Reverse Linefeed	Esc I
Erase to end of screen	Esc J
Erase to end of line	Esc K

Table D.12 lists the VT52 and ANSI auxiliary keypad definitions. Encoding of each listed keypad key is supported; decoding is not applicable.

Table D.12: VT52 ANSI Mode Auxiliary Keypad Definitions

Keys	Keypad Numeric Code	VT52 Keypad	ANSI Keyboard
0	0	Esc ? p	Esc O p
1	1	Esc ? q	Esc O q
2	2	Esc ? r	Esc O r
3	3	Esc ? s	Esc O s
4	4	Esc ? t	Esc O t
5	5	Esc ? u	Esc O u
6	6	Esc ? v	Esc O v
7	7	Esc ? w	Esc O w
8	8	Esc ? x	Esc O x
9	9	Esc ? y	Esc O y
- (dash)	- (dash)	Esc ? m	Esc O m
, (comma)	, (comma)	Esc ? l	Esc O l
. (period)	. (period)	Esc ? n	Esc O n
Enter	Same as Return key	Esc ? m	Esc O m

VT320 terminal emulation

Table D.13 lists the keystroke mapping (encoding) for VT320 terminal emulation.

Table D.13: VT320 Encoding

VT320 Keyboard	PC Character Sequence	VT320 Keyboard Byte Sequence
Escape Key (Esc)	Esc	0x1B
F1	F1	Esc O P
F2	F2	Esc O Q
F3	F3	Esc O R
F4	F4	Esc O S
F6	F6	Esc [1 7 ~

Table D.13: VT320 Encoding (Continued)

VT320 Keyboard	PC Character Sequence	VT320 Keyboard Byte Sequence
F7	F7	Esc [1 8 ~
F8	F8	Esc [1 9 ~
F9	F9	Esc [2 0 ~
F10	F10	Esc [2 1 ~
F11	F11	Esc [2 3 ~
F12	F12	Esc [2 4 ~
F13	Ctrl - F5	Esc [2 5 ~
F14	Ctrl - F6	Esc [2 6 ~
F15	Ctrl - F7	Esc [2 8 ~
F16	Ctrl - F8	Esc [2 9 ~
F17	Ctrl - F9	Esc [3 1 ~
F18	Ctrl - F10	Esc [3 2 ~
F19	Ctrl - F11	Esc [3 3 ~
F20	Ctrl - F12	Esc [3 4 ~
Insert	Insert	Esc [1 ~
Home	Home	Esc [2 ~
Delete	Delete	Hex 7 F
End	End	Esc [5 ~
Up Arrow	Up Arrow	Esc [A
Down Arrow	Down Arrow	Esc [B
Left Arrow	Left Arrow	Esc [D
Right Arrow	Right Arrow	Esc [C

Table D.14 lists the decoding for VT320 terminal emulation.

Table D.14: VT320 Decoding

VT320 Keyboard Function	VT320 Keyboard Byte Sequence
Index	Esc D

Table D.14: VT320 Decoding (Continued)

VT320 Keyboard Function	VT320 Keyboard Byte Sequence
New Line	Esc E
Reverse Index	Esc M
Escape O	Esc O
Save cursor and attributes	Esc 7
Restore cursor and attributes	Esc 8
Up Arrow	Esc [A
Down Arrow	Esc [B
Right Arrow	Esc [C
Left Arrow	Esc [D
Set cursor to home position	Esc [H
Set cursor to home position	Esc [f
Character Attributes	Esc [m
Erase from cursor to end of line	Esc [K
Erase from cursor to end of screen	Esc [J
Programmable LEDs	Esc [q
What are You?	Esc [c
Set Mode	Esc [?
Delete 1 Character	Esc [P
Insert 1 Line	Esc [L
Delete 1 Line	Esc [M
Up Arrow	Esc O A
Down Arrow	Esc O B
Right Arrow	Esc O C
Left Arrow	Esc O D
Fill Screen with Es	Esc # 8
Up Arrow amount specified by Pn	Esc [Pn A
Down Arrow amount specified by Pn	Esc [Pn B

Table D.14: VT320 Decoding (Continued)

VT320 Keyboard Function	VT320 Keyboard Byte Sequence
Right Arrow amount specified by Pn	Esc [Pn C
Left Down Arrow amount specified by Pn	Esc [Pn D
Erase parts of current line	Esc [Pn K
Erase parts of current screen	Esc [Pn J
Direct Cursor Addressing	Esc [Pn H
Direct Cursor Addressing	Esc [Pn f
Programmable LEDs	Esc [Pn q
Scrolling Region	Esc [Pn r
Clear tabs	Esc [Pn g
Device status report	Esc [Pn n
What are you?	Esc [Pn c
Sat Mode	Esc [Pn h
Delete Pn Characters	Esc [Pn P
Insert Pn Lines	Esc [Pn L
Delete Pn Lines	Esc [Pn M
Insert Character	Esc [Pn @
Erase Pn Characters	Esc [Pn X

Appendix E: Regaining Access to the DSView 3 Software

Access to a DSView 3 software system may be lost due to reasons such as:

- Being locked out by the DSView 3 software
- Deleting the last DSView 3 software administrator
- Forgetting the DSView 3 software administrator password

To regain access to a DSView 3 software system:

1. Contact Avocent Technical Support. You will be provided with the `resetpassword.zip` archive file.
2. Extract the `resetpassword.zip` archive file into the `<DSView Installation Directory>\bin` directory on the DSView 3 software hub server using a third party product.
3. From the Control Panel, select *Administrative Tools - Services* and stop the Avocent DSView 3 software service.
4. Open a terminal window, change directories to the `<DSView Installation Directory>/bin` directory and enter **`resetpassword.bat`**. A code successfully generated message will appear in the terminal window, along with a request code in the same format as the following:

```
341D3DAD-E71A15B1-66D77BBD-E655BB6C
```

NOTE: Request codes are valid for only four hours.

5. Contact Avocent Technical Support and provide the generated request code.
6. Avocent Technical Support will provide you with a reset code.
7. In a terminal window, enter **`resetpassword.bat <reset code>`**. A *Message reset performed successfully* message will appear in the terminal window, along with the Administrator user-name and password for the DSView 3 management software.
8. From the Control Panel, select *Administrative Tools - Services* and restart the Avocent DSView 3 software service.
9. You may now log into the DSView 3 management software.

Appendix F: Glossary

Access control

Access control refers to mechanisms and policies that restrict access to computer resources.

Active Directory

Active Directory is the directory service included with Microsoft Windows 2000 and later versions of Windows operating systems. It extends the features of previous Windows-based directory services and contains new features that ease the navigation and management of large amounts of information, which may generate savings for both administrators and end users. Active Directory is secure, distributed, partitioned and replicated. It is designed to work well in any size installation, from a single server with a few hundred objects to thousands of servers and millions of objects.

ADSAP (Avocent DS Authentication Protocol) or ADSAP2

The ADSAP or ADSAP2 is a protocol used for authentication and authorization of KVM switch and serial console appliance target device sessions in the DSVIEW 3 management software. This is an SSL based protocol that uses X.509 certificates.

AIDP (Avocent Install and Discover Protocol)

AIDP is a protocol used to install out-of-box appliances that do not have an IP address assigned and used to discover existing appliances that have an address assigned. This UDP-based protocol is not encrypted and only public information is passed over this link. AIDP uses UDP port 3211. Port 3211 is non-configurable.

Applet

An applet is a program written in the Java language that runs within a web browser.

ASMP (Avocent Secure Management Protocol)

ASMP is a protocol used to securely configure managed appliance settings. This TCP-based protocol uses an SSL encrypted communications link. ASMP uses TCP port 3211. Port 3211 is non-configurable.

Authentication

Authentication is the validation of user login information. Authentication is used to enforce selective permission to access resources or to perform an operation.

Authentication server

An authentication server is a network device that provides authentication services.

Authorization

Authorization is the process of granting or denying access to a resource. Most computer security systems are based on a two-step process. The first stage is authentication, which ensures that users are who they claim to be. The second stage is authorization, which allows the user access to various resources based on the user's identity.

AVSP (Avocent Video Session Protocol)

A protocol used to transfer keyboard, video and mouse information between a KVM switch and a remote Video Viewer. AVSP operates over SSL encrypted TCP links. TCP/IP ports 8192 and 2068 are used by default, but may be configured to different port numbers.

Browser session

A type of target device session in which the target device contains a web server. The DSView 3 software client connects directly to the target device using a web browser, without directing the connection through the unit.

Cascade device

A device that connects between a KVM switch or serial console appliance and a target device, or connects to a KVM switch or serial console appliance and is not, in itself, a target device. Examples of cascade devices include a cascade switch and a power device.

Cascade switch

A cascade switch is an analog KVM switch connected to a KVM switch port or IQ module. A cascade switch expands the number of connections allowed on a KVM switch if the switch supports the cascade protocol.

CCM appliance

A CCM console management appliance is an Avocent managed appliance that provides a Telnet server and an SSH server for accessing serially attached devices over a standard TCP/IP connection. Model numbers include the CCM850, CCM1650 and CCM4850 appliances.

Certificate authentication

Certificate authentication is the process of authenticating with a digital certificate.

CPS appliance

A CPS serial over IP network appliance is an Avocent managed appliance that provides a Telnet server and an SSH server for accessing serially attached devices over a standard TCP/IP connection. Model numbers include the CPS810 and CPS1610 appliances.

Database replication

Database replication is the process of distributing and keeping in sync the same database to all DSView 3 servers in a DSView 3 software system. Database replication ensures that all database changes made at the hub server or spoke servers are replicated to all DSView 3 servers in the DSView 3 software system.

The DSView 3 management software versions of the spoke server and hub server must match in order to register the spoke server. For example, you may not register a spoke server running DSView 3 software version 3.1 with a hub server running DSView 3 software version 3.2.

DHCP (Dynamic Host Configuration Protocol)

DHCP is an Internet protocol used to automate the configuration of computers using TCP/IP. DHCP can be used to do the following:

- Assign IP addresses automatically

- Deliver TCP/IP stack configuration parameters, such as the subnet mask and default router
- Provide other configuration information, such as printer addresses

Digital Certificate

A digital certificate is an attachment to an electronic message used for security purposes. The most common use of a digital certificate is to verify that users sending a message are who they claim to be, and to provide the receiver with the means to encode a reply.

An individual wishing to send an encrypted message applies for a digital certificate from a Certificate Authority (CA). The CA issues an encrypted digital certificate containing the applicant's public key and a variety of other identification information. The CA makes its own public key readily available through print publicity or perhaps on the Internet.

The recipient of an encrypted message uses the CA's public key to decode the digital certificate attached to the message, verifies it as issued by the CA and then obtains the sender's public key and identification information held within the certificate. With this information, the recipient can send an encrypted reply.

The most widely used standard for digital certificates is X.509.

DSR switch

The DSR switch is part of the Avocent digital KVM switch series of products that allows KVM signals to be transmitted over a standard TCP/IP connection.

DSView 3 management software

The DSView 3 management software is an Avocent software component installed on a PC. The DSView 3 management software provides the IP-based centralized services required for management of managed appliances and target devices, including centralized authentication, access control, logging events, monitoring, license management and so on. DSView 3 software clients interact with the software using the DSView 3 Explorer.

DSView 3 server

A DSView 3 server is a customer provided PC on which the DSView 3 management software is installed.

DSView 3 software client

The DSView 3 software client is a customer provided PC with an installed web browser. The web browser accesses the DSView 3 server and provides the user interface (that is, the DSView 3 Explorer) for the DSView 3 software system. The DSView 3 Explorer enables users to access and administer the server, managed appliances and target devices.

DSView 3 software client session

The DSView 3 software client session is a single HTML session between the client web browser and the server. For each DSView 3 software client session, the user must log into the DSView 3 server. Multiple DSView 3 software client sessions can exist between a given DSView 3 software client PC and the DSView 3 server. This occurs when the user launches another web browser window and connects to the same DSView 3 server.

A DSView 3 software client session may contain multiple target device sessions.

DSView 3 software hub server

A DSView 3 software hub server is responsible for maintaining the master copy of the DSView 3 software system database. Only one server in a DSView 3 software system can be configured as the hub server. Spoke servers in a DSView 3 software system perform database replication with the hub server. The DSView 3 software hub server acts as the traffic cop for database replication between itself and all of the other servers in a DSView 3 software system.

The DSView 3 software hub server and a spoke server offer the same software functionality to a user. The distinction of hub or spoke only has to do with the database replication role the server plays and not with the software functionality the server offers to the user.

The DSView 3 management software versions of the spoke server and hub server must match in order to register the spoke server. For example, you may not register a spoke server running DSView 3 version 3.1 with a hub server running DSView 3 software version 3.2.

DSView 3 software spoke server

A DSView 3 software spoke server is responsible for initiating database replication with the hub server. A spoke server sends its database changes to the hub server and receives database changes from it.

The DSView 3 software hub server and a spoke server offer the same software functionality to a user. The distinction of hub or spoke only has to do with the database replication role the server plays and not with the software functionality the server offers to the user.

The DSView 3 management software versions of the spoke server and hub server must match in order to register the spoke server. For example, you may not register a spoke server running DSView 3 software version 3.1 with a hub server running DSView 3 software version 3.2.

DSView 3 software system

A DSView 3 software system includes all the components required to provide DSView 3 software functionality, including the DSView 3 server, DSView 3 software client, managed appliances and target devices.

An SNMP manager and external authentication servers, which are optional components and outside the DSView 3 software system, may also be added to provide additional functionality.

Embedded appliance

Embedded appliances include IBM ASM RSA II, DRAC 4, HP iLO and NEC IPF embedded appliances.

Encryption

Encryption is the translation of data into a secret code. Encryption is the most effective way to achieve data security. To read an encrypted file, you must have access to a secret key or password that enables you to decrypt the file. Unencrypted data is called plain text. Encrypted data is referred to as cipher text.

There are two main types of encryption: asymmetric (also called public-key encryption) and symmetric.

External authentication server

The external authentication server is an optional component(s) outside of the DSVIEW 3 software system that enables you to select an authentication method. The DSVIEW 3 server brokers authentication requests (LDAP, RADIUS and so on).

Flash

Flash is a special type of EEPROM that can be erased and reprogrammed in blocks instead of one byte at a time. The BIOS and applications of many modern applications are stored on a Flash memory chip so that it may easily be updated (if necessary).

FRU (Field Replaceable Unit)

An FRU is a module or component which is typically completely replaced as part of a field service repair operation.

Graceful shutdown

A graceful shutdown is identical to a shutdown performed by selecting *Start - Shutdown* and then selecting *Shut down* in the Shut Down Window dialog box.

Hotkey

A hotkey is a keystroke that may be assigned and used to cause a specific action or set of actions to occur within a user interface. By assigning the action(s), the keystroke's normal operation (for example, pressing **F1** to open help) is superseded.

HTML (Hypertext Markup Language)

HTML is a markup language used to create hypertext documents that are portable from one platform to another on the World Wide Web (WWW). HTML files are ASCII text files with embedded codes (markup tags) to indicate formatting and hypertext links. Web browsers interpret and display HTML documents.

HTTP (Hypertext Transfer Protocol)

HTTP is the underlying protocol by which WWW clients and servers communicate. HTTP is an application-level, generic, stateless, object-oriented protocol for distributed, collaborative, hypermedia information systems. A feature of HTTP is the typing and negotiation of data representation, allowing systems to be built independently of the data being transferred.

HTTPS (Secure Hypertext Transfer Protocol)

HTTPS is an extension to the HTTP protocol that supports sending data securely over the WWW.

Integrated windows authentication

Previously known as Windows NT Challenge/Response (NT/CR) or NT LAN Manager (NTLM), Integrated Windows Authentication is a secure form of web browser authentication using either the Kerberos V5 authentication protocol or its own challenge/response authentication protocol.

This authentication method works best in an intranet environment where the types of web browsers that your network users access may be controlled. If you are already logged on to

Windows, Integrated Windows Authentication uses your logon information for authentication, so it will not prompt for a username and password [known as Single Sign-On (SSO)].

Integrated Windows Authentication only works with Internet Explorer and does not work with an HTTP proxy. Integrated Windows Authentication must be explicitly enabled under the Advance Internet Options dialog box of Internet Explorer version 6.0 SP1 and above.

IQ module

An IQ smart module uses CAT 5 cabling to attach a target device to a KVM switch. The IQ module significantly reduces cable bulk in the rack and is well suited for high-density installations. An IQ module is connected to a DSR switch or other supported KVM switch.

Java

Java is an environment for developing and deploying distributed, scalable, enterprise-level applications designed to run on networks, the Internet, and the WWW. The Java platform consists of a set of services, Application Program Interfaces (APIs) and protocols that provide functionality for developing multitiered, web-based applications.

KVM

KVM is an abbreviation of Keyboard, Video, Mouse.

KVM session

A KVM session is a type of target device session in which the target device contains a KVM connection (typically a server). KVM sessions are connected through a KVM switch. Tiered analog switches may also be part of the connection. A KVM Video Viewer connection exists between the DSView 3 software client and the target device.

KVM session profiles

KVM session profiles control KVM session behavior on a target device. A profile contains Video Viewer settings in general, cursor, toolbar, video and mouse scaling categories. There is a default KVM session profile which a target device will use if no other profile is assigned to it. Appliance administrators may create and modify profiles. Appliance administrators or users with unit configure or unit edit rights may assign a profile to a target device.

KVM switch

KVM switch refers to a unit that allows KVM sessions to a target device and is supported by the DSView 3 software. KVM switches include the DSR switch and other switches supported by plug-ins.

LDAP (Lightweight Directory Access Protocol)

LDAP is a set of protocols for accessing information directories. LDAP is based on standards contained in the X.500 standard, but is significantly simpler. Unlike X.500, LDAP supports TCP/IP, which is necessary for Internet access. Because LDAP is a simpler version of X.500, it is sometimes called X.500-lite.

Local port

The local port is the physical connection through which a KVM switch or serial console appliance can be accessed without accessing a network connection.

For a KVM switch, the local port is typically the KVM connection at which a keyboard, mouse and monitor can be connected directly to the switch. An onscreen display may be invoked to control the KVM switch and access switched KVM ports.

For a serial console appliance, the local port is typically the serial connection at which a terminal can be connected directly to the appliance (CCM appliances have a dedicated console port). A command line interface (CLI) is used to control the appliance and access switched serial ports.

Managed appliance

Managed appliances include KVM switches, serial console appliances, EVR1500 environmental monitor and control appliances and generic appliances (such as routers). Other managed appliances may be supported by a plug-in.

MIB (Management Information Base)

MIB is a database of objects that can be monitored by a network management system (NMS). SNMP uses standardized MIB formats that allow any SNMP tools to monitor any device defined by an MIB.

NAT (Network Address Translation)

NAT is an Internet standard that enables a local-area network (LAN) to use one set of IP addresses for internal traffic and a second set of addresses for external traffic. A NAT box located between the LAN and Internet makes all necessary IP address translations.

NAT serves three main purposes:

- Provides a type of firewall by hiding internal IP addresses.
- Enables a company to use more internal IP addresses. Since they're used internally only, there's no possibility of conflict with IP addresses used by other companies and organizations.
- Allows a company to combine multiple ISDN connections into a single Internet connection.

NAT device

A NAT device is a network address translation (NAT) device enables the use of more internal IP addresses than the number that are assigned. A NAT device provides IP addresses that are not exposed outside of the device. The DSView 3 management software will not support network configuration where the DSView 3 server and KVM switch or serial console appliance are separated by a NAT device.

Negative hysteresis

Negative hysteresis is the unsigned number of counts added to the raw threshold value, which creates the re-arm point for all sensor thresholds that are less than zero (0). A negative hysteresis value of 0 indicates that any thresholds less than zero do not contain hysteresis.

OSCAR interface

The OSCAR interface is a tool that is built in to Avocent appliances and allows a user connected to the local KVM port to display and change settings in a KVM switch. The OSCAR interface also allows a local user to connect to target devices.

Power device

An Avocent or supported third party cascade device that allows the remote controlling of target device power.

Positive hysteresis

Positive hysteresis is the unsigned number of counts subtracted from the raw threshold value, which creates the re-arm point for all sensor thresholds that are greater than zero (0). A positive hysteresis value of 0 indicates that any thresholds greater than zero do not contain hysteresis.

PPP (Point to Point Protocol)

PPP is a set of industry-standard framing and authentication protocols included with Windows NT Remote Access Service to ensure interoperability with third party remote access software. PPP negotiates configuration parameters for multiple layers of the OSI (Open Systems Interconnection) model.

SDR repository device

An SDR repository device is the logical management device that provides a sensor data records (SDR) system interface, which in turn, provides a set of SDR storage and retrieval commands.

Serial console appliance

Serial console appliance refers to a unit that allows serial sessions to a target device and is supported by the DSView 3 software. Serial console appliances include the ACS console server, the legacy CCM and CPS appliances and other units supported by plug-ins. The ACS console server is supported by a plug-in; for detailed procedures and what DSView 3 operations the ACS console server supports, see the corresponding plug-in documentation for detailed procedures.

Serial session

A serial session is a type of target device session in which the target device contains a serial connection (typically a Linux server TTY port or a router) and is connected through a serial console appliance. A Telnet Viewer connection exists between the DSView 3 software client and the serial console appliance. The appliance converts the Telnet information to serial information.

Server

A server is a computer or device on a network that manages network resources. For example:

- A file server is a computer and storage device dedicated to storing files. Any user on the network can store files on the server.
- A print server is a computer that manages one or more printers.

- A network server is a computer that manages network traffic.
- A database server is a computer system that processes database queries.

Servers are often dedicated, meaning that they perform no other tasks besides their server tasks. However, on multiprocessing operating systems, a single computer can execute several programs at once. In this case, a server may refer to the program that is managing resources rather than the entire computer.

Session

When used alone, a session refers to a target device session. See the definition of a target device session for details.

Site

A site is a location that contains a managed appliance, DSView 3 server or both.

Smart card

A smart card, common access card (CAC), or integrated circuit card (ICC) is a pocket-sized card with embedded integrated circuits which can process data. Smart cards can be used for single sign-on authentication.

SNMP (Simple Network Management Protocol)

SNMP is a set of protocols for managing complex networks. SNMP works by sending messages to different parts of a network. SNMP-compliant devices, called agents, store data about themselves in MIBs and return this data to the SNMP requesters.

SNMP manager

The SNMP manager is an optional component (outside of the DSView 3 software system) that enables the monitoring of many cross-platform devices using SNMP information. SNMP managers are also called network management systems (NMS).

SSH Passthrough session

An SSH Passthrough session is a serial session opened to a unit by without the use of a web browser. From an SSH client, you can enter an SSH Passthrough command to establish a connection to any serial unit managed by the DSView 3 software if you have access rights.

SSL (Secure Sockets Layer)

SSL is a protocol that supplies secure data communication through data encryption and decryption. SSL enables private communications over networks by using a combination of public key cryptography and bulk data encryption.

Target device

A target device includes a wide range of data center components such as servers and routers that an administrator is able to virtually manage through the DSView 3 management software.

Target device session

A target device session is a connection through a KVM, serial, Telnet or web browser. Target device sessions do not include power management functionality.

TCP/IP (Transmission Control Protocol)

TCP is one of the main protocols in TCP/IP networks. The IP protocol deals only with packets. TCP enables two hosts to establish a connection and exchange streams of data. TCP guarantees delivery of data and that packets will be delivered in the same order in which they were sent.

Telnet session

A Telnet Viewer session is a type of target device session in which the target device supports Telnet and the DSView 3 software client connects directly to the target device using Telnet.

Telnet Viewer

This applet is a software component that provides the user interface needed to display a remote target device through serial over IP sessions.

Tiered switch

A tiered switch is also known as a cascade switch. See the definition of cascade switch.

UDP (User Datagram Protocol)

UDP is a connectionless protocol that runs on top of IP networks like TCP. Unlike TCP/IP, UDP/IP provides very few error recovery services, offering instead a direct way to send and receive datagrams over an IP network. UDP is primarily used for broadcasting messages over a network.

Unit

Unit is a generic term that refers to either a target device, managed appliance, blade chassis or a component in a virtual environment. For example, the Unit List may contain both target devices and managed appliances.

Video Viewer

The Video Viewer is a software component that provides the user interface needed to display a remote target device through KVM over IP sessions.

VPN (Virtual Private Network)

VPN is a means of implementing a private network on a public network such as the Internet. By encrypting data and assigning addresses, the impression is given to networks at each end of the VPN that they are connected by a private physical network instead of across a public network.

(WAN) Wide Area Network

WAN typically refers to a network that is distributed at multiple sites and connected by a relatively slow link between the sites. The WAN is frequently implemented using a VPN on the Internet.

(WAS) Web Application Server

WAS is software that runs on a server that is capable of executing web applications. The WAS software typically contains or works with a web (HTTP) server.

(Webapp) Web Application

Webapps are groups of server-side Web resources that make up an interactive online application. The web resources include Java servlets, JavaServer Pages™ (JSPs), static

documents (such as HTML documents), and applets that can be deployed in a DSView 3 software client web browser. Web applications must run in the context of a web application server such as the DSView 3 server.

Web server

A web server is a computer equipped with server software to respond to HTTP requests, such as requests from a web browser. A web server uses the HTTP protocol to communicate with clients on a TCP/IP network.

X.509

X.509 is the most widely used standard for defining digital certificates. X.509 is an International Telecommunications Union (ITU) recommendation, which means that the standard has not yet been officially defined or approved. As a result, companies have implemented the standard in different ways. For example, both Mozilla and Microsoft use X.509 certificates to implement SSL in their web servers and web browsers. However, an X.509 certificate generated by Mozilla may not be readable by Microsoft products, and vice versa.

INDEX

A

Access

- methods 108
- regaining 389

Access rights

- about 144
- exporting 307
- methods for assigning 145
- specifying from unit group perspective 216
- specifying from unit perspective 146
- specifying from user account perspective 239
- specifying from user group perspective 246
- target devices 145

Active Directory external authentication service 82

ActiveX controls 43

Adobe Flash Player 17

AlterPath Manager

- importing data from 312
- migrating to DSView 3 software 312, 327

appliance configuration templates 137

Appliances. *See Managed appliances*

Authentication services

- Active Directory 82
- group naming in external services 242
- internal 80
- LDAP 88
- managing 79
- ports 362
- RADIUS 93
- removing 80
- RSA SecurID 98

TACACS+ 95

- types 79
- validating user accounts on external authentication server 330
- Windows NT 87

Avocent Mouse Sync 261

Avocent Mouse Synchronization (AMS) 266

B

Backup and restore 69, 323

Backup servers. *See Spoke servers*

Bookmarks 30

Browsers 1, 42

C

Cascade switches

- changing name in appliance 155
- changing name or type 134
- merging 134
- port settings 155
- splitting 134
- supported types 5

Certificates

- security alerts 61
- server 46, 64
- system policy 47
- trust store 47
- types 46
- updating 61, 64, 65
- user 38, 47, 235

Client session information 66

Colors 37

Connections

- adding a target device connection 183
- deleting a target device connection 183
- display format 181
- displaying information 182
- renaming a managed appliance connection 182

Contact unit properties 141, 142

CSR 61**Custom fields**

- about 207
- associated a label with a unit 208
- changing for a unit 142
- defining 208
- example 208

Customize link 28

D**Data logging**

- archiving 191
- deleting data log files 191
- displaying data log files 193
- enabling on units 188
- enabling the SSH server 187
- exporting system certificate 46
- files 185
- licenses 186
- specifying data log file location 190
- verifying signatures 194

Department groups 205

DS Zones 219

DSR Remote Operations software 364

DSView 2.x software

- migrating units 326

E**Email**

- DSView 3 server 68
- event logs 340

Embedded units

- about 160
- access rights 144
- accessing 108
- adding 118
- credentials 161
- sessions 160
- supported models 6

Encryption

- KVM sessions 173
- virtual media sessions 174

Event logs

- creating a .csv file 347
- creating a task to export a .csv file 325
- deleting entries 345
- displaying 343
- displaying entries 344
- displaying entry details 344
- email notifications 340
- enabling and disabling event logging 343
- entry states 345
- event categories 340
- event severity 339
- retaining 346

EVR1500 environmental monitors

- adding 122
- network properties 144

F

Filtering 26

Firewalls 50

Firmware

- adding a file 336
- deleting 337
- displaying information 336
- displaying version information 148
- updating for an appliance type 329
- upgrading 314
- upgrading a power device 167
- upgrading IQ modules 154

Flash Player 17

G

Generic appliances

- adding 122
- network properties 144

Glossary 390

Groups

- departments 205
- locations 205
- sites 205
- unit 210

H

Hub server

- about 2
- adding to Trusted Sites list 45
- backup and restore 69, 323
- certificates 61
- license 54
- properties 59
- registering hub server as spoke server 73
- replication 75
- updating hub server certificate on spoke server 65
- updating spoke server certificate on hub server 64

I

Identity unit properties 141

infrastructure 162

Installation

- configuring DSView 3 software 14
- DSR Remote Operations software 21, 366
- DSView 3 software 10
- Java 19
- minimum requirements for client 16
- requirements for DSView 3 server 9
- supported operating systems 10
- uninstalling the DSView 3 software 18
- what to do before installing DSView 3 software 10

Integrated Windows Authentication 49

Internal authentication service 80

Internet Explorer considerations 42

IPMI target devices

- creating a task to control power 328

IPv4 and IPv6 network protocols 2, 116

IQ modules

- deleting offline 153
- displaying 153
- upgrading 154
- USB speed 154

ISDN

- active modem sessions 179
- modem session properties 67

ISV partners program 57

J

Java 19, 284

K

Keyboard commands 31

Keyboard pass through mode 255

L

LDAP external authentication service 88

Legal notice 35

Licenses 54

Local accounts

- adding 157

- changing settings 159

- deleting 158

- displaying information 157

- target device access rights 159

Location groups 205

Location unit properties 141

Login scripts (Telnet Viewer) 294

M

Macros

- exit (DSR switches) 175

- Telnet Viewer 296

- Video Viewer 274

Managed appliances

- adding a generic appliance 122

- adding a single appliance 116

- adding an appliance from an IP address range
120

- adding an EVR1500 environmental monitor 122

- changing name 113

- displaying connections 182

- displaying version information 148

- DSView 3 server addresses 148

- firmware management 336

- local account settings 157

- names 123, 125

- network properties 143

- network settings 147

- ports used 356

- rebooting 313

- renaming a connection 182

- restoring a configuration 316

- restoring the user database 317

- resynchronizing 315

- saving a configuration 316

- saving the user database 317

- secure mode 117, 121, 149

- session settings 170, 171

- SNMP settings 149, 324

- supported 4

- tools 313

- updating firmware of an appliance type 329

- upgrading firmware 314

Modem connections

- active modem sessions 179

- modem session properties 67

Modem dial connections 196

Modem port settings (DSR switches) 156

Mouse

- cursor commands in Video Viewer 264

- cursor settings in KVM session profile 257

- preventing conflicts 10

N

Name synchronization 123, 125

NAT devices 53

Network properties

- DSView 3 server 59

- generic appliance 144

- managed appliance 143

- spoke servers 74

- target device 143

Network settings for managed appliances 147

Note unit properties 142, 143

O

Operating systems

- client 16

- DSR Remote Operations software 366

- DSView 3 server 10

OSCAR interface authentication setting (DSR switches) 156

Overview unit properties 140

P

Pages 29

Partners program 57

Passwords

- changing in user account 236

- changing user account restrictions 236

- changing your own 37

- resetting in user account 233

PCI compliance 35

Plug-ins

- about 349

- activating 353

- adding 350

- disabling 353

- displaying information 350

- upgrading 352

Ports

- cascade switch settings 155

- modem port settings (DSR switches) 156

- OSCAR interface authentication settings (DSR switches) 156

- TCP and UDP 356

Power device sockets

- displaying 168

- push/pull 168

Power devices

- adding 166

- changing input feed information 168

- changing settings 166

- controlling power from a Power Device Sockets window 169

- controlling power from a Units View window 170

- controlling power from DSR Remote Operations software 371

- controlling power from the Telnet Viewer 303

- controlling power from the Unit Overview window 113

- controlling power from the Video Viewer 279

- controlling power with a task 324

- displaying 165

- displaying input feed information 167

- licenses 54

- push/pull 165

- removing 166

- sockets 168

- supported types 7

- upgrading firmware 167

Preemption

- about 41

- changing in user account 237

- virtual media 280

Printing 30

Profiles

- DSView 3 software sessions 36

- KVM sessions 254

Properties

- contact 141, 142

- DSView 3 server 59

- generic appliance network 144
- global system 31, 34
- managed appliance network 143
- note 142, 143
- spoke server network 74
- target device network 143
- unit identity 141
- unit location 141
- Video Viewer session 253

Proxy server

- about 2
- ports used 356
- specifying 65

Push/pull

- about 123, 125
- automatic name pull 127
- automatic name push 126
- manual name pull 129
- manual name push 128
- pull names task 330

R

- RADIUS external authentication service 93

- Replication 75

Requirements

- client 16
- DSR Remote Operations software 366
- DSView 3 server 9

Resync wizard

- topology synchronization options 132
- using 315

- RSA SecurID external authentication service 98

S

- Scan mode (Video Viewer) 271

- Secure mode 117, 121

Security

- alerts 61
- zones 44

- Serial session application selection 38

Servers

- backup and restore 323
- email 68
- managing certificates 64
- manually backup and restore 69
- ports used 356, 360
- properties 59
- proxy 65
- replication 75
- trap destinations 66
- unit status polling 69
- See also *Hub server and Spoke servers*

- Services 151

Sessions

- access methods 108
- changing KVM session settings 173
- changing serial console appliance settings 173
- changing virtual media settings (KVM switch) 174
- choosing serial session application 38
- client information 66
- closing a DSView 3 software client session 19
- disconnecting an active session from a target device window 179
- disconnecting an active session from an appliance window 177
- displaying active session information (all sessions) 176
- displaying active session information for a target device 178
- displaying appliance session information 172

- managing active 176
- opening a DSView 3 software client session 16
- removing an active session from display 177
- sharing (CCM appliances) 173

Side navigation bar 24

Site groups 205

SNMP 149, 324, 362

Sorting 26

Spoke servers

- about 2
- adding 73
- certificate management 64
- certificates 61
- changing network properties 74
- deleting 74
- displaying 72
- licenses 54
- managing 72
- promoting to hub servers 75
- properties 59
- registering hub server as spoke server 73
- replication 75
- updating hub server certificate on spoke server 65
- updating spoke server certificate on hub server 64

SSH

- enabling server for data logging and SSH Passthrough 187
- specifying a user SSH key in profile 39
- specifying user SSH key in user account 235

Telnet Viewer 290

SSH Passthrough sessions 195

- port sharing 196
- read/write access 202

- SP commands 203

SSL 61

Synchronization 123, 125

- automatic name pull 127
- automatic name push 126
- automatic topology 131
- manual name pull 129
- manual name push 128
- resynchronizing 315
- topology 130
- topology options in Add Unit Wizard 131
- topology options in Resync Wizard 132

T

TACACS+ external authentication service 95

- adding groups 244

Target devices

- access rights 145
- access rights to a local account 159
- accessing 24, 108
- adding 122
- adding a connection 183
- adding units with default names 117, 121
- attaching from a topology view 105
- controlling power through power devices 169
- default names 130, 132
- deleting a connection 183
- deleting devices with no connections 130, 132
- device settings 122
- displaying 150
- displaying connections 182
- merging 133, 307, 308
- merging duplicate names 117, 121
- names 123, 125
- network properties 143

- services 151
- settings 150
- Unit Overview information 148
- Tasks
 - about 317, 319
 - adding 320
 - changing 335
 - deleting 335
 - displaying results 334
 - running manually 334
 - scheduling 320
- TCP ports 356
- Technical support 355
- Telnet
 - choosing serial session application 38
 - third party applications 38
 - Viewer 287
 - See also *Telnet Viewer*
- Telnet Viewer
 - about 287
 - closing a session 304
 - controlling power of devices attached to power devices 303
 - copying session data 302
 - customizing preferences for all sessions 291
 - customizing session properties 292
 - logging 299
 - login scripts 294
 - macros 296
 - opening a session 290
 - printing session data 302
 - reviewing session data 295
 - SSH2 client 290
- Terminal emulation 373
- Terminal Services 151

Thumbnail Viewer. See *View Viewer - Scan mode*

- Topology
 - exporting report 305
 - synchronization 130
 - update topology task 331
 - view 104

U

- UDP ports 356
- Unit groups
 - about 210
 - adding 214
 - changing access rights 216
 - changing membership 216
 - changing the name 215
 - deleting 215
 - displaying group information 214
 - displaying group names 213

Units

- access rights 144
- accessing 108
- adding 113, 115
- connections 181
- contact properties 141, 142
- custom fields 142
- deleting 123
- exporting 305
- grouping 205
 - grouping by custom fields 207
 - grouping by department 205
 - grouping by location 205
 - grouping by sites 205
 - grouping by unit group 210
- hiding 107
- identity properties 141

- location properties 141
- managed appliance settings 147
- merging cascade switches 134
- merging target devices 133
- migrating DSView 2.x units 326
- multiple unit operations 111
- names 123, 125
- note properties 142, 143
- overview properties 140
- properties 139
- showing 107
- splitting cascade switches 134
- status 108
- status polling 69
- synchronization 123, 125
- topology view 104
- unit groups 210
- Unit Overview windows 112
- Units View windows 103
- User accounts
 - about displays 229
 - access rights 239
 - adding 231
 - changing address 237
 - changing expiration 236
 - changing password 236
 - changing preemption level 237
 - changing restrictions 236
 - changing user certificate 38, 235
 - changing user group membership 237
 - changing username 234
 - deleting 233
 - properties 234
 - resetting password 233
 - setting the lockout policy for internal
 - authentication service users 81
 - specifying user SSH key 235
 - unlocking 233
 - validating on external authentication server 330
- See also *User groups*
- User groups
 - about 241
 - access rights 246
 - adding user-defined 242
 - built-in 40
 - changing members 245
 - changing properties 245
 - deleting user-defined 244
 - naming in external authentication services 242
- User options in client sessions 36
- V**
- Video noise compensation 173
- Video Viewer
 - about 249
 - capturing a display 270
 - closing a session 254
 - connecting to an existing session 252
 - displaying users 270
 - KVM session profiles 254
 - manual video adjustment 267
 - menu commands 263
 - opening a KVM session 251
 - power controlling devices attached to power
 - devices 279
 - scan mode 271
 - session properties 253
 - session time-out 254
- Virtual media
 - about 279

- access mode 174
- changing session settings 174
- closing a session 283
- launching a session 281
- locking to KVM session 174
- mapping drives 281
- requirements 279
- session settings 281
- sharing and preemption 280

VNC 151

VPN 51

W

Windows NT external authentication service 87

Wizards

- Add Appliance 116, 118, 120

- Add Local User Account 158

- Add Target Device 122

- Add Target Device Connection 183

- Add Task 320

- Add Unit 122

- adding units 116

- Attach Device 105

- Importing Data 312

- Power Management 166

- Register Spoke Server 73

- topology synchronization options 131, 132

- Update DSView Server Certificate 63

X

X.509. See *Certificates*

Z

Zones. See *DS Zones*



For Technical Support:
www.avocent.com/support

590-395-501M

Free Manuals Download Website

<http://myh66.com>

<http://usermanuals.us>

<http://www.somanuals.com>

<http://www.4manuals.cc>

<http://www.manual-lib.com>

<http://www.404manual.com>

<http://www.luxmanual.com>

<http://aubethermostatmanual.com>

Golf course search by state

<http://golfingnear.com>

Email search by domain

<http://emailbydomain.com>

Auto manuals search

<http://auto.somanuals.com>

TV manuals search

<http://tv.somanuals.com>