

8 port / 16 port
PS/2 KVM over IP SWITCH
USER'S MANUAL

Rev 1.0

TABLE OF CONTENTS

1. THE QUICK INSTALLATION GUIDE	1
2. INTRODUCTION	4
2.1 When the server is up and running	4
2.2 When the sever is dead	4
2.3 Features	5
2.4 Package contents	6
2.5 Technical specifications	7
2.6 System requirement	8
2.7 Cable diagrams	8
2.8 Product Details	9
3. HARDWARE INSTALLATION	10
3.1 Operation Overview	10
3.2 Connecting PS/2 IP-KVM SWITCH to the host system	10
4. CONFIGURATION	14
4.1 Initial Configuration	14
4.1.1 Initial configuration via DHCP server	14
4.1.2 Initial configuration via serial console	16
4.1.3 Keyboard, Mouse and Video configuration	16
4.1.3.1 IP-KVM switch keyboard settings	17
4.1.3.2 Remote Mouse Settings	17
4.1.3.3 Auto mouse speed and mouse synchronization	17
4.1.3.4 Host system mouse settings	17
4.1.3.5 Single and Double Mouse Mode	18
4.1.3.6 Recommended Mouse Settings	18
4.1.3.7 Video Modes	18
5. USAGE	20
5.1 Prerequisites	20
5.2 Using PS/2 KVM over IP switch as a KVM switch	21
5.2.1 Daisy Chain Connection Diagram	23
5.2.2 Hot Plug	24
5.2.3 On Screen Display Operation	25
5.3 Login into the IP-KVM switch and logout	27
5.3.1 Login into the IP-KVM switch	27
5.3.2 Logout from the IP-KVM switch	29
5.4 The Remote Console	29

5.5	Main Window	30
5.5.1	Remote Console Control Bar	30
5.5.2	Remote Console Status Line	36
6.	MENU OPTIONS	37
6.1	Remote Control	37
6.1.1	KVM Console	37
6.1.2	Telnet Console	37
6.2	User Management	39
6.2.1	Change Password	39
6.2.2	Users And Groups	39
6.3	KVM Settings	40
6.3.1	User Console	40
6.3.2	Keyboard/Mouse	43
6.3.3	Video	44
6.4	Device Settings	45
6.4.1	Network	45
6.4.2	Dynamic DNS	47
6.4.3	Security	49
6.4.4	Certificate	50
6.4.5	Serial Port	52
6.4.6	Date And Time	54
6.4.7	Event Log	55
6.5	Maintenance	56
6.5.1	Device Information	56
6.5.2	Event Log	58
6.5.3	Update Firmware	59
6.5.4	Unit Reset	60
7.	TROUBLESHOOTING	61
8.	CERTIFICATES	62
A.	PIN ASSIGNMENTS	
B.	KEY CODES	
C.	VIDEO MODES	

1. The Quick Installation Guide

Installation

PS/2 IP-KVM switch redirects local keyboard, mouse and video data to a remote administration console. All data is transmitted via IP. PS/2 IP-KVM switch can be used in a multi administrator and multi server environment as well. Besides, PS/2 IP-KVM switch is a KVM switch, which can also be used with a local console. Connecting PS/2 IP-KVM switch to the host system



In order to connect the PS/2 IP-KVM switch perform the following steps:

1. Connect the power supply to PS/2 IP-KVM switch.
2. Connect the monitor to the PS/2 IP-KVM switch.
3. Connect the keyboard to the PS/2 IP-KVM switch.
4. Connect the mouse to the PS/2 IP-KVM switch.
5. Plug the HDDB15 pin connector of a 3-in-one cable into any label computer port on the rear of PS/2 IP-KVM switch unit. Then connect the HDDB-15 pin male type for PC video, the purple Mini Din 6 pin female type for keyboard and the green Mini Din 6 pin female type for mouse. To plug these three connectors into the respective ports of computer.
6. Repeat item 5 procedure to all of PC ports of PS/2 IP-KVM switch
7. Connect Ethernet and/or modem, depending how you want to access PS/2 IP-KVM switch.

Video modes

PS/2 IP-KVM switch recognizes a limited number of common video modes. When running X-Window on the host system, please don't use any custom mode lines with special video modes. If done so, PS/2 IP-KVM SWITCH may not be able to detect these. You are on the safe side with all standard VESA video modes. Please refer to Appendix C for a list of all known modes.

Initial IP configuration

Initially the PS/2 IP-KVM switch network interface is configured with the parameters shown in Table 1.1.

Parameter	Value
IP auto configuration	DHCP
IP-Address	192.168.1.22
Net-mask	255.255.255.0
Default-Gateway	none

Table 1.1: Initial configuration

If this initial configuration doesn't meet your local requirements, you need to do the initial IP configuration. Use one of the following ways:

1. Connect the enclosed NULL modem cable to the serial interface on the rear side. The serial interface needs to be adjusted with the parameters shown in table 1.2:

Parameter	Value
Bits/second	115200
Data bits	8
Parity	No
Stop bits	1
Flow Control	None

Table 1.2: Serial parameters

Use a terminal software (e.g. hyper term or minicom) to connect to PS/2 IP-KVM switch. Reset PS/2 IP-KVM switch and immediately press <ESC>. You will see some device information and a '=' prompt. Enter the command 'config' and press <Enter>. After waiting a few moments you may configure IP auto configuration, IP address, net mask and default gateway. Pressing <Enter> without entering values does not change settings. The gateway value must be set to 0.0.0.0 (for no gateway) or any other value. You will be asked if the values are correct and get a chance to correct them. After confirming, PS/2 IP-KVM switch performs a reset.

2. Use a crossover Ethernet cable to connect PS/2 IP-KVM switch to a subnet where a DHCP server is available. After the DHCP server has assigned an IP address to PS/2 IP-KVM switch you can use the web interface to configure the device.

Web interface

IP-KVM switch may be accessed using a standard JAVA enabled web browser. You may use the HTTP protocol or a secure encrypted connection via HTTPS. Just enter the configured IP address of IP-KVM switch into your web browser.

Login name	super (factory default)
Password	pass (factory default)

Changing these settings to user specific values is strongly recommended and can be done on the User Management page (see the Section called Users and Groups in Chapter 6).

Remote Console

The Remote Console is the redirected screen, keyboard and mouse of the remote host system to which IP-KVM switch is installed. The web browser which is used for accessing IP-KVM switch has to supply a Java Runtime Environment version 1.1 or higher. However, it is strongly recommended to install Sun JVM 1.4. The Remote Console will behave exactly the same way as if you were sitting directly in front of the screen of your remote system. That means that both the keyboard and mouse can be used in the usual way. Open the console by selecting the preview picture on the main site of the HTML front end. Figure 1-2 shows the top part of the Remote Console.



Figure 1.3: Top part of the Remote Console

There are some options to choose from and the important ones are the following:

Auto Adjust button 

If the video displayed is of bad quality or distorted in some way, press this button and wait a few seconds while PS/2 IP-KVM switch tries to adjust itself for the best possible video quality.

Sync Mouse 

Choose this option in order to synchronize the local with the remote mouse cursor. This is especially necessary when using accelerated mouse settings on the host system. In general there is no need to change mouse settings on the host.

Video Settings in Options Menu This opens a new window with elements to control the PS/2 IP-KVM

switch Video Settings. You can change some values, for instance the brightness and contrast of the picture displayed, which may improve the video quality. It is also possible to revert to the default settings for all video modes or only the current one.

Note: At first start, if the local mouse pointer is not synchronized with the remote mouse pointer, press the Auto Adjust Button once.

2. Introduction

Thank you for purchasing PS/2 IP-KVM switch. PS/2 IP-KVM switch can save your MONEY, TIME, SPACE, EQUIPMENT and POWER. PS/2 IP-KVM switch defines a new class of remote KVM access devices. PS/2 IP-KVM switch combines an 8/16/32-port KVM switch with digital remote KVM access via IP networks and comprehensive system management.

PS/2 IP-KVM switch provides convenient; remote KVM access and control via LAN or Internet. It captures, digitizes, and compresses video signal and transmits it with keyboard and mouse signals to and from a remote computer. PS/2 IP-KVM switch provides a non-intrusive solution for remote access and control. Remote access and control software runs on its embedded processors only but not on mission-critical servers, so that there is no interference with server operation or impact on network performance.

Furthermore, PS/2 IP-KVM switch offers additional remote power management with the help of optional available device.

PS/2 IP-KVM switch supports consoles consisting of PS/2 style keyboards and mouse, and HD 15 video output. PS/2 IP-KVM switch will automatically detect the current video mode of the console, however manual fine-tuning is recommended to receive the best video quality. PS/2 IP-KVM switch will accept video streams up to 110 MHz dot clock. This results in a screen resolution of 1280x1024 pixels with a frame rate of 60 Hz.

2.1 When the server is up and running

PS/2 IP-KVM switch gives you a full control over the remote server. The Management Console allows you to access the remote server's graphics, keyboard and mouse and to send special commands to the server. You can also perform periodic maintenance of the server. Using the Console Redirection Service, you are able to do the following:

- I. Reboot the system.
- II. Watch the boot process.
- III. Boot the system from a separate partition to load the diagnostic environment.
- IV. Run special diagnostic programs.

2.2 When the sever is dead

Obviously, fixing hardware defects is not possible through using a remote management device. Nevertheless PS/2 IP-KVM switch gives the administrator valuable information about the type of a hardware failure. Serious hardware failures can be categorized into five different categories with different chances to happen:

- I. Hard disk failure 50%
- II. Power cable detached, power supply failure 28%
- III. CPU, Controller, main board failure 10%
- IV. CPU fan failure 8%
- V. RAM failure 4%

Using PS/2 IP-KVM switch, administrators can determine which kind of serious hardware failure has occurred (See table 2.1).

Type of failure	Detected by
Hard disk failure	Console screen, CMOS set-up information
Power cable detached, power supply failure	Server remains in power off state after power on command has been given.
CPU Controller, main board failure.	Power supply is on, but there is no video output.
CPU fan failure	By server specific management software
RAM failure	Boot-Sequence on boot console

Table 2.1: Host system failures and how they are detected.

2.3 Features

- 8/16 port KVM over IP switch is 19" rack mount size design.
- Support DOS, Win3.X, Win95/98/98SE/2000/ME/XP, WinNT, Netware, Unix, Linux
- Support iMAC, Power MAC and Sun Microsystems with USB port (Need work with USB-PS/2 adapter)
- Hot Plug - Add PCs or Remove Connected PCs for Maintenance without Powering Down the KVM switch or PCs.
- High Video Quality – Resolution Up To 1920X1440 (local side), 1280 X1024 (remote side)
- No Software Required - easy PC selection via On Screen Display Menu (OSD), Push Buttons, Hot Keys
- At local console side - Support eight characters password protection and search PC server name
- At Remote console side – Use SSL protocol for any encrypted network traffic between itself and a connected client.
- Keyboard status restored when switching PCs
- LED Display for easy status monitoring
- Buzzer sound for switching port confirmation.
- Built-in one extra daisy chain port and no waste any PC port
- No DIP switch setting needed and auto detect daisy chain bank
- Manage serves around the world
- KVM (keyboard, video, mouse) access over IP and analogous telephone line.
- BIOS level access
- No impact on server or network performance
- Automatically senses video resolution for best possible screen capture
- High-performance mouse tracking and synchronization

2.4 Package contents

Model No.: 8 port PS/2 IP-KVM switch

Base unit- 8 port PS/2 IP-KVM switch	1 PCS
User's manual	1 PCS
Installation software and User Manual on CD-ROM	1 PCS
AC to DC Power Adapter	1 PCS
Rack Mount Kit	1 SET
Daisy Chain Cable	1 PCS
3-in-one cables (One HDDDB 15-pin male to one HDDDB 15-pin and two Mini Din 6-pin PS/2 cables)	Optional
Null modem cable	1 PCS

Model No.: 16 port PS/2 IP-KVM switch

Base unit- 16 port PS/2 IP-KVM switch	1 PCS
User's manual	1 PCS
Installation software and User Manual on CD-ROM	1 PCS
AC to DC Power Adapter	1 PCS
Rack Mount Kit	1 SET
Daisy Chain Cable	1 PCS
3-in-one cables (One HDDDB 15-pin male to one HDDDB 15-pin and two Mini Din 6-pin PS/2 cables)	Optional
Null modem cable	1 PCS

2.5 Technical specifications

Model No.	8 port PS/2 IP-KVM switch	16 port PS/2 IP-KVM switch
PC Port	8	16
Console Port	1	
PC Port Connector (All Female Types)	VGA HDDDB 15-pin(shared with PS/2 keyboard and Mouse)	
Console Port Connector (All Female Types)	Local Console: PS/2 Keyboard Mini Din 6 pin PS/2 Mouse Mini Din 6 pin VGA HDDDB 15pin Remote Console: RJ-45 8P8C	
Daisy Chain Port Connector (All Female Types)	PS/2 Keyboard mini Din 6 pin PS/2 Mouse Mini Din 6 pin VGA HDDDB 15pin	
Serial Port (DB9 pin Male)	1	
LAN port (RJ-45 8P8C)	1 10BASE-T Ethernet uses Category 3/4/5/5E/6 UTP 100BASE-T Ethernet uses Category 5/5E/6 UTP	
Reset button	1	
PC selection	On Screen Display Menu, Hot Key, Push Button	
PC Port LED	8	16
Bank 7 segment LED	1	
On Screen Display Control	Yes	
Scan Intervals	5~99 Sec.	
Keyboard Emulation	PS/2	
Mouse Emulation	PS/2	
VGA Resolution	Local Console: 1920X1440 Remote Console: 1280 X1024	
Daisy Chain MAX Level	8 levels	
MAX PC Connection	120	128
Housing	Metal	
Power Adapter	DC 5V, 2.5A	
Operation Temperature	0~50	
Storage Temperature	-20 ~ 60	
Humidity	0~80%, Non-Condensing	
Size	19" Rack Mount / 1RU	19" Rack Mount / 1RU
Weight (kg)	2.0kg	2.2kg
Dimension (cm)	41(L) X 16.4(W) X 4.6(H)	41(L) X 16.4(W) X 4.5(H)

2.6 System requirement

Model No.	8 ports PS/2 IP-KVM switch
Local console side	One VGA Monitor One Keyboard One Mouse
Network Side	10/100Mbps Ethernet or Modem
Remote Console side	One computer
Computer side	8 PCs with 8 3-in-one cables (One HDDB 15-pin male to one HDDB 15-pin and two Mini Din 6-pin PS/2 cables)

Model No.	16 ports PS/2 IP-KVM switch
Console side	One VGA Monitor One Keyboard One Mouse
Network Side	10/100Mbps Ethernet or Modem
Remote Console side	One computer
Computer side	16 PCs with 16 3-in-one cables (One HDDB 15-pin male to one HDDB 15-pin and two Mini Din 6-pin PS/2 cables)

2.7 Cable diagrams

PS/2 Cable:

Mini Din 6 pin Male to Male



VGA Cable:

HDB15 pin Male to Male



AT to PS/2 keyboard adapter: (Optional)

Din 5 pin Male to Mini Din 6 pin Female



PS/2 to DB9 adapter (Optional)

Mini Din 6 pin Female to DB 9 pin Female



CAT5/5E/6 Straight Through UTP/STP Cable:

8P8C



2.8 Product Details

8 port Rack Mount PS/2 IP-KVM switch:



16 port Rack Mount PS/2 IP-KVM switch:



3. Hardware installation

3.1 Operation Overview

Figure 3.1 shows the connections of PS/2 IP-KVM switch to its host, to peripheral devices, to the power source and to the local area network.

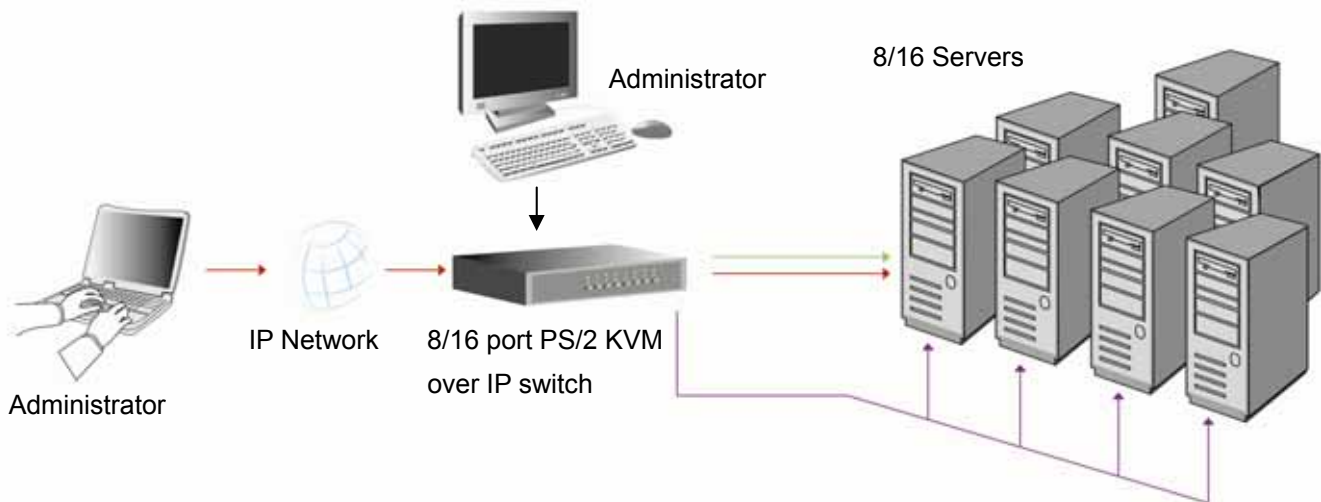

Figure 3.1: PS/2 IP-KVM switch usage scenario

PS/2 IP-KVM switch redirects local keyboard, mouse, and video data to a remote administration console. All data is transmitted via IP.

PS/2 IP-KVM switch can be used in a multi administrator and multi server environment as well.

3.2 Connecting PS/2 IP-KVM switch to the host system

Before installation, please make sure all of peripherals and computers have been turned off. This example of installation is based on 8 port Rack Mount PS/2 IP-KVM switch and you also can think that 16 port Rack Mount PS/2 IP-KVM switch and 32 port Rack Mount PS/2 IP-KVM switch have the same installation procedure. In order to connect the PS/2 IP-KVM switch to the host system, please perform the following steps:

Step 1

Attach the power supply to the KVM unit and plug the other end into an electrical receptacle.



Step 2

Find a convenient place to put your PS/2 IP-KVM switch. Its 19" rack mount form factor makes it ideal mountable on 19" rack. When mounting to a rack, attach the included brackets to the sides of the PS/2 IP-KVM switch. Take note of the length of your cables so that your computers, KVM Switch, keyboard, mouse and monitor are distanced properly.

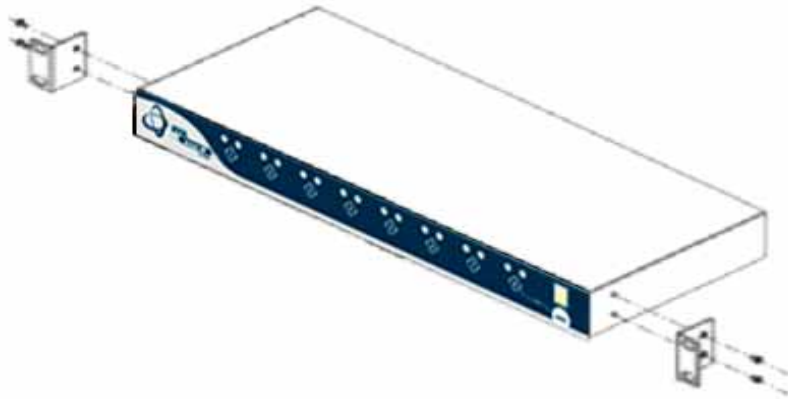

Step 3 (Local console)

Connect the monitor to the KVM Switch. Using the attached cable, or the one included with your monitor, connect it to the HDDB15-pin female port on the back of the KVM unit labeled with the monitor symbol at the CONSOLE connector.



Step 4

Connect the keyboard to the KVM Switch. If you have an AT type keyboard, you will need an AT to PS/2 adapter.



Step 5

Connect the mouse to the KVM Switch.



Step 6

Each PC port connector is HDDB15-pin type. Locate your input cable. It will have an HDDB15-pin male connector at one end. Plug it into any label computer port on the rear of KVM switch unit. The other end of input cable will have three connectors: a HDDB15-pin male type for PC video, a Mini Din 6 pin female type for keyboard and a Mini Din 6 pin female type for mouse. To plug these three connectors into the respective ports of computer. Repeat the same procedure to all of PCs.



Step 7

Double-check all of the connections. You can check the color of keyboard and mouse connector to make sure the keyboard and mouse cables go to the correct ports.

Step 8

Repeat step 5 to 7 for the remainder of the computers.

Step 9

Connect the Ethernet and/or modem, ISDN, depending on how you want to access PS/2 IP-KVM switch.

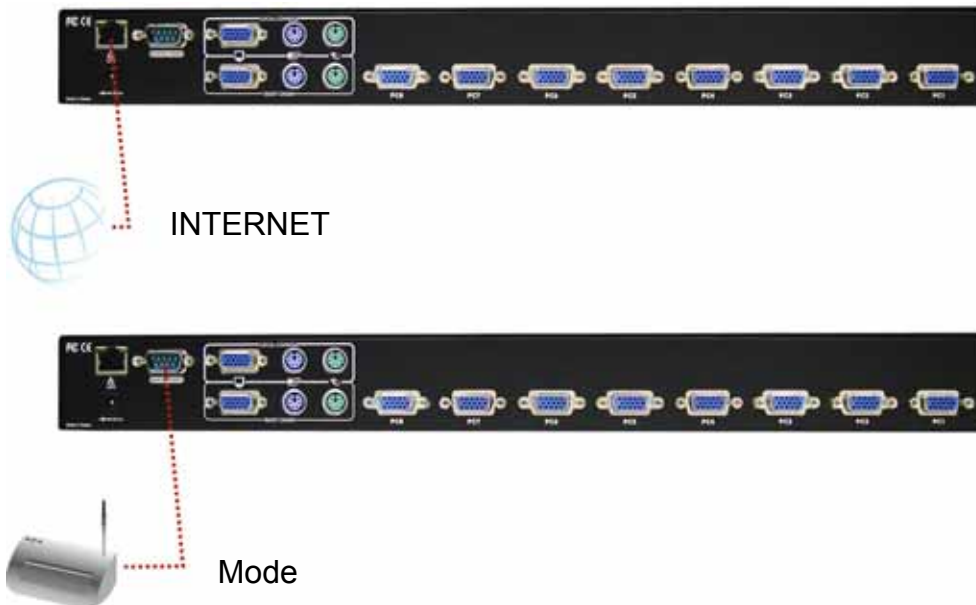

The rear side of PS/2 IP-KVM switch provides a RJ-45 connector for Ethernet. The connector is used either for a 100 Mbps 100BASE-TX connection or for a 10 Mbps 10BASE-T connection. The adapter can sense the connection speed and will adjust to the appropriate operation mode automatically.

10 Mbps Connection

For 10BASE-T Ethernet networks, the Fast Ethernet adapter uses Category 3, 4, or 5 UTP cable. To establish a 10 Mbps connection, the cable must be connected to a 10BASE-T hub.

- Make sure that the cable is wired appropriately for a standard 10BASE-T adapter.
- Align the RJ-45 plug with the notch on the adapter's connector and insert it into the adapter's connector.

100 Mbps Connection

For 100BASE-TX Fast Ethernet networks, PS/2 IP-KVM switch supports Category 5 UTP cabling. To establish a 100 Mbps connection, the cable must be connected to a 100BASE-TX hub.

- Make sure that the cable is wired appropriately for a standard 100BASE-TX adapter.
- Align the RJ-45 plug with the notch on the adapter's connector and insert it into the adapter's connector.

3.2.1 Connecting the External Reset/Power Option

Please refer to the manual of the PS/2 IP-KVM switch 8/16/32 port external power switch option or a third party external power option to connect those external devices to one of the serial interface on the rear side of PS/2 IP-KVM switch. By the date of printing this manual supported options are:

- . Avocent.SPC1 800/1600
- . Sentry In-Line Power Module
- . Leaning ePowerSwitch
- . Peppercon IPM-220L

4. Configuration

4.1 Initial Configuration

The PS/2 IP-KVM switch's communication interfaces are all based on TCP/IP. It comes pre-configured with the IP configuration listed in Table 4-1.

Parameter	Value
IP auto configuration	DHCP
IP-Address	-
Net-mask	255.255.255.0
Default-Gateway	none

Table 4-1. Initial network configuration

Warning

If the DHCP connection fails on boot up, the PS/2 IP-KVM switch will not have an IP address.

If this initial configuration does not meet your requirements, the following describes the initial IP configuration that is necessary to access the PS/2 IP-KVM switch for the first time.

4.1.1 Initial configuration via DHCP server

By default, the PS/2 IP-KVM switch will try to contact a DHCP server in the subnet to which it is physically connected. If a DHCP server is found, it may provide a valid IP address, gateway address and net mask. Before you connect the device to your local subnet, be sure to complete the corresponding configuration of your DHCP server. It is recommended to configure a fixed IP assignment to the MAC address of the PS/2 IP-KVM switch. You can find the MAC address labeled on the bottom side.

If this initial configuration does not meet your local requirements, use the setup tool to adjust the values to your needs. The setup tool can be found on the CD ROM delivered with this package. You can follow the procedure described below.

PS/2 IP-KVM switch Setup Tool

MAC Address Detection

Connect the IP-KVM switch to your computer either via local network, or via USB. Start the setup tool from the CD ROM on the computer that the IP-KVM switch is installed. Depending on the connection (USB or network), the device detection is different. A window opens as seen below:

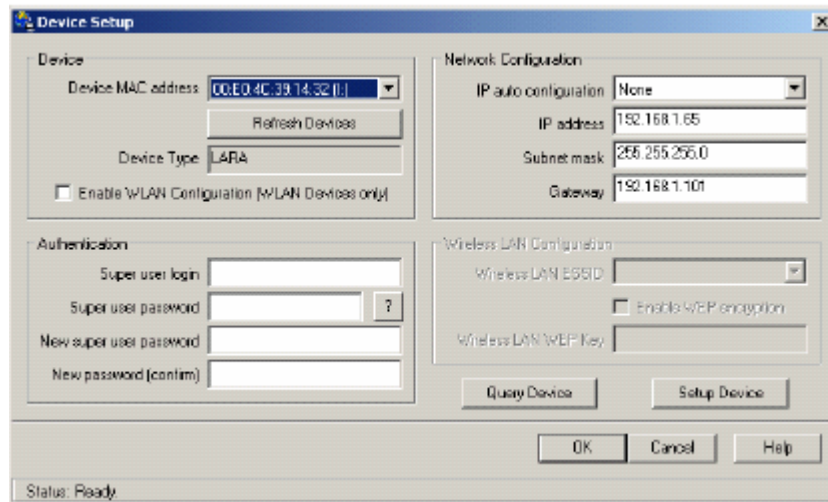

Figure4-1. IP-KVM switch setup tool

On the upper left corner, the MAC address of the IP-KVM switch is displayed. To detect the MAC address, manually, press the button “Refresh Devices”. The displayed MAC address is the same MAC address printed on the white sticker placed on the back of the IP-KVM switch. If the IP-KVM switch is connected via USB, it is classified as an USB device and an appropriate drive letter is chosen for this device.

On the lower right corner of the window, there are two buttons: “Query Device” and “Setup Device”. Press the “Query Device” button to display the preconfigured values of the network configuration. The values are displayed in the text fields located above. If necessary, adjust the network settings to your needs. To save the changes enter an user name and an according password. Then press the “ Setup Device “ button.

Authentication

To adjust the authentication settings, enter your login as a super user, and change your password.

Super user login

Enter the login name of the super user. The initial value is “ super ”. All of characters are lower case.

Super user password

Enter the current password for the super user. This initial value is “ pass “. All of characters are lower case.

New super user password

Enter the new password for the super user.

New password (confirm)

Re-type the new password for the super user.

To close the window and accept the changes, press the “ OK ” button, otherwise press the “ Cancel ” button.

4.1.2 Initial configuration via serial console

Using a serial terminal, the PS/2 IP-KVM switch has a serial line interface (rear side). This connector is compliant with the RS 232 serial line standard. The serial line has to be configured with the parameters given in Table 4-2.

When configuring with a serial terminal, reset the PS/2 IP-KVM switch and immediately press the “ESC” key. You will see some device information, and a “=>” prompt. Enter “config”, press “Enter” and wait for a few seconds for the configuration questions to appear.

Parameter	Value
Bits/second	115200
Data bits	8
Parity	No
Stop bits	1
Flow Control	None

Table 4-2. Serial line parameters

As you proceed, the following questions will appear on the screen. To accept the default values which are shown in square brackets below, press “Enter”.

IP auto configuration (non/dhcp/bootp) [dhcp]:

IP [192.168.1.22]:

Net mask [255.255.255.0]:

Gateway (0.0.0.0 for none) [0.0.0.0]:

IP autoconfiguration

With this option, you can specify whether the PS/2 IP-KVM switch should get its network settings from a DHCP or BOOTP server. For DHCP, enter “dhcp”, and for BOOTP enter “bootp”. If you do not specify any of these, the IP autoconfiguration is disabled and subsequently you will be asked for the following network settings.

IP address

The IP address the PS/2 IP-KVM switch uses. This option is only available if IP autoconfiguration is disabled.

Net mask

The net mask of the connected IP subnet. This option is only available if IP autoconfiguration is disabled.

Gateway address

The IP address of the default router for the connected IP subnet. If you do not have a default router, enter 0.0.0.0. This option is only available if IP autoconfiguration is disabled.

4.1.3 Keyboard, Mouse and Video configuration

Between the PS/2 IP-KVM switch and the host, there are two interfaces available for transmitting keyboard and mouse data: USB and PS/2. The correct operation of the remote mouse depends on several settings, which will be discussed in the following subsections.

4.1.3.1 PS/2 IP-KVM switch keyboard settings

The PS/2 IP-KVM switch settings for the host's keyboard type have to be correct in order to make the remote keyboard work properly. Check the settings in the PS/2 IP-KVM switch front-end. See [6.3.3](#) for details.

4.1.3.2 Remote Mouse Settings

A common problem with KVM devices is the synchronization between the local and remote mouse cursors. The PS/2 IP-KVM switch addresses this situation with an intelligent synchronization algorithm. There are two mouse modes available on the PS/2 IP-KVM switch.

Auto mouse speed

The automatic mouse speed mode tries to detect the speed and acceleration settings of the host system automatically. See the section below for a more detailed explanation.

Fixed mouse speed

This mode just translates the mouse movements from the Remote Console in a way that one pixel move will lead to n pixel moves on the remote system. This parameter n is adjustable with the scaling. It should be noted that this works only when mouse acceleration is turned off on the remote system.

4.1.3.3 Auto mouse speed and mouse synchronization

The automatic mouse speed mode performs the speed detection during mouse synchronization. Whenever the mouse does not move correctly, there are two ways for re-synchronizing local and remote mouse:

Fast Sync

The fast synchronization is used to correct a temporary, but fixed skew. Choose the option using the Remote Console options menu or press the mouse synchronization hotkey sequence in case you defined one.

Intelligent Sync

If the fast sync does not work or the mouse settings have been changed on the host system, use the intelligent resynchronization. This method takes more time than the fast one and can be accessed with the appropriate item in the Remote Console option menu. The intelligent synchronization requires a correctly adjusted picture. Use the auto adjustment function or the manual correction in the Video Settings panel to setup the picture. The Sync mouse button on top of the Remote Console can behave differently, depending on the current state of mouse synchronization. Usually pressing this button leads to a fast sync, except in situations where the KVM port or the video mode changed recently.

Note: At first start, if the local mouse pointer is not synchronized with the remote mouse pointer, press the Auto Adjust Button once.

4.1.3.4 Host system mouse settings

The host's operating system knows various settings from the mouse driver.

Warning

The following limitations do not apply in case of USB and Mouse Type "MS Windows 2000 and newer".

While the IP-KVM switch works with accelerated mice and is able to synchronize the local with the remote mouse pointer, there are the following limitations, which may prevent this synchronization from working properly:

Special Mouse Driver

There are mouse drivers which influence the synchronization process and lead to desynchronized mouse pointers. If this happens, make sure you do not use a special vendor-specific mouse driver on your host system.

Windows XP Mouse Settings

Windows XP knows a setting named "improve mouse acceleration", which has to be deactivated.

Active Desktop

If the Active Desktop feature of Microsoft Windows is enabled do not use a plain background. Instead, use some kind of wallpaper. As an alternative, you could also disable the Active Desktop completely.

Navigate your mouse pointer into the upper left corner of the applet screen and move it slightly forth and back. Thus the mouse will be resynchronized. If re-synchronizing fails, disable the mouse acceleration and repeat the procedure.

4.1.3.5 Single and Double Mouse Mode

The information above applies to the Double Mouse Mode, where remote and local mouse pointers are visible and need to be synchronized. The PS/2 IP-KVM switch also features another mode, the Single Mouse Mode, where only the remote mouse pointer is visible. Activate this mode in the open Remote Console and click into the window area. The local mouse pointer will be hidden and the remote one can be controlled directly. To leave this mode, it is necessary to define a mouse hotkey in the Remote Console Settings Panel. Press this key to free the captured local mouse pointer.

4.1.3.6 Recommended Mouse Settings

For the different operating systems we can give the following advice:

MS Windows 2000/2003 (Professional and Server), XP

In general, we recommend the usage of a mouse via USB. Choose USB without Mouse Sync. For a PS/2 mouse choose Auto Mouse Speed. For XP disable the option enhance pointer precision in the Control Panel.

SUN Solaris

Adjust the mouse settings either via `xset m 1` or use the CDE Control Panel to set the mouse to 1:1, no acceleration. As an alternative you may also use the Single Mouse Mode.

MAC OS X

We recommend using the Single Mouse Mode.

4.1.3.7 Video Modes

The PS/2 IP-KVM switch recognizes a limited number of common video modes. When running X11 on the host system, please do not use any custom mode lines with special video modes. If you do, the PS/2 IP-KVM switch may not be able to detect them. We recommend using any of the standard VESA video modes, instead

5. Usage

5.1 Prerequisites

The PS/2 IP-KVM switch features an embedded operating system and applications offering a variety of standardized interfaces. This chapter will describe both these interfaces, and the way to use them in a more detailed manner. The interfaces are accessed using the TCP/IP protocol family, thus they can be accessed using the built-in Ethernet adapter.

The following interfaces are supported:

HTTP/HTTPS

Full access is provided by the embedded web server. The PS/2 IP-KVM switch environment can be entirely managed using a standard web browser. You can access the PS/2 IP-KVM switch using the insecure HTTP protocol, or using the encrypted HTTPS protocol. Whenever possible, use HTTPS.

Telnet

A standard Telnet client can be used to access an arbitrary device connected to the PS/2 IP-KVM switch's serial port via a terminal mode.

The primary interface of the PS/2 IP-KVM switch is the HTTP interface. This is covered extensively in this chapter. Other interfaces are addressed in subtopics.

In order to use the Remote Console window of your managed host system, the browser has to come with a Java Runtime Environment version 1.1 or higher. If the browser has no Java support (such as on a small handheld device), you are still able to maintain your remote host system using the administration forms displayed by the browser itself.

Important: We recommend installing a Sun JVM 1.4.

For an insecure connection to the PS/2 IP-KVM switch, we can recommend the following browsers :

- Microsoft Internet Explorer version 5.0 or higher on Windows 98, Windows ME, Windows 2000 and Windows XP
- Netscape Navigator 7.0 or Mozilla 1.6 on Windows 98, Windows ME, Windows 2000, Windows XP, Linux and other UNIX-like Operating Systems

In order to access the remote host system using a securely encrypted connection, you need a browser that supports the HTTPS protocol. Strong security is only assured by using a key length of 128 Bit. Some of the old browsers do not have a strong 128 Bit encryption algorithm.

Using the Internet Explorer, open the menu entry “?” and “Info” to read about the key length that is currently activated. The dialog box contains a link that leads you to information on how to upgrade your browser to a state of the art encryption scheme. Figure 5-1 shows the dialog box presented by the Internet Explorer 6.0.



Figure 5-1. The Internet Explorer displaying the encryption key length

Newer web browsers do support strong encryption on default.

5.2 Using PS/2 KVM over IP switch as a KVM switch

The power on state of 8/16 port PS/2 KVM over IP switch:

When you power on KVM switch, it will ask you the password, **the default password value is eight zero –“ 00000000 “**. Please key in eight zero and enter the same value at retype field.

Note: Before you are not familiar with the operation of OSD manual, please don't change the password – i.e. keep default eight zero (00000000) value. Otherwise, if you have set the password and unfortunately forget the password, you need send it back to your distributor for maintaining the password.

➤ The Membrane Buttons

8 port PS/2 IP-KVM Switch

The Push Buttons :

Pressing the individual button to get PC port you want.

16 port PS/2 IP-KVM Switch

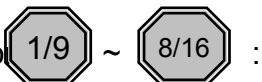
The Push Button :

Pressing the individual button to get PC port you want. To press both “Shift “ button and port 1(or port 2,3,4,5,6,7,8) individual button simultaneous to get PC port 9 (10,11,12,13,14,15,16) respectively.

For example: The user would like to switch console port to PC port 12. He can press “Shift“ button and port 4 button simultaneously. The port LED of PC port 12 is lit when the console is switched to PC port 12.

PC port LED Indication :

There are two LEDs--- Power LED (**The LED is marked by “ P “**) and Link LED (**The LED is marked by “ O “**) accompanied with each PC port.

When you select one of sixteen PC ports and this PC is shut down or this PC port is disconnected to the PC, the selected power port LED is off (But, if this PC is PC99 type, the selected power port LED is lit) and the Link LED is flash. When you select one of sixteen PCs ports and this PC is powered on, the selected port Link LED and power LED is lit.

Note: If there are one of rack mount of KVM switches you used is 16 port IP-KVM switch,

please put 16 port IP-KVM switch on the 1st bank (or say Master bank). It is based on 16 port IP-KVM switch supports 16 port LEDs display on the front panel. Otherwise, 8 port IP-KVM switch is allocated at 1st bank and there is a 16 port IP-KVM switch chained to the slave bank, the master bank (or say 1st bank) is unable to show the PC port LEDs (from port 9 to 16) of 16 port IP-KVM switch completely.

➤ 7-Segment BANK LED Indication

When you would like to view the next bank KVM switch, please press “ BANK “ push button cyclically to the destination bank. The bank LED will be changed from bank 1 to the maximum daisy chain level and then to press “ BANK “ push button once back to the bank 1.

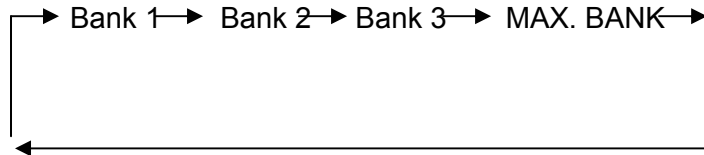

➤ Reset Button ((“ Bank ” button) and (PC 8/16 ” button)):

To press both “Bank” button and “any one of the PC1~PC8” button of master bank simultaneously can reset KVM switch. This reset action will not only return KVM switch back to initial state --- Check the password, but also re-check all of slave banks which connected to mast KVM Switch.

If you add a new KVM Switch as a slave bank, please use reset button of master KVM Switch to automatically assign a new ID to it. You can view this new slave bank go through OSD menu. The PC ports of KVM Switch do not be reset by reset command.

Keyboard Hot Key Commands:

You can also conveniently command KVM switch by switching ports through simple key sequences. To send commands to KVM switch, **the “SCROLL LOCK” key must be pressed twice within 2 seconds**. You will hear a beep for confirmation and the keyboard is in hot key mode. If you have not pressed any key in hot key mode within 2 seconds (It means to key in any key follows up “Scroll Lock” “Scroll Lock” key), the keyboard will back to under Operation System (O.S.) control state.

Below are the different hot key commands (for local KVM):

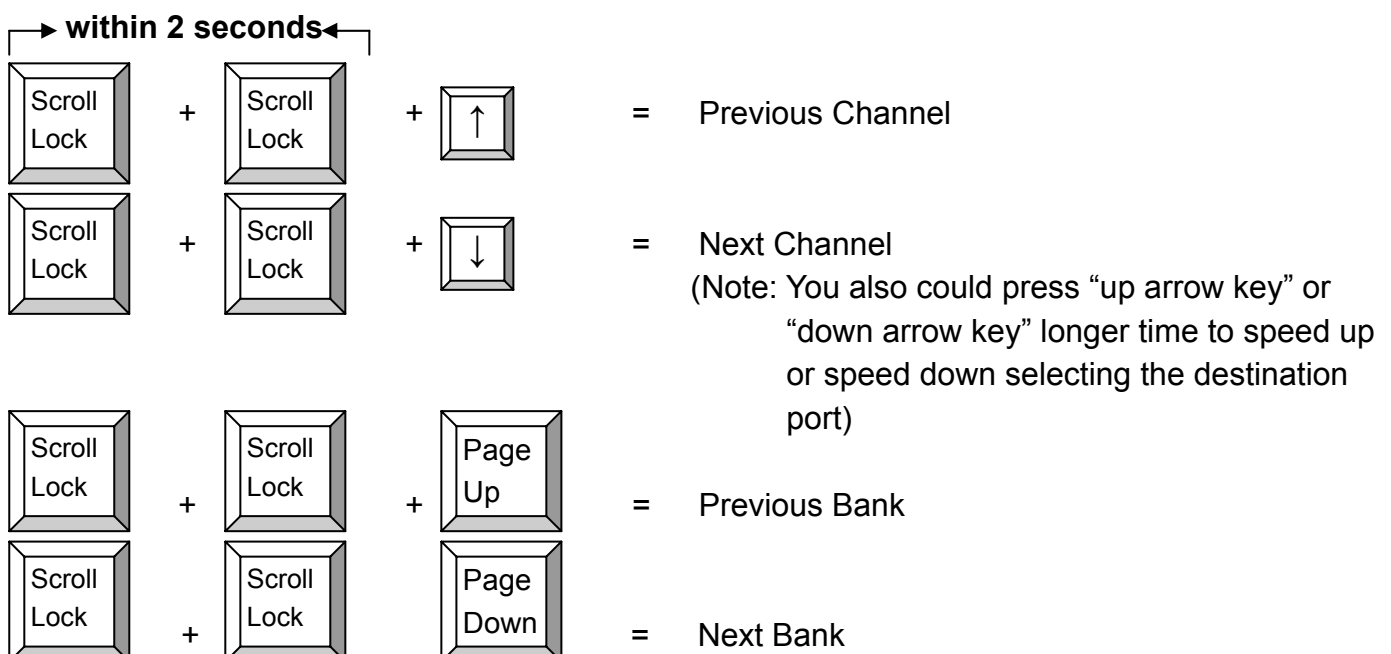

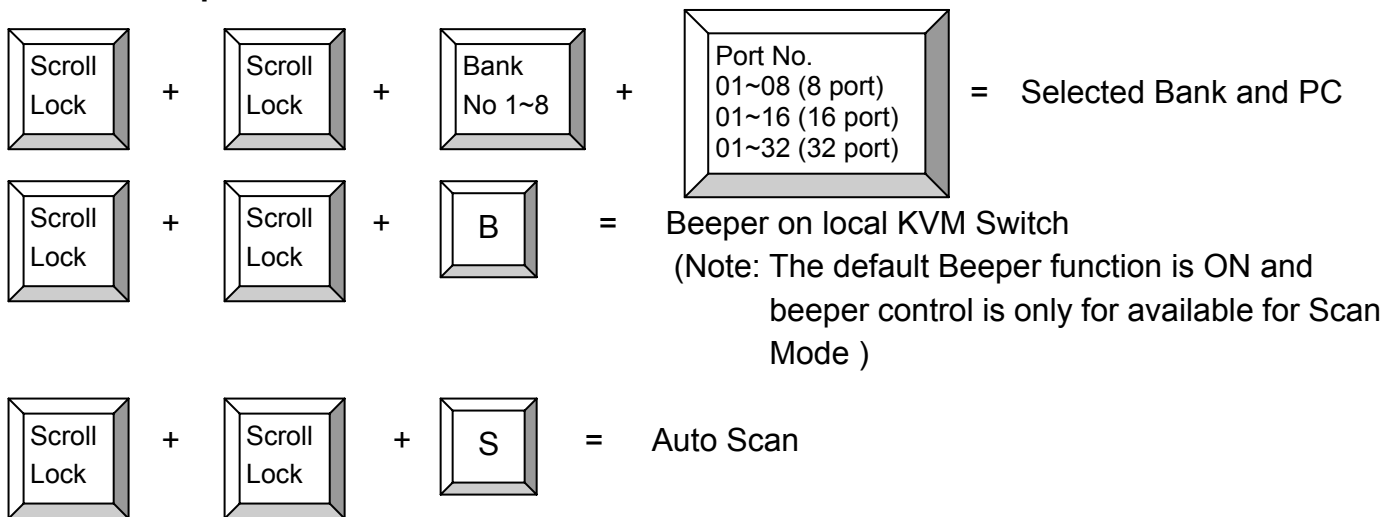
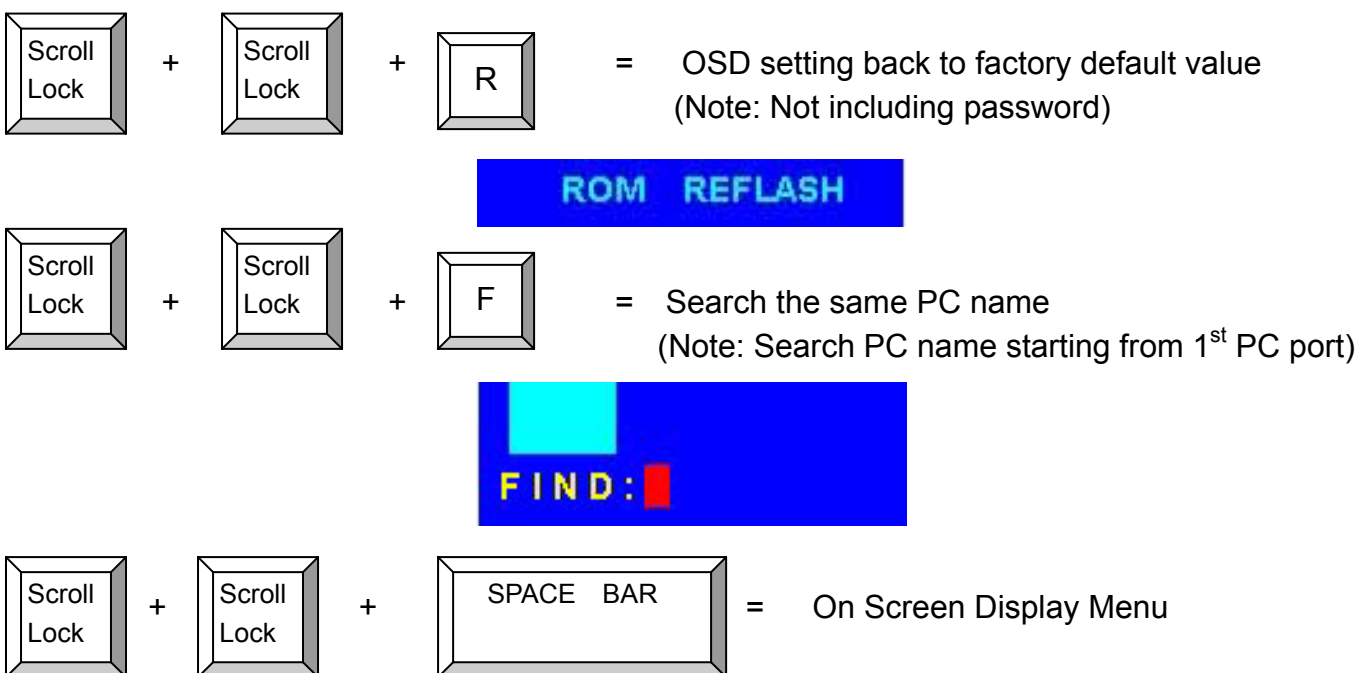
To select PC port:**To get out of Auto Scan Mode, Press any key or SPACE bar.****5.2.1 Daisy Chain Connection Diagram**

Please use the attached 3 feet 3-in-one daisy chain Cable (90 feet) Kit to daisy chain the KVM Switch.

- A. Connect Keyboard, Mouse and Monitor to the console port (Local console block) of bank 1 KVM switch.
- B. Use one end of 3-in-one Cable Kit to connect the daisy chain port of bank 1 and the other end for the console port (Daisy-chain block) of bank 2 KVM switch.
- C. Please repeat item B to daisy chain more bank as you want. But, the maximum daisy chain bank is eight levels.

- D. Before chaining the slave bank up to six banks, you need a VGA extender between the fifth bank and the sixth bank to enhance the VGA signal.

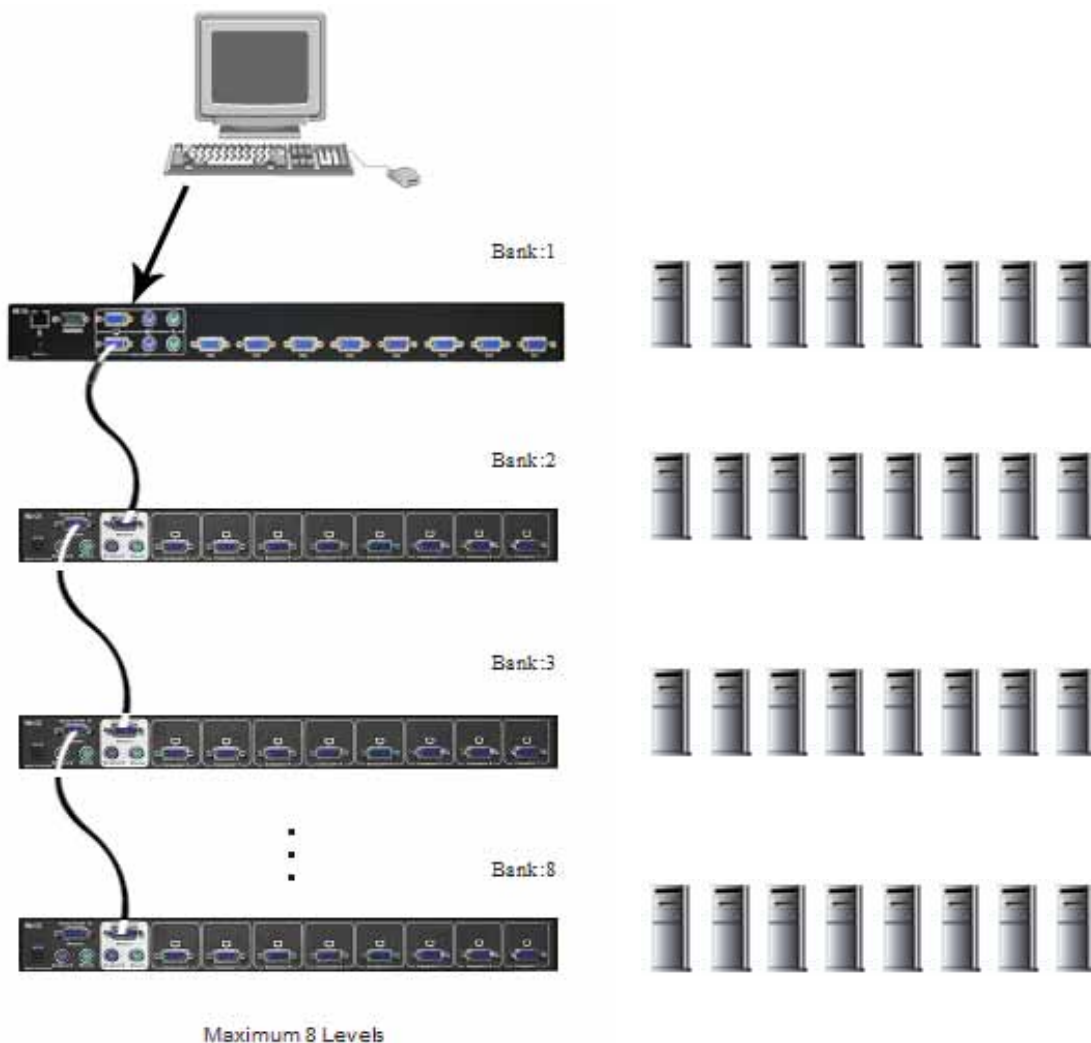

Figure 5-2: Daisy Chain Connection

5.2.2 Hot Plug

The KVM Switch supports “Hot Plug” function for easy addition or removal of PCs. The user can arrange or maintain PCs as follows:

- A PC can be disconnected and reconnected to the same or different port of the KVM unit without having to power it off as long as it is not the Daisy-chain port or pass through port.
- The pass through port PC (i.e. The pass through port means the console port is connected to PC directly) is powered on. Before you go hot plug function, please switch to this pass through port to next port (or say emulation port) and then switch back to the pass through port.
- You may unplug the mouse or the keyboard from the console port and plug it back in at any time.

NOTE:

Some O.S. (Operation Systems) like SCO Unix are unable to support “Hot Plug” function. If you apply “Hot Plug” to this kind of O.S., it will cause unpredictable behavior or shut down the PC. Before attempting to use “Hot Plug”, please make sure your O.S. and

mouse software driver supports the “Hot Plug” function.

5.2.3 On Screen Display Operation

- OSD menu can be popped up in powered on PC port or non-powered on PC port or empty PC port. The resolution of OSD menu is fixed to 1024X768 for non-powered on PC port or empty PC port.
- When you pop up the OSD menu window go through the hot key (Scroll Lock + Scroll Lock + space), you will see the following small window on your monitor.

- The 1ST line bar is Bank no.
- The 2nd block is your PC system name list. You will find the system number list from 01 to 04 (if the current box is 4 port) or from 01 to 8 (if the current box no. is 8 port) or from 01 to 16 (if the current box no. is 16 port). You can define your PC name in maximum 10 characters. The factory default of 16 port KVM switch PC name is from “SYSTEM 01”, “SYSTEM 02” ,..., “SYSTEM 16” and 8 port KVM switch is from “SYSTEM 01”, “SYSTEM 02”,..., “SYSTEM 08”. Besides, the sun symbol “☀” near to the PC name represents the PC system is powered on.

To use up arrow key “↑” or down arrow key “↓” to select port for destination PC name. After you have selected the PC port already, you can press the ENTER Key to switch the PC port you want immediately

To use “PgUp” key or “PgDn” key for selecting previous or next Bank no. (or Box No.)

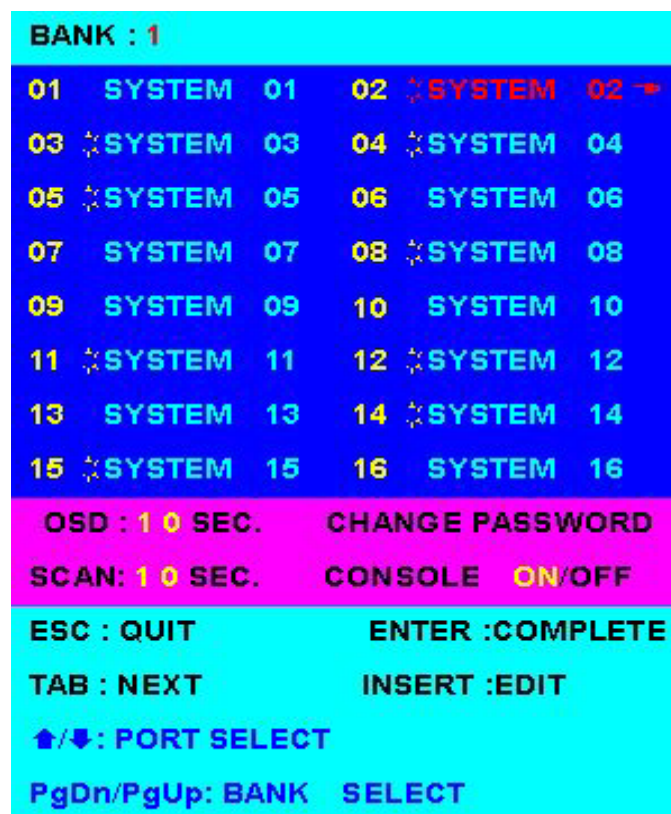

To press “INS” key for editing PC name. After finishing the edit, please press “Enter” key for saving information.

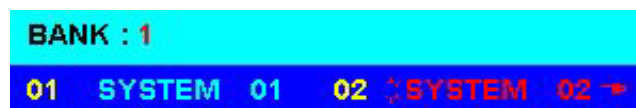

To use “Tab” key to select items like Bank, OSD, SCAN, CHANGE PASSWORD, CONSOLE ON/OFF, etc...

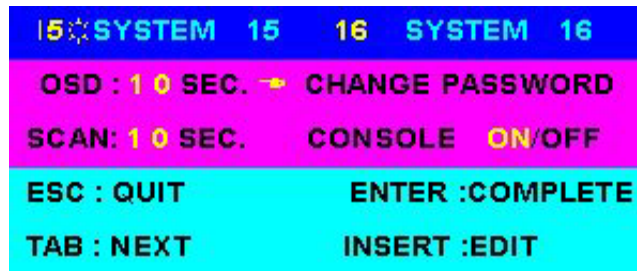

- The “OSD: 10 SEC” means that the OSD windows display or PC system name exists 10 sec. on your monitor. You can modify it from 05 sec to 99 sec. The factory default value is 10 sec.
- The “SCAN TIME” means that scan interval from one PC port to next PC port. The default SCAN time is 10 sec and the maximum scan time is 99 sec.
- The “CHANGE PASSWORD” is for user to avoid all PC systems to be intruded by the other person. The default password is 8 digits “00000000”.

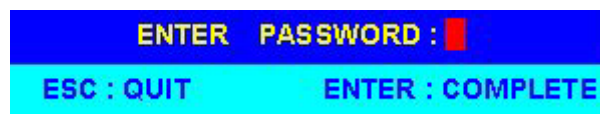

There is an enter password window showed out when you select this item and then press the Enter. The maximum password is 8 digits. After you key in the password already and press the Enter key, there is another window for confirming your typed password.



You need to retype the password again for rechecking your previous key-in password is matched or not.



- The “ CONSOLE ON/OFF “ means to manage the console of KVM switch. If you select “ CONSOLE ON “, it means that any user can use the console. If you select “ CONSOLE OFF “(factory default OFF state), it means that any user will not be allowed to use the console unless you enter the password. When you enter the password already and pass the KVM switch authentication, the CONSOLE will be set to ON. After you finish using KVM switch, please don’t forget to set up CONSOLE ON state to OFF state. Besides, if current CONSOLE is ON state and you reset KVM switch, the CONSOLE will be set up ON state back to OFF state.
- When you finish the set up of PC name and get out of OSD setting mode, you will find the PC name showed at the up-left corner of monitor. Now, you can use ESC key to clear the message right away if you don’t need it.

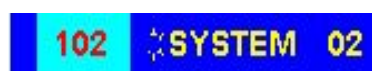

- If you want OSD returning back to factory default value, you can execute “SCROLL LOCK”, “SCROLL LOCK” , “R” keys in order. The bank seven segment LED on the front panel will

be flashed during the refresh process.

ROM REFLASH

When the OSD value back to default setting, the bank seven segment LED on the front panel will stop flashing

5.3 Login into the PS/2 IP-KVM switch and logout

5.3.1 Login into the PS/2 IP-KVM switch

Launch your web browser. Direct it to the address of your PS/2 IP-KVM switch, which you configured during the installation process. The address used might be a plain IP address or a host and domain name, in the case where you have given your PS/2 IP-KVM switch a symbolic name in the DNS. For instance, type the following in the address line of your browser when establishing an unsecured connection:

http://<IP address of PS/2 IP-KVM>

When using a secure connection, type in:

https://<IP address of PS/2 IP-KVM>

This will lead you to the PS/2 IP-KVM switch login page as shown in Figure 5-3.

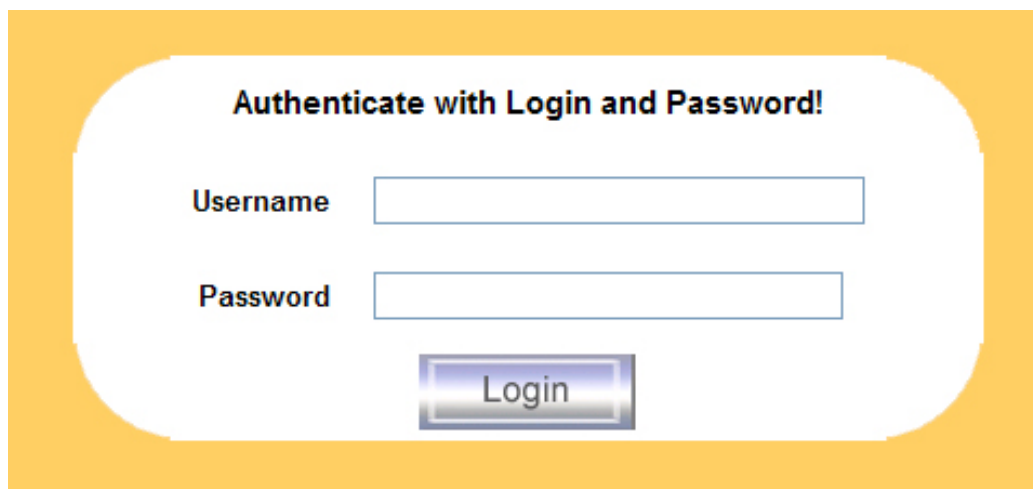

Figure 5-3. Login screen

The PS/2 IP-KVM switch has a built-in super user that has all permissions to administrate your PS/2 IP-KVM switch:

Login name	super (factory default)
Password	pass (factory default)

Table 5-1. Standard user settings

Warning

The user “super” is not allowed to login via the serial interface of the PS/2 IP-KVM switch.

Warning

Please make sure to change the super user password immediately after you have installed and accessed your PS/2 IP-KVM switch for the first time. Not changing the pass phrase for the super user is a severe security risk and might result in unauthorized access to the PS/2 IP-KVM switch and to the host system including all possible consequences!

Warning

Your web browser has to accept cookies, or else login is not possible.

Navigation

Having logged into the PS/2 IP-KVM switch successfully, the main page of the PS/2 IP-KVM switch appears (see Figure 5-4). This page consists of three parts; each of them contains specific information. The buttons on the upper side allow you to navigate within the front end (see Table 5-2 for details). The lower left frame contains a navigation bar and allows you to switch between the different sections of the PS/2 IP-KVM switch. Within the right frame, task-specific information is displayed that depends on the section you have chosen before.

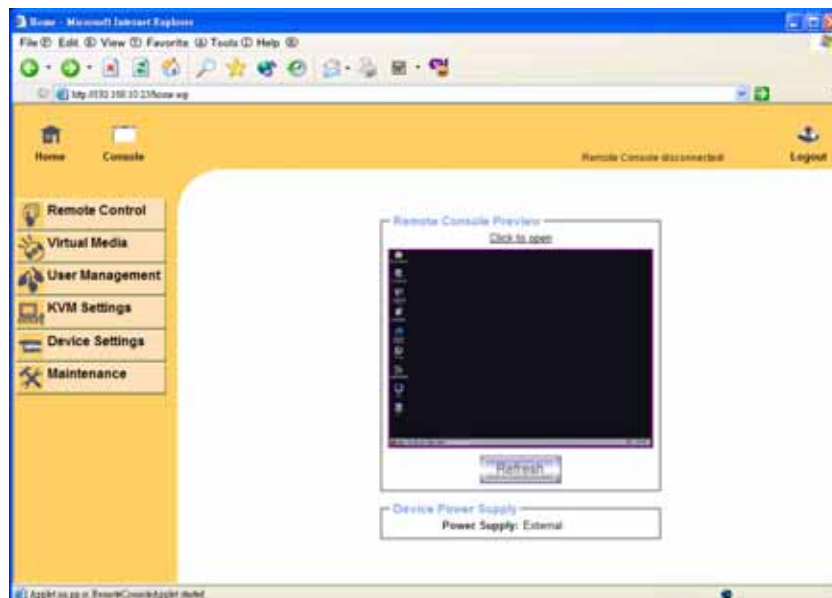
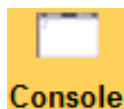

Figure 5-4. Main page



Return to the main page of the PS/2 IP-KVM switch .



Open the PS/2 IP-KVM switch remote console.



Exit from the PS/2 IP-KVM switch front end.

Table 5-2. Buttons from the front end

Warning

If there is no activity for half an hour, the PS/2 IP-KVM switch will log you out, automatically. A click on one of the links will bring you back to the login screen.

5.3.2 Logout from the PS/2 IP-KVM switch

This link logs out the current user and presents a new login screen. Please note that an automatic logout will be performed in case there is no activity for half an hour.

5.4 The Remote Console

General description

The Remote Console is the redirected screen, keyboard and mouse of the remote host system that PS/2 IP-KVM switch controls.

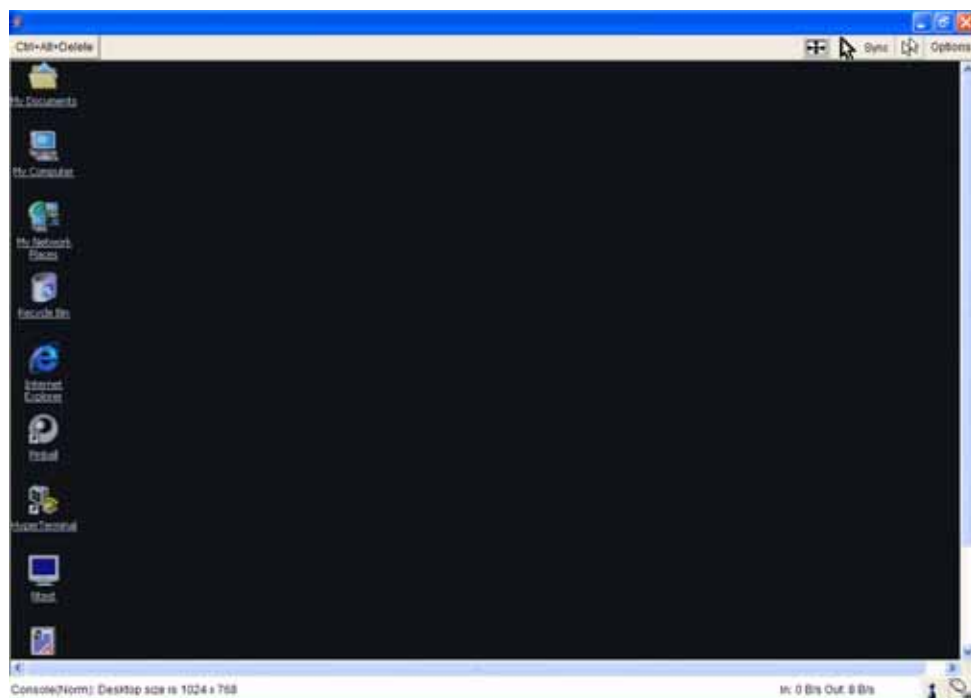

Figure 5-5. Remote Console

The Remote Console window is a Java Applet that tries to establish its own TCP connection to the PS/2 IP-KVM switch. The protocol that is run over this connection is neither HTTP or HTTPS, but RFB (Remote Frame Buffer Protocol). Currently, RFB tries to establish a connection to port number 443. Your local network environment has to allow this connection to be made, i.e. your firewall and, in case you have a private internal network, your NAT (Network Address Translation) settings have to be configured accordingly.

In case the PS/2 IP-KVM switch is connected to your local network environment and your connection to the Internet is available using a proxy server only without NAT being configured, the Remote Console is very unlikely to be able to establish the according connection. This is because today's web proxies are not capable of relaying the RFB protocol.

In case of problems, please consult your network administrator in order to provide an appropriate network environment.

5.5 Main Window

Starting the Remote Console opens an additional window. It displays the screen content of your host system. The Remote Console will behave exactly in the same way as if you were sitting directly in front of the screen of your remote system. That means keyboard and mouse can be used in the usual way. However, be aware of the fact that the remote system will react to keyboard and mouse actions with a slight delay. The delay depends on the bandwidth of the line, which you use to connect to the PS/2 IP-KVM switch.

With respect to the keyboard, the very exact remote representation might lead to some confusion as your local keyboard changes its keyboard layout according to the remote host system. If you use a German administration system, and your host system uses a US English keyboard layout, for instance, special keys on the German keyboard will not work as expected. Instead, the keys will result in their US English counterpart. You can circumvent such problems by adjusting the keyboard of your remote system to the same mapping as your local one.

The Remote Console window always tries to show the remote screen with its optimal size. That means it will adapt its size to the size of the remote screen initially and after the screen resolution of the remote screen has been changed. However, you can always resize the Remote Console window in your local window system as usual.

Warning

In difference to the remote host system, the Remote Console window on your local window system is just one window among others. In order to make keyboard and mouse work, your Remote Console window must have the local input focus.

5.5.1 Remote Console Control Bar

The upper part of the Remote Console window contains a control bar. Using its elements you can see the state of the Remote Console and influence the local Remote Console settings. A description for each control follows.



Figure 5-6. Remote Console Control Bar

Ctrl+Alt+Delete

Special button key to send the “Control Alt Delete” key combination to the remote system (see also Chapter 6 for defining new button keys).

Auto Adjust button



If the video display is of bad quality or distorted in some way, press this button and wait a few seconds while the PS/2 IP-KVM switch tries to adjust itself for the best possible video quality.



Activates the mouse synchronization process. Choose this option in order to synchronize the local with the remote mouse cursor. This is especially necessary when using accelerated mouse settings on the host system. In general, there is no need to change mouse settings on the host.

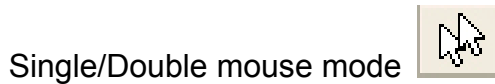

Switches between the Single Mouse Mode (where only the remote mouse pointer is visible) and the Double Mouse Mode (where remote and local mouse pointers are visible and need to be synchronized). Single mouse mode is only available if using SUN JVM 1.3 or higher.



To open the Options menu, click on the button “Options”.

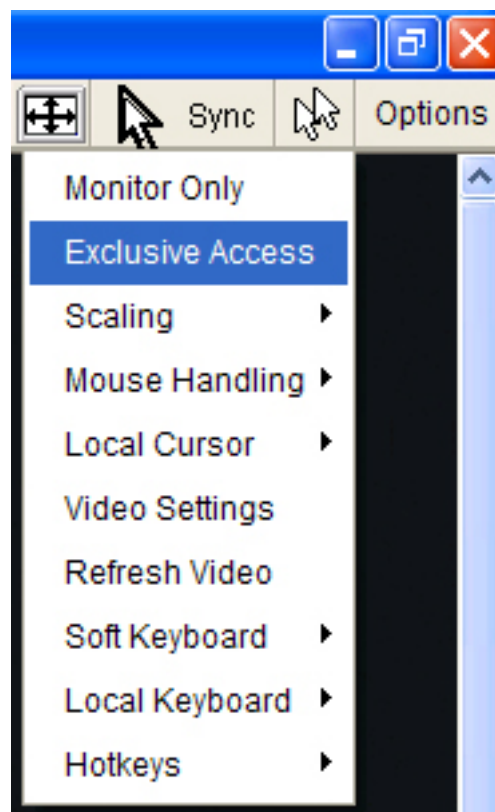

Figure 5-7. Remote Console Options Menu

A short description of the options follows.

- **Monitor Only**

Toggles the “Monitor Only” filter on or off. If the filter is switched on no remote console interaction is possible, and monitoring is possible.

- **Exclusive Access**

If a user has the appropriate permission, he can force the Remote Consoles of all other users to close. No one can open the Remote Console at the same time again until this user disables the exclusive access, or logs off.

A change in the access mode is also visible in the status line (see Figure 5-8).



Figure 5-8. Remote Console Exclusive Mode

- **Scaling**

Allow you to scale down the Remote Console. You can still use both mouse and keyboard, however the scaling algorithm will not preserve all display details.

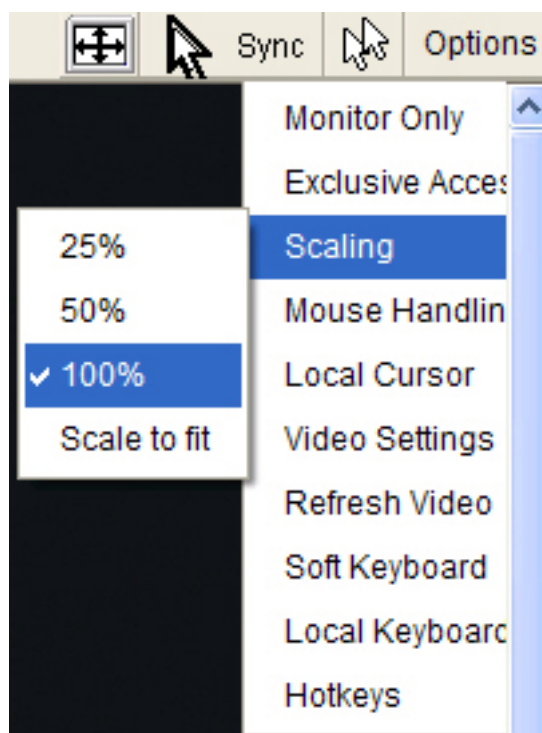

Figure 5-9. Remote Console Options Menu:Scaling

- **Mouse Handling**

The submenu for mouse handling offers two options for synchronizing the local and the remote mouse pointer.

Fast Sync --

The fast synchronization is used to correct a temporary, but fixed skew.

Intelligent Sync --

Use this option if the fast sync does not work or the mouse settings have been changed on the host system.

Warning

This method takes more time than the fast one and requires a correctly adjusted picture. Use the auto adjustment function or the manual correction in the Video Settings panel to setup the picture.

- **Local Cursor**

Offers a list of different cursor shapes to choose from for the local mouse pointer. The selected shape will be saved for the current user and activated the next time this user opens the Remote Console. The number of available shapes depends on the Java Virtual Machine; a version of 1.2 or higher offers the full list.

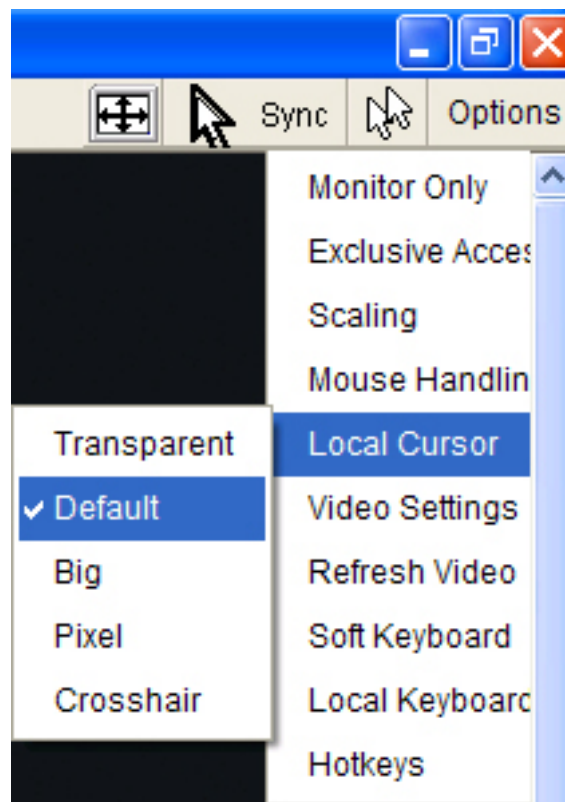

Figure 5-10. Remote Console Options Menu:Cursor

- **Video Settings**

Opens a panel for changing the PS/2 IP-KVM switch video settings. PS/2 IP-KVM switch features two different dialogs, which influence the video settings.

Video Settings through the HTML-Frontend

To enable local video port, select this option. This option decides if the local video output of PS/2 IP-KVM switch is active and passing through the incoming signal from the host system.

The option Noise Filter defines how PS/2 IP-KVM switch reacts to small changes in the video input signal. A large filter setting needs less network traffic and leads to a faster video display, but small changes in some display regions may not be recognized immediately. A small filter displays all changes instantly but may lead to a constant amount of network traffic even if display content is not really changing

(depending on the quality of the video input signal). All in all the default setting should be suitable for most situations.

Video Settings through the remote console

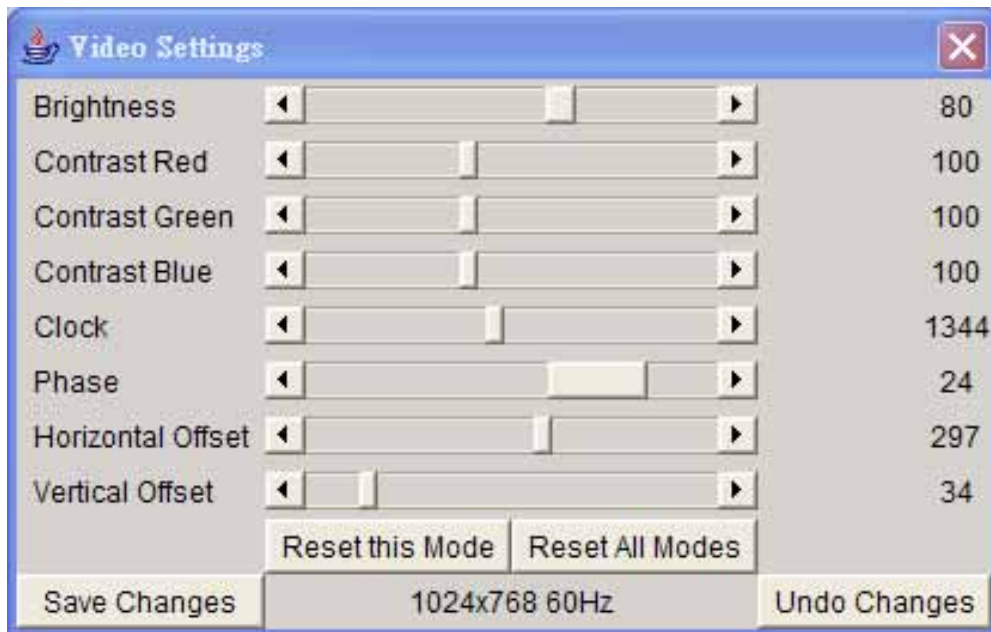

Figure 5-11. Video Settings Panel

Brightness

Controls the brightness of the picture

Contrast

Controls the contrast of the picture

Clock

Defines the horizontal frequency for a video line and depends on the video mode. Different video card types may require different values here. The default settings in conjunction with the auto adjustment procedure should be adequate for all common configurations. If the picture quality is still bad after auto adjustment you may try to change this setting together with the sampling phase to achieve a better quality.

Phase

Defines the phase for video sampling, used to control the display quality together with the setting for sampling clock.

Horizontal Position

Use the left and right buttons to move the picture in horizontal direction while this option is selected.

Vertical Position

Use the left and right buttons to move the picture in vertical direction while this option is selected.

Reset this Mode

Reset mode specific settings to the factory-made defaults.

Reset all Modes

Reset all settings to the factory-made defaults.

Save changes

Save changes permanently

Undo Changes

Restore last settings

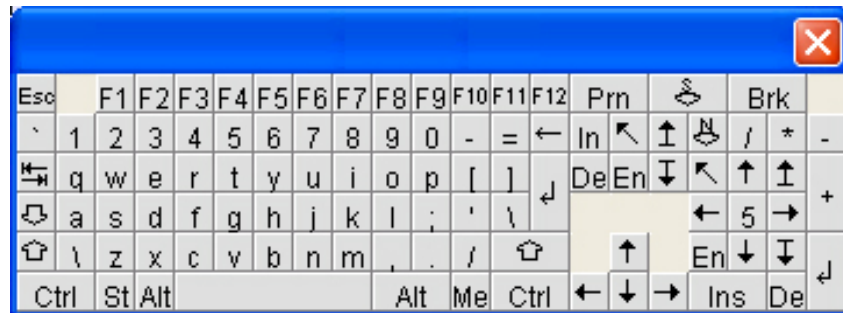
Soft Keyboard**Figure 5-12. Soft Keyboard**

Opens up the Menu for the Soft-Keyboard.

- Show

Pops up the Soft-Keyboard. The Soft-Keyboard is necessary in case your host system runs a completely different language and country mapping than your administration machine.

- Mapping

Used for choosing the according language and country mapping of the Soft-Keyboard.

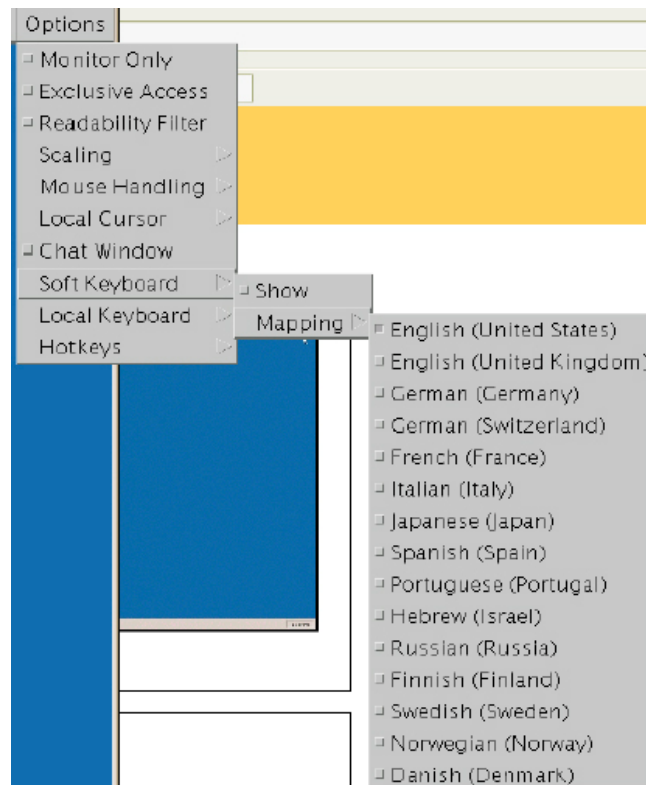
**Figure 5-13. Soft Keyboard Mapping**

- Local Keyboard

Used to change the language mapping of your browser machine running the Remote Console Applet. Normally, the applet determines the correct value automatically. However, depending on your particular JVM and your browser settings this is not always possible. A typical example is a German localized system that uses an US-English keyboard mapping. In this case you have to change the Local Keyboard setting to the right language, manually.

- Hotkeys

Opens a list of hotkeys defined before. Choose one entry, the command will be sent to the host system.

A confirmation dialog can be added that will be displayed before sending the selected command to the remote host. Select “OK” to perform the command on the remote host.

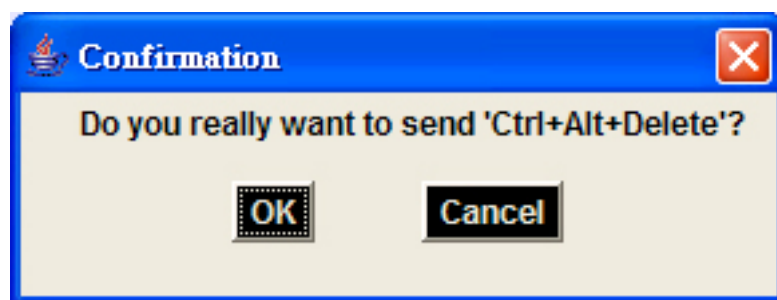

Figure 5-14. Remote Console Confirmation Dialog

5.5.2 Remote Console Status Line

Status line

Shows both console and the connection state. The size of the remote screen is displayed. Figure 4-15 was taken from a Remote Console with a resolution of 800x600 pixels. The value in brackets describes the connection to the Remote Console. “Norm” means a standard connection without encryption, “SSL” indicates means a secure connection.

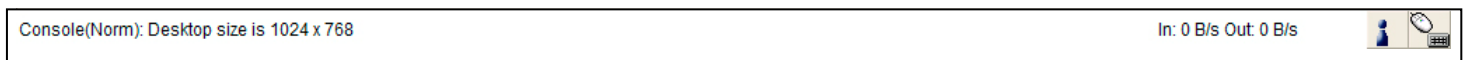

Figure 5-15. Status line

Furthermore, both the incoming (“In:”) and the outgoing (“Out:”) network traffic are visible (in kb/s). If compressed encoding is enabled, a value in brackets displays the compressed transfer rate.

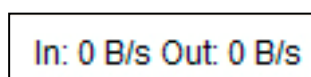

Figure 5-16. Status line transfer rate

For more information about Monitor Only and Exclusive Access settings, see the according sections

6. Menu Options

6.1 Remote Control

6.1.1 KVM Console

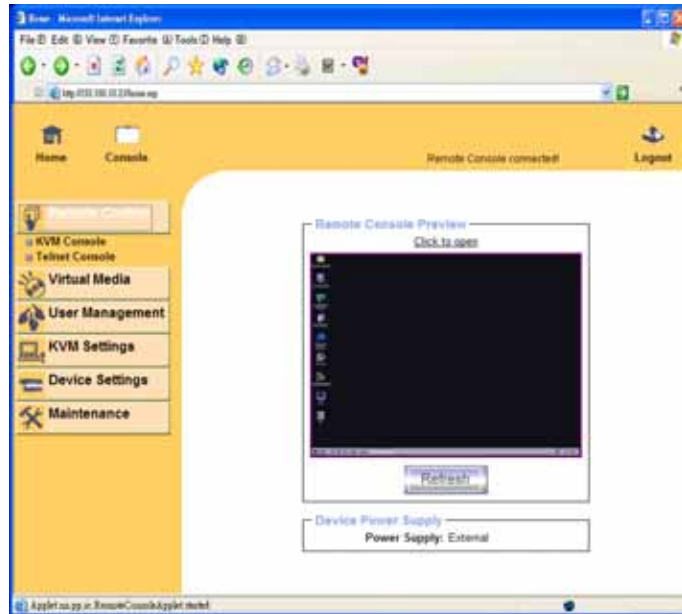

Figure 6-1. KVM Console

To open the KVM console, either clicks on the menu entry on the left, or on the console picture on the right. To refresh the picture, click on the button “Refresh”.

For the power settings see the Section called *Remote Power*.

6.1.2 Telnet Console

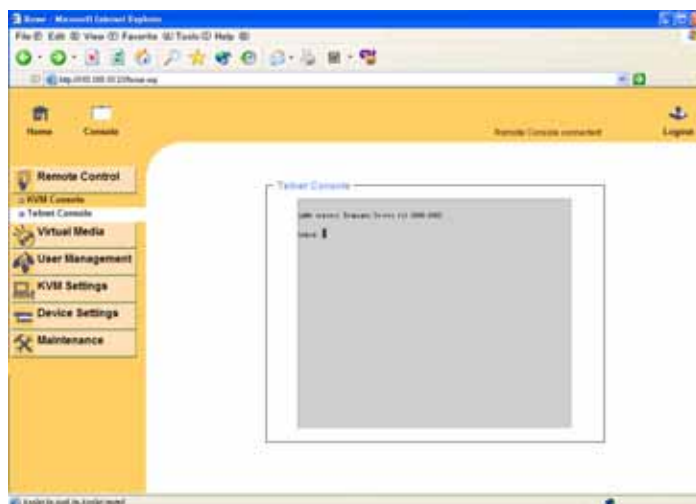

Figure 6-2. Telnet Console

The PS/2 IP-KVM switch firmware features a Telnet server that enables a user to connect via a standard Telnet client. In case the Telnet program is using a VT 100, VT 102 or VT 220

terminal or an according emulation, it is even possible to perform a console redirection as long as the PS/2 IP-KVM switch host machine is using a text mode screen resolution.

Connecting to the PS/2 IP-KVM switch is done as usual and as required by the Telnet client, for instance in a UNIX shell:

```
telnet 192.168.1.22
```

Replace the IP address by the one that is actually assigned to the PS/2 IP-KVM switch. This will prompt for username and password in order to log into the device. The credentials that need to be entered for authentication are identical to those of the web interface. That means, the user management of the Telnet interface is entirely controlled with the according functions of the web interface.

Once you have successfully logged into the PS/2 IP-KVM switch a command line will be presented and you can enter according management commands.

In general, the Telnet interface supports two operation modes: the command line mode and the terminal mode. The command line mode is used to control or display some parameters. In terminal mode the pass-through access to serial port 1 is activated (if the serial settings were made accordingly). All inputs are redirected to the device on serial port 1 and its answers are displayed on the Telnet interface.

The following list shows the according command mode command syntax and their usage.

help

Displays the list of possible commands

cls

Clears the screen

quit

Exits the current session and disconnects from the client

version

Displays the release information

terminal

Starts the terminal passthrough mode for serial port 1. The key sequence esc exit switches back to the command mode. The command has an optional parameter (1 or 2) to select the desired serial port for passthrough access.

6.2 User Management

6.2.1 Change Password

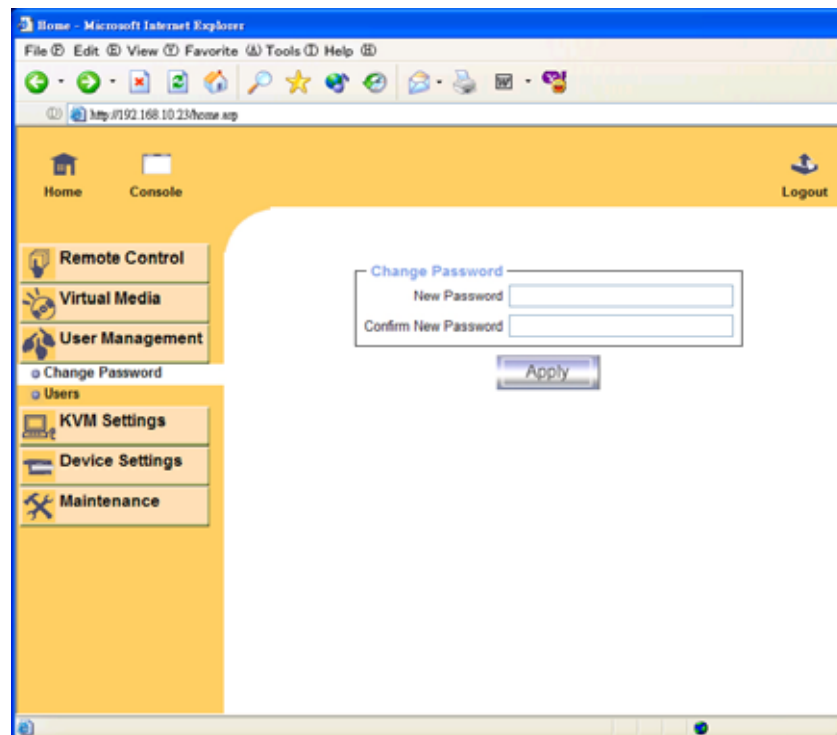

Figure 6-12. Set password

To change your password, enter the new password in the upper entry field. Retype the password in the field below. Click “Apply” to submit your changes.

6.2.2 Users And Groups

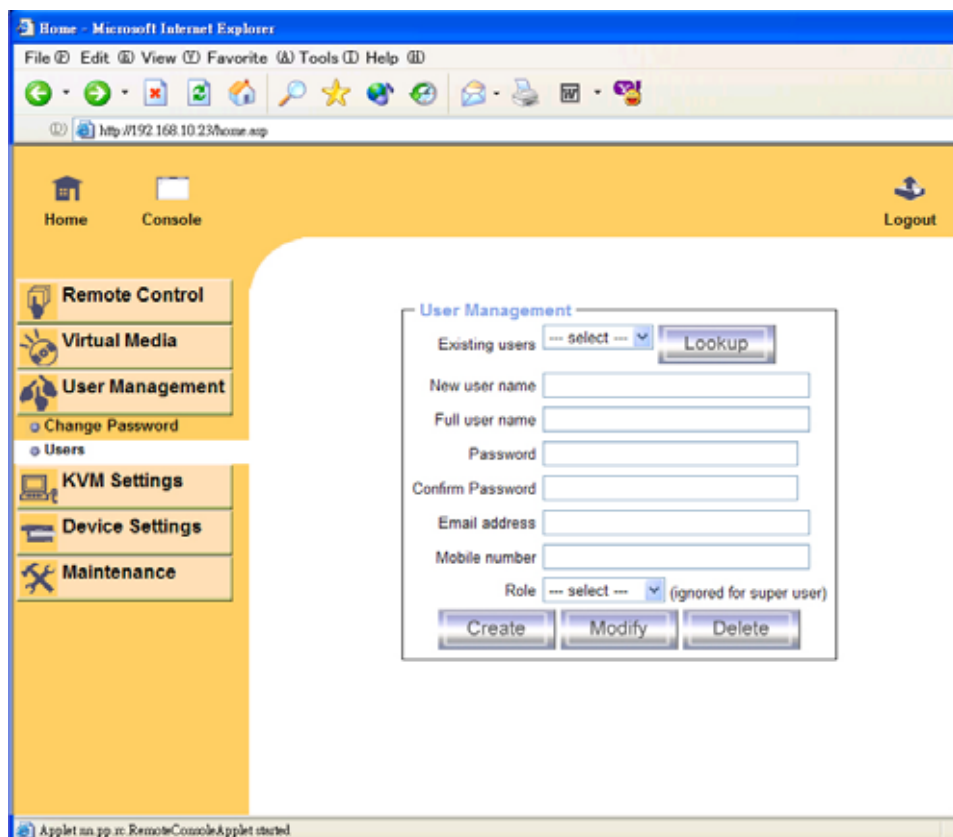

Figure 6-13. Set User

The PS/2 IP-KVM switch comes with 2 pre-configured user accounts that have fixed permissions. The account super has all possible rights to configure the device and to use all functions PS/2 IP-KVM switch offers. The account “user” has only the permission to open and use the Remote Console. Even his user name and password can only be changed by the super account.

Upon delivery, both accounts have the password pass. Make sure to change these passwords immediately after you have installed and firstly accessed your PS/2 IP-KVM switch.

While the “user” account never sees the following options, the user “super” account can change the name and password for both accounts.

Existing users

Select an existing user for modification. Once a user has been selected, click the lookup button to see the user information.

New User name

The new user name for the selected account.

Password

The password for the login name. It must be at least four characters long.

Confirm password

Confirmation of the password above.

6.3 KVM Settings

6.3.1 User Console

The following settings are user specific. That means, the super user can customize these settings for every users separately. Changing the settings for one user does not affect the settings for the other users.

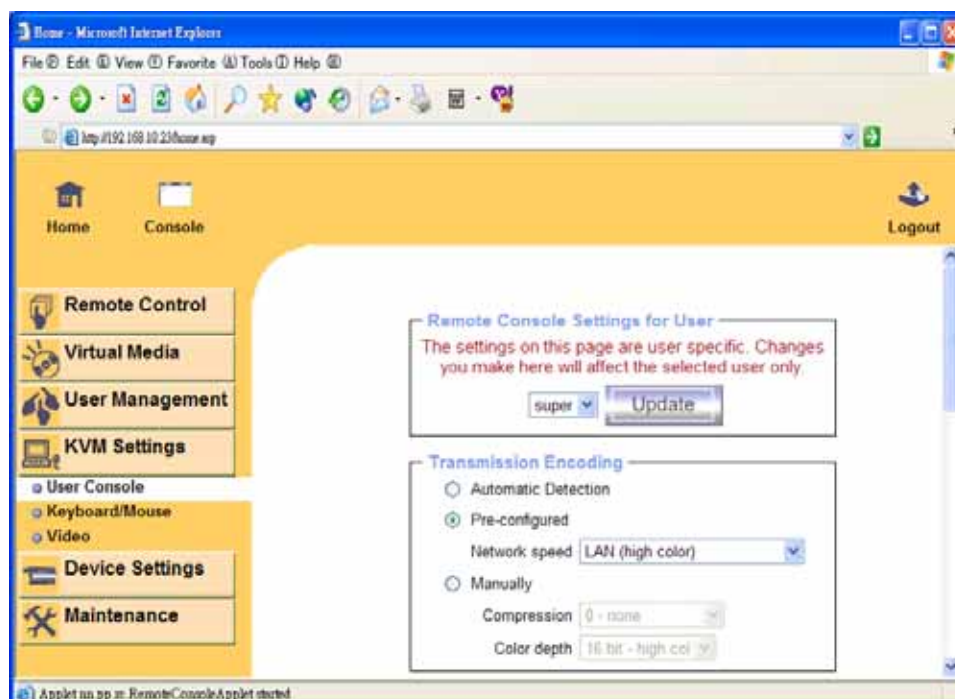

Figure 6-14. User Console Settings (Part 1)

User select box

This selection box displays the user ID for which the values are shown and for which the changes will take effect. You may change the settings of other users if you have the necessary access rights.

Transmission Encoding

The Transmission Encoding setting allows changing the image-encoding algorithm that is used to transmit the video data to the Remote Console window. It is possible to optimize the speed of the remote screen depending on the number of users working at the same time and the bandwidth of the connection line (Modem, ISDN, DSL, LAN, etc.).

Automatic detection

The encoding and the compression level is determined automatically from the available bandwidth and the current content of the video image.

Pre-configured

The pre-configured settings deliver the best result because of optimized adjustment of compression and colour depth for the indicated network speed.

Manually

Allows to adjust both compression rate and the colour depth individually. Depending on the selected compression rate the data stream between the PS/2 IP-KVM switch and the Remote Console will be compressed in order to save bandwidth. Since high compression rates are very time consuming, they should not be used while several users are accessing the PS/2 IP-KVM switch simultaneously.

The standard color depth is 16 Bit (65536 colors). The other color depths are intended for slower network connections in order to allow a faster transmission of data. Therefore compression level 0 (no compression) uses only 16 Bit color depth. At lower bandwidths only 4 Bit (16 colors) and 2 Bit (4 gray scales) are recommended for typical desktop interfaces. Photo-like pictures have best results with 4 Bit (16 gray scales). 1 Bit color depth (black/white) should only be used for extremely slow network connections.

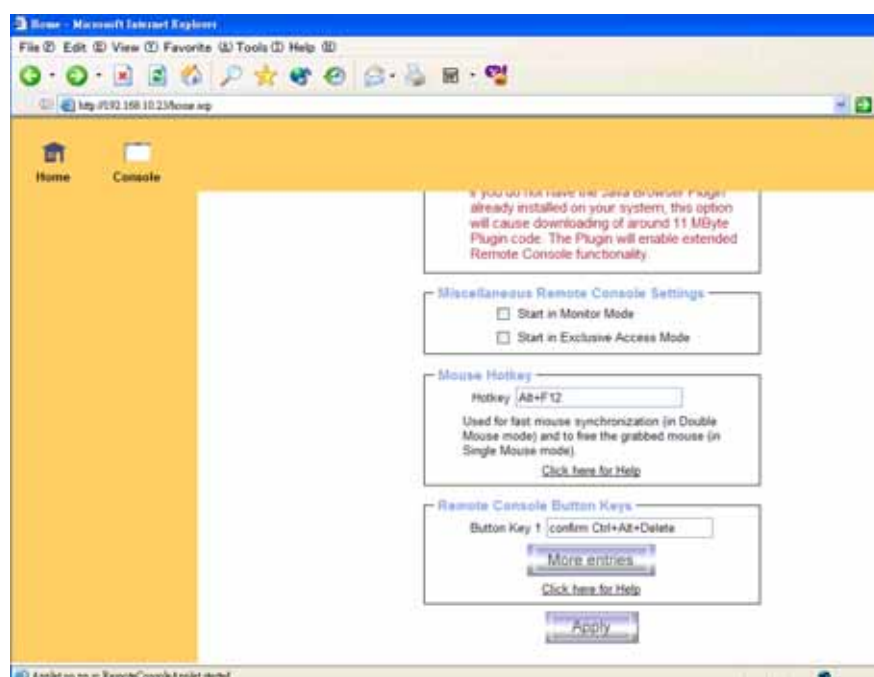

Figure 6-15. User Console Settings (Part 2)

Remote Console Type

Specifies, which Remote Console Viewer to use.

Default Java-VM

Uses the default Java Virtual Machine of your Browser. This may be the Microsoft JVM for the Internet Explorer, or the Sun JVM if it is configured this way. Use of the Sun JVM may also be forced (see below).

Sun Microsystems Java Browser Plugin

Instructs the web browser of your administration system to use the JVM of Sun Microsystems. The JVM in the browser is used to run the code for the Remote Console window, which is actually a Java Applet. If you check this box for the first time on your administration system and the appropriate Java plug-in is not already installed on your system, it will be downloaded and installed automatically. However, in order to make the installation possible, you still need to answer the according dialogs with "yes" . The download volume is around 11 Mbytes. The advantage of downloading Sun's JVM lays in providing a stable and identical Java Virtual Machine across different platforms. The Remote Console software is optimized for this JVM versions and offers wider range of functionality when run in SUN's JVM. (Hint: If you are connected over a slow connection to the Internet you can also pre-install the JVM on your administration machine. The software is available on the CD ROM that is delivered along with the PS/2 IP-KVM switch.)

Miscellaneous Remote Console Settings

Start in Monitor Mode

Sets the initial value for the monitor mode. By default the monitor mode is off. In case you switch it on, the Remote Console window will be started in a read only mode.

Start in Exclusive Access Mode

Enables the exclusive access mode immediately at Remote Console startup. This forces the Remote Consoles of all other users to close. No one can open the Remote Console at the same time again until this user disables the exclusive access or logs off.

Mouse hotkey

Allows to specify a hotkey combination which starts either the mouse synchronization process if pressed in the Remote Console, or is used to leave the single mouse mode.

Remote Console Button Keys

Button Keys allow simulating keystrokes on the remote system that cannot be generated locally. The reason for this might be a missing key or the fact, that the local operating system of the Remote Console is unconditionally catching this keystroke already. Typical examples are " Control+Alt+Delete " on Windows and DOS, what is always caught, or "Control+Backspace" on Linux for terminating the X-Server. The syntax to define a new Button Key is as follows:

[confirm] <keycode>[+]-[*]<keycode>]*

“confirm” requests confirmation by a dialog box before the key strokes will be sent to the remote host.

“keycode” is the key to be sent. Multiple key codes can be concatenated with a plus, or a minus sign. The plus sign builds key combinations, all keys will be pressed until a minus sign or the end of the combination is encountered. In this case all pressed keys will be released in reversed sequence. So the minus sign builds single, separate key presses and -releases. The star inserts a pause with duration of 100 milliseconds.

6.3.2 Keyboard/Mouse

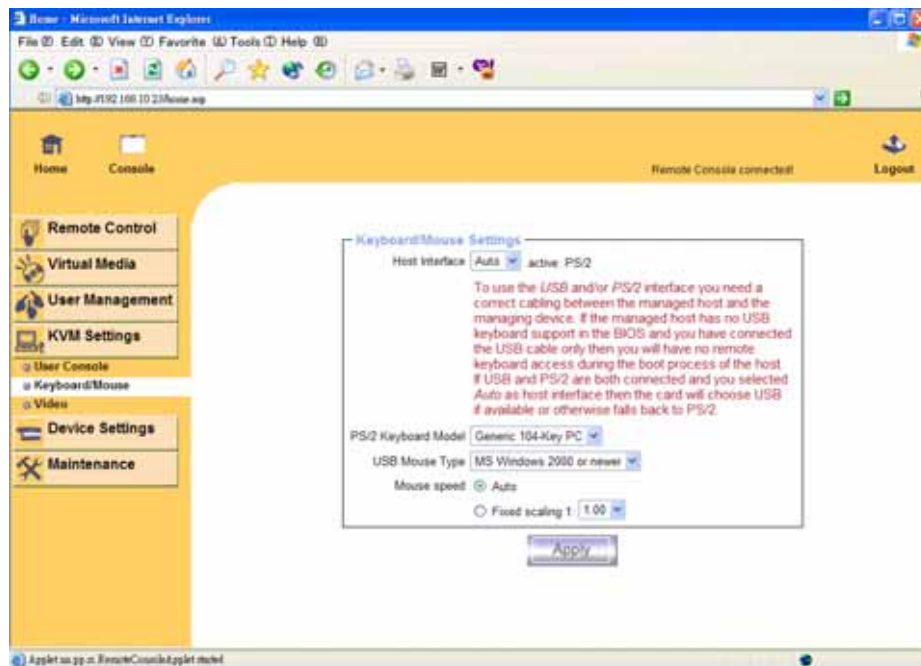

Figure 6-17. Keyboard and Mouse Settings

Host Interface

Enables a certain interface the mouse is connected to. You can choose between “Auto” for automatic detection, “USB” for an USB mouse, and “PS/2” for a PS/2 mouse.

Warning

To use the USB and/or PS/2 interface you need a correct cabling between the managed host and the managing device. If the managed host has no USB keyboard support in the BIOS and you have connected the USB cable only then you will have no remote keyboard access during the boot process of the host. If USB and PS/2 are both connected and you selected “ Auto ” as host interface, then the card will select “ USB ” if available or otherwise falls back to “ PS/2 ”.

To get USB remote keyboard access during the boot process of the host, the following conditions must be fulfilled:

- the host bios must have USB keyboard support
- the USB cable must be connected or must be selected in the Host interface option

PS/2 Keyboard Model

Enables a certain keyboard layout. You can choose between “Generic 101-Key PC” for a standard keyboard layout, “Generic 104-Key PC” for a standard keyboard layout extended by three additional windows keys, “Generic 106-Key PC” for a Japanese keyboard, and “Apple Macintosh” for the Apple Macintosh.

USB Mouse Type

Enables USB mouse type. Choose between “MS Windows 2000 or newer” for MS Windows 2000 or Windows XP, or “Other Operating Systems” for MS Windows NT, Linux, or OS X. In “MS Windows 2000 or newer” mode the remote mouse is always synchronized with the local mouse.

Mouse Speed

- Auto mouse speed

Use this option if the mouse settings on host use an additional acceleration setting. The PS/2 IP-KVM switch tries to detect the acceleration and speed of the mouse during the mouse sync process.

- Fixed mouse speed

Use a direct translation of mouse movements between the local and the remote pointer.

You may also set a fixed scaling which determines the amount the remote mouse pointer is moved when the local mouse pointer is moved by one pixel. This option only works when the mouse settings on the host are linear. This means that there is no mouse acceleration involved.

To set the options, click on the button “Apply”.

6.3.3 Video

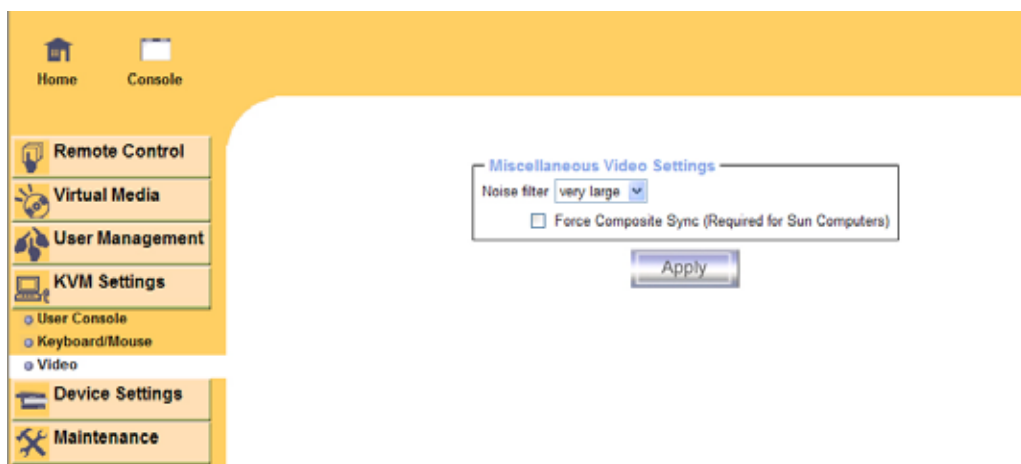

Figure 6-18. Video Settings

Miscellaneous Video Settings

- Noise filter

This option defines how the PS/2 IP-KVM switch reacts to small changes in the video input signal. A large filter setting needs less network traffic and leads to a faster video

display, but small changes in some display regions may not be recognized immediately. A small filter displays all changes instantly but may lead to a constant amount of network traffic even if the display content is not really changing (depending on the quality of the video input signal). All in all the default setting should be suitable for most situations.

- Force Composite Sync (Required for Sun Computers)

To support signal transmission from a Sun machine, enable this option. If not enabled the picture of the remote console will not be visible.

To set the options, click on the button "Apply".

6.4 Device Settings

6.4.1 Network

The Network Settings panel as shown in Figure 6-19 allows changing network related parameters. Each parameter will be explained below. Once applied the new network settings will immediately come into effect.

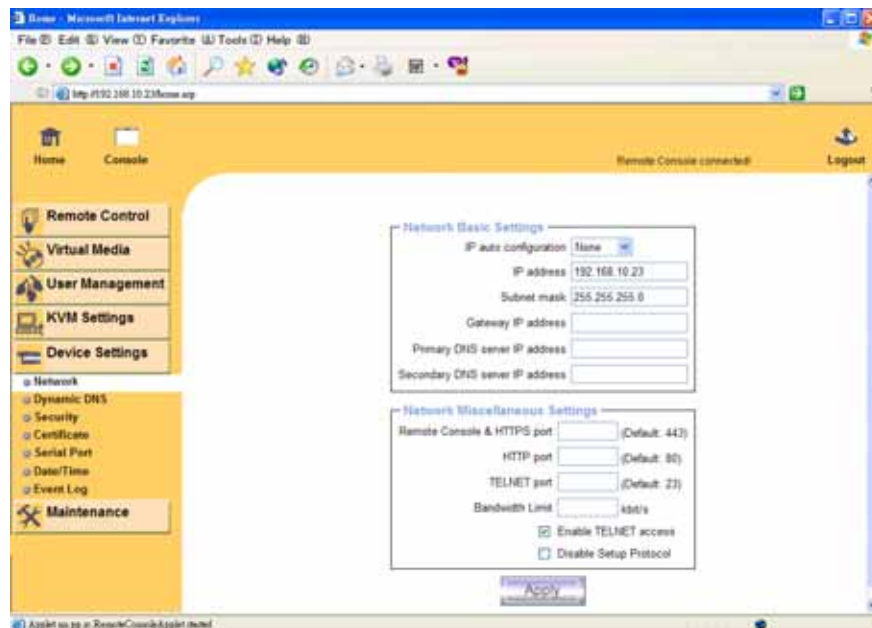

Figure 6-19. Network Settings

Warning

The initial IP configuration is usually done directly at the host system using the special procedure described in Table 4-1.

Warning

Changing the network settings of the PS/2 IP-KVM switch might result in losing connection to it. In case you change the settings remotely make sure that all the values are correct and you still have an option to access the PS/2 IP-KVM switch.

IP auto configuration

With this option you can control if the PS/2 IP-KVM switch should fetch its network settings from a DHCP or BOOTP server. For DHCP, select “dhcp” , and for BOOTP select “bootp” accordingly. If you choose “none” then IP auto configuration is disabled.

IP address

IP address in the usual dot notation.

Subnet Mask

The net mask of the local network.

Gateway IP address

In case the PS/2 IP-KVM switch should be accessible from networks other than the local one, this IP address must be set to the local network router's IP address.

Primary DNS Server IP Address

IP address of the primary Domain Name Server in dot notation. This option may be left empty, however the PS/2 IP-KVM switch will not be able to perform name resolution.

Secondary DNS Server IP Address

IP address of the secondary Domain Name Server in dot notation. It will be used in case the Primary DNS Server cannot be contacted.

Remote Console And HTTPS port

Port number at which the PS/2 IP-KVM switch's Remote Console server and HTTPS server are listening. If left empty the default value will be used.

HTTP port

Port number at which the PS/2 IP-KVM switch's HTTP server is listening. If left empty the default value will be used.

Telnet port

Port number at which the PS/2 IP-KVM switch's Telnet server is listening. If left empty the default value will be used.

Bandwidth limitation

The maximum network traffic generated through the PS/2 IP-KVM switch ethernet device. Value in Kbit/s.

Enable Telnet access

Set this option to allow accessing the LARA express using the Telnet Gateway see the Section called Telnet Console).

Disable Setup Protocol

Enable this option to exclude the PS/2 IP-KVM switch from the setup protocol.

6.4.2 Dynamic DNS

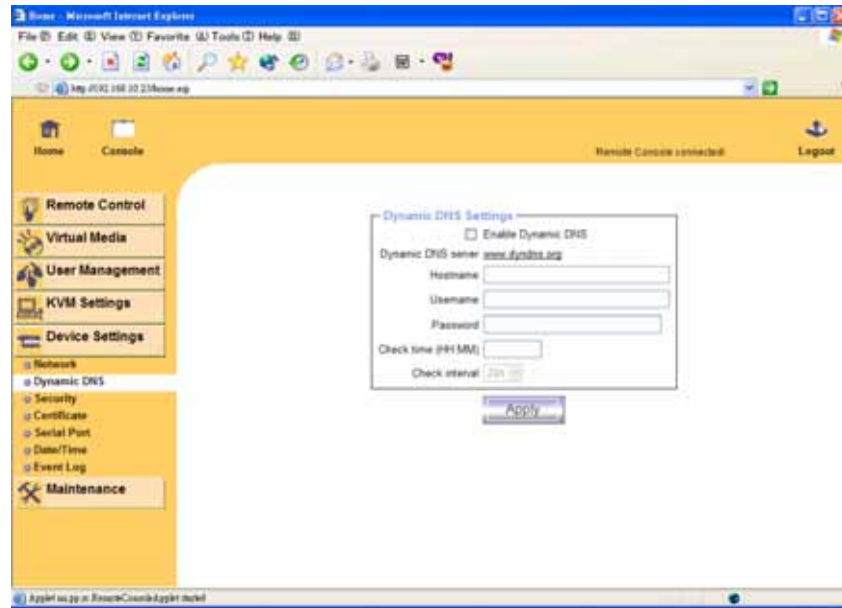

Figure 6-20. Dynamic DNS

A freely available Dynamic DNS service (dyndns.org) can be used in the following scenario (see Figure 6-21):

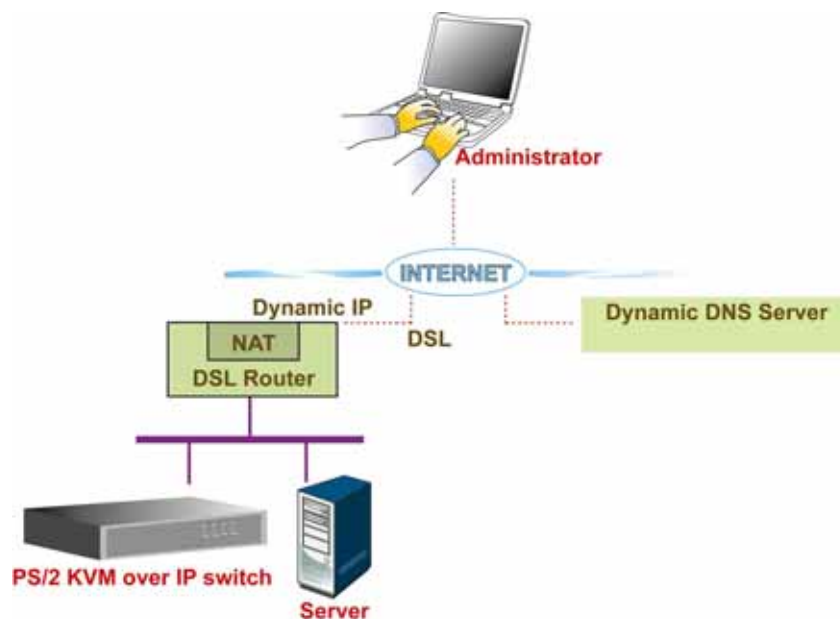

Figure 6-21. Dynamic DNS Scenario

The PS/2 IP-KVM switch is reachable via the IP address of the DSL router, which is dynamically assigned by the provider. Since the administrator does not know the IP address assigned by the provider, the PS/2 IP-KVM switch connects to a special dynamic DNS server in regular intervals and registers its IP address there. The administrator may contact this server as well and pick up the same IP address belonging to his card.

The administrator has to register a PS/2 IP-KVM switch that is supposed to take part in the service with the Dynamic DNS Server and assign a certain hostname to it. He will get a nickname and a password in return to the registration process. This account information

together with the hostname is needed in order to determine the IP address of the registered PS/2 IP-KVM switch.

You have to perform the following steps in order to enable Dynamic DNS:

- Make sure that the LAN interface of the PS/2 IP-KVM switch is properly configured.
- Enter the Dynamic DNS Settings configuration dialog as shown in Figure 6-20.
- Enable Dynamic DNS and change the settings according to your needs (see below).

Enable Dynamic DNS

This enables the Dynamic DNS service. This requires a configured DNS server IP address.

Dynamic DNS server

This is the server name where PS/2 IP-KVM switch registers itself in regular intervals. Currently, this is a fixed setting since only dyndns.org is supported for now.

Hostname

This is the hostname of the PS/2 IP-KVM switch that is provided by the Dynamic DNS Server. (Use the whole name including the domain, e.g. testserver.dyndns.org, not just the actual hostname).

Username

You have registered this username during your manual registration with the Dynamic DNS Server. Spaces are not allowed in the Nickname.

Password

You have used this password during your manual registration with the Dynamic DNS Server.

Check time

The PS/2 IP-KVM switch card registers itself in the Dynamic DNS server at this time.

Check interval

This is the interval for reporting again to the Dynamic DNS server by the PS/2 IP-KVM switch.

Warning

The PS/2 IP-KVM switch has its own independent real time clock. Make sure the time setting of the PS/2 IP-KVM switch is correct. (See the Section called *Date And Time*)

6.4.3 Security

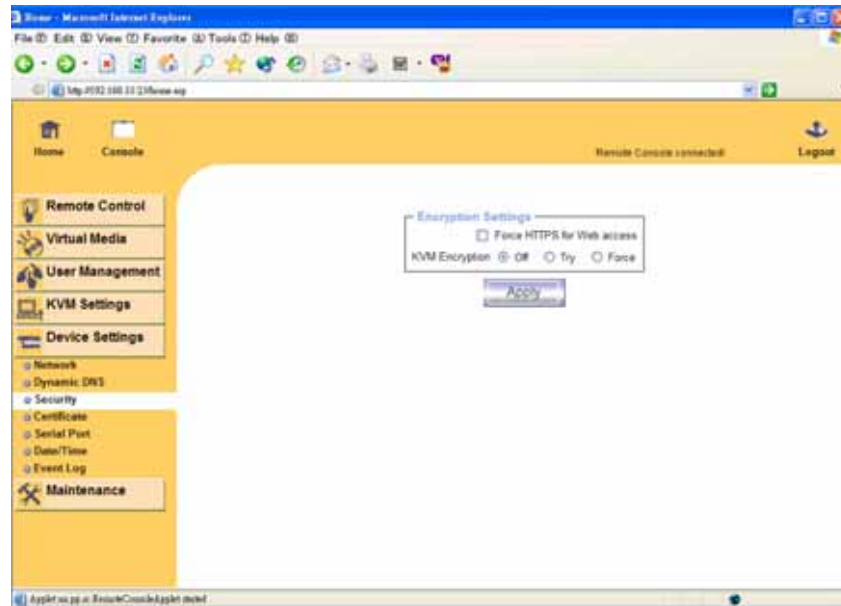

Figure 6-22. Device Security

Force HTTPS

If this option is enabled access to the web front-end is only possible using an HTTPS connection. The PS/2 IP-KVM switch will not listen on the HTTP port for incoming connections.

In case you want to create your own SSL certificate that is used to identify the PS/2 IP-KVM switch refer to the Section called *Certificate*.

KVM encryption

This option controls the encryption of the RFB protocol. RFB is used by the Remote Console to transmit both the screen data to the administrator machine and keyboard and mouse data back to the host. If set to 'Off' no encryption will be used. If set to 'Try' the applet tries to make an encrypted connection. In case connection establishment fails for any reason an unencrypted connection will be used.

If set to "Force" the applet tries to make an encrypted connection. An error will be reported in case connection establishment fails.

6.4.4 Certificate

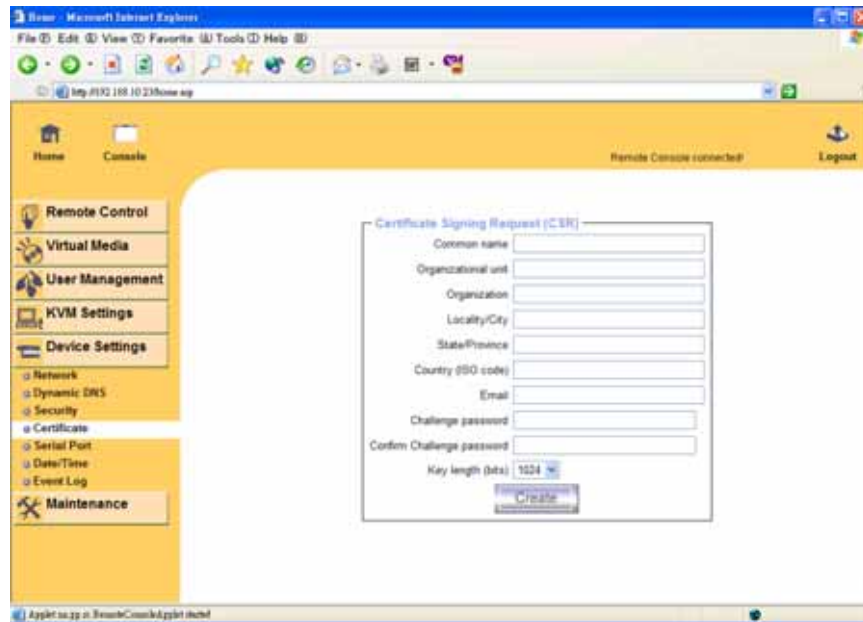

Figure 6-23. Certificate Settings

The PS/2 IP-KVM switch uses the Secure Socket Layer (SSL) protocol for any encrypted network traffic between itself and a connected client. During the connection establishment the PS/2 IP-KVM switch has to expose its identity to a client using a cryptographic certificate. Upon delivery, this certificate and the underlying secret key is the same for all PS/2 IP-KVM switch ever produced and certainly will not match the network configuration that will be applied to the PS/2 IP-KVM switch cards by its user. The certificate's underlying secret key is also used for securing the SSL handshake. Hence, this is a security risk (but far better than no encryption at all).

However, it is possible to generate and install a new certificate that is unique for a particular PS/2 IP-KVM switch card. In order to do that, the PS/2 IP-KVM switch is able to generate a new cryptographic key and the associated Certificate Signing Request (CSR) that needs to be certified by a certification authority (CA). A certification authority verifies that you are the person who you claim you are, and signs and issues a SSL certificate to you.

The following steps are necessary to create and install a SSL certificate for the PS/2 IP-KVM switch:

- Create a SSL Certificate Signing Request using the panel shown in Figure 6-23. You need to fill out a number of fields that are explained below. Once this is done, click on the button “ Create ” which will initiate the Certificate Signing Request generation. The CSR can be downloaded to your administration machine with the “Download CSR” button (see Figure 6-24).
- Send the saved CSR to a CA for certification. You will get the new certificate from the CA after a more or less complicated traditional authentication process (depending on the CA).
- Upload the certificate to the PS/2 IP-KVM switch using the “Upload” button as shown in Figure 6-24.

Certificate Signing Request (CSR)

The following CSR is pending:

```

countryName           = TW
stateOrProvinceName  = taipei
localityName          = taipei
organizationName      = test org
organizationalUnitName = test
commonName            = test
emailAddress          = test@test.com

```

Download
Delete

Certificate Upload

SSL Certificate File Browse...

Upload

Figure 6-24. SSL Certificate Upload

After completing these three steps, the PS/2 IP-KVM switch has its own certificate that is used for identifying the card to its clients.

Warning

If you destroy the CSR on the PS/2 IP-KVM switch there is no way to get it back! In case you deleted it by mistake, you have to repeat the three steps as described above.

Common name

This is the network name of the PS/2 IP-KVM switch once it is installed in the user's network (usually the fully qualified domain name). It is identical to the name that is used to access the PS/2 IP-KVM switch with a web browser (without the "http://" prefix). In case the name given here and the actual network name differ, the browser will pop up a security warning when the PS/2 IP-KVM switch is accessed using HTTPS.

Organizational unit

This field is used for specifying to which department within an organization the PS/2 IP-KVM switch belongs.

Organization

The name of the organization to which the PS/2 IP-KVM switch belongs.

Locality/City

The city where the organization is located.

State/Province

The state or province where the organization is located.

Country (ISO code)

The country where the organization is located. This is the two-letter ISO code, e.g. DE for Germany, or US for the USA.

Challenge Password

Some certification authorities require a challenge password to authorize later changes on the certificate (e.g. revocation of the certificate). The minimal length of this password is 4 characters.

Confirm Challenge Password

Confirmation of the Challenge Password

Email

The email address of a contact person that is responsible for the PS/2 IP-KVM switch and its security.

Key length

This is the length of the generated key in bits. 1024 Bits are supposed to be sufficient for most cases. Longer keys may result in slower response time of the PS/2 IP-KVM switch during connection establishment.

6.4.5 Serial Port

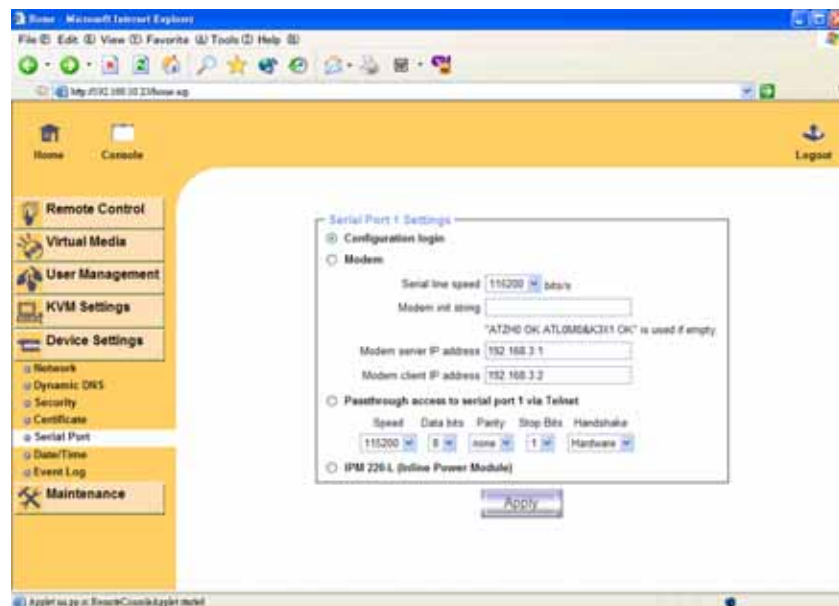

Figure 6-25. Serial Port

The PS/2 IP-KVM switch Serial Settings (Figure 6-25) allow you to specify what device is connected to the serial port and how to use it.

Configuration or console login

Do not use the serial port for any special function, use it only for the initial configuration (see Table 4-1).

Modem

The PS/2 IP-KVM switch offers remote access using a telephone line in addition to the standard access over the built-in Ethernet adapter. The modem needs to be connected to the serial interface of the PS/2 IP-KVM switch .

Logically, connecting to the PS/2 IP-KVM switch using a telephone line means nothing else than building up a dedicated point-to-point connection from your console computer to the PS/2 IP-KVM switch. In other words, the PS/2 IP-KVM switch acts as an Internet Service Provider (ISP) to which you can dial in. The connection is established using the Point-to-Point Protocol (PPP). Before you connect to the PS/2 IP-KVM switch, make sure to configure your console computer accordingly. For instance, on Windows based operating systems you can configure a dial-up network connection, which defaults to the right settings like PPP.

The Modem Settings panel allows you to configure the remote access to the PS/2 IP-KVM switch using a modem. The meaning of each parameter will be described below. The modem settings are part of the serial settings panel.

Serial line speed

The speed the PS/2 IP-KVM switch is communicating with the modem. Most of all modems available today will support the default value of 115200 bps. In case you are using an old modem and discovering problems try to lower this speed.

Modem Init String

The initialization string used by the PS/2 IP-KVM switch to initialize the modem. The default value will work with all modern standard modems directly connected to a telephone line. In case you have a special modem or the modem is connected to a local telephone switch that requires a special dial sequence in order to establish a connection to the public telephone network, you can change this setting by giving a new string. Refer to the modem's manual about the AT command syntax.

Modem server IP address

This IP address will be assigned to the PS/2 IP-KVM switch itself during the PPP handshake. Since it is a point-to-point IP connection virtually every IP address is possible but you must make sure, it is not interfering with the IP settings of the PS/2 IP-KVM switch and your console computer. The default value will work in most cases.

Modem client IP address

This IP address will be assigned to your console computer during the PPP handshake. Since it is a point-to-point IP connection virtually every IP address is possible but you must make sure, it is not interfering with the IP settings of the PS/2 IP-KVM switch and your console computer. The default value will work in most cases.

Passthrough access to serial port via Telnet

Using this option, it is possible to connect an arbitrary device to the serial port and access it (assuming it provides terminal support) via Telnet. Select the appropriate options for the serial port and use the Telnet Console, or a standard Telnet client to connect to the PS/2 IP-KVM switch .

IPM 220-L (Inline Power Module)

This is an optionally available external module to switch power of a single system by putting it in the power supply line of the controlled system.

6.4.6 Date And Time

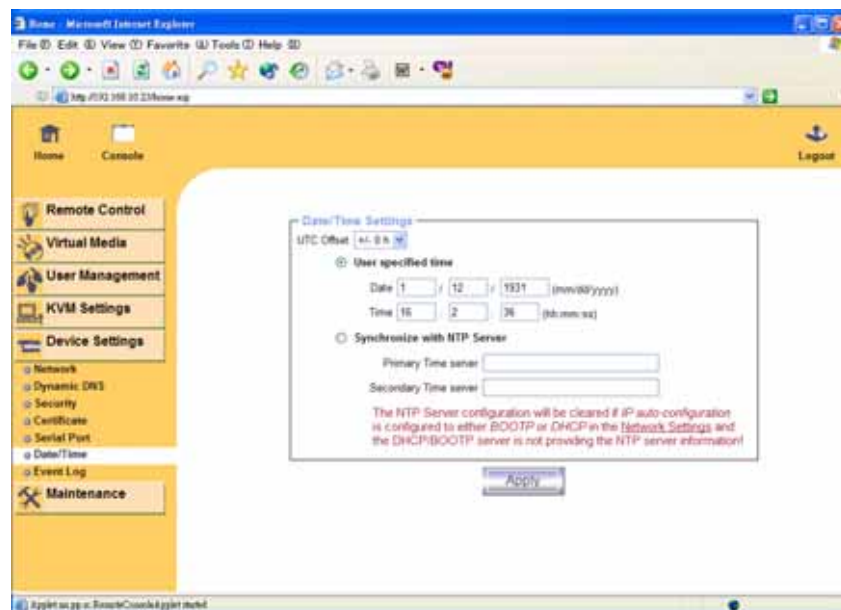

Figure 6-27. Date and Time

This link refers to a page, where the internal real-time clock of the PS/2 IP-KVM switch can be set up (see Figure 6-27). You have the possibility to adjust the clock manually, or to use a NTP timeserver. Without a timeserver, your time setting will not be persistent, so you have to adjust it again, after PS/2 IP-KVM switch loses power for more than a few minutes. To avoid this, you can use a NTP timeserver, which sets up the internal clock automatically to the current UTC time. Because NTP server time is always UTC, there is a setting that allows you to set up a static offset to get your local time.

Warning

There is currently no way to adjust the daylight saving time automatically. So you have to set up the UTC offset twice a year properly to the local rules of your country.

6.4.7 Event Log

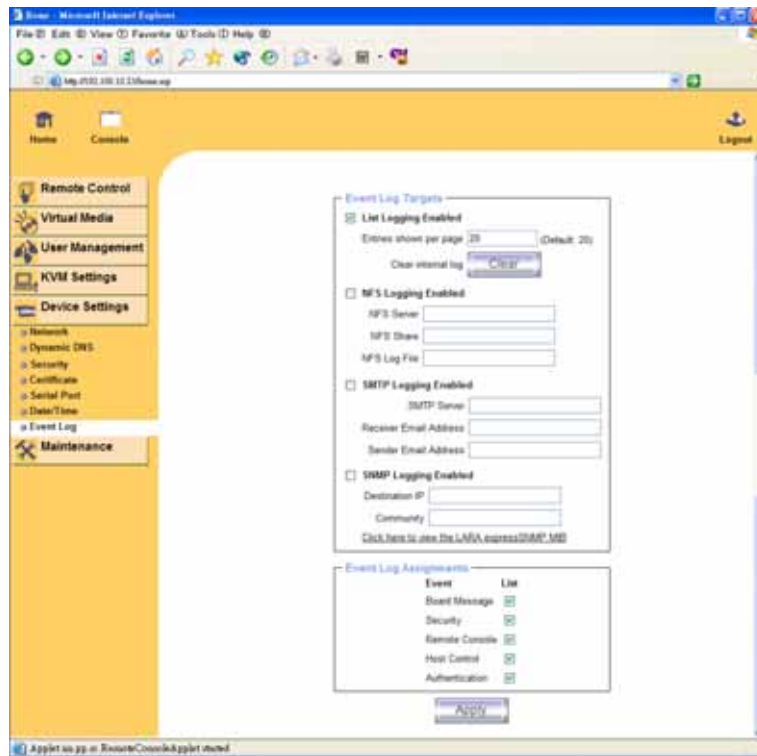

Figure 6-29. Event Log

Important events like a login failure or a firmware update are logged to a selection of logging destinations (see Figure 6-29). Each of those events belongs to an event group, which can be activated separately.

The common way to log events is to use the internal log list of the PS/2 IP-KVM switch. To show the log list, click on “Event Log” on the “Maintenance” page. In the Event Log Settings you can choose how many log entries are shown on each page. Furthermore, you can clear the log file here.

List logging enabled

The common way to log events is to use the internal log list of the PS/2 IP-KVM switch. To show the log list, click on “Event Log” on the “Maintenance” page.

Since the PS/2 IP-KVM switch's system memory is used to save all the information, the maximum number of possible log list entries is restricted to 1.000 events. Every entry that exceeds this limit overrides the oldest one, automatically.

Warning

If the reset button on the HTML front-end is used to restart the PS/2 IP-KVM switch, all logging information is saved permanently and is available after the PS/2 IP-KVM switch has been started. If the PS/2 IP-KVM switch loses power or a hard reset is performed, all logging data will be lost. To avoid this, use one of the following log methods.

NFS Logging enabled

Define a NFS server, where a directory or a static link have to be exported, to write all logging data to a file that is located there. To write logging data from more than one PS/2 IP-KVM switch devices to only one NFS share, you have to define a file name that is unique for each device. When you change the NFS settings and press the button “Apply” ,

the NFS share will be mounted immediately. That means, the NFS share and the NFS server must be filled with valid sources or you will get an error message.

SMTP Logging enabled

With this option, the PS/2 IP-KVM switch is able to send Emails to an address given by the Email address text field in the Event Log Settings. These mails contain the same description strings as the internal log file and the mail subject is filled with the event group of the occurred log event. In order to use this log destination you have to specify a SMTP server, that has to be reachable from the PS/2 IP-KVM switch device and that needs no authentication at all (<serverip>:<port>).

SNMP Logging enabled

If this is activated, the PS/2 IP-KVM switch sends a SNMP trap to a specified destination IP address, every time a log event occurs. If the receiver requires a community string, you can set it in the appropriate text field. Most of the event traps only contain one descriptive string with all information about the log event. Only authentication and host power events have an own trap class that consists of several fields with detailed information about the occurred event. To receive this SNMP traps, any SNMP trap listener may be used.

Warning

In contrast to the internal log file on the PS/2 IP-KVM switch, the size of the NFS log file is not limited. Every log event will be appended to the end of the file so it grows continuously and you may have to delete it or move it away from time to time.

6.5 Maintenance

6.5.1 Device Information

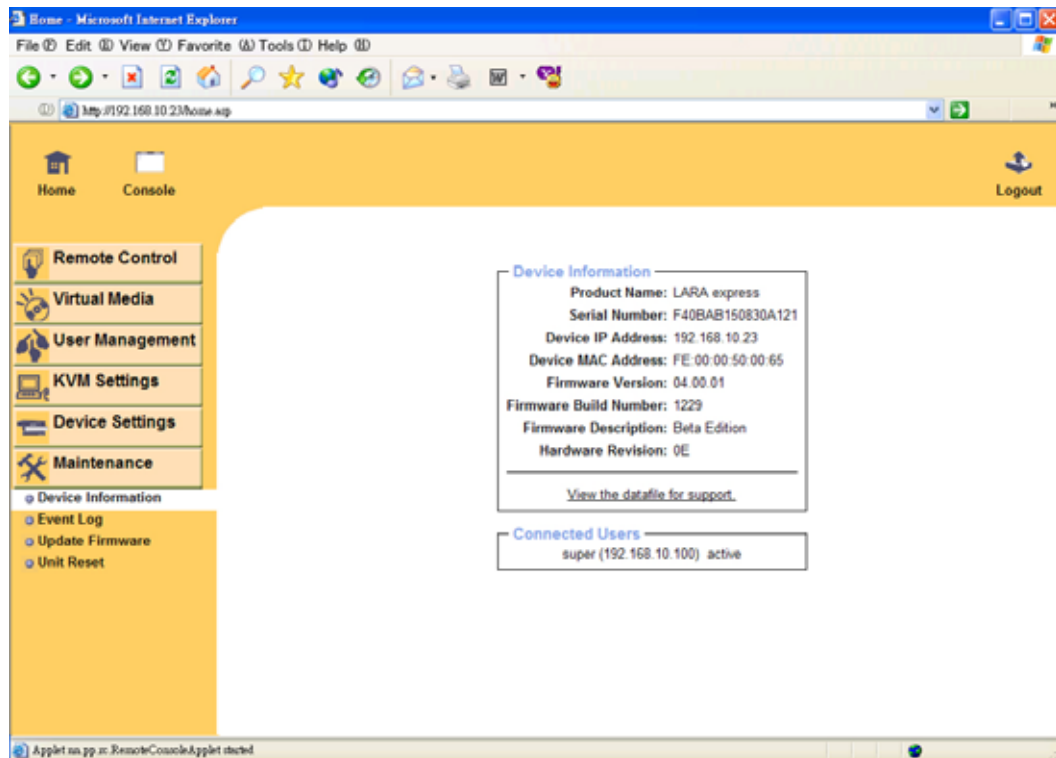

Figure 6-31. Device Information

Board Summary

This section contains a summary with various information about this IP-KVM and its current firmware and allows you to reset the card. You may have a look at Figure 6-31 for an example.

The Data file for support allows you to download the IP-KVM data file with specific support information. This is an XML file with certain customized support information like the serial number etc. You may send us this information together with a support request. It will help us to locate and solve your reported problem.

Connected Users	
test (62.238.0.39)	active
test (80.145.25.183)	26 min idle
test (212.183.10.29)	20 min idle
test (62.153.241.228) RC (exclusive)	active

Figure 6-32. Connected Users

Figure 6-32 displays the IP-KVM activity. From left to right the connected user(s), its IP address (from which host the user comes from) and its activity status is displayed. RC means that the Remote Console is open. If the Remote Console is opened in exclusive mode the term (exclusive mode) is added. For more information about this option see the Section called Remote Console Control Bar in Chapter 5. To display the user activity the last column contains either the term active for an active user or 20 min idle for a user who is inactive for a certain amount of time.

Reset Functions

This section allows you to reset specific parts of the device. Currently this involves the video engine and the PS/2 IP-KVM switch itself. Resetting the card itself is mainly needed to activate a newly updated firmware. It will close all current connections to the administration console and to the Remote Console. The whole process will take about half a minute. Resetting sub devices (e.g. video engine) will take some seconds only and do not result in closing connections.

6.5.2 Event Log

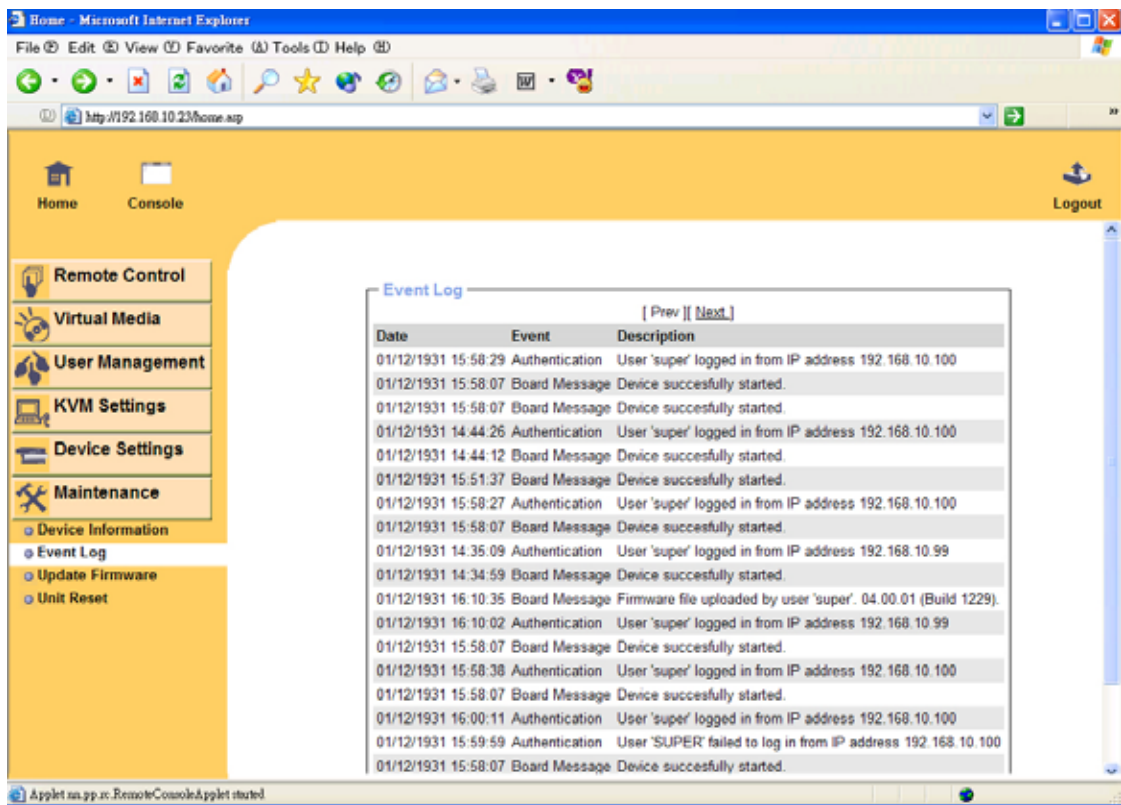

Date	Event	Description
01/12/1931 15:58:29	Authentication	User 'super' logged in from IP address 192.168.10.100
01/12/1931 15:58:07	Board Message	Device successfully started.
01/12/1931 15:58:07	Board Message	Device successfully started.
01/12/1931 14:44:26	Authentication	User 'super' logged in from IP address 192.168.10.100
01/12/1931 14:44:12	Board Message	Device successfully started.
01/12/1931 15:51:37	Board Message	Device successfully started.
01/12/1931 15:58:27	Authentication	User 'super' logged in from IP address 192.168.10.100
01/12/1931 15:58:07	Board Message	Device successfully started.
01/12/1931 14:35:09	Authentication	User 'super' logged in from IP address 192.168.10.99
01/12/1931 14:34:59	Board Message	Device successfully started.
01/12/1931 16:10:35	Board Message	Firmware file uploaded by user 'super'. 04.00.01 (Build 1229).
01/12/1931 16:10:02	Authentication	User 'super' logged in from IP address 192.168.10.99
01/12/1931 15:58:07	Board Message	Device successfully started.
01/12/1931 15:58:38	Authentication	User 'super' logged in from IP address 192.168.10.100
01/12/1931 15:58:07	Board Message	Device successfully started.
01/12/1931 16:00:11	Authentication	User 'super' logged in from IP address 192.168.10.100
01/12/1931 15:59:59	Authentication	User 'SUPER' failed to log in from IP address 192.168.10.100
01/12/1931 15:58:07	Board Message	Device successfully started.

Figure 6-32. Event Log List

Figure 6-32 displays the log list including the events that are logged by the PS/2 IP-KVM switch.

6.5.3 Update Firmware

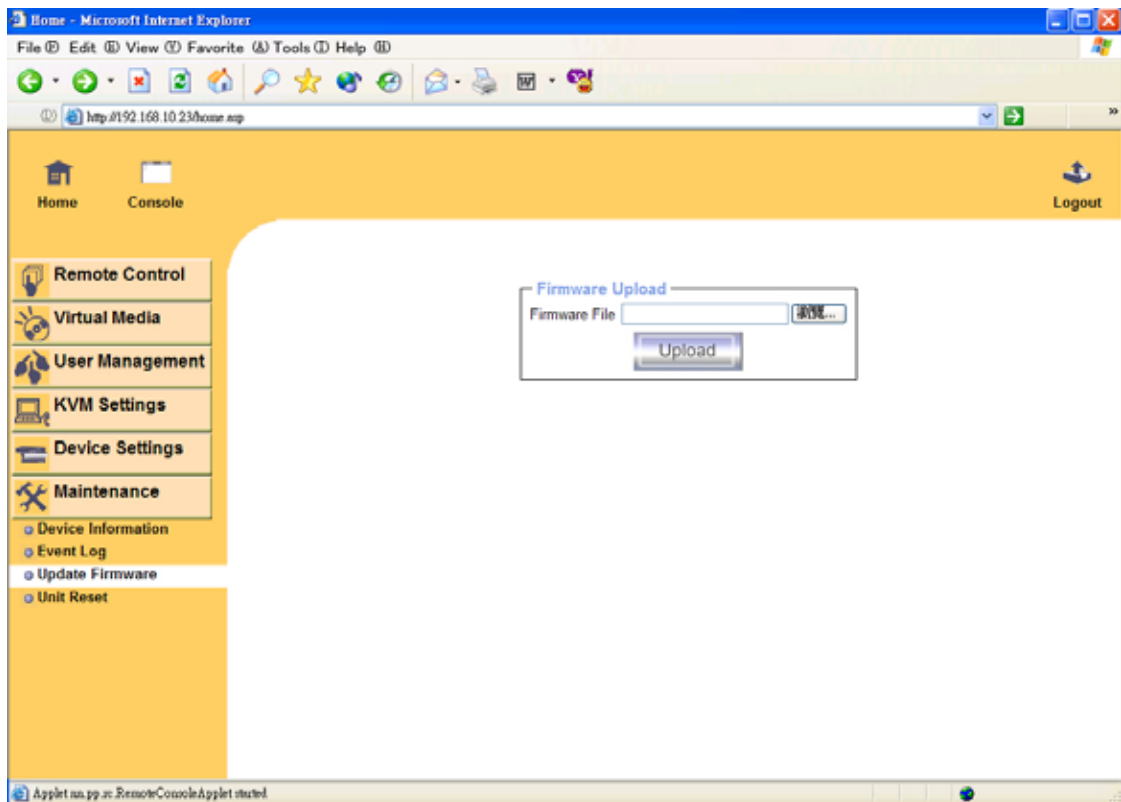

Figure 6-33. Update Firmware

The PS/2 IP-KVM switch is a complete standalone computer. The software it runs is called the firmware. The firmware of the PS/2 IP-KVM switch can be updated remotely in order to install new functionality or special features.

A new firmware update is a binary file which will be sent to you by email or which you can download from the supplier web site. If the firmware file is compressed (file suffix .zip) then you must unzip it before you can proceed. Under the Windows operating system you may use WinZip from <http://www.winzip.com/> for uncompression. Other operating systems might provide a program called unzip.

Before you can start updating the firmware of your PS/2 IP-KVM switch the new uncompressed firmware file has to be accessible on the system that you use for connecting to the PS/2 IP-KVM switch.

Updating the firmware is a three-stage process:

- Firstly, the new firmware file is uploaded onto the PS/2 IP-KVM switch. In order to do that you need to select the file on your local system using the button “ Browse ” of the Upload Firmware panel. Once the firmware file has been uploaded, it is checked whether it is a valid firmware file and whether there were any transmission errors. In case of any error the Upload Firmware function will be aborted.
- Secondly, if everything went well, you see the Update Firmware panel. The panel shows you the version number of the currently running firmware and the version number of the uploaded firmware. Pressing the button “ Update ” will store the new version and substitute the old one completely.

Warning

This process is not reversible and might take some minutes. Make sure the PS/2 IP-KVM switch 's power supply will not be interrupted during the update process, because this may cause an unusable card.

- Thirdly, after the firmware has been stored, the panel will request you to reset the PS/2 IP-KVM switch manually. Half a minute after the reset, the PS/2 IP-KVM switch will run with the new firmware version and should be accessible. However, you are requested to login once again.

Warning

The three-stage firmware update process and complete consistency check are making a mistake in updating the firmware almost impossible. However, only experienced staff members or administrators should perform a firmware update. Make sure the PS/2 IP-KVM switch 's power supply will not be interrupted!

6.5.4 Unit Reset

Figure 6-34. Unit Reset

This section allows you to reset specific parts of the device. This involves the both keyboard and mouse, the video engine and the IP-KVM itself. Resetting the card itself is mainly needed to activate a newly updated firmware. It will close all current connections to the administration console and to the Remote Console.

The whole process will take about half a minute. Resetting sub devices (e.g. video engine) will take some seconds only and does not result in closing connections. To reset a certain

IP-KVM functionality click on the button Reset as displayed in Figure 6-34.

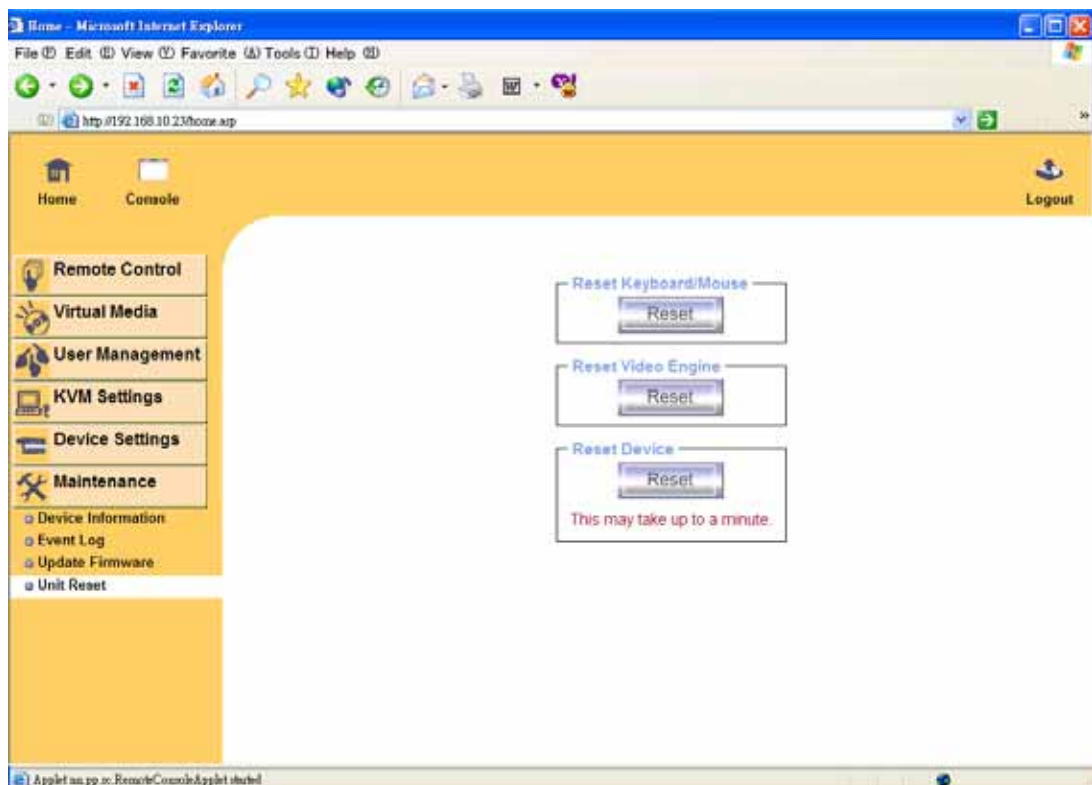
Warning

1. Only the super user is allowed to reset the IP-KVM.
2. Virtual Media function is not available for 8/16 port PS/2 KVM over IP switch.

7. Troubleshooting

1. Ensure that all cables are well seated. Label all of cables with the number for each respective computer to avoid confusion.
2. The recommended VGA cable of PC port distance is 5 meters maximum without ghosting and degradation. Normally, the cable length is based on driver capacity of your VGA card. If you need longer VGA cable, please use VGA extender to accomplish your applications.
3. The recommended PS/2 cable of PC port distance is 5 meters maximum. Normally, the cable length is based on driver capacity of your motherboard PS/2 port. If you need longer PS/2 cable, please use PS/2 extender to accomplish your applications.
4. The Power Jack polarity is center positive and the power adapter need be DC5V, 2.5A.
5. Don't press any keys on the keyboard while the selected computer is booting up. Otherwise, it might cause the keyboard error or keyboard is not detected at PC side.
6. The computer boot up fine, but keyboard doesn't work
 - Make sure the keyboard works when directly plugged into the computer.
 - Try a different keyboard, but use only 101, 102 or 104-key keyboard.
7. The Mouse is not detected during PC boot up.
 - Make sure the mouse works when directly plugged into the computer.
 - Make sure the mouse is a true PS/2 mouse. A combo mouse will work just as long as it is set for PS/2 mode with the correct adapter. Try a different mouse.
 - Avoiding moving the mouse or pressing the mouse buttons when switching ports or during boot up process.
 - Avoiding switching ports during shutting down the PC process.
 - When you switch one PC port to another PC port, the best scan time setting need to be set to 5 sec. or more. Normally, the VGA monitor change one resolution mode to another will take one or two seconds. So, the scan time is not recommended to below 5 seconds.
8. The power switch is off, but the switch still works fine or power adapter is unplugged from the switch, but the switch still works fine.
KVM Switch unit draws the power source from power adapter and all PC's PS/2 port. Some PC's PS/2 port can support enough power for the switch, but some PC's PS/2 port (like laptop, notebook computer...etc.) is unable to supply enough power for the switch. In order to make sure the system can work steadily, please do not set power switch to off state or remove the power adapter from the switch.
9. If forgetting the " password " you typed, please contact your supplier.
10. The remote mouse doesn't work or is not synchronous
Make sure the mouse settings in PS/2 IP-KVM switch match the mouse model. There are some circumstances where the mouse synchronization process could behave incorrectly, refer to Section 5.4.3 for further explanation.
11. Login on PS/2 IP-KVM switch fails.
Was the correct combination of user and password given? On delivery, the user " super " has the password "PS/2 IP-KVM switch" depending on the actual device. Moreover your browser must be

configured to accept cookies.

12. The Remote Console window can't connect to PS/2 IP-KVM switch.
Possibly a firewall prevents access to the Remote Console. Make sure the TCP port numbers 443 or 80 are open for incoming TCP connection establishments.
13. No connection can be established to PS/2 IP-KVM switch.
Check whether the network connection is working in general (ping the IP address of PS/2 IP-KVM switch). If not, check network hardware. Is PS/2 IP-KVM switch powered on? Check whether the IP address of PS/2 IP-KVM switch and all other IP related settings are correct! Also verify that all the IP infrastructure of your LAN, like routers etc., is correctly configured. Without a ping functioning, PS/2 IP-KVM switch can't work either.
14. In the browser the PS/2 IP-KVM switch pages are inconsistent or chaotic.
Make sure your browser cache settings are feasible. Especially make sure the cache settings are not set to something like "never check for newer pages". Otherwise PS/2 IP-KVM switch pages may be loaded from your browser cache and not from the card.
15. Can't upload the signed certificate in MacOS X
If an 'internal error' occurs while uploading the signed certificate either change the extension of the file to .txt or add a file helper using the Internet Explorer preferences for this type of file. Make sure that the encoding is plain text and the checkbox 'use for outgoing' is checked. Another possibility is to use a Mozilla based browser.
16. Every time I open a dialog box with some buttons the mouse pointers are not synchronous anymore
Please check, if you have an option like "Automatically move mouse pointer to the default button of dialog boxes" enabled in the mouse settings of the operating system. This option needs to be disabled.
17. Remote Console doesn't open with Opera in Linux
Some versions of Opera don't grant enough permission if the signature of the applet can't be verified. You can add the lines grant code Base "nn.pp.rc.RemoteConsoleApplet" {permission java.lang.RuntimePermission "accessClassInPackage.sun.*";};to the java policy file of opera (e.g. /usr/share/opera/java/opera.policy) to solve the problem.

8. Certificates

FCC

This equipment has been tested and found to comply with Part 15 of the FCC Rules. Operation is subject to the following two conditions:

- (1) This device may not cause harmful interference
- (2) This device must accept any interference received. Including interference that may cause undesired operation.

CE – Certificate

This equipment is in compliance with the requirements of the following regulations: EN 55 022: CLASS B

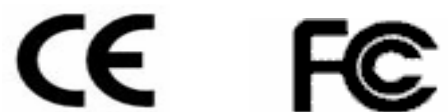

A. Pin Assignments

A.1 VGA HD-15

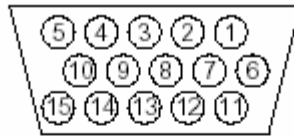

Pin	Assignment	Pin	Assignment
1	Red	9	5 V
2	Green	10	GND sync
3	Blue	11	Not connected
4	Not connected	12	SDA, DDC, ...
5	GND	13	HSYNC
6	GND red	14	VSYNC
7	GND green	15	DATA_CLOCK
8	GND blue		

A.2 RJ 45 Connector Ethernet

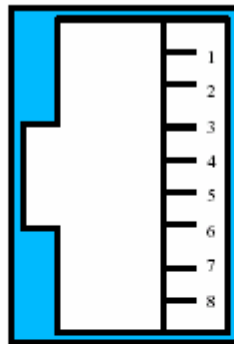

Pin	Assignment	Pin	Assignment
1	TX +	5	Not connected
2	TX -	6	RX -
3	RX +	7	Not connected
4	Not connected	8	Not connected

A.3 RJ 45 Connector ISDN

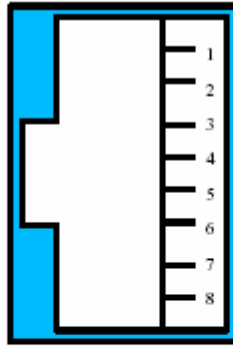

Pin	Assignment	Pin	Assignment
1	Not connected	5	RX -
2	Not connected	6	TX -
3	TX +	7	Not connected
4	RX +	8	Not connected

A.4 Serial SUB-D 9 Connector 1



Pin	Assignment	Pin	Assignment
1	DCD	6	DSR
2	RX	7	RTS
3	TX	8	CTS
4	DTR	9	RI
5	GND		

A.5 KVM 15 pin connector



Pin	Assignment	Pin	Assignment
1	VGA Red	9	MS Data
2	VGA Green	10	KBD VCC
3	VGA Blue	11	MS Clock
4	KBD Data	12	SDA, DCC, ...
5	KBD Clock	13	HSYNC
6	GND	14	VSYNC
7	GND	15	DATA_CLOCK
8	GND		

B. Key Codes

Table C.1 shows the key codes used to defines keystrokes or hotkeys for several functions. Please note that these key codes do not represent necessarily key characters that are used on international keyboards. They name a key on a standard 104 key PC keyboard with an US English language mapping. The layout for this keyboard is shown in Figure C.1. However, most modifier keys and other alphanumeric keys used for hotkey purposes in application programs are on an identical position, no matter what language mapping you are using. Some of the keys have aliases also, means they can be named by 2 key codes (separated by comma in the table).

Esc	F1	F2	F3	F4	F5	F6	F7	F8	F9	F10	F11	F12	Prnt	ScrL	Brk					
~	1	2	3	4	5	6	7	8	9	0	-	=	Bsp	Ins	Posl	Pgup	Num /	*	-	
tab	q	w	e	r	t	y	u	i	o	p	[]	CR	Del	End	Pgdn	7	8	9	+
Caps	a	s	d	f	g	h	j	k	l	;	'	\					4	5	6	
LShift	z	x	c	v	b	n	m	,	.	?	Rshift				Up		1	2	3	CR
Lctrl	Win	Alt	Space				AltGR	Menu	RCtrl					Left	Down	Right	0	,		

Figure B.1: English (US) Keyboard Layout, used for key codes

Key (and aliases)
0 - 9
A - Z
, TILDE
- , MINUS
= , EQUALS
;
'
< , LESS
,
.
/ , SLASH
BACK SPACE
TAB
[
]
ENTER
CAPS LOCK
\ , BACK SLASH
LSHIFT , SHIFT
RCTRL
RSHIFT
LCTRL , CTRL
LALT , ALT
SPACE
ALTGR
ESCAPE , ESC

F1
F2
F3
F4
F5
F6
F7
F8
F9
F10
F11
F12
PRINTSCREEN
SCROLL LOCK
BREAK
INSERT
HOME
PAGE UP
DELETE
END
PAGE DOWN
UP
LEFT
DOWN
RIGHT
NUM LOCK
NUMPAD0
NUMPAD1
NUMPAD2
NUMPAD3
NUMPAD4
NUMPAD5
NUMPAD6
NUMPAD7
NUMPAD8
NUMPAD9
NUMPADPLUS,NUMPAD PLUS
NUMPAD/
NUMPADMUL,NUMPAD MUL
NUMPADMINUS,NUMPAD MINUS
NUMPADENTER
WINDOWS
MENU

Table B.1: Key Names

C. Video Modes

Table B.1 lists the video modes PS/2 IP-KVM switch supports. Please don't use other custom video settings besides of these. If done so, PS/2 IP-KVM switch may not be able to detect them.

Resolution (x, y)	Refresh Rates (Hz)
640 x 350	70, 85
640 x 400	56, 70, 85
640 x 480	60, 67, 72, 75, 85, 90, 100, 120
720 x 400	70, 85
800 x 600	56, 60, 70, 72, 75, 85, 90, 100
832 x 624	75
1024 x 768	60, 70, 72, 75, 85, 90, 100
1152 x 864	75
1152 x 870	75
1152 x 900	66
1280 x 960	60
1280 x 1024	60, 75

Table C.1 Video mode

Free Manuals Download Website

<http://myh66.com>

<http://usermanuals.us>

<http://www.somanuals.com>

<http://www.4manuals.cc>

<http://www.manual-lib.com>

<http://www.404manual.com>

<http://www.luxmanual.com>

<http://aubethermostatmanual.com>

Golf course search by state

<http://golfingnear.com>

Email search by domain

<http://emailbydomain.com>

Auto manuals search

<http://auto.somanuals.com>

TV manuals search

<http://tv.somanuals.com>