

User's Guide

AXIS Q8108-R Network Video Recorder

ENGLISH



About this Document

This document includes instructions for installing the AXIS Q8108-R Network Video Recorder.

Legal Considerations

Video and audio surveillance can be prohibited by laws that vary from country to country. Check the laws in your local region before using this product for surveillance purposes.

Electromagnetic Compatibility (EMC)

This equipment generates, uses and can radiate radio frequency energy and, if not installed and used in accordance with the instructions, may cause harmful interference to radio communications. However, there is no guarantee that interference will not occur in a particular installation.

If this equipment does cause harmful interference to radio or television reception, which can be determined by turning the equipment off and on, the user is encouraged to try to correct the interference by one or more of the following measures: Re-orient or relocate the receiving antenna. Increase the separation between the equipment and receiver. Connect the equipment to an outlet on a different circuit to the receiver. Consult your dealer or an experienced radio/TV technician for help. Shielded (STP) network cables must be used with this unit to ensure compliance with EMC standards.

USA – This equipment has been tested and found to comply with the limits for a Class B computing device pursuant to Subpart B of Part 15 of FCC rules, which are designed to provide reasonable protection against such interference when operated in a commercial environment. Operation of this equipment in a residential area is likely to cause interference, in which case the user at his/her own expense will be required to take whatever measures may be required to correct the interference.

Europe –  This digital equipment fulfills the requirements for radiated emission according to limit B of EN55022, and the requirements for immunity according to EN55024 residential and commercial industry.

Equipment Modifications

This equipment must be installed and used in strict accordance with the instructions given in the user documentation. This equipment contains no user-serviceable components. Unauthorized equipment changes or modifications will invalidate all applicable regulatory certifications and approvals.

Liability

Every care has been taken in the preparation of this document. Please inform your local Axis office of any inaccuracies or omissions. Axis Communications AB cannot be held responsible for any technical or typographical errors and reserves the right to make changes to the product and documentation without prior notice. Axis Communications AB makes no warranty of any kind with regard to the material contained within this document, including, but not limited to, the implied warranties of merchantability

and fitness for a particular purpose. Axis Communications AB shall not be liable nor responsible for incidental or consequential damages in connection with the furnishing, performance or use of this material.

RoHS

This product complies with both the European RoHS directive, 2002/95/EC, and the Chinese RoHS regulations, ACPEIP.



WEEE Directive

The European Union has enacted a Directive 2002/96/EC on Waste Electrical and Electronic Equipment (WEEE Directive). This directive is applicable in the European Union member states.



The WEEE marking on this product (see right) or its documentation indicates that the product must not be disposed of together with household waste. To prevent possible harm to human health and/or the environment, the product must be disposed of in an approved and environmentally safe recycling process. For further information on how to dispose of this product correctly, contact the product supplier, or the local authority responsible for waste disposal in your area. Business users should contact the product supplier for information on how to dispose of this product correctly. This product should not be mixed with other commercial waste.

Support

Should you require any technical assistance, please contact your Axis reseller. If your questions cannot be answered immediately, your reseller will forward your queries through the appropriate channels to ensure a rapid response. If you are connected to the Internet, you can:

- download user documentation
- find answers to resolved problems in the FAQ database. Search by product, category, or phrases
- report problems to Axis support by logging in to your private support area.

AXIS Q8108-R User's Guide

This user's guide provides instructions for installing the AXIS Q8108-R Network Video Recorder.

- Hardware overview - page 4
- Unit connectors - page 5
- Install the hardware - page 8
- Connect the cables - page 9
- Mounting Hard Disk - page 10
- Set up your computer - page 12
- Technical Specifications - page 15

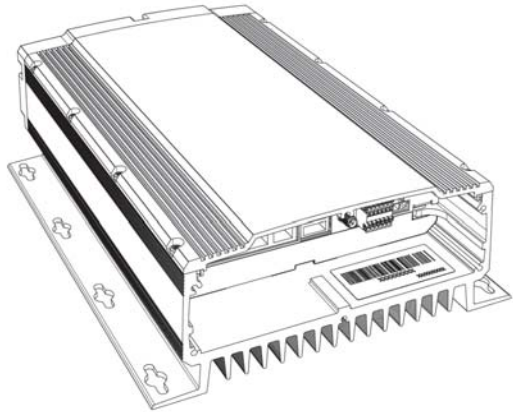

ENGLISH

Important!
 The network video recorder should be installed by a trained professional. Please observe relevant national and local regulations for the installation

Package contents

Item	Models/variants/notes
Network Video Recorder	AXIS Q8108-R
Printed materials	AXIS Q8108-R User's Guide (this document)
Included accessories	Power cable with terminal block, Cable shelf
Not included accessory	Power supply, Cable sealing for IP65 rating

Hardware overview

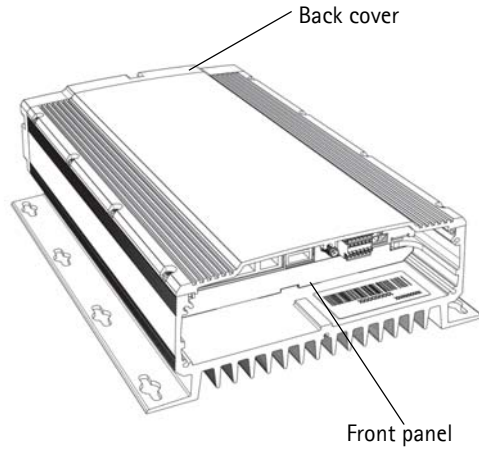

Cable shelf

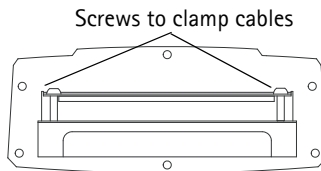

Dimensions

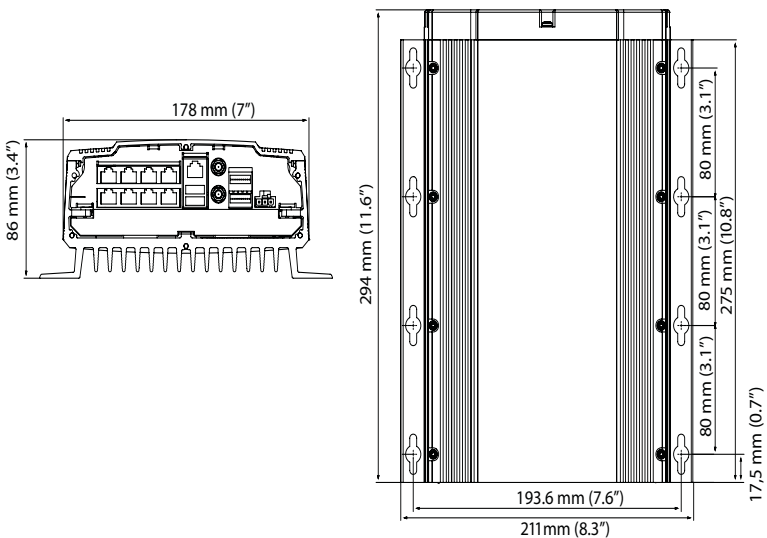

Back

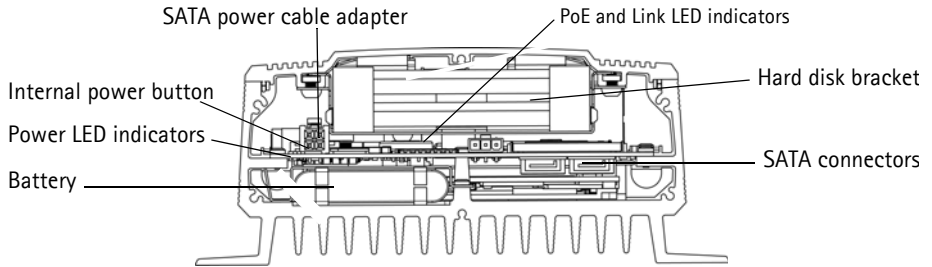

ENGLISH

Front

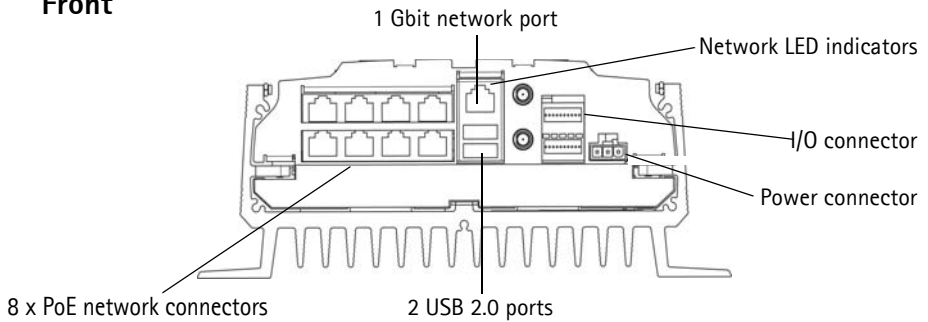

Unit connectors

8 PoE network connectors - RJ-45 Ethernet connectors. Provides power to up to 8 network cameras that are PoE enabled Class 1. The PoE ports are divided into a left and right group of four. A maximum load of 16W is allowed per group. For example, a PoE class 0 can be connected in the left group and up to 4 PoE class 1 can be connected in the right group. If a PoE class 0 is connected, the other ports in the group must not be used. See illustration below and Technical specifications on page 15.

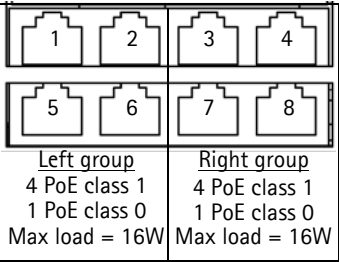
Possible combinations		Left group	Right group	Total
		4 PoE Class 1	4 PoE Class 1	8
		4 PoE Class 1	1 PoE Class 0	5
		1 PoE Class 0	4 PoE Class 1	5
		1 PoE Class 0	1 PoE Class 0	2

Network connector- 1 Gbit port for external network connection.

Power connector- 3-pin terminal block. Use a fused power supply: 12V DC (10A) or 24V DC (5 A)

2 USB 2.0 ports - To be used with any peripheral USB device. Max load = 500mA

I/O connector - 2 digital output ports and 8 digital input ports.

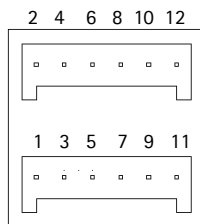
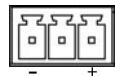

Pin assignment - I/O connector

Pin number	Function	Notes	Specifications
1	Output 1	Open collector NPN transistor with the emitter connected to ground when activated. Outputs are reserved for developer use.	Max load = 500mA
2	Output 2		
3	Input 1	Inactive for voltages less than 1V Active for voltages more than 3V Only one input can be programmed via AXIS NVR manager, see <i>Power Configuration</i> , on page 13	Max input = + 30V
4	Input 2		
5	Input 3		
6	Input 4		
7	Input 5		
8	Input 6		
9	Input 7		
10	Input 8		
11	5V DC Power	Can be used to power auxiliary equipment. Note: This pin can only be used as power out.	Max load = 250mA
12	GND	Ground	

LED indicators

LED	Color	Indication	
Network	Amber	Link established.	
	Green Unlit	Steady for connection to 100 Mbit/s network	
		For connection to 1Gbit/s network	
Power	Green	Power supplied - normal operation.	
	Green and Amber	Battery powered	
	Unlit	Power off	
PoE/Link	Green	Steady	Power is being supplied to the camera
		Flash slowly	Short circuit
		2 flash sequence	Error in PoE connection.
		5 flash sequence	Connected units exceed the max load.
		6 flash sequence	Connected units in the left or right group exceed the max load.
	Amber	Link established	

Install the hardware

Before you begin

There are a few considerations before installing the AXIS Q8108-R.

- The AXIS Q8108-R casing is designed to mount directly on any surface using a minimum of 4 screws appropriate for the surface type
 - The operating temperature range is dependent on the Hard Disk
 - Install in an open area allowing for 10mm of space on all sides for cooling and ventilation
 - Ensure there is proper fuse protection: 12V DC (10A) or 24V DC (5 A)
1. Use at least 4 screws appropriate for the surface. The AXIS Q8108-R is designed to install in any position, but if it is to be installed in a vertical position the cable shelf should be pointing up for optimal heat dissipation.

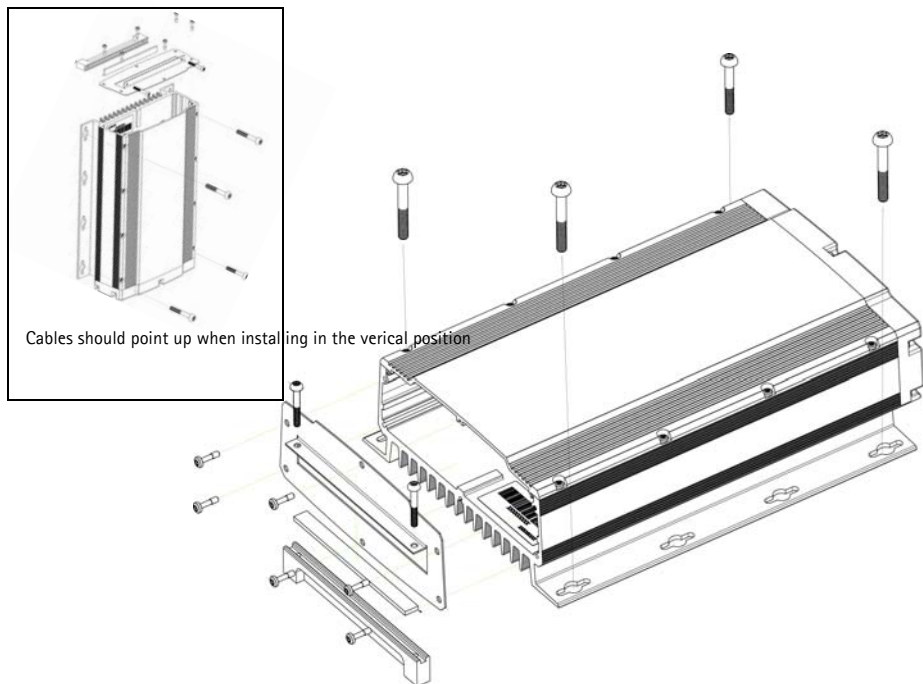

2. Thread the cables through cable shelf. For an IP65 rating use Cable Sealing (not included).
3. Connect all appropriate cables. See *Connect the cables*, on page 9.
4. Attach front cable shelf to AXIS Q8108-R with the four provided screws.
5. Tighten shelf to clamp cables. This prevents connector damage during operation.

Connect the cables

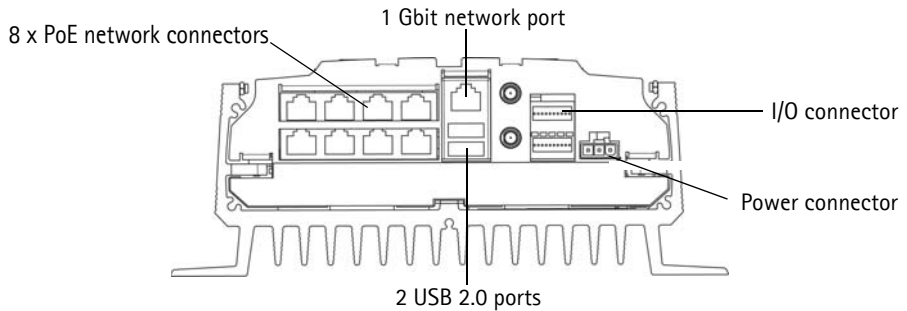

1. Install up to 8 Axis network cameras according to their Installation Guides.
2. Connect cameras to AXIS 8108-R via RJ-45 PoE connectors, which will provide both power and network connection to each camera.
3. Optionally connect external input/output devices.
4. Connect the supplied power cable to the power block.

Mounting Hard Disk

AXIS Q8108-R supports the use of up to 2 separate hard disk. Follow these instructions and consult manufacturer's recommendations to mount or change hard disk.

1. Remove the back cover.
2. Power off the AXIS Q8108-R, see *Start up and shut down*, on page 11 and *LED indicators*, on page 7.
3. Insert hard disks into adapter kit. It's possible to use one 3.5" or up to two 2.5" hard disks.
4. Insert adapter kit with hard disks into the bracket in the lid.
5. Attach the SATA connectors.
6. Power on the device.
7. Replace back cover and tighten screws

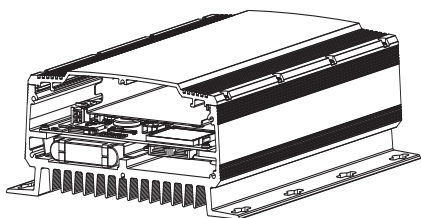

1

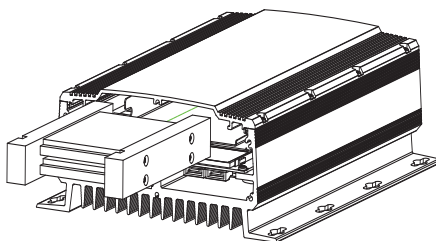

2

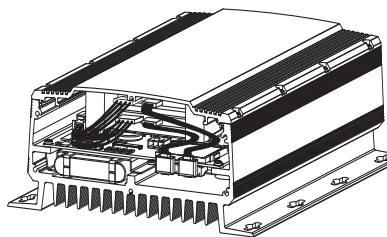

3

Start up and shut down

The AXIS Q8108-R starts up automatically when power is supplied. See *AXIS NVR Manager*, on page 13 for more options. The AXIS Q8108-R automatically does a controlled shut down after one minute when the power is shut off.

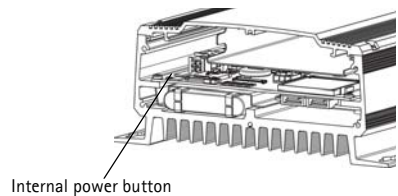

Internal power button

Use this button to manually start up or shut down the AXIS Q8108-R. When pushed briefly the NVR will power down in a controlled manner, which will take 15 – 30 seconds. If the button is held down for more than 3 seconds the NVR will hard power down. This is useful if for some reason the NVR becomes unresponsive.

The internal power button is also used for resetting the NVR to factory default settings, see **Resetting to the factor default settings**.

Battery backup function

The AXIS Q8108-R has an Uninterruptable Power Supply (UPS) designed for short power shortages. For periods more than 1 minute, the UPS will provide enough power to the AXIS Q8108-R for a controlled shut down.

A controlled shutdown may not occur if the battery temperature is outside of charging range 0 - 45°C (32 - 113°F).

Resetting to the factory default settings

This will reset parameters to the factory default settings including the password.

1. Disconnect power from the NVR and remove back cover.
2. Make sure all indicator LEDs are off (this could take a few moments).
3. Press and hold the Internal power button and reconnect power.
4. Release the Internal power button when the power LED is lit.

These settings will be reset:

- Network configuration is set to factory default (DHCP and UPnP™ off)
- Administrator password is set to "password"
- Power Configuration is set to "Automatic"

Resetting the NVR to factory default settings will not affect AXIS Camera Station settings or recordings.

Set up your computer

This section will help you install AXIS NVR Manager and AXIS Camera Station Client and configure it for your Axis NVRs and Axis Network Cameras. A brief introduction to the functionality of the software is covered here. For more information see the context sensitive help files or, for AXIS Camera Station see the User's Manual available at www.axis.com

AXIS NVR Manager is for discovery, configuration and firmware upgrade of AXIS Q8108-R. Go to www.axis.com to download AXIS NVR Manager and follow the install wizard's instructions. Make sure you have full administrator rights on the computer you install on.

AXIS Camera Station Client is for monitoring, recording, playback and event management of Axis network cameras. Launch AXIS Camera Station Client from AXIS NVR Manager and follow the install wizard's instructions or download from www.axis.com.

Minimum recommended requirements for AXIS NVR Manager and AXIS Camera Station Client

PC minimum requirements:

- Memory: 1 GB RAM
- Software: Windows XP SP2, Server 2003 SP2, Vista, Windows 7 (For other operating systems, see www.axis.com/techsup), Microsoft .NET 3.5 (included in installation package)
- Support for DirectX 9.0c

For individual PC requirements for AXIS Camera Station Client refer to the AXIS Camera Station User's Manual.

AXIS NVR Manager

1. Connect to the NVR directly via a network cable or through the network and make sure that power has been applied.
2. Start AXIS NVR Manager.
3. AXIS NVR Manager will automatically discover all NVRs that are in the same network. Note that the NVR startup takes more than a minute and must be completed before it can be discovered.

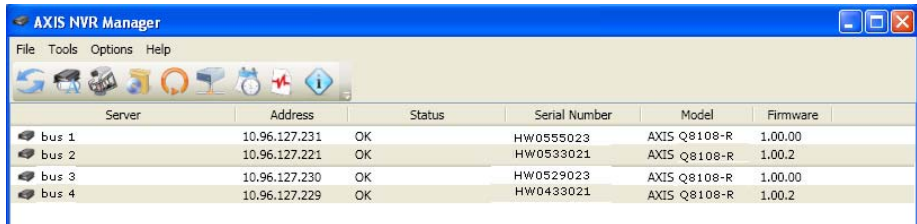

Server	Address	Status	Serial Number	Model	Firmware
bus 1	10.96.127.231	OK	HW0555023	AXIS Q8108-R	1.00.00
bus 2	10.96.127.221	OK	HW0533021	AXIS Q8108-R	1.00.2
bus 3	10.96.127.230	OK	HW0529023	AXIS Q8108-R	1.00.00
bus 4	10.96.127.229	OK	HW0433021	AXIS Q8108-R	1.00.2

Set the password

The default user name is "Administrator" and password is "password". It is strongly recommended that the Administrator password be changed at once to a strong password containing both upper and lower case letters and numbers.

1. Select the NVR in the AXIS NVR Manager window.
2. Go to **Tools > Set Master Credentials**.
3. Enter a strong password.

Network configuration

Network settings can be assigned either automatically or manually. Go to **Tools > Network Configuration**

To access the NVR from behind a router UPnP™ must be enabled in AXIS NVR Manager. Check **Enable UPnP™** under **Network Configuration**. When enabling UPnP™, the NVR needs to be in the subnet as your computer. Make sure that the router is UPnP™ capable and has UPnP™ enabled.

Caution:

For security reasons, enable UPnP™ in order to access the NVR via AXIS NVR Manager or AXIS Camera Station only when the NVR is behind a router that requires NAT traversal.

Power Configuration

To configure how the NVR powers on, go **Tools > Power Configuration**. The AXIS Q8108-R can be configured to power on automatically when external power is available, manually with the internal power button, or when an external button is wired to an input port.

Note:

If power configuration is done incorrectly you might not be able to start the NVR. To remedy this situation go to *Resetting to the factory default settings*, on page 11 and follow the instructions.

AXIS Camera Station

AXIS Camera Station Client is for monitoring, recording, playback and event management.

Connect AXIS Camera Station Client

From AXIS NVR Manager select an NVR device and click the **Launch AXIS Camera Station Client** icon or start AXIS Camera Station Client from your computer and use the NVR's network address in the logon dialog.

Notes:

- If the correct version of AXIS Camera Station Client has not been previously installed on the computer running AXIS NVR Manager, a prompt will appear to perform an installation.
- Prior versions of AXIS Camera Station Client and AXIS Camera Station Server need to be removed from the computer before installing this version. Do not continue with the installation if the removal of prior versions is not your intent.

To log onto the NVR enter the administrator user name and password you set up in NVR Manager see *Set the password*, on page 13.

Configure AXIS Camera Station

For easy navigation AXIS Camera Station is divided into workspaces; **Live view**, **Recordings**, **Logs** and **Configuration**.

- **Live view** - Provides a single interface to organize and monitor AXIS network cameras and video encoders on your network
- **Recordings** - Search, playback and export recordings from one or many cameras in a desired time interval with timeline visualization
- **Logs** - Alarm, event and audit logs for an instant overview of the system
- **Configuration** - has a collection of all the important links to add cameras, set up recording settings, user permissions, event configuration and more

When AXIS Camera Station is started for the first time it automatically adds Axis cameras and video encoders it finds on your network. If there are more cameras on your network than you have a license for, go to **Configuration > Add/Edit Cameras**.

Note:

To use the NVR as an NTP server for the added cameras, use the NVR's IP address.

For more information see the context sensitive help in AXIS Camera Station or the User's Manual.

Technical Specifications

Function/ group	Item	Specification
	Model	AXIS Q8108-R
System	Processor	1.1GHz Intel Atom Z5 series CPU
	RAM	1GB SODIMM DDR2
	System disk	Compact Flash PATA drive 4GB
	Operating system	Windows Embedded Standard 2009
	Battery backup	Controlled shutdown 1 minute after power loss
Network	Security	Password protection, user access log
	NTP	NTP server included
Software	Video Management Software	AXIS Camera Station, 8-channel license included. For more information, see www.axis.com/products/cam_station_software
	Application Programming Interface	Open API for software integration
	Video compression	H.264 (MPEG-4 Part 10/AVC), MPEG-4 Part 2, Motion JPEG
	Audio compression	AAC,G.711, G.726
	Resolutions	Supports connected Axis video product resolutions
	Recording frame rate	Supports connected Axis video product frame rates (Maximum total recording bit rate 70 Mb/s)
General	Casing	Rugged IP43 rated aluminum casing
	Input voltage	12 or 24V DC
	Max power	84 W
	PoE output	8 PoE class 1, or 1 PoE class 0 + 4 PoE class 1, or 2 PoE class 0
	Connectors	2x high speed USB ports, 1x Gbit port for external connection, 8 RJ-45 10BASE-T/100BASE-TX PoE, 2 digital output ports and 8 digital input ports, 2 SATA connectors
	Operating Temperatures	-10 to 50 °C (14 - 122 °F)
	Weights	3.7 kg (8.14 lb)

Function/ group	Item	Specification
	Approvals	EU directive 2002/96/EC, MIL STD-810F Method 516.5 Procedure I, MIL STD-810F method 514.5, EN 55022, EN 55024, EN 61000-4-2, ISO 11452-2, EN 61000-4-3, ISO 11452-2, EN 61000-4-4, EN 61000-4-5, EN 61000-4-11, ISO 7637-2, EN50121-3-2, FCC part 15 subpart B class B
	Project customization	WLAN 802.11b/g, GSM/UMTS/HSDPA, GPS, Accelerometer

User's Guide

Ver.1.0

AXIS Q8108-R

Printed: August 2010

© Axis Communications AB, 2010

Part No. 39382

Free Manuals Download Website

<http://myh66.com>

<http://usermanuals.us>

<http://www.somanuals.com>

<http://www.4manuals.cc>

<http://www.manual-lib.com>

<http://www.404manual.com>

<http://www.luxmanual.com>

<http://aubethermostatmanual.com>

Golf course search by state

<http://golfingnear.com>

Email search by domain

<http://emailbydomain.com>

Auto manuals search

<http://auto.somanuals.com>

TV manuals search

<http://tv.somanuals.com>