



CLASSIC-LINE PROOFER HEATER

Model Number: CPH70-MP17

Innovative Foodservice Equipment Custom Designed for Performance, Service and Value.

INSTALLATION AND OPERATING INSTRUCTIONS



P/N N138574 3/07

Phone: +1 (214) 421-7366
Fax: +1 (214) 565-0976
Toll Free: +1 (800) 441-1601
Website: www.BevLes.com
E-mail: sales@BevLes.com

BevLes
729 Third Avenue
Dallas, TX 75226

TABLE OF CONTENTS

SECTION	PAGE
DELIVERY & FREIGHT CLAIMS	3
DELIVERY	3
Review of Received Goods	3
FREIGHT CLAIMS	3
Inspection	3
INTRODUCTION	3
WARNING LABELS AND SAFETY INSTRUCTIONS	4
Recognize Safety Information	4
Understand Signal Words	4
Avoid Injury	4
Emergency Preparation	4
Follow Safety Instructions	5
Safety & Warning Labels	5
Label Locations	5
ELECTRICAL	6
Electrical Rating	6
Electrical Connection	6
LOCATION	6
OPERATING PROCEDURES	6
Control Panel Configuration	6
To Operate as a Heated (Holding) Cabinet	7
To Operate as a Proofing Cabinet	7
Heat and Moisture (Secondary Control)	8
CLEANING PROCEDURES	8
Ledge Removal	8
Holding or Proofing Assembly Removal	8
Drip Trough Draining and Removal	9
Air Tunnel Removal	9
Exterior Cleaning	10
Interior Cleaning	10
Moving Cabinet	10
TROUBLESHOOTING	11
WIRING DIAGRAMS	12
120V, 60Hz, 1 Ph	12
220-204V, 50Hz, 1 Ph	13
WARRANTY	14
Domestic Warranty	14
International Warranty	15

DELIVERY AND FREIGHT CLAIMS

DELIVERY

REVIEW OF RECEIVED GOODS:

1. Observe shipping carton for obvious shipping damage.
2. Note concerns while delivery party is present (see freight claims).
3. Unpack the unit and inspect for shipping damage. Notify manufacturer immediately if there is any shipping damage found

FREIGHT CLAIMS

INSPECTION:

You are responsible for all claims. It is vitally important that upon arrival, all cartons and crates are inspected for visible damage. If at all possible, cartons and crates should be opened immediately to check for concealed damaged within. All cartons and crates must be saved until the unit is completely removed from the carton so concealed damage claims can be filed.

You, as the consignee, must file freight claims with the delivering truck line. If there is any question whatsoever regarding the condition of the equipment, this question should be noted on the bill of lading, which you sign as a delivery receipt.

All shortages must be noted on the bill of lading as the shipment is received. If a bill of lading is signed as complete for the delivering truck driver, there is virtually no way to secure a claim for shortages which are found later.

INTRODUCTION

THANK YOU for purchasing your new Classic-Line Proofer Heater. This unit provides the means to maintain previously heated food at a prescribed holding temperature and is also used to proof bakery products at precise heat and humidity conditions.

NOTE:

Read this manual carefully before beginning installation and/or operation to avoid personal injury or damage.

This manual is a necessary and permanent part of the unit. Always keep it accessible.

This manual covers basic installation and use. If you need additional information, contact our customer service department for assistance.

If this manual or any of the warning labels are marred or destroyed, contact **manufacturer** to replace them.

Locate the serial number plate. Write the 12-digit serial number below. Your dealer needs this number when you order parts.

Serial Number _____

WARNING LABELS AND SAFETY INSTRUCTIONS

RECOGNIZE SAFETY INFORMATION









This is the safety alert symbol. When you see this symbol on your equipment or in this manual be alert to the potential for personal injury or damage to your unit.

Be sure you understand all safety messages and always follow recommended precautions and safe operating practices.



UNDERSTAND SIGNAL WORDS

Important safety information is presented in this section and throughout the manual. These signal words are used in the warnings and safety messages.

	DANGER: Severe injury or death will occur if you ignore the message.	
	WARNING: Severe injury or death can occur if you ignore the message.	
	CAUTION: Minor injury or damage can occur if you ignore the message. CAUTION also calls attention to safety messages in this manual	
	NOTICE: This is important installation, operation or maintenance information that you should pay special attention to. If you ignore this information, you may damage your unit.	

AVOID INJURY FROM HIGH VOLTAGE ELECTRICAL SHOCK

Disconnect power before cleaning or servicing the unit. Do not spray with water or steam. Use a damp cloth to clean.

Be sure outlet is grounded:

- Check ground pin on plug
- Do not use if pin is bent or missing
- Never remove ground pin from plug

PREPARE FOR EMERGENCIES

Be prepared if a fire starts.
Keep a first aid kit and fire extinguisher handy.

Keep emergency numbers for doctors, ambulance service, hospital and fire department near your telephone.

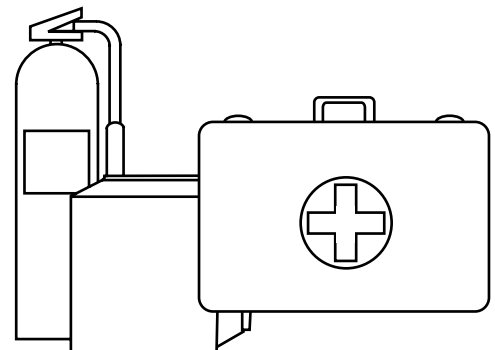
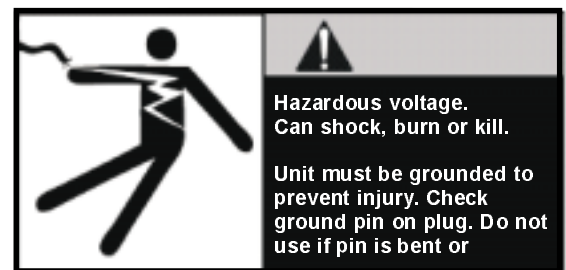
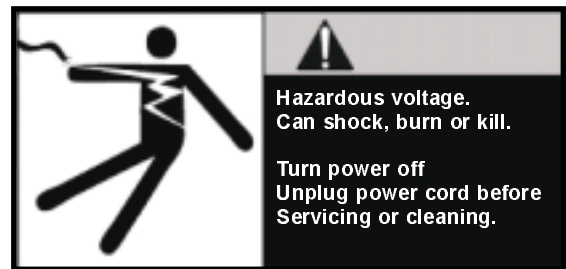

FOLLOW SAFETY INSTRUCTIONS

Carefully read all safety messages in this manual and safety signs on your equipment. Keep safety signs in good condition. Replace any missing or damaged safety signs.

Learn how to operate the equipment and how to use the controls properly. Do not let anyone operate without instruction and proper training.

Keep your equipment in proper working condition. Unauthorized modifications to the equipment may impair the functions and/or safety and reduce equipment life.

SAFETY AND WARNING LABELS

LABEL LOCATIONS:

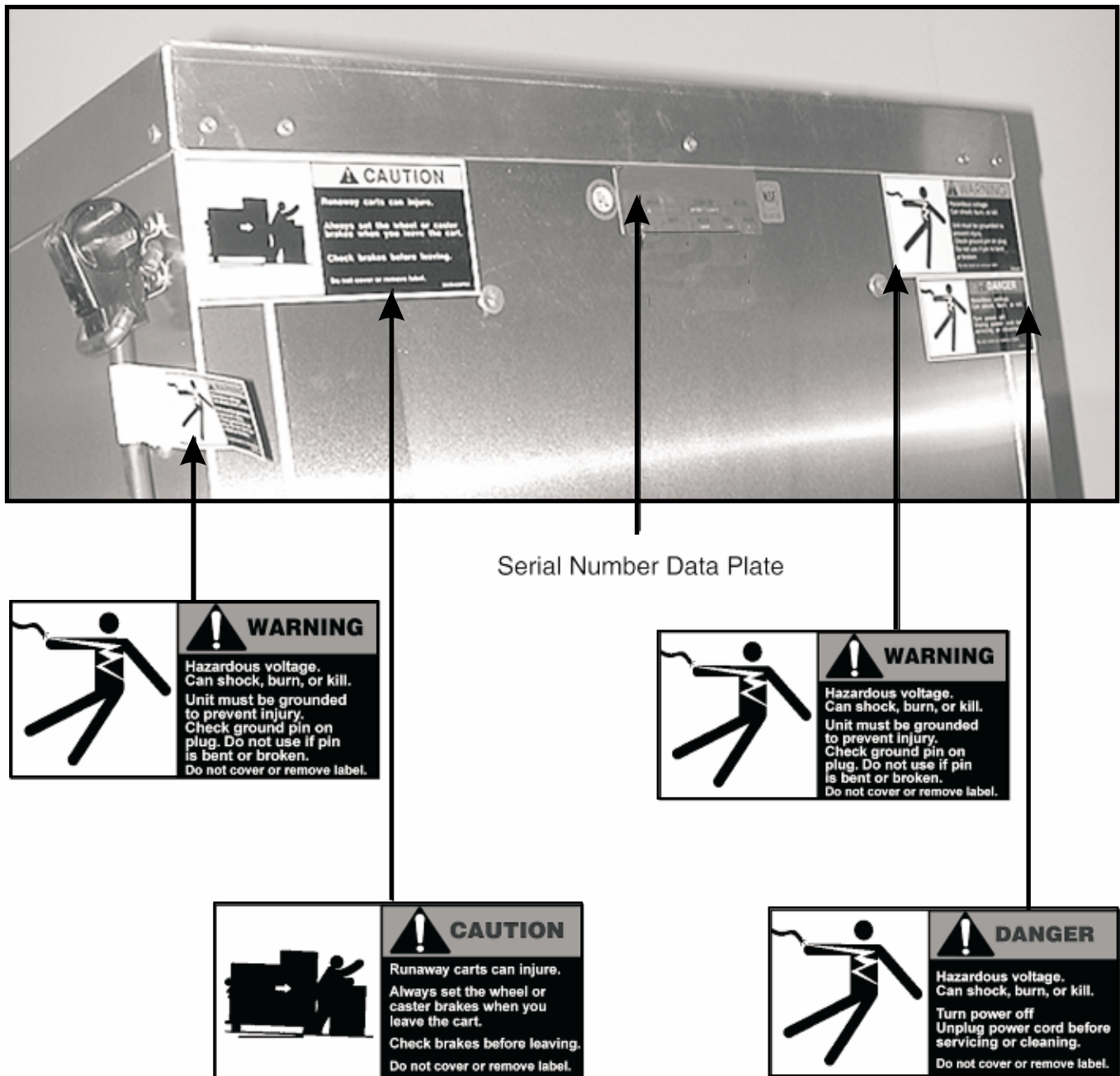

ELECTRICAL

ELECTRICAL RATING

For models equipped with 120V, 60HZ, 1PH ELECTRICAL CONNECTION:

The cabinet heating unit has a 2000-watt heating element and requires a 20-amp circuit. If required circuit is not available, wiring should be performed by a qualified and certified electrician.



**NEMA 5-20R
20 AMP RECEPTACLE**

For models equipped with 220V, 50HZ, 1PH ELECTRICAL CONNECTION:

Equipped with a female "IEC 60320 C20" Power inlet which accommodates various power cord configurations for applicable country. The cabinet heating unit has a 2000-watt heating element and requires a 9-amp circuit.



IEC 60320 C20 POWER INLET (9 amp)
*NOTE: Be sure unit is grounded.
Check ground connection. Do not use
if unit is not grounded.*

LOCATION

Your unit should be located to provide easy access, without restrictions. Factory installed door opens from left to right. Provisions for mounting door to open from right to left are incorporated.

Electrical outlet must be less than (6) ft. from unit operating position. Avoid enclosed or confined locations, which will restrict air circulation.

Electrical Cord Holder Installation

- 1.) Locate and remove cord holder bracket on top of heater body inside cabinet. See figure 1.
- 2.) Remove (2) screws from upper right rear of cabinet for later installation See figure 2.
- 3.) Install bracket with (2) screws and tighten. See figure 3. Completed install see figure 4.



Figure 1



Figure 2

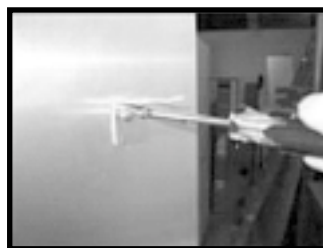

Figure 3



Figure 4

OPERATING PROCEDURES

CONTROL PANEL CONFIGURATION

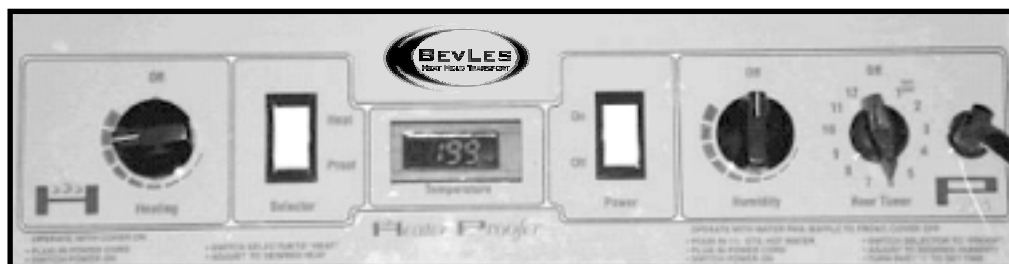

TO OPERATE AS A HEATED (HOLDING) CABINET:

- Operate without pan but with the cover on.
- Flip power switch upward to the “On” position.
- Flip selector switch upward to “Heat” position.
- Turn the “Heating” knob to maintain desired holding temperature.



TO OPERATE AS A PROOFING CABINET:

! DANGER: Do not overfill pan with water, this can cause electrical shock. Disconnect power prior to filling pan while power cord is plugged in. **!**

Fill the pan with 1-1/2 quarts of hot water. The pan is partially full. (Too much water can cause longer proofing time.)

- Plug the cord set into properly grounded three- prong outlet.
- Flip power switch upward to the “On” position. Flip selector switch down and to “Proof” position. Turn the humidity knob to maintain 95°F (see chart for proper setting).
- Preheat cabinet for 20-30 minutes. The cabinet door should be 1/2 3/4 covered with moisture.



TYPICAL PROOFING PREPARATION:

- Grease pan. Place frozen buns on a bun pan (18 x 26), brush tops of buns with vegetable oil and refrigerate until dough thaws and reaches 40°F (4-6 hours or overnight).
- One condition that is important during thawing is after the rolls are panned, the tops of the rolls must not “crust” or dry out. This can be prevented by oiling the tops of the rolls and covering them very lightly with film wrap.
- The overwrap must not be tucked in at the sides, merely laid on top of the greased dough.
- **NOTE:** Do not cover dough during proofing.

FRESHLY PREPARED DOUGH

# Of Buns	Dough Temp.	Proof Time	Cabinet Temp.
1 to 10	Room Temp.	30 min.	90-95°F
10 to 20	Room Temp.	33 min.	90-95°F
20 to 30	Room Temp.	35 min.	90-95°F
30 to 40	Room Temp.	38 min.	90-95°F
40 to 50	Room Temp.	40 min.	90-95°F

REFRIGERATED DOUGH

# Of Buns	Dough Temp.	Proof Time	Cabinet Temp.
1 to 10	30° - 45°F	35 min.	90-95°F
10 to 20	30° - 45°F	39 min.	90-95°F
20 to 30	30° - 45°F	43 min.	90-95°F
30 to 40	30° - 45°F	46 min.	90-95°F
40 to 50	30° - 45°F	50 min.	90-95°F

HEAT AND MOISTURE (SECONDARY CONTROL):

Heat and/or moisture can be further controlled by sliding damper, located at top of cabinet, left or right to desired opening.



CLEANING PROCEDURES

LEDGE REMOVAL:

- Lift up and out of holes in ledge uprights.

HEATER ASSEMBLY REMOVAL:

- Open door and allow sufficient time for cool down.
- Unplug heater cord from receptacle.
- Carefully slide heating unit forward. (If in proofing mode and pan has water remaining, avoid water movement to prevent spillage. After unit is totally out and on a stable surface, remove water pan and pour out remaining water.)



When returning heater assembly to its operating position, be sure to line up back end with bottom of louvered air tunnel. (If returning unit to proofing mode, add water only after unit is fully inserted and in operating position.)



DRIP TROUGH DRAINING AND REMOVAL:

DRAINING:



Open drain trough by pushing clamp tab upward.



Close by pushing front of clamp inward.

REMOVAL:

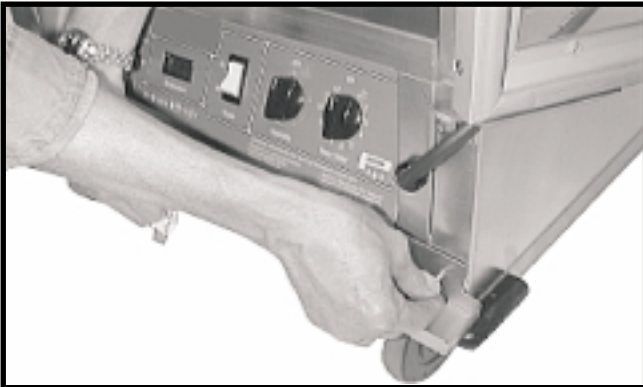

To remove trough: remove thumbscrews; drop trough down and pull forward.

AIR TUNNEL REMOVAL:

The louvered air tunnel hangs on shoulder rivets, through tear drop slots, at back of cabinet.

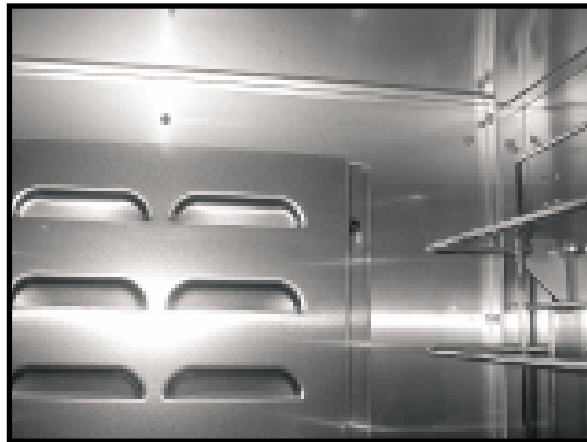

Grasp air tunnel and lift up and off.

EXTERIOR CLEANING:



CAUTION: Use only cleaners for stainless steel or aluminum: Fantastic, 409, Scotchbrite, dish washing products are recommended. Follow all directions for safe use of these products.



CAUTION: Do not use steel wool or other abrasive cleaners. Do not use cleaners or sanitizers containing lye, chlorine, iodine, ammonia or bromine as these will damage the finish on the stainless steel.



Refer to "**CAUTIONS**" above when preparing and using cleaning solution.

- Dip towel in cleaning solution
- Wipe down exterior of unit.

DO NOT pressure wash, hose-down, immerse, or spray the cabinet or any part of it. Follow with a clean damp cloth to remove residual cleaning solution. Allow surfaces to air dry. Wipe exterior with towel and stainless steel polish (or towel and lemon oil). Polish with a clean, soft cloth.

INTERIOR CLEANING:



CAUTION: Use only cleaners for stainless steel or aluminum: Fantastic, 409, Scotchbrite, dish washing products are recommended. Follow all directions for safe use of these products.



CAUTION: Do not use steel wool or other abrasive cleaners. Do not use cleaners or sanitizers containing lye, chlorine, iodine, ammonia or bromine as these will damage the finish on the stainless steel.



CAUTION: Disconnect cord set from power supply before cleaning.

DO NOT use abrasives or harsh chemicals.

- Open door all the way.
- Remove ledge assemblies.
- Remove holding or proofing unit, drip trough and air tunnel.
- Clean holding or proofing unit.
DO NOT spray electric heat unit with water or steam. Wipe with a damp cloth.
(Be sure electric cord is **NOT** plugged into power source.)
- Wipe interior of unit with a towel and detergent solution.
- **DO NOT** pressure wash, hose-down, immerse, or spray the cabinet or any part of it. Remove detergent residue with a clean damp towel. Allow surfaces to air dry.

MOVING CABINET:

- Make sure door is secured before moving cabinet.
- Unplug electrical cord before moving cabinet.
- Empty water from proofing pan, if applicable.
- Remove drip trough and pour out condensation before moving, if applicable.

TROUBLESHOOTING



DANGER: The following work is to be performed only by a licensed electrician. There is hazardous voltage which can shock, burn or kill. Turn power off. Unplug power cord before service or cleaning.



Problem:	Probable Cause:	Solution:
Unit will not run (heater and fan are off)	Power cord is not plugged in	Plug in power cord
	Circuit breaker is tripped	Call a licensed electrician
	No power at outlet	Call a licensed electrician
	Defective power cord or switch	Call a licensed service agency or a licensed electrician
Compartment too cold	Check door	Instruct user to keep door closed
	Poor door seal	Check door seal and replace if necessary
	Thermostat setting is too low	Turn thermostat knob to a warmer position. This should be done one increment at a time until a satisfactory temperature is obtained
	Defective thermostat	Check thermostat. If necessary, call a licensed service agency or a licensed electrician
Compartment too hot	Thermostat setting is too high	Turn thermostat knob to a cooler position. This should be done one increment at a time until a satisfactory temperature is obtained
	Defective thermostat	Check thermostat. If necessary, call a licensed service agency or a licensed electrician
No humidity	No water in pan	Add hot water
	Selector Switch on heat	Switch to Proof Mode
	Humidity thermostat set too low	Adjust thermostat (usually 1/4 to 1/3 of full range)

WIRING DIAGRAM CPH70-MP17 CLASSIC-LINE PROOFER HEATER - 120V, 60Hz, 1Ph

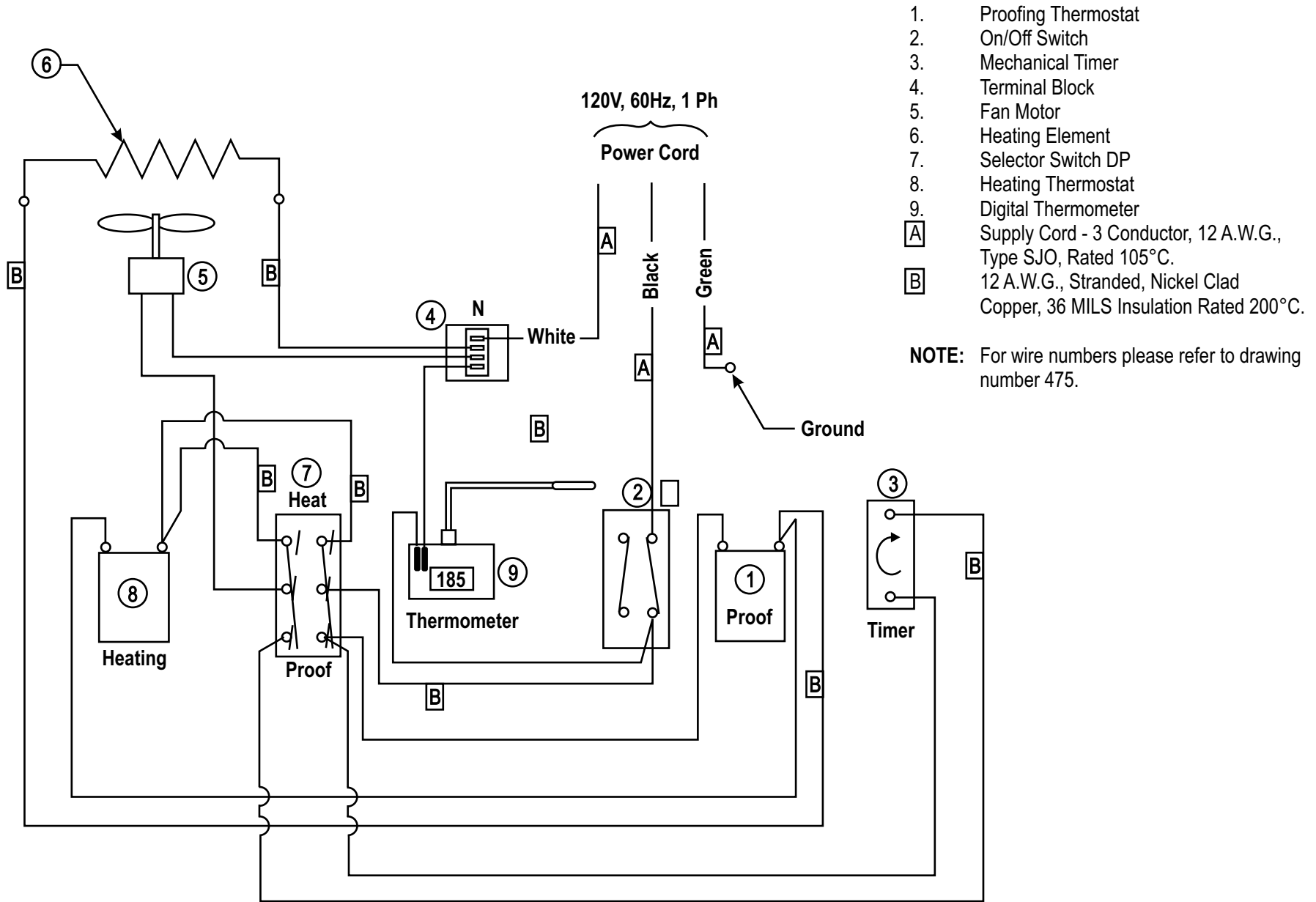

1. Proofing Thermostat
 2. On/Off Switch
 3. Mechanical Timer
 4. Terminal Block
 5. Fan Motor
 6. Heating Element
 7. Selector Switch DP
 8. Heating Thermostat
 9. Digital Thermometer
- [A] Supply Cord - 3 Conductor, 12 A.W.G., Type SJO, Rated 105°C.
- [B] 12 A.W.G., Stranded, Nickel Clad Copper, 36 MILS Insulation Rated 200°C.

NOTE: For wire numbers please refer to drawing number 475.

WIRING DIAGRAM CPH70-MP17 CLASSIC-LINE PROOFER HEATER - 220-240V, 50Hz, 1Ph

220-240V, 50Hz, 1 Ph
Power Cord

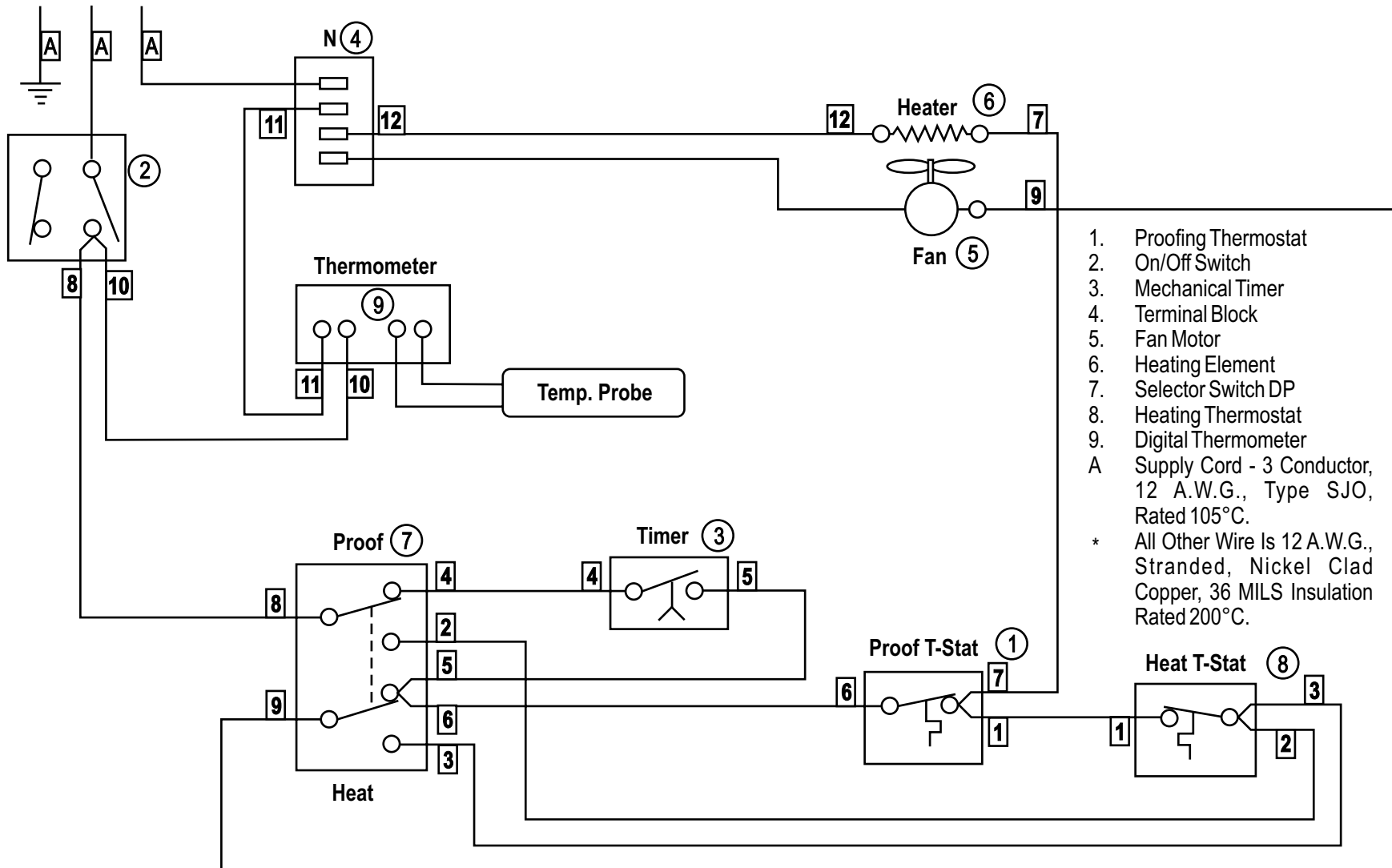



BEVLES COMPANY LIMITED WARRANTY

729 Third Avenue * Dallas, TX 75226

Phone: +1 (214) 421-7366 Fax: +1 (214) 565-0976

Domestic Warranties and Service

1. Bevles warrants to the original purchaser that on the date the equipment is shipped (sold), it will be free of defects in materials or workmanship. Bevles will, at its discretion, repair or replace, during the warranty period printed below, any part that has a defect in material or workmanship that was present when the product shipped from Bevles, and which manifests itself during the warranty period under normal use and service.
 - Parts: Two* years from date of original shipment from the Bevles factory.
 - Labor: One** year from date of original shipment from the Bevles factory.

* Air Circulation Blower Assemblies (motors) and Power Switches shall be one year from date of original shipment.

Calrod "Air" Heating Elements shall be three years from date of original shipment.

** All electrical components 120 days from date of original shipment.
2. Bevles must be contacted, and pre-approval must be issued by the Bevles factory prior to any type of service being performed. Bevles assumes no responsibility for any charges that were not expressly authorized by the Bevles factory, or for any charges that exceed, in Bevles' sole judgement, normal and customary amounts.
3. Bevles will pay UPS Ground charges for any part that has a defect in material or workmanship that was present when the product shipped from Bevles, and which manifests itself during the **first year** of the warranty period under normal use and service. All warranty replacement parts will ship F.O.B. Bevles factory, Cheyenne, WY 82007.
4. This warranty shall be void in its entirety if any abuse of, misuse of, alteration/modification of or improper maintenance of original product occurs. If, at any time a claim is reported to Bevles, and the purchaser is delinquent in payment for the product, warranty will not apply.
5. Buyer's Remedies-If a Bevles product fails due to a defect in material or workmanship in conformity with the warranties in paragraph one, buyers shall notify Bevles of such failure within a reasonable time, but in no event beyond fifteen (15) days of such discovery of defect in material or workmanship. Bevles shall provide, in its sole discretion, either the repair or replacement of any defective or any non-conforming part. Bevles specifically disavows any other representation, warranty or liability relating to the continued use of the product.
6. Exclusion of consequential and incidental damages-In no event shall Bevles be liable for any incidental, special, indirect, or consequential damages, whether resulting from non-delivery or from the use, misuse, or inability to use the product, or from defects in the product, or from Bevles' own negligence or other tort. This exclusion applies regardless of whether such damages are sought for breach of warranty, breach of contract, negligence, or strict liability in tort or under any other legal theory.
7. Disclaimer of warranties-The warranties contained in paragraph one above are the exclusive warranties given by Bevles and supersede any prior, contrary, or additional representations, whether oral or written. Bevles hereby disclaims and excludes all other warranties-whether expressed, implied, or statutory-including any warranty of merchantability, any warranty of fitness for a particular purpose, and any implied warranties otherwise arising from course of dealing or usage of trade.

1/05



BEVLES COMPANY LIMITED WARRANTY

729 Third Avenue * Dallas, TX 75226

Phone: +1 (214) 421-7366 Fax: +1 (214) 565-0976

International Warranties and Service

What is Covered

This warranty covers defects in components (Parts) under normal use, and applies only to the original purchaser providing that:

- The equipment has not been damaged, altered or misused.
- The equipment is properly installed, adjusted, operated and maintained in accordance local codes and in accordance with the installation instructions provided with the product.
- The serial number rating plate affixed to the equipment has not been defaced or removed.

Who is Covered

This warranty is extended to the original purchaser and applies only to equipment purchased for International use only.

Coverage Period

One year and 3 months (15 months) limited parts replacement only.

Warranty Coverage

This warranty covers replacement parts only. No labor, travel time or travel expenses are included or implied. The purchaser shall be responsible for all expenses related to travel, mileage and shipping costs.

Exclusions

- **Glass**
- **Light bulbs**
- **Plastic components**
- **Accessories**

This warranty is in lieu of all other warranties, expressed or implied, and all other obligations or liabilities on the manufacturers part. BevLes, shall in no event be liable for any special, indirect or consequential damages, or in any event for damages in excess or the purchase price of the unit. The replacement of proven defective purchase parts shall constitute a fulfillment of all obligations under the terms of this warranty.

All warranty service should be coordinated through the Customer Service Department at BevLes (214) 421-7366.

When requesting parts identification, always specify: Model Number, Serial Number, Type of gas or voltage, Phase and Wattage.

3/14/07



Phone: +1 (214) 421-7366
Fax: +1 (214) 565-0976
Toll Free: +1 (800) 441-1601
Website: www.BevLes.com
E-mail: sales@BevLes.com

BevLes
729 Third Avenue
Dallas, TX 75226

Free Manuals Download Website

<http://myh66.com>

<http://usermanuals.us>

<http://www.somanuals.com>

<http://www.4manuals.cc>

<http://www.manual-lib.com>

<http://www.404manual.com>

<http://www.luxmanual.com>

<http://aubethermostatmanual.com>

Golf course search by state

<http://golfingnear.com>

Email search by domain

<http://emailbydomain.com>

Auto manuals search

<http://auto.somanuals.com>

TV manuals search

<http://tv.somanuals.com>