



R5976214
user's manual

VISU^{PLUS}
Video Insertion Unit

R5976214, Current Version

Title: VISU^{PLUS} – User's Manual

ID-no.: R5976214

Release: June 2003

	main issue	update
chapter 1		
chapter 2	add	
chapter 3	add	
chapter 4		
chapter 5		
chapter 6	corr.	
chapter 7	add	
chapter 8		
chapter 9		

new: The corresponding chapters are new or completely revised.

corr.: Passages of the corresponding chapter were corrected; see modification bars.

add.: Passages of the corresponding chapter were added; see modification bars.

This manual refers to following hardware and software configurations of VISU^{PLUS} containing the following most current components with order codes:

R9830602	VISU ^{PLUS} base unit
R9842140	digital output unit DVI
R9830621	analog output unit, to be used in VISU ^{PLUS} – EOS setup
R9830623	analog output unit, to be used in VISU ^{PLUS} stand alone setup
R9830611	video input unit
R9830646	RGB input unit, compatible with XGA and SXGA
R7626275	processor board

Document History

Modifications which result in a new version are indicated by a vertical bar.

Trademarks

Brand and product names mentioned in this manual may be trademarks, registered trademarks or copyrights of their respective holders. All brand and product names mentioned in this manual serve as comments or examples and are not to be understood as advertising for the products or their manufacturers.

Copyright © 1998, 1999, 2000 by BARCO

Die Weitergabe sowie die Vervielfältigung aller Unterlagen, die von uns überlassen werden, deren Verwertung und Mitteilung ihres Inhaltes an Dritte ist nicht gestattet, soweit dies nicht ausdrücklich zugestanden ist. Urheberrechte, insbesondere auch solche an Software, werden nur insoweit übertragen, als es für die Erreichung des speziellen Vertragszwecks erforderlich ist. Zuwiderhandlungen können zu Schadensersatz verpflichten. Alle Rechte aus der Erteilung eines Patents oder der Eintragung eines Gebrauchsmusters verbleiben bei uns.

Copyright © 1998, 1999, 2000 by BARCO

All rights reserved. No part of this document may be copied, reproduced or translated. It shall not otherwise be recorded, transmitted or stored in a retrieval system without the prior written consent of the BARCO.

Guarantee and Compensation

BARCO provides a guarantee relating to perfect manufacturing as part of the legally stipulated terms of guarantee. On receipt, the purchaser must immediately inspect all delivered goods for damage incurred during transport, as well as for material and manufacturing faults. BARCO must be informed immediately in writing of any complaints.

The period of guarantee begins on the date of transfer of risks, in the case of special systems and software on the date of commissioning, at the latest 30 days after the transfer of risks. In the event of justified notice of complaint, BARCO can repair the fault or provide a replacement at its own discretion within an appropriate period. If this measure proves to be impossible or unsuccessful, the purchaser can demand a reduction in the purchase price or cancellation of the contract (redhibition). All other claims, in particular those relating to compensation for direct or indirect damage, and also damage attributed to the operation of software as well as to other services provided by BARCO, being a component of the system or independent services, will be deemed invalid provided the damage is not proven to be attributed to the absence of properties guaranteed in writing or due to the intent or gross negligence on the part of BARCO.

If the purchaser or a third party carries out modifications or repairs on good delivered by BARCO, or if the goods are handled incorrectly, in particular if the systems are commissioned or operated incorrectly or if, after the transfer of risks, the goods are subject to influences not agreed upon in the contract, all guarantee claims of the purchaser will be rendered invalid. Not included in the guarantee coverage are system failures which are attributed to programs or special electronic circuitry provided by the purchaser, e. g. interfaces. Normal wear as well as normal maintenance are not subject to the guarantee provided by BARCO either.

The environmental conditions as well as the servicing and maintenance regulations specified in this manual must be complied with by the customer.

Revision sheet

To:

► **Barco Control Rooms GmbH**
An der Rossweid 5, D-76229 Karlsruhe
Phone: +49-721-6201-0, Fax: +49-721-6201-298
E-mail: docu.de.bcd@barco.com, Web: <http://www.barcocontrolrooms.com>

From: _____

Date: _____

Please correct the following points in this documentation (**R5976214**):

page	wrong	correct

Contents

1 Introduction	1-1
1.1 How this manual is organized	1-2
1.2 Styles and Symbols	1-3
1.3 Safety Instructions	1-4
1.3.1 Precautions	1-4
1.3.2 Unpacking of Devices	1-6
1.3.3 Installation	1-6
1.3.4 Servicing	1-6
1.3.5 Cleaning	1-6
1.3.6 Re-Packing	1-6
2 Summary	2-1
2.1 Properties	2-2
3 Getting Started	3-1
3.1 Examining	3-2
3.1.1 VISU ^{PLUS}	3-2
3.1.2 Control PC for VISU ^{PLUS} Standalone	3-4
3.2 Cabling	3-5
3.2.1 Power Supply	3-5
3.2.2 Digital Output Unit (DVI)	3-6
3.2.3 Digital Output Unit MDR26	3-8
3.2.4 Analog Output Unit	3-9
3.2.5 Video Input Unit	3-11
3.2.6 RGB Input Unit	3-12
3.2.7 Processor Board	3-13
3.3 Starting Up	3-16
3.3.1 Connecting	3-16
3.3.2 Switching on	3-20
3.3.3 Switching off	3-20
4 Operating	4-1
4.1 Display Capabilities	4-2
4.1.1 Video Input Unit	4-3
4.1.2 RGB Input Unit (SXGA)	4-4
4.1.3 Output Units	4-5
4.1.4 Video Switcher	4-6
4.2 Operation	4-7
5 Maintenance	5-1
5.1 Exchange of Consumables	5-2
5.1.1 Replacing the Filter Pad of VISU ^{PLUS}	5-2
5.2 Cleaning	5-2
6 Command Reference	6-1

6.1 Introduction	6-2
6.2 Notation Conventions.....	6-2
6.3 VISU ^{PLUS} Internals.....	6-3
6.4 VISU ^{PLUS} Operation Protocol	6-4
6.4.1 Error / Info messages.....	6-4
6.4.2 Return value.....	6-4
6.4.3 ACK / NACK	6-4
6.5 Commands.....	6-5
6.5.1 <CR>	6-6
6.5.2 SET_BAUDRATE	6-6
6.5.3 AUTO_CONFIG	6-6
6.5.4 VERBOSE	6-7
6.5.5 HW_SET_PARAM / HW_GET_PARAM	6-7
6.5.6 OPU_SET_POS.....	6-9
6.5.7 OPU_SET_PARAM / OPU_GET_PARAM.....	6-10
6.5.8 IPU_LNK_TO_WIN	6-10
6.5.9 WIN_LNK_TO_SRC	6-11
6.5.10 WIN_SET_POS.....	6-11
6.5.11 WIN_SET_VIEWPORT	6-12
6.5.12 WIN_BRING_TO_TOP.....	6-12
6.5.13 WIN_SHOW.....	6-12
6.5.14 WIN_SET_PARAM / WIN_GET_PARAM.....	6-13
6.5.15 SRC_SET_PARAM / SRC_GET_PARAM.....	6-14
6.5.16 ENABLE_UPDATE.....	6-16
6.5.17 TRY_ENABLE_UPDATE.....	6-17
6.5.18 VERSION.....	6-17
6.6 Way of operations	6-18
7 Technical Appendix	7-1
7.1 Technical Data.....	7-2
7.2 Interfaces	7-6
7.3 Order Codes.....	7-11
8 Troubleshooting	8-1
8.1 Communication to VISU ^{PLUS} Fails.....	8-2
8.2 Hot Line.....	8-3
9 Index.....	9-1
9.1 Table of Tables	9-1
9.2 Table of Figures.....	9-2

1 Introduction

This chapter explains the structure of the manual itself and the used typographic styles and symbols. Safety information is provided concerning the operation of computer systems from BARCO.

1.1 How this manual is organized

This manual describes design and startup of VISU^{PLUS} Video Insertion Unit from BARCO. It is divided into nine chapters:

- ▶ **Introduction**
explains the structure of the manual itself and the used typographic styles and symbols. Safety information is provided concerning the operation of computer systems from BARCO.
- ▶ **Summary**
gives an overview about the features of VISU^{PLUS}.
- ▶ **Getting Started**
describes the set up of VISU^{PLUS}.
- ▶ **Operating**
shows the capabilities which VISU^{PLUS} offers displaying graphics and video.
- ▶ **Maintenance**
describes the maintenance of VISU^{PLUS}.
- ▶ **Command Reference**
provides an overview of the serial commands and an instruction how to use.
- ▶ **Technical Appendix**
gives tabular overviews about the technical details of VISU^{PLUS}, its components and of their interfaces.
- ▶ **Troubleshooting**
gives advice, if your VISU^{PLUS} does not operate properly.
- ▶ **Index**
gives a list of the tables and figures, used in this manual.

Chapters, pages, figures and tables are numbered separately. Chapters are indicated by a »point syntax«, e. g. **4.2.3**, pages by a »dash syntax«, e. g. **2-1**, as figures and tables are, e. g. **figure 5-4**.

1.2 Styles and Symbols

The typographic styles and the symbols used in this document have the following meaning:

Helvetica bold	Labels, menus and buttons are printed in the Helvetica bold font.
Condensed	Links to both other chapters of this manual and to sites in the Internet are printed condensed. In the on-line version of this manual all hyperlinks appear teal.
Courier	Names of files and parts from programs are printed in the Courier font.
Courier bold	Inputs you are supposed to do from the keyboard are printed in Courier bold font.



Within a piece of programming code this arrow marks a line, that must be made up in two lines, though meant to be one line.



This arrow marks tips and notes.



The book is a reference to enclosed manuals.



If you do not heed instructions indicated by this symbol there is a risk of damage to the equipment!



If you do not heed instructions indicated by this symbol there is a risk of electrical shock and danger to personal health!



This symbol marks passages concerning solely the VISU^{PLUS} in conjunction with EOS.

1.3 Safety Instructions

This section describes safety precautions, which must be observed when installing and operating a product from BARCO.

1.3.1 Precautions



For your own protection, observe the following safety precautions when installing, operating and servicing your device:

- ▶ Before operating the units please read this manual thoroughly and retain it for future reference!
- ▶ Observe all warnings and instructions printed on the devices!
- ▶ Servicing not explicitly mentioned in this manual should never be carried out by unauthorized personnel! Never open the case of the unit without first disconnecting the power supply cord!
- ▶ To prevent fire or electrical shock hazard, do not expose this unit to rain or moisture!
- ▶ This product should be operated from an AC power source!
- ▶ This unit may be connected to an IT power system!
- ▶ Check that the voltage and frequency of your power supply match those printed on the device label with the rated electrical values!
- ▶ If you are not sure of the type of AC power available, consult your dealer or local power company!
- ▶ This product is equipped with a 3-wire grounding plug, a plug having a third (grounding) pin. This plug will only fit into a grounding-type power outlet. This is a safety feature. If you are unable to insert the plug into the outlet, contact your electrician to replace your obsolete outlet. Do not defeat the purpose of the grounding-type plug!
- ▶ This equipment must be grounded (earthed) via the supplied 3 conductor AC power cable. (If the supplied power cable is not the correct one, consult your dealer.)

Mains lead (AC Power cord) with CEE 7 plug:

The wires of the mains lead are colored in accordance with the following code:

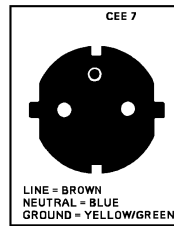

yellow + green	Earth (Ground)
blue	Neutral
brown	Line (Life)

Figure 1-1
CEE 7 plug

Power cord with ANSI 73.11 plug:

The wires of the power cord are colored in accordance with the following code.

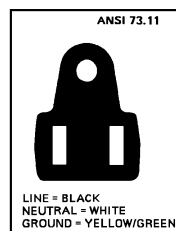

yellow + green	Earth (Ground)
black	Neutral
white	Line (Life)

Figure 1-2
ANSI 73.11 plug

- ▶ Do not allow anything to rest on the power cord. Do not locate this product where people will walk on the cord. To disconnect the cord, pull it out by the plug. Never pull the cord itself.
- ▶ If an extension cord is used with this product, make sure that the total of the ampere ratings on the products plugged into the extension cord does not exceed the extension cord ampere rating.
- ▶ Never push objects of any kind into this product through cabinet slots as they may touch dangerous voltage points or short out parts that could result in a risk of fire or electrical shock.
- ▶ Never spill liquid of any kind on the product. Should any liquid or solid object fall into the cabinet, unplug the set and have it checked by qualified service personnel before resuming operations.
- ▶ Lightning - For extra protection for this product during a lightning storm or when it is left unattended and unused for a long period of time, unplug it from the wall outlet. This will prevent damage to the unit due to lightning and AC power-line surges.

1.3.2 Unpacking of Devices

Note advises on the packaging for unpacking!

1.3.3 Installation

- ▶ Do not place this unit on an unstable cart, stand, or table. The unit may fall, causing serious damage to it.
- ▶ Do not use this unit near water.
- ▶ Use only the power cord supplied with your unit. While appearing to be similar, other power cords have not been safety tested at the factory and may not be used to power the unit. For a replacement power cord, contact your dealer.
- ▶ Slots and openings in the cabinet and the sides are provided for ventilation; to ensure reliable operation of the unit and to protect it from overheating, these openings must not be blocked or covered. The openings should never be blocked by placing the product on a bed, sofa, rug, or other similar surface. This product should never be placed near or over a radiator or heat register. This unit should not be placed in a built-in installation or enclosure unless proper ventilation is provided.
- ▶ The maximum recommended ambient temperature for this equipment is 40° C.
- ▶ When using the unit in a multi-unit rack assembly or closed assembly the ambient temperature inside the assembly may not exceed the maximum rated ambient temperature.
- ▶ When installed in a rack, the installation should be such that the amount of airflow required for safe operation of the equipment is not compromised. The mounting of the equipment should be such that no hazardous condition is achieved due to uneven mechanical loading.

1.3.4 Servicing

Mechanical or electrical modifications others than described in this manual must not be made to the devices. BARCO is not liable for damages resulting from modified devices.



Only authorized personnel should carry out other maintenance work not explicitly mentioned in this installation manual!

Never open the case of Visu^{PLUS} without first disconnecting the power supply cord! Measurements and tests with the opened device may be carried out only in the factory or by specially trained personnel, due to the dangers of electrical shock.

1.3.5 Cleaning

Unplug this product from the wall outlet before cleaning. Do not use liquid cleaners or aerosol cleaners. See section [5.2 Cleaning](#) for a cleaning instruction!

1.3.6 Re-Packing

Keep the original shipping carton and packing material; they will come in handy if you ever have to ship your unit. For maximum protection, repack your set as it was originally packed at the factory.

2 Summary

This chapter gives an overview about the features of VISU^{PLUS}.

2.1 Properties

With VISU^{PLUS} (Video Insertion Unit) live video and RGB data can be displayed on ATLAS and OVERVIEW Display Walls and be integrated into the X window applications or a Microsoft Windows desktop controlled by EOS.

The video- and RGB-windows displayed by VISU^{PLUS} can be manipulated in contrast, brightness, color etc. As well they can be zoomed in and out.

The VISU^{PLUS} system is a modular system, which holds a processor board, one to four input modules and one to four output modules. Any combination of inputs and outputs is possible, i.e. you may for example have two output cards, two video input cards and two RGB input cards installed. This then offers you the possibility to display two video and two RGB sources anywhere within a 2x1 or 1x2 display matrix area.

Two VISU^{PLUS} setups are possible:

Visu^{PLUS} – Eos Setup

With VISU^{PLUS} live video and RGB pictures can be inserted into the display of the EOS X Terminal or EOS Workstation for Windows NT/2000. In this way, video or RGB data may be displayed within an X window or a video window respectively and may be controlled in the same way as any other window concerning resizing and moving.

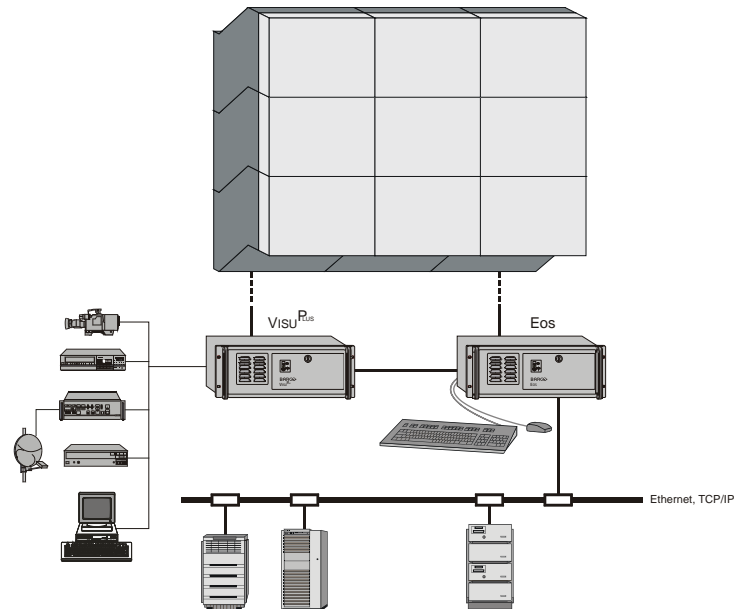

Figure 2-1
Visu^{PLUS} – Eos setup

Visu^{PLUS} – Standalone Setup

A VISU^{PLUS} standalone system is mainly used in application areas where there is a need for displaying different information sources (Video or RGB) within a matrix of display systems (projectors or other display medium). Sources displayed may be moved, re-scaled and treated in a number of other ways via control software, which is installed on a control PC. To control the functions of VISU^{PLUS} and to locate and size the video and RGB windows an additional control PC is needed.

This control PC is operated with the Linux operating system.

The VISU^{PLUS} standalone product is almost identical to the VISU^{PLUS} product for EOS systems. The functionality is largely the same, some minor hardware aspects together with some internal operation differs between both products.

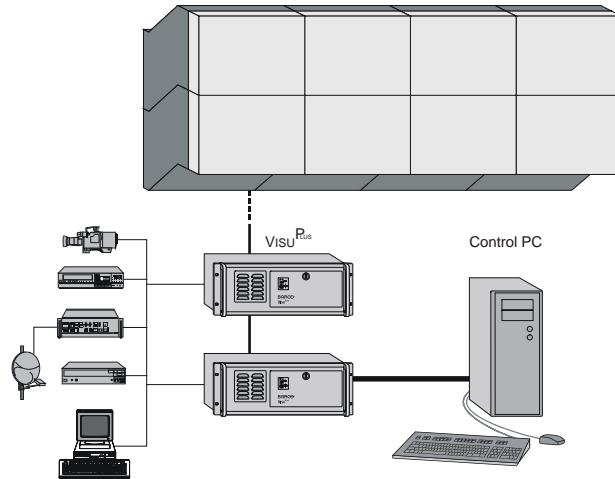

Figure 2-2
VISU^{PLUS} – standalone setup

Control Room Management Software OSIRIS and APOLLO

Depending on the used operating system of the EOS and control PC respectively, either the wall management software OSIRIS or APOLLO can be used to control the VISU^{PLUS}.

OSIRIS is used for a VISU^{PLUS} with digital or analog output in a VISU^{PLUS} – EOS or VISU^{PLUS} – standalone setup when EOS or the control PC is operated as X terminal. The EOS X Server that is installed on EOS or the control PC provides the multi screen capability. The table below gives you an overview about the releases of OSIRIS and the X Server that have to be used with your specific VISU^{PLUS} hardware configuration:

Visu ^{Plus} configuration	Osiris	X Server
EOS setup, analog output	V 1.1.1 and later	R2.11 and later
standalone setup, analog output	V 1.1.3 and later	R2.21 and later
EOS setup, digital output MDR26 connector	V 1.2.0 and later	R2.2 and later
standalone setup, digital output MDR26 connector	V 1.2.0 and later	R2.21 and later
EOS setup, digital output DVI connector	V 1.3.2 and later	R3.06 and later
standalone setup, digital output DVI connector	V 1.3.2 and later	R3.06 and later

Table 2-1
dependencies of VISU^{PLUS}, OSIRIS and X Server

APOLLO serves to control a VISU^{PLUS} with digital output connected to an EOS Workstation for Windows NT/2000.

Visu ^{Plus} configuration	Apollo	Display Driver
EOS setup, digital output MDR26 connector	R1.4.1 and later	R3.0 and later
EOS setup, digital output DVI connector	R1.4.3 and later	R3.1 and later

Table 2-2
dependencies of VISU^{PLUS}, APOLLO and EOS Display Driver

3 Getting Started

This chapter describes the set up of VISU^{PLUS}.

If your VISU^{PLUS} is already configured within your working place you can skip this chapter and continue with section [4 Operating](#).

3.1 Examining

3.1.1 Visu^{PLUS}

The front of VISU^{PLUS} looks like this or similar:

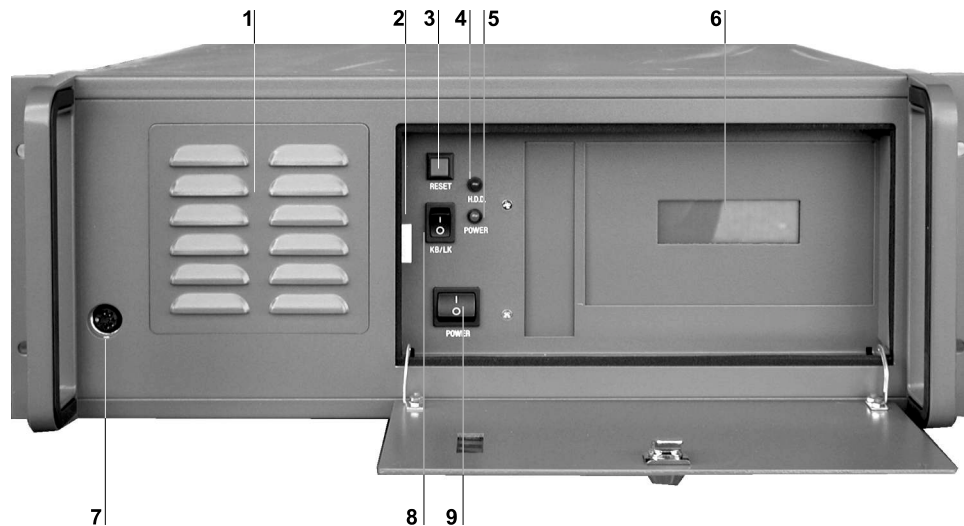

1	air supply
2	handle of filter mounting
3	restart button
4	LED: status
5	LED: power on
6	LCD display for system messages
7	reserved for future use!
8	reserved for future use!
9	power button

Figure 3-1
front view of VISU^{PLUS}

Next to the air supply openings [1] there is the handle of the filter mounting [2].

In the center there are three buttons. The upper one is the **reset** button [3], the lower one is the **power** button [9]. The two LEDs next to the switches indicate **status** [4] respectively **power on** [5].

On the right hand side there is an **LCD display** for system messages [6].

The Back

The back of your VISU^{PLUS} looks like this or similar:

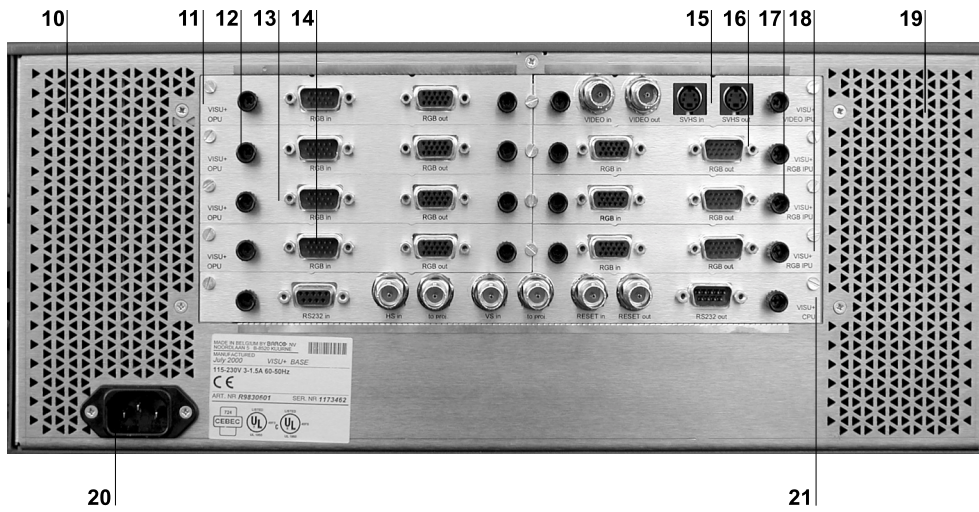

10, 19	air supply
11	output card 0
12	output card 1
13	output card 2
14	output card 3
15	input card 0
16	input card 1
17	input card 2
18	input card 3
20	mains connection
21	processor board

Figure 3-2
rear view of VISU^{PLUS}

On the lower left hand side there is the **mains connection** [20].

In the left middle there are up to four **output cards** [11-14], lined up one under each other. In the right middle there are up to four **input cards** [15-18], lined up one under each other. Under the input and output cards, the **processor board** [21] is located.



To protect VISU^{PLUS} from overheating, the air supply openings in the case shall be kept free of obstructions!

3.1.2 Control PC for Visu^{PLUS} Standalone

The control PC for VISU^{PLUS} standalone comes with its own documentation to you, please read it carefully.

The control PC provides a serial and a parallel port that is used to connect to the processor board of the VISU^{PLUS} and therewith control the VISU^{PLUS}. The serial port is located on a Multiport I/O card. For the parallel port either the standard parallel port of the computer can be used or if available a parallel port of the Multiport I/O Card. The Multiport I/O Card is inserted in an expansion slot of the control PC.

3.2 Cabling

3.2.1 Power Supply



Check the power rating on your outlet before connecting VISU^{PLUS} to the wall outlet or to a power strip. Contact your facilities manager or a qualified electrician if you are not sure what type of power is supplied to your building.



VISU^{PLUS} is designed to operate with single-phase power systems having a grounded neutral conductor. To reduce the risk of electrical shock, do not plug into any other type of power system.

To connect VISU^{PLUS} to the power supply, follow these steps:

- ▶ Plug the female end of the power cord into the **mains connection** [20].

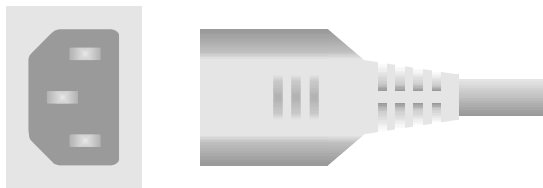

Figure 3-3
mains connection of VISU^{PLUS}

- ▶ Plug the male end of the power cord into a power outlet.

3.2.2 Digital Output Unit (DVI)

There are three different types of output units for connecting to the projection modules of an OVERVIEW or ATLAS Display Wall: digital output unit DVI, digital output unit MDR26 and analog output unit.

To connect to digital projection modules the digital output unit DVI can be used.



Within a Visu^{Plus} – Eos configuration the graphical information of Eos is also inserted into the output unit of Visu^{Plus}.

Each of these output units provides the facility for connecting one projection module.



Digital and analog output units may not be mixed within one Visu^{Plus} or within multiple Visu^{Plus} in the same chain! Nevertheless digital output units with DVI connector and with MDR26 connector can be used in the same device.

Furthermore in a VISU^{PLUS} - EOS configuration the digital output unit DVI is able to loop through DDC information from the display device to the EOS.

Connectors

The digital output unit has two connectors. The **In** connector [1] is to connect to a digital graphic channel of EOS within a VISU^{PLUS} – EOS Setup. The **Out** connector [2] is to connect to the projection module.



1	In
2	Out

Figure 3-4
digital output unit (DVI)

Cable

The DVI-D to DVI-D cable is used to connect the **Out** connector [2] of the digital output unit (DVI) with a digital projection module, see figure below.



Figure 3-5
DVI-D to DVI-D cable

Order

The (digital or analog) output units are numbered from top to bottom beginning with **0**.

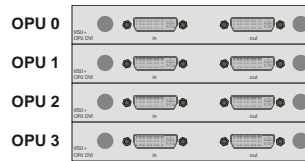

Figure 3-6
numbering of output units

If multiple VISU^{PLUS} are used, the output units are numbered continuously beginning with the output units of the VISU^{PLUS} that is connected directly to the EOS or control PC, continuing with the output units of the VISU^{PLUS} that is directly connected to the first VISU^{PLUS} etc.

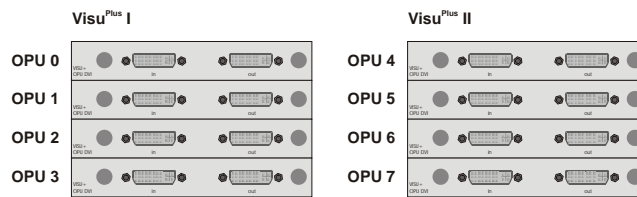

Figure 3-7
output units in multiple VISU^{PLUS}

3.2.3 Digital Output Unit MDR26

VISU^{PLUS} can be equipped with digital output units with MDR26 connector for connecting digital projection modules of an OVERVIEW or ATLAS Display Wall.



Within a Visu^{Plus} – Eos configuration the graphical information of Eos is also inserted into the output unit of Visu^{Plus}.

Each of these output units provides the facility for connecting one projection module.



Digital and analog output units may not be mixed within one Visu^{Plus} or within multiple Visu^{Plus} in the same chain!

Connectors

The digital output unit has two connectors. The **RGB In** connector [1] is to connect to a digital graphic channel of EOS within a VISU^{PLUS} – EOS Setup. The **Out** connector [2] is to connect to the projection module.

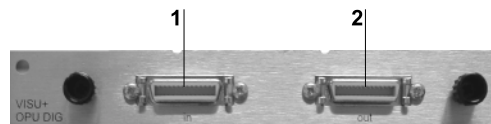

1	In
2	Out

Figure 3-8
digital output unit

Order

Analog output units are numbered in exactly the same way like the digital output units, see section [3.2.2 Digital Output Unit \(DVI\)](#).

MDR26 Cable

The Panellink cable is used to connect the **Out** connector [2] of the digital output unit with a digital projection module, see figure below.

Within a VISU^{PLUS} – EOS setup a shorter version of the Panellink cable (1.5 m) is used to connect the digital output of EOS with the **In** connector [1] of the digital input unit.



Figure 3-9
MDR26 to MDR26 cable

3.2.4 Analog Output Unit

VISU^{PLUS} can be equipped with analog output units for connecting analog projection modules or CRT monitors.



Within a Visu^{Plus} – Eos configuration the graphical information of Eos is as well inserted in the OPU.

Each of these output units provides the facility for connecting one analog projection module or CRT monitor.



Digital and analog output units may not be mixed within one Visu^{Plus} or within multiple Visu^{Plus} in the same chain!

Connectors

The analog output unit has two connectors. The **In** connector [1] is used to connect an analog graphics channel of EOS in a VISU^{PLUS} – EOS Setup. The **Out** connector [2] is used to connect to the projector.

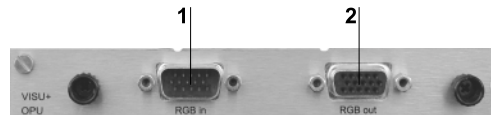

1	RGB in
2	RGB out

Figure 3-10
analog output unit

Order

Analog output units are numbered in exactly the same way like the digital output units, see section [3.2.2 Digital Output Unit \(DVI\)](#).

D15 – D15 Cable

Within a VISU^{PLUS} – EOS setup the D15 – D15 cable is used to connect the analog output of EOS with the **RGB in** connector of the analog input unit.



Figure 3-11
D15 – D15 cable

D15 – BNC Cable

The D15 – BNC cable is used to connect the output connector of the analog output unit with an analog projection module or a CRT monitor. The table below shows the order of the output signals as they are in the BNC connectors:

signal	identification
Red	red wire
Green	green wire
Blue	blue wire
Hsync	undefined color, next to blue wire and not green wire
Vsync	undefined color, next to Hsync and not blue wire

Table 3-1
color coding of BNC connectors



In a Visu^{Plus} – Eos setup the processor board has to be synchronized with the outgoing signal. Therefore the horizontal sync has to be connected to the HS in connector of the processor board, the vertical sync has to be connected to the VS in of the processor board, see section 3.2.7 Processor Board.



Figure 3-12
D15 – BNC cable

3.2.5 Video Input Unit

VISU^{PLUS} can be equipped with video input units to insert video data. Each of these video input units provides the facility for connecting one video source and to loop through the signal.

Connectors

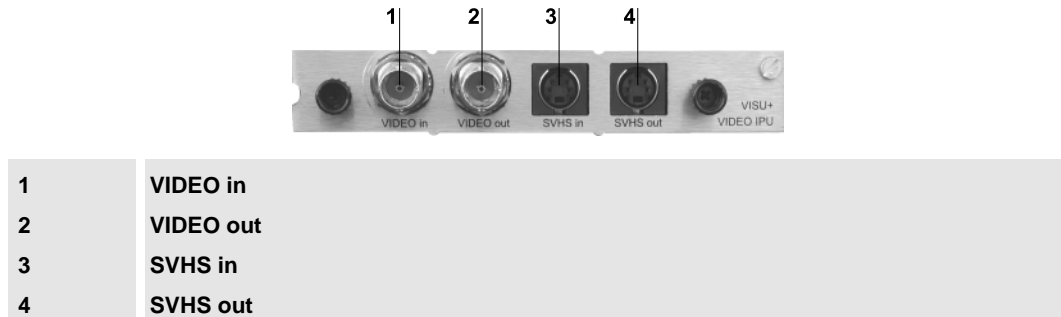

Figure 3-13
video input unit

A composite video source can be connected to the **VIDEO in [1]** connector or an SVHS video source can be connected to the **SVHS in [3]** connector. The video signal can be actively looped through and with the **VIDEO out [2]** and **SVHS out [4]** connector respectively the signal can be connected to another device or VISU^{PLUS}.

Order

The input units are numbered from top to bottom beginning with **0**. Video and RGB input units may be mixed.

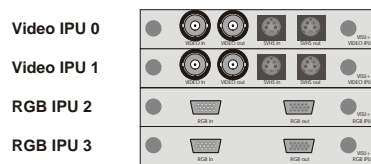

Figure 3-14
numbering of input units

If multiple VISU^{PLUS} are used, the input units are numbered continuously beginning with the input units of the VISU^{PLUS} that is connected directly to the EOS or control PC, continuing with the input units of the VISU^{PLUS} that is directly connected to the first VISU^{PLUS} etc.

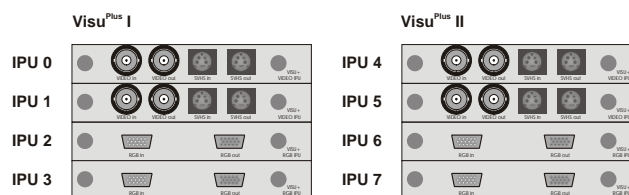
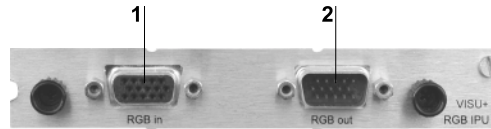

Figure 3-15
input units in multiple VISU^{PLUS}

3.2.6 RGB Input Unit

VISU^{PLUS} can be equipped with RGB input units to insert RGB data. Each of these RGB input units provides the facility for connecting one RGB source and to loop through the signal.

Connectors



1	RGB in
2	RGB out

Figure 3-16
RGB input unit

An RGB source can be connected to the **RGB in [1]** connector. If wished the ability to actively loop through the RGB signal can be used and with the **RGB out [2]** connector the signal can be connected to another device.



The RGB out connector may only be used to loop the signal through to connect to an other device, e.g. a monitor. Don't insert the signal to another VISU^{PLUS}. Use an extra device like RGB/Matrix switcher instead!



If an RGB signal is connected from a Barco Magic interface then a BNC T-connector has to be used, which has to be connected as close as possible to the RGB input unit. The Hsync and Vsync line have to be terminated with a 75 Ohm terminator.

In this case only separate sync (HS, VS) may be used. Composite sync (Cs) may not be used!

Order

The order of the RGB input units is explained in section [3.2.5 Video Input Unit](#).

3.2.7 Processor Board

The processor board (CPU) contains several connectors to control, reset and synchronize the VISU^{PLUS}.

Connectors

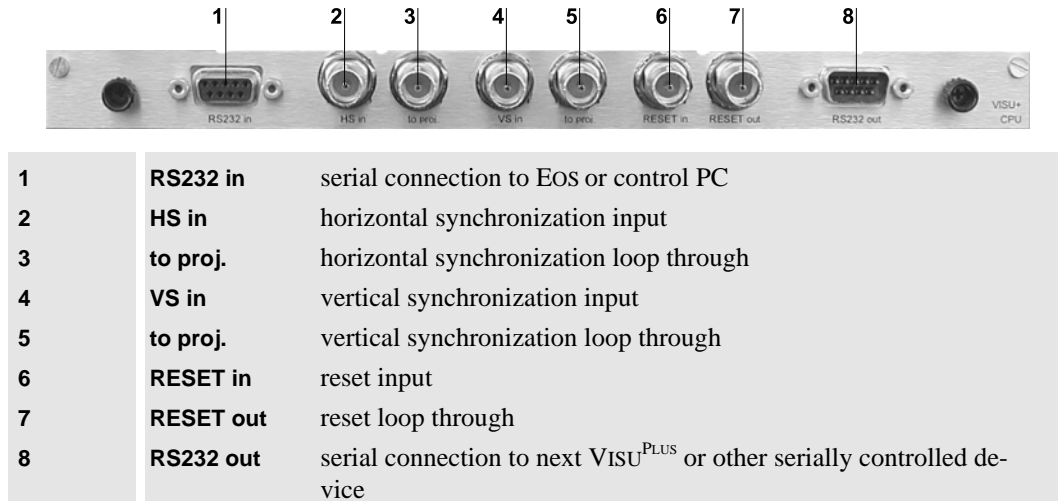

Figure 3-17
processor board

The **RS232 in** connector [1] is to connect the EOS or control PC with the VISU^{PLUS}. The **RS232 out** connector [8] is to connect another VISU^{PLUS} or any other device that is as well controlled via the serial interface.



In Visu^{Plus} – Eos setup the HS in [2] and VS in [4] connectors are to insert the horizontal and vertical synchronization. When required (projectors without the sync on green capability for example), the output sync connectors to proj. [3], [5] may be used to loop through the sync signals towards the sync input of the projectors.



Under no circumstances may the sync outputs be looped through to the next Visu^{Plus}. With multiple Visu^{Plus}, use the syncs from an output channel of that particular Visu^{Plus}!

The connectors for the synchronization [2], [3], [4] and [5] are not used for the digital VISU^{PLUS}.

The **RESET in** connector [6] is to insert the reset signal from EOS or the control PC. If multiple VISU^{PLUS} are used, the **RESET out** connector [7] is to be used to loop through the reset signal to the next VISU^{PLUS}.

Visu^{PLUS} Load Cable (D9 – D9)

In order to upload the operating system to the VISU^{PLUS} devices and control the VISU^{PLUS} windows (position and aspect ratio) a serial connection has to be established between the VISU^{PLUS} and EOS or the control PC.

The serial cable is also used to establish the serial connection between multiple VISU^{PLUS}.

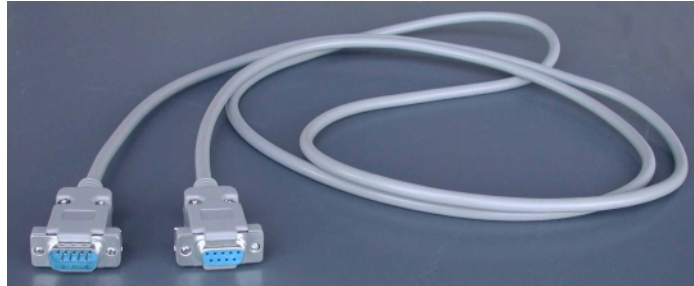

Figure 3-18
VISU^{PLUS} load cable

Visu^{PLUS} Reset Cable (D25 – BNC)

The VISU^{PLUS} reset cable is used to connect the parallel port of EOS and the control PC respectively with the reset in port [6] of the VISU^{PLUS}. By means of this connection the VISU^{PLUS} can be reset remotely.

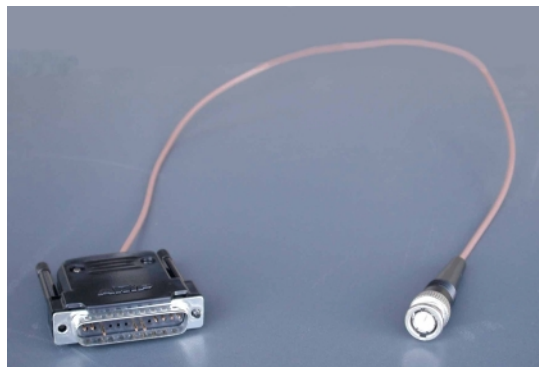

Figure 3-19
VISU^{PLUS} reset cable

BNC - BNC Cable

- ▶ The BNC – BNC cable is used to establish the connection between multiple VISU^{PLUS} in a chain. It connects the **RESET out** connector [7] of a VISU^{PLUS} with the **RESET in** connector [6] of the next VISU^{PLUS}.

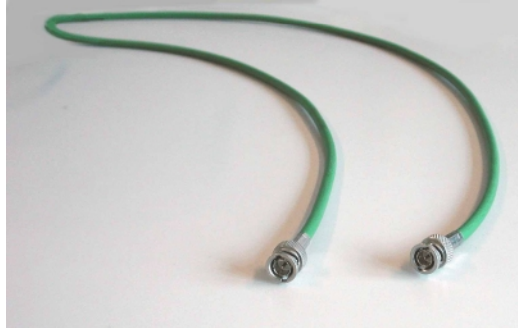

Figure 3-20
BNC - BNC cable

3.3 Starting Up

3.3.1 Connecting

Plug in the power cable on the back panel of your VISU^{PLUS}. Please refer to section [3.2.1 Power Supply!](#)

Connect the serial port of the Multiport I/O Card of EOS and the control PC respectively with the **RS232 in** port of the processor board. If more than one VISU^{PLUS} is used connect the **RS232 out** port of the processor board of the first VISU^{PLUS} with the **RS232 in** port of the processor board of the next VISU^{PLUS} and so on, see section [3.2.7 Processor Board](#).

Connect the parallel port of the EOS and the control PC respectively with the **RESET in** port of the processor board of VISU^{PLUS}. If more than one VISU^{PLUS} is used connect the **RESET out** port of the processor board of the first VISU^{PLUS} with the **RESET in** port of the processor board of the next VISU^{PLUS} and so on, see section [3.2.7 Processor Board](#).

Connect the video or RGB sources with the respective **in** port on the video or RGB input unit, refer to section [3.2.5 Video Input Unit](#) and [3.2.6 RGB Input Unit](#).



Interfaces and long cabling can influence the image quality (sharpness and color). To reduce the color degradation, one can tune the interface while its image is being displayed directly on a projector, before connecting it to the input of the VISU^{PLUS}! This takes some time, but it pays off in the end!

For the connection of cables for the graphical data three different setups of VISU^{PLUS} have to be distinguished, depending on analog or digital output units and on EOS or standalone setup:

Visu^{PLUS} – Eos setup (digital)

If EOS controls VISU^{PLUS} and data is transferred digitally, connect the data cables as follows:

Connect the first graphic port of EOS with the **in** ports of the first digital output unit of VISU^{PLUS} and so on. Refer to section **3.2.3 Digital Output Unit** for the order of the output units and to the **user's manual Eos X Terminal** for the order of the graphic channels of **Eos 7.3 Order Codes**. Connect the **out** ports of the digital output units with the OVERVIEW or ATLAS projection modules.



Within a Visu^{Plus} – Eos setup the Visu^{Plus} units need to be powered on even if no video or RGB-signal is inserted at all due to the loop through of the graphic signals of Eos.

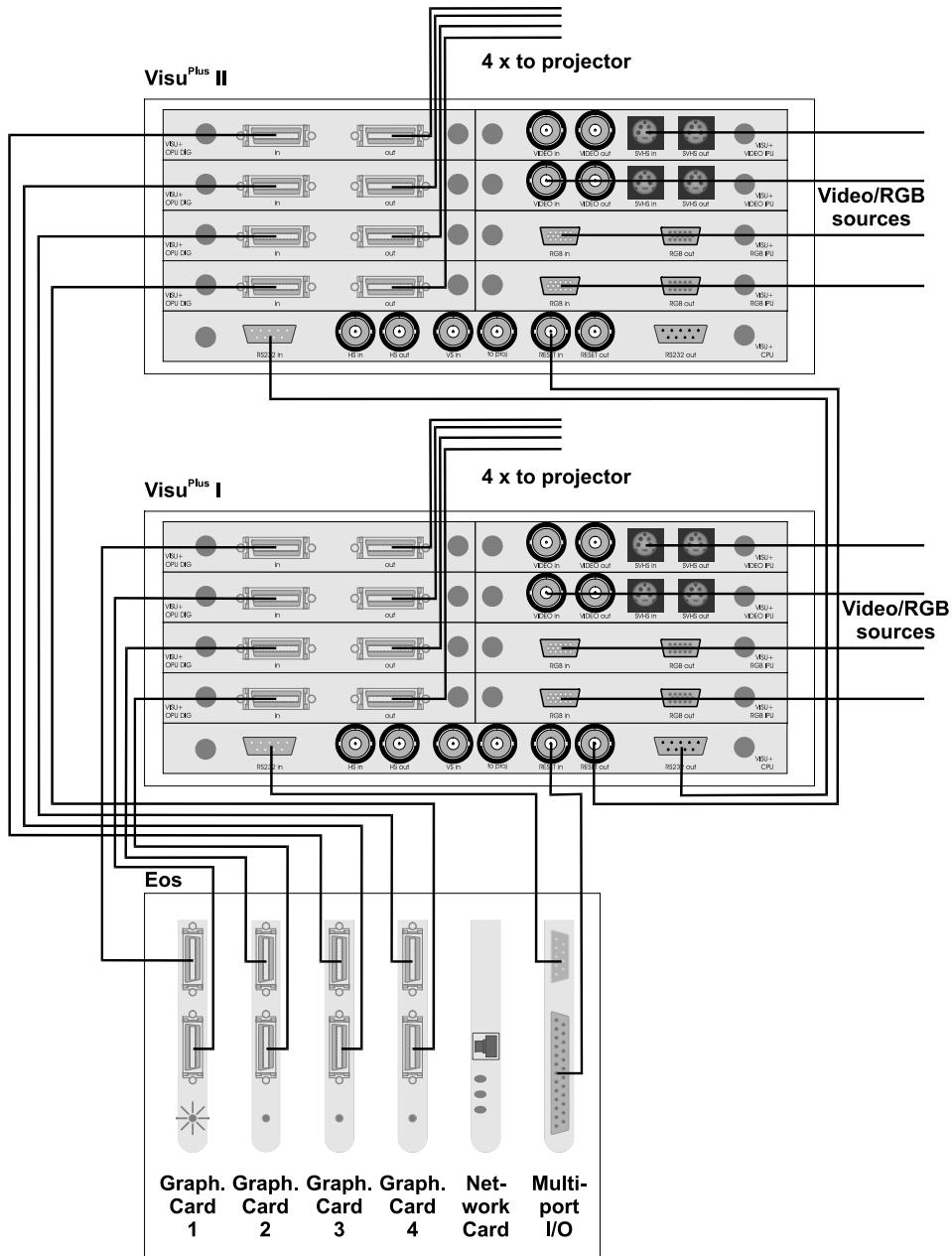

Figure 3-21
data and control cabling: VISU^{PLUS} – Eos setup, digital

Visu^{PLUS} – Eos setup (analog)

If EOS controls VISU^{PLUS} and analog data is transferred, connect the data cables as follows:

Connect the first graphic port of EOS with the **in** ports of the first analog output unit of VISU^{PLUS} and so on. Refer to section 3.2.4 Analog Output Unit for the order of the output units and to the **user's manual Eos X Terminal** for the order of the graphic channels of EOS, see section 7.3 Order Codes. Connect the **out** ports of the analog output units with the analog projection modules or CRT monitors. The Hsync and Vsync of the last used output of each VISU^{PLUS} needs to be connected to the **HS in** and the **VS in** of the processor boards, see section 3.2.4 Analog Output Unit.

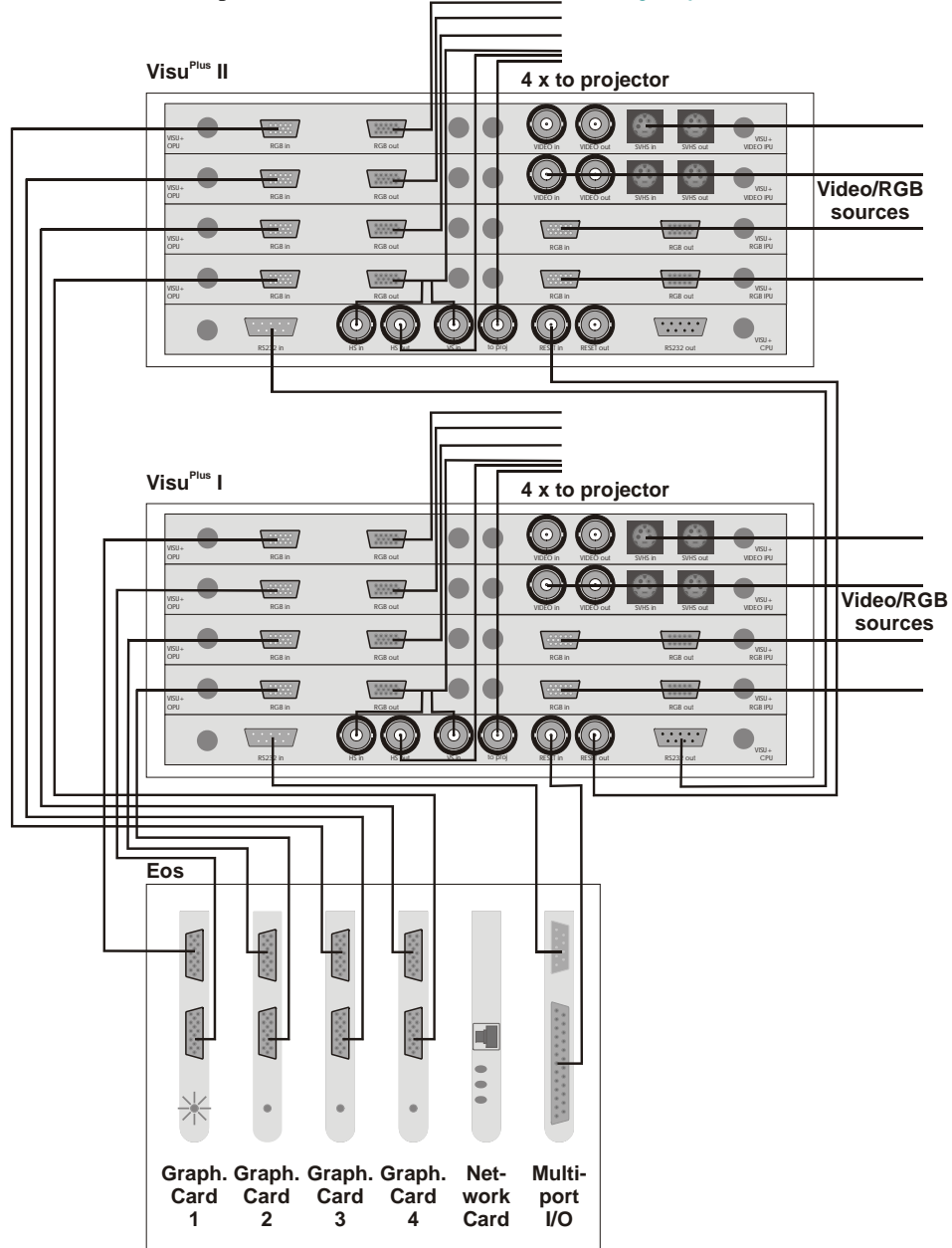

Figure 3-22
data and control cabling: Visu^{Plus} – Eos setup, analog

VisuPlus – standalone setup (digital and analog)

If VISU^{PLUS} is setup in a standalone configuration and is controlled by a control PC the cabling of the digital or analog output units follows the same scheme. Therefore just the cabling for the analog setup is explicitly given. The cabling of the digital setup has to be established accordingly. Connect the data cables as follows:

Connect the **out** ports of the analog output units with the analog projection modules or CRT monitors.

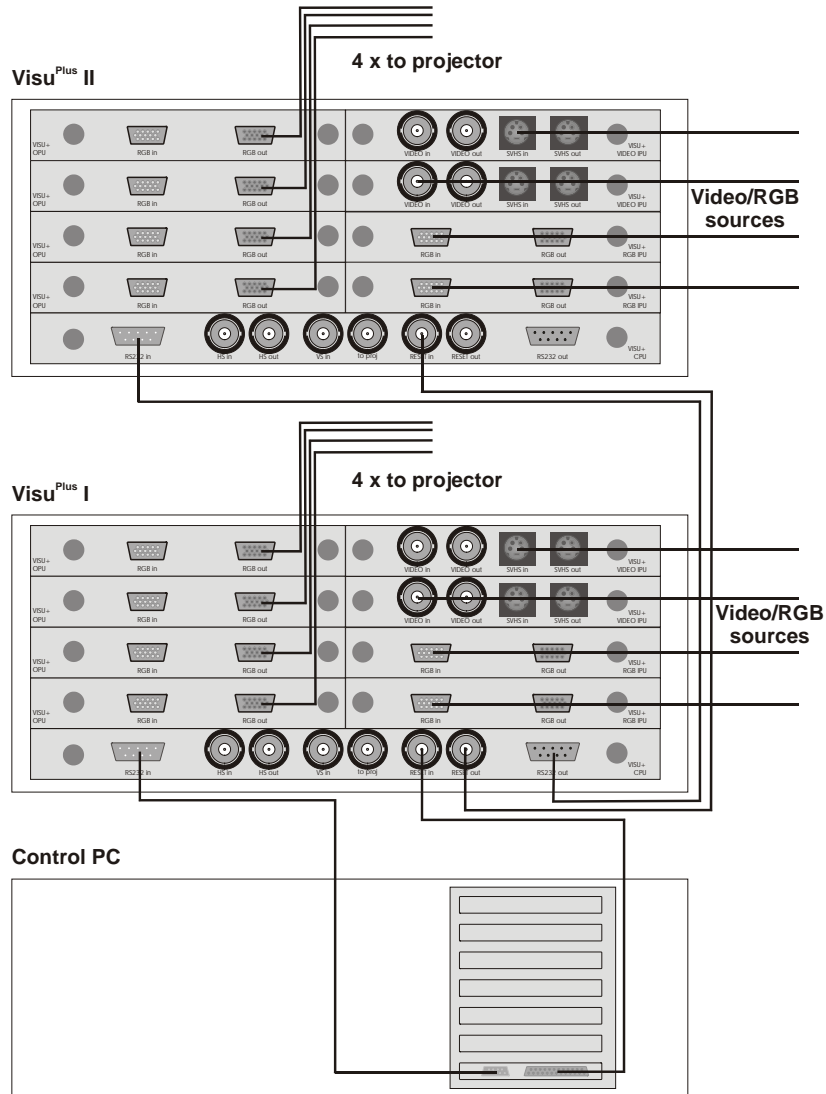

Figure 3-23
data and control cabling: Visu^{Plus} – standalone setup, analog



Under no circumstances, connect any signal to either one of the sync-BNC connectors (HS in [2], to proj. [3], VS in [4], to proj. [5]) on the processor board of the stand-alone VISU^{PLUS}.

3.3.2 Switching on

Switch on VISU^{PLUS} by applying the **power switch [9]** on front! When multiple VISU^{PLUS} are used, the order in which the VISU^{PLUS} are switched on is of no importance.

When the system is powered on, the **green LED: Power [5]** on the front panel will lighten up. If it does not lighten up, see section [8 Troubleshooting](#).

When the system is switched on, the **red LED: Status [4]** on the front panel will light up for one second. When the status LED stays lighted up, see section [8 Troubleshooting](#).



Within a Visu^{Plus} – Eos setup the Visu^{Plus} units need to be powered on even if no video or RGB-signal is inserted at all due to the loop through of the graphic signals of Eos.

3.3.3 Switching off

To switch off VISU^{PLUS} just push the **power switch [9]** on the front of VISU^{PLUS} to **0**.

4 Operating

This chapter shows the capabilities that VISU^{PLUS} offers for displaying video and RGB signals.

4.1 Display Capabilities

Up to four input units can be integrated in VISU^{PLUS} to be able to display video or RGB sources on an ATLAS or OVERVIEW Display Wall. RGB and video input units can be integrated within the same VISU^{PLUS} device.

The video and RGB windows are freely movable. The video or RGB input can be scaled up and down. Downscaling is possible up to 16×16 pixels, upscaling is unlimited.

The video and RGB windows can separately be frozen, hidden and shown. It can be zoomed in and out and the windows may overlap. Contrast, brightness, chroma, hue and sharpness of the video windows can be adopted. Resolution, phase and color of the RGB windows can be adopted.

If multiple VISU^{PLUS} are used the video and RGB data can only be displayed on the modules where the VISU^{PLUS} is connected. A video switcher can be used to provide the same signal to all VISU^{PLUS} devices if this signal is to be displayed on several projection modules, which are connected to multiple VISU^{PLUS} units.

If no source is connected or if a window is moved out of the display area of the projection modules where the VISU^{PLUS} is connected to, the content of the window is black (analog output units) or has a background color (digital output units).

4.1.1 Video Input Unit

Video data in the video input unit is processed with a color depth of 24 bit.

At a video input unit **composite video** and **SVHS video** can be connected. Only one source can be displayed at one time.

The video input unit supports the most common video standards. All supported standards are listed in the table below. Unsupported standards may be converted first to a supported standard using a separate converter!

NTSC-M (U.S., many others)	autodetect
NTSC-Japan (Japan)	manual selection
PAL-B (many)	autodetect
PAL-D (China)	autodetect
PAL-K	autodetect
PAL-G (many)	autodetect
PAL-H (Belgium)	autodetect
PAL-I (Great Britain, others)	autodetect
PAL-M (Brazil)	manual selection
PAL-N (Paraguay, Uruguay)	manual selection
PAL-N combination (Argentina)	manual selection
SECAM-B/G/D/K/K1/L (Eastern Europe, France, Middle East)	manual selection

Table 4-1
supported video standards

The manual selection can be defined by means of the OSIRIS or APOLLO software.

4.1.2 RGB Input Unit (SXGA)

The RGB input unit has a maximum resolution of 1280×1024 pixels. It processes data internally with a color depth of 16 bpp.

max. resolution	1280×1024
max. pixelclock	160 MHz
max. line rate	100 kHz
max. frame rate	120 Hz
input	Separate sync and Composite sync signals with an amplitude between 0.3 V and 5 V, Sync-on-green
detection of the synctype	automatic
sampling	R, G, B -> 5, 6, 5
scaling mode	intelligent
sources	non interlaced

Table 4-2
display properties of RGB input unit

4.1.3 Output Units

Module Overlapping Windows

If the VISU^{PLUS} is equipped with analog output units and a window is positioned on multiple projection modules, at the vertical border of a module two pixels are not displayed. One can choose whether two pixels on the left or two pixels on the right or one pixel on each side is not displayed.

Displaying RGB windows with more than 1024x768 Pixels

The following remarks must be considered when displaying RGB windows, due to the internal output line size of 1024 bit per row of the output card:

- ▶ Output resolutions up to 1024 pixels per row can be displayed without any limitation.
- ▶ At higher resolutions the pixels will be scaled to fit in the buffer. A resolution of 1280×1024 will then internally be stored at 640×1024 pixels. To overcome this the horizontal size will be doubled towards the projector.

An RGB input of 800×600 pixels is optimally displayed:

- ▶ At an output resolution of 1024×768
The RGB window needs not to be enlarged. All pixels fit in the line buffer.
- ▶ At an output resolution of 1280×1024
If the RGB window is doubled to a size of 1600.

If orbiting is required, there has to be an overlap of 16 pixels between 2 outputs. Since this overlapping area has to be contained within the same buffer size of 1024, the usable resolution has to be reduced further to 1008 (=1024-16) horizontally. In order to keep the aspect ratio correct, the output resolution of 1008 x 756 per screen is the best choice for optimal usage of the VISU^{PLUS}.

4.1.4 Video Switcher

Integrating a video switcher improves the possibilities of moving video and RGB windows on the Display Wall. A connected video or RGB source can then not only be displayed in the display section of one VISU^{PLUS} but can be moved within the whole area of all VISU^{PLUS} connected to the source via the video switcher. The figures below illustrate the possibilities to display video and RGB windows without and with video switcher:

► **No video switcher is used:**

The display of the video and RGB windows is restricted to the projection modules, which are connected to one specific VISU^{PLUS} (left image). If a window is moved over the borders of the display area, no content can be shown in the concerned area (right image):

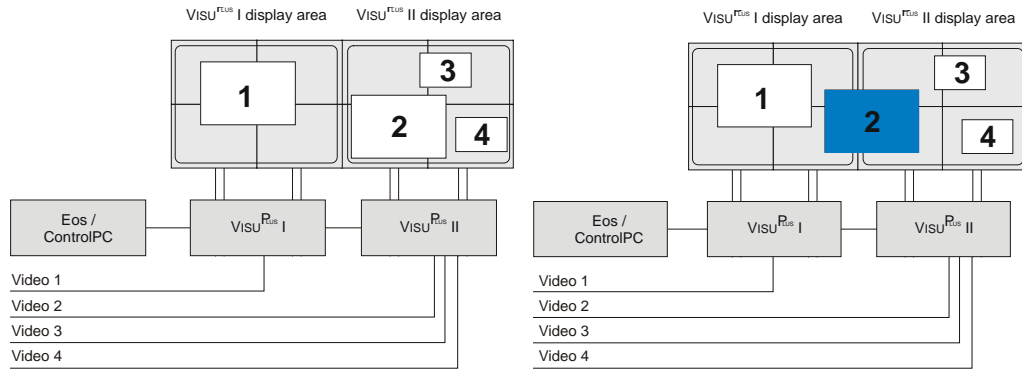

Figure 4-1
display without video switcher

► **A video switcher is used:**

Video and RGB windows can be displayed on all projection modules, which are connected to any VISU^{PLUS} that is connected to the video switcher.

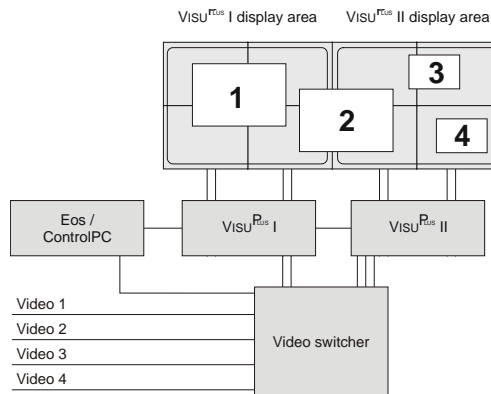

Figure 4-2
display with video switcher

4.2 Operation

The VISU^{PLUS} is controlled by means of EOS or the control PC. Therefore on EOS and the control PC respectively the Wall Management Software OSIRIS or APOLLO has to be installed, depending on the operating system. The operation of the VISU^{PLUS} is explained in the user's manual of OSIRIS as well as in the user's manual of APOLLO.

5 Maintenance

VISU^{PLUS} requires very little maintenance. Some maintenance operations are nevertheless necessary to maintain distortion free operation of VISU^{PLUS}.

5.1 Exchange of Consumables

5.1.1 Replacing the Filter Pad of Visu^{PLUS}

The filter pad of the VISU^{PLUS} case has to be changed in intervals, depending on the grade of pollution of the air. See section [7.3 Order Codes](#) for ordering filter pads.

The air filter is located behind the ventilation slits on the front of VISU^{PLUS}.

- ▶ Unlock the front cover of VISU^{PLUS} with the key!
- ▶ Pull the handle of the filter mounting into your direction!
- ▶ Pull out the filter mounting to the right!
- ▶ Remove the old filter pad!
- ▶ Insert a new filter pad!
- ▶ Insert the mounting into VISU^{PLUS} until the handle engages!
- ▶ Lock the front cover!

5.2 Cleaning

To keep the cabinet looking brand-new, periodically clean it with a soft cloth. Stubborn stains may be removed with a cloth lightly dampened with mild detergent solution. Never use strong solvents, such as thinner or benzine, or abrasive cleaners, since these will damage the cabinet.

Unplug the device from the wall outlet before cleaning.



Never clean the case of Visu^{Plus} without first disconnecting the power supply cord!
Do not use liquid cleaners or aerosol cleaners!

6 Command Reference

This chapter provides an overview of the serial commands used to control the VISU^{PLUS} and an instruction how to use them.

Usually EOS and the control PC take use of these protocols by means of the wall management software. Nevertheless it may be helpful to know the protocol for a debug mode (e.g. MS Hyper Terminal).

6.1 Introduction

The host computer (EOS or the control PC) communicates with one or more VISU^{PLUS} via a serial protocol.

There are two different communication protocols used towards the VISU^{PLUS}. The first protocol is used after start-up or restart, and takes care of downloading and starting the necessary VISU^{PLUS}-software. The other protocol is used after the previous one, and takes care of real time VISU^{PLUS}-operation:

- ▶ Initialization: Hardware settings (output resolution, output phase, ...).
- ▶ Video settings (contrast, brightness, freeze, ...).
- ▶ RGB input settings (horizontal and vertical resolution, horizontal and vertical phase, ...).
- ▶ Source placement.

The following sections describe this last protocol.

Please contact Barco for the download protocol.

6.2 Notation Conventions

The syntax elements of VISU^{PLUS} commands are signified as follows:

< >	Angled brackets surrounding a syntax item indicate a user-defined argument. Do not enter the brackets in commands.
<CR>	The ASCII Carriage Return.
VisuNr	VISU ^{PLUS} number in a serial chain. The first one has number 0.
IpuNr	Input unit (video or RGB) number, which is a physical board in one of the VISU ^{PLUS} of the chain. The first IpuNr of a VISU ^{PLUS} (top most location) = 4 * VisuNr.
SrcNr	Source number, the output of an image-generating device (camera, video, computer image...), ranging from 0 to 63.
WinNr	Window number, a real window on the screen, ranging from 0 to 63.
OpuNr	Output unit number, which is a physical board in one of the VISU ^{PLUS} of the chain. The first OpuNr of a VISU ^{PLUS} (top most location) = 4 * VisuNr.
Source	A source is an output of an image-generating device (Camera, video, TVDM...). In the VISU ^{PLUS} data structure, each source has a unique source number: SrcNr
Window	A VISU ^{PLUS} window is the image in one single X window or video window. In the VISU ^{PLUS} data structure, each window has a unique window number: WinNr
IPU	An IPU is a physical board of a VISU ^{PLUS} . In the VISU ^{PLUS} data structure, each IPU has a unique IPU number: IpuNr

Table 6-1
syntax elements of Visu^{Plus} commands

6.3 Visu^{PLUS} Internals

The internal data structure is been split into three different tables: source table, window table and input unit table. These three tables are stored on each Visu^{PLUS} in the chain. The source table and the window table have the same content on each Visu^{PLUS}, as they contain information about the configuration of the whole system. The input unit table is unique on each Visu^{PLUS} as it contains information about the input units of the specific Visu^{PLUS} where it is stored.

This is done to decrease the amount of communication towards the Visu^{PLUS} when using matrix-switchers.

Input Unit Table		Window Table		Source Table	
IPU x+0 parameters	0	Window 0 parameters	0	Source 0 parameters	
IPU x+1 parameters	3	Window 1 parameters	-1	Source 1 parameters	
IPU x+2 parameters	-1	Window 2 parameters	3	Source 2 parameters	
IPU x+3 parameters	2	Window 3 parameters	4	Source 3 parameters	
		Window 4 parameters	-1	Source 4 parameters	
		
		Window 63 parameters	-1	Source 63 parameters	

Figure 6-1
data tables of Visu^{Plus}

Source Table

The source table can store source specific parameters for up to 64 (0..63) different sources.

A source can be a video (parameters: Contrast, Brightness, ...) or RGB (parameters: Resolution, Phases, ...).

Window table

The window table can store parameters for up to 64 (0..63) different windows.

Parameters are the window position, size and viewport, also some window specific parameters (Sharpness, Freeze, ...).

A window of this table can be linked to a source and an input unit. It is necessary that a complete link exists: **source – window – input unit**. The linked source will be displayed in the window.

There is no link when the source-link is **-1**, so an empty window will appear!

Multiple windows can display the same source.

Input Unit Table:

The input unit table can store parameters for 4 (0..3) different input units. Parameters are all for internal use!

The input units are numbered continuously beginning with the input units of the Visu^{PLUS} that is connected directly to the EOS or control PC (**VisuNr = 0**), continuing with the input units of the next Visu^{PLUS} in the chain (**VisuNr = 1**). The number of the input unit (**IpuNr**) is then:

$$\text{IpuNr} = \text{VisuNr} * 4 + \text{local IPU number}$$

The local IPU number is the same for each unit from top to bottom **0, 1, 2, 3**.

An input unit of this table can be linked to a window. This input will be used to display the source linked to that window. After start up of the Visu^{PLUS} all windows are linked to the sources on a one-to-one bases. (window 0 → source 0, window 1 → source 1, ...)

There is no link when the window-link is **-1**, so this input unit is not used at a certain time!

Multiple input units, of different Visu^{PLUS}, can be used to display one window.

6.4 VISU^{PLUS} Operation Protocol

The VISU^{PLUS}-operation protocol is completely ASCII based. Characters are placed in capitals. Numbers are transferred as ASCII coded words (example number -128 is transferred as ASCII(-128)). Every command (send from host computer or returning from VISU^{PLUS}) must end with a <CR>. The protocol runs on a baudrate of 9600, 19200 or 38400 with (preferred) or without hardware handshaking (RTS/CTS).

Multiple VISU^{PLUS} are placed in a chain and all the configuration commands must be send to the first VISU^{PLUS} in the chain. This VISU^{PLUS} takes care of the communication towards the other VISU^{PLUS}.

One command cycle can be separated into several parts:

- ▶ Command send to first VISU^{PLUS} in chain.
- ▶ Write command: Error and/or Info messages coming back from first VISU^{PLUS} in chain.
Read command: Return value coming back from first VISU^{PLUS} in chain.
- ▶ **ACK / NACK** coming back from first VISU^{PLUS} in chain.

6.4.1 Error / Info messages

An info message gives information about the currently executed command.

Syntax:

```
VISU INFO VISU <VisuNr>: <InfoMessage> <CR>
```

An Error message gives error information about the currently executed command.

Syntax:

```
VISU ERROR VISU <VisuNr>: <ErrorMessage> <CR>
```

6.4.2 Return value

A return value comes back when the VISU^{PLUS} is executing a read command.

Syntax:

```
VISU <ReturnValue> <CR>
```

6.4.3 ACK / NACK

Every command send to the VISU^{PLUS} is acknowledged (**ACK**) or not acknowledged (**NACK**) by this VISU^{PLUS}. You get an Acknowledge when no error has occurred during the execution of a command. You can get a not Acknowledge when an error has occurred during the execution of a command.

Syntax:

```
VISU ACK <CR>
```

```
VISU NACK <CR>
```

6.5 Commands

There are two ways of sending commands to a VISU^{PLUS}.

One way is sending the complete ASCII command name.

The other way is sending a command shortcut, which is a ASCII(#) followed by the command index incremented by the ASCII(A). This method improves the speed of communication. It also don't send info messages to its LCD-display or source of commands (EOS / control PC).

Overview

The table below gives a brief overview about the VISU^{PLUS} commands. You find a detailed description of the commands further on in this section.

command	shortcut	description
<CR>		check for answer of first VISU ^{PLUS}
SET_BAUDRATE	#[defines VISU ^{PLUS} baudrate
AUTO_CONFIG	#W	configuration of VISU ^{PLUS} chain
VERBOSE	#Z	enable/disable VISU ^{PLUS} from sending info messages
HW_SET_PARAM	#U	set hardware parameters
HW_GET_PARAM	#V	get hardware parameters
OPU_SET_POS	#P	reinitialize VISU ^{PLUS} / set position of VISU ^{PLUS} output units
OPU_SET_PARAM	#Q	set parameters of an output unit
OPU_GET_PARAM	#R	get parameters of an output unit
IPU_LNK_TO_WIN	#C	link an input unit to a window
WIN_LNK_TO_SRC	#M	link a window to a source
WIN_SET_POS	#D	size and position of a window
WIN_SET_VIEWPORT	#E	specifies the visible portion of a source in its window
WIN_BRING_TO_TOP	#F	bring a window to top
WIN_SHOW	#G	show/hide a window
WIN_SET_PARAM	#H	set parameter of a window(non video/RGB specific)
WIN_GET_PARAM	#I	get a parameter of a window (non video/RGB specific)
SRC_SET_PARAM	#N	set parameters of a source
SRC_GET_PARAM	#O	get parameters of a source
ENABLE_UPDATE	#X	enable (force)/disable update of the Screen
TRY_ENABLE_UPDATE	#Y	try update of the screen
VERSION	#\	retrieves VISU ^{PLUS} internal software version

Table 6-2
Visu^{Plus} commands - overview

6.5.1 <CR>

The <CR> command is used to check if the first VISU^{PLUS} answers. The first VISU^{PLUS} sends its prompt VISU> back to the host computer. This is the only command that doesn't end with ACK or NACK!

Syntax:

```
VISU <CR>
```

Return from first Visu^{PLUS}:

```
VISU>
```

6.5.2 SET_BAUDRATE

The baudrate of the VISU^{PLUS} is always 9600 Baud at start-up. The SET_BAUDRATE command can change this towards higher baudrates, like 19600 and 38400 Baud.

Syntax:

```
VISU SET_BAUDRATE <Value> <CR>
```

```
VISU #[ <Value> <CR>
```

Arguments of SET_BAUDRATE:

Value	Description
96	baudrate set to 9600 baud
196	baudrate set to 19600 baud
384	baudrate set to 38400 baud

Table 6-3
arguments of SET_BAUDRATE command

6.5.3 AUTO_CONFIG

The AUTO_CONFIG command configures the VISU^{PLUS} chain, so that every VISU^{PLUS} knows its number in the chain.

Syntax:

```
VISU AUTO_CONFIG 0 <LastVisuNrInChain> <CR>
```

```
VISU #W 0 <LastVisuNrInChain> <CR>
```

Example with a chain of four VISU^{PLUS}:

```
VISU AUTO_CONFIG 0 3
```

6.5.4 VERBOSE

The VERBOSE command enables or disables the VISU^{PLUS} from sending **INFO** messages.

Syntax:

```
VISU VERBOSE <VALUE> <CR>
VISU #Z <VALUE> <CR>
```

Arguments of VERBOSE:

Value	Description
0	disable the VISU ^{PLUS} from sending INFO messages
1	enable the VISU ^{PLUS} to send INFO messages

Table 6-4
arguments of VERBOSE command

6.5.5 HW_SET_PARAM / HW_GET_PARAM

The HW_SET_PARAM command is used to configure hardware parameters. With the HW_GET_PARAM command it is possible to retrieve a hardware parameter.

Syntax:

```
VISU HW_SET_PARAM <PARAMETER> <VALUE> <CR>
VISU #U <PARAMETER> <VALUE> <CR>

VISU HW_GET_PARAM <PARAMETER> <CR>
VISU #V <PARAMETER> <CR>
```

Parameters and correlated values:

Parameter	Value	Description
0	1 . . 511	horizontal phase (Hphase)
1	1 . . 255	vertical phase (Vphase)
2	0 1	enables / disables standalone mode: VISU ^{PLUS} – EOS setup: synchronize VISU ^{PLUS} on external Syncs VISU ^{PLUS} standalone setup: synchronize VISU ^{PLUS} on internal generated Syncs
3	1 . . 1023	line period for internal generated horizontal sync calculation: 33*Requested LineTime (µs) ; only valid for VISU ^{PLUS} –standalone setup
4	1 . . 63	horizontal sync width; only valid for VISU ^{PLUS} –standalone setup
5	1 . . 2047	internal total pixels per line (HTotalVisu) calculation: (67*HTotalOutput)/PxIClk where PxIClk is output pixelclock in MHz
6	1 . . 2047	total lines per frame
24	1 . . 1024 > 1024	horizontal resolution: value remains the indicated value value / 2 (e.g. 1280 → 640)

25	1 . . 1024	vertical resolution
26	1 . . 16 0	horizontal orbit size (HorbitSize): for VISU ^{PLUS} on CRT projectors for all other cases
27	1 . . 16 0	vertical orbit size (VorbitSize): for VISU ^{PLUS} on CRT projectors for all other cases
28	(Hphase - HorbitSize) .. (Hphase)	horizontal orbit step Only valid when orbiting is used!
29	(Vphase - VorbitSize) .. (Vphase)	vertical orbit step Only valid when orbiting is used!
34	1 . . 2047	output total pixels per line (HTotalOutput)
35	0 . . 3	frameRateDivider: Reduces processing framerate, with 0 full framerate mode
37	2 3	output Type analog VISU ^{PLUS} digital VISU ^{PLUS}
44	1 0	freezes all inserted images on the wall freeze inserted images unfreeze all inserted images
45	0 . . 255	color key, red component; to use with digital VISU ^{PLUS} only
46	0 . . 255	color key, green component; to use with digital VISU ^{PLUS} only
47	0 . . 255	color key, blue component; to use with digital VISU ^{PLUS} only
48	0 . . 255	background, red component; to use with digital VISU ^{PLUS} only
49	0 . . 255	background, green component; to use with digital VISU ^{PLUS} only
50	0 . . 255	background, blue component; to use with digital VISU ^{PLUS} only

Table 6-5
arguments of HW_SET_PARAM / HW_GET_PARAM commands

6.5.6 OPU_SET_POS

The OPU_SET_POS command has two functions. One of them is reinitializing the VISU^{PLUS}. The other one is used to give a specific output unit an X and Y coordinate. These coordinates are the physical position of the outputs on the matrix of the Display Wall.

Syntax for Reinitializing:

```
VISU OPU_SET_POS -1 -1 -1 <CR>
VISU #P -1 -1 -1 <CR>
```

Syntax for Positioning

```
VISU OPU_SET_POS <OpuNr> <X> <Y> <CR>
VISU #P <OpuNr> <X> <Y> <CR>
```

For the numbering of the output units see section 3.2.3 Digital Output Unit.

Argument	Value	Description
<OpuNr>		indication of output unit
<X>	1 . . 255	x coordinate of the output in the wall
<Y>	1 . . 255	y coordinate of the output in the wall

Table 6-6
arguments of OPU_SET_POS command

Example:

OPU: 0 X: 0 Y: 0	OPU: 1 X: 1 Y: 0	OPU: 4 X: 2 Y: 0	OPU: 5 X: 3 Y: 0
OPU: 2 X: 0 Y: 1	OPU: 3 X: 1 Y: 1	OPU: 6 X: 2 Y: 1	OPU: 7 X: 3 Y: 1

Figure 6-2
numbering of OPU's and projection modules

```
VISU OPU_SET_POS 0 0 0 <CR>
VISU OPU_SET_POS 1 1 0 <CR>
VISU OPU_SET_POS 2 0 1 <CR>
VISU OPU_SET_POS 3 1 1 <CR>
VISU OPU_SET_POS 4 2 0 <CR>
VISU OPU_SET_POS 5 3 0 <CR>
VISU OPU_SET_POS 6 2 1 <CR>
VISU OPU_SET_POS 7 3 1 <CR>
```

6.5.7 OPU_SET_PARAM / OPU_GET_PARAM

The OPU_SET_PARAM command is used to configure output unit specific settings.

The OPU_GET_PARAM command is used to retrieve those settings.

Syntax:

```
VISU OPU_SET_PARAM <OpuNr> <Parameter> <Value> <CR>
```

```
VISU #Q <OpuNr> <Parameter> <Value> <CR>
```

```
VISU OPU_GET_PARAM < OpuNr> < Parameter> <CR>
```

```
VISU #R < OpuNr> < Parameter> <CR>
```

Parameters and correlated values:

Parameter	Value	Description
0	1..127	output insertion image red gain
1	1..127	output insertion image cut off
2	1..127	output insertion image green gain
3	1..127	output insertion image green off
4	1..127	output insertion image blue gain
5	1..127	output insertion image blue off
6	1	updates Ramdac color table after loading parameter
7	0..63	output sampling phase: adapt insertion image on external (EOS image) one

Table 6-7
parameters of OPU_SET_PARAM / OPU_GET_PARAM command

6.5.8 IPU_LNK_TO_WIN

The IPU_LNK_TO_WIN command is used to link physical input units (Video or RGB) to Windows.

One VISU^{PLUS} unit can contain up to four input units and four output units. But for bigger Display Walls, multiple VISU^{PLUS} need to be cascaded. If you want to display one window with the same source on more than four output units, one input unit of every VISU^{PLUS} needs to have that source as input (loop-through, matrix-switcher, ...). All the VISU^{PLUS} need to know what input unit is used to display his portion of the complete window. This is done by the IPU_LNK_TO_WIN command.

Syntax to create or remove a link:

```
VISU IPU_LNK_TO_WIN <IpuNr> <WinNr> <CR>
```

```
VISU #C <IpuNr> <WinNr> <CR>
```

Syntax to remove all links:

```
VISU IPU_LNK_TO_WIN -1 -1 <CR>
```

```
VISU #C -1 -1 <CR>
```



A link must be first removed before a new one can be created!

A link can only be made if a physical board is available!

Values of <WinNr>:

Value	Description
0 . . 63	create link to this window
-1	remove the link, IpuNr not used

Table 6-8
values of <WinNr> of IPU_LNK_TO_WIN command

Example:

```
VISU IPU_LNK_TO_WIN 0 0 <CR> : input unit 0 linked to window 0
VISU IPU_LNK_TO_WIN 1 -1 <CR> : input unit 1 not used
VISU IPU_LNK_TO_WIN 2 1 <CR> : input unit 2 linked to window 1
VISU IPU_LNK_TO_WIN 3 2 <CR> : input unit 3 linked to window 2
VISU IPU_LNK_TO_WIN 4 3 <CR> : input unit 4 linked to window 3
VISU IPU_LNK_TO_WIN 5 -1 <CR> : input unit 5 not used
VISU IPU_LNK_TO_WIN 6 4 <CR> : input unit 6 linked to window 4
VISU IPU_LNK_TO_WIN 7 1 <CR> : input unit 7 linked to window 1, a loop through
from input unit 2
```

6.5.9 WIN_LNK_TO_SRC

The WIN_LNK_TO_SRC command is used to link a window to sources.

Syntax to create or remove a link:

```
VISU WIN_LNK_TO_SRC <WinNr> <SrcNr> <CR>
VISU #M <WinNr> <SrcNr> <CR>
```

Syntax to remove all links:

```
VISU WIN_LNK_TO_SRC -1 -1 <CR>
VISU #M -1 -1 <CR>
```

Values of <SrcNr>:

Value	Description
0 . . 63	create link to this window
-1	remove the link, IpuNr not used

Table 6-9
values of <SrcNr> of WIN_LINK_TO_SRC command



A link must first be removed before a new one can be created!

6.5.10 WIN_SET_POS

The WIN_SET_POS command places a specified window on a specified place with a specified size.

Syntax:

```
VISU WIN_SET_POS <WinNr> <XStart> <YStart> <XEnd> <YEnd> <CR>
VISU #D <WinNr> <XStart> <YStart> <XEnd> <YEnd> <CR>
```

6.5.11 WIN_SET_VIEWPORT

The WIN_SET_VIEWPORT specifies the displayed portion of a source in its window. The viewport values are given in pro mile!

Syntax:

```
VISU WIN_SET_VIEWPORT <WinNr> <XStart> <YStart> <XEnd> <YEnd>
↳ <CR>
VISU #E <WinNr> <XStart> <YStart> <XEnd> <YEnd> <CR>
```

6.5.12 WIN_BRING_TO_TOP

The WIN_BRING_TO_TOP command brings a **WinNR**-window to the top.

Syntax:

```
VISU WIN_BRING_TO_TOP <WinNR> <CR>
VISU #F <WinNR> <CR>
```

6.5.13 WIN_SHOW

The WIN_SHOW command makes it possible to show or hide a window.

Syntax:

```
VISU WIN_SHOW <WinNr> <Value> <CR>
```

Values of <Value>:

Value	Description
0	hide window
1	show window

Table 6-10
values of <Value> of WIN_SHOW command

6.5.14 WIN_SET_PARAM / WIN_GET_PARAM

The WIN_SET_PARAM command is used to configure source independent window settings. The WIN_GET_PARAM command is used to retrieve those settings.

Syntax:

```
VISU WIN_SET_PARAM <WinNr> <Parameter> <Value> <CR>
```

```
VISU #H <WinNr> <Parameter> <Value> <CR>
```

```
VISU WIN_GET_PARAM <WinNr> <Parameter> <CR>
```

```
VISU #I <WinNr> <Parameter> <CR>
```

Parameters and correlated values:

Parameter	Value	Description
0	0..100	window sharpness
1	0 1	freeze/unfreeze source in window unfreeze (default) freeze
2	0 1 2 3 4	force horizontal scaling no scaling (default) force scaling divide by 2 force scaling divide by 3 force scaling divide by 4 force scaling divide by 5
3	0 1 2 3 4	force vertical scaling no scaling (default) force scaling divide by 2 force scaling divide by 3 force scaling divide by 4 force scaling divide by 5

Table 6-11
arguments of WIN_SET_PARAM / WIN_GET_PARAM commands

6.5.15 SRC_SET_PARAM / SRC_GET_PARAM

The SRC_SET_PARAM command is used to configure source specific settings.

The SRC_GET_PARAM command is used to retrieve those settings.

Syntax:

```
VISU SRC_SET_PARAM <SrcNr> <SrcType> <Parameter> <Value> <CR>
VISU #N <SrcNr> <SrcType> <Parameter> <Value> <CR>

VISU SRC_GET_PARAM <SrcNr> <SrcType> <Parameter> <CR>
VISU #O <SrcNr> <SrcType> <Parameter> <CR>
```

Values of <SrcType>:

Value	Description
3	video input
5	RGB input

Table 6-12
values of <SrcType> of SRC_SET_PARAM / SRC_GET_PARAM command

Video parameters and correlated values:

Parameter	Value	Description
0		source input type
	0	BNC input
	1	SVHS input
1	0 . . 511	video contrast
2	-128 . . 127	video brightness
4	-128 . . 127	video hue
5	0 . . 511	video chroma U
6	0 . . 511	video chroma V
7		video format
	0	auto
	1	auto
	2	PAL forced
	3	PAL-N forced
	4	PAL-N combination forced
	5	PAL-M forced
	6	NTSC-M forced
	7	NTSC-Japan forced
8	SECAM forced	

Table 6-13
video parameters of SRC_SET_PARAM / SRC_GET_PARAM command

RGB parameters and correlated values:

Parameter	Value	Description
0		source input type
	0	disabled
	1	enabled
1	0 . . 1280	horizontal resolution
2	0 . . 1024	vertical resolution
3	0 . . 511	horizontal phase
4	0 . . 255	vertical phase
5	0 . . 2047	horizontal total pixels
6	0 . . 31	sampling phase
7	0 . . 67	red coarse gain
8	0 . . 31	red fine gain
9	0 . . 255	red cut off
10	0 . . 67	green coarse gain
11	0 . . 31	green fine gain
12	0 . . 255	green cut off
13	0 . . 67	blue coarse gain
14	0 . . 31	blue fine gain
15	0 . . 255	blue cut off
16	0 . . 67	red coarse gain offset
17	0 . . 31	red fine gain offset
18	0 . . 255	red cut off offset
19	0 . . 67	green coarse gain offset
20	0 . . 31	green fine gain offset
21	0 . . 255	green cut off offset
22	0 . . 67	blue coarse gain offset
23	0 . . 31	blue fine gain offset
24	0 . . 255	blue cut off offset

Table 6-14
RGB parameters of SRC_SET_PARAM / SRC_GET_PARAM command

6.5.16 ENABLE_UPDATE

The `ENABLE_UPDATE` command enables or disables the updating of the Display Wall. When disabled, values can be loaded to the `VISUPLUS`, but will not be updated on the Display Wall. When enabled, a forced update will be done and loading new parameters will every time update the Display Wall.

Use this command to disable screen-updates before loading new parameters to the `VISUPLUS`, and enable it again afterwards to force a complete update.

The command must be used as follows:

- ▶ Disable update.
- ▶ Send all necessary window and source commands (`WIN_SET_POS`, `WIN_SHOW`, `WIN_TO_TOP`).
- ▶ Enable (force) update.

Syntax:

```
VISU ENABLE_UPDATE <Value> <CR>
```

```
VISU #X<Value> <CR>
```

Values:

Value	Description
0	disable updating
7	enable (force) updating

Table 6-15
values of `ENABLE_UPDATE` command

6.5.17 TRY_ENABLE_UPDATE

The TRY_ENABLE_UPDATE tries an update to see if there is bandwidth enough within the VISU^{PLUS} to transfer all source data from inputs to outputs.

Syntax:

```
VISU TRY_ENABLE_UPDATE <CR>
VISU #Y <CR>
```

If there is bandwidth enough, no error messages will come back; it can be proceeded with a real ENABLE_UPDATE. Sometimes there is not enough bandwidth (especially with high-resolution RGB sources), following error message will be sent back from the VISU^{PLUS}:

Syntax:

```
VISU ERROR VISU <VisuNr>: Insufficient transfer bandwidth
↳ <AmountOfValues> <WinNr> ... <WinNr>
```

Arguments:

Arguments	Description
<AmountOfValues>	amount of following values
<WinNr>	a window number, which has bandwidth problems

Table 6-16
arguments of TRY_ENABLE_UPDATE command

The first thing to do to solve those problems is reducing the processing frame rate (see HW_SET_PARAM) and retry. Only reduce it to halve the frame rate (Value = 1) when video is used! You can go further when using RGB. When this is not enough you can always start to force downscaling of sources (see WIN_SET_PARAM).

6.5.18 VERSION

This command retrieves the version of the software running on the VISU^{PLUS}.

Syntax:

```
VISU VERSION <CR>
VISU #X <CR>
```

Return Value:

```
Version visu960 : vX.X.X.X
```

6.6 Way of operations

Configuration of Visu^{PLUS}

Following describes the order in which the VISU^{PLUS} has to be configured:

- ▶ Check communication with the first VISU^{PLUS} in the chain
VISU<CR>
- ▶ Change baudrate if required
VISU SET_BAUDRATE <Value> <CR>
- ▶ Configure the chain
VISU AUTO_CONFIG 0 <LastVisuNrInChain> <CR>
- ▶ Updates disabled
VISU ENABLE_UPDATE 0 <CR>
- ▶ Reinitialize VISU^{PLUS}
VISU OPU_SET_POS -1 -1 -1 <CR>
- ▶ Define all hardware parameters
VISU HW_SET_PARAM <Parameter> <Value> <CR>
- ▶ Define all Output-coordinates
VISU OPU_SET_POS <OpuNr> <X> <Y> <CR>
- ▶ Define all Source parameters
VISU SRC_SET_PARAM <SrcNr> <SrcType> <Parameter> <Value> <CR>
- ▶ Reset default links between input units → windows → sources
VISU IPU_LNK_TO_WIN -1 -1 <CR>
VISU WIN_LINK_TO_SRC -1 -1 <CR>
- ▶ (Re-) Define links between input units → windows → sources
VISU IPU_LNK_TO_WIN <IpuNr> <WinNr> <CR>
VISU WIN_LNK_TO_SRC <WinNr> <SrcNr> <CR>
- ▶ Define Windows position, size, viewport and priority starting with the one that has the lowest priority.
VISU WIN_SET_POS <WinNr> <XStart> <YStart> <XEnd> <YEnd> <CR>
VISU WIN_SET_VIEWPORT <WinNr> <XStart> <YStart> <XEnd> <YEnd>
⌨ <CR>
VISU WIN_SHOW <WinNr> <Value> <CR>
VISU WIN_BRING_TO_TOP <WinNr> <CR>
- ▶ Try update and solve bandwidth problems
VISU TRY_ENABLE_UPDATE <CR>
- ▶ Enable (force) update
VISU ENABLE_UPDATE 7 <CR>

Operation of Visu^{PLUS}

Following describes the operation of VISU^{PLUS} after configuration:

- ▶ disable updates

```
VISU ENABLE_UPDATE 0 <CR>
```

- ▶ (re-) define Links between input units → windows → sources

```
VISU IPU_LNK_TO_WIN <IpuNr> <WinNr> <CR>
```

```
VISU WIN_LNK_TO_SRC <WinNr> <SrcNr> <CR>
```

- ▶ (re-) define Window position, size, viewport and priority

```
VISU WIN_SET_POS <WinNr> <XStart> <YStart> <XEnd> <YEnd> <CR>
```

```
VISU WIN_SET_VIEWPORT <WinNr> <XStart> <YStart> <XEnd> <YEnd>  
<CR>
```

```
VISU WIN_SHOW <WinNr> <Value> <CR>
```

```
VISU WIN_BRING_TO_TOP <WinNr> <CR>
```

- ▶ try update + solve bandwidth problems

```
VISU TRY_ENABLE_UPDATE <CR>
```

- ▶ enable (force) update

```
VISU ENABLE_UPDATE 7 <CR>
```

- ▶ go back to first point

Updating of Parameters

Source parameters can also be updated during operation if necessary:

```
VISU SRC_SET_PARAM <SrcNr> <SrcType> <Parameter> <Value> <CR>
```

7 Technical Appendix

This chapter provides tabular overviews about the technical details of VISU^{PLUS}, its components and of their interfaces.

7.1 Technical Data

Visu^{PLUS}

dimensions (h/w/d)	177mm/435mm/450mm 6.97 in./17.13 in./17.72 in.
weight	14.6kg 32.2lbs. (base unit) 15,98kg 35.23lbs. (equipped with 4 input and 4 output units)
power mains	90 – 240V, 60 - 50Hz
power supply	150W
operating conditions	0 .. 40° Celsius at max. 80% humidity, non condensing

Table 7-1
properties Visu^{PLUS}

Digital Output Board (DVI)

functions	upscaling source priority digital colorkeying digital insertion in an external signal
resolution & colors	800×600×24bpp 1024×768×24bpp 1280×1024×24bpp
maximum pixelclock	67MHz (internal) 108MHz (from EOS and to projector)
graphical output standard	PanelLink
bus connection	propriety
operating conditions	0..50°C at max. 80% humidity, non condensing
dimensions	220mm×117mm
plugs	1 55pin 2mm ZPAQ connector to the VISU propriety bus 2 DVI-D connectors

Table 7-2
properties digital output board DVI

Digital Output Board (MDR26)

functions	upscaling source priority digital colorkeying digital insertion in an external signal
resolution & colors	800×600×24bpp 1024×768×24bpp 1280×1024×24bpp
maximum pixelclock	67MHz (internal) 112MHz(from EOS and to projector)
graphical output standard	PanelLink
bus connection	propriety
operating conditions	0..50°C at max. 80% humidity, non condensing
dimensions	220mm×117mm
plugs	1 55pin 2mm ZPAQ connector to the VISU propriety bus 2 26pin PanelLink connectors

Table 7-3
properties digital output board MDR26

Analog Output Board

functions	upscaling source priority analog colorkeying analog insertion in an external signal
resolution & colors	800×600×24bpp 1024×768×24bpp 1280×1024×24bpp
maximum pixelclock	67MHz (internal) 134MHz(from EOS and to projector)
graphical output standard	RGsB RGB HV
bus connection	propriety
operating conditions	0..50°C at max. 80% humidity, non condensing
dimensions	220mm×117mm
plugs	1 55pin 2mm ZPAQ connector to the VISU propriety bus 1 15pin SubMinD HD male connector, VGA compatible 1 15pin SubMinD HD female connector, VGA compatible

Table 7-4
properties analog output board

RGB Input Board

functions	A/D conversion downscaling frame rate control
maximal resolution	1280×1024×24bpp
maximum pixelclock	160MHz
maximum line frequency	100kHz
maximum frame frequency	120Hz
supported sync types	separate sync: Hsync + Vsync composite sync: Csync sync-on-green
color depth	16-bit (R-G-B: 5-6-5)
bus connection	propriety
operating conditions	0..50°C at max. 80% humidity, non condensing
dimensions	220mm×101mm
plugs	1 55pin 2mm ZPAQ connector to the VISU propriety bus 1 15pin SubMinD HD male connector, VGA compatible 1 15pin SubMinD HD female connector, VGA compatible

Table 7-5
properties RGB input board

Video Input Board

functions	video decoding de-interlacing with median filter downscaling frame rate control
video norm	CCIR 601 compatible
color depth	16-bit YUV
bus connection	propriety
operating conditions	0..50°C at max. 80% humidity, non condensing
dimensions	220mm×101mm
plugs	1 55pin 2mm ZPAQ connector to the VISU propriety bus 2 BNC connector 2 4-in mini-DIN connectors

Table 7-6
properties video input board

Processor board

functions	serial communication handling hardware control VISU ^{PLUS} bus control
supported sync types	separate sync: Hsync + Vsync
bus connection	proprierty
operating conditions	0..50°C at max. 80% humidity, non condensing
dimensions	220mm×234mm
plugs	2 55pin 2mm ZPAQ connector to the Visu propriety bus 2 9pin SubMinD connector, RS232 compatible 6 BNC connector

Table 7-7
properties processor board

7.2 Interfaces

Seen from outside VISU^{PLUS}.

Processor Board

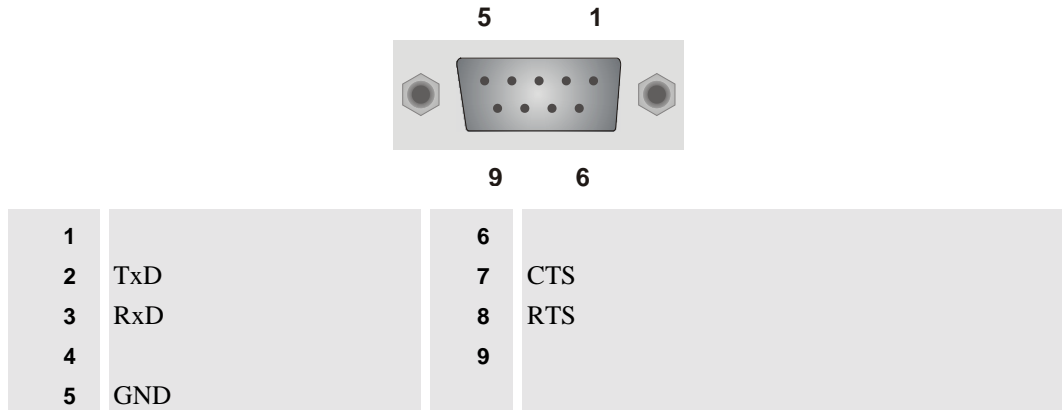

Figure 7-1
D9 female pin assignment

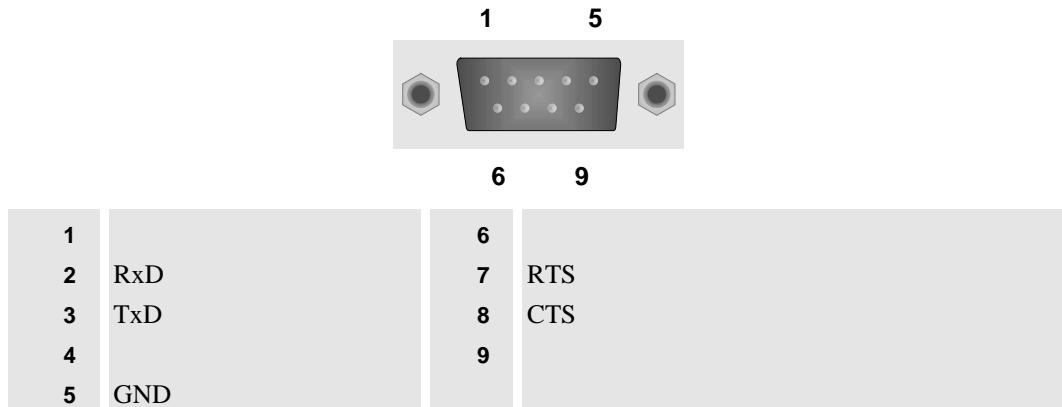

Figure 7-2
D9 male pin assignment

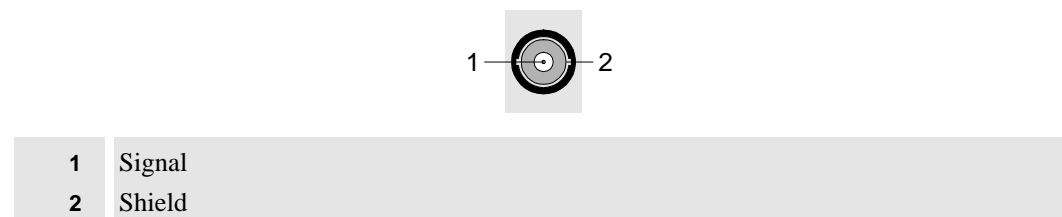
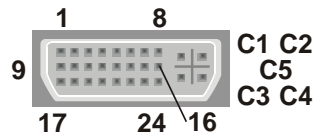

Figure 7-3
BNC connector pin assignment

Digital Output Board DVI



1	Data2-	9	Data1-	17	Data0-
2	Data2+	10	Data1+	18	Data0+
3	Data2 Shield	11	Data1 Shield	19	Data0 Shield
4		12		20	
5		13		21	
6	DDC Clock	14	+5V Power	22	Clock Shield
7	DDC Data	15	Ground (return for +5V, Hsync, and Vsync)	23	Clock+
8		16	Hot Plug Detect	24	Clock-
C1		C5	GND	C3	
C2				C4	

Figure 7-4
DVI in and out connector Panellink pin assignment

Digital Output Board MDR26

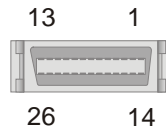

Pin	Panellink	Pin	Panellink
1		14	
2		15	
3		16	
4	RxC-	17	RxC+
5	GND	18	Rx0-
6	Rx0+	19	GND
7		20	
8	GND	21	Rx1-
9	Rx1+	22	GND
10	Rx2-	23	Rx2+
11		24	
12		25	
13		26	

Figure 7-5
MDR26 in connector Panellink pin assignment

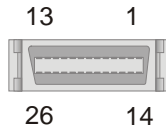

Pin	PanelLink	Pin	PanelLink
1		14	
2		15	
3		16	
4	Tx2+	17	Tx2-
5	GND	18	Tx1+
6	Tx1-	19	GND
7		20	
8	GND	21	Tx0+
9	Tx0-	22	GND
10	TxC+	23	TxC-
11		24	
12		25	
13		26	

Figure 7-6
MDR26 out connector PanelLink pin assignment

Analog Output Board, RGB in – RGB input unit, RGB out

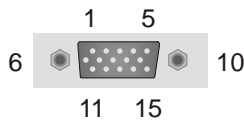

1	red	6	red GND	11	
2	green	7	green GND	12	
3	blue	8	blue GND	13	HSYNC
4		9		14	VSYNC
5		10	sync GND	15	

Figure 7-7
RGB male connector pin assignment

Analog Output Board, RGB out – RGB Input Unit, RGB in

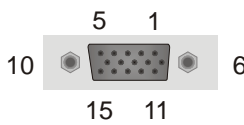

1	red	6	red GND	11	
2	green	7	green GND	12	
3	blue	8	blue GND	13	HSYNC
4		9		14	VSYNC
5		10	sync GND	15	

Figure 7-8
RGB female connector pin assignment

Video Input Board, Video in/out

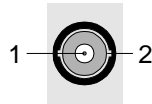

1	Signal
2	Shield

Figure 7-9
BNC connector pin assignment

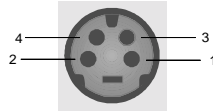

S-Video	
1	GND
2	GND
3	Y
4	C

Figure 7-10
4-pole mini-DINconnector pin assignment

Reset Cable (D25 – BNC)

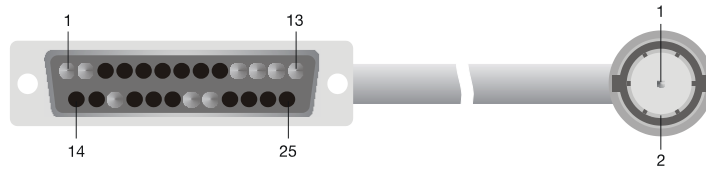

to pin10	1	signal	1
to pin 1	10		
to pin 21	11	shield	2
to pin 16	12		
to pin 13	13	shield	2
to pin 13	16		
to pin 11	20		
to pin 11	21		

Figure 7-11
reset cable pin assignment

Load Cable (D9 – D9)

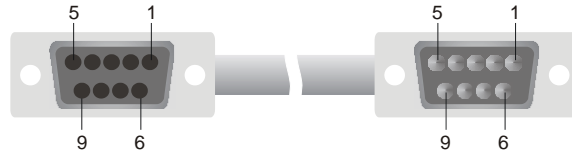

	1	–	1
	2	–	2
	3	–	3
	4	–	4
	5	–	5
	6	–	6
	7	–	7
	8	–	8
	9	–	9

Figure 7-12
load cable pin assignment

7.3 Order Codes

Hardware	
R5976214	user's manual VISU ^{PLUS} Video Insertion Unit, English
RSDOC30612	user's manual EOS X Terminal, English
R9830602	VISU ^{PLUS} base unit
R9842140	digital output board DVI
R9830621	analog output board, to be used in VISU ^{PLUS} – EOS setup
R9830623	analog output board, to be used in VISU ^{PLUS} stand alone setup
R9830611	video input board
R9830646	RGB input board, compatible with XGA and SXGA
R7626261	back plane
R7626275	processor board
R9832060	control PC, Linux
R347989	dust filter
	Data cables and adapters
RSGBP27122	MDR26 <-> MDR26, max. XGA, 2 m
RSGBP27123	MDR26 <-> MDR26, max. XGA, 10 m
RSGBP27124	MDR26 <-> MDR26, max. XGA, 1,5 m
RSCBL31360	DVI-D -> MDR26, max. XGA, 1,5 m
RSCBL31361	DVI-D -> MDR26, max. XGA, 2 m
RSCBL31362	DVI-D -> MDR26, max. XGA, 10 m
RSCBL31890	MDR26 -> DVI-D, max. XGA, 1,5 m
RSCBL31891	MDR26 -> DVI-D, max. XGA, 2 m
RSCBL31892	MDR26 -> DVI-D, max. XGA, 10 m
RSCBL32060	DVI-D <-> DVI-D, max. SXGA, 2 m
RSCBL32062	DVI-D <-> DVI-D, max. XGA, 5 m
RSCBL32063	DVI-D <-> DVI-D, max. XGA, 10 m
RSCBL32040	DVI-D <-> DVI-D optical, max. SXGA, 10 m
RSCBL32041	DVI-D <-> DVI-D optical, max. SXGA, 20 m
RSCBL32042	DVI-D <-> DVI-D optical, max. SXGA, 50 m
RSCBL32030	MDR26 -> DVI-D adapter
RSCBL32050	DVI-D -> MDR26 adapter
Software	
RSCRS31972	user's manual APOLLO
RSCRS3045B	APOLLO, basic package (containing:
RSCRS30451	Desktop Management
RSCRS30452	Remote Pointer
RSCRS30455	Device Control)
R9830830	APOLLO, full package (containing:
RSCRS30453	Apollo basic package
RSCRS30454	Video viewers (required for VISU ^{PLUS})
RSCRS30451	Screen viewer
	Screen scraper)

R5976144	user's manual OSIRIS
R9832080	VISU ^{PLUS} support license
R9830830	OSIRIS Wall Management Software, Basic (containing:
R9832000	Base module
R9832001	remote pointer
R9832002	VISU ^{PLUS} insertion
R9832003	projector control module
R9832004	control manager)
R9830835	OSIRIS Wall Management Software, Full Version (containing:
	OSIRIS Basic
R9832005	matrix switch control module
R9832006	UPS security control module
R9832007	external serial device module)
R9832020	license OSIRIS for VISU ^{PLUS} stand alone

Table 7-8
order codes

8 Troubleshooting

Check this chapter for help, if your VISU^{PLUS} does not operate properly and for information how to contact the technical support of BARCO.

8.1 Communication to VISU^{PLUS} Fails

The LCD display on the front of VISU^{PLUS} shows system messages concerning operation and errors.

The error messages that may appear, are all related with commands sent from an EOS or control PC. The software on these devices will take care of the generated error messages.

In the case that the communication to the VISU^{PLUS} (-chain) fails (e.g. **no host present** – message) the following should be done:

▶ **Check the control cabling of the processor board:**

The VISU^{PLUS} load cabling or the VISU^{PLUS} reset cabling may be not correct or incomplete. See section [3.3.1 Connecting](#) to check if the cabling is correct. Verify all connections.

▶ **Restart Visu^{Plus}:**

After checking the cabling and correcting it, if necessary, power off all VISU^{PLUS} in the chain, wait one minute and power on the VISU^{PLUS} again. Retry the download.

▶ **Check result:**

Check if the download has taken place correctly. If it still is not successful call for technical assistance, see section [8.2 Hot Line](#). To provide information for the technical assistance, please continue with error detection as follows:

▶ **Status LED:**

Check the **status LED** on the front of all VISU^{PLUS}, see section [3.1.1 VisuPlus](#).

If one or more are **on**, remove the **VisuPlus reset cable** from the **RS232 in** connector **[1]** of the processor board, [3.2.7 Processor Board](#) and check again the **status LED**. Please report this reaction of the **status LED** as well to the technical assistance.

If the **status LEDs** are **off**, check the LCD panel of the first VISU^{PLUS} in the chain. Is there - readable - text on the display? What text?

8.2 Hot Line

Feel free to contact us if you have any further questions!

▶ **BARCO N.V. Projection Systems - Europe**

Nordlaan 5, B-8520 Kuurne

Phone: +32-56-368-211, Fax: +32-56-368-251

E-mail: support.bcd@barco.com, Web: www.barcocontrolrooms.com

9 Index

9.1 Table of Tables

Table 2-1 interaction of VISU ^{PLUS} , OSIRIS and X Server	2-4
Table 3-1 color coding of BNC connectors	3-10
Table 4-1 supported video standards	4-3
Table 4-2 display properties of RGB input unit	4-4
Table 6-1 syntax elements of Visu ^{Plus} commands	6-2
Table 6-2 Visu ^{Plus} commands - overview	6-5
Table 6-3 arguments of SET_BAUDRATE command	6-6
Table 6-4 arguments of VERBOSE command	6-7
Table 6-5 arguments of HW_SET_PARAM / HW_GET_PARAM commands	6-8
Table 6-6 arguments of OPU_SET_POS command	6-9
Table 6-7 parameters of OPU_SET_PARAM / OPU_GET_PARAM command	6-10
Table 6-8 values of <WinNr> of IPU_LNK_TO_WIN command	6-11
Table 6-9 values of <SrcNr> of WIN_LINK_TO_SRC command	6-11
Table 6-10 values of <Value> of WIN_SHOW command	6-12
Table 6-11 arguments of WIN_SET_PARAM / WIN_GET_PARAM commands	6-13
Table 6-12 values of <SrcType> of SRC_SET_PARAM / SRC_GET_PARAM command	6-14
Table 6-13 video parameters of SRC_SET_PARAM / SRC_GET_PARAM command	6-14
Table 6-14 RGB parameters of SRC_SET_PARAM / SRC_GET_PARAM command	6-15
Table 6-15 values of ENABLE_UPDATE command	6-16
Table 6-16 arguments of TRY_ENABLE_PUPDATE command	6-17
Table 7-1 properties VISU ^{PLUS}	7-2
Table 7-2 properties digital output board	7-2
Table 7-3 properties analog output board	7-3
Table 7-4 properties RGB input board	7-4
Table 7-5 properties video input board	7-4
Table 7-6 properties processor board	7-5
Table 7-7 order codes	7-12

9.2 Table of Figures

Figure 1-1 CEE 7 plug	1-5
Figure 1-2 ANSI 73.11 plug	1-5
Figure 2-1 VISU ^{PLUS} – EOS setup	2-2
Figure 2-2 VISU ^{PLUS} – standalone setup	2-3
Figure 3-1 front view of VISU ^{PLUS}	3-2
Figure 3-2 rear view of VISU ^{PLUS}	3-3
Figure 3-3 mains connection of VISU ^{PLUS}	3-5
Figure 3-4 digital output unit (DVI)	3-6
Figure 3-5 DVI-D to DVI-D cable	3-6
Figure 3-6 numbering of output units	3-7
Figure 3-7 output units in multiple VISU ^{PLUS}	3-7
Figure 3-9 digital output unit	3-8
Figure 3-10 PanelLink cable	3-8
Figure 3-11 analog output unit	3-9
Figure 3-12 D15 – D15 cable	3-10
Figure 3-13 D15 – BNC cable	3-10
Figure 3-14 video input unit	3-11
Figure 3-15 numbering of input units	3-11
Figure 3-16 input units in multiple VISU ^{PLUS}	3-11
Figure 3-17 RGB input unit	3-12
Figure 3-18 processor board	3-13
Figure 3-19 VISU ^{PLUS} load cable	3-14
Figure 3-20 VISU ^{PLUS} reset cable	3-14
Figure 3-21 BNC - BNC cable	3-15
Figure 3-22 data and control cabling: VISU ^{PLUS} – EOS setup, digital	3-17
Figure 3-23 data and control cabling: Visu ^{Plus} – Eos setup, analog	3-18
Figure 3-24 data and control cabling: Visu ^{Plus} – standalone setup, analog	3-19
Figure 4-1 display without video switcher	4-6
Figure 4-2 display with video switcher	4-6
Figure 6-1 data tables of Visu ^{Plus}	6-3
Figure 6-2 numbering of OPU's and projection modules	6-9
Figure 7-1 D9 female pin assignment	7-6
Figure 7-2 D9 male pin assignment	7-6
Figure 7-3 BNC connector pin assignment	7-6
Figure 7-4 DVI in and out connector PanelLink pin assignment	7-7
Figure 7-6 MDR26 in connector PanelLink pin assignment	7-7
Figure 7-7 MDR26 out connector PanelLink pin assignment	7-8
Figure 7-8 RGB male connector pin assignment	7-8
Figure 7-9 RGB female connector pin assignment	7-8
Figure 7-10 BNC connector pin assignment	7-9
Figure 7-11 4-pole mini-DINconnector pin assignment	7-9
Figure 7-12 reset cable pin assignment	7-9
Figure 7-13 load cable pin assignment	7-10

Free Manuals Download Website

<http://myh66.com>

<http://usermanuals.us>

<http://www.somanuals.com>

<http://www.4manuals.cc>

<http://www.manual-lib.com>

<http://www.404manual.com>

<http://www.luxmanual.com>

<http://aubethermostatmanual.com>

Golf course search by state

<http://golfingnear.com>

Email search by domain

<http://emailbydomain.com>

Auto manuals search

<http://auto.somanuals.com>

TV manuals search

<http://tv.somanuals.com>