

# BarcoiQ GRAPHICS 500



## Owner's Manual

R9002930

R5976367/10  
01/02/2007

**BARCO**

Visibly yours

## Product revision

Software version: V3.10

**Barco nv Presentations**  
Noordlaan 5, 8520 Kuurne  
Phone: +32 56.36.82.11  
Fax: +32 56.35.86.51  
E-mail: [presentations.bid@barco.com](mailto:presentations.bid@barco.com)  
Visit us at the web: [www.barco.com](http://www.barco.com)

Printed in Belgium

## Copyright ©

All rights reserved. No part of this document may be copied, reproduced or translated. It shall not otherwise be recorded, transmitted or stored in a retrieval system without the prior written consent of Barco.

## Federal Communications Commission (FCC Statement)

This equipment has been tested and found to comply with the limits for a class A digital device, pursuant to Part 15 of the FCC rules. These limits are designed to provide reasonable protection against harmful interference when the equipment is operated in a commercial environment. This equipment generates, uses, and can radiate radio frequency energy and, if not installed and used in accordance with the instruction manual, may cause harmful interference to radio communications. Operation of this equipment in a residential area may cause harmful interference, in which case the user will be responsible for correcting any interference.

## Guarantee and Compensation

Barco provides a guarantee relating to perfect manufacturing as part of the legally stipulated terms of guarantee. On receipt, the purchaser must immediately inspect all delivered goods for damage incurred during transport, as well as for material and manufacturing faults Barco must be informed immediately in writing of any complaints.

The period of guarantee begins on the date of transfer of risks, in the case of special systems and software on the date of commissioning, at latest 30 days after the transfer of risks. In the event of justified notice of complaint, Barco can repair the fault or provide a replacement at its own discretion within an appropriate period. If this measure proves to be impossible or unsuccessful, the purchaser can demand a reduction in the purchase price or cancellation of the contract. All other claims, in particular those relating to compensation for direct or indirect damage, and also damage attributed to the operation of software as well as to other services provided by Barco, being a component of the system or independent service, will be deemed invalid provided the damage is not proven to be attributed to the absence of properties guaranteed in writing or due to the intent or gross negligence or part of Barco.

If the purchaser or a third party carries out modifications or repairs on goods delivered by Barco, or if the goods are handled incorrectly, in particular if the systems are commissioned operated incorrectly or if, after the transfer of risks, the goods are subject to influences not agreed upon in the contract, all guarantee claims of the purchaser will be rendered invalid. Not included in the guarantee coverage are system failures which are attributed to programs or special electronic circuitry provided by the purchaser, e.g. interfaces. Normal wear as well as normal maintenance are not subject to the guarantee provided by Barco either.

The environmental conditions as well as the servicing and maintenance regulations specified in the this manual must be complied with by the customer.

## Trademarks

Brand and product names mentioned in this manual may be trademarks, registered trademarks or copyrights of their respective holders. All brand and product names mentioned in this manual serve as comments or examples and are not to be understood as advertising for the products or their manufactures.



# TABLE OF CONTENTS

<b>1. Packaging and Dimensions .....</b>	<b>5</b>
1.1 Box content .....	5
1.2 Projector Packaging .....	5
1.3 Lens Packaging .....	6
1.4 Dimensions .....	6
<b>2. Installation Guidelines.....</b>	<b>9</b>
2.1 Safety warnings .....	9
2.2 Installation guidelines .....	9
2.3 Projector configurations .....	10
2.4 Lenses .....	14
2.4.1 Lenses.....	14
2.4.2 Lens formulas .....	15
2.4.3 Lens installation .....	15
2.4.4 Removing the lens .....	16
2.4.5 Cleaning the lens .....	17
2.5 Batteries .....	17
2.5.1 Battery installation .....	17
<b>3. Connections .....</b>	<b>19</b>
3.1 Power connection .....	19
3.2 Input source connection .....	19
3.2.1 Input section.....	20
3.2.2 Input facilities.....	20
3.3 5-Cable input .....	21
3.4 Composite Video Input .....	22
3.5 S-Video input .....	23
3.6 Digital Visual Interface (DVI) input .....	24
3.7 Computer input .....	25
3.8 Serial Digital Interface (Optional) .....	25
3.9 Audio input/Output (Optional) .....	26
3.10 Communications Connections .....	27
3.10.1 RS232 IN connection .....	27
3.11 Extended configuration .....	27
3.11.1 Introduction.....	27
3.11.2 5 cable extended configuration.....	27
3.11.3 S-Video extended configuration.....	28
3.11.4 Summarizing .....	29
<b>4. Getting started .....</b>	<b>31</b>
4.1 RCU & Local keypad .....	31
4.2 Terminology overview .....	33
4.3 Switching on .....	34
4.4 Lamp runtime .....	35
4.5 Lamp error .....	36
4.6 Quick set up adjustments .....	37
4.6.1 Quick lens Adjustment .....	37
4.6.2 Using the RCU .....	37
4.7 Projector address.....	39
4.7.1 Address setting .....	39
4.7.2 Displaying and Programming addresses into the RCU.....	40
4.8 Controlling the projector.....	40
4.9 Digital Zoom .....	41
4.10 Menu structure.....	41
4.11 Using the menu .....	41
4.12 Using the Dialogboxes .....	42
<b>5. Source Selection .....</b>	<b>45</b>
5.1 Source selection .....	45
5.2 Composite Video .....	46
5.3 S-Video .....	47
5.4 The Video Selector .....	48
<b>6. General Menu .....</b>	<b>51</b>
6.1 Pause .....	51
6.2 Freeze .....	51
6.3 Standby Timer .....	52
6.4 Audio (Optional) .....	53
6.4.1 Audio Setup .....	53
6.4.2 Audio Settings.....	54
6.5 Identification .....	55

<b>7. Image Menu</b>	<b>57</b>
7.1 Settings	57
7.1.1 Contrast	58
7.1.2 Brightness	58
7.1.3 Color	58
7.1.4 Tint (hue)	59
7.1.5 Sharpness	59
7.1.6 Gamma	59
7.1.7 Phase	60
7.1.8 Noise reduction	60
7.2 Aspect ratio	60
7.3 Show native resolution	64
7.4 Keystone	65
7.5 Color temperature	66
7.6 Filmmode detection	67
7.7 Blanking	69
7.8 Input balance	69
7.9 AGC on Video	74
7.10 Manual Gain Control	75
<b>8. Tools Menu</b>	<b>77</b>
8.1 Introduction to PiP	77
8.2 PiP select	79
8.3 PiP add window	79
8.4 PiP remove window	80
8.5 PiP layout	81
8.5.1 PiP Save	81
8.5.2 PiP rename layout	82
8.5.3 PiP delete layout	82
8.6 PiP Adjust	83
8.7 Diagnostics	84
<b>9. Signal Menu</b>	<b>87</b>
9.1 Switching mode	87
9.2 Background	88
<b>10. Lamp Menu</b>	<b>89</b>
10.1 Runtimes	89
10.2 Mode	89
10.3 Power mode (only active in the iQG/R 500)	91
10.4 History	92
10.5 Reset runtime	93
10.6 Runtime warning	94
<b>11. Image files menu</b>	<b>97</b>
11.1 Load file	97
11.2 Auto Image	98
11.3 Edit file	99
11.4 Rename file	102
11.5 Copy	103
11.6 Delete	104
11.7 Forced file load	105
<b>12. Display setup</b>	<b>107</b>
12.1 Full screen representation	107
12.2 Startup screen	107
12.3 Textbox	108
12.4 Take screenshot	108
12.5 Menu bar position	110
12.6 Status bar position	110
12.7 Sliderbox position	111
12.8 AutoImage Setup	112
12.9 Blanking	113
<b>13. Installation menu</b>	<b>115</b>
13.1 Lens adjustments	115
13.2 Projector address	116
13.3 Orientation	117
13.4 Language	118
13.5 Quick access keys	119
13.6 RS232 baudrate	120
13.7 Automatic startup	120
13.8 Security	121
13.9 Change password	123
13.10 Gemini installed (only for GEMINI CADWALL systems ! )	124

<b>A. Cleaning the dustfilters</b> .....	<b>125</b>
A.1 Dustfilters .....	125
A.2 Cleaning .....	125
<b>B. Standard Image Files</b> .....	<b>127</b>
B.1 Table overview .....	127
<b>Glossary</b> .....	<b>133</b>
<b>Index</b> .....	<b>135</b>





# 1. PACKAGING AND DIMENSIONS

## Overview

- Box content
- Projector Packaging
- Lens Packaging
- Dimensions

## 1.1 Box content

---



### CEE7

European power plug to connect the power cord to the wall outlet.

---



### ANSI 73.11

American power plug to connect the power cord to the wall outlet.

---

## Content

- 1 projector (weight  $\pm$  12,6 kg or 27.8 lbs)
- 1 remote control unit RCU + 2 batteries.
- 2 power cables with outlet plug type CEE7 and ANSI 73.11.
- 1 owners manual
- 1 safety manual

## 1.2 Projector Packaging

---

### Way of Packaging

The projector is packed in a carton box. To provide protection during transportation, the projector is surrounded with foam. The package is secured with banding and fastening clips.

### To unpack

1. Release the fastening clips. (image 1-1)
2. Remove the banding. Handle as shown in the drawing.
3. Take the projector out of its shipping carton and place it on a table. (image 1-2)

## 1. Packaging and Dimensions

---

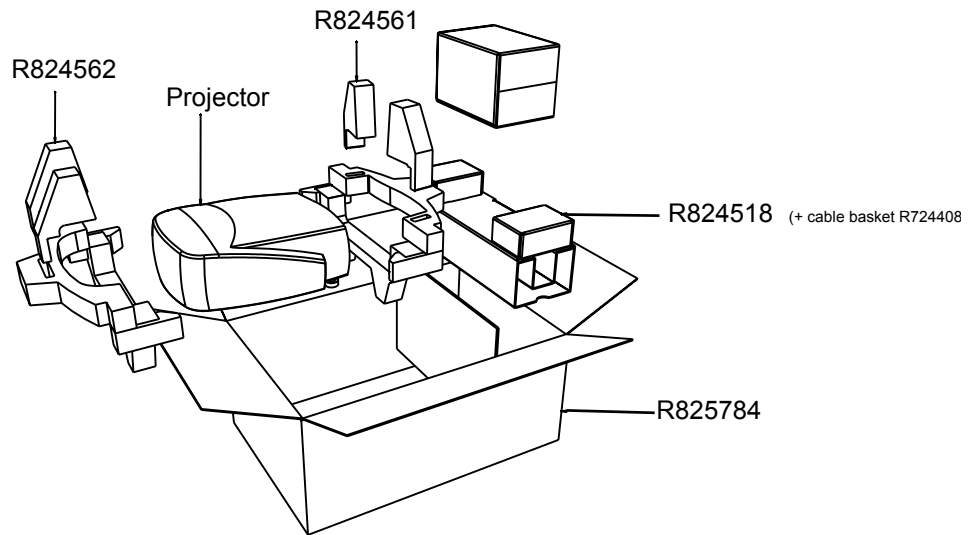
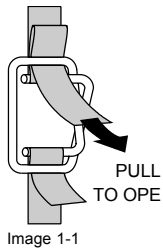

Image 1-2



Save the original shipping carton and packing material, they will be necessary if you ever have to ship your projector. For maximum protection, repack your projector as it was originally packed at the factory.



Save the original shipping carton and packing material, they will be necessary if you ever have to ship your projector. For maximum protection, repack your projector as it was originally packed at the factory.



**CAUTION:** Never transport the projector with the lens mounted on it !  
Always remove the lens before transporting the projector.

## 1.3 Lens Packaging

---

### Way of Packaging

Lenses are supplied as an individual item.

They are packed in a carton box.



Save the original shipping carton and packing material, they will be necessary if you ever have to transport the lens.



**CAUTION:** Never transport the projector with the lens mounted on it !  
Always remove the lens before transporting the projector.

## 1.4 Dimensions

---

### Dimensions overview

Dimensions are given in mm (1 inch = 25.4 mm)

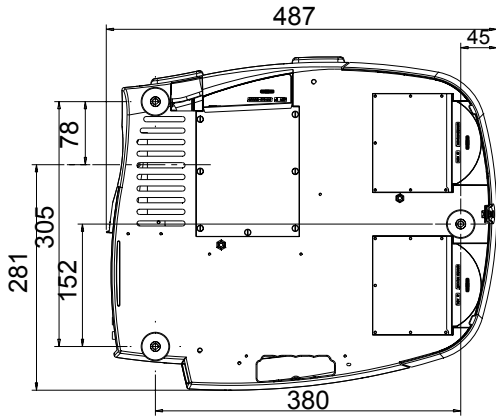

Length with different lenses, see table

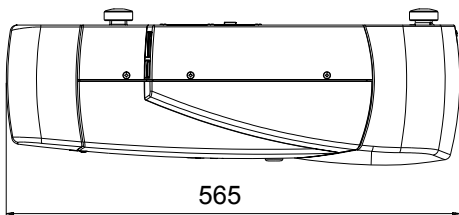
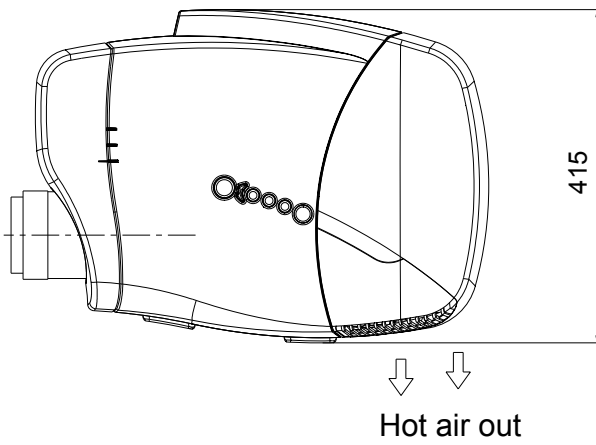
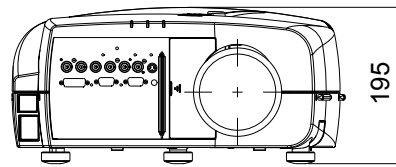
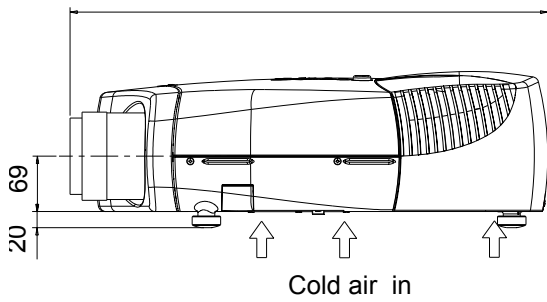

Image 1-3

## 1. Packaging and Dimensions

Lens	length of projector	combinable with cable basket	Remarks
SVD(2-2.5:1)	545mm	YES	Length with cable basket = 565mm
QVD(1.3-1.8:1)	600mm	YES	
QVD(1.9-2.6:1)	590mm	YES	
QVD(3.0-6.0:1)	620mm	YES	
QVD(0.85:1)	545mm	NO	
QVD(7.0:1)	540mm	YES	Length with cable basket = 560mm

## 2. INSTALLATION GUIDELINES

### Overview

- Safety warnings
- Installation guidelines
- Projector configurations
- Lenses
- Batteries

### 2.1 Safety warnings



**WARNING:** Before installing the projector, read first the safety instructions in the safety manual (R5975258) delivered with the projector.

Insure that the projector is installed in an easy to evacuate room in case of a lamp explosion.

#### Mercury Vapor Warnings

Keep the following warnings in mind when using the projector. The lamp used in the projector contains mercury. In case of a lamp rupture, explosion there will be a mercury vapor emission. In order to minimize the potential risk of inhaling mercury vapors:

- Ensure the projector is installed only in ventilated rooms.
- Replace the lamp module before the end of its operational life.
- Promptly ventilate the room after a lamp rupture, explosion has occurred, evacuate the room (particularly in case of a pregnant woman).
- Seek medical attention if unusual health conditions occur after a lamp rupture, explosion, such as headache, fatigue, shortness of breath, chest-tightening coughing or nausea.

### 2.2 Installation guidelines

#### Ambient temperature check

Careful consideration of things such as image size, ambient light level, projector placement and type of screen to use are critical to the optimum use of the projection system.

Max. ambient temperature : 40 °C or 104 °F

Min. ambient temperature : 0 °C or 32 °F

The projector will not operate if ambient air temperature falls outside this range (0°C- 40°C or 32°F-104°F).

#### Environment

Do not install the projection system in a site near heat sources such as radiators or air ducts, or in a place subject to direct sunlight, excessive dust or humidity. Be aware that room heat rises to the ceiling; check that temperature near the installation site is not excessive



**CAUTION:** Harmful Environmental Contamination Precaution

#### Environment condition check

A projector must always be mounted in a manner which ensures the free flow of clean air into the projectors ventilation inlets as well as free flow at the ventilation outlets. The installation must also allow easy access to the consumable parts ( dustfilters, lamps, ...) For installations in environments where the projector is subject to airborne contaminants such as that produced by smoke machines or similar (these deposit a thin layer of greasy residue upon the projectors internal optics and imaging electronic surfaces, degrading performance), then it is highly advisable and desirable to have this contamination removed prior to it reaching the projectors clean air supply. Devices or structures to extract or shield contaminated air well away from the projector are a prerequisite, if this is not a feasible solution then measures to relocate the projector to a clean air environment should be considered. Make sure that the projector never runs with dirty dustfilters as this will dramatically reduce the lifetime of the consumables. It is advised to clean the dustfilters on a regular basis and to replace them at any lamp change. Barco reserves itself the right to refuse warranty replacement of consumables if they have been used in a projector with dirty airfilters. Only use the manufactures recommended cleaning kit which

## 2. Installation Guidelines

---

has been specifically designed for cleaning optical parts, never use industrial strength cleaners on a projectors optics as these will degrade optical coatings and damage sensitive optoelectronics .

Failure to take suitable precautions to protect the projector from the effects of persistent and prolonged air contaminants will culminate in extensive and irreversible ingrained optical damage. At this stage cleaning of the internal optical units will be non-effective and impracticable. Damage of this nature is under no circumstances covered under the manufactures warranty and may deem the warranty null and void. In such a case the client shall be held solely responsible for all costs incurred during any repair. It is the clients responsibility to ensure at all times that the projector is protected from the harmful effects of hostile airborne particles in the environment of the projector. The manufacture reserves the right to refuse warranty repair if a projector has been subject to wantful neglect, abandon or improper use.

### What about ambient light ?

The ambient light level of any room is made up of direct or indirect sunlight and the light fixtures in the room. The amount of ambient light will determine how bright the image will appear. So, avoid direct light on the screen. Windows that face the screen should be covered by opaque drapery while the set is being viewed. It is desirable to install the projection system in a room whose walls and floor are of non-reflecting material. The use of recessed ceiling lights and a method of dimming those lights to an acceptable level is also important. Too much ambient light will 'wash out' of the projected image. This appears as less contrast between the darkest and lightest parts of the image. With bigger screens, the 'wash out' becomes more important. As a general rule, darken the room to the point where there is just sufficient light to read or write comfortably. Spot lighting is desirable for illuminating small areas so that interference with the screen is minimal.

### Which screen type ?

There are two major categories of screens used for projection equipment. Those used for front projected images and those for rear projection applications. Screens are rated by how much light they reflect (or transmit in the case of rear projection systems) given a determined amount of light projected toward them. The 'GAIN' of a screen is the term used. Front and rear screens are both rated in terms of gain. The gain of screens range from a white matte screen with a gain of 1 (x1) to a brushed aluminized screen with a gain of 10 (x10) or more. The choice between higher and lower gain screens is largely a matter of personal preference and another consideration called the Viewing angle. In considering the type of screen to choose, determine where the viewers will be located and go for the highest gain screen possible. A high gain screen will provide a brighter picture but reduce the viewing angle. For more information about screens, contact your local screen supplier.

### Image size

The projector is designed for projecting an image size with a screenwidth from 1.00m (3.3ft) to 6.00m (19.7ft) with an aspect ratio of 4 to 3.

### Image retention

Image retention can affect LCD projectors, in extreme cases, permanent "burn" can occur if still/repetitive images are left on the screen for long periods of time. Such damage to the panels is NOT covered by warranty.

Please ensure that the following precautions are taken to avoid this phenomenon :

1. Use a screensaver (that moves)
2. Periodically change/alter any background images on the desktop
3. Turn off the projector when not in use.

## 2.3 Projector configurations

---

### The different configurations

1. Rear/Ceiling
2. Rear/Table
3. Front/Ceiling
4. Front/Table

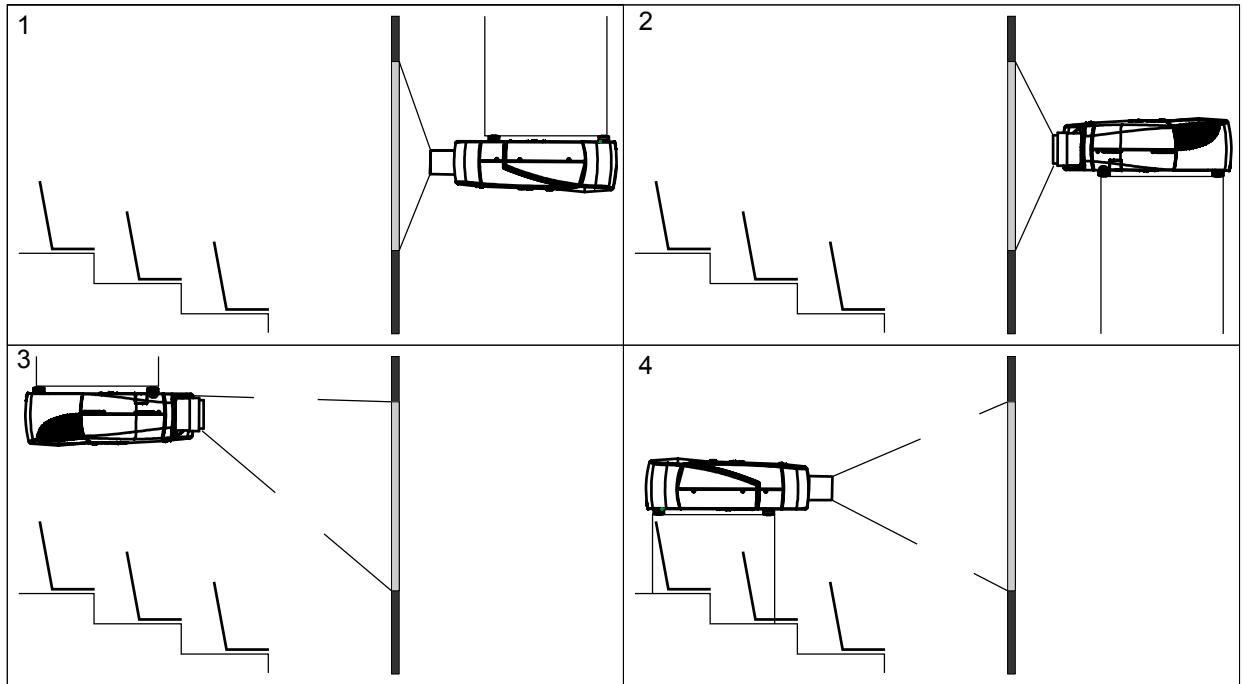

Image 2-1

Positioning the projector

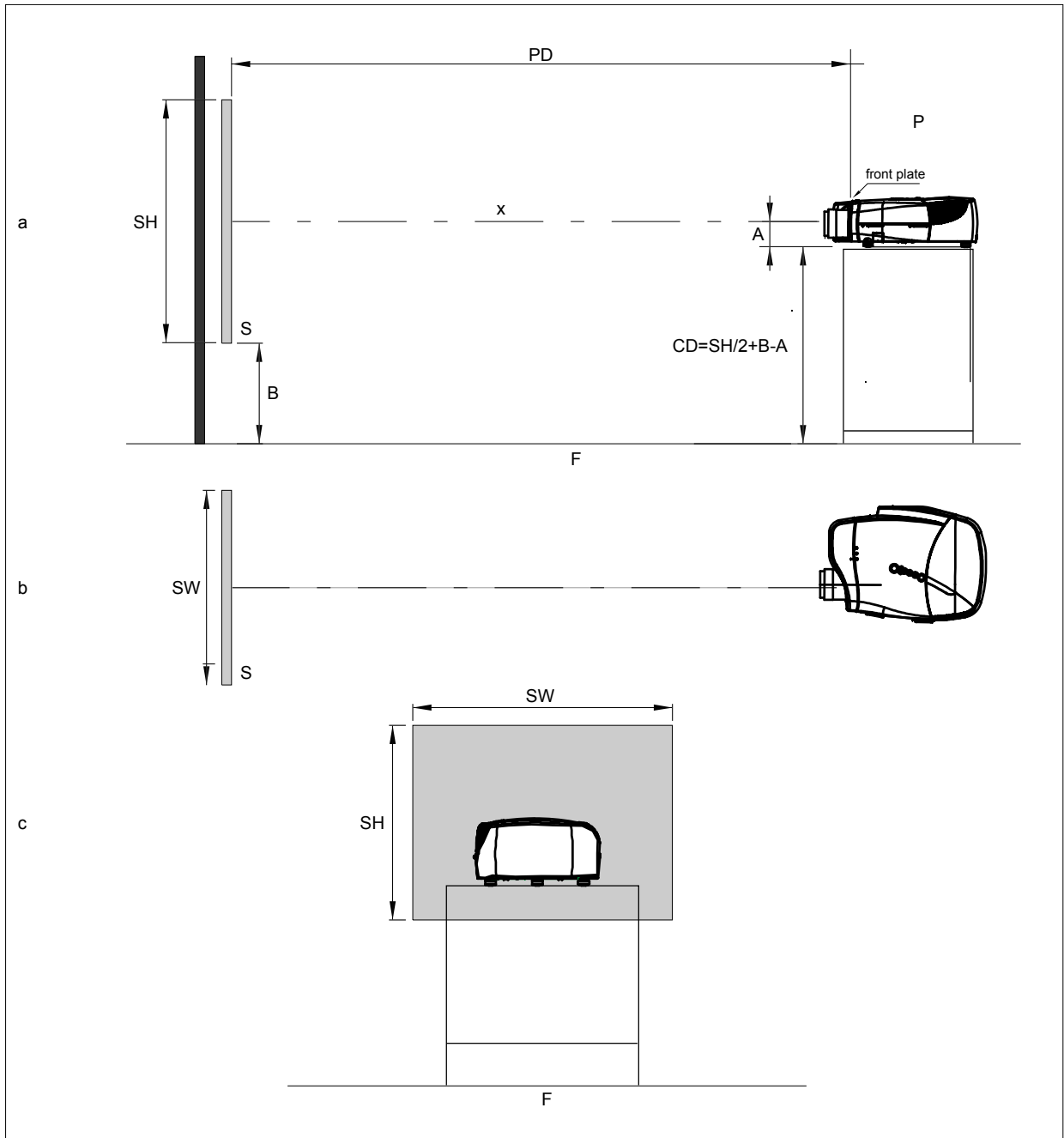

Image 2-2  
ON-Axis installation

- a side view
- b top view
- c back view
- x optical axis projection lens
- p projector
- s screen
- F floor



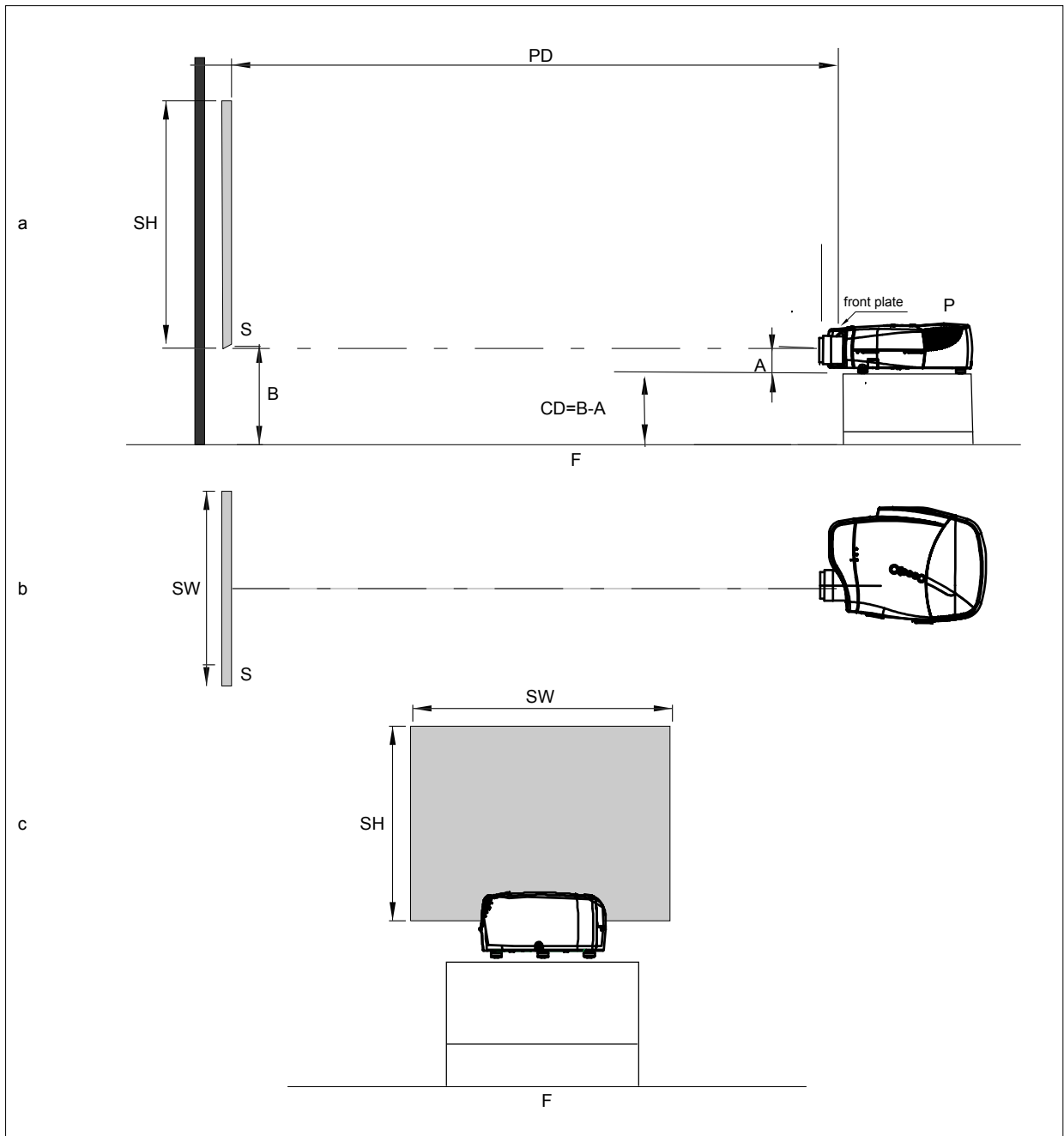

Image 2-3  
100% OFF Axis installation

- a side view
- b top view
- c back view
- x optical axis projection lens
- p projector
- s screen
- F floor



**CAUTION: Only for iQ Pro:**

The harddisk in the iQ Pro server is formatted in horizontal position but can operate in all axes (6 directions). The projector should not be tilted more then +/- 5 degrees from these positions, otherwise error rates will increase.



**CAUTION: Never place the projector on either side !**

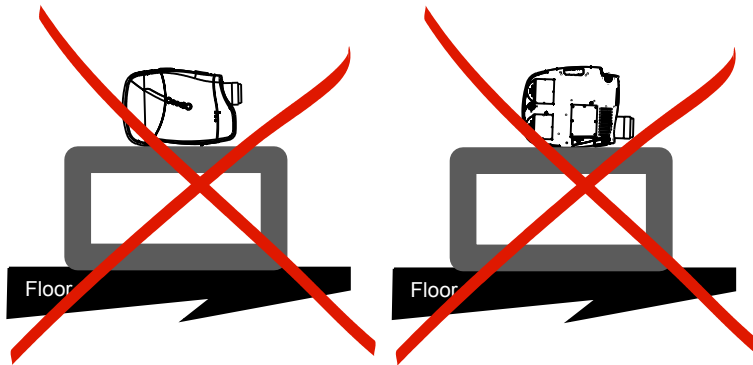

Image 2-4

## 2.4 Lenses

### Overview

- Lenses
- Lens formulas
- Lens installation
- Removing the lens
- Cleaning the lens

### 2.4.1 Lenses

#### Available lenses

The following lenses are available, or will become available (contact a BARCO service center) as an option :

Lenses	Standard version
QVD(0.85:1)	R9841220
QVD(1.3-1.8:1)	R9840950
QVD(1.9-2.6:1)	R9840960
QVD(3.0-6.0:1)	R9840970
QVD(7:1)	R9841230
SVD(2.0-2.5:1)	R9841240



**The QVD (0.85:1) is to be used in ON Axis configuration only.**

**Shifting the lens vertically will not guarantee optimal image quality.**

## 2.4.2 Lens formulas

### Formulas

	Metric Formulas (meter)	Inch formulas (inch)
QVD(0.85:1)	$PD = -0.034 + 0.801 \times SW + 0.0086 / SW$	$PD = -1.34 + 0.801 \times SW + 13.35 / SW$
QVD(1.3-1.8:1)	$PD_{min} = 0.019 + 1.216 \times SW + 0.028 / SW$ $PD_{max} = -0.001 + 1.584 \times SW + 0.074 / SW$	$PD_{min} = 0.75 + 1.216 \times SW + 43.4 / SW$ $PD_{max} = -0.04 + 1.584 \times SW + 115 / SW$
QVD(1.9-2.6:1)	$PD_{min} = 0.052 + 1.731 \times SW - 0.014 / SW$ $PD_{max} = 0.11 + 2.33 \times SW - 0.059 / SW$	$PD_{min} = 2.05 + 1.731 \times SW - 21.7 / SW$ $PD_{max} = 4.33 + 2.33 \times SW - 91.8 / SW$
QVD(3.0-6.0:1)	$PD_{min} = 0.048 + 2.795 \times SW - 0.042 / SW$ $PD_{max} = 0.06 + 5.6 \times SW - 0.041 / SW$	$PD_{min} = 1.89 + 2.795 \times SW - 65 / SW$ $PD_{max} = 2.36 + 5.6 \times SW - 63.4 / SW$
QVD(7:1)	$PD = 0.013 + 6.35 \times SW + 0.005 / SW$	$PD = 0.51 + 6.35 \times SW + 8.35 / SW$
SVD(2.0-2.5:1)	$PD_{min} = -0.139 + 1.733 \times SW + 0.1 / SW$ $PD_{max} = 0.005 + 2.224 \times SW - 0.00862 / SW$	$PD_{min} = -5.47 + 1.733 \times SW + 153 / SW$ $PD_{max} = 0.2 + 2.224 \times SW - 13.3 / SW$



Lens program to calculate the projector distance is available on the BARCO web site : [http://www.barco.com/projection\\_systems/customer\\_services/lens\\_program.asp](http://www.barco.com/projection_systems/customer_services/lens_program.asp)

## 2.4.3 Lens installation

### How to install ?

1. Take the lens out of its packing material
2. Slide the lens door to the left (image 2-5)
3. Fix the lens by placing it in the housing  
**Note:** *In case of a motorized lens the female jack must be in front of the male jack located in the upper-left part of the housing in the projector (image 2-6)*
4. Push carefully to lock the lens in the housing
5. Slide back the lens door to the right



Image 2-5



Image 2-6



**CAUTION:** Never transport the projector (or the whole unit) with the lens mounted on it ! Always remove the lens and transport it separately.

---

#### 2.4.4 Removing the lens

##### How to remove the lens ?

1. Slide the lens door to the left.
2. Unlock the lens by pulling the handle located on the right side of the projector (image 2-7)
3. Remove the lens out of its housing



Image 2-7



**CAUTION:** Never transport the projector with the lens mounted on it !  
Always remove the lens before transporting the projector.

---

### 2.4.5 Cleaning the lens



To minimize the possibility of damage to optical coatings, or scratches to lens surfaces, we have developed recommendations for cleaning. **FIRST**, we recommend you try to remove any material from the lens by blowing it off with clean, dry deionized air. **DO NOT** use any liquid to clean the lenses.

---

#### Necessary tools

Toraysee™ cloth (delivered together with the lens kit). Order number : R379058.

#### How to clean the lens ?

Proceed as follow :

1. Always wipe lenses with a CLEAN Toraysee™ cloth.
  2. Always wipe lenses in a single direction.  
**Warning:** *Do not wipe back and forwards across the lens surface as this tends to grind dirt into the coating.*
  3. Do not leave cleaning cloth in either an open room or lab coat pocket, as doing so can contaminate the cloth.
  4. If smears occur when cleaning lenses, replace the cloth. Smears are the first indication of a dirty cloth.
- 



**CAUTION:** Do not use fabric softener when washing the cleaning cloth or softener sheets when drying the cloth.

Do not use liquid cleaners on the cloth as doing so will contaminate the cloth.

---



Other lenses can also be cleaned safely with this Toraysee™ cloth.

---

## 2.5 Batteries

---

### Overview

- Battery installation

### 2.5.1 Battery installation

#### How to install the battery

Two batteries are packed together with the RCU. Before using your RCU, install first these batteries.

1. Remove the battery cover on the backside by pushing the handle a little towards the bottom of the RCU.
2. Lift up the top side of the cover at the same time.
3. Insert the batteries as indicated in the RCU.
4. Put the battery cover on its place.



## 3. CONNECTIONS

### Overview

- Power connection
- Input source connection
- 5-Cable input
- Composite Video Input
- S-Video input
- Digital Visual Interface (DVI) input
- Computer input
- Serial Digital Interface (Optional)
- Audio input/Output (Optional)
- Communications Connections
- Extended configuration

### 3.1 Power connection

#### AC power (mains) cord connection

Use the supplied power cord to connect your projector to the wall outlet.

Plug the female power connector into the male connector at the front of the projector.



The power input is auto-ranging from 90 to 240 VAC.

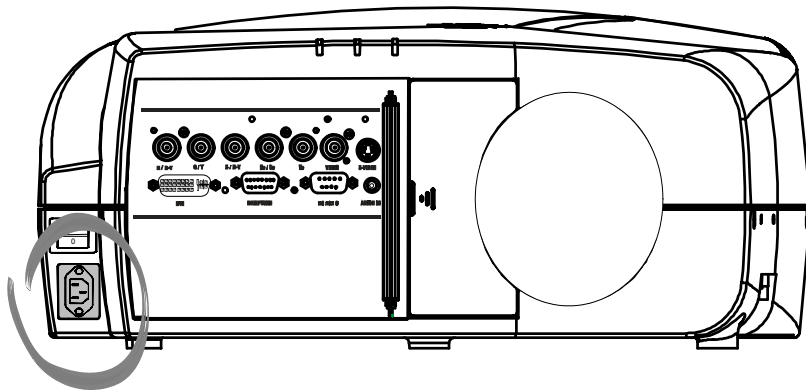

Image 3-1

#### Fuses

For continued protection against fire hazard :

- refer replacement to qualified service personnel
- ask to replace with the same type of fuse.

### 3.2 Input source connection

#### Overview

- Input section
- Input facilities

### 3.2.1 Input section

#### Input Layers

The input section is divided in layers, each of them regrouping several inputs, this architecture allows the input section to be upgraded at any time with an optional analog or digital layer.

1. Layer 1: analog layer containing analog data and video inputs
2. Layer 2: a hybrid layer containing 2 digital and 1 analog input
3. Layer 3: is an optional layer, it may be an Audio & Video analog layer or a SDI digital layer.



The optional layer is not available for the Pro version

### 3.2.2 Input facilities



The optional features are also explained in this manual, they are always mentioned with “(optional)”



The SDI and Audio option is not possible on the Pro version !

#### overview

- 5-cable input
- composite video
- component video (PR/Y/PB)
- S-Video
- Digital Visual Input (DVI)
- Computer
- Serial Digital Input (Optional)
- Audio input/output (Optional)

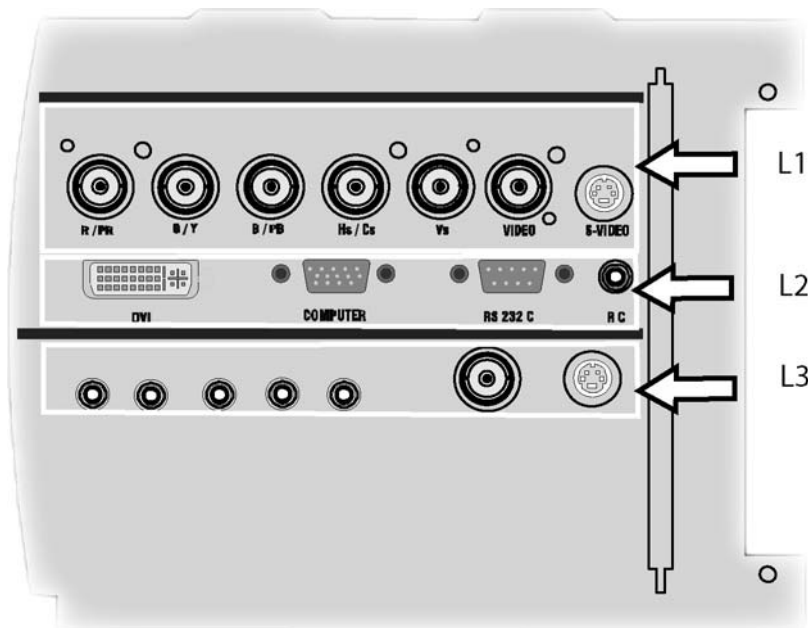

Image 3-2  
Source input section with optional Audio&Video layer, the LED's indicate the selection of a signal.

- L1 Layer 1 = RGBHV (data) + Composite Video + S-Video
- L2 Layer 2 = DVI + Computer + RS232 IN + RC (Wired Remote Control)
- L3 Layer 3 = Optional Audio&Video Layer = 4x Audio IN + 1xAudio Out + Composite Video + S-Video





Layer 3 can be an optional audio&video layer or an optional SDI (SDI Input/Output)

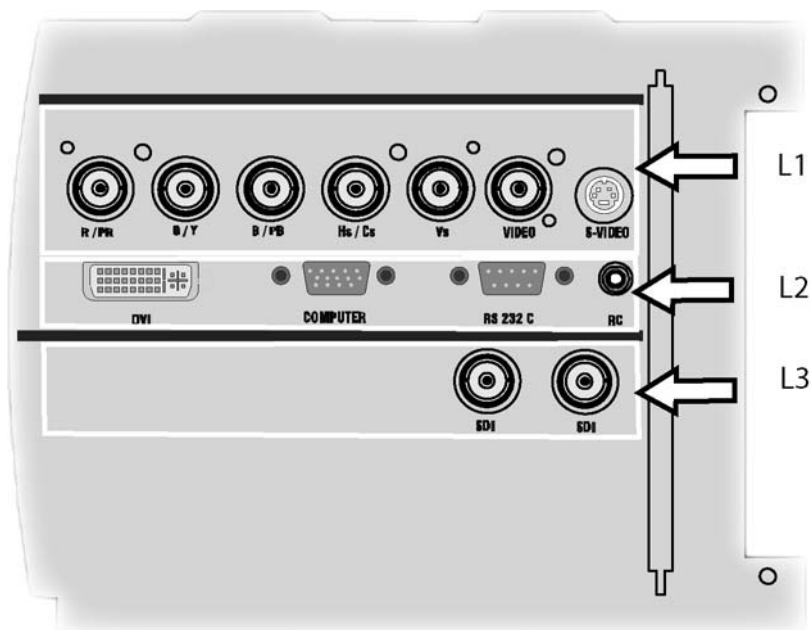

Image 3-3  
source input section with optional SDI layer



A cable cover is supplied with the projector and can be fitted on the front of the projector

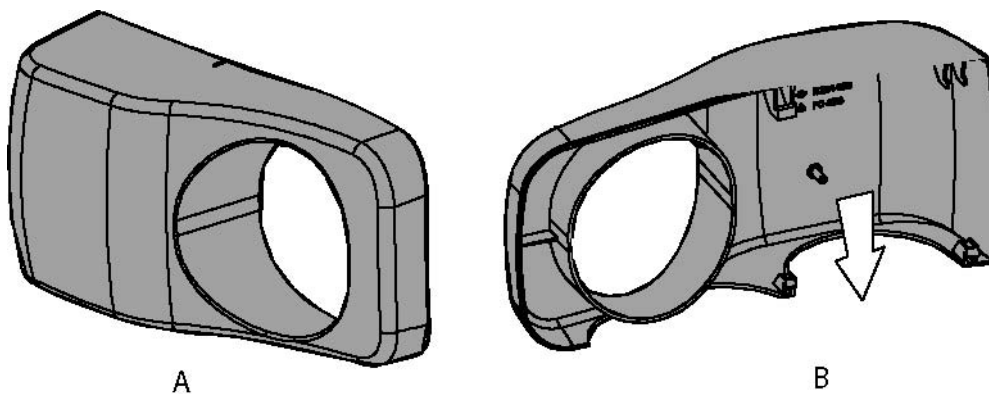

Image 3-4  
Cable basket : the white arrow shows the cables leaving the projector

- A Front view
- B Back view

### 3.3 5-Cable input

#### Input specifications

The 5-cable input section is made of 5 BNC input terminals.

0.7 Vpp ± 3dB

75 Ω terminated

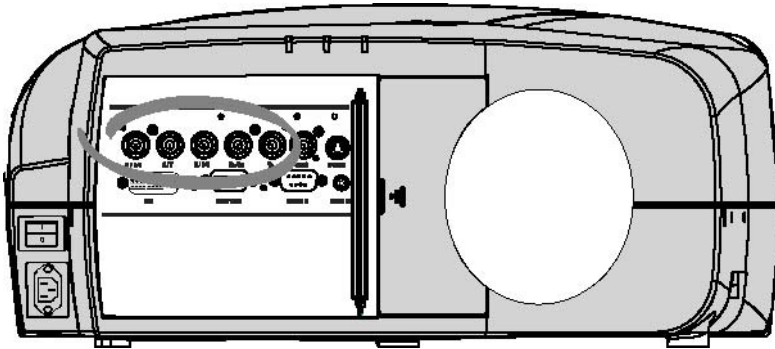

Image 3-5



**Component Video**

In Component Video the term component describes a number (3) of elements that are needed to make up the video picture, these components are R-Y/Y/B-Y. A composite video signal on the other hand contains all the information needed for the color picture in a single channel of information

**Which signals can be connected ?**

Signals/Input BNC	R	G	B	H	V
RGBHV	R	G	B	H	V
RG <sub>s</sub> B <sup>1</sup>	R	G <sub>s</sub>	B	-	-
RGBS <sup>1</sup>	R	G	B	S	-
Component	PR	Y	PB	-	-



Beside the standard RGB, component and sync signals, the extended mode of the 5 Cable input makes processing of additional signals possible.

**How to select a source on the 5 cable input ?**

1. Press 1 on the RCU  
*Note:* Another way for selecting this input is via the Menu



**Component Video signals (PR/Y/PB)**

Some interfaces use progressive output signals with a double line frequency of 32 kHz. The video decoder used for the video signals is not appropriate for these signals since it can only handle 16 kHz signals. This signal has therefore to be internally redirected, this is done in the *Source selection* menu by selecting *Data on BNC's* instead of *Component video* and by selecting *Pr/Y/Pb* in the advanced settings of the *Image file* menu.

**3.4 Composite Video Input**

**Composite video connection**

A Composite video signal is often available on a yellow cinch connector of a Camera, VCR or DVD player, in this case you will need an adapter cable cinch/BNC to connect to Video input of the RGB board.

**Input specifications**

- The Composite video input section is made of 1BNC input terminal.
- 1.0 Vpp ± 3dB
- 75 Ω terminated
- No loop through

1. data or video

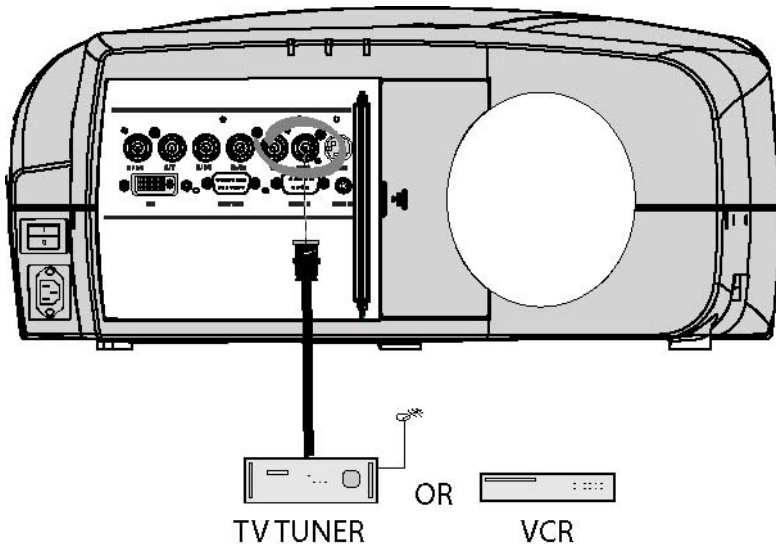

Image 3-6

### How to select a Composite Video Input ?

1. Press **3** on the RCU

**Note:** Another way for selecting this input is via the Menu.



The projector allows the input of more composite video signals (up to 7 composite video signals).  
"5 cable extended configuration", page 27



This note is not valid for the Pro version :

The Audio&Video optional layer(3) allows the use of an additional Video BNC input (referred to as Video2).

The selection of this optional input happens the same way as the standard input (key 3)

## 3.5 S-Video input

### S-Video connection

An S-Video signal is available on the Mini-Din connector of a camera, VCR or DVD player.

### Input specification

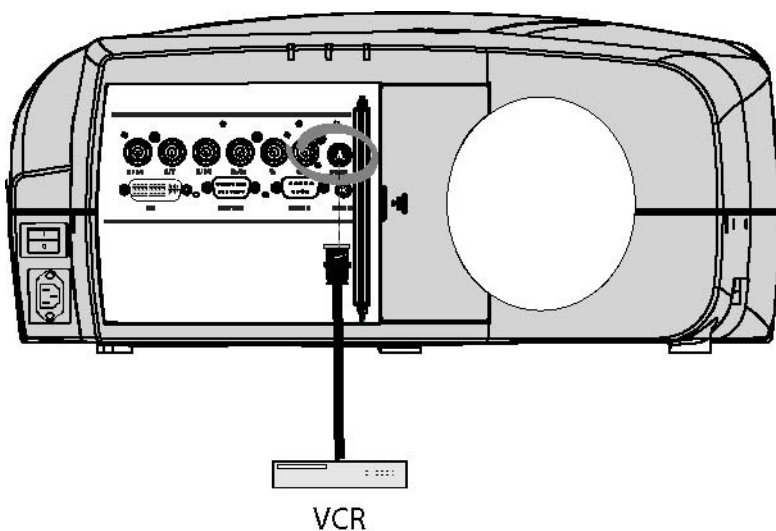

Image 3-7

### 3. Connections

#### Which signal can be connected ?

Standard S-Video (S-VHS) with separate Y(luma) and C (chroma) signals.

#### How to select the S-Video input ?

1. Press **4** on the RCU

**Note:** Another way for selecting this input is via the Menu.



The projector allows the input of more S-Video signals (up to 3 composite video signals).  
"S-Video extended configuration", page 28



This note is not valid for the Pro version:

The Audio&Video optional layer(3) allows the use of an additional S-Video input (referred to as S-Video4).

The selection of this optional input happens the same way as the standard input (key 4)

## 3.6 Digital Visual Interface (DVI) input



#### DVI

Digital Visual Interface is a display interface developed in response to the proliferation of digital flat panel displays.

The digital video connectivity standard that was developed by DDWG (Digital Display Work Group). This connection standard offers two different connectors: one with 24 pins that handles digital video signals only, and one with 29 pins that handles both digital and analog video. This standard uses TMDS (Transition Minimized Differential Signal) from Silicon Image and DDC (Display Data Channel) from VESA (Video Electronics Standards Association).

DVI can be single or dual link.

#### Input specifications

Single link DVI

Differential input voltage: 200 mV - 800mV

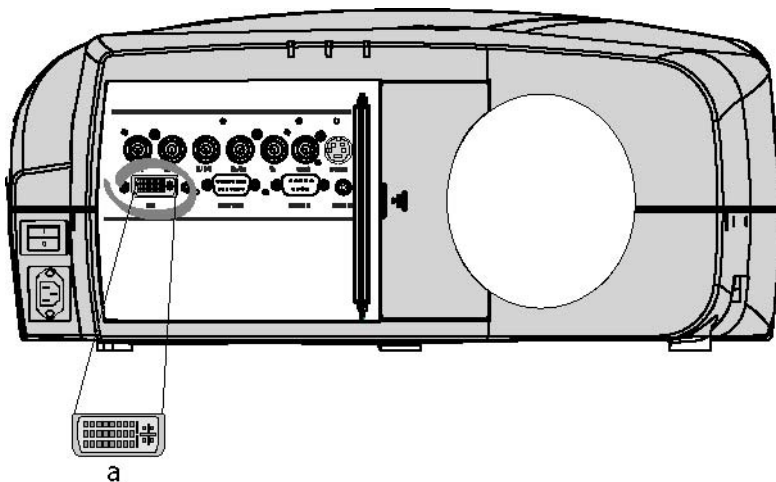

Image 3-8

a DVI-I type connector, analog link (4 pins at the right side of the connector) not supported

#### How to select the DVI Input ?

1. Press **5** on the RCU

**Note:** Another way for selecting this input is via the Menu.

### 3.7 Computer input

#### Input specification

TTL sync input :  $U_{\min} = 2.0 \text{ V}$

RGB input =  $0.7 \text{ V}_{\text{pp}} \pm 3\text{dB}$

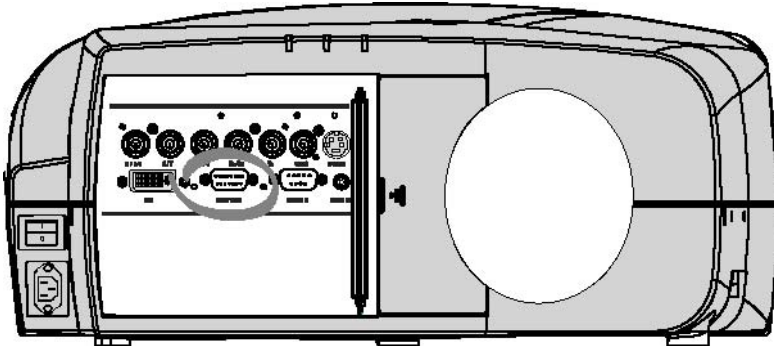

Image 3-9

#### What can be connected ?

- RGBHV
- RG<sub>S</sub>B



Composite sync only possible on Green

#### How to select a computer input ?

1. Press 2 on the RCU

**Note:** Another way for selecting this input is via the Menu.

### 3.8 Serial Digital Interface (Optional)



#### SDI

Serial Digital Interface

#### Input specifications

SDI input : BNC

SDI output : BNC (=loop through)

typical :  $0.8 \text{ V}_{\text{pp}}$

75Ω terminated

output impedance: 75Ω

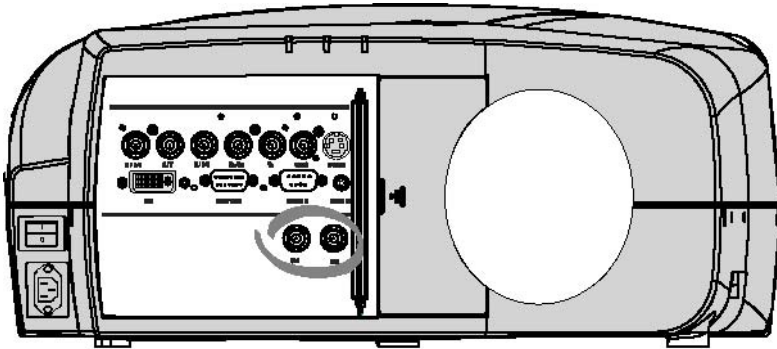

Image 3-10

### How to select the SDI input

1. Press 7 on the RCU

**Note:** Another way for selecting this input is via **Source** on the local keypad or via the Menu.



The SDI is located on Layer3 which is an optional Layer.

---

## 3.9 Audio input/Output (Optional)

---

### Input specification

Typical = 200 mV

Max = 4V<sub>pp</sub>

Mono/Stereo

### Output specification

V<sub>in</sub> +20dB / -∞ dB

Max = 4 V<sub>pp</sub>

Mono/Stereo (selectable in menu)

### How to select the audio input ?

1. Use the Audio menu (General menu) to link the desired audio input to the desired signal. (image 3-11)

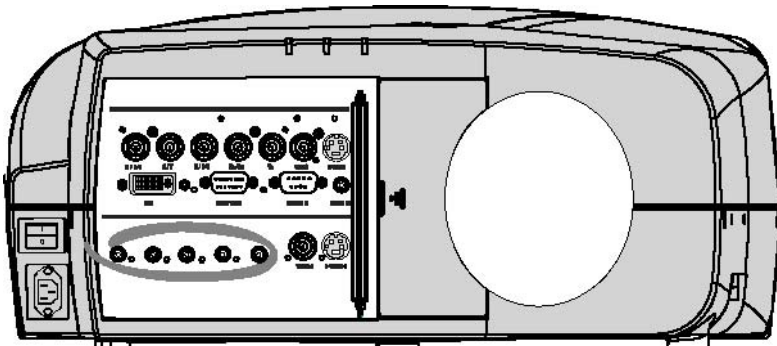

Image 3-11

## 3.10 Communications Connections

### Overview

- RS232 IN connection

### 3.10.1 RS232 IN connection

#### What can be connected to the RS232 IN connection ?

The RS 232 IN connections allows the projector to communicate with a Computer e.g. IBM PC or Apple Macintosh.

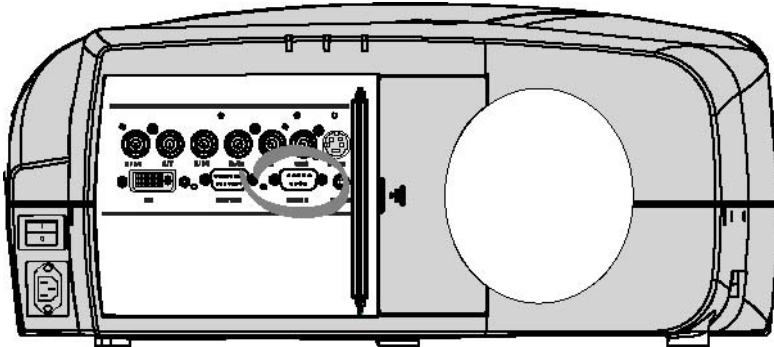

Image 3-12

#### Applications of the RS232 connection

Remote control:

- easy adjustment of projector via IBM PC (or compatible) or MAC connection.
- address range from 1 to 255
- allow storage of multiple projector configurations and set ups.
- wide range of control possibilities

Data communication: sending data to the projector or copying the data from the projector to the computer



To set up the baudrate of the projector, see the Installation menu

## 3.11 Extended configuration

### Overview

- Introduction
- 5 cable extended configuration
- S-Video extended configuration
- Summarizing

### 3.11.1 Introduction

#### What can be done ?

The PiP mode allows to display up to 4 windows of images coming from different sources. The extended capabilities on the input board allow therefore to combine several data & video sources, beside that, they allow switching between a wide range of input signals.

### 3.11.2 5 cable extended configuration

#### What can be done ?

Beside the standard RGB, composite & sync signals, the extended capabilities of the 5 cable inputs make treatment of additional signals possible:

### 3. Connections

- a composite video signal may be connected to 4 of the 5 BNC's (beside the standard video BNC input)
- a S-Video signal can be connected

		Inputs					
		R	G	B	H	V	VIDEO
Signals	RGBHV	R	G	B	H	V	-
	RG <sub>S</sub> B	R	G <sub>S</sub>	B	-	-	-
	RGBS	R	G	B	S	-	-
	Component	PR	Y	PB	-	-	-
	S-Video	-	-	-	-	C	Y
	S-Video	C	-	Y	-	-	-
	Composite	VIDEO	-	-	-	-	-
	Composite	-	VIDEO	-	-	-	-
	Composite	-	-	VIDEO	-	-	-
	Composite	-	-	-	-	VIDEO	-
	Composite	-	-	-	-	-	VIDEO

Table 3-2  
Extended configuration of the 5 cable input: the first column gives the possible signals, and the first row the 5 cable input connectors (+ the standard Video BNC).

#### How to set up the 5 cable extended configuration ?

1. Connect the video or S-video source to the desired BNC connector  
**Note:** In some cases an adapter cable is required (image 3-13, image 3-14, image 3-15)

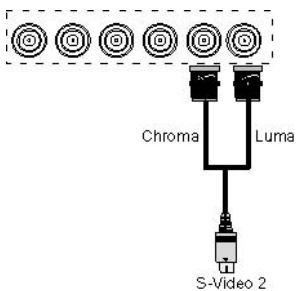

Image 3-13  
Connecting an S-Video signal on the Vs & Video BNC

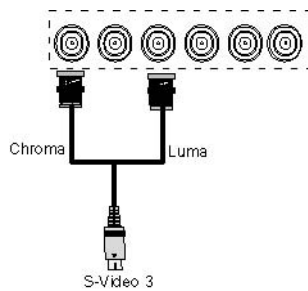

Image 3-14  
Connecting an S-Video signal on the R & B BNC

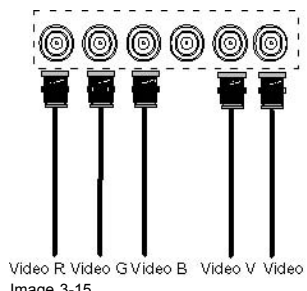

Image 3-15  
Connecting composite Video signals on the 5 cable input



**Multiple video signals can not be visualized simultaneously since there is only one decoder. However, the use of the optional Audio & video layer(3) allows to visualize up to 2 different video signals (in PiP mode ).**

#### 3.11.3 S-Video extended configuration

##### What can be done ?

Beside the standard luminance (Y) and chrominance (C) signals, the advanced capabilities of the S-Video input make treatment of additional signals possible:

- 2 composite video signal may be connected.

	Inputs	
	Y	C



Signals	S-Video	Y	C
	Composite Video	Video	-
	Composite Video	-	Video

Table 3-3

Extended configuration of the S-Video input: the first column gives the possible signals, and the first row the S-Video inputs pins.

### How to set up the S-Video extended configuration ?

1. Connect the video sources to the desired connector (image 3-16)

**Note:** An adapter cable is required

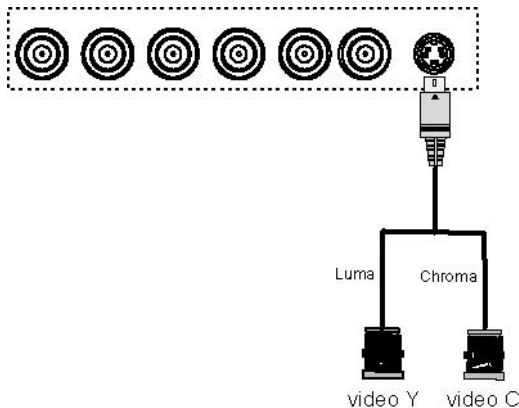

Image 3-16

Connecting 2 composite Video signals on the S-Video connector



**Multiple video signals can not be visualized simultaneously since there is only one decoder. However, the use of the optional Audio & video layer(3) allows to visualize up to 2 different video signals (in PiP mode ).**

## 3.11.4 Summarizing

### Summarizing the extended connections

**A composite video signal can be entered via 7 different inputs, which gives us 7 different video signals (not including optional video input):**

1. Video R : via 1st BNC
2. Video G : via 2nd BNC
3. Video B : via 3rd BNC
4. Video VS : via 5th BNC
5. Video : via the standard composite video BNC input
6. Video Y : via S-Video input
7. Video C : via S-Video input

Key **3** on the RCU allows to browse through the active video inputs, each hit moves to the next active video input. The first hit on key 3 selects the last selected video input.

**In the same way 3 S-Video signals can be visualized through 3 different inputs**

1. S-Video 1: via the standard S-Video input
2. S-Video 2 : via the 5 the BNC and the standard Composite Video input
3. S-Video 3 : via the 1st and the 3rd BNC

Key **4** on the RCU allows to browse through the active S-Video inputs, each hit moves to the next active video input. The first hit on key 4 selects the last selected video input.



## 4. GETTING STARTED

### Overview

- RCU & Local keypad
- Terminology overview
- Switching on
- Lamp runtime
- Lamp error
- Quick set up adjustments
- Projector address
- Controlling the projector
- Digital Zoom
- Menu structure
- Using the menu
- Using the Dialogboxes

### 4.1 RCU & Local keypad

---

#### How controlling the projector ?

The projector can be controlled by the local keypad or by the remote control unit.

#### Location of the local keypad ?

The local keypad is located on the topside of the projector.

For key overview: "Terminology overview", page 33

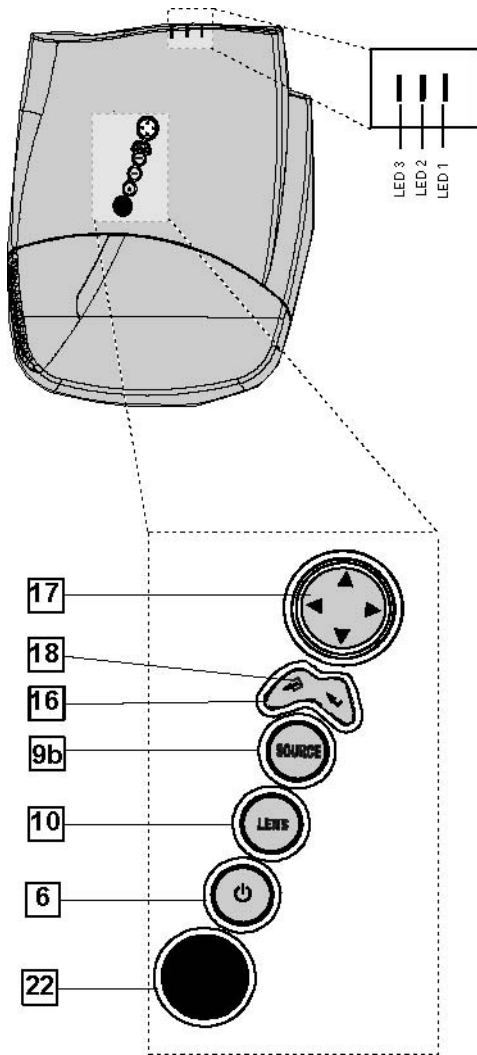

Image 4-1  
Local keypad layout

**Remote control functions.**

This remote control includes a battery powered infrared (IR) transmitter that allows the user to control the projector remotely. This remote control is used for source selection, control, adaptation and set up. It includes automatic storing of picture controls (Brightness, Sharpness...) and settings.

Other functions of the remote control are :

- switching between stand by and operational mode.
- switching to "pause" (blanked picture, full power for immediate restarting)
- direct access to all connected sources.

**Diagnose LED's**

	Green	Red
<b>LED1</b>	cool down sequence: flickers 60 seconds (120 seconds in case of iQ 400 series) after switching to standby	rescue program (software error)
<b>LED2</b>	only for the versions containing a server: shows when projector is in standby and server is active.	hardware error
<b>LED3</b>	IR acknowledgement	continue : standby flickers : Security = ON

## 4.2 Terminology overview

### Overview

The following table gives an overview of the keys.

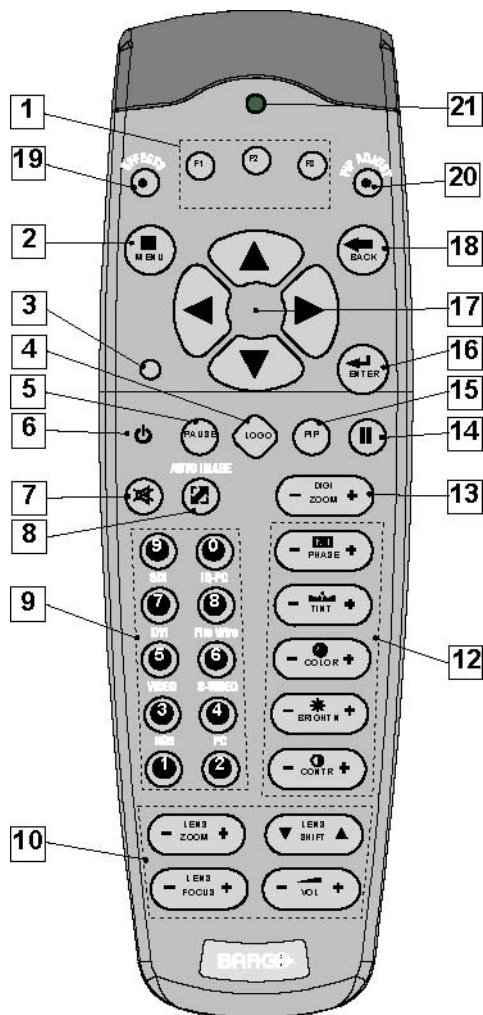

Image 4-2

1	Function keys	user programmable keys with functions for direct access.
2	MENU	Menu key, to enter or exit the Toolbar menu.
3	Address key	(recessed key), to enter the address of the projector (between 0 and 9). Press the recessed address key with a pencil, followed by pressing one digit button between 0 and 9.
4	LOGO key	allows to recall the stored Logo (not in PiP mode)
5	PAUSE	to stop projection for a short time, press 'PAUSE'. The image disappears but full power is retained for immediate restarting.
6	STBY	standby button, to start projector when the power switch is switched on and to switch off the projector without switching off the power switch. <b>Attention : Switching to Standby. When the projector is running and you want to go to standby, press the standby key for 2 seconds.</b>
7	MUTE	to interrupt the sound reproduction (audio = optional).
8	<b>AUTOIMAGE</b>	Auto image, to center the image on the active LCD surface.
9	Digit buttons	direct input selection.
9b	SOURCE button	this button allows to switch through the active (scanned) inputs

## 4. Getting started

10	Lens control	use these buttons to obtain the desired ZOOM, SHIFT, FOCUS.
11	VOL	use this button to obtain the desired sound level (audio = optional)
12	Picture controls	use these buttons to obtain the desired picture analog level.
13	<b>DIGI ZOOM</b>	allows a digital Zoom of a part of the image
14	FREEZ	press to freeze the projected image.
15	<b>PIP</b>	allows to activate the PICTURE IN PICTURE mode
16	ENTER	to confirm an adjustment or selection in the MENU. On the local keypad the ENTER button additionally accesses the PIP window resize function
17	Cursor keys	Cursor Keys on RCU or on the local keypad : to make menu selections or to access the toolbar.
18	BACK	to leave the selected menu or item (go upwards to previous menu).
19	EFFECTS	not yet implemented
20	<b>PIP ADJUST</b>	allows to select a PiP window and change its configuration on screen
21	RC operating indication	lights up when a button on the remote control is pressed. (This is a visual indicator to check the operation of the remote control)
22	IR receiver	IR receiver

Table 4-2



ordernumber RCU: R763794K

## 4.3 Switching on

### How to switch on.

1. Press the power switch to switch on the projector.
  - When '0' is pushed in, the projector is switched off.
  - When '1' is pushed in, the projector is switched on

The projector starts in standby mode, LED3 is red.

### Starting image projection.

1. Press **Standby** key once on the local keypad or on the remote control. (image 4-3)

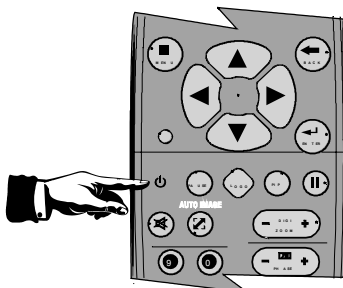

Image 4-3



It may take about 60 seconds before image projection, i.e. no projection until the completion of several operations (software initialization,...).



If the Security mode is enabled, a textbox will be displayed for PIN code entry, see **Security** setting in the **Installation** menu

## 4.4 Lamp runtime



x

To generalize for the different projector types, x refers here to the maximum run time of the lamp.

### Lamp runtime indication while running

Independently of the lamp mode, when the total runtime of an active lamp (lamp1 for example) is (x-30) hours or more, a warning message will be displayed.

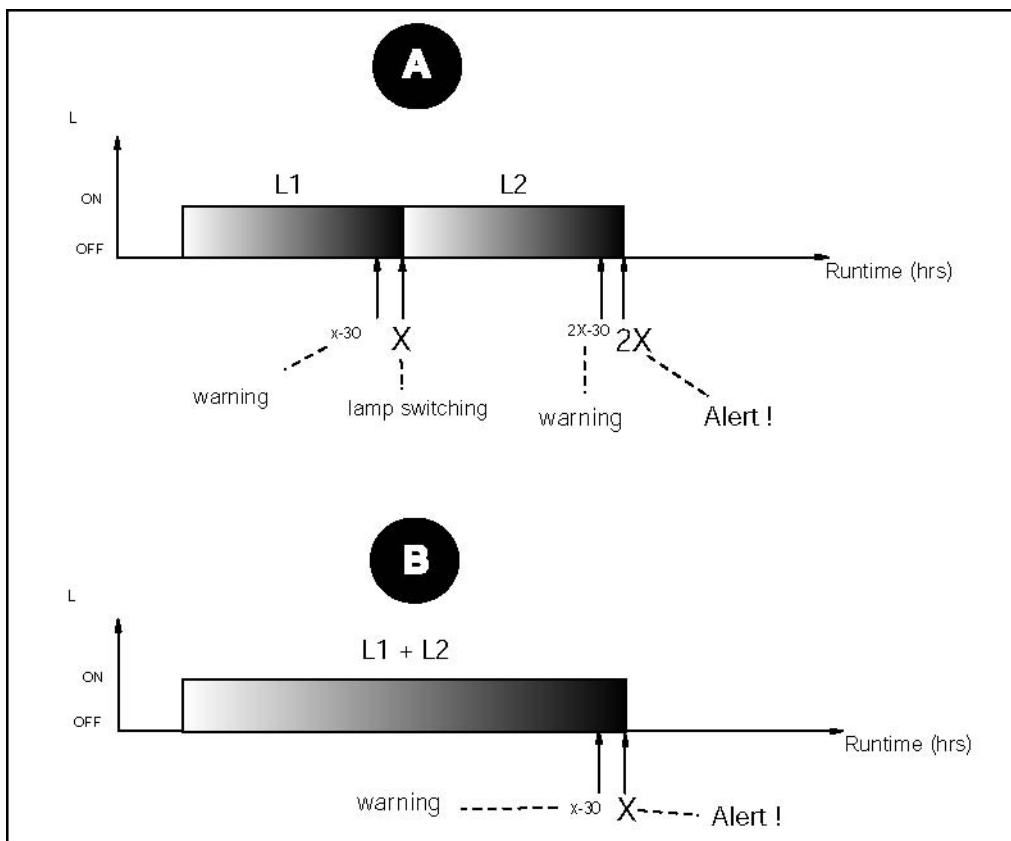

Image 4-4  
Lamp runtime management

- A single mode
- B dual mode
- x maximum lamp runtime



Image 4-5  
warning message in case of an iQ300 projector

This warning message will be repeated at the next start up. Press **BACK** or **MENU** to remove the message.

## 4. Getting started

The total lifetime of the lamp for a safe operation is "x" hours max, do not use it longer. Always replace with a same type of lamp. Call a BARCO authorized service technician for lamp replacement.

BarcoIQ	x ( Max lamp runtime, in hours)
210L	6000
350	3000
500	1500

Table 4-3  
Maximum runtime for the different BarcoIQ projectors

When the lamp runtime reaches "x" hours the projector switches automatically to the other lamp, being lamp2.. following messages are displayed during and after switching.

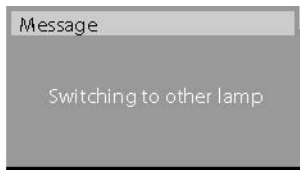

Image 4-6

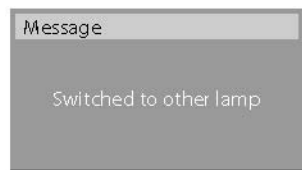

Image 4-7

When lamp2 at its turn reaches x-30 hours, a warning message appears on the screen.



Image 4-8  
warning message in case of a IQ300 series projector

At the end of the lifetime of lamp2 (x hours) the projector generates an alert message.

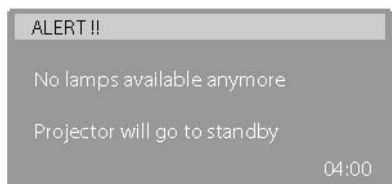

Image 4-9

A countdown time of 4 minutes is triggered before the projector is shut down (standby).

If the lamp runtime has not been reset, the alert message will reappear at the next start up (with again 4 minutes countdown time).

This alert message can be escaped with **MENU** or **BACK**, but the countdown continues.

Contact a qualified Barco technician for lamp replacement.



In Dual mode the lamp end of lifetimes are reached at the same time, however if in dual lamp mode one lamp has been used more than the other (for example if the projector has been working temporarily in single mode), one lamp will reach its end of lifetime sooner than the other lamp, which brings us to the Single mode operation.



**WARNING:** Using a lamp for more than x hours is dangerous as the lamp could explode.

The lamp runtime reset as well as the lamp replacement can only be done by a Barco authorized technician.

## 4.5 Lamp error

### What happens in case of a lamp error ?

When a lamp error occurs in dual mode, a dialogbox is displayed informing the user of the steps to be taken.



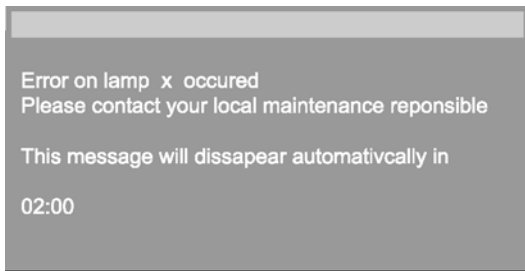

Image 4-10

The message will dissappear after 2 minutes, it can also be escaped.

The projector will switch to single lamp mode and displays an icon (right top corner of the screen) representing a crossed out lamp, that way informing the user of an earlier lamp error.

The icon can always be removed via the *Clear lamp error* function in the *Lamp* menu.



**WARNING:** In case of lamp error contact a Barco authorized technician.

## 4.6 Quick set up adjustments

### Overview

- Quick lens Adjustment
- Using the RCU

### 4.6.1 Quick lens Adjustment

#### What can be done ?

For a quick lens set up and image shift, use the RCU dedicated keys or the lens button on the local keypad



**Zoom/focus are only available for motorized lenses.**

#### Quick zoom/focus adjustment

1. Press **LENS ZOOM** or **LENS FOCUS** on the RCU
2. Use the arrow keys to adjust

#### Quick shift adjustment

1. Press **LENS SHIFT**
2. Use the arrow keys to adjust

### 4.6.2 Using the RCU

#### Pointing to a reflective screen

1. Point the front of the RCU to the reflective screen surface. (image 4-11)

## 4. Getting started

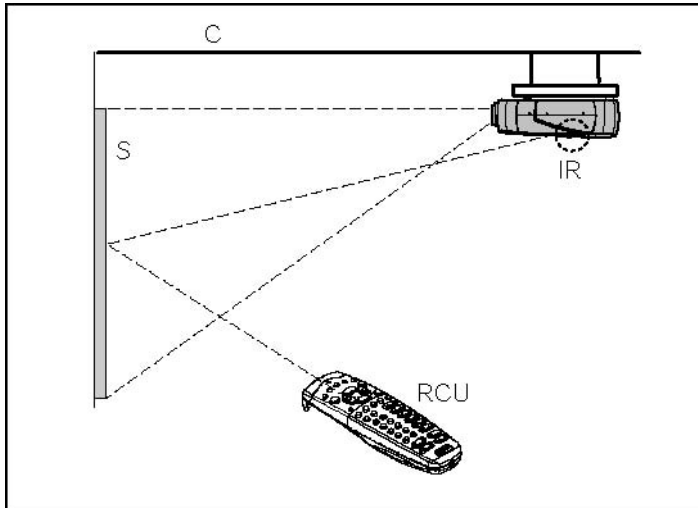

Image 4-11



When using the remote control, make sure you are within the effective operating distance.

The operating distance may be up to 15 m (50ft).



The remote control unit will not function properly if strong light strikes the sensor window or if there are obstacles between the remote control and the IR sensor.

### How to connect ?

1. Plug one end of the remote cable in the connector on the bottom of the RCU.
2. Plug the other end in the connector in the front panel of the projector labelled **RC**. (image 4-12)

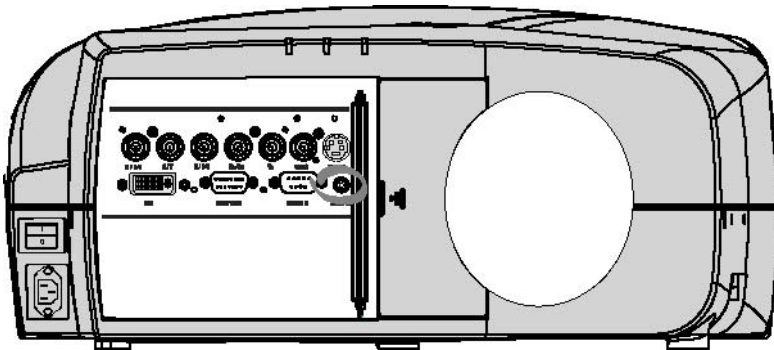

Image 4-12

### Specifications of the RC input

$U_{in} = 9V$

$I_{max} = 80 \text{ mA}$

Internal IR receivers can be disabled:

- mono jack : on plug in of the jack
- stereo jack : on plug in or using an external switch bringing the right channel (B) to ground level.

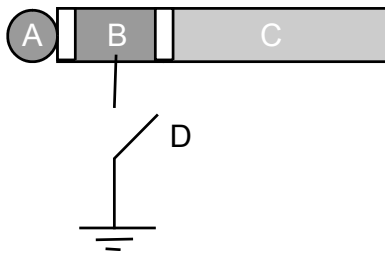

Image 4-13  
Stereo jack pin configuration

- A tip: Left channel
- B ring: right channel
- C sleeve: common (GND)
- D external switch



The Remote connection uses a standard two wire cable terminated on each end with a 3.5 mm male (mono/stereo) phone jack.

This cable is not delivered but is available in most electrical or audio shops.

## 4.7 Projector address

### Overview

- Address setting
- Displaying and Programming addresses into the RCU

### 4.7.1 Address setting



#### Projector address

Address installed in the projector to be individually controlled.



#### Common address

Default address. Projector will always execute the command coming from a RCU programmed with that common address.

### Why a projector address ?

As more than one projector can be installed in a room, the separate projector should be separately addressable with an RCU or computer. Therefore each projector has its own address.

### Set up an individual Projector Address.

The set up of a projector address can be done via the software.

### Projector controlling.

Every projector requires an individual address between 0 and 255 which can be set in the *Installation* menu.

When the address is set, the projector can be controlled by :

- RCU for addresses between 0 and 9.
- computer, e.g. IBM PC (or compatible), Apple MAC, etc. for addresses between 0 and 255.

A projector will respond to a RCU set to the common address '0' regardless of what address is set in the projector itself (common address of projector should also be "0").

The RCU is default programmed with address 0 , 'common address'.



If it is necessary to control a specific projector, then enter the projector address into the RCU (only when that address is between 0 and 9). The projector with the corresponding address will listen to that specific RCU.



Some projectors may operate in domestic environments where other equipments may listen to the common address "0", therefore the common address can also be set to "1".

#### 4.7.2 Displaying and Programming addresses into the RCU

##### Displaying the Projector Address on the Screen.

1. Press the **Address** key (recessed key on the RCU) with a pencil.

The projector's address will be displayed in a 'Text box'



To continue using the RCU with that specific address, it is necessary to enter the same address with the digit buttons (address between 0 and 9) within 5 seconds after pushing the address key. For example : if the Address key displays projector address 003, then press "3" digit button on the RCU to set the RCU's address to match the projector's address. Do not press 0-0-3 . This will address the remote control to '0' and control all projectors in the room. If the address is not entered within 5 seconds, the RCU returns to its default address (zero address) and controls then all projectors in the room.

**Address 0 (or 1) should always allow communication with the projector since it is a common address.**

##### Displaying the Projector Address in Standby.

1. Press the **Address** key (recessed key on the RCU) with a pencil.

All the LED's on the front of the projector go out.

Then LED1 starts blinking green the number of hundreds. After that LED2 starts blinking the number of tens. Finally LED3 starts blinking green the number of units. If this is done, the original status of the leds is restored.

### 4.8 Controlling the projector

#### Input Selection

Key in the corresponding slot number with the digit keys on the RCU. The selected source will be displayed.

#### Picture Controls

When an image control is pressed, a text box with a bar scale, icon and function name of the control, e.g. 'brightness...' appears on the screen (only if *Textbox* in the Installation menu is ON). The length of the bar scale and the value of the numeric indication indicate the current memorized setting for this source. The bar scale changes as the arrows on the RCU are pressed or the + or - buttons on the local keypad.

The picture settings are saved in the image file.

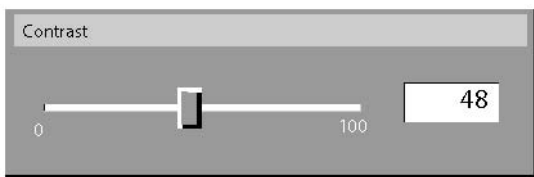

Image 4-14

Brightness	Use the + button for a higher brightness. Use the - button for a lower brightness.
Contrast	Use the + button for a higher contrast. Use the - button for lower contrast.
Color	Use the + button for richer colors. Use the - button for lighter colors.
Tint(Hue)	Tint is only active for Video and S-Video when using the NTSC 4.43 or NTSC 3.58 system. Use the + button Use the - button.

Sharpness	Use the + button for a sharper picture. Use the - button for a softer picture.
Phase	Use the + or - button to adjust the phase.
Gamma	Use the + button for a higher gamma Use the - button for a lower gamma
Freeze	Press <b>Freeze</b> to freeze the displayed image.

### The Pause Key

When the Pause key is pressed, the image projection is stopped, a black screen will be displayed

To restart the image projection:

- Press **PAUSE** key
- Press **BACK** key
- Select a source number

## 4.9 Digital Zoom

### What can be done ?

The Digital Zoom key on the RCU allows to zoom (in or out) one particular part of the image

### How to Zoom ?

1. Press ← or → on the **Digital Zoom** key on the remote to Zoom the center of the image

A wizardbox is displayed in the lower part of the screen, follow the instructions.

Use the **BACK** key to undo the Zoom function.



**Digital Zoom can not be performed on a logo.**

## 4.10 Menu structure

### PC like menustructure

The projector has a build in "PC like" toolbar menu which allows easy access to different parameters for setting up the projector.

The menu is activated by pressing **MENU**, it contains 2 levels depending on the type of user:

- Level 1: standard user
- Level 2: advanced user, level 2 is password protected, the advanced parameters are only visible when the correct password has been entered ( factory password = "0000")



**Menu items which are not applicable are greyed out.**

## 4.11 Using the menu

### Menu Layout

A grey line gives the transition between standard and advanced parameters.

The existence of a submenu is indicated by a white arrow, *Settings* is a submenu.

*Keystone* is an item of the *Image* menu.

## 4. Getting started

---

Three suspension points indicate that the menuitem hides a dialogbox or a textbox.

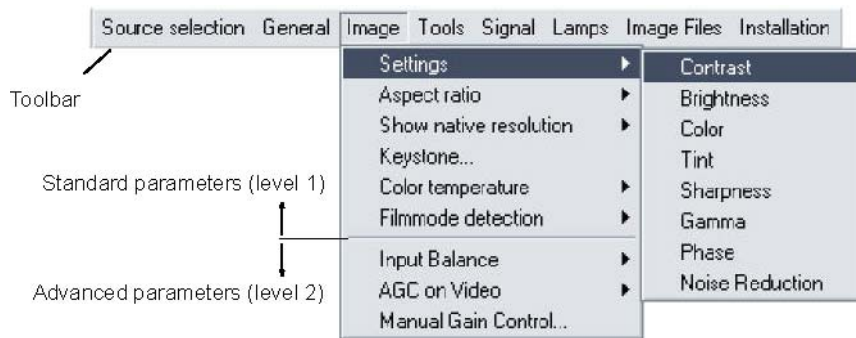

Image 4-15



The menus inserted in this manual are of the advanced type: all the items are visible. The menus seen by a standard user on the screen will hence not correspond with the menus in the manual i.e. the advanced items will not be visible, they will be replaced with "More..."

---



Greyed out menus or items are not available in this software version

---

### How to pull down a menu ?

1. Use ↓ to pull down a menu

### How to pull down a submenu ?

1. Use → to pull down a submenu

### How to exit the submenu ?

1. Press **BACK** to exit a submenu
- 



Press **MENU** to exit the menu

---



When the menu has been exited for more than 1 minute, the advanced user password has to be re-entered.

---

## 4.12 Using the Dialogboxes

---

### How to use the dialogboxes ?

Some parameters are modified by means of a dialogbox, where selections can be made and/or values can be entered. The values can be entered in several ways:

#### Entering numeric values using the numeric keys on the remote control

1. Press **ENTER** to activate the input field (image 4-16)
2. Key in the desired value

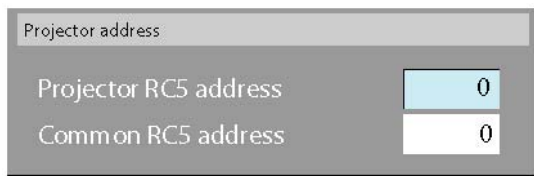

Image 4-16

### Entering numeric values using the arrow keys on the remote control

1. Press **ENTER** to activate the input field.
2. Press ← or → to select the digit to be changed (image 4-17)
3. Press ↓ or ↑ to increase or decrease the value

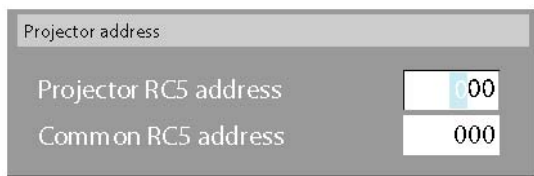

Image 4-17

### Entering numeric values using the arrow keys on the local keypad

1. Press **ENTER** to activate the input field.
2. Press ← or → to select the digit to be changed
3. Press ↓ or ↑ to increase or decrease the value



**To confirm the changes always press ENTER.**

**Use ↓ or ↑ to browse between the different fields.**



**In some cases an alphanumeric value (file name, ...) has to be entered. Use ↑ or ↓ to scroll through the character values once the input field is activated**

**Following characters can be browsed in this particular order:**

**Decimal scroll list: 0123456789**

**Signed decimal scroll list: 0123456789-**

**ASCII scroll list: ABCDEFGHIJKLMNOPQRSTUVWXYZ0123456789+\*/&@#.;:abcdefghijklmnopqrstuvwxyz**





## 5. SOURCE SELECTION

### Overview

- Source selection
- Composite Video
- S-Video
- The Video Selector

### 5.1 Source selection

#### Selecting a source

The Source selection menu allows to select one of the different sources. Another method to select an input source is via the remote control using the numeric keys or by using the local keypad.



**When selecting a source with a different resolution (and/or aspect ratio) than the projector's resolution (and/or aspect ratio), the source can be shown in its native resolution or can be re-scaled to the projector's resolution, the latter case brings of course some loss of quality.**

**For more info on resolution match see the Show native resolution function in the *Image* menu.**

#### How to select a source ?

1. Press **MENU** to activate the Tool bar
2. Press ↓ to Pull down the Source Selection menu (image 5-1, image 5-2)
3. Use ↑ or ↓ to select one of the different sources ( Press → to Pull down if the item has a submenu)
4. Press **ENTER** to confirm your choice

On the screen appears now the selected source.

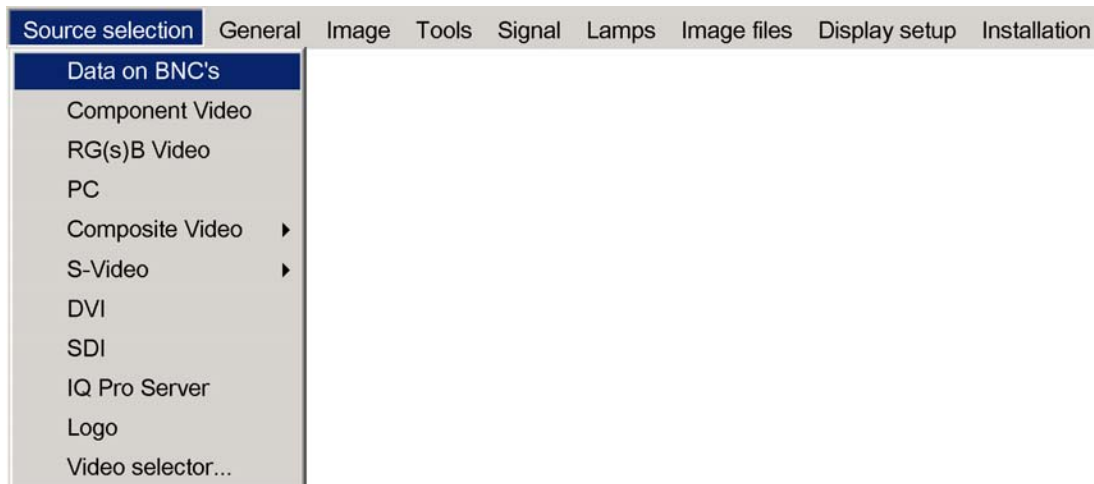

Image 5-1

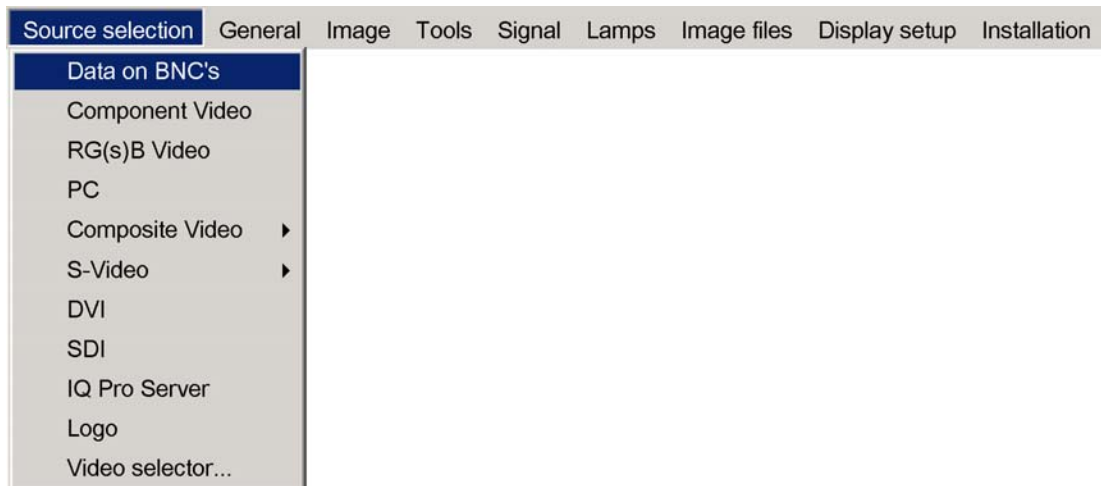

Image 5-2



The Barco logo on the menu indicates the presence of a signal, the digit indicates the shortcut key on the RCU.

The 3 first sources (Data on BNC's, Component Video & RG(s)B) refer to the 5-cable input, the position of the indication "1" will always show which BNC configuration is selected.

---

### When to select "Data on BNC's"

Select Data on BNC's when a data signal is connected to the BNC's

### When to select "Component video" ?

Select Component video when a video signal of the type (R-Y/Y/B-Y) is connected on the BNC's.

### When to select RG<sub>s</sub>B Video ?

Select RG<sub>s</sub>B Video when an RGB video signal (15 KhZ) with Sync on green or sync on H is presented on the BNC's.

This signal is routed to the video circuit and is projected in a Video Window.

## 5.2 Composite Video

---

### How to select one of the 7 composite video inputs ?

1. Press **MENU** to activate the Tool bar
2. Press **↓** to Pull down the Source Selection menu
3. Use **↑** or **↓** to select *Composite video*
4. Press **→** to Pull down the submenu
5. Use **↑** or **↓** to select one of the different video inputs (image 5-3)  
**Note:** *Video2 is an optional Video input and is only displayed in case the optional Video/Audio layer is installed.*  
*If the extended mode is disabled, the submenu contains only 1 selection (2 selections if the Audio & Video option is installed).*
6. Press **ENTER** to confirm your choice  
A white bullet indicates the selected composite video source which now appears on the screen.

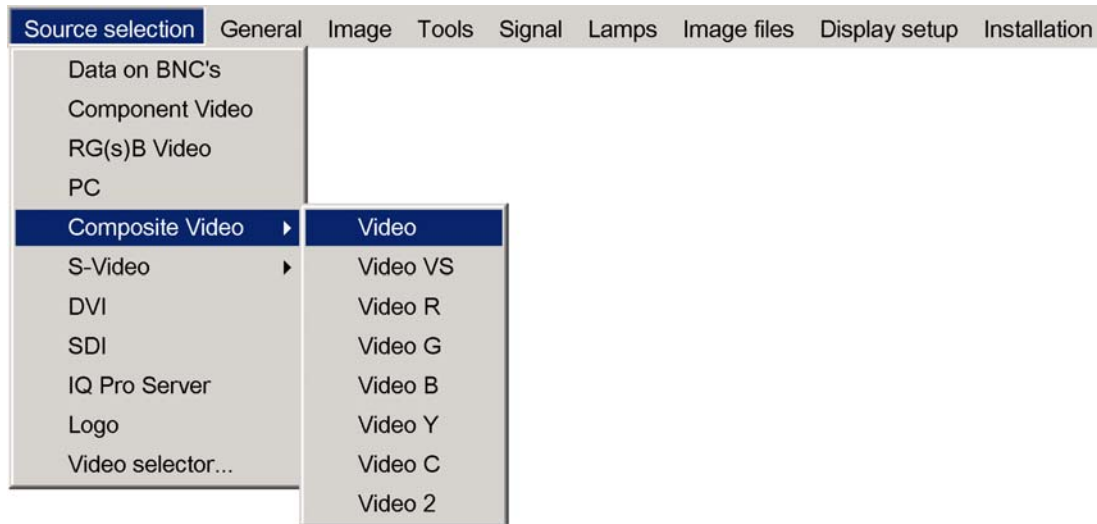

Image 5-3

### Adjustments on a Composite video signal

The projectors allows different adjustments on a composite video signal. Depending on the type of signal (NTSC /PAL) the terminology may differ :

- Contrast
- Brightness
- Color : adjusts the level of color saturation in a PAL signal
- Tint : adjusts the level of color saturation in an NTSC signal
- AGC: Automatic Gain Control



The composite video sources can also be selected using the video selector or via the dedicated key 3 on the RCU. Key 3 allows to browse through the active video inputs when the extended mode is checked in Video Selector..

## 5.3 S-Video

### When

Select the S-Video input when in presence of a video signal also called S-VHS signal.

An S-Video signal is available on the Mini-Din connector of a camera, VCR or DVD player.

### How to select one of the 3 S-Video inputs ?

1. Press **MENU** to activate the Toolbar
2. Press ↓ to Pull down the Source Selection menu
3. Use ↑ or ↓ to select *S-Video*
4. Press → to Pull down the submenu
5. Use ↑ or ↓ to select one of the different video inputs (image 5-4)

**Note:** *S-Video4 is an optional Video input and is only displayed in case the optional Video/Audio layer is installed*

*If the extended mode is disabled, the submenu contains only 1 selection (2 selections if the Audio & Video option is installed).*

6. Press **ENTER** to confirm your choice

A white bullet indicates the selected video source which now appears on the screen.

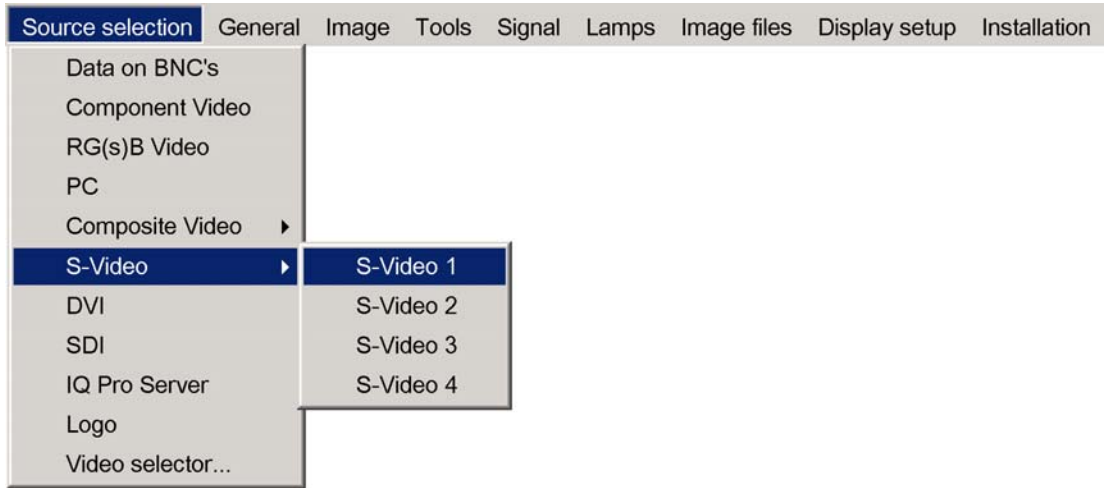

Image 5-4



The S-Video sources can also be selected using the video selector or via the dedicated key 4 on the RCU. Key 4 allows to browse through the active S-Video inputs when the extended mode is checked in Video Selector.

## 5.4 The Video Selector



### Video Selector

The Video Selector is a graphical interface which allows an overview of the different video inputs (Composite Video and S-Video) and whether they are active (signal connected) or not as well as the selection of these different signals.

### Video selector modes

The video selector has two modes:

- standard mode : the video selectable video inputs are the standard composite video & the S-Video input
- extended mode : several BNC connections are added and can be selected as video inputs (S-Video inputs).

### How to display the Video Selector ?

1. Press **MENU** to activate the Tool bar
2. Press **↓** to Pull down the Source Selection menu
3. Use **↑** or **↓** to select *Video selector*
4. Press **ENTER**

On the screen appears a message, (image 5-5)

followed by a graphical interface (image 5-6, image 5-7)

A BNC or S-Video connector on the video selector can be in one of following conditions:

- A: connector disabled
- B: connector enabled but inactive (no video signal present on connector)
- C: connector enabled & active (video signal present on connector)
- D: connector enabled active & selected
- E: connector enabled & active & focused (browser positioned on connector)

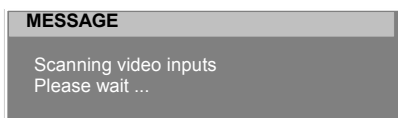
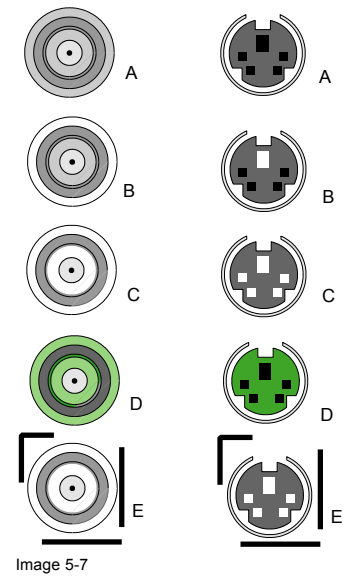
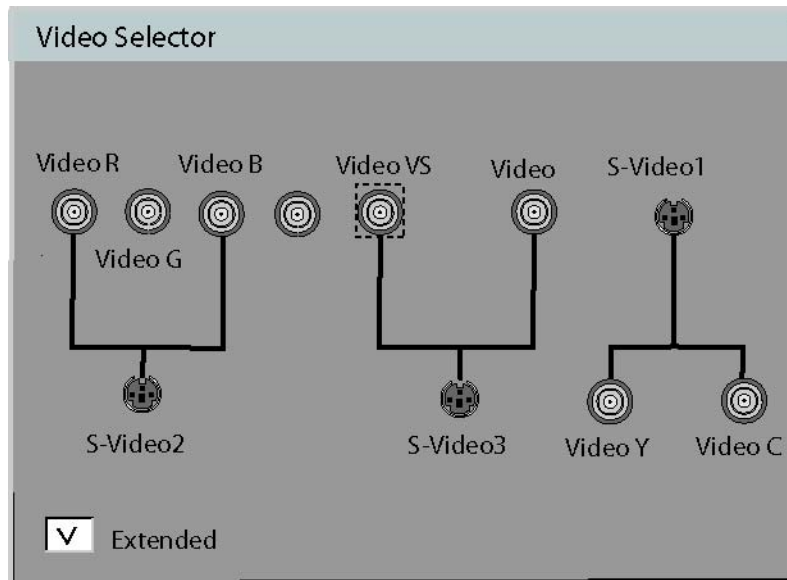
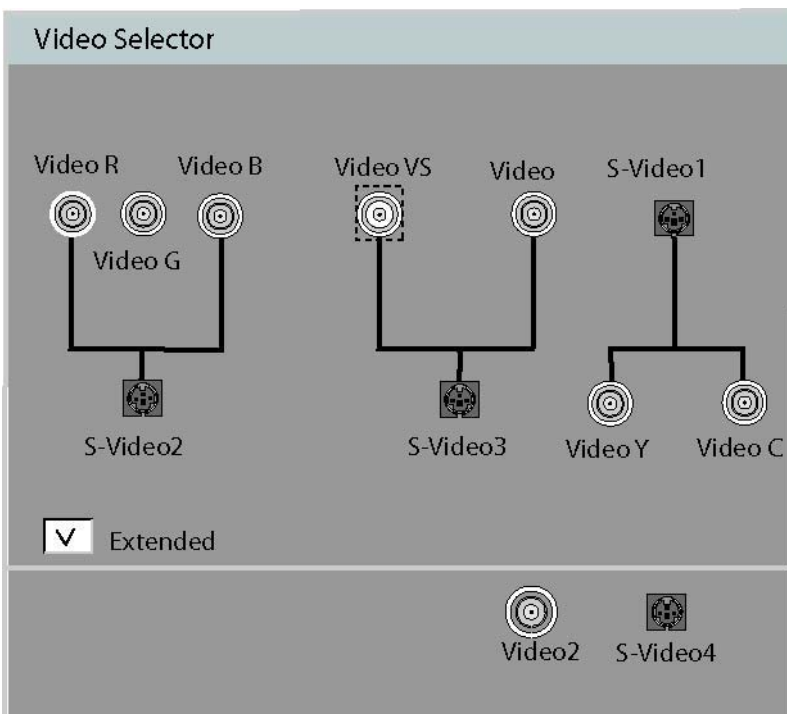

Image 5-5



If the Audio/Video option is installed the Video Selector is updated with the additional Video & S-Video input



### How to select an input on the Video Selector ?

1. Use ←or→ to browse through the different inputs
2. Press **ENTER**  
Use **MENU** or **BACK** to exit the Video Selector

### How to disable the extended Video Selector

1. Use the arrow keys to select the *Extended* checkbox
2. Press **ENTER** to disable the extended mode  
The standard Video Selector is displayed (image 5-9)

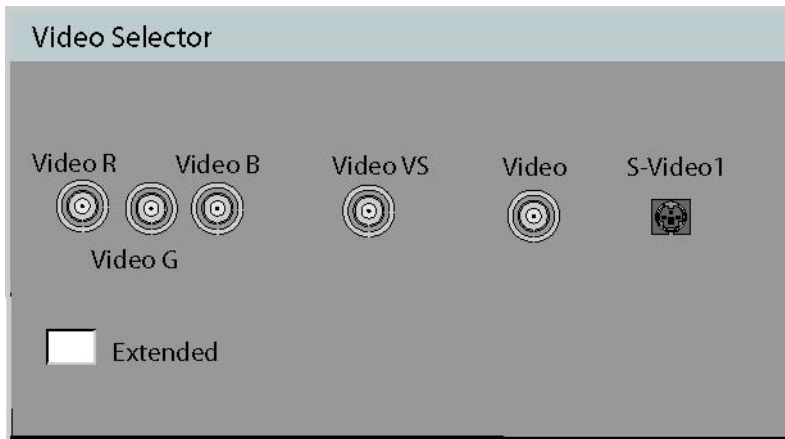

Image 5-9

## 6. GENERAL MENU

### Overview

- Pause
- Freeze
- Standby Timer
- Audio (Optional)
- Identification

### 6.1 Pause

#### Interrupting the image projection

With the Pause function, the image projection can be stopped, the projector remains with full power for immediate restart. The projection is interrupted by means of a mechanical shutter cutting the light beam.

#### How to interrupt the image projection ?

1. Press **MENU** to activate the Tool bar
2. Press → to select *General*
3. Press ↓ to Pull down the General menu
4. Use ↑ or ↓ to select *Pause* (image 6-1)
5. Press **ENTER** to activate the Pause function

A brief sound indicates that the shutter has been activated.

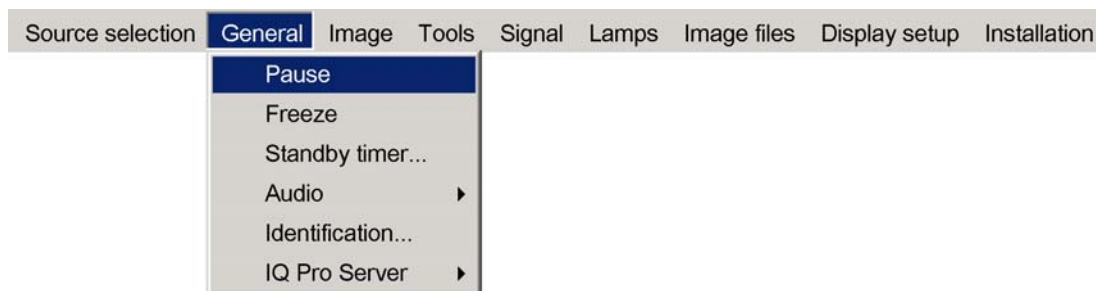

Image 6-1



The image projection can also be interrupted using the **PAUSE** key on the RCU.

To restart the image : press **PAUSE**

### 6.2 Freeze

#### Freezing the image

With the Freeze function, the image can be frozen. To restart the image, reuse the Freeze function or press the **FREEZE** button on the remote.

#### How to freeze the image ?

1. Press **MENU** to activate the Tool bar
2. Press → to select *General*
3. Press ↓ to Pull down the General menu
4. Use ↑ or ↓ to select *Freeze* (image 6-2)
5. Press **ENTER** to activate the Freeze function

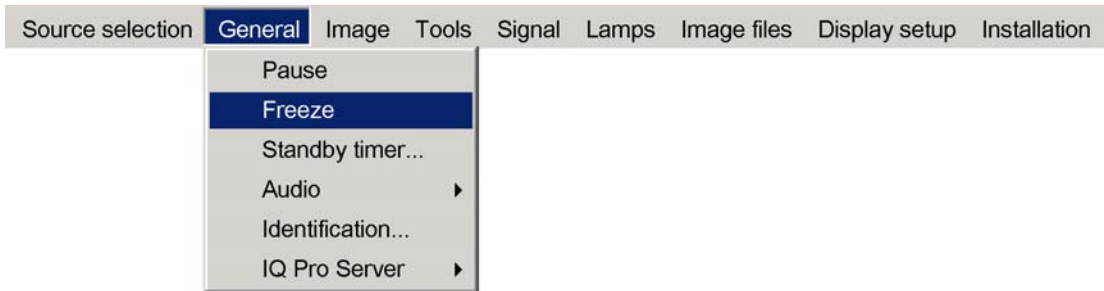

Image 6-2



The image can also be frozen using the FREEZE key on the RCU

### 6.3 Standby Timer

#### Purpose of the Standby Timer

If there is no signal, and the standby timer is enabled, a dialogbox is displayed and the projector will shut down after a determined time.

The countdown time can be set in a dialog box in a range from 180 to 3600 seconds (default value = 300). The Timer can also be disabled.

#### How to enable the timer ?

1. Press **MENU** to activate the Tool bar
2. Press → to select *General*
3. Press ↓ to Pull down the General menu
4. Use ↑ or ↓ to select *Standby Timer* (image 6-3)
5. Press **ENTER** to activate the function  
On the screen appears a dialogbox (image 6-4)
6. Use ↑ or ↓ to select *Enabled*, a box surrounds the selected item, press **ENTER** to activate
7. Use ↑ or ↓ to browse to the input field
8. Use ←or→ , the numeric keys on the remote or the keypad to change the countdown setting
9. Press **MENU** or **BACK** to exit or to go back to the previous menu

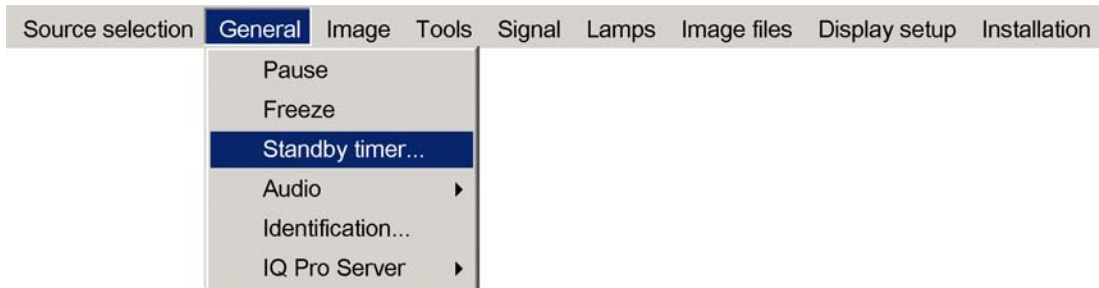

Image 6-3



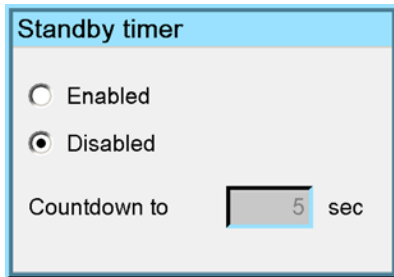

Image 6-4

## 6.4 Audio (Optional)

### Overview

- Audio Setup
- Audio Settings

### 6.4.1 Audio Setup

#### What can be done ?

Layer 3 allows the input of 4 audio signals, each of them can be linked to the corresponding (video or data) source signal. It is also possible to link multiple audio signals to one video (or data) source signal, this can be useful in case of teleconferencing.

The configuration has to be done in the Audio Setup menu

#### Starting the Audio Setup menu

1. Press **MENU** to activate the Tool bar
2. Press **→** to select *General*
3. Press **↓** to Pull down the General menu
4. Use **↑** or **↓** to select *Audio setup* (image 6-5)
5. Press **ENTER**

A dialog box is displayed (image 6-6)

- LED is red : audio input is mute
- LED is green : input is active (linked image source is selected)
- LED is orange : image source is not selected



Image 6-5

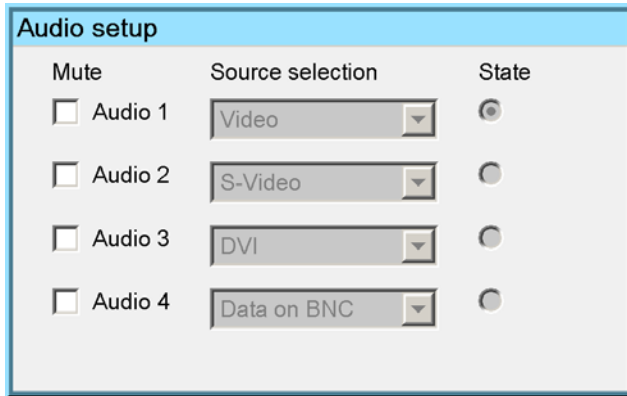

Image 6-6

**How to mute an Audio channel ?**

1. use the arrow keys to select the desired mute box
2. Press **ENTER**

**How to link an audio input to a source ?**

1. use the arrows to select the desired scroll box
2. Press **ENTER** to open the scroll box
3. use **↑** or **↓** to select the source
4. Press **ENTER**



When the source switching mode is the fade in/out mode, the audio switching will also be done using a fade in/out effect.

**6.4.2 Audio Settings**

**Audio Settings**

1. Press **MENU** to activate the Tool bar
2. Press **→** to select *General*
3. Press **↓** to Pull down the General menu
4. Use **↑** or **↓** to select *Audio setup* (image 6-7)
5. Press **ENTER**  
A dialog box is displayed (image 6-8)
6. Use the arrow keys to select and change the settings  
**Note:** *The default value for the volume is 43, this corresponds to a gain factor of 1 (volume in = volume out).*

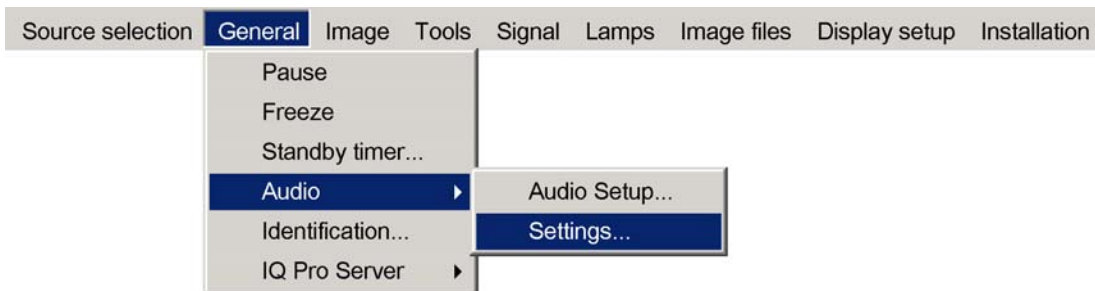

Image 6-7

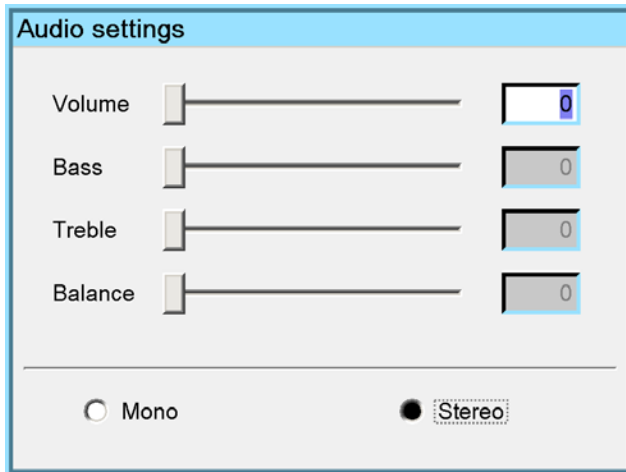

Image 6-8

## 6.5 Identification

### The projector's identification screen

The identification screen displays the projector's main characteristics

#### How to display the identification screen ?

1. Press **MENU** to activate the Tool bar
2. Press → to select *General*
3. Press ↓ to Pull down the General menu
4. Use ↑ or ↓ to select *Identification* (image 6-9)
5. Press **ENTER** to activate the function  
On the screen appears a text box.  
In this case the projector is an iDR500 (image 6-10)
6. Press **MENU** or **BACK** to exit or to go back to the previous menu

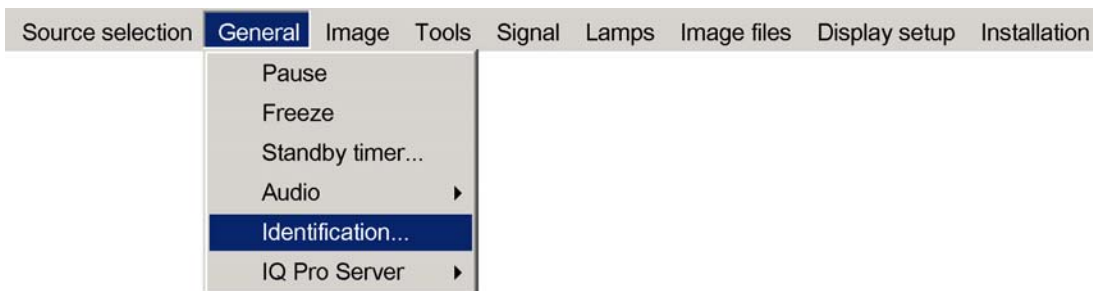

Image 6-9

Identification	
Type	iDR500
Address	2
Software	01.02
RS232 baudrate	115200
Serial number	6001758

Image 6-10

## 7. IMAGE MENU

### Overview

- Settings
- Aspect ratio
- Show native resolution
- Keystone
- Color temperature
- Filmmode detection
- Blanking
- Input balance
- AGC on Video
- Manual Gain Control

### 7.1 Settings

#### Overview

- Contrast
- Brightness
- Color
- Tint (hue)
- Sharpness
- Gamma
- Phase
- Noise reduction

#### What can be done ?

Correct image settings are important for a good image reproduction. The image settings are made through a dialog box with a scroll bar. Minimal, maximal and actual values are indicated. These settings can also be done directly via the RCU's dedicated buttons, except for the sharpness.

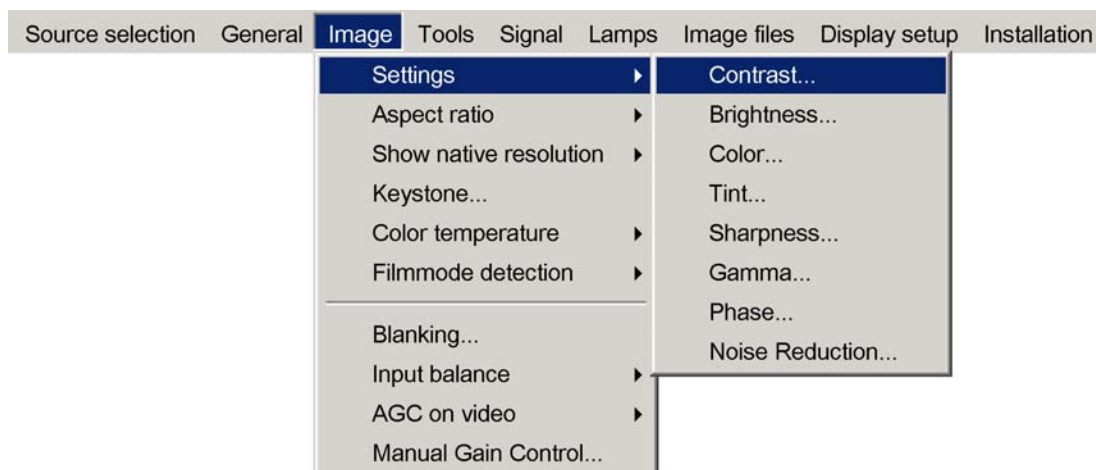

Image 7-1



Image 7-2

### 7.1.1 Contrast

#### Contrast adjustment

Adjust the contrast to "brighten" the white parts of the image.



It is recommended to adjust the brightness before adjusting the contrast.

---

#### How to change the contrast

1. Press **MENU** to activate the Toolbar
2. Press **→** to select the *Image* item
3. Press **↓** to Pull down the *Image* menu
4. Use **↑** or **↓** to select *settings*
5. Press **→** to pull down the menu
6. Use **↑** or **↓** to select *Contrast*
7. Press **ENTER**  
On the screen appears now a sliderbox (image 7-3)
8. Use **←**-or-**→** , the numeric keys on the remote, or the keypad to change the contrast



Image 7-3

### 7.1.2 Brightness

#### Brightness adjustment

Adjusting the brightness will affect the dark areas of the image. Increase the brightness to "lighten" up the parts that are too dark.

#### How to change the Brightness ?

1. Press **MENU** to activate the Toolbar
2. Press **→** to select the *Image* item
3. Press **↓** to Pull down the *Image* menu
4. Use **↑** or **↓** to select *settings*
5. Press **→** to pull down the menu
6. Use **↓** or **↑** to select *Brightness*
7. Press **ENTER**  
On the screen appears now a sliderbox (image 7-4)
8. Use **←**-or-**→** , the numeric keys on the remote, or the keypad to change the Brightness



Image 7-4

### 7.1.3 Color

#### Color adjustment

Adjust the color to obtain more or less saturated colors.

### How to change the Color ?

1. Press **MENU** to activate the Toolbar
2. Press → to select the *Image* item
3. Press ↓ to Pull down the *Image* menu
4. Use ↑ or ↓ to select *settings*
5. Press → to pull down the menu
6. Use ↓ or ↑ to select *Color*
7. Press **ENTER**

On the screen appears now a sliderbox (image 7-5)

8. Use ← or → , the numeric keys on the remote, or the keypad to change the Color

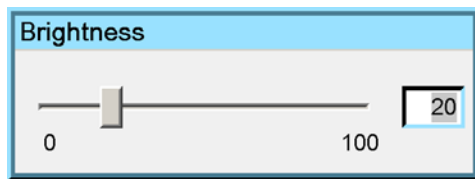

Image 7-5

#### 7.1.4 Tint (hue)

##### How to change the Tint ?

1. Press **MENU** to activate the Toolbar
2. Press → to select the *Image* item
3. Press ↓ to Pull down the *Image* menu
4. Use ↑ or ↓ to select *settings*
5. Press → to pull down the menu
6. Use ↓ or ↑ to select *Tint*
7. Press **ENTER**

On the screen appears now a sliderbox

8. Use ← or → , the numeric keys on the remote, or the keypad to change the Tint

#### 7.1.5 Sharpness

##### How to change the sharpness ?

1. Press **MENU** to activate the Toolbar
2. Press → to select the *Image* item
3. Press ↓ to Pull down the *Image* menu
4. Use ↑ or ↓ to select *settings*
5. Press → to pull down the menu
6. Use ↓ or ↑ to select *sharpness*
7. Press **ENTER**

On the screen appears now a sliderbox

8. Use ← or → , the numeric keys on the remote, or the keypad to change the sharpness

#### 7.1.6 Gamma

##### How to change the Gamma

1. Press **MENU** to activate the Toolbar
2. Press → to select the *Image* item
3. Press ↓ to Pull down the *Image* menu
4. Use ↑ or ↓ to select *settings*

## 7. Image Menu

---

5. Press → to pull down the menu
6. Use ↓ or ↑ to select *Gamma*
7. Press **ENTER**  
On the screen appears now a sliderbox
8. Use ← or → , the numeric keys on the remote, or the keypad to change the Gamma

### 7.1.7 Phase

#### Phase adjustment

A bad phase adjustment will result in bad transitions and sometimes noise (text can end to be unclear).

#### How to change the Phase ?

1. Press **MENU** to activate the Toolbar
2. Press → to select the *Image* item
3. Press ↓ to Pull down the *Image* menu
4. Use ↑ or ↓ to select *settings*
5. Press → to pull down the menu
6. Use ↓ or ↑ to select *Phase*
7. Press **ENTER**  
On the screen appears now a sliderbox (image 7-6)
8. Use ← or → , the numeric keys on the remote, or the keypad to change the Phase

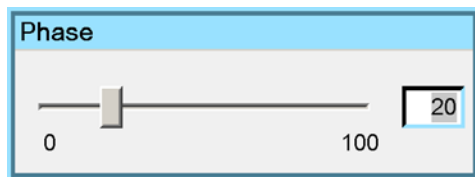

Image 7-6

### 7.1.8 Noise reduction

#### How to change the Noise reduction ?

1. Press **MENU** to activate the Toolbar
2. Press → to select the *Image* item
3. Press ↓ to Pull down the *Image* menu
4. Use ↑ or ↓ to select *settings*
5. Press → to pull down the menu
6. Use ↓ or ↑ to select *Noise reduction*
7. Press **ENTER**  
On the screen appears now a sliderbox
8. Use ← or → , the numeric keys on the remote, or the keypad to change the Noise reduction setting.

## 7.2 Aspect ratio

---

#### Aspect ratios

The standard aspect ratio used in broadcast television is the 4:3 ratio. However, most of the DVD sources use nowadays the widescreen 16:9 or even the cinemascope 2.35:1 aspect ratio.

Some DVD sources may even use the anamorphic 16:9 or anamorphic 2.35:1 to take advantage of the higher vertical resolution offered by the 4:3 ratio. The "anamorphic" term means that the original widescreen image is squeezed in order to fit the 4:3 aspect ratio.



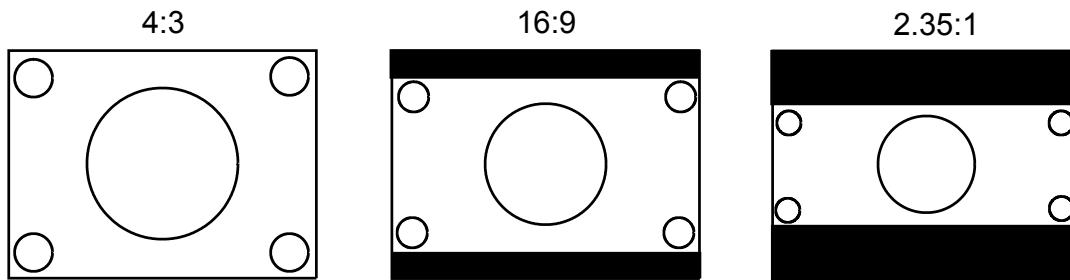

Image 7-7  
Common non- anamorphic aspect ratios in DVD sources

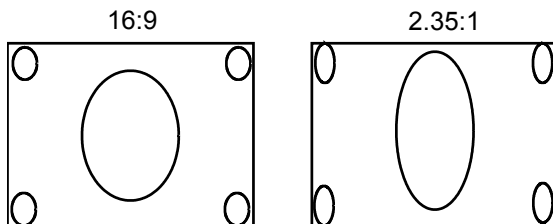

Image 7-8  
Anamorphic aspect ratios in DVD sources

### What can be done ?

The aspect ratio setting forces the projector to project an image using a defined aspect ratio :

- 4:3
- 16:9
- 5:4
- Auto



**The settings do not refer to the aspect ratio of the source !**

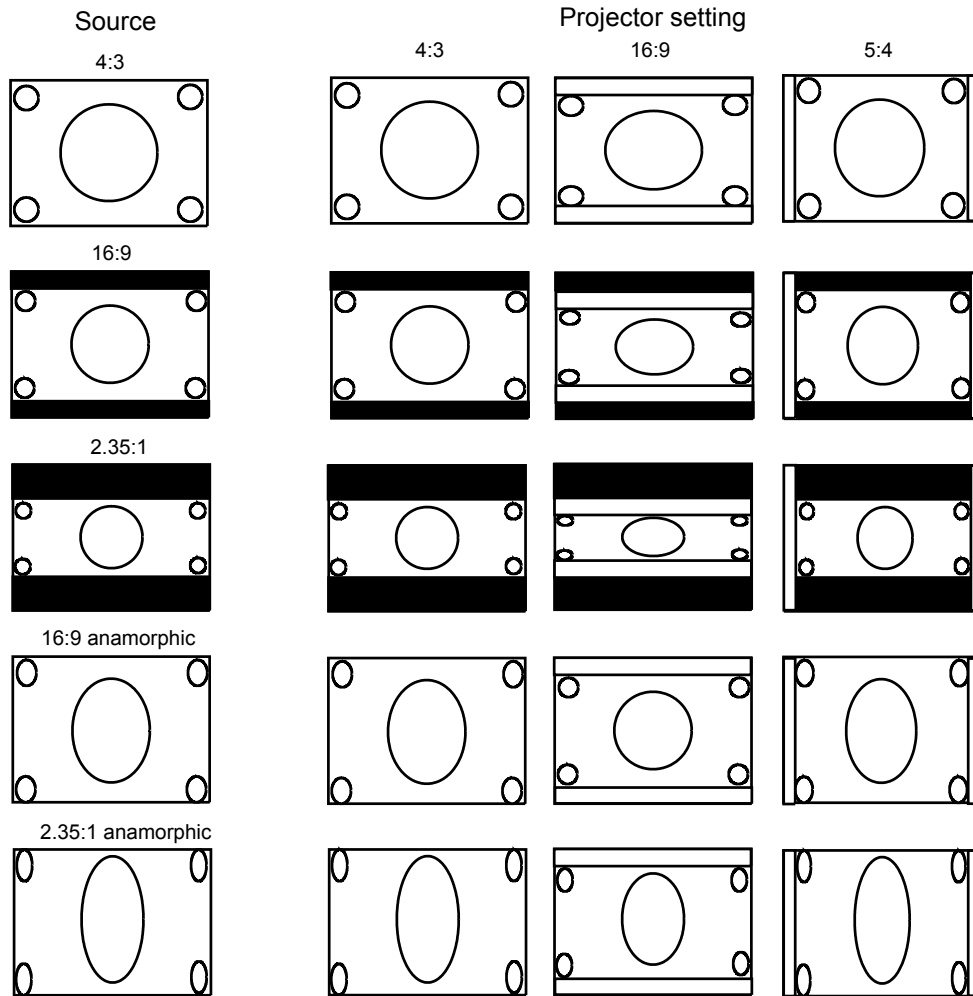

Image 7-9  
Possible aspect ratio settings and their effect on different sources in the iQ.

We can conclude that the thumb rule for DVD projection is to always leave the projector in 4:3 format except when dealing with anamorphic sources where the 16:9 setting allows the best reproduction.

The Auto function calculates an aspect ratio based on the information stored in the image files.



**Selecting Auto in case of a Video source may shrink the image horizontally**

### How to change the Aspect ratio ?

1. Press **MENU** to activate the Tool bar
2. Press **→** to select *Image*
3. Press **↓** to Pull down the *Image* menu (image 7-10)
4. Use **↑** or **↓** to select *Aspect ratio*
5. Use **→** open the *Aspect ratio* menu
6. Use **↑** or **↓** to select the desired ratio
7. Press **ENTER** to confirm

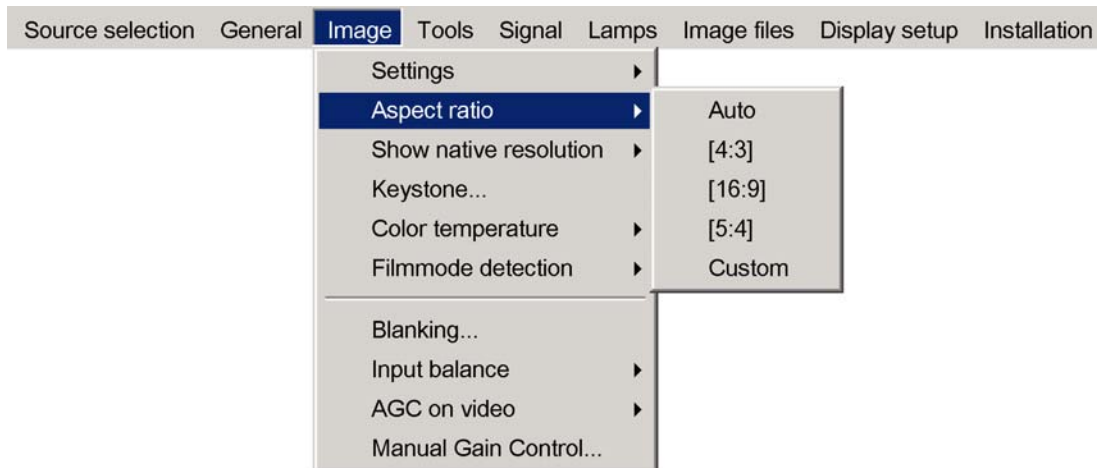

Image 7-10



The aspect ratio settings are greyed out in case the *Show native resolution* or the *Full screen representation* setting is enabled.

### How to set a custom Aspect ratio ?

1. Press **MENU** to activate the Tool bar
2. Press → to select *Image*
3. Press ↓ to Pull down the *Image* menu (image 7-11)
4. Use ↑ or ↓ to select *Aspect ratio*
5. Use → open the *Aspect ratio* menu
6. Use ↑ or ↓ to select *Custom*
7. Press **ENTER** to confirm
  - A dialog box is displayed (image 7-12)
8. Enter the values for width and height of the image
  - The image aspect ratio is updated.

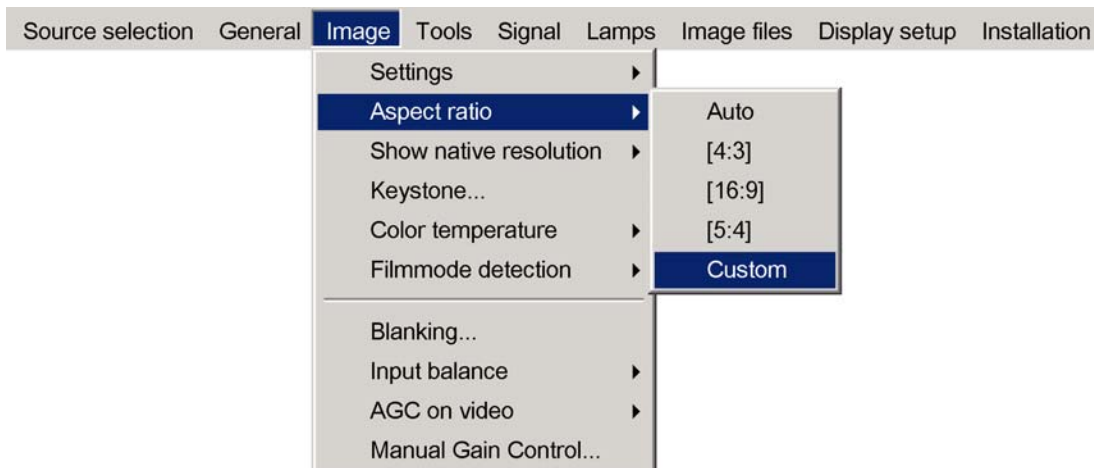

Image 7-11

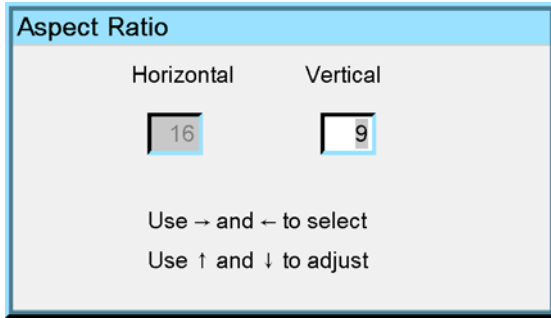

Image 7-12

### 7.3 Show native resolution



#### Graphics

Native resolution of the LCD panels = 1024 pixels x 768 pixels (4:3)



#### Reality(SXGA)

Native resolution of the LCD panels = 1366 pixels x 1024 pixels (4:3)



#### Reality(SXGA+)

Native resolution of the LCD panels = 1400 x 1050 pixels (4:3)

#### What can be done ?

The aim here is to always show the resolution of the source independently of the resolution of the LCD panels. This way better image reproduction is obtained since no up or down scaling is done on the source.

Note that native resolution refers here to the source and does thus only have sense when handling data sources (greyed out for video sources).

Depending on the type of projector the "show native resolution" function will handle the sources as follows:

Source			Projected image			
Name	Ratio	Resolution	Ratio	Resolution	Particularities Reality (SXGA+)	Particularities Graphics
xga	4:3	1024x768	4:3	1024x768	image centered +side blanked	image centered
sxga	5:4	1280x1024	5:4	1280x1024	image centered +side blanked	scroll image
sxga+	4:3	1400x1050	4:3	1400x1050	image centered	scroll image
uxga	4:3	1600x1200	4:3	1600x1200	scroll image	scroll image

Table 7-1  
Show native resolution = ON in case of a Graphics(XGA) and Reality (SXGA+) BarcoIQ projector



The *Full screen representation* function on the other hand forces to use the complete native resolution of the LCD panels.

#### How to enable the "Show native resolution" function?

1. Press **MENU** to activate the Toolbar
2. Press → to select the *Image* item
3. Press ↓ to Pull down the *Image* menu

4. Use ↑ or ↓ to select *Show native resolution* (image 7-13)
5. Press → to pull down the menu
6. Use ↓ or ↑ to select *On*
7. Press **ENTER**

A white bullet shows the selection

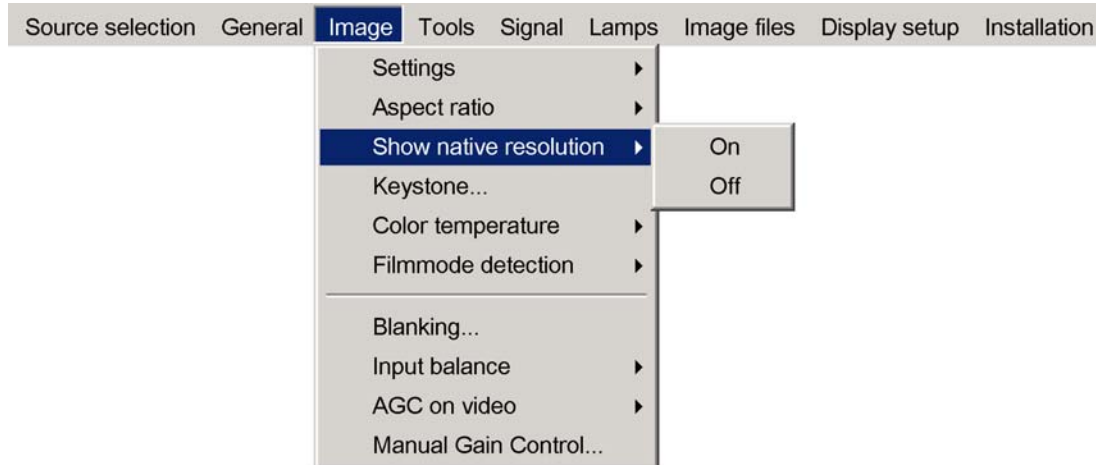

Image 7-13



The default mode is used if the *show native resolution* and the *full screen function* are off.

The default mode shows always the native ratio and forces the native resolution of the panels (part of the image blanked where needed)



When show native resolution is ON and the resolution of the source is higher than the panel resolution , use the arrow keys to scroll through the image (pan).

## 7.4 Keystone

### What can be done ?

The Keystone adjustment is used to align the image, this can be necessary when projecting under a non standard angle

### How to perform a Keystone correction ?

1. Press **MENU** to activate the Tool bar
2. Press → to select *Image*
3. Press ↓ to Pull down the *Image* menu
4. Use ↑ or ↓ to select *Keystone* (image 7-14)
5. Press **ENTER** to confirm

A sliderbox is displayed . (image 7-15)

Use ← or →, the numeric keys on the remote, or the keypad to adjust the keystone.

The Top and bottom adjustments affect the image differently. (image 7-16, image 7-17)

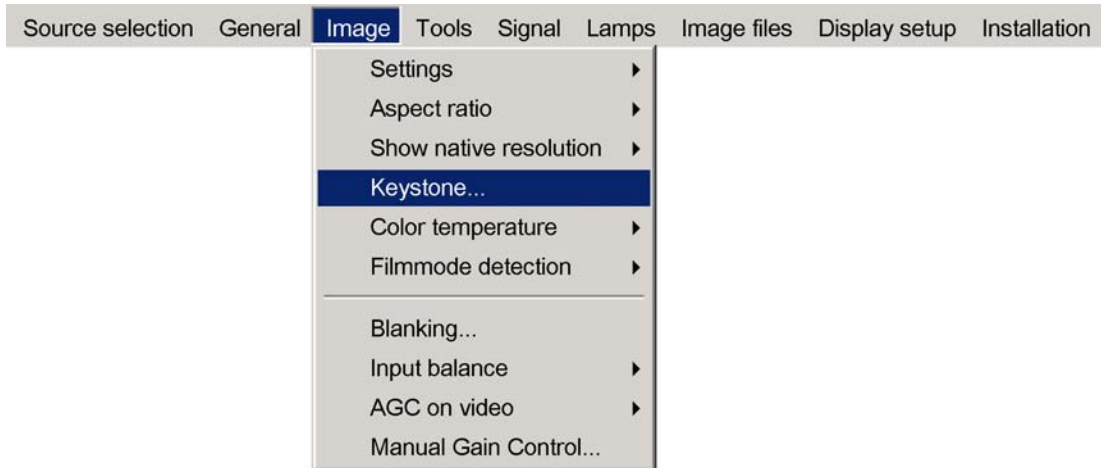

Image 7-14

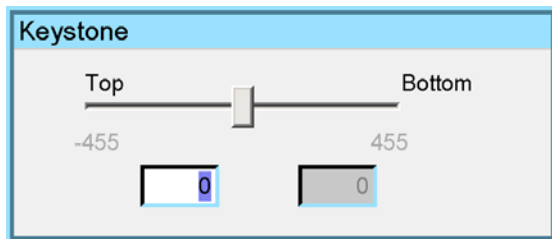

Image 7-15

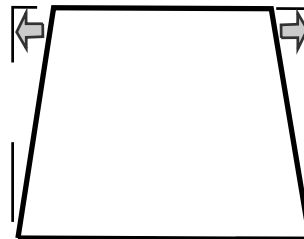

Image 7-16  
Top adjustment of the keystone

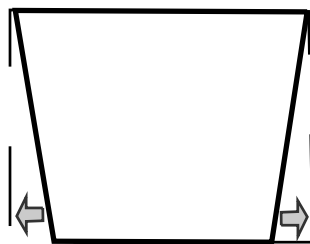

Image 7-17  
Bottom adjustment of the keystone

## 7.5 Color temperature

### What can be done ?

The color temperature can be selected according to the type of source:

There are 4 different preset color temperatures:

- Projector white
- computer : 9300 K
- Video : 6500 K
- Film : 5400 K
- Broadcast : 3200 K

These calibrated presets can be selected and will provide optimum color tracking, the projector allows however the setting of a personal color temperature, this is done in *custom*

### How to select a preset color temperature ?

1. Press **MENU** to activate the Tool bar
2. Press → to select the *Image* item
3. Press ↓ to Pull down the *Image* menu

4. Use ↑ or ↓ to select *Color temperature*
5. Press → to pull down the menu
6. Use ↓ or ↑ to select the desired preset color temperature
7. Press **ENTER**

The color temperature of the image is adapted and a white bullet shows the active setting.

### How to start up the custom color temperature ?

1. Press **MENU** to activate the Tool bar
2. Press → to select the *Image* item
3. Press ↓ to Pull down the *Image* menu
4. Use ↑ or ↓ to select *Color temperature*
5. Press → to pull down the menu
6. Use ↓ or ↑ to select *custom*
7. Press **ENTER**

A slider box for the red custom setting is displayed as well as a wizard text box in the lower part of the screen. (image 7-18, image 7-19)

Follow the instructions on the wizard textbox. (image 7-20)

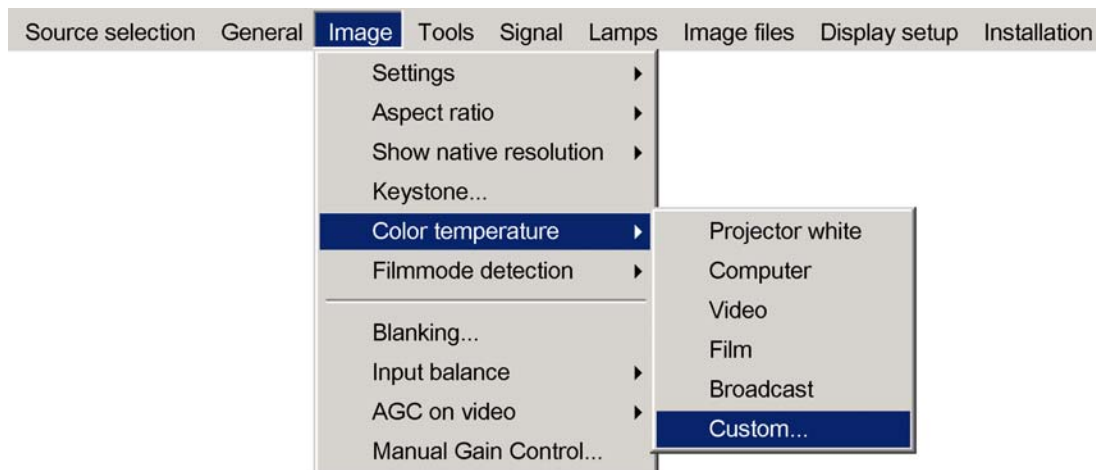

Image 7-18



Image 7-19



Image 7-20

## 7.6 Filmmode detection

### What can be done ?

Some sources like common DVD material are derived from cinema 24 Hz sources (2/2 or 3/2 pull down method).

## 7. Image Menu

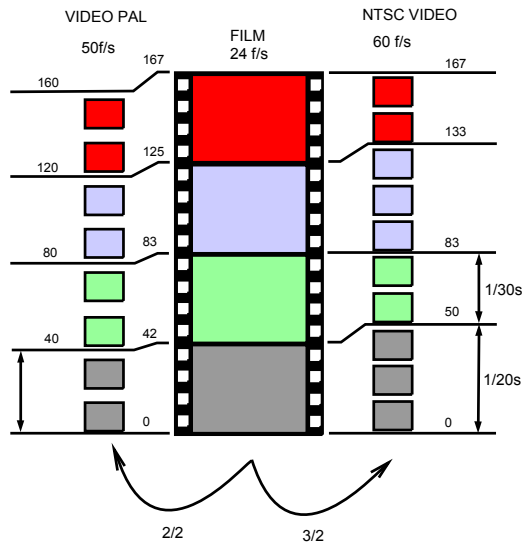

Image 7-21  
film to video conversion: 2/2 and 2/3 pull down method

The filmmode detection insures that these converted signals are shown without artefacts, especially motion artefacts due to bad de-interlacing.

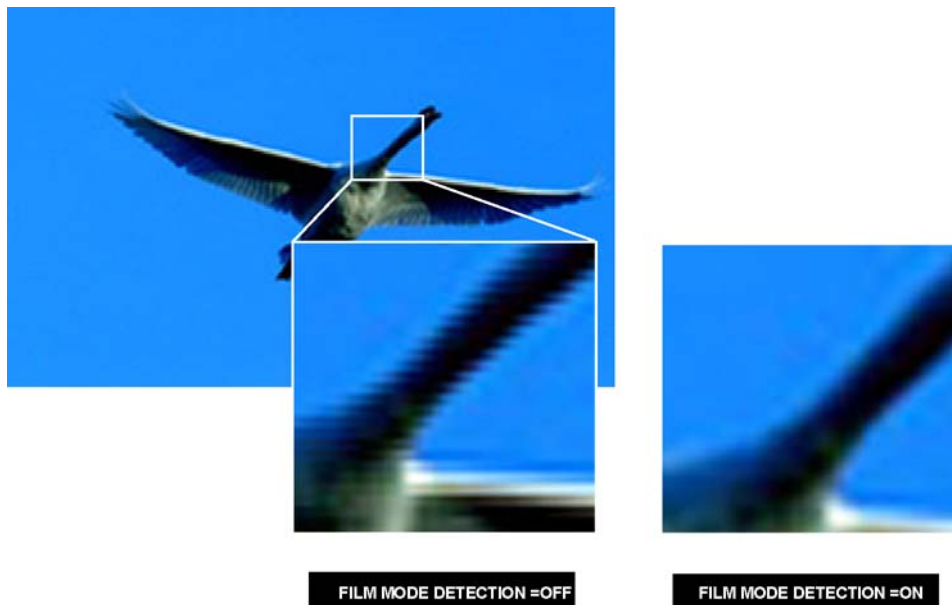

Image 7-22



This function may cause undesired effects on standard sources, therefore it can be disabled (OFF) at any time

### Enabling/disabling the filmmode detection

1. Press **MENU** to activate the Toolbar
2. Press **→** to select the *Image* item
3. Press **↓** to Pull down the *Image* menu
4. Use **↑** or **↓** to select *Filmmode detection*
5. Press **→** to pull down the menu
6. Use **↓** or **↑** to enable or disable the Filmmode detection
7. Press **ENTER**

A white bullet shows the active setting (image 7-23)



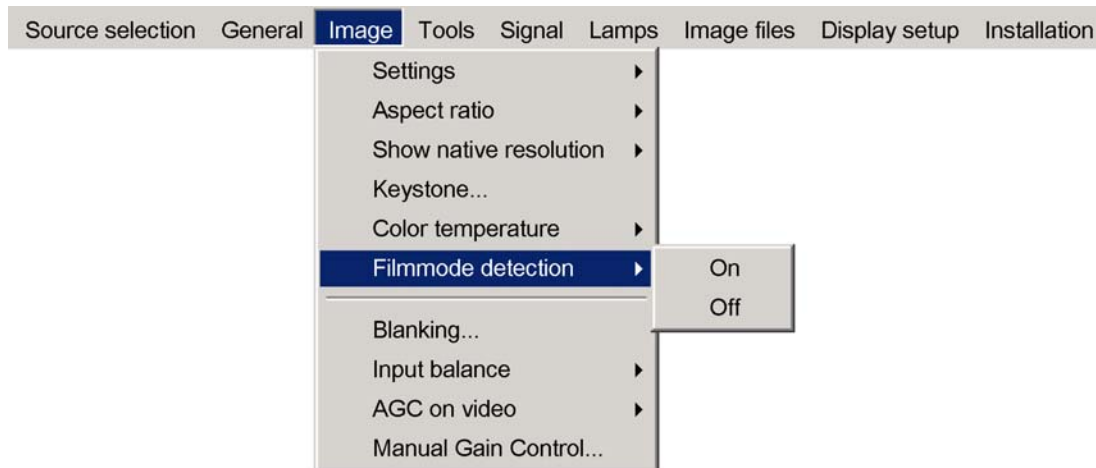

Image 7-23

## 7.7 Blanking

### Blanking in the Image menu

The blanking in general allows to blank unwanted video information (noise in the top or bottom of the image).

The blanking in the image menu is the same as in the Display settings menu except for the fact that here the blanking settings are **stored** in the image files. In other words each custom file or source has its own blanking values.

See the blanking procedure in the Display settings menu.



**If the selected source is not entirely displayed always check first the blanking settings in the image menu since the active custom file may contains blanking.**

## 7.8 Input balance

### Introduction: Unbalanced color signals

When transporting signals, there is always a risk of deterioration of the information contained in the signals.

In case of information contained in the amplitude of the signals which is the case of data color signals (R, G, B), image 7-24, we are quite sure that the amplitude of these color signals is subject to alterations.

An example of alteration may be a DC component added to the signal, in the form of a DC offset repositioning the black level, since this **black level** (“**brightness**”) will become crucial later on ( clamping circuit) it will result in “black not being black”.

Another value that is subject to alteration is the amplitude of the signal, resulting in an altered “Gain” of the signal (“**white level**” or **contrast** ).

The alterations of the three color signals will happen independently i.e. the colors will end to be unbalanced, image 7-25



Image 7-24

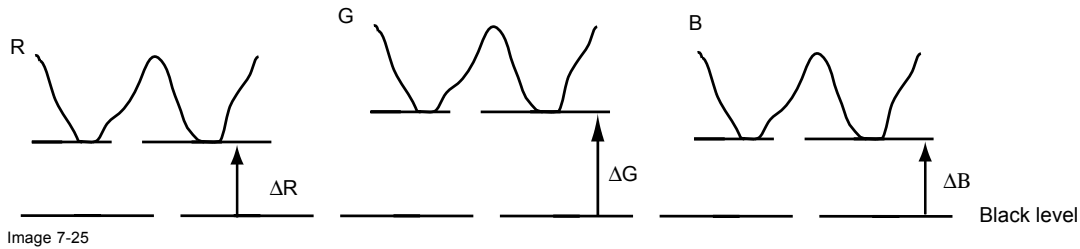

Image 7-25



One can conclude here that a good color tracking can only be met by using three previously (input) balanced color signals

### Analog Digital Conversion

The analog color signals must pass through an Analog/Digital conversion circuit prior to any digital processing in the PMP.

A typical ADC transforms the analog value into an 8 bit coded digital signal.

The graphic shows that when converting a signal containing a DC offset component the range of the converter is not optimally used.

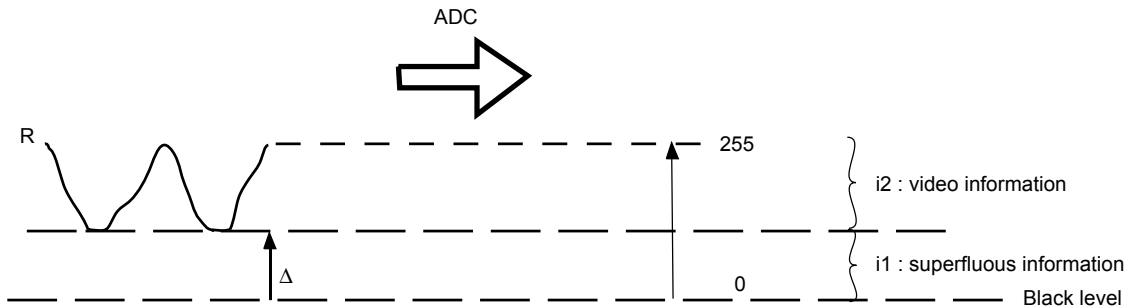

Image 7-26



One can conclude here that a good data conversion can only be met by using three previously (input) balanced color signals

### The objective of input balancing

The objective in input balancing is to "set" the same black level and the same white level for the three colors of a particular input source.



**Black level setting : brightness**

**White level setting : contrast**

The same absolute black and white level for the three colors allows the same reference for Brightness and contrast control of the picture !

These two references also set the range in which the ADC will work for that particular source ( this explains also why each input balance setting is linked to a particular source and thus saved in the image file).

### How can it be done ?

To balance the three color signals of a particular source there are conditions; in fact we must know the black and the white level of the source i.e. :

1. the source in question must be able to generate a white signal, ideally a 100% white (background) full screen pattern
2. the source in question must be able to generate a black signal, ideally a 100 % black (background) full screen pattern

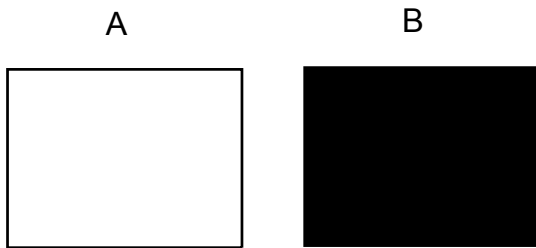

Image 7-27

White balance : In the projector, we will set the contrast for each color until we get a 100% light output picture when projecting a 100% white image (image A)

Black balance : In the projector, we will set the brightness for each color until we get a 0% light output picture when projecting a 100% black image (image B).



The changeover from min to max is indicated by the apparition of bright spots also called “digital noise”



An alternative to a full screen White/black pattern is the standard gray scale pattern, the white bar will be used for white balance and the black bar for black balance.

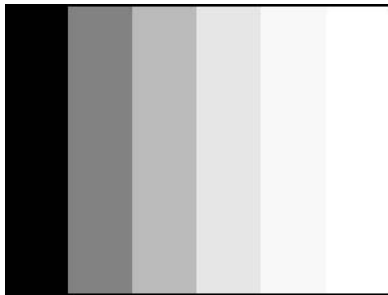

Image 7-28

### Black balance

1. Press **MENU** to activate the Toolbar
2. Press → to select the *Image* item
3. Press ↓ to Pull down the *Image* menu
4. Use ↑ or ↓ to select *Input balance*
5. Press → to pull down the menu
6. Use ↓ or ↑ to select *Black balance* (image 7-29)
7. adjust the red black level on a minimal value (image 7-30, image 7-31)
8. adjust the blue black level on a minimal value
 

**Note:** *this minimal value is not necessary , provided that the 2 other colors are not influencing too much the color to be adjusted, in fact the aim is to minimize the effect of the two other colors since there is a risk of reaching too soon the 50% transition due to the contribution of these two other colors signals.*
9. Adjust the green black level until bright spots appear on the screen
- 10.adjust the blue black level on a minimal value
 

**Note:** *this minimal value is not necessary , provided that the 2 other colors are not influencing too much the color to be adjusted, in fact the aim is to minimize the effect of the two other colors since there is a risk of reaching too soon the 50% transition due to the contribution of these two other colors signals.*
- 11.Adjust the green black level until bright spots appear on the screen
- 12.Adjust the Blue black level until bright spots appear on the screen
- 13.Adjust the red black level until bright spots appear on the screen
 

the projected image should know be noisy full black

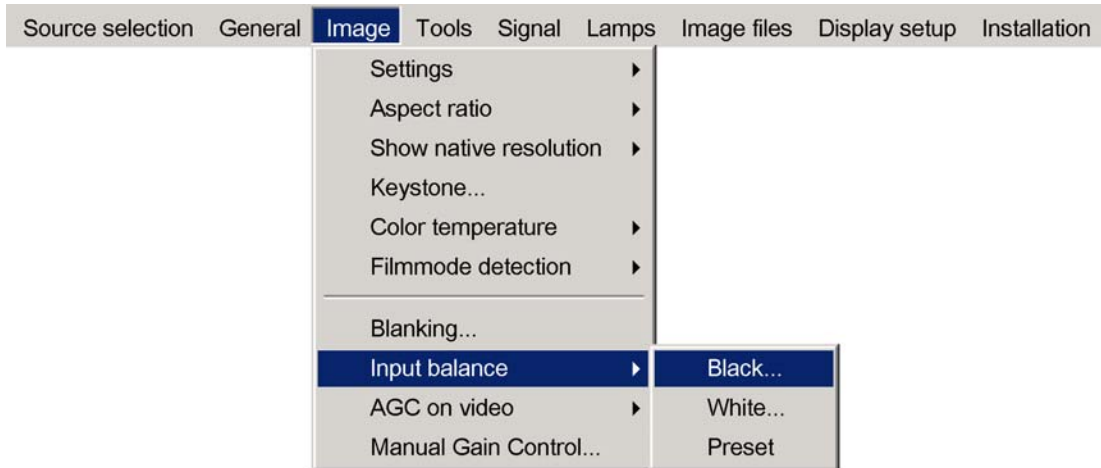

Image 7-29



Image 7-30



Image 7-31

### Performing White input balance

1. Connect the source you want to project
  2. Select a white pattern (or gray scale as alternative)
  3. Press **MENU** to activate the Toolbar
  4. Press → to select the *Image* item
  5. Press ↓ to Pull down the *Image* menu
  6. Use ↑ or ↓ to select *Input balance*
  7. Press → to pull down the menu
  8. Use ↓ or ↑ to select *White balance* (image 7-32)
  9. adjust the red white level (gain) on a minimal value (image 7-33)
  10. adjust the blue white level (gain) on a minimal value
 

**Note:** *this minimal value is not necessary , provided that the 2 other colors are not influencing too much the color to be adjusted, in fact the aim is to minimize the effect of the two other colors since there is a risk of reaching too soon the transition (bright spots) due to the contribution of these two other colors signals.*
  11. Adjust the Green white level (gain) until bright spots appear on the screen
  12. Adjust the Blue white level (gain) until bright spots appear on the screen
  13. Adjust the Red white level (gain) until bright spots appear on the screen
- the projected image should know be noisy neutral grey.

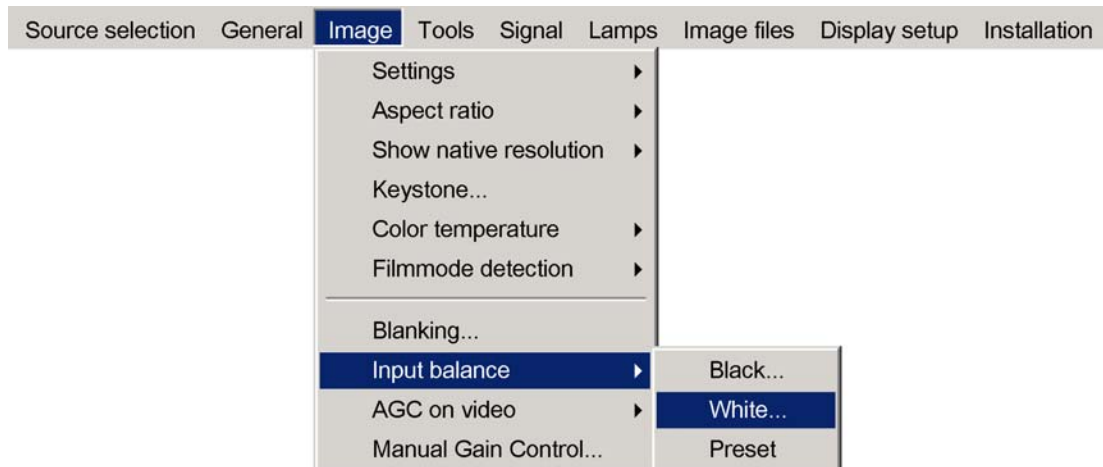

Image 7-32

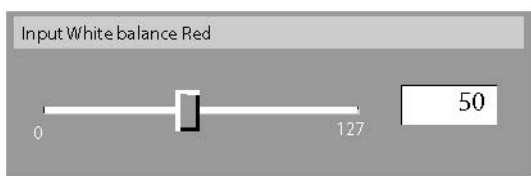

Image 7-33



if one uses a gray scale pattern, the bright spots should appear in the white bar.



Selecting *Preset* restores the factory input balance setting

### Remark on the input balance of a component video source



Before starting the Input Balance procedure, generate a signal with dominant white parts.

Input balance is also available for a component video source under following conditions:

- A component video signal is present on the BNC's
- "Data on BNC's" is selected in the *Source selection menu*
- Cr/Y/Cb is selected in the Advanced menu of the corresponding image file

The procedure is the same as for a data source except:

## 7. Image Menu

---

- The white balance happens only on Green  
Adjust until bright spots appear in the image

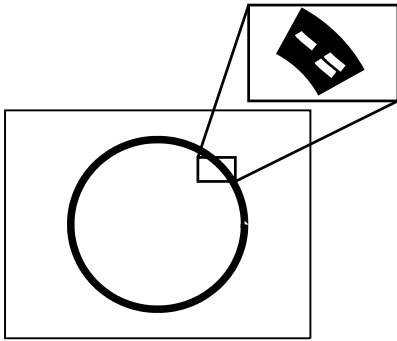

Image 7-34

- The black balance happens on the three colors  
The PR and PB connector have to be removed from the input  
Adjust until noise appears in the image

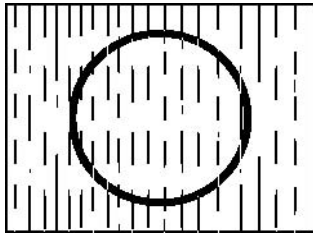

Image 7-35



The input balance settings are stored in the image file, each source has its own input balance.

---

## 7.9 AGC on Video

---



### AGC

Automatic Gain Control: allows an automatic amplitude (gain) control of the incoming video signal

---



### AGC is only for Video signals

---

### Enabling/disabling the AGC

1. Press **MENU** to activate the Tool bar
2. Press **→** to select the *Image* item
3. Press **↓** to Pull down the *Image* menu
4. Use **↑** or **↓** to select *AGC on Video*
5. Press **→** to pull down the menu
6. Use **↓** or **↑** to enable or disable the AGC
7. Press **ENTER**

A white bullet shows the active setting (image 7-36)

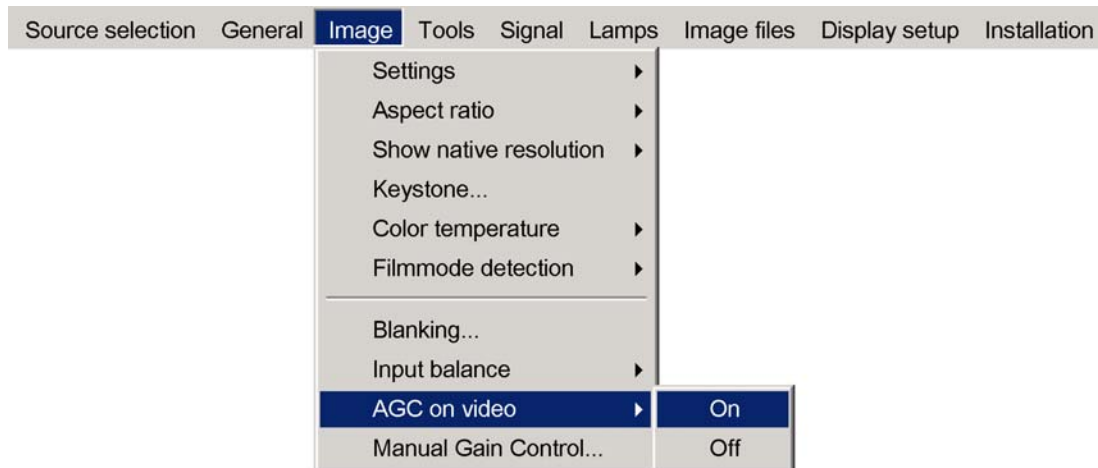

Image 7-36



The AGC can be disturbing in case of Macrovision encoded signals, therefore the AGC can be disabled (OFF) at any time

## 7.10 Manual Gain Control

### What can be done ?

Beside the AGC there is the possibility to manually set the gain of the incoming video signal. When the AGC is enabled (ON), the manual setting does not affect the gain, AGC must therefore be disabled. The manual gain control must be done on an external pattern with white areas (grey scale bar pattern)

### How to set the Manual Gain Control ?

1. Press **MENU** to activate the Tool bar
2. Press → to select the *Image* item
3. Press ↓ to Pull down the *Image* menu
4. Use ↑ or ↓ to select *Manual Gain Control* (image 7-37)
5. Press **ENTER**
  - A scroll bar is displayed (image 7-38)
6. Use ← or →, the numeric keys on the remote, or the keypad to change the gain so as to obtain homogene white parts in the image.

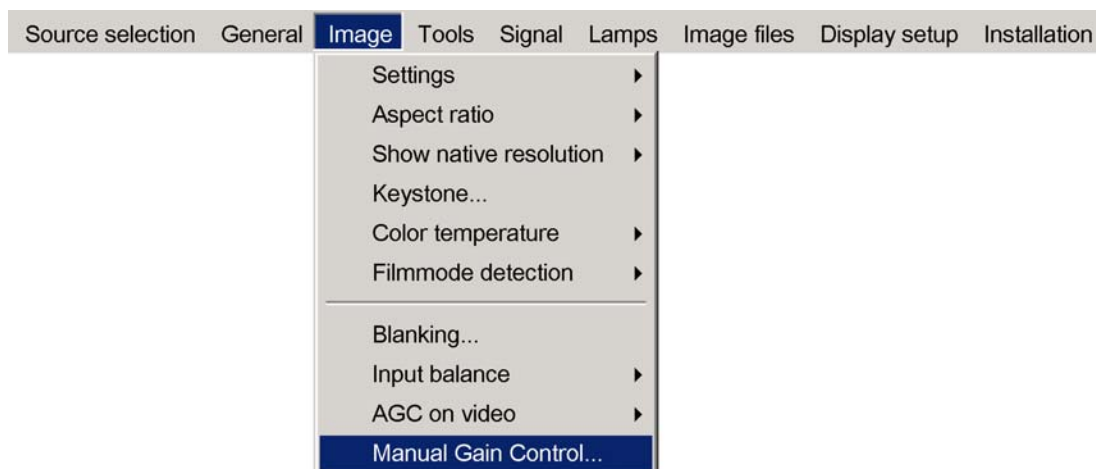

Image 7-37



Image 7-38



---

## 8. TOOLS MENU

### Overview

- Introduction to PiP
- PiP select
- PiP add window
- PiP remove window
- PiP layout
- PiP Adjust
- Diagnostics

### 8.1 Introduction to PiP

---



#### PiP

PiP stands for "Picture in Picture" and allows to display multiple windows containing each of them an image. The windows may be of the video or data type.

---

#### What are the different possibilities within the PiP mode ?

The input section of the IQ projector allows a multitude of combinations of different input signals which may be projected in the 4 windows of the PiP screen.

The PiP mode allows independent settings for each window:

- Image settings : contrast, brightness, tint, color,...
- Vertical and horizontal shift of each window all over the screen
- Resizing of the window
- Digital Zoom
- Linking of (an) audio input(s) to a single or multiple windows

### What are the different PiP layouts ?

- Full screen<sup>2</sup>

The full screen is used to display one of the selected sources.  
Browsing through the sources is possible with the **PiP Adjust** button on the remote.

- 2-by-2 raster<sup>2</sup>

The screen is divided into 4 subscreens containing 2 Video and 2 Data sources.



Image 8-1  
PiP: 2by2 layout

- PiP layout 1-3<sup>3</sup>

These are factory layouts, they can be edited and saved.

- Personal layouts

Beside the 2 fixed layouts and the 3 factory layouts, one can set 5 additional (personal) layouts.

### PiP dedicated buttons

- **PiP Adjust** : this button allows to focus on one particular window, this is shown with a white frame surrounding the selected window.  
A source identification box is displayed in the right lower corner.

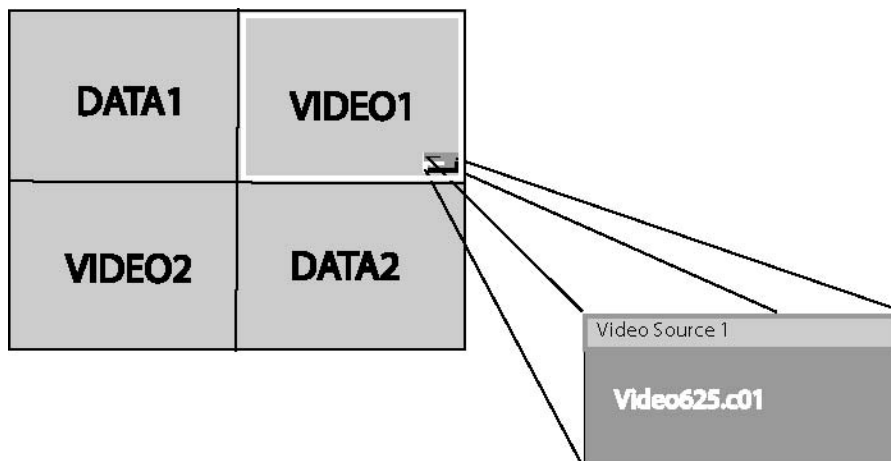

Image 8-2

Pressing the button removes the frame to the next window. This can also be done via *PiP Adjust* in the Tools menu

- **PIP**: this button allows to browse through the different configurations, it has the same function as *PiP select* in the Tools menu.



Since there is only one decoder (second decoder is optional), when in 2by2 configuration, Video1 and Video2 are derived from the same video source.

<sup>2</sup>. fixed layout  
<sup>3</sup>. factory layouts

## 8.2 PiP select

### PiP layouts

The different PiP layouts (configurations) can be selected in the PiP select menu.

### How to change the PiP configuration ?

1. Press **MENU** to activate the Tool bar
2. Press → to select the *Tools* item
3. Press ↓ to Pull down the *Tools* menu
4. Use ↑ or ↓ to select *PiP select*
5. Press → to pull down the menu
6. Use ↑ or ↓ to select the desired configuration
7. Press **ENTER**

A white bullet shows the active layout (image 8-3)



Image 8-3



The PiP configuration can also be selected via the dedicated PiP key on the RCU.

## 8.3 PiP add window

### What can be done ?

It is possible to add a window to the existing windows (maximum 4), therefore a source must be selected.

Sources which are already used are non selectable. If, for instance, the PiP layout contains a component video then component video will be non selectable.

Once added, the window may be altered in several ways to meet particular needs:

- repositioning
- re-sizing
- changing the order

### How to add a window ?

1. Press **MENU** to activate the Tool bar
2. Press → to select the *Tools* item
3. Press ↓ to Pull down the *Tools* menu
4. Use ↑ or ↓ to select *PiP add window* (image 8-4)
5. Press **ENTER**

The source selection menu is displayed (image 8-5)

In the lower part of the screen appears a wizard in 4 steps (image 8-6)

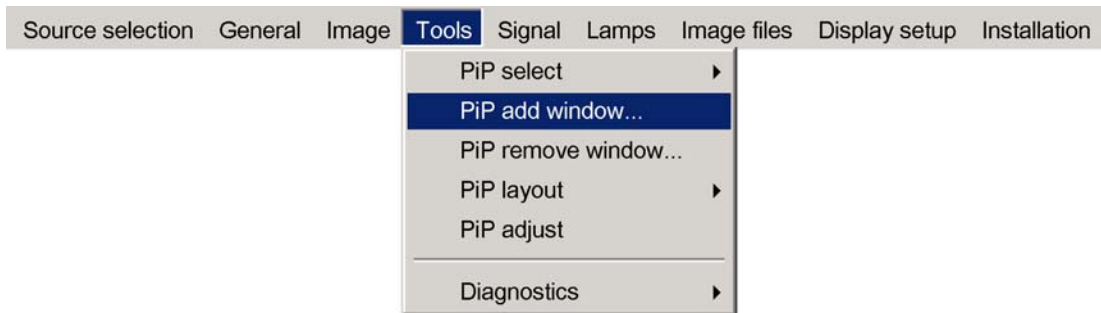

Image 8-4

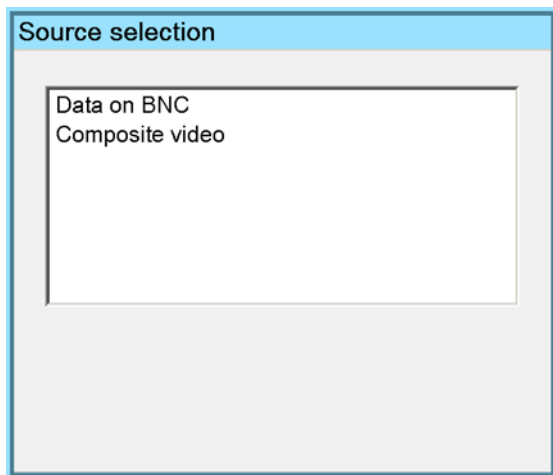

Image 8-5

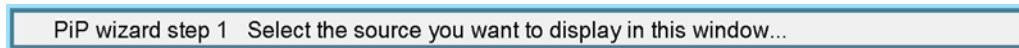

Image 8-6

## 8.4 PiP remove window

### How to remove a window ?

1. Press **MENU** to activate the Tool bar
2. Press → to select the *Tools* item
3. Press ↓ to Pull down the *Tools* menu
4. Use ↑ or ↓ to select *PiP remove window* (image 8-7)
5. Press **ENTER**

In the lower part of the screen appears a wizard. (image 8-8)

The selected window appears surrounded with a white frame, each hit on **PIP ADJUST** will move the frame along the different windows.

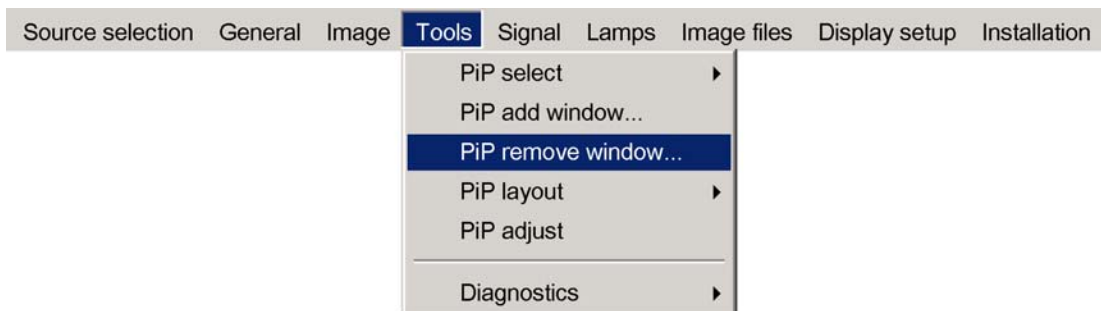

Image 8-7

Change color between Red and Blue with < -COLOR+ >

Image 8-8

## 8.5 PiP layout

### Overview

- PiP Save
- PiP rename layout
- PiP delete layout

### 8.5.1 PiP Save

#### What can be done ?

The active layout can be saved or "saved as".

When a new layout is saved it is added to the *PiP select* menu.



A fixed layout can be edited (re-sizing, re-positioning,...) but it can not be saved under its original name.

#### How to save a layout ?

1. Press **MENU** to activate the Tool bar
2. Press → to select the *Tools* item
3. Press ↓ to Pull down the *Tools* menu
4. Use ↑ or ↓ to select *PiP layout*
5. Press → to pull down the menu
6. Use ↑ or ↓ to select *PiP save* or *save as* (image 8-9)
7. Press **ENTER**

If *save as* has been selected, a dialog box is displayed (image 8-10)

Use ← or →, the numeric keys on the remote, or the keypad to enter the name and exit with **BACK** or **MENU**.

If *save* has been selected, a message box is displayed (image 8-11)

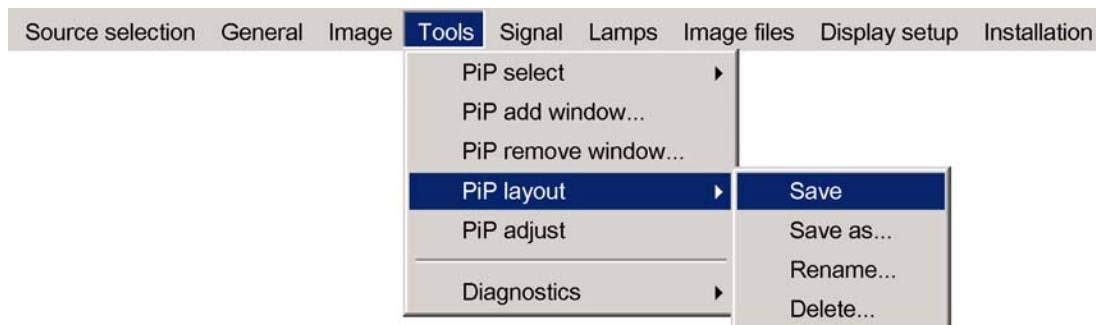

Image 8-9

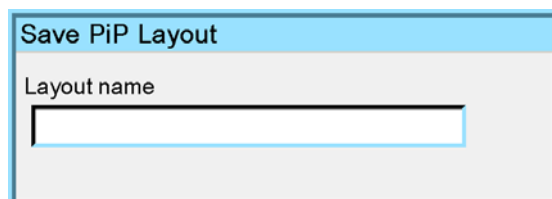

Image 8-10

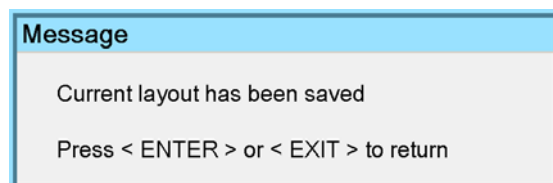

Image 8-11

### 8.5.2 PiP rename layout

#### What can be done ?

The non fixed layouts (factory and personal layouts) can be renamed .

The maximal length of the name is 12 characters.

---



**A fixed layout can not be renamed**

---

#### How to rename a layout ?

1. Press **MENU** to activate the Tool bar
2. Press → to select the *Tools* item
3. Press ↓ to Pull down the *Tools* menu
4. Use ↑ or ↓ to select *PiP layout*
5. Press → to pull down the menu
6. Use ↑ or ↓ to select *Rename*
7. Press **ENTER**

A dialog box is displayed (image 8-12)

8. Use ↑ or ↓ to select the layout to be renamed

9. Press **ENTER**

A dialog box is displayed (image 8-13)

Use ← or →, the numeric keys on the remote, or the keypad to enter the name and exit with **BACK** or **MENU**.

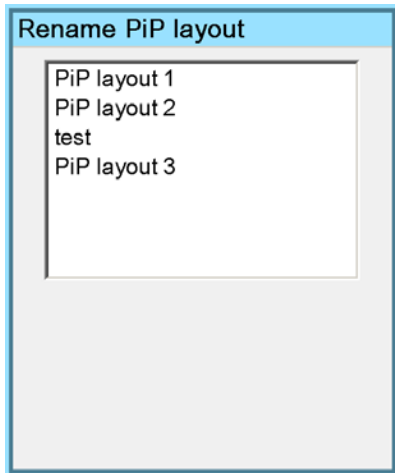

Image 8-12

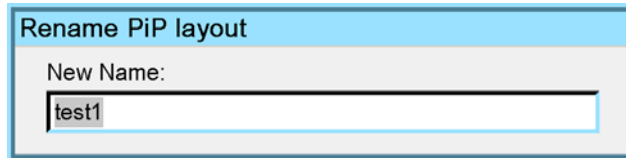

Image 8-13

### 8.5.3 PiP delete layout

#### What can be done ?

The non fixed layouts (factory and personal layouts) can be deleted.

---



**The fixed layouts and the active layout can not be deleted**

---

#### How to delete a layout ?

1. Press **MENU** to activate the Tool bar
2. Press → to select the *Tools* item
3. Press ↓ to Pull down the *Tools* menu

4. Use ↑ or ↓ to select *PiP layout*
5. Press → to pull down the menu
6. Use ↑ or ↓ to select *Delete*
7. Press **ENTER**  
A dialog box is displayed (image 8-14)
8. Use ↑ or ↓ to select the layout to be renamed
9. Press **ENTER**  
The layout is deleted and disappears from the dialog box

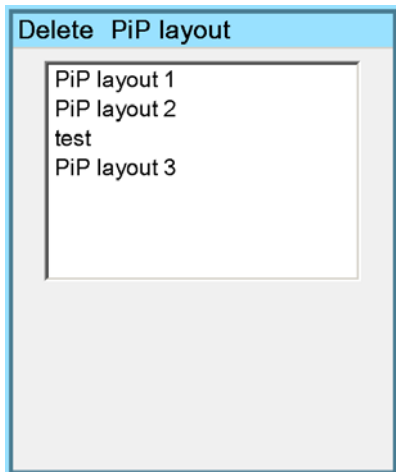

Image 8-14

## 8.6 PiP Adjust

### What can be done ?

PiP adjust allows to browse through the windows in the active layout, a white frame indicates the window which has the focus. This way, independent settings (picture settings, ...) are possible for each window.



This can also be done by using the dedicated PiP Adjust key on the RCU

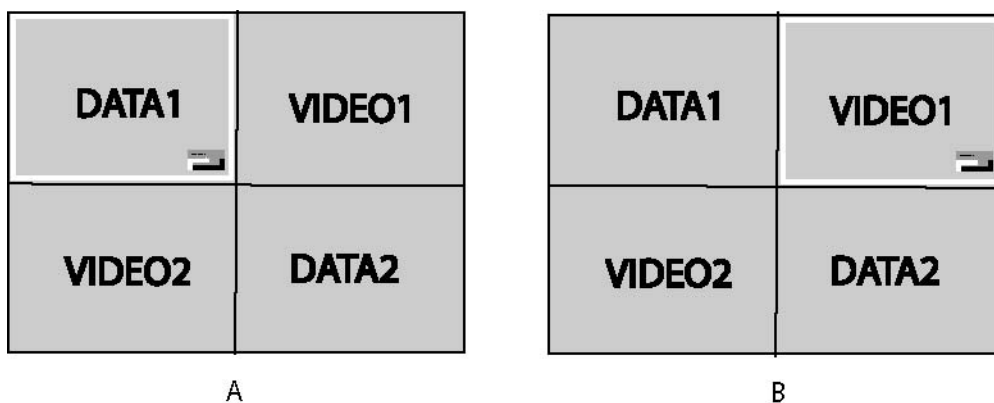

Image 8-15  
PiP adjust in case of 2by2 layout

- A Data1 window has the focus, new settings will only affect Data1 window
- B Video1 window has the focus, new settings will only affect Video1 window

### PiP adjust

1. Press **MENU** to activate the Toolbar

## 8. Tools Menu

---

2. Press → to select the *Tools* item
3. Press ↓ to Pull down the *Tools* menu
4. Use ↑ or ↓ to select *PiP Adjust* (image 8-16)
5. Press **ENTER**  
The menu disappears.  
The focus moves to the next window when pressing **ENTER** (clockwise rotation)  
If you press **BACK** or if you wait 5 seconds the menu is displayed.

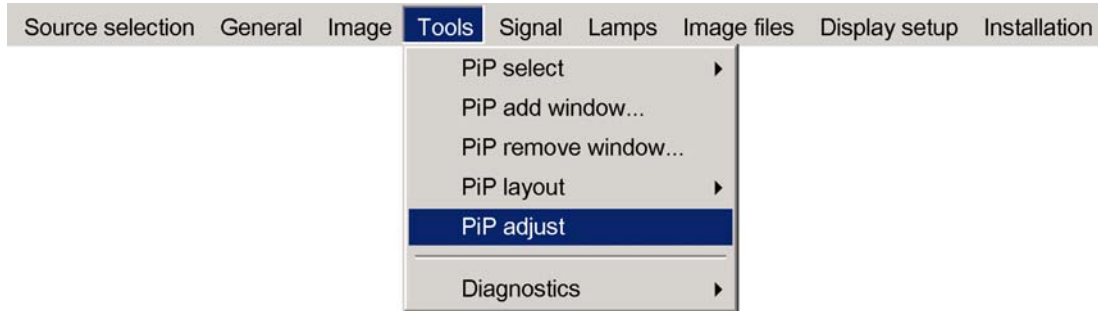

Image 8-16



When using the PiP adjust key on the RCU the corresponding source box is displayed in the bottom right corner.

---

### How to adjust a window in the layout ?

1. Use the PiP Adjust key or function in the menu to choose the window to be adjusted
2. Press **ENTER**  
A wizard bar is displayed in the bottom of the screen  
Follow the procedure.

## 8.7 Diagnostics

---

### What can be done ?

The I<sup>2</sup>C bus allows the diagnostic of different hardware components

### How to display the diagnostics menu ?

1. Press **MENU** to activate the Toolbar
2. Press → to select the *Tools* item
3. Press ↓ to Pull down the *Tools* menu
4. Use ↑ or ↓ to select *Diagnostics*
5. Press → to pull down the menu
6. Press **ENTER** to select I<sup>2</sup>C (image 8-17)  
A textbox is displayed (image 8-18, image 8-19)



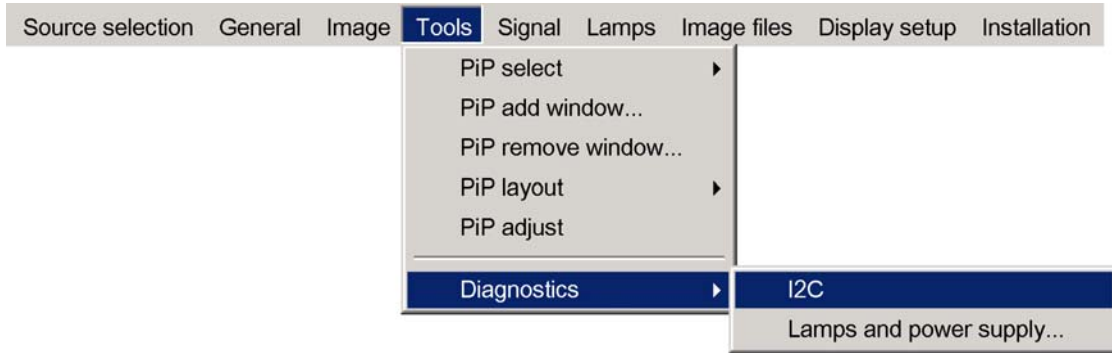

Image 8-17

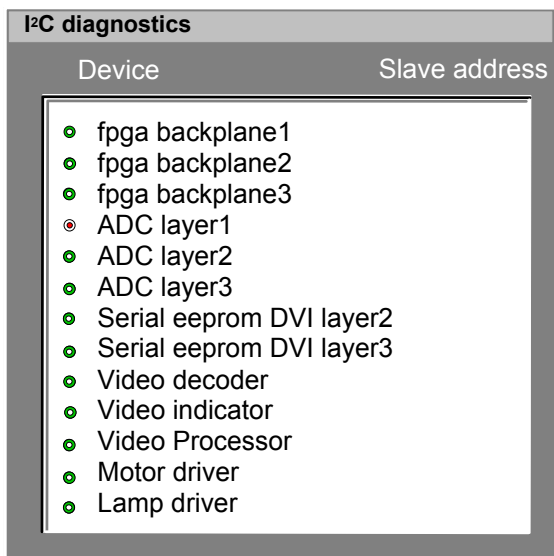

Image 8-18

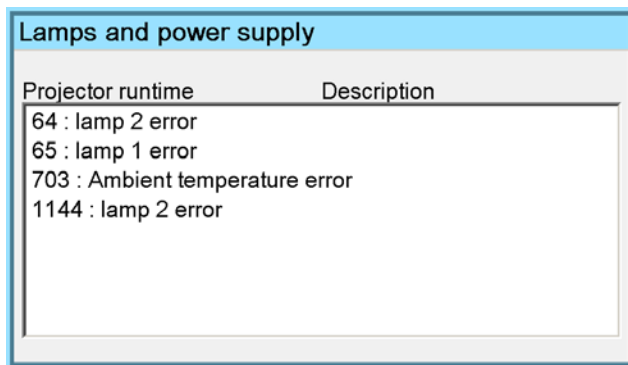

Image 8-19



## 9. SIGNAL MENU

### Overview

- Switching mode
- Background

### 9.1 Switching mode

#### Switching from one source to another

To minimize undesired effects when switching from one source to another, one can use the Seamless switching mode, beside Seamless switching there is a wide choice of several effects which render the source switching transitions more enjoyable.

#### How to select a switching mode ?

1. Press **MENU** to activate the Tool bar
2. Press → to select the *Signal* item
3. Press ↓ to Pull down the *Signal* menu
4. Use ↑ or ↓ to select *Switching mode*
5. Press → to pull down the menu
6. Use ↑ or ↓ to select the desired switching mode (image 9-1)
7. Press **ENTER**

A white bullet shows the active effect.

The next source switching will be done using the selected effect

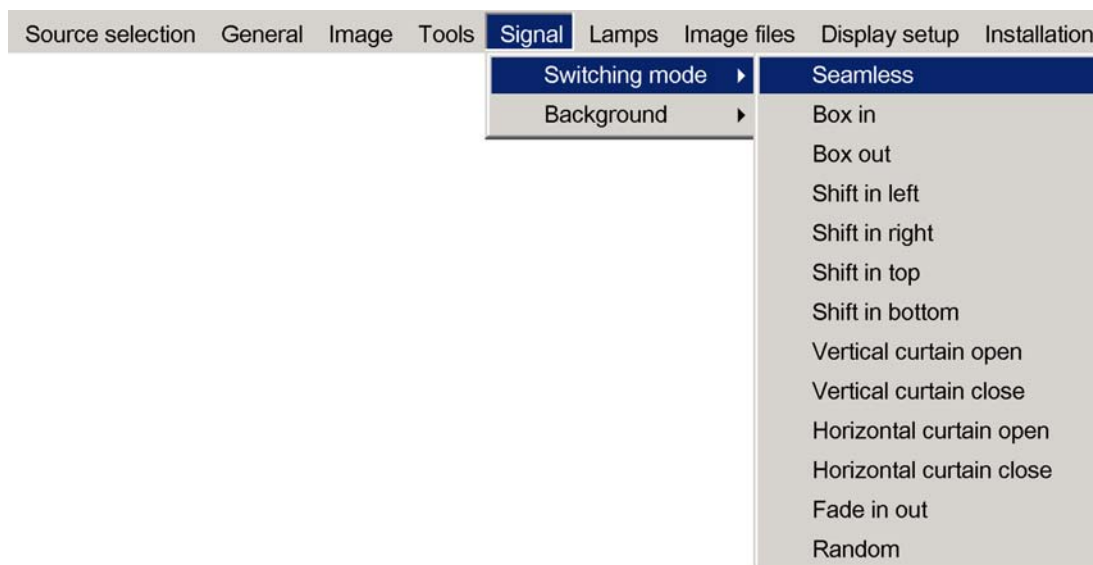

Image 9-1



The *Random* mode will select a new switching mode at each source switching i.e. there will never be 2 successive source switchings with the same effect.

The Seamless switching mode is not used in the *Random* mode.



The switching effects are only possible in the full screen mode



When the source switching mode is the fade in/out mode, the audio (when available) switching will also be done using a fade in/out effect.

---

## 9.2 Background

---

### Purpose

If there is no signal connected to the projector, the background will be a logo, a black or a blue screen depending on the *background* settings.

### How to change the background ?

1. Press **MENU** to activate the Toolbar
2. Press → to select the *Signal* item
3. Press ↓ to Pull down the *Signal* menu
4. Use ↑ or ↓ to select *Background*
5. Press → to pull down the menu
6. Use ↑ or ↓ to select the desired background (image 9-2)
7. Press **ENTER**

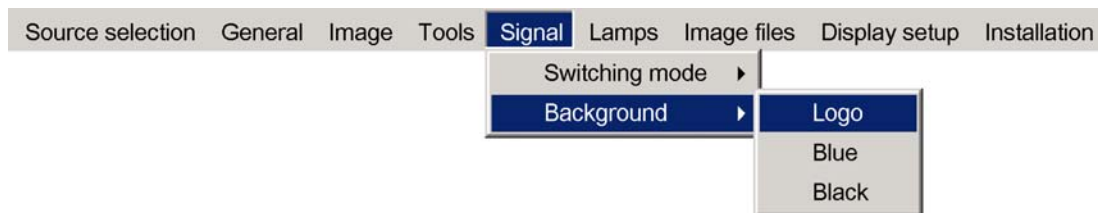

Image 9-2



The logo display is only possible in the full screen mode, a logo can thus not be displayed (rescaled) in a window in the PiP mode.

---



When there is no signal connected, the projector will also start its standby timer countdown (if enabled) and shuts down after the predetermined time.

---

## 10. LAMP MENU

### Overview

- Runtimes
- Mode
- Power mode (only active in the iQG/R 500)
- History
- Reset runtime
- Runtime warning

### 10.1 Runtimes

#### How to display the lamp runtimes ?

1. Press **MENU** to activate the Toolbar
2. Press **→** to select the *Lamp* item
3. Press **↓** to Pull down the *Lamp* menu
4. Use **↑** or **↓** to select *Runtimes* (image 10-1)
5. Press **ENTER**

A textbox is displayed (image 10-2)

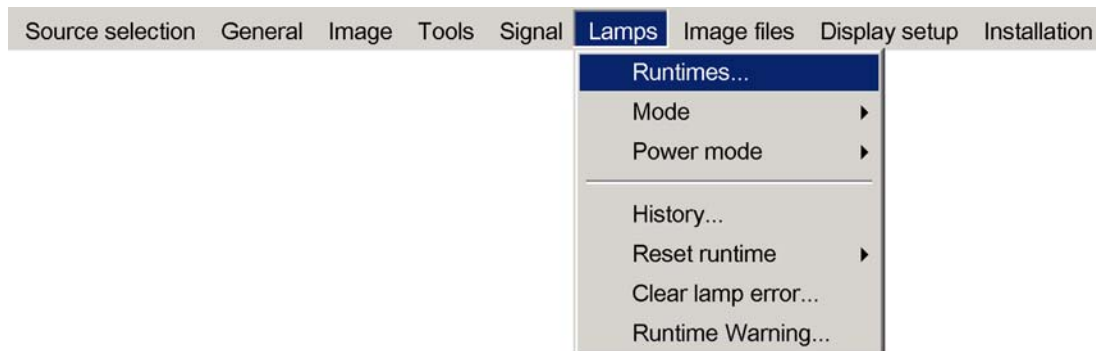

Image 10-1

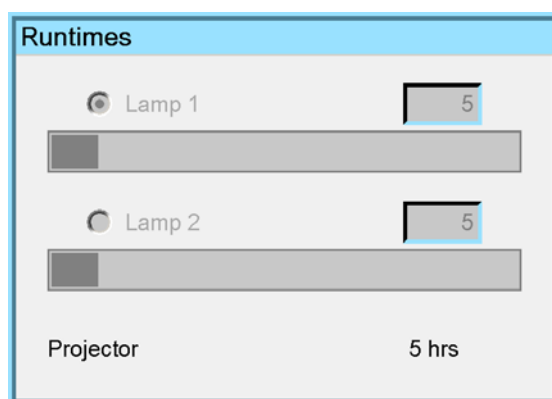

Image 10-2

### 10.2 Mode

#### What are the different lamp modes ?

Single mode

## 10. Lamp Menu

The projector will always switch to the lamp with the shortest runtime when the difference between the runtimes of lamp1 and lamp 2 reaches **100 hours**, switching from one lamp to another happens only at switching on of the projector and not during operation.

When the lamp fails or reaches its maximum runtime the projector switches automatically to the other lamp without interrupting the projection. The failure is logged and the lamp will never be initialized in the future.

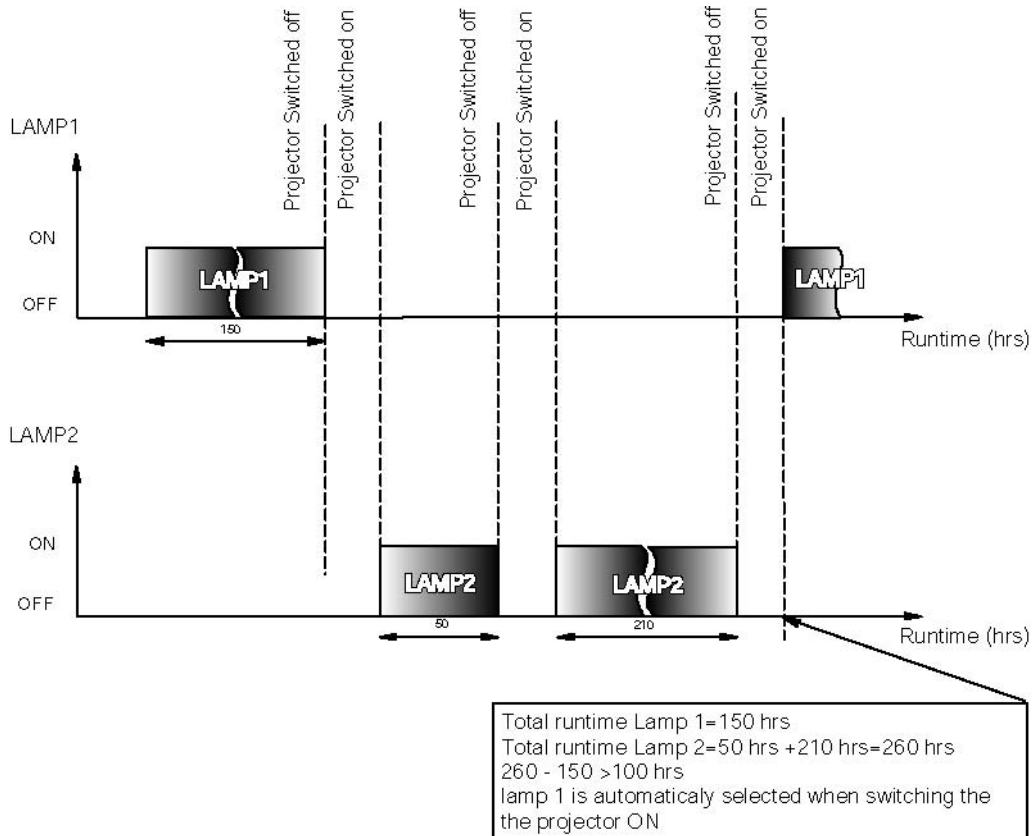

Image 10-3  
Single mode operation: switching principle

### Dual mode

Both lamps are working.

When one lamp fails, the projector continues the projection using the remaining lamp.

### How to select the lamp mode ?

1. Press **MENU** to activate the Toolbar
2. Press **→** to select the *Lamp* item
3. Press **↓** to Pull down the *Lamp* menu
4. Use **↑** or **↓** to select *Mode*
5. Press **→** to pull down the menu
6. Use **↑** or **↓** to select the desired background (image 10-4)
7. Press **ENTER**

A bullet shows the active mode.

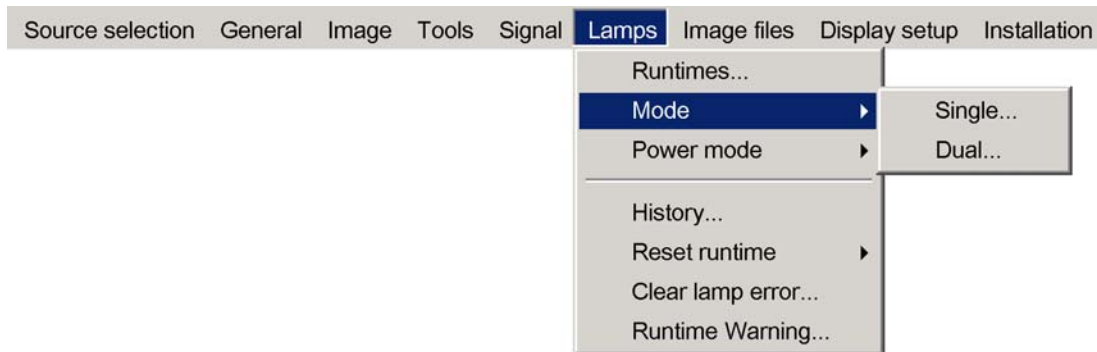

Image 10-4



When switching from the dual mode to the single mode the lamp with the longest runtime is switched off.  
If the runtimes are equal (if the projector has always been operated in dual mode) then lamp1 is switched out.



When switching to single mode, returning to the dual mode will not be possible in the first 60 seconds, *Dual* in the menu is greyed out and LED1 is flickering, thereby preventing hot restrike which may damage the lamp.

### 10.3 Power mode (only active in the iQG/R 500)

#### What can be done ?

The lamp power mode can be chosen to be in :

- Full power mode : the total available power is used for the lamps (maximal brightness). This corresponds with the shortest lamp lifetime (1500 hours)
- Economy mode : the lamps are dimmed, the lifetime is extended to 3000 hours

The choice of the Power mode must be done during the installation of the projector. The switching between the 2 modes can only be done 6 times and this only during the first 100 hours of the lamp lifetime (considering a dual lamp mode i.e. both lamps are used).

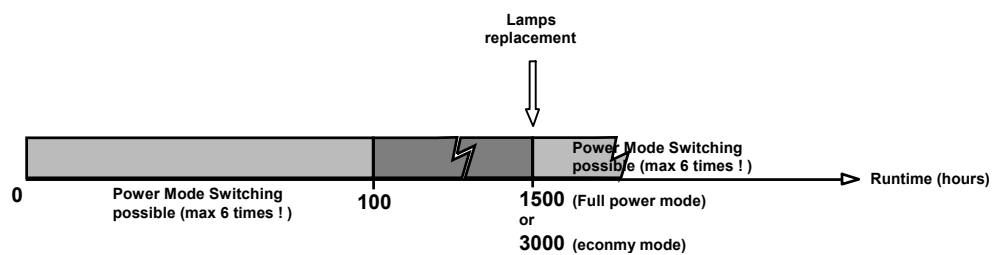

Image 10-5

Lamp power mode (projector considered to be running in dual lamp mode i.e. with both lamps on)



Above considerations and numbers (lifetimes) are only valid when functioning in dual lamp mode (both lamps on)

#### How to select a Power mode ?

1. Press **MENU** to activate the Tool bar
2. Press → to select the *Lamp* item
3. Press ↓ to Pull down the *Lamp* menu
4. Use ↑ or ↓ to select *Power Mode*
5. Press → to pull down the menu
6. Use ↑ or ↓ to select the desired mode (image 10-6)
7. Press **ENTER**

## 10. Lamp Menu

A dialog box is displayed. Confirm or cancel with *Accept* or *Cancel* (image 10-7)

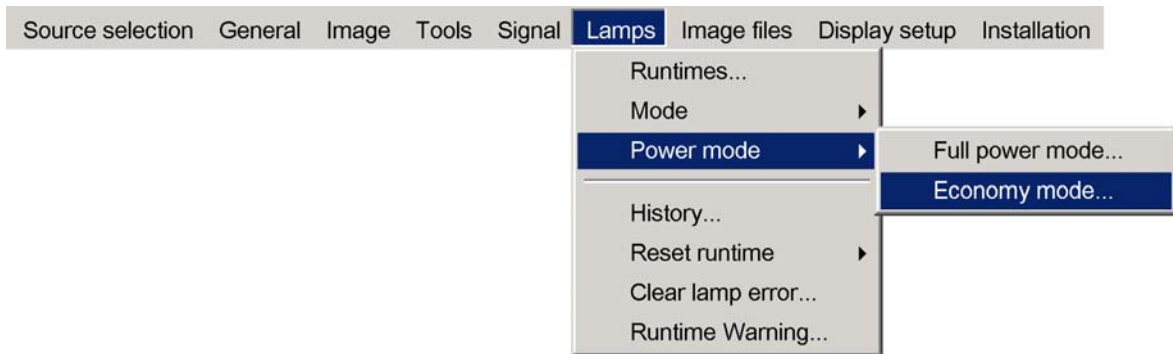

Image 10-6

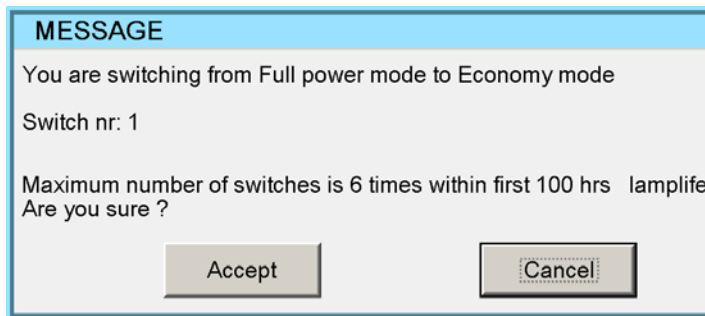

Image 10-7

## 10.4 History

### How to view the history ?

1. Press **MENU** to activate the Tool bar
2. Press → to select the *Lamp* item
3. Press ↓ to Pull down the *Lamp* menu
4. Use ↑ or ↓ to select *History* (image 10-8)
5. Press **ENTER**

A textbox is displayed (image 10-9)

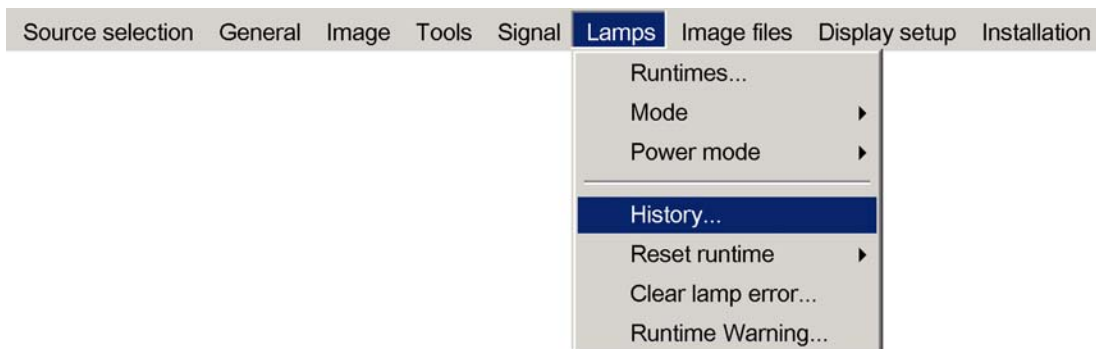

Image 10-8



Lamp history		
Lamp	Serial no.	Runtime
L1	0001230	900
L2	0001222	900
Current lamps		
L1	0001240	900
L2	0001242	900

Image 10-9

## 10.5 Reset runtime

### When to reset the lamp runtime ?

The lamp runtime should only be reset when placing a new lamp.



**WARNING:** Lamp runtime reset as well as the lamp replacement can only be done by a Barco authorized technician.

### How to reset the lamp runtime in the iQ/iD ?

1. Press **MENU** to activate the Tool bar
2. Press **→** to select the *Lamp* item
3. Press **↓** to Pull down the *Lamp* menu
4. Use **↑** or **↓** to select *Reset runtime*
5. Press **→** to pull down the menu
6. Use **↑** or **↓** to select the lamp to be reset (image 10-10)
7. Press **ENTER**  
A dialog box is displayed (image 10-11)
8. Use **←** or **→**, the numeric keys on the remote, or the keypad to change the serial number of the lamp (serial number 0000000 will not be accepted).

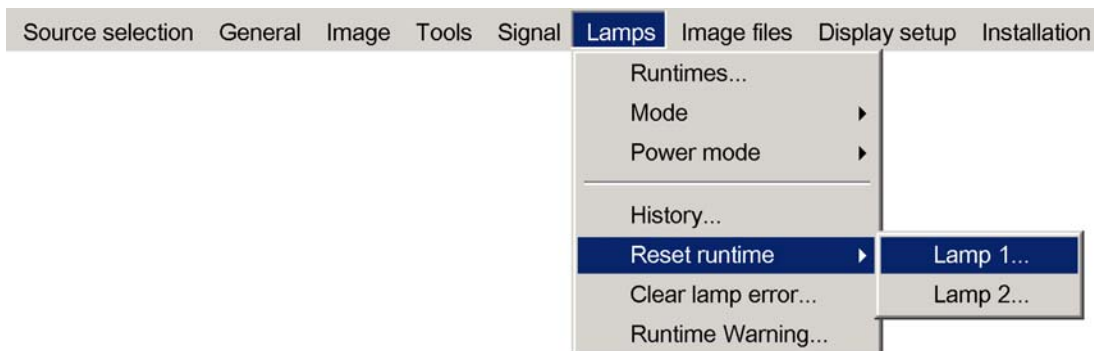

Image 10-10



Image 10-11



**WARNING:** Lamp runtime reset as well as the lamp replacement can only be done by a Barco authorized technician.

---

### How to reset the lamp runtime in the SIM5Plus?

1. Press **MENU** to activate the Tool bar
2. Press **→** to select the *Lamp* item
3. Press **↓** to Pull down the *Lamp* menu
4. Use **↑** or **↓** to select *Reset runtime*
5. Press **→** to pull down the menu
6. Use **↑** or **↓** to select the lamp to be reset
7. Press **ENTER**

A dialog box is displayed (image 10-12)

8. Use **←** or **→**, the numeric keys on the remote, or the keypad to change the serial number of the lamp (serial number 0000000 will not be accepted).

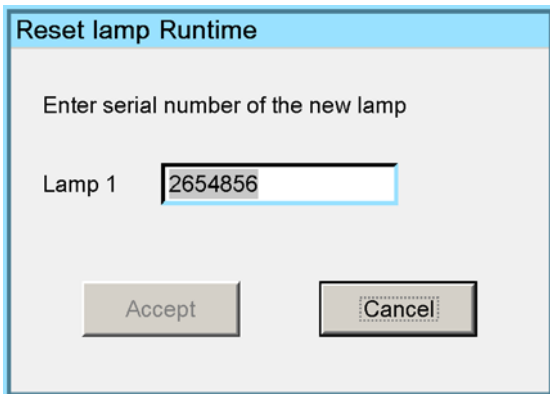

Image 10-12



**WARNING:** Lamp runtime reset as well as the lamp replacement can only be done by a Barco authorized technician.

---

## 10.6 Runtime warning

---

### What can be done ?

When the lamp has reached a certain predetermined runtime , a warning message will be displayed on the screen. The lamp runtime warning can be set in a range from 30 to 200 hours. The runtime warning is displayed by default at 30 hours before end of lamp lifetime.

### How to set the lamp runtime warning?

1. Press **MENU** to activate the Toolbar
2. Press **→** to select the *Lamp* item
3. Press **↓** to Pull down the *Lamp* menu
4. Use **↑** or **↓** to select *Runtime warning* (image 10-13)
5. Press **ENTER**  
A dialogbox is displayed (image 10-14)
6. Use **←** or **→**, the numeric keys on the remote, or the keypad to change the runtime warning setting.

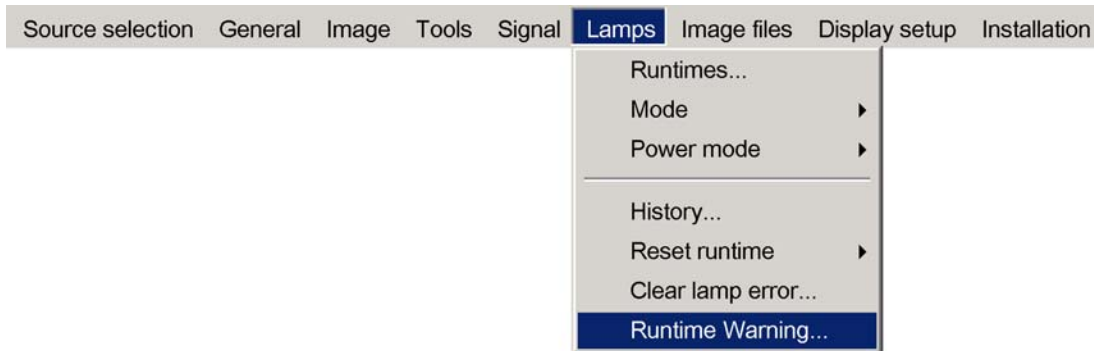

Image 10-13

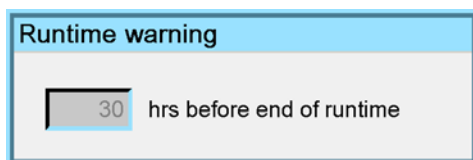

Image 10-14



**WARNING:** Lamp runtime reset as well as the lamp replacement can only be done by a Barco authorized technician.



# 11. IMAGE FILES MENU

## Overview

- Load file
- Auto Image
- Edit file
- Rename file
- Copy
- Delete
- Forced file load

## 11.1 Load file

### How to load a file ?

1. Press **MENU** to activate the Tool bar
2. Press → to select the *Image files* item
3. Press ↓ to Pull down the *Image files* menu
4. Use ↑ or ↓ to select *Load* (image 11-1)
5. Press **ENTER**  
A dialog box is displayed (image 11-2)
6. Use ↑ or ↓ to select the desired file  
*Tip:* For more info about the available image files and the specifications, see "Standard Image Files", page 127
7. Press **ENTER**  
The file is loaded and the image is adapted.

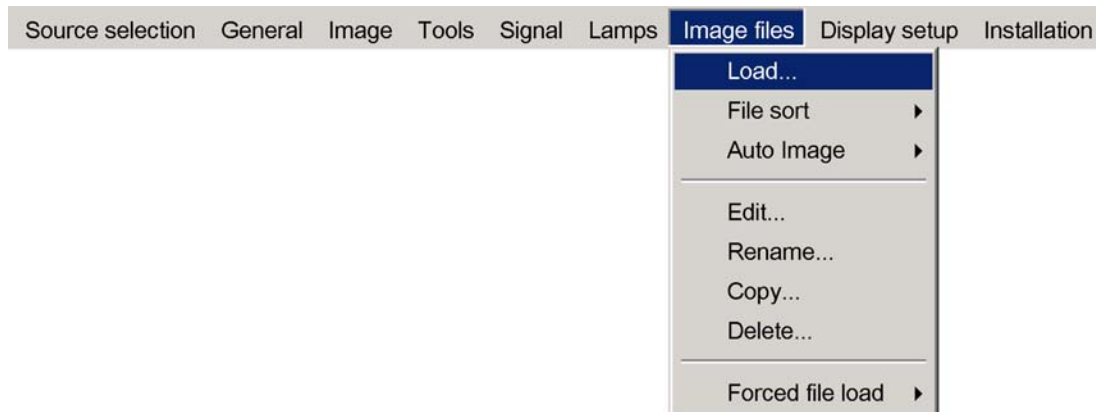

Image 11-1

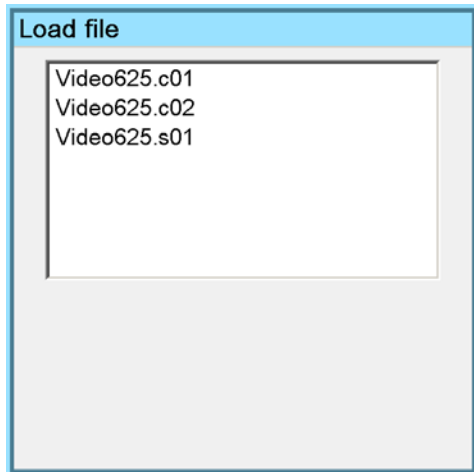

Image 11-2



In PiP mode, the files which may be loaded will be of the data type if the active window is a data window, or they will be of the video type if the active window is a video window.

### What to do if the image is not perfect ?

If the displayed image is not correct after AutoImage or after selecting the best fitting file, go to the Edit menu, select the active file and change the settings.

## 11.2 Auto Image

---

### What can be done ?

Auto Image creates the best suited image file for the connected source.

It calculates/measures several source parameters :

- Total pixels per line
- Start pixel
- Phase
- Contrast/Brightness levels



**Auto Image works only for data images.**

The measure of the total number of pixels per line can be done through 2 methods

- Limited scan: a windowing is used to allow fast tracking.  
The operation takes about 20 seconds (depending on file)
- Full scan: tracking is done over the full range.  
The operation takes about 1.5 minutes (depending on file)

### How to launch Auto Image?

1. Press **MENU** to activate the Tool bar
2. Press → to select the *Image files* item
3. Press ↓ to Pull down the *Image files* menu
4. Use ↑ or ↓ to select *Auto Image*
5. Press → to open the menu
6. Use ↑ or ↓ to select the desired file scan method (image 11-3)
7. Press **ENTER**

A text box showing a progress bar is displayed. (image 11-4)

**Tip:** Press the **Cancel** button to cancel the operation.

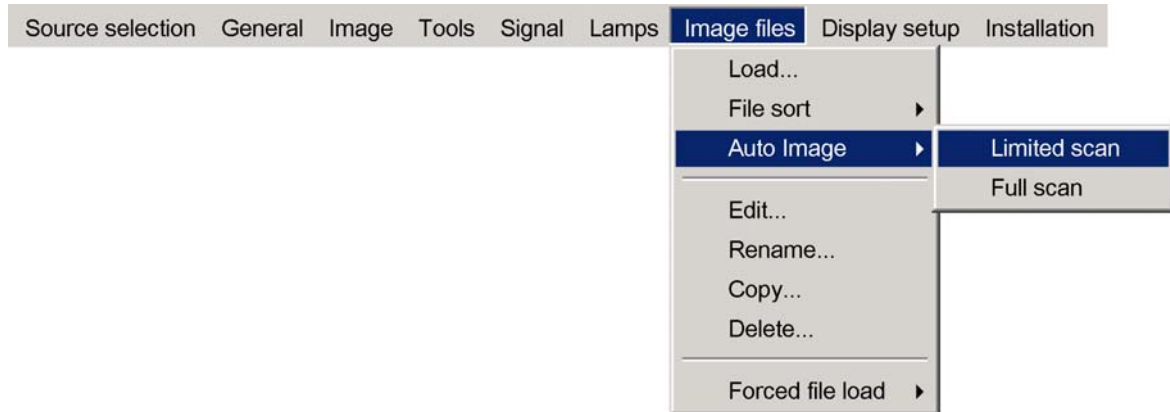

Image 11-3

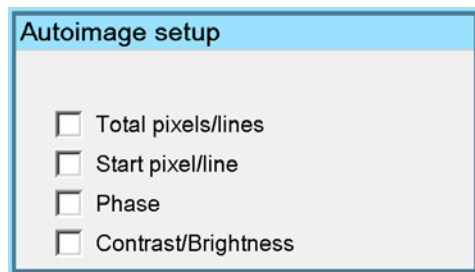

Image 11-4



The Auto Image setup in the *Display setup* menu affect only Auto Image if it is launched via the RCU key or at automatic file creation.

Launching Autolmage via the menu involves complete checking of all parameters.



Auto Image can also be launched via the RCU with the dedicated Autolmage key.

## 11.3 Edit file

### What can be done with the Edit file menu ?

The Edit file menu makes it possible to change the settings of the file according to the real settings of the connected source. Consult the source specifications before entering the data.

### How to edit a file ?

1. Press **MENU** to activate the Tool bar
2. Press → to select the *Image files* item
3. Press ↓ to Pull down the *Image files* menu
4. Use ↑ or ↓ to select *Edit* (image 11-5)
5. Press **ENTER**  
A dialog box is displayed
6. Use ↑ or ↓ to select the desired file  
**Note:** *If in PIP mode the cursor is placed by default on the active file which has the focus.*
7. Press **ENTER**  
A dialog box is displayed (image 11-6)
8. Press **ENTER**

## 11. Image files menu

A dialog box is displayed (image 11-7)

9. Use ← or →, the numeric keys on the remote, or the keypad to edit and change the values, confirm with ENTER  
**Note:** *greyed out fields can not be updated (total pixels)*

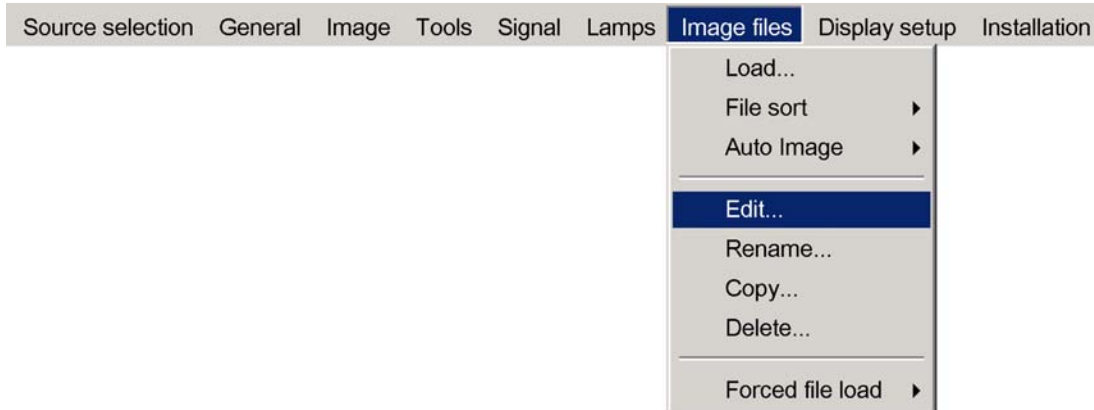

Image 11-5

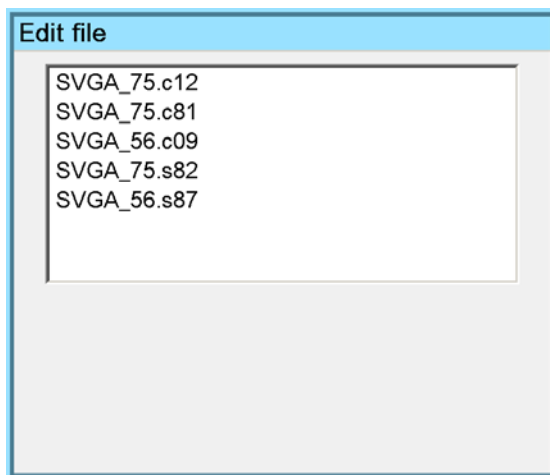

Image 11-6

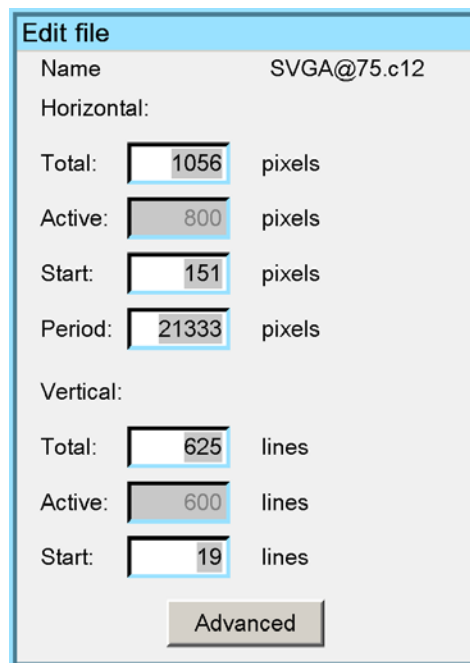

Image 11-7

### Which items can be adjusted ?

The following items can be adjusted :

- Active horizontal pixels
- Horizontal start in pixels
- Horizontal period in ns
- Active vertical lines
- Vertical start in lines



## Advanced video settings

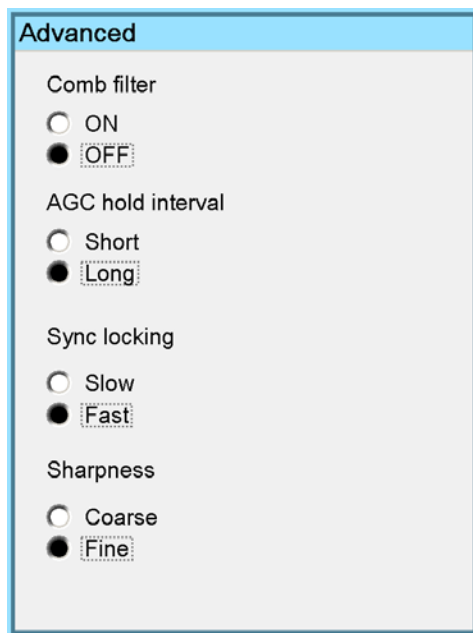

Image 11-8

The **advanced** button enables the advanced settings for a video source.

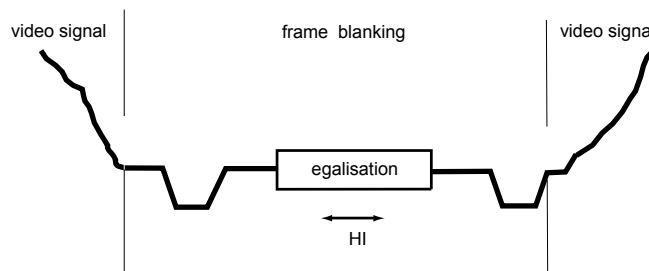

Image 11-9

HI AGC Hold interval

The **Comb filter** is by default enabled.

The **AGC hold interval** is the time interval in which the AGC is inhibited (AGC hold = no update in video amplitude measurement), the advanced parameter allows to choose a short or long hold interval.

A long AGC hold interval eliminates Macrovision® disturbances since the AGC is hold during a long interval, thus reducing the probability to encounter a Macrovision® pulse.

The **sync locking setting** is recommended for poor video signals (ex: poor TV signals).

**Sharpness** adjustment can be chosen to be coarse or fine.



**It is recommended to use the default values.**

## Advanced Data settings

The **advanced** button enables the advanced settings for a data source.

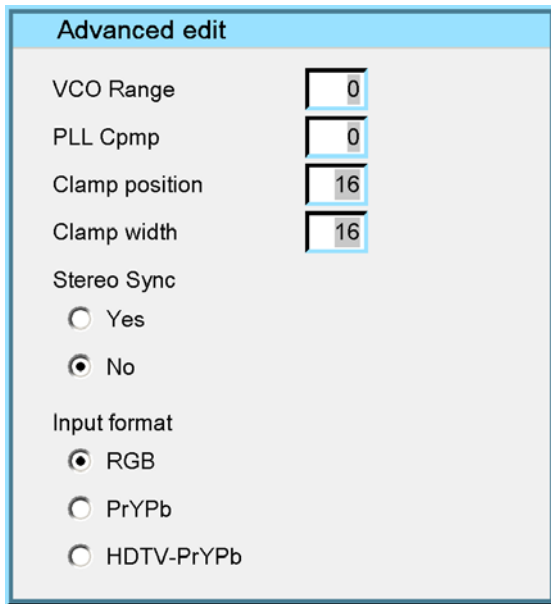

Image 11-10

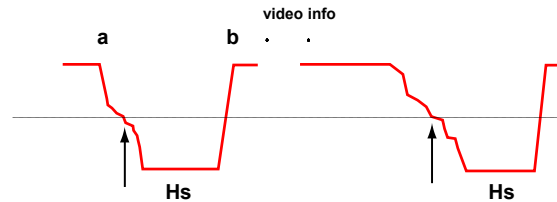

Image 11-11  
 Hs horizontal sync pulse  
 a active low  
 b active high

The **VCO range** setting determines the frequency range of the VCO (Voltage Controlled Oscillator).

The **Cmpm** (Charge pump current) sets the low pass filter current.

Both VCO range & Cmpm are set by the image file, changing these settings is only indicated in for special purposes.

The **horizontal sync polarity** setting can be useful in case of a bad shaped edge, one can choose between the leading (active low) or trailing (active high) edge.

The input format settings are used to "tell more" about the signals connected on the BNC's, it completes the information in the source selection menu.

- RGB is selected by default and means that an RGB signal is connected to the BNC's
- PR/Y/PB must be selected whenever:
  - a progressive signal (32 kHz frequency video signal ) is connected to the BNC's (select the source with *Data on BNC's* in the Source selection menu).
  - one wants (in PIP mode) to visualize the component video signal in a Data window hereby adding a video image in the PIP layout.
- HDTV-PR/Y/PB for high definition component video signals.



**It is recommended to use the default values.**

## 11.4 Rename file

### How to rename a file ?

1. Press **MENU** to activate the Tool bar
2. Press → to select the *Image files* item
3. Press ↓ to Pull down the *Image files* menu
4. Use ↑ or ↓ to select *Rename* (image 11-12)
5. Press **ENTER**  
 A dialog box is displayed (image 11-13)
6. Use ↑ or ↓ to select the desired file
7. Press **ENTER**  
 A text box is displayed (image 11-14)  
 Use ←or →, ↓ or ↑ the numeric keys on the remote, or the keypad to edit and change the values, confirm with ENTER.

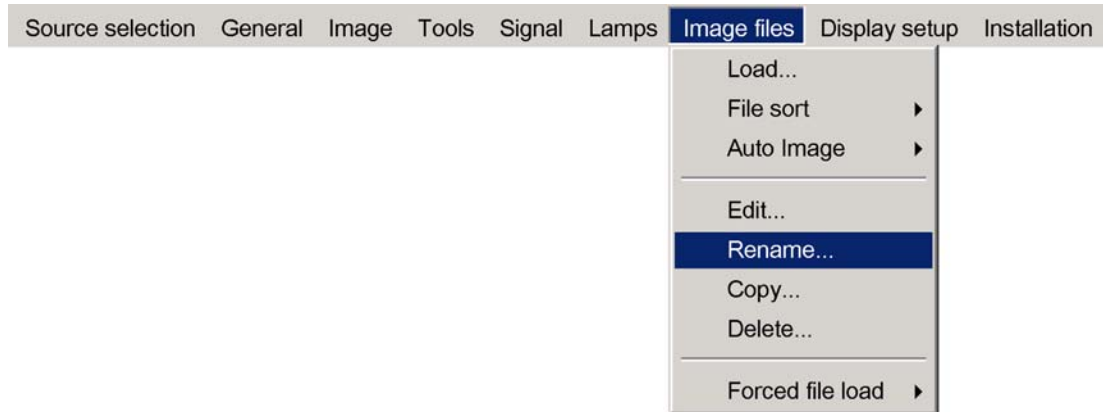

Image 11-12

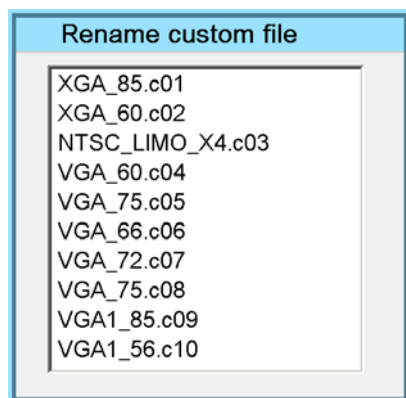

Image 11-13

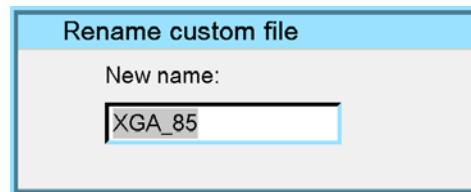

Image 11-14

## 11.5 Copy

### How to copy a file ?

1. Press **MENU** to activate the Tool bar
2. Press → to select the *Image files* item
3. Press ↓ to Pull down the *Image files* menu
4. Use ↑ or ↓ to select *copy* (image 11-15)
5. Press **ENTER**  
A dialogbox is displayed (image 11-16)
6. Use ↑ or ↓ to select the desired file
7. Press **ENTER**  
A text box is displayed (image 11-17)  
Use ← or →, ↓ or ↑ on the remote, or the keypad to enter the new name, confirm with **ENTER**.

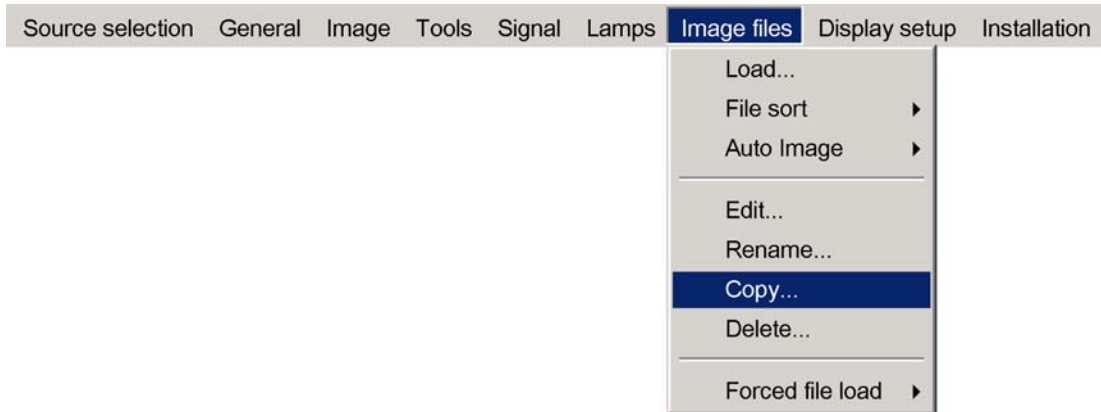

Image 11-15

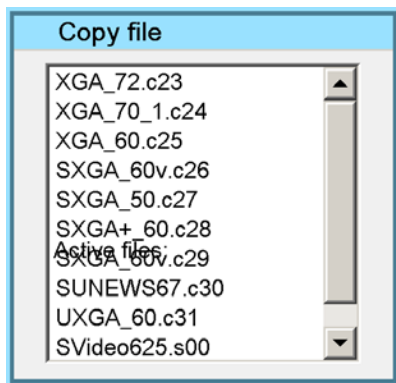

Image 11-16

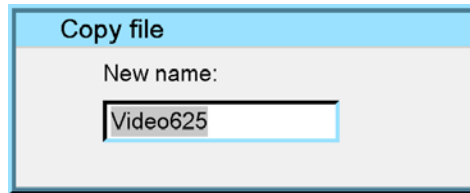

Image 11-17



If the AutoImage function does not succeed in finding a file and no file is loaded (load list is empty), which means that the source is not displayed, then use the copy function: Copy a standard file (.std) which is not too different of the source to display, then edit this file to get the best image.

## 11.6 Delete

### How to delete a file ?

1. Press **MENU** to activate the Tool bar
2. Press → to select the *Image files* item
3. Press ↓ to Pull down the *Image files* menu
4. Use ↑ or ↓ to select *delete* (image 11-18)
5. Press **ENTER**  
A dialog box is displayed (image 11-19)
6. Use ↑ or ↓ to select the desired file
7. Press **ENTER**  
The selected file is deleted and is removed from the list

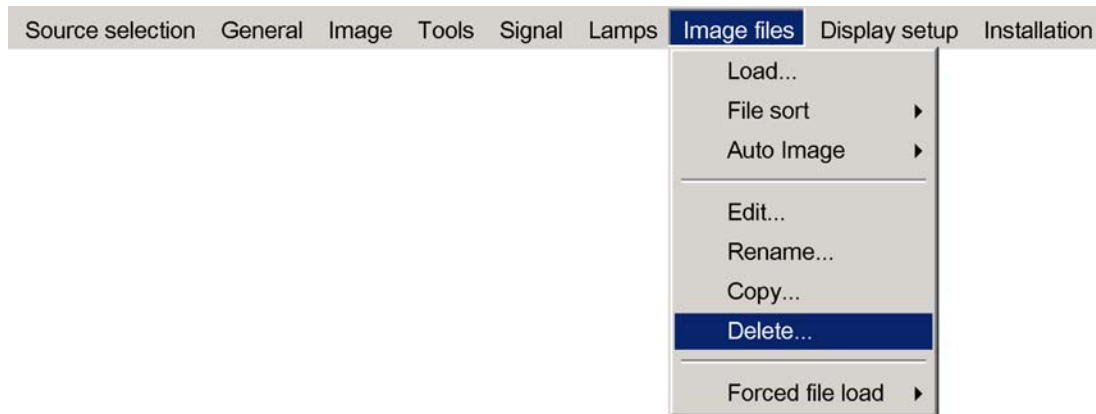

Image 11-18

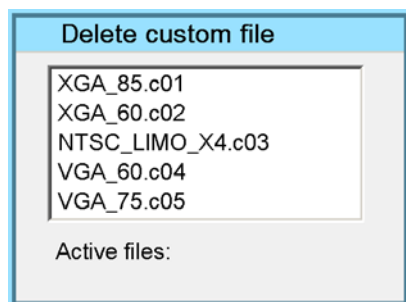

Image 11-19

## 11.7 Forced file load

### What can be done ?

Forced file load allows to force or lock one particular custom file to be loaded for one particular input. This way one can guarantee that the same desired file is always used for a particular source.

For each layer (layer 1, layer 2, layer 3) we can enable or disable the forced file load. The specification for the file to be selected for each input on that layer is done via RS232.



see the **RS232 User Guide** for more information on the **Forced file load** command to be sent.

### How to set a file to be loaded ?

1. Press **MENU** to activate the Tool bar
2. Press → to select the *Image files* item
3. Press ↓ to Pull down the *Image files* menu
4. Use ↑ or ↓ to select *Forced file load*
5. Press → to open the menu (image 11-20)
6. Use ↑ or ↓ to select the desired layer
7. Press **ENTER**

Forced file load is activated for this layer (this is shown with a bullet)

11. Image files menu

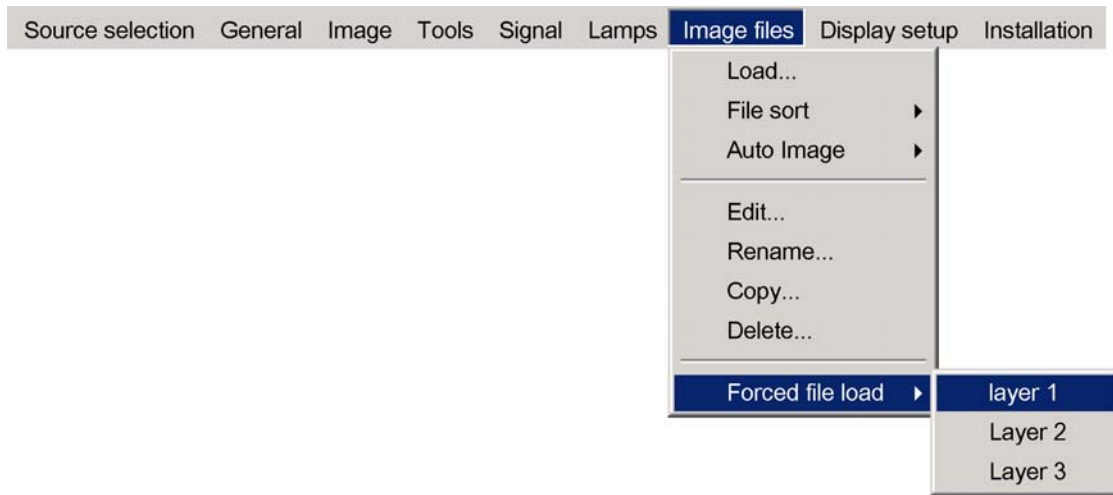

Image 11-20

## 12. DISPLAY SETUP

### Overview

- Full screen representation
- Startup screen
- Textbox
- Take screenshot
- Menu bar position
- Status bar position
- Sliderbox position
- AutoImage Setup
- Blanking

### 12.1 Full screen representation

#### Purpose of the Full screen representation

The *Full screen representation* function forces to use the complete native resolution of the LCD panels independently of the native resolution of the source.

Note that the full screen representation does not preserve the aspect ratio of the source, i.e. when the aspect ratio of the active image is not the same as the projector (in this case 1920/1080 or 1.77:1), the image will end to be distorted (stretched or shrunk).

#### How to enable/disable the full screen representation ?

1. Press **MENU** to activate the Tool bar
2. Press → to select the *Display setup* item
3. Press ↓ to Pull down the Display setup menu
4. Use ↑ or ↓ to select *Full screen representation*
5. Press → to pull down the menu
6. Use ↓ or ↑ to select ON or OFF
7. Press **ENTER**



The full screen representation will not guarantee the best image quality, therefore the *Show native resolution* has to be selected.

The *show native resolution* function on the other hand forces to use the native resolution of the source.

The *Full screen representation* function overrules the *show native resolution* function.



The aspect ratio setting is greyed out when enabling the full screen representation.

### 12.2 Startup screen

#### What can be done ?

When the startup screen is enabled, the identification screen is displayed for a few seconds at startup. This startup screen can also be disabled.

Identification	
Type	iDR500
Address	2
Software	01.02
RS232 baudrate	115200
Serial number	6001758

Image 12-1

### How to enable/disable the Startup screen?

1. Press **MENU** to activate the Tool bar
2. Press → to select the *Display setup* item
3. Press ↓ to Pull down the *Display setup* menu
4. Use ↑ or ↓ to select *Startup screen*
5. Press → to pull down the menu
6. Use ↓ or ↑ to select the ON or OFF
7. Press **ENTER**

## 12.3 Textbox

---

### What can be done ?

The textbox function allows to display or not the different sliderboxes used for instance for picture settings (contrast,...), it also affects the source information windows (displayed in the right lower corner of the screen).

### How to enable/disable the Textbox ?

1. Press **MENU** to activate the Toolbar
2. Press → to select the *Display setup* item
3. Press ↓ to Pull down the *Display setup* menu
4. Use ↑ or ↓ to select *Textbox*
5. Press → to pull down the menu
6. Use ↓ or ↑ to enable/disable the textbox
7. Press **ENTER**

## 12.4 Take screenshot

---

### What can be done ?

A screenshot can be taken from an active projected image. This screenshot is then saved in a 4 MB RAM and can be used as background.

Each new screenshot erases the previous logo therefore a warning message is displayed asking the user to confirm.





Image 12-2  
Default (factory stored) Logo

### How to take a screenshot ?

1. Press **MENU** to activate the Tool bar
2. Press **→** to select the *Display setup* item
3. Press **↓** to Pull down the *Display setup* menu
4. Use **↑** or **↓** to select *Take screenshot* (image 12-3)
5. Press **ENTER**

A dialog box is displayed. Press **yes** to confirm. (image 12-4)

A text box shows the evolution of the operation. (image 12-5, image 12-6)

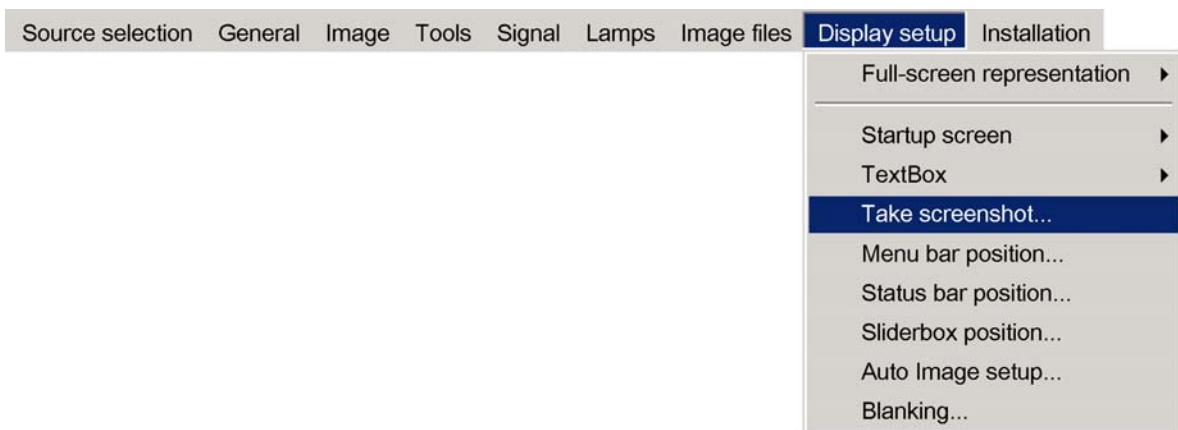

Image 12-3

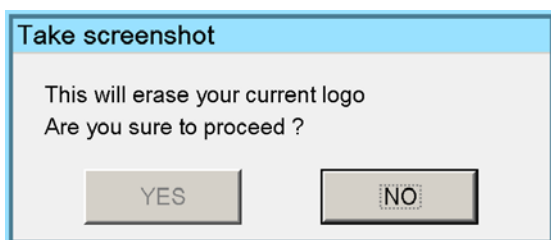

Image 12-4

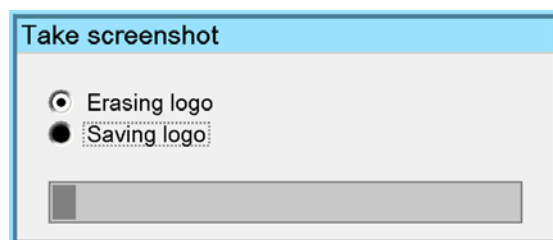

Image 12-5

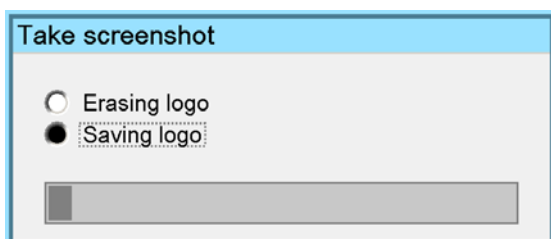

Image 12-6

---

## 12.5 Menu bar position

---

### What can be done ?

The menu toolbar can be centered vertically , the range being from top of the screen to the middle of the screen. This can be useful in applications where the top image content is not displayed.

### How to center the menu ?

1. Press **MENU** to activate the Toolbar
2. Press → to select the *Display setup* item
3. Press ↓ to Pull down the *Display setup* menu
4. Use ↑ or ↓ to select *Menu bar position menu* (image 12-7)
5. Press **ENTER**
6. Use ↑ or ↓ to position the menu toolbar

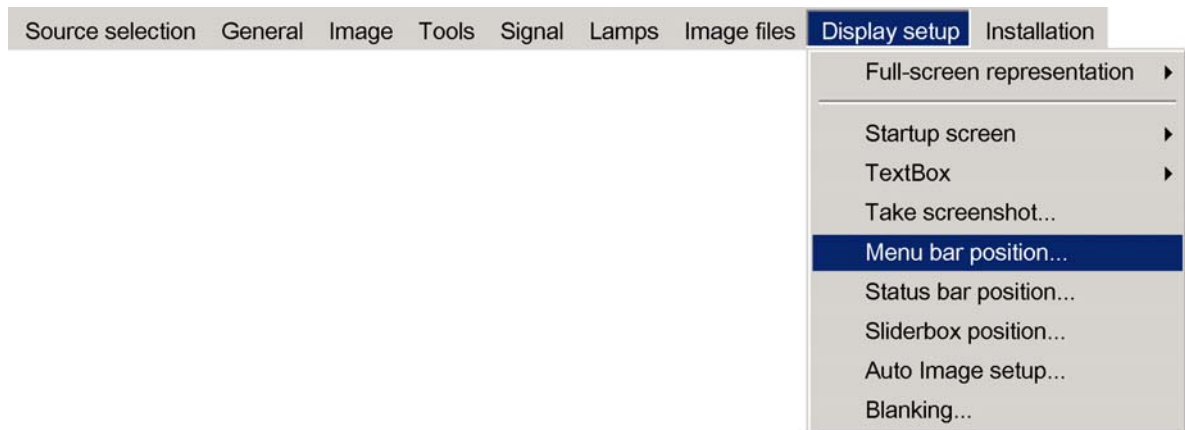

Image 12-7

---

## 12.6 Status bar position

---

### What can be done ?

The status bar (wizard menu) can be centered vertically , the range being from bottom of the screen to the middle of the screen. This can be useful in applications where the bottom image content is not displayed.

### How to center the menu ?

1. Press **MENU** to activate the Toolbar
2. Press → to select the *Display setup* item
3. Press ↓ to Pull down the *Display setup* menu
4. Use ↑ or ↓ to select *Status bar position* (image 12-8)
5. Press **ENTER**
6. Use ↑ or ↓ to position the status bar

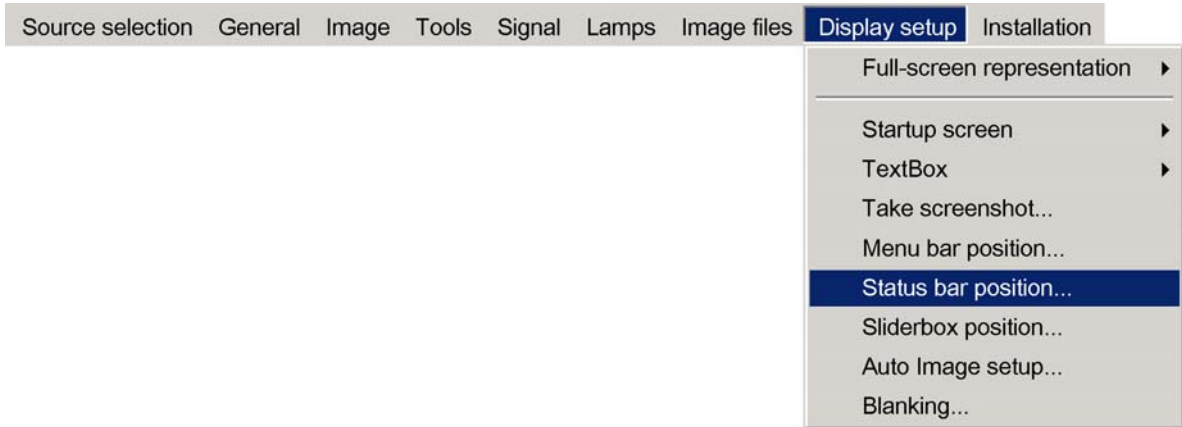

Image 12-8

## 12.7 Sliderbox position

### What can be done ?

The sliderbox can be displayed anywhere on the screen, the position can be set in this menu.

### How to reposition the sliderbox?

1. Press **MENU** to activate the Tool bar
2. Press → to select the *Display setup* item
3. Press ↓ to Pull down the *Display setup* menu
4. Use ↑ or ↓ to select *Sliderbox position* (image 12-9)
5. Press **ENTER**

A sliderbox is displayed. Use the 4 arrow keys to drag the box to the desired position. (image 12-10)

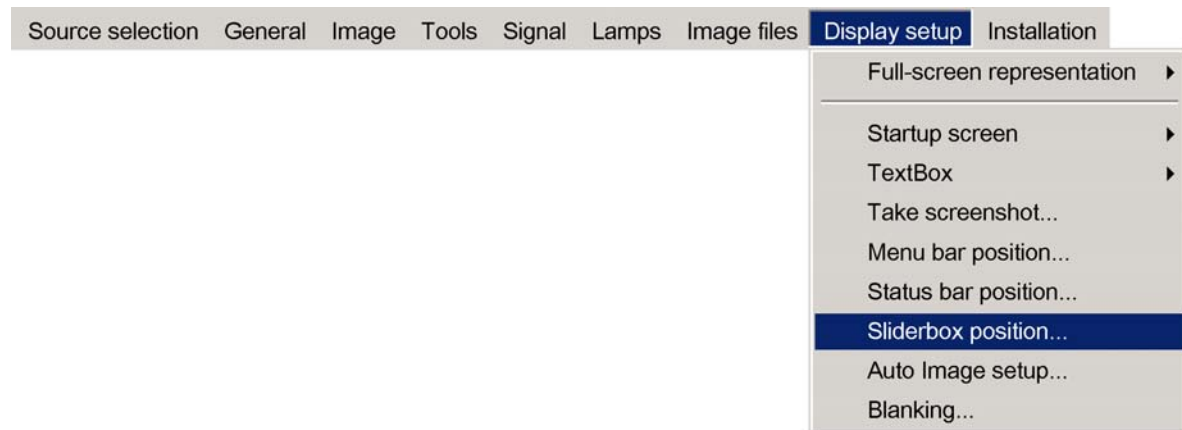

Image 12-9

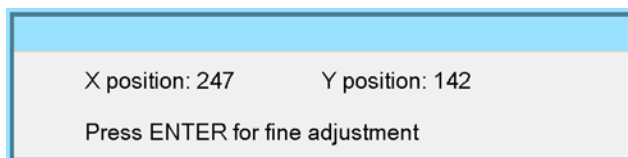

Image 12-10



**There is a coarse and a fine adjustment of the position, use ENTER (when sliderbox is displayed) to switch between the two.**

## 12.8 AutoImage Setup

### What can be done ?

Autoimage allows to detect automatically the characteristics of the source (total pixels per line,...) and uses this information to adapt the image to the LCD panels.

Autoimage can adapt the image based on following data :

- Total pixels per line
- Start pixel
- Phase
- Contrast/brightness levels



**Autoimage works only for data signals.**

### How to set up AutoImage?

1. Press **MENU** to activate the Tool bar
2. Press **→** to select the *Display setup* item
3. Press **↓** to Pull down the *Display setup* menu
4. Use **↑** or **↓** to select *AutoImage setup* (image 12-11)
5. Press **ENTER**  
A dialog box is displayed.  
(image 12-12)
6. Use the arrow keys to select the desired item and press **ENTER** to activate or deactivate the item.

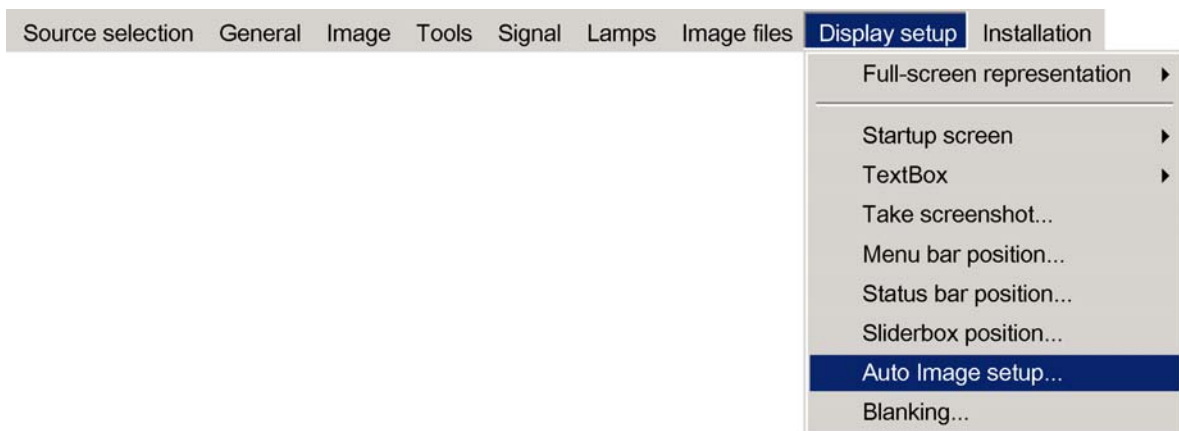

Image 12-11

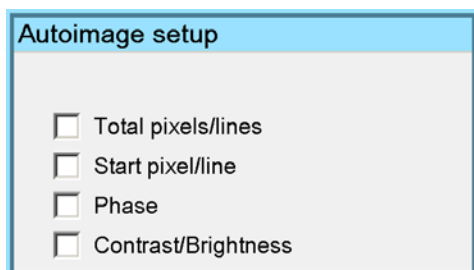

Image 12-12

### How to perform AutoImage ?

1. Press **AutoImage** on the RCU  
A textbox showing a progress bar is displayed.



During the AUTOIMAGE measuring process the data source disappears temporarily (logo is displayed if background is set to logo )

## 12.9 Blanking

### What can be done ?

The image can be blanked in several ways :

- Top blanking
- Bottom blanking
- Left blanking
- Right blanking

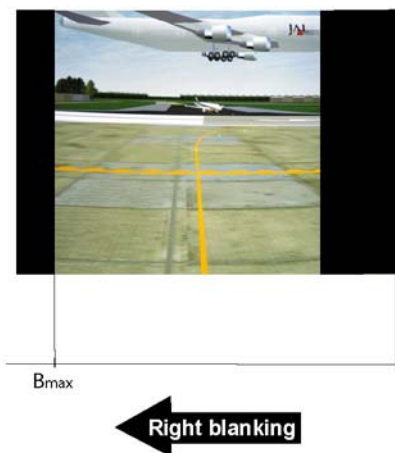
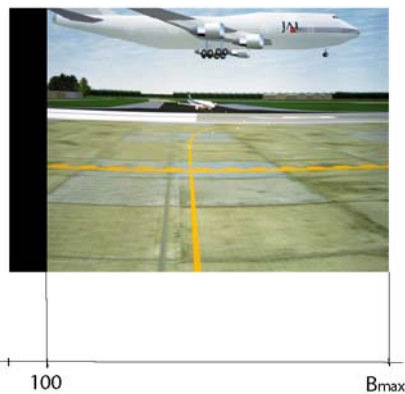

Image 12-13



Note that here the blanking is only done on the display i.e. the setting is not saved in the image file. in other words only one type of blanking (setting) can be done independently of the source.

### How to blank the image ?

1. Press **MENU** to activate the Toolbar
2. Press **→** to select the *Display setup* item
3. Press **↓** to Pull down the menu
4. Use **↑** or **↓** to select *Blanking* (image 12-14)
5. Press **ENTER**
  - A slider box is displayed (image 12-15)
6. Use **←** or **→**, the numeric keys on the remote, or the keypad to change the blanking.

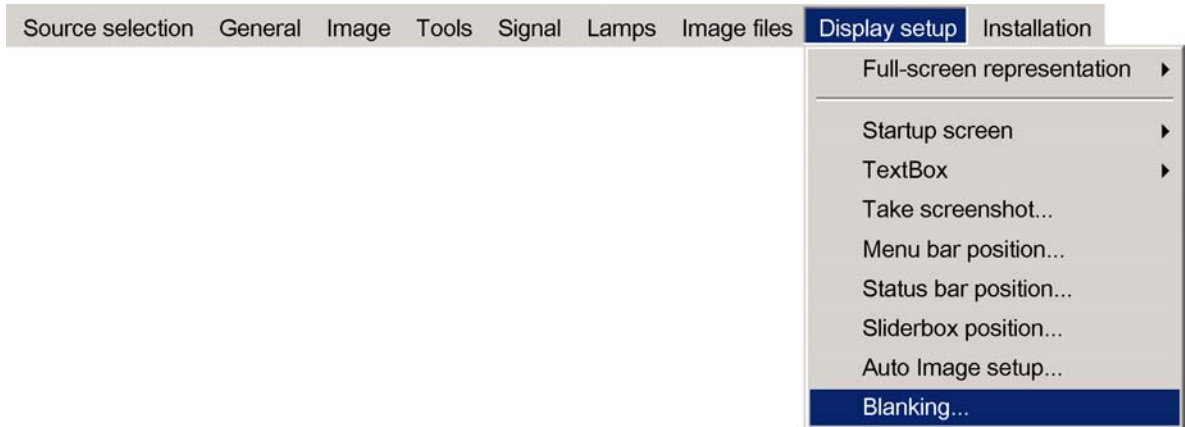

Image 12-14

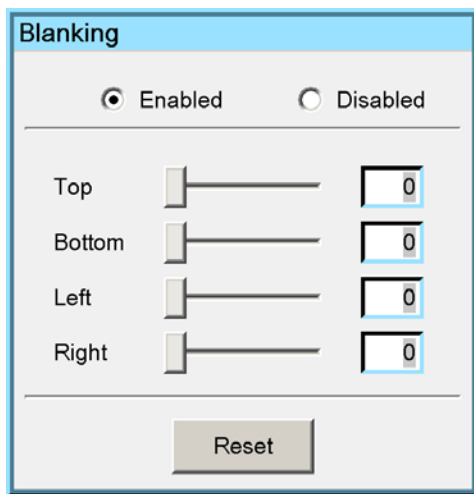

Image 12-15



**Use the checkboxes to enable/disable the blanking**  
**Use the Reset key to reset the blanking values.**



**The logo is also affected by the blanking**

# 13. INSTALLATION MENU

## Overview

- Lens adjustments
- Projector address
- Orientation
- Language
- Quick access keys
- RS232 baudrate
- Automatic startup
- Security
- Change password
- Gemini installed (only for GEMINI CADWALL systems ! )

## 13.1 Lens adjustments

### What can be done ?

Motorized lenses can be adjusted in the installation menu or via the dedicated keys on the remote.

The following parameters can be adjusted:

- Zoom
- Focus
- Shift (also for non motorized lenses)

### How to Zoom/focus or shift ?

1. Press **MENU** to activate the Toolbar
2. Press → to select the *Installation*
3. Press ↓ to Pull down the *Installation* menu
4. Use ↑ or ↓ to select *Lens adjustment* (image 13-1)
5. Press **ENTER**

A textbox appears on the screen, follow the instructions. (image 13-2, image 13-3)

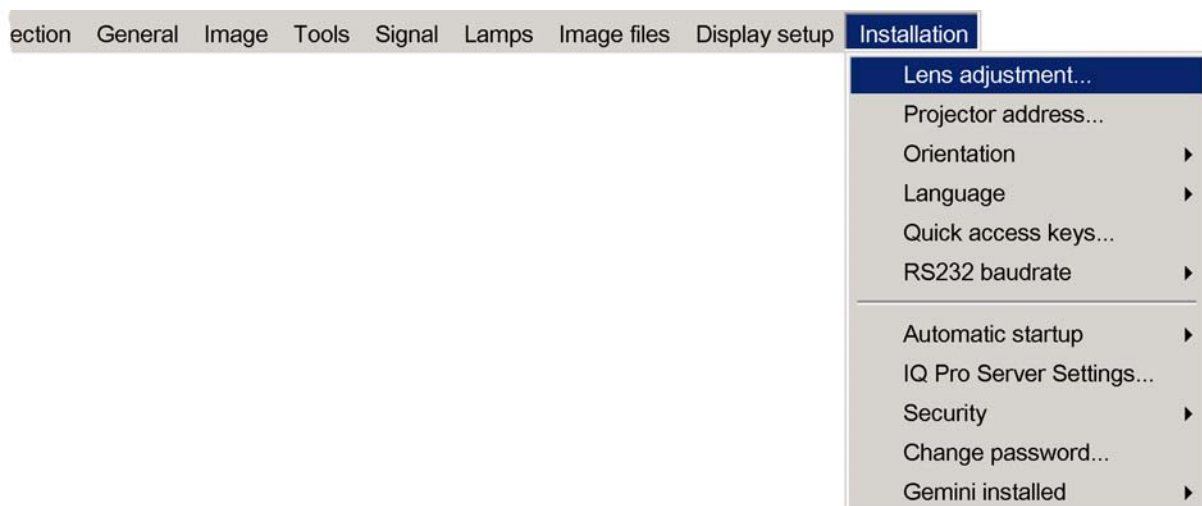

Image 13-1

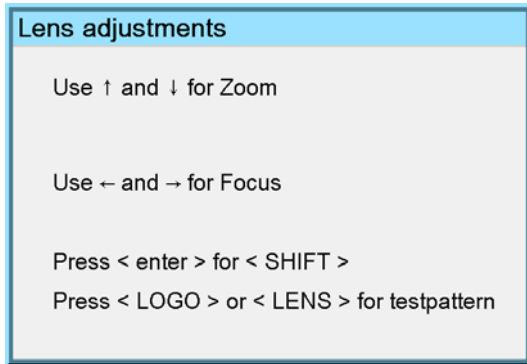

Image 13-2

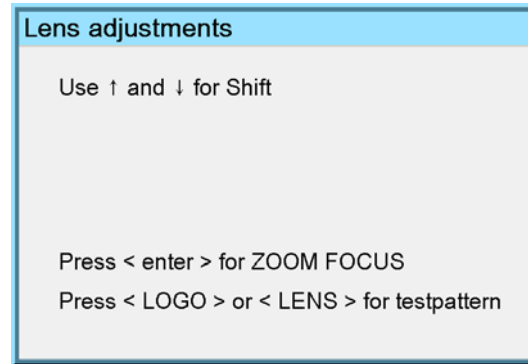

Image 13-3

## 13.2 Projector address

### What can be done ?

The projector is shipped with projector address set to "0"

In some cases the projector address must be changed, for example if an unique RCU is used to control 2 or more projectors (independently).

In the OSD menu *Projector Address*, the following addresses can be programmed :

- Projector address: address defined by the user, may be from 0 to 255  
0-9 is used for RCU communication, 0-255 being used for RS232 serial communication.
- Common address : address may be 0 or 1

### How to change the projector's RC5 address ?

1. Press **MENU** to activate the Tool bar
2. Press → to select the *Installation*
3. Press ↓ to Pull down the *Installation* menu
4. Use ↑ or ↓ to select *Projector address* (image 13-4)
5. Press **ENTER**

A dialog box appears on the screen. (image 13-5, image 13-6)

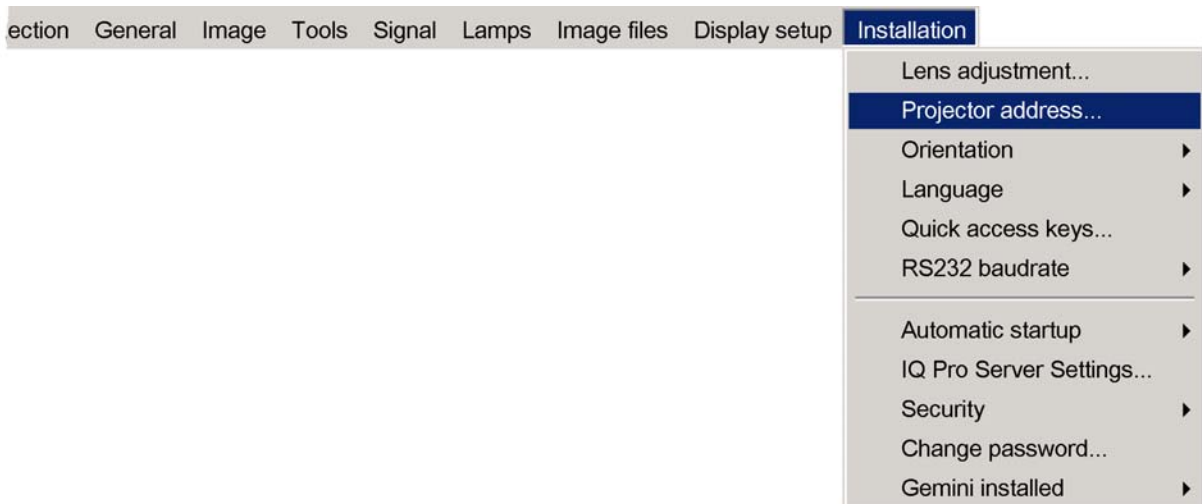

Image 13-4



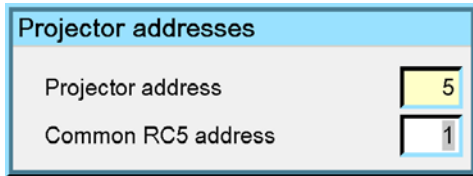

Image 13-5

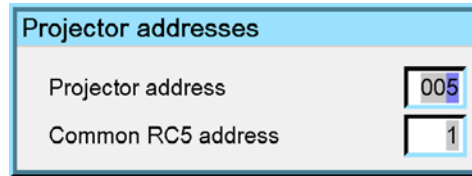

Image 13-6

### Entering the new projector address ?

1. Enter the new projector address with the digit keys on the RCU, the local keypad or the cursor keys.



This address must be between 0 and 255.

### How to change the common RC5 address ?

1. Press **MENU** to activate the Tool bar
2. Press → to select the *Installation*
3. Press ↓ to Pull down the *Installation* menu
4. Use ↑ or ↓ to select *Projector address*
5. Press **ENTER**

A dialog box appears on the screen.

### Entering the new common address ?

1. Enter the new projector address with the digit keys on the RCU, the local keypad or the cursor keys.



This address must be between 0 or 1.

## 13.3 Orientation

### Projector orientations

Depending on how the projector is oriented, the projector's internal settings have to be adapted.

### How to change the orientation ?

1. Press **MENU** to activate the Toolbar
2. Press → to select the *Installation* item
3. Press ↓ to Pull down the *Installation* menu
4. Use ↑ or ↓ to select *Orientation*
5. Press → to pull down the menu
6. Use ↓ or ↑ to select the desired orientation (image 13-7)
7. Press **ENTER**

The projection is adapted and a black bullet shows the active configuration.

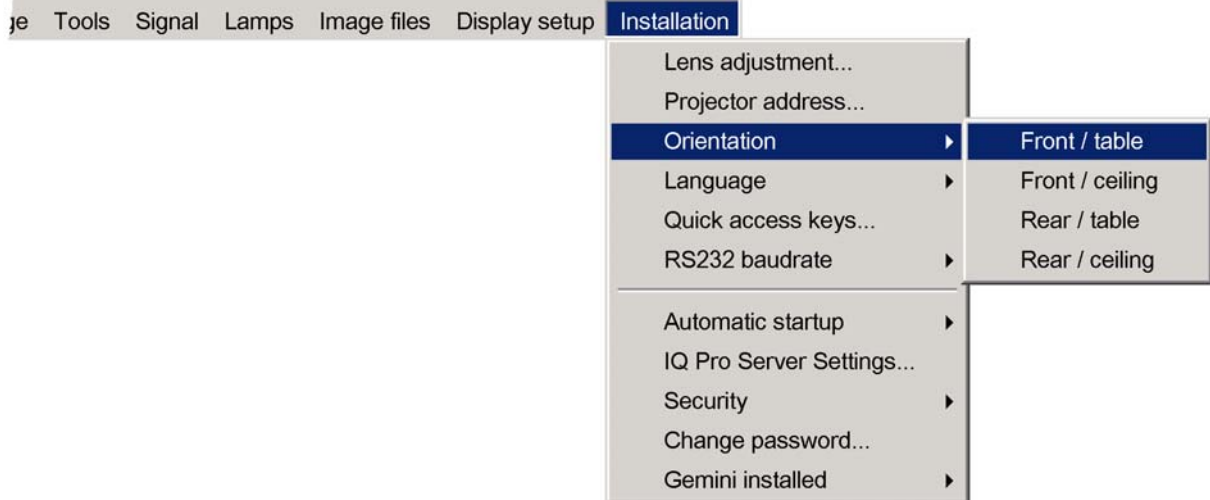

Image 13-7

## 13.4 Language

### List of languages

The list of selectable languages is depending on the software of the projector.

### How to change the Language ?

1. Press **MENU** to activate the Tool bar
2. Press → to select the *Installation* item
3. Press ↓ to Pull down the *Installation* menu
4. Use ↑ or ↓ to select *Language*
5. Press → to pull down the menu
6. Use ↓ or ↑ to select the desired language (image 13-8)
7. Press **ENTER**

The language is adapted and a black bullet shows the active configuration.

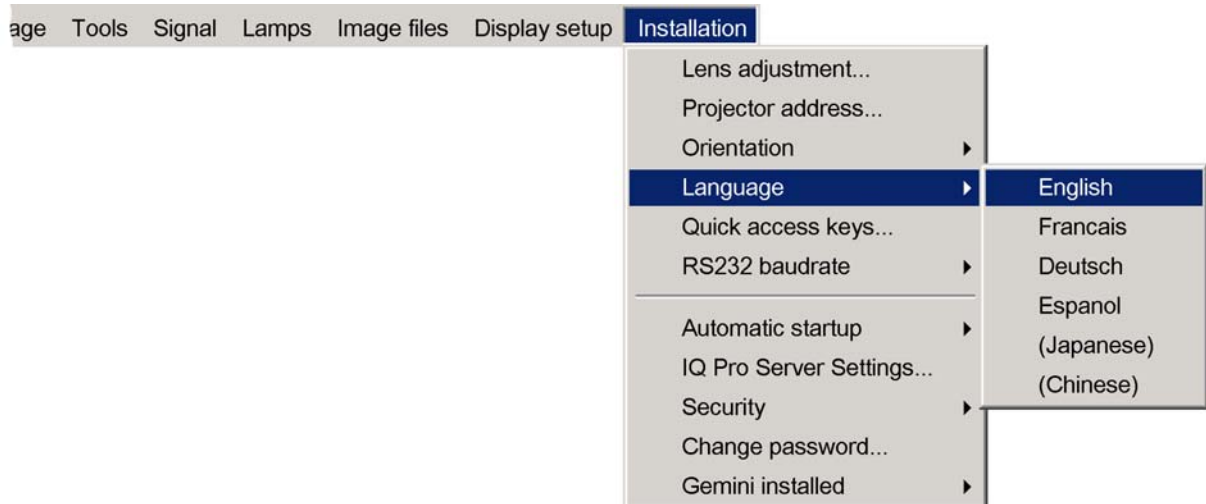

Image 13-8

## 13.5 Quick access keys

### What can be done ?

The 3 function keys on top of the RCU can be associated with a particular item in one of the menus.

Each function which is not password protected or does not have a key on the RCU can be associated to a function key.

### How to get an overview of the quick access keys ?

1. Press **MENU** to activate the Tool bar
2. Press → to select the *Installation*
3. Press ↓ to Pull down the *Installation* menu
4. Use ↑ or ↓ to select *Quick access keys* (image 13-9)
5. Press **ENTER**

A text box appears on the screen.

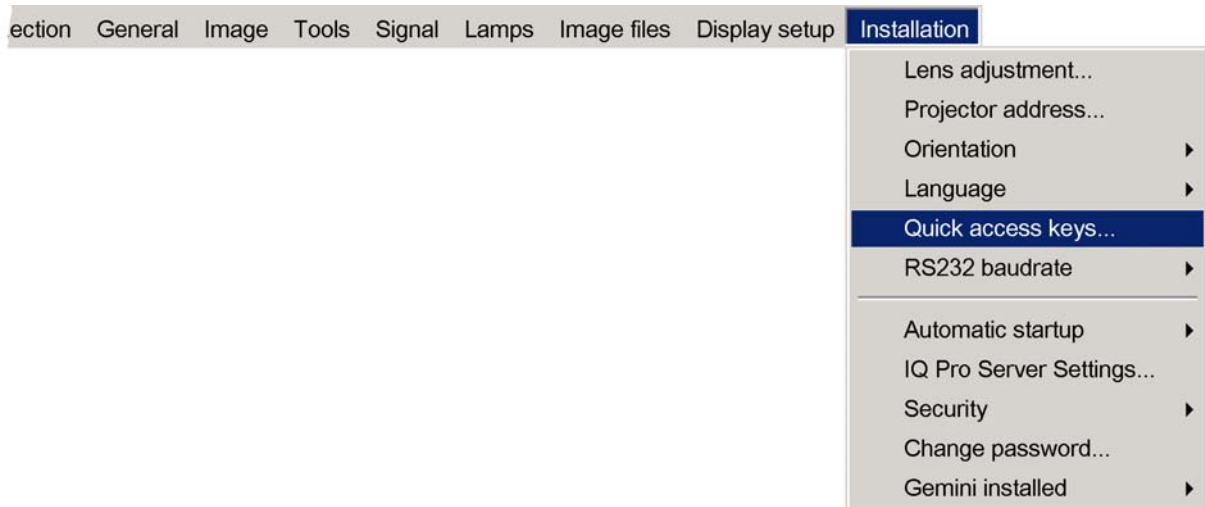

Image 13-9

### How to program the quick access keys ?

1. Scroll through the menus to the desired menu item
2. Push the desired function key for 3 seconds (image 13-10)

The menu item is stored in the quick access key

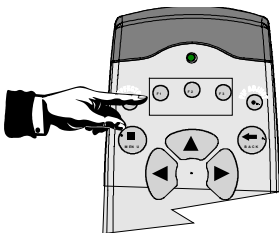

Image 13-10



#### Factory pre-programmed functions

- F1 : color depth
- F2 : noise reduction
- F3 : orientation

## 13.6 RS232 baudrate

### How to change the baudrate?

1. Press **MENU** to activate the Tool bar
2. Press → to select the *Installation* item
3. Press ↓ to Pull down the *Installation* menu
4. Use ↑ or ↓ to select *RS232 baudrate* (image 13-11)
5. Press → to pull down the menu
6. Use ↓ or ↑ to select the desired baudrate
7. Press **ENTER**

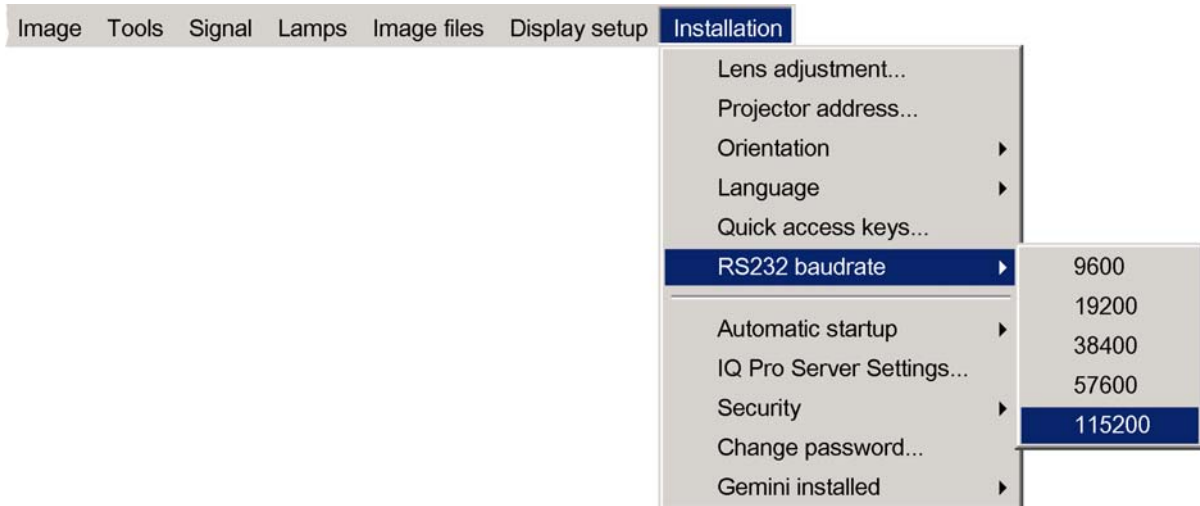

Image 13-11

## 13.7 Automatic startup

### What can be done ?

The automatic startup allows immediate restart of the projector after a power failure (breakdown), i.e. without passing through the standby state.

The projector restarts at power resume and recovers the previous settings (previous source,...).

This function can be disabled if undesired or inadequate for safety reasons, etc.



**CAUTION: If the Automatic startup function is enabled one must be aware of the fact that it involves safety precautions**

**Make sure that the projector (or the operators!) will not be affected by altered environmental conditions when restarting at power resume.**

### How to enable/disable the Automatic startup?

1. Press **MENU** to activate the Tool bar
2. Press → to select the *Installation* item
3. Press ↓ to Pull down the *Installation* menu
4. Use ↑ or ↓ to select *Automatic startup*
5. Press → to pull down the menu
6. Use ↓ or ↑ to enable/disable the automatic startup
7. Press **ENTER**

## 13.8 Security

### What can be done ?

A security function is implemented in the projector and allows a protection against theft.

A PIN code allows the user to lock the projector in case of wrong code entry.

The PIN code must be entered at each start up (Power ON), entering three times a wrong number triggers a wait cycle of 15 minutes, the second 3 wrong codes a wait cycle of 30 minutes, 1 hour, ...

The security mode can be enabled or disabled.

### How to activate the security mode ?

1. Press **MENU** to activate the Tool bar
2. Press → to select the *installation* item
3. Press ↓ to Pull down the menu
4. Use ↑ or ↓ to select *Security* (image 13-12)
5. Press → to open the menu
6. Use ↑ or ↓ to select *ON*
7. Press **ENTER**

A dialog box is displayed (image 13-13)

8. Use the arrow keys to select YES and press **ENTER** to confirm

A dialog box is displayed

Enter your name, company name,... (this information is displayed in the identification menu) (image 13-14)

9. Press **ACCEPT**

A dialog box is displayed.

Enter the PIN code, and confirm it. (image 13-15)

An informative text box is then displayed. Press **ENTER** or **BACK** to escape. (image 13-16)

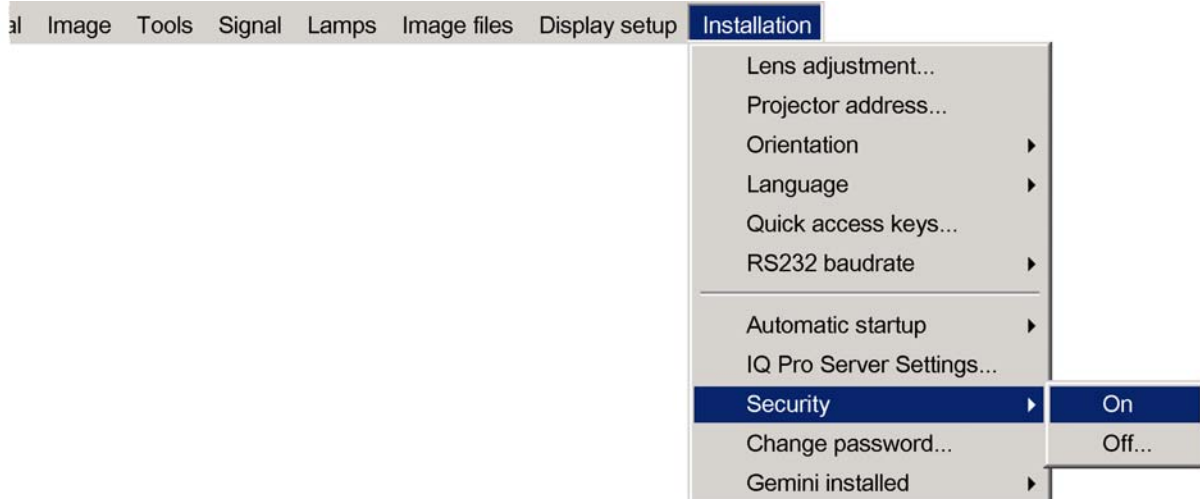

Image 13-12

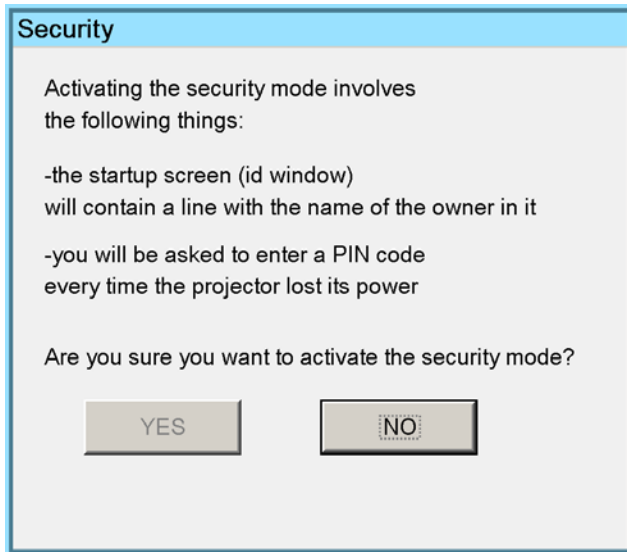

Image 13-13

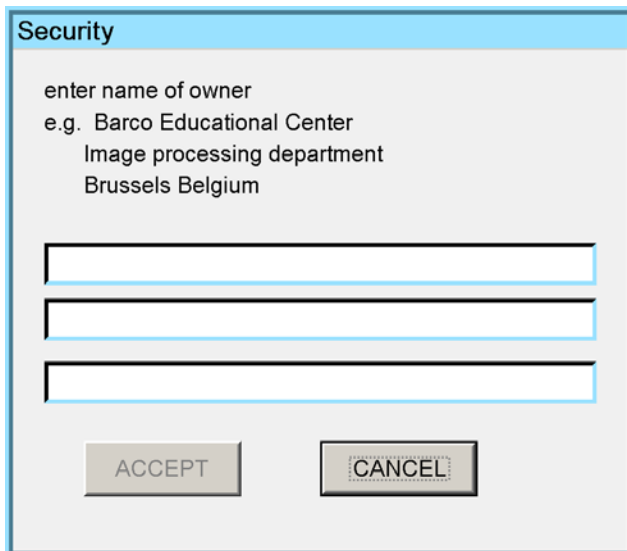

Image 13-14

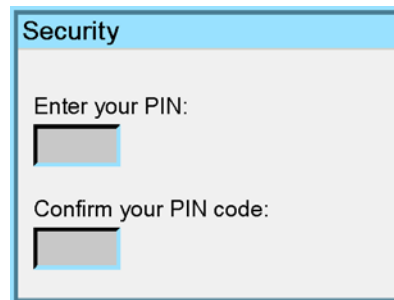

Image 13-15

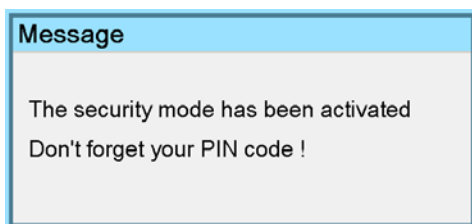

Image 13-16

### How to disable the security mode ?

1. Press **MENU** to activate the Tool bar
2. Press → to select the *installation* item
3. Press ↓ to Pull down the menu
4. Use ↑ or ↓ to select *Security*
5. Press → to open the menu
6. Use ↑ or ↓ to select *OFF*
7. Press **ENTER**

- A dialog box is displayed
8. Enter your PIN code
    - The security mode is now disabled

## 13.9 Change password

### How to change the password ?

1. Press **MENU** to activate the Tool bar
2. Press → to select the *Installation* item
3. Press ↓ to Pull down the *Installation* menu
4. Use ↑ or ↓ to select *Change password* (image 13-17)
5. Press **ENTER**
  - A dialog box is displayed.
  - (image 13-18)
6. Use ← or → , the numeric keys on the remote , or the keypad to enter and confirm the new password.
  - Each character is displayed as an asterisk.

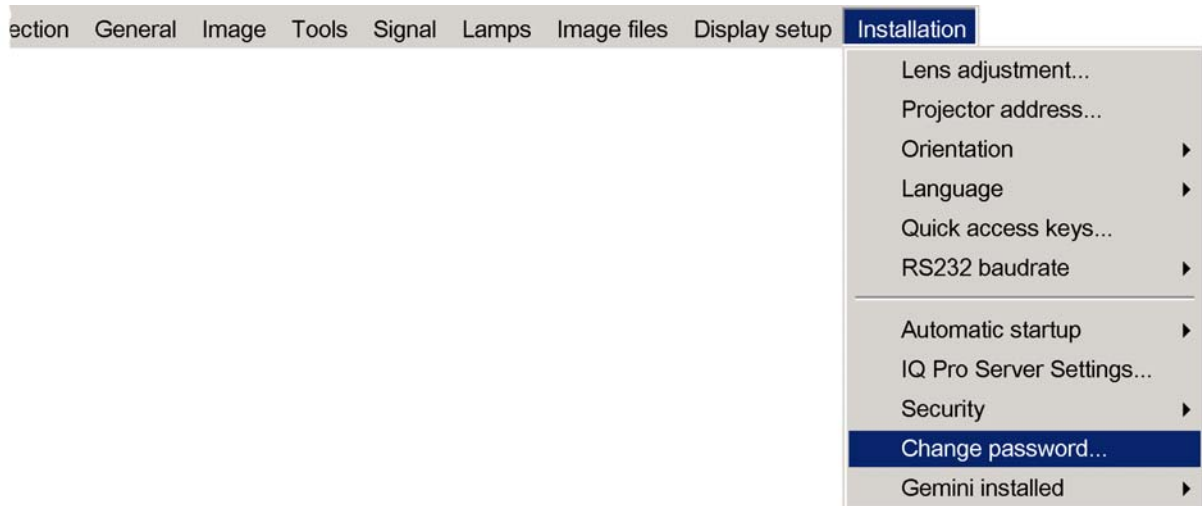

Image 13-17

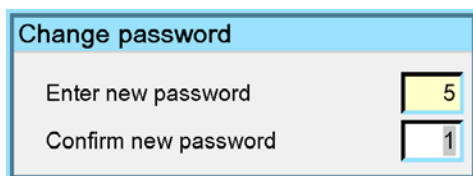

Image 13-18



The new password is accepted if the new password and the confirmed password coincide.



If the password is forgotten contact a Barco authorized technician.

## 13.10 Gemini installed (only for GEMINI CADWALL systems ! )

### When to enable ?

Gemini is option is necessary when the iQ is used in a Gemini 2 channel CADWALL system. By enabling Gemini the restrictions relative to the allowed difference in the number of total lines are changed :

- 1 line for non interlaced sources (instead of 0)
- 2 lines for interlaced sources (instead of 1)



The default setting is NO. Never activate this option if not in presence of a Gemini CADWALL system.

### How to enable Gemini ?

1. Press **MENU** to activate the Toolbar
2. Press → to select the *Installation* item
3. Press ↓ to Pull down the *Installation* menu
4. Use ↑ or ↓ to select *Gemini installed* (image 13-19)
5. Use ↑ or ↓ to select *ON*
6. Press **ENTER**

The Gemini option is enabled

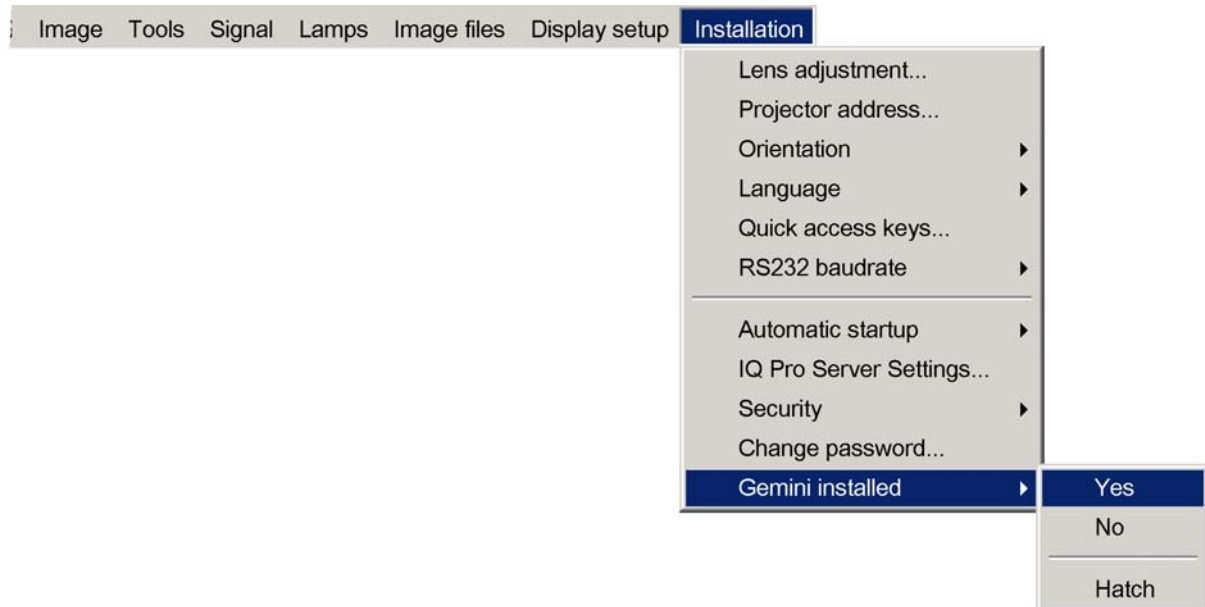

Image 13-19



## A. CLEANING THE DUSTFILTERS

### Overview

- Dustfilters
- Cleaning

### A.1 Dustfilters

#### Location of the filters

There are 4 filters located at different positions

1. Filter1: Lamp 1
2. Filter2 : Lamp 2
3. Filter 3 : X-Cube filter
4. Filter 4 : Input filter

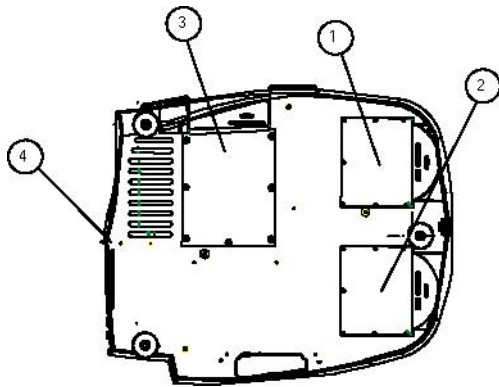

Image A-1  
location of the filters

- 1 lamp filter 1
- 2 lamp filter 2
- 3 x-cube filter
- 4 input filter

### A.2 Cleaning

#### How to clean the dustfilters ?

1. Place the projector so as to access easily the filter to be cleaned
2. Push the handle downwards to unlock the filter. (image A-2)
3. Slide out the filter (image A-3, image A-4, image A-5)  
See image A-6.
4. Clean the dust filter with a dry cloth.
5. Re-insert the dust filter by sliding it back in the filter housing.

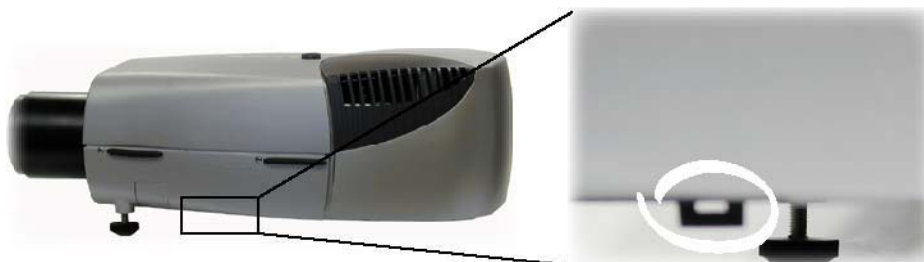

Image A-2  
Location of the x-cube filter and its handle

## A. Cleaning the dustfilters

---



Image A-3  
Lamp filter removal



Image A-4  
lamp & X-Cube filters removed

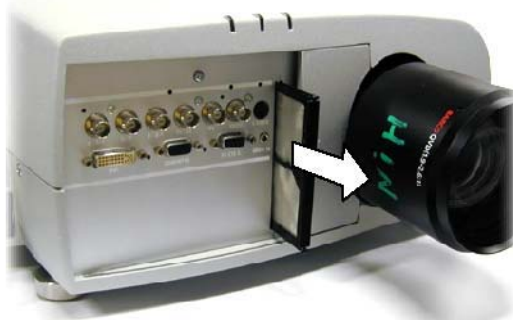

Image A-5  
Input filter removal



Image A-6  
Input filter removed



If the airflow is falling under a predetermined threshold value a warning will be displayed on the screen.

### Message

An insufficient airflow is detected  
Please check your dustfilter  
at the airflow entrance

Image A-7

**At that time it is strongly recommended to replace or clean the dustfilter under the X-cube. Failing to do so, will strongly reduce the lifetime of the LCD's and the analyzers.**

**The manufacturer reserves itself the right to refuse warranty repair if the projector was working with dirty dustfilters.**

---

## B. STANDARD IMAGE FILES

### B.1 Table overview

#### Table overview

The following standard image files are pre-programmed in the projector.

Name <sup>4</sup>	Resolution <sup>5</sup>	Fvert Hz <sup>6</sup>	FHor kHz <sup>7</sup>	Fpix MHz <sup>8</sup>	Ptot <sup>9</sup>	Pact <sup>10</sup>	Ltot <sup>11</sup>	Lact <sup>12</sup>
1600_48V	1600x600i	48,040	62,500	135,000	2160	1600	651	600
CGA	640x200i	59,924	15.700	14.318	912	640	262	200
COMPUSC4	1024x480i	29,945	30,694	39,779	1296	1024	512	480
DOS1_70	720x400	70	31,500	28,350	900	720	449	400
DOS3_56	640x400	56	24,800	21,030	848	640	440	400
DOS4_85	640x400	85	37,860	31,500	832	640	445	400
ED	735x480	59,943	31,470	28,638	910	735	525	480
EGA	640x350	59,702	21,851	16,257	744	640	366	350
ESVGA_75	832x624	73	47,900	53,648	1120	832	660	624
EXGA_60	1152x864	60	54,900	79,934	1456	1152	916	864
EXGA_80	1152x864	80,000	76,499	110,159	1140	1152	958	864
EXGA_85	1152x864	85 ,000	77,202	121,671	1576	1152	907	864
EXGA1_70	1152x864	70	63,800	94,424	1480	1152	912	864
EXGA1_75	1152x864	75	67,499	107,999	1600	1152	900	864
EXGA2_70	1152x864	70	66,098	99,941	1512	1152	945	864
EXGA2_75	1152x864	75	75,199	110,092	1464	1152	1002	864
FMR	640x400i	42,323	36,440	28,570	784	640	431	400
GE_50	640x400	50	31,200	44,928	1440	1163	625	522
GE_60	1085x480	60	30,700	41,261	1344	1085	512	480
hd_1080i	1920x540	60	33,750	74,249	2200	1920	563	540
hd_24p	1920x1080	24,000	27,000	74,000	2750	1920	1125	1080
hd_24sf	1950x540	48,000	27,000	74,000	2750	1950	562	540
hd_25i	1920x540	50,000	28,125	74,000	2640	1920	562	540
hd_25p	1920x1080	25,000	28,125	74,000	2640	1920	1125	1080

4. Name: name of file, contains the settings.  
5. Resolution: image resolution, when followed by ..i means interlaced.  
6. Fvert Hz: vertical frame frequency of the source  
7. FHor kHz: horizontal frequency of the source  
8. Fpix MHz: pixel frequency  
9. Ptot : total pixels on one horizontal line.  
10. Pact: active pixels on one horizontal line.  
11. Ltot: total lines in one field  
12. Lact: active lines in one field.

B. Standard Image Files

Name <sup>4</sup>	Resolution <sup>5</sup>	Fvert Hz <sup>6</sup>	FHor kHz <sup>7</sup>	Fpix MHz <sup>8</sup>	Ptot <sup>9</sup>	Pact <sup>10</sup>	Ltot <sup>11</sup>	Lact <sup>12</sup>
hd_30p	1920x1080	30,000	33,750	74,000	2200	1920	1125	1080
hd_60p	1280x720	60,000	45,000	74,000	1650	1280	750	720
INTER_GR	1184x886	67,170	61,796	92,941	1504	1184	920	886
IQPC_SXGA_2	1366x1024	59	62,933	106,230	1688	1366	1067	1024
IQPC_SXGA_D	1280x1024	60	63,857	107,791	1688	1280	1063	1024
IQPC_XGA_1	1024x768	61	49,005	65,863	1344	1024	807	768
IQPC_XGA_2	1024x768	60	48,485	65,164	1344	1024	807	768
IQPC_XGA_D	1024x768	61	49,005	65,863	1344	1024	806	768
MAC_3	512x384	60,147	24,480	15,667	640	512	407	384
MAC_4	560_384	60,147	24,480	17,234	704	560	407	384
MAC_5	512x342	60,158	22,259	16,670	704	512	370	342
MAC_6	832x624	74,546	49,722	57,280	1152	832	667	624
MAC_7	1024x768	74,907	60,150	80,000	1330	1024	803	768
MAC_LC	640x480	66,619	34,975	31,338	896	640	525	480
MAC_POR	640x870	74,996	68,846	57,280	932	640	918	870
METH_BOOT1	720x400	70	31,500	28,350	900	720	448	400
METH_BOOT2	640x480	59	31,000	24,800	800	640	524	480
MXGA_100	1152x864	100	92,997	145,820	1568	1152	930	864
NTSC	675x240	60	15,748	13,512	858	675	263	240
NTSC_LIMO_x2	834x482	60	31,496	32,252	1024	834	525	482
NTSC_LIMO_x3	834x715	60	46,646	47,766	1024	834	778	715
NTSC_LIMO_x4	834x961	60	62,992	64,504	1024	834	1050	961
PAL	675x286	50	15,625	13,500	864	675	313	286
PAL_LIMO_x2	834x574	50	31,250	32,000	1024	834	626	574
PAL_LIMO_x3	834x850	50	46,296	47,407	1024	834	926	850
PAL_LIMO_x4	834x1146	50	62,500	64,000	1024	834	1250	1146
PAM500	640x400	60,000	26,400	22,810	864	640	440	400
PAM800	1120x375i	44,936	36,443	50,000	1372	1120	406	375
PC98_2	1120x375i	39,994	32,835	47,840	1457	1120	411	375
PC98_3	1120x750	60,000	50,000	78,569	1571	1120	833	750
S1152_66	1152x900	66,004	61,846	94,500	1528	1152	937	900
S1152_76	1152x900	76,637	71,809	108,000	1504	1152	937	900

Name <sup>4</sup>	Resolution <sup>5</sup>	Fvert Hz <sup>6</sup>	FHor kHz <sup>7</sup>	Fpix MHz <sup>8</sup>	Ptot <sup>9</sup>	Pact <sup>10</sup>	Ltot <sup>11</sup>	Lact <sup>12</sup>
S1600_67	1600x1280	67	89,286	200,000	2240	1600	1334	1280
SDI_625	675x278i	25,000	15,625	13,500	864	720	313	278
SDI_525	675x240i	29,970	15,734	13,500	858	720	263	240
SG_50	1600x1200	50,000	62,500	130,313	2085	1600	1250	1200
SG_60_1	1280x1024	60,000	63,900	107,352	1680	1280	1065	1024
SG_60_2	1024x768	60,000	48,780	64,390	1320	1024	813	768
SG_60_3	960x680	60,000	43,200	54,432	1260	960	720	680
SG_60_4	1600x1200	60,000	75,000	156,375	2085	1600	1250	1200
STOR_100	764x287	100	31,300	30,361	970	764	313	287
STOR_120	810x247	119	31,300	30,361	970	810	263	247
STOR_50	1024x512	50	31,300	40,064	1280	1024	625	512
STOR_60	1024x512	60	31,300	40,064	1280	1024	525	512
SUNNEWS67	1280x1024	67,189	71,691	117,000	1632	1280	1067	1024
SUNNEWS76	1280x1024	76,107	81,130	135,000	1664	1280	1066	1024
SUNXGA60	1024x768	59,984	48,287	64,125	1328	1024	805	768
SUNXGA70	1024x768	70,041	56,596	74,250	1312	1024	808	768
SUNXGA77	1024x768	77,069	62,040	84,375	1360	1024	805	768
SUP_MAC	1024x768	60,000	48,780	63,999	1312	1024	813	768
SVGA_56V	800x600	56,250	35,156	36,000	1024	800	625	600
SVGA_60V	800x600	60,317	37,879	40,000	1056	800	628	600
SVGA_72_1	800x600	72,084	48,080	50,003	1040	800	666	600
SVGA_72_2	800x600	72,084	48,080	50,003	1040	800	667	600
SVGA_75	800x600	75,000	46,875	75,000	1056	800	625	600
SVGA_85	800x600	85,000	53,635	56,250	1048	800	631	600
SXGA_72_1	1280x1024	72	76,699	128,854	1680	1280	1061	1024
SXGA_72_2	1280x1024	72	76,970	130,080	1690	1280	1069	1024
SXGA_75	1280x1024	75	79,974	134,997	1688	1280	1066	1024
SXGA_76	1280x1024	76	81,103	134,955	1664	1280	1066	1024
SXGA_85	1280x1024	85	91,149	157,506	1728	1280	1072	1024
SXGA_L	1280x1024	60	62,500	84,000	1344	1280	1041	1024

B. Standard Image Files

Name <sup>4</sup>	Resolution <sup>5</sup>	Fvert Hz <sup>6</sup>	FHor kHz <sup>7</sup>	Fpix MHz <sup>8</sup>	Ptot <sup>9</sup>	Pact <sup>10</sup>	Ltot <sup>11</sup>	Lact <sup>12</sup>
SXGA+_60	1280x1024	60	63,980	107,997	1688	1280	1066	1024
SXGA2_60	1280x960	60	59,999	107,998	1800	1280	1000	960
SXGA2_85	1280x960	85	85,940	148,505	1728	1280	1011	960
SXGA50	1280x1024	50	52,351	88,368	1688	1280	1047	1024
SXGA60v	1280x1024	60	63,658	110,001	1728	1280	1056	1024
SXGAP_70	1024x1280	70	92,902	133,779	1440	1024	1326	1280
SXGAP1_60	1024x1280	60	77,700	83,916	1080	1024	1297	1280
SXGAP2_60	1024x1280	60	79,498	110,661	1392	1024	1325	1280
UXGA_60	1600x1200	60	75,002	162,004	2160	1600	1250	1200
UXGA_65	1600x1200	65	81,248	175,496	2160	1600	1250	1200
UXGA_L	1600x1200	60	72,801	119,977	1648	1600	1216	1200
UXGAP1_60	1200x1600	59	95,804	119,946	1252	1200	1620	1600
UXGAP2_60	1200x1600	60	99,404	163,817	1648	1200	1656	1600
VGA_60	640x480	60	31,326	25,061	800	640	525	480
VGA_66	640x480	67	35,100	30,326	864	640	525	480
VGA_72	640x480	73	37,860	31,500	832	640	520	480
VGA_75	640x480	75,000	37,500	31,500	840	640	500	480
VGA1_85	640x480	85,000	43,369	36,000	832	640	509	480
VGA2_85	720x400	85,000	37,900	35,475	936	720	446	400
VGA75ISO	640x480	75,000	39,375	31,500	800	640	525	480
VIDEO525	1302x239i	29,970	15,734	32,207	1302	1024	263	239
VIDEO625	1024x278i	25,000	15,625	31,984	1310	1024	313	278
XGA_43	1024x384	87	35,500	44,872	1264	1024	409	384
XGA_60	1024x768	60,000	48,360	64,996	1344	1024	806	768
XGA_70_1	1024x768	70,000	56,475	74,999	1328	1024	806	768
XGA_70_2	1024x768	70,000	57,052	78,047	1368	1024	815	768
XGA_72	1024x768	71,955	58,140	80,000	1376	1024	808	768
XGA_75_1	1024x768	75	60,024	78,752	1312	1024	800	768
XGA_75_2	1024x768	76	61,080	86,000	1408	1024	806	768
XGA_85	1024x768	85,000	68,680	94,500	1376	1024	808	768

---

Name <sup>4</sup>	Resolution <sup>5</sup>	Fvert Hz <sup>6</sup>	FHor kHz <sup>7</sup>	Fpix MHz <sup>8</sup>	Ptot <sup>9</sup>	Pact <sup>10</sup>	Ltot <sup>11</sup>	Lact <sup>12</sup>
XGA_EOS	1024x768	63,000	50,000	67,200	1344	1024	796	768
XGA75_GS	1024x768	74,534	59,701	79,284	1328	1024	801	768
SXGA_60	1280x1024	60	63,980	107.997	1688	1280	1066	1024
SXGA+_60_2	1400x1050	60	65,574	122,230	1864	1400	1089	1050
SXGA+_60_3	1400x1050	60	65,104	122,396	1880	1400	1085	1050

Table B-1





---

# GLOSSARY

**AGC**

Automatic Gain Control: allows an automatic amplitude (gain) control of the incoming video signal

**ANSI 73.11**

American power plug to connect the power cord to the wall outlet.

**CEE7**

European power plug to connect the power cord to the wall outlet.

**Common address**

Default address. Projector will always execute the command coming from a RCU programmed with that common address.

**Component Video**

In Component Video the term component describes a number (3) of elements that are needed to make up the video picture, these components are R-Y/Y/B-Y. A composite video signal on the other hand contains all the information needed for the color picture in a single channel of information

**DVI**

Digital Visual Interface is a display interface developed in response to the proliferation of digital flat panel displays.

The digital video connectivity standard that was developed by DDWG (Digital Display Work Group). This connection standard offers two different connectors: one with 24 pins that handles digital video signals only, and one with 29 pins that handles both digital and analog video. This standard uses TMDS (Transition Minimized Differential Signal) from Silicon Image and DDC (Display Data Channel) from VESA (Video Electronics Standards Association).

DVI can be single or dual link.

**Graphics**

Native resolution of the LCD panels = 1024 pixels x 768 pixels (4:3)

**PiP**

PiP stands for "Picture in Picture" and allows to display multiple windows containing each of them an image. The windows may be of the video or data type.

**Projector address**

Address installed in the projector to be individually controlled.

**Reality(SXGA)**

Native resolution of the LCD panels = 1366 pixels x 1024 pixels (4:3)

**Reality(SXGA+)**

Native resolution of the LCD panels = 1400 x 1050 pixels (4:3)

**SDI**

Serial Digital Interface

**Video Selector**

The Video Selector is a graphical interface which allows an overview of the different video inputs (Composite Video and S-Video) and whether they are active (signal connected) or not as well as the selection of these different signals.



# INDEX

## A

Address 39–40, 116  
 Program 40  
 RCU 40  
 Projector address 116  
 setting 39  
 Adjustments 115  
 lens 115  
 AGC 74  
 Audio 26  
 connection 26  
 Auto Image 98  
 AutoImage 112  
 Setup 112

## B

Background 88  
 Battery 17  
 Installation 17  
 blanking 69  
 Blanking 113

## C

Cleaning 17, 125  
 dustfilters 125  
 Lens 17  
 Connections 19–20, 27  
 Communication 27  
 Communications 27  
 RS232 IN 27  
 input source connections 19  
 Input source connections 20, 27  
 extended configuration 27  
 facilities 20  
 layers 20  
 power connection 19

## D

Diagnostics 84  
 Digital 24–25  
 DVI 24  
 SDI 25  
 Digital Zoom 41  
 Dimensions 6  
 projector 6  
 display 107  
 setup 107

## F

File 97, 99, 102–104  
 copy 103  
 delete 104  
 edit 99  
 load 97  
 rename 102  
 Filters 125  
 cleaning 125  
 location 125  
 Full screen representation 107

## G

Gain 74–75  
 automatic control 74  
 manual control 75  
 Gemini 124  
 General 52–55

audio 53  
 Audio 53–54  
 settings 54  
 setup 53  
 identification 55  
 Standby Timer 52  
 General menu 51  
 freeze 51  
 pause 51  
 General settings 51  
 General Menu 51  
 Getting started 31, 35, 37, 39, 41–42  
 address 39  
 Controlling the projector 41  
 digital zoom 41  
 lamp runtime 35  
 quick set up 37  
 Quick Set up 37  
 lens 37  
 using the dialogboxes 42  
 using the menu 41

## I

Identification screen 55  
 Image 64  
 resolution 64  
 image files 105  
 forced file load 105  
 Image files 127  
 standard 127  
 Image settings 57  
 Image menu 57  
 Input 21–26, 69  
 input balance 69  
 Input source connection 21–26  
 5-Cable input 21  
 Audio 26  
 Composite Video input 22  
 computer input 25  
 DVI 24  
 S-Video input 23  
 SDI 25  
 Input source connections 27–29  
 Extended configuration 27–29  
 5-cable 27  
 introduction 27  
 S-Video 28  
 summarizing 29  
 Installation 9, 124  
 Gemini 124  
 guidelines 9  
 Installation guidelines 9–10, 14  
 configurations 10  
 guidelines 9  
 lenses 14  
 Safety 9  
 safety warnings 9

## L

lamp 36  
 error 36  
 Lamp 35  
 runtime 35  
 Lamp history 92  
 Lamp mode 89  
 Language 118  
 Layers 20  
 input 20  
 Lens 6, 16–17, 37, 115  
 Cleaning 17

lens adjustments 115  
 Packaging 6  
   unpack 6  
 quick Adjustment 37  
 removing 16  
 Lenses 14–15  
   available lenses 14  
   formulas 15  
   installation 15  
 Local keypad 31

## M

Menu 41, 45, 57–60, 65–67, 69, 74–75, 77, 79–84, 87–89, 92–94, 97, 99, 102–104, 107–108, 111–112, 115–120, 123  
   Image files menu 97, 99, 102–104  
     copy file 103  
     delete file 104  
     edit file 99  
     load file 97  
     rename file 102  
   Image menu 57–60, 65–67, 69, 74–75  
     AGC on video 74  
     aspect ratio 60  
     Brightness 58  
     color 58  
     color temperature 66  
     contrast 58  
     filmmode detection 67  
     Gamma 59  
     input balance 69  
     Keystone 65  
     manual gain control 75  
     noise reduction 60  
     phase 60  
     settings 57  
     sharpness 59  
     Tint 59  
   installation menu 115  
   Installation menu 107–108, 111–112, 115–120, 123  
     AutoImage Setup 112  
     Automatic startup 120  
     change password 123  
     Full screen representation 107  
     language 118  
     lens adjustments 115  
     projector address 116  
     projector orientation 117  
     Quick access keys 119  
     RS232 baudrate 120  
     Sliderbox position 111  
     Startup screen 107  
     Take screenshot 108  
     textbox 108  
   Lamp menu 89, 92–94  
     history 92  
     Mode 89  
     reset runtime 93  
     Runtime warning 94  
     runtimes 89  
   Signal menu 87–88  
     background 88  
     switching mode 87  
   Source selection 45  
   structure 41  
   Tools 77  
     PiP 77  
   Tools menu 77, 79–84  
     Diagnostics 84  
     PiP add window 79  
     PiP Adjust 83  
     PiP delete layout 82  
     PiP layout 81  
     PiP remove window 80  
     PiP rename layout 82  
     PiP Save 81

PiP select 79  
   using the menu 41  
 menu bar 110

## N

Native resolution 64  
 No signal 88  
   background 88

## O

Orientation 117  
   projector orientation 117

## P

Packaging 5–6  
   Lens 6  
   projector 5  
 Password 123  
   change password 123  
 PiP 79–83  
   add window 79  
   adjust 83  
   layout 81  
   Layout 81–82  
     delete 82  
     rename 82  
     save 81  
   remove window 80  
   select 79  
 Power mode 91  
 Projector 5–6, 34, 40  
   Controlling 40  
   dimensions 5–6  
   packaging 5  
   Packaging 5  
     unpack 5  
   Switch on 34

## Q

Quick access keys 119

## R

RCU 17, 31, 33, 37  
   Battery 17  
   Terminology 33  
   Overview 33  
   Using 37  
 Removing 16  
   lens 16  
 RS232 baudrate 120  
 Runtime 93–94  
   reset 93  
   warning 94

## S

Screenshot 108  
   security 121  
 shipped Box 5  
   content 5  
 Sliderbox position 111  
 Source 45, 87  
   selection 45  
   Source selection 45  
   switching mode 87  
 source files 127  
   standard 127  
 Source selection 46–48  
   composite video 46

S-Video 47  
video selector 48  
Startup 120  
automatic 120  
Startup screen 107  
status bar 110  
Switching 87  
switching mode 87

## T

Textbox 108

Timer 52

## V

Video 22–23, 74–75  
AGC 74  
Composite Video 22  
manual gain control 75  
S-Video 23



## Revision Sheet

To:

► **Barco nv Presentations**  
Noordlaan 5, 8520 Kurne  
Phone: +32 56.36.82.11, Fax: +32 56.35.86.51  
E-mail: presentations.bid@barco.com, Web: www.barco.com

From: \_\_\_\_\_

Date: \_\_\_\_\_

Please correct the following points in this documentation (**R5976367/10**):

**page**

**wrong**

**correct**

## Free Manuals Download Website

<http://myh66.com>

<http://usermanuals.us>

<http://www.somanuals.com>

<http://www.4manuals.cc>

<http://www.manual-lib.com>

<http://www.404manual.com>

<http://www.luxmanual.com>

<http://aubethermostatmanual.com>

Golf course search by state

<http://golfingnear.com>

Email search by domain

<http://emailbydomain.com>

Auto manuals search

<http://auto.somanuals.com>

TV manuals search

<http://tv.somanuals.com>