

Solaris LC40



Owners Manual

R9004120 (Events)
R9004125 (Media)

Barco nv Media

Noordlaan 5, B-8520 Kurne

Phone: +32 56.36.89.70

Fax: +32 56.36.83.86

E-mail: media@barco.com

Visit us at the web: www.barco.com

Barco nv Events

Noordlaan 5, B-8520 Kurne

Phone: +32 56.36.89.70

Fax: +32 56.36.88.24

E-mail: events@barco.com

Visit us at the web: www.barco.com

Printed in Belgium

Changes

Barco provides this manual 'as is' without warranty of any kind, either expressed or implied, including but not limited to the implied warranties or merchantability and fitness for a particular purpose. Barco may make improvements and/or changes to the product(s) and/or the program(s) described in this publication at any time without notice.

This publication could contain technical inaccuracies or typographical errors. Changes are periodically made to the information in this publication; these changes are incorporated in new editions of this publication.

Copyright ©

All rights reserved. No part of this document may be copied, reproduced or translated. It shall not otherwise be recorded, transmitted or stored in a retrieval system without the prior written consent of Barco.

Trademarks

Brand and product names mentioned in this manual may be trademarks, registered trademarks or copyrights of their respective holders. All brand and product names mentioned in this manual serve as comments or examples and are not to be understood as advertising for the products or their manufactures.

TABLE OF CONTENTS

1. Safety Instructions	3
1.1 General instructions	3
1.2 Electrical Safety	3
1.3 Protection on Servicing	4
1.4 Safety on Cleaning	5
1.5 Safety on Shipping	5
1.6 On installation site	5
2. Packaging and Dimensions	7
2.1 Box content	7
2.2 Packaging	7
2.3 Dimensions	8
3. Installation Guidelines	11
3.1 General	11
3.2 Solaris LC40 configurations	11
3.3 Battery Insertion in the Remote Control	12
4. Connections	13
4.1 Power connection	13
4.2 Input source connections	13
4.2.1 Input facilities	13
4.2.2 Digital Visual Interface (DVI) input	14
4.2.3 RGB analog input	16
4.2.4 Serial Digital Interface	17
4.2.5 Compact PC module	17
4.2.6 Video input module	18
4.2.7 DVI input module (optional)	20
4.2.8 HD-SDI input module (optional)	21
4.2.9 RGB input module (optional)	22
4.2.10 Audio pré-amp input (optional)	23
4.3 RGB out at native screen resolution (WXGA)	24
4.4 Communication Connections	25
4.4.1 RS232 IN/OUT	25
4.5 Cable cover	25
5. Getting Started	27
5.1 Terminology overview RCU	27
5.2 Switching ON/OFF	28
5.3 Using the RCU	29
5.4 LCD panel address	30
5.4.1 IR address	30
5.4.2 Displaying and Programming IR addresses into the RCU	30
5.4.3 RS232 address	30
5.4.4 Controlling the Solaris LC40 with the RCU	30
5.5 Locking the Solaris LC40 for IR signals	32
5.6 Quick access to Picture in Picture	32
6. Getting used to the Menu Structure	35
6.1 How to start up the menus	35
6.2 Using the menus	35
6.3 Adjusting a control in a Slider box	36
7. Input Selection	37
7.1 Start up the Input Selection	37
7.2 Selecting an Input Source	37
7.3 Configuring input 2	38
7.4 Selecting Compact PC	38
8. Image Settings	41
8.1 Image Settings Menu overview	41
8.2 Aspect Ratio	41
8.3 Brightness	42
8.4 Contrast	43
8.5 Color Saturation	43
8.6 Tint (hue)	44
8.7 Sharpness	44
8.8 Viewport	45
8.8.1 About Viewport	45
8.8.2 Viewport creation	45
8.8.3 Automatic Viewport function	48
8.8.4 Total pixels setup	49
8.9 Phase	49

9. Audio Settings	51
9.1 Audio settings menu overview	51
9.2 Starting up the audio controls	51
9.3 Volume control	51
9.4 Balance control	52
9.5 Bass control	52
9.6 Treble control	53
9.7 Subwoofer control	53
10. PiP Settings	55
10.1 Introduction to PiP	55
10.2 Select PiP input	55
10.3 PiP size	56
10.3.1 Scale	56
10.3.2 Horizontal size	57
10.3.3 Vertical size	57
10.4 PiP position	58
11. Compact PC Control	61
11.1 Display control by Compact PC	61
12. Advanced Settings	63
12.1 Advanced Settings menu overview	63
12.2 Gamma	63
12.3 Color Temperature	64
12.4 Input Balance	65
12.4.1 Introduction to Input Balance	65
12.4.2 Adjusting the input balance	67
12.5 Noise Reduction	68
12.6 Film mode detection	69
12.7 Video Gain	70
12.8 Display Settings	70
12.8.1 Rotate	71
12.8.2 Backlight	71
12.9 Installation	72
12.9.1 File Services	72
12.9.1.1 Introduction to image files	72
12.9.1.2 Load file set up	73
12.9.1.3 Loading a specific file	73
12.9.2 When no Signal	74
12.9.3 Language Selection	75
12.9.4 Tiled setup	75
12.10 Service	77
12.10.1 Identification screen	77
12.10.2 IR address	78
12.10.3 Serial communication	78
12.10.3.1 RS232 address	79
12.10.3.2 Changing the baudrate for RS232 communication	79
12.10.4 IR locking	80
12.10.4.1 Locking the display	80
12.10.4.2 Changing your PIN code	80
12.10.5 Restore Factory Defaults	81
A. Standard Source Set up Files	83
A.1 Table overview	83
B. Optional Mounting Equipment	85
B.1 Wall Mounting Support	85
B.1.1 Kit content	85
B.1.2 Horizontal Wall Mounting Support	85
B.1.3 Vertical Wall Mounting Support	87
B.2 Table mounting support	89
C. Specifications	91
C.1 Specifications Solaris LC40	91
Glossary	93
Index	95

1. SAFETY INSTRUCTIONS

1.1 General instructions

Scope

This document includes safety considerations of the Solaris LC40. Throughout this manual, the term SERVICE PERSONNEL refers to persons having appropriate technical training and experience necessary to be knowledgeable of potential hazards to which they are exposed (including, but not limited to HIGH VOLTAGE ELECTRIC and ELECTRONIC CIRCUITRY and HIGH BRIGHTNESS PROJECTORS) in performing a task, and of measures to minimize the potential risk to themselves or other persons. The term USER and OPERATOR refers to any person other than SERVICE PERSONNEL, AUTHORIZED to operate the installed digital video distribution system.

General safety instructions

- Before operating your Solaris LC40, please read this manual thoroughly, and retain it for future use.
- Installation and preliminary adjustments should be performed by qualified service personnel or authorized service dealers.
- All warnings on the system parts and in the documentation manual should be adhered to.
- All instructions for operating and use of this equipment must be followed precisely.
- All local installation codes should be adhered to.

Owner's Record

The part number and serial number are indicated on the registration plate which is located at the rear of the Solaris LC40.

Record this number here. Refer to that whenever you call upon your dealer regarding these products.

Name	Parts Number	Serial Number	Dealer
Solaris LC40			

Shock Hazard



The lightning flash with an arrowhead within a triangle is intended to tell the user that parts inside this product are risk of electrical shock to persons.



The exclamation point within a triangle is intended to tell the user that important operating and/or servicing instructions are included in the technical documentation for this equipment.

Image 1-1

1.2 Electrical Safety

Ratings & Grounding

- These products should be operated from an AC power source. Check if the mains voltage and the load matches the product electrical ratings.
- A grounded three-core power cable has to be used. Connect the power cord by inserting it in a grounded electrical outlet, making sure that the cord is properly grounded.
- If you are unable to install the AC Requirements, contact your electrician. Do not defeat the purpose of the grounding.
- Always connect this appliance to an electrically grounded outlet. Never use a ground bypass (cheater) adapter.

1. Safety Instructions

General

- Always plug power cord into appliance before plugging into outlet.
- Do not allow anything to rest on the power cord. Do not locate this product where persons will walk on the cord.
- Always unplug appliance from electrical outlet before cleaning and servicing and when not in use. Never yank cord to pull plug from outlet. Grasp plug and pull to disconnect.
- Do not operate appliance with a damaged cord or if the appliance has been dropped or damaged - until it has been examined by a qualified serviceman.
- Position the cord so that it will not be tripped over, pulled, or contact hot surfaces.
- If an extension cord is necessary, a cord with a current rating at least equal to that of the appliance should be used. Cord rated for less amperage than the appliance may overheat.
- Let appliance cool completely before storing. Remove cord from appliance when storing.
- Never push objects of any kind into this product through cabinet slots as they may touch dangerous voltage points or short out parts that could result in a risk of fire or electrical shock.
- Never spill liquid of any kind on the product. Should any liquid or solid object fall into the cabinet, unplug the set and have it checked by qualified service personnel before resuming operations.
- Lightning - For added protection for this video product during a lightning storm, or when it is left unattended and unused for long periods of time, unplug it from the wall outlet. This will prevent damage to the projector due to lightning and AC power-line surges.

1.3 Protection on Servicing



WARNING: Attempts to alter the factory-set internal controls or to change other control settings not specially discussed in this manual can lead to permanent damage to the Unit and cancellation of the warranty

Servicing

Do not attempt to service the installed modules yourself, as opening or removing covers may expose you to dangerous voltage potential and risk of electric shock! Refer all projector service to a qualified service center.

Call for service in the following conditions :

- When the power cord or plug is damaged or frayed.
- If liquid has been spilled into the modules.
- If the product has been exposed to rain or water.
- If the product does not operate normally when the operating instructions are followed. Adjust only those controls that are covered by the operating instructions since improper adjustment of the other controls may result in damage and will often require extensive work by a qualified technician to restore the product to normal operation;
- If the product has been dropped or the cabinet has been damaged;
- If the product exhibits a distinct change in performance, indicating a need for service.

Replacement Parts

When replacement parts are required, be sure the service technician has used original Barco replacement parts or authorized replacement parts which have the same characteristics as the Barco original part. Unauthorized substitutions may result in degraded performance and reliability, fire, electric shock or other hazards. Unauthorized substitutions may void warranty.

Safety Check

Upon completion of any service or repairs to these modules, ask the service technician to perform safety checks to determine that the modules are in proper operating condition.

Protection

Please do not disassemble or modify LCD module to avoid the possibility of electric shock, damage of electronic components, scratch at display surface and invasion of foreign particles. In addition, such activity may result in fire accident due to burning of electronic component. LCD module disassembled or modified by customer is out of warranty.

Please be careful in handling of display with broken glass. When the display glass breaks, please pay attention not to injure your fingers. The display surface has the plastic film attached, which prevents dispersion of glass pieces, however touching broken edge will injure your fingers. Also Lamp (Cold Cathode Fluorescent Lamp) is made of glass, therefore please pay attention in the same way.

Please do not touch the fluid flown out of broken display glass. If the fluid should stick to hand or clothes, wipe off with soap or alcohol immediately and then wash it with water. If the fluid should get in eyes, wash eyes immediately with pure water for more than 15 minutes and then consult the doctor.

Lamp contains mercury inside. Please follow regulations or rules established by local autonomy at its disposal.

1.4 Safety on Cleaning

Cabinet

Unplug this product from the wall outlet before cleaning. Do not use liquid cleaners or aerosol cleaners. Use a damp cloth for cleaning.

To keep the cabinet looking brand-new, periodically clean it with a soft cloth. Stubborn stains may be removed with a cloth lightly dampened with mild detergent solution. Never use strong solvents, such as thinner or benzine, or abrasive cleaners, since these will damage the cabinet.

Display surface

Contamination of display surface. When display surface of LCD module is contaminated, please wipe the surface softly with cotton swab or clean cloth. If it is not enough, please take it away with cellophane tape or wipe the surface with cotton swab or clean cloth containing benzine. In this case, please be careful so that benzine does not get in inside of LCD module, because it may be damaged.

Water drop on LCD surface. Please do not leave LCD module with water drop. When the display surface gets water drop, please wipe it off with cotton swab or soft cloth immediately, otherwise display surface will be deteriorated. If water gets in inside of LCD module, circuit may be damaged.

1.5 Safety on Shipping

Original Shipping package

Save the original shipping packing material; they will come in handy if you ever have to ship one of your installed modules. For maximum protection, repack your set as it was originally packed at the factory.

1.6 On installation site

Transportation

- Any transportation of the unopened unit in its packaging should be done by two persons.
- In transportation or storage of products in original packing, NEVER stack more than the number stated on the carton box. This warning is also indicated on the side of the carton.
- For transportation or storage, observe the warnings and instructions on the side of the carton.

Nearby equipment

If air conditioning ducts or lamps, etc. are located near the installation site, the attendant dust, extreme temperatures, humidity, and condensation may become sources of trouble. Please take sufficient steps to avoid this.

Safety locations

Do not install the unit where it may be easily touched or leaned against. Avoid locations subject to high vibrations or severe impacts.

Mechanical stress. Please be careful not to apply strong mechanical stress like drop or shock to LCD module. Such stress may cause break of display glass and Lamp or may be the cause for failure.

Pressure to display surface. Please be careful not to apply strong pressure to display surface. Such pressure may cause scratches at surface or may be the cause of failure.

Protection against scratch. Please be careful not to hit, press or rub the display surface with hard material like tools. In addition, please do not put heavy or hard material on display surface, and do not stack LCD modules. Polarizer at front surface can be easily scratched.

Temperature dependence of display. Response speed (optical response) of LCD display is dependent on temperature. Under low temperature, response speed is slower. Also brightness and chromaticity change slightly depending on temperature.

Remaining of image

Displaying the same pattern for long time may cause remaining of image even after changing the pattern. This is not a failure but will disappear with time.

Lightning conditions

- Consider existing lightning and sunlight angles when creating the installation layout. Extremely bright lightning can reduce the visibility and the quality of the displayed image.
- In extremely bright surroundings, adjusting screen intensity may not result in perceptibly brighter images. Keep in mind that extreme intensity settings can reduce system service life.

Installation partially outdoors

The unit is designed for indoor use, and is not suited for open-air use. Installation in locations that are even partially exposed to the elements may lead to malfunctions or breakdown caused by any of the following:

- Water and dust
- Changes in temperature and humidity
- Salt-bearing wind

2. PACKAGING AND DIMENSIONS

Overview

- Box content
- Packaging
- Dimensions

2.1 Box content

Content

Standard delivered for :

R9004120

- 1 Solaris LC40 (weight : 24.5 kg)
- 2 power cables with outlet plug type CEE7 and ANSI 73.11
- 1 owners manual
- 1 remote control
- 1 video input

R9004125

- 1 Solaris LC40 (weight : 24.5 kg)
- 2 power cables with outlet plug type CEE7 and ANSI 73.11
- 1 owners manual



CEE7

European power plug to connect the power cord to the wall outlet.



ANSI 73.11

American power plug to connect the power cord to the wall outlet.

2.2 Packaging

Way of Packaging

The Solaris LC40 is packed in a carton box. To provide protection during transportation, the Solaris LC40 is surrounded with foam. The packaging is secured with banding and fastening clips.

To unpack

1. Release the fastening clips.
2. Remove the banding.
3. Take the Solaris LC40 out of its shipping carton.



Save the original shipping carton and packing material, they will be necessary if you ever have to ship your panel. For maximum protection, repack your panel as it was originally packed at the factory.

2.3 Dimensions

Front view

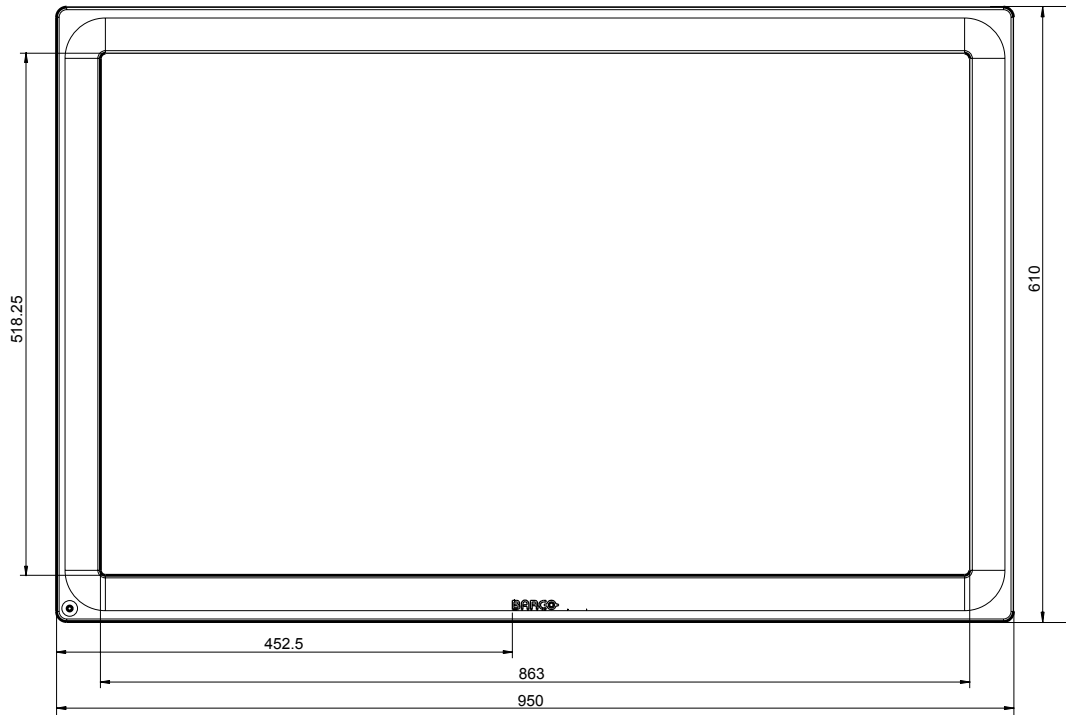

Image 2-1
Front view

Back view

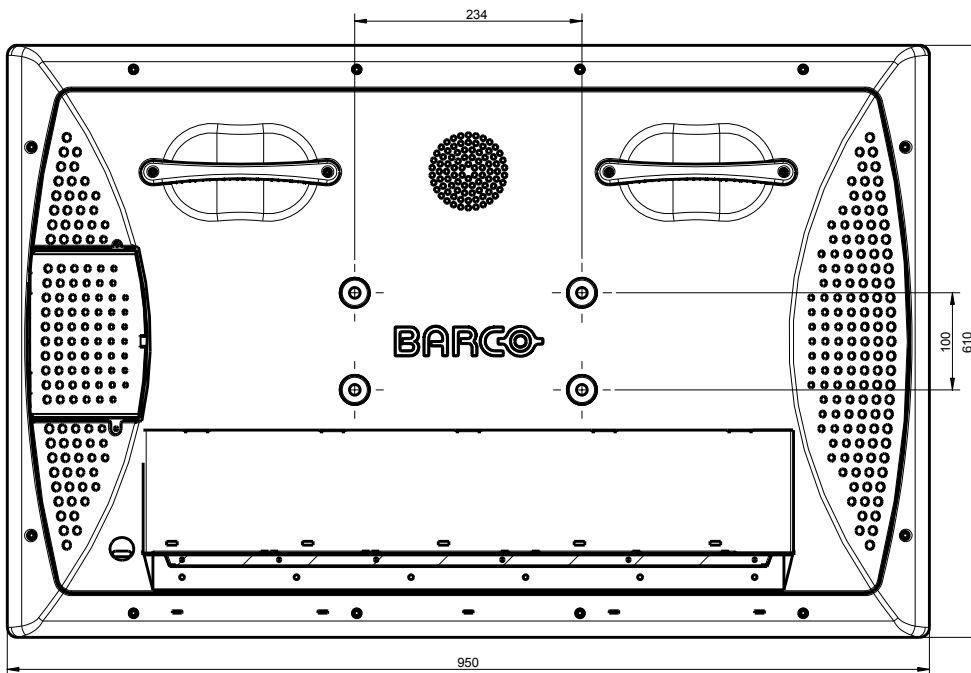

Image 2-2
Back view

Bottom view

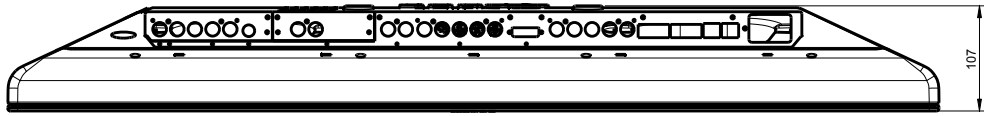

Image 2-3
Bottom view

3. INSTALLATION GUIDELINES

Overview

- General
- Solaris LC40 configurations
- Battery Insertion in the Remote Control

3.1 General

Environmental conditions

- Operating temperature : 5° to 40°C (41° to 104°F)
- Humidity : max 85%

3.2 Solaris LC40 configurations

Different configurations

The Solaris LC40 can be used in two different configurations, landscape and portrait.

The portrait configuration is only possible with the optional Rotator module (order number : **R9842362**)

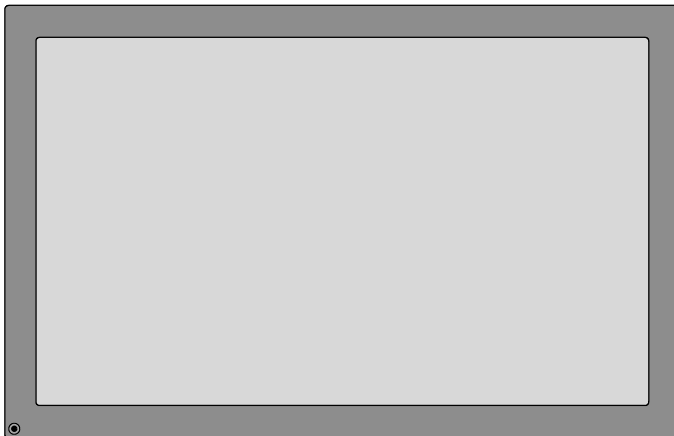

Image 3-1
Landscape configuration

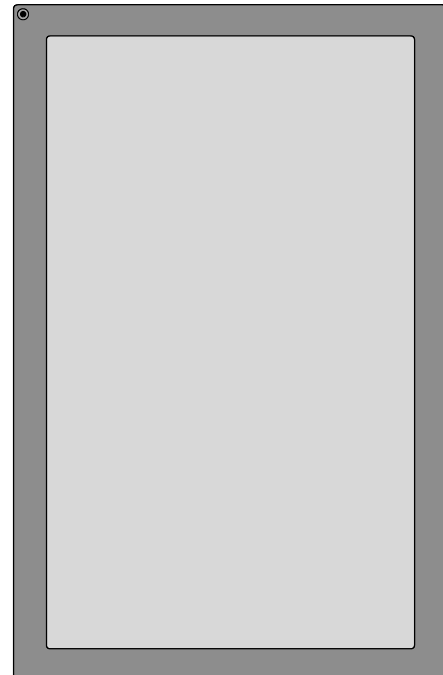

Image 3-2
Portrait configuration

When using in landscape, the infra red receiver must be in the lower left corner.

When using in portrait, the infra red receiver must be in the upper left corner.

Applications

The Solaris LC40 can be used as stand alone display or as part of a network of displays.

3.3 Battery Insertion in the Remote Control

Where to find the batteries

The batteries are not placed in the remote control to avoid remote control operation in its package, resulting in a shorter battery life time.

How to install the batteries

1. Push the cover tab (A) with the fingernail a little backwards and pull upwards the cover top (B). (image 3-3)
2. Slide the cover forwards to remove. (image 3-4)
3. Push the battery body towards the spring and lift it up to remove. (image 3-5)
4. Insert two AA size batteries, making sure the polarities match the + and – marks inside the battery compartment (image 3-5).
5. Insert the lower tab of the battery cover in the gap at the bottom of the remote control, and press the cover until it clicks in place (image 3-4).



Image 3-3
Battery cover unlock



Image 3-4
Battery cover removal



Image 3-5
Battery removal

4. CONNECTIONS

Overview

- Power connection
- Input source connections
- RGB out at native screen resolution (WXGA)
- Communication Connections
- Cable cover

4.1 Power connection

AC power (mains) cord connection

Use the supplied power cord to connect your LCD panel to the wall outlet.

Plug the female power connector into the male connector at the back of the LCD panel.



The power input is auto-ranging from 90 to 240 VAC.

4.2 Input source connections

Overview

- Input facilities
- Digital Visual Interface (DVI) input
- RGB analog input
- Serial Digital Interface
- Compact PC module
- Video input module
- DVI input module (optional)
- HD-SDI input module (optional)
- RGB input module (optional)
- Audio pré-amp input (optional)

4.2.1 Input facilities

Input panel view

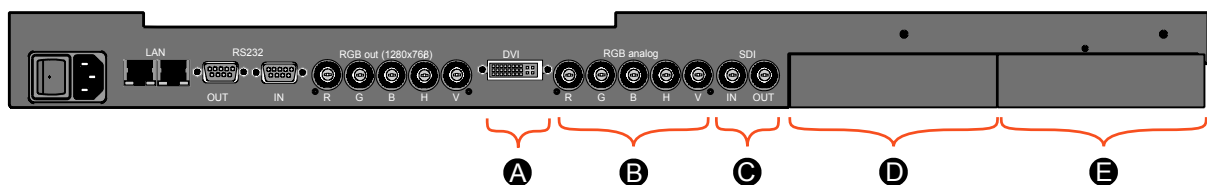

Image 4-1
Input panel view

Overview standard available inputs

Ref	Input connector	Source
A	DVI	DVI digital DVI analog

4. Connections

Ref	Input connector	Source
B	RGB analog (BNC)	RGB
C	SDI	SDI

Overview optional inputs

Ref	Input slot	Input module	Source
D	Universal input for data sources	DVI input	DVI digital DVI analog
		RGB input	RGB
		HD-SDI input	HD-SDI
		Audio input	Audio in (L + R), audio out (L + R + Subwoofer)
E	Video sources	Video input	Video S-Video Component video RGB Video (15 kHz)

4.2.2 Digital Visual Interface (DVI) input



DVI

Digital Visual Interface is a display interface developed in response to the proliferation of digital flat panel displays.

The digital video connectivity standard that was developed by DDWG (Digital Display Work Group). This connection standard offers two different connectors: one with 24 pins that handles digital video signals only, and one with 29 pins that handles both digital and analog video. This standard uses TMDS (Transition Minimized Differential Signal) from Silicon Image and DDC (Display Data Channel) from VESA (Video Electronics Standards Association).

DVI can be single or dual link.

Input specifications

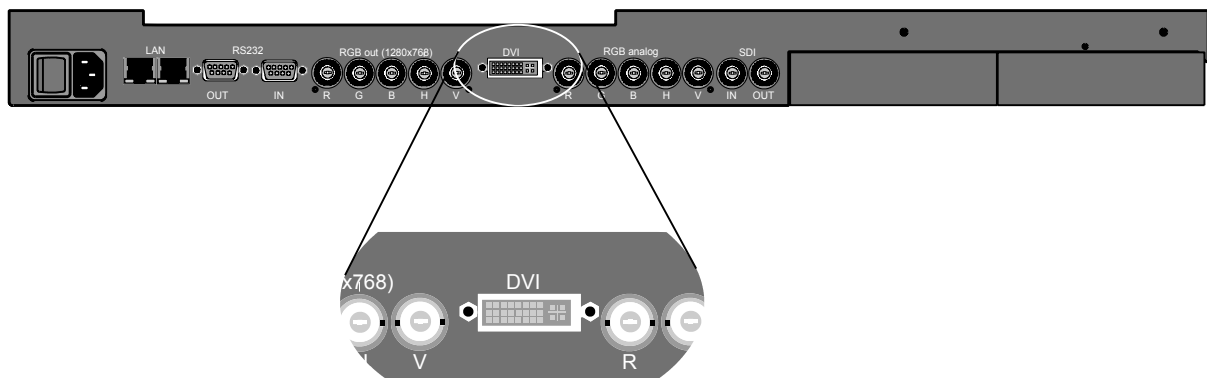

Image 4-2
Standard DVI input

Pixel clock : 25 .. 165 MHz

Horizontal sync range : 15 .. 110 kHz

Vertical sync range : 23 .. 125 Hz

Max. input format : UXGA (1600x1200) @ 60 Hz

DVI-Digital

- Single link
- Differential input voltage : 200mV - 800mV

DVI-Analog

- RGB input = $0.7 V_{pp} \pm 3dB$
- TTL sync input : $U_{min} = 2.5V$

Pin assignment for the DVI connector.

Pin 1	TMDS DATA2-	Pin 15	Ground (for +5V)
Pin 2	TMDS DATA2+	Pin 16	Hot Plug Detect
Pin 3	TMDS DATA2/4 Shield	Pin 17	TMDS DATA0-
Pin 4	TMDS DATA4-	Pin 18	TMDS DATA0+
Pin 5	TMDS DATA4+	Pin 19	TMDS DATA0/5 Shield
Pin 6	DDC Clock	Pin 20	TMDS DATA5-
Pin 7	DDC Data	Pin 21	TMDS DATA5+
Pin 8	Analog Vert sync	Pin 22	TMDS Clock Shield
Pin 9	TMDS DATA1-	Pin 23	TMDS Clock+
Pin 10	TMDS DATA1+	Pin 24	TMDS Clock-
Pin 11	TMDS DATA1/3 Shield	C1	Analog Red
Pin 12	TMDS DATA3-	C2	Analog Green
Pin 13	TMDS DATA3+	C3	Analog Blue
Pin 14	+5 Power	C4	Analog Hor Sync
		C5	Ground

How to select the DVI input via the RCU?

1. Press **7** on the RCU.

The internal system detects automatically the DVI source. If at the same time a digital DVI and analog DVI source is connected and switched on, the digital DVI source will be displayed.

How to select the DVI input via the menu structure?

1. Press on the thumb wheel or press **ENTER** on the RCU to activate the menus.

The main menu will be displayed on the screen. (menu 4-1)

2. Turn the thumb wheel or use the up or down arrow keys to select *Input selection*.

The input selection menu will be displayed. (menu 4-2)

3. Turn the thumb wheel or use the up or down arrow keys to select **7 DVI**.

4. Press the thumb wheel or press **ENTER** on the RCU.

The internal system detects automatically the DVI source. If at the same time a digital DVI and analog DVI source is connected and switched on, the digital DVI source will be displayed.

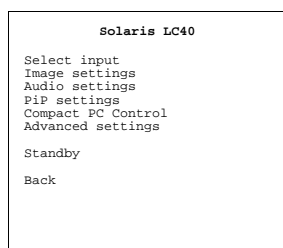

Menu 4-1

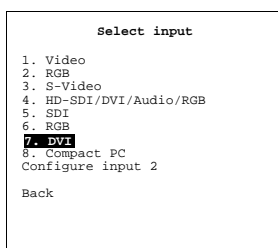

Menu 4-2

4.2.3 RGB analog input

Input specifications

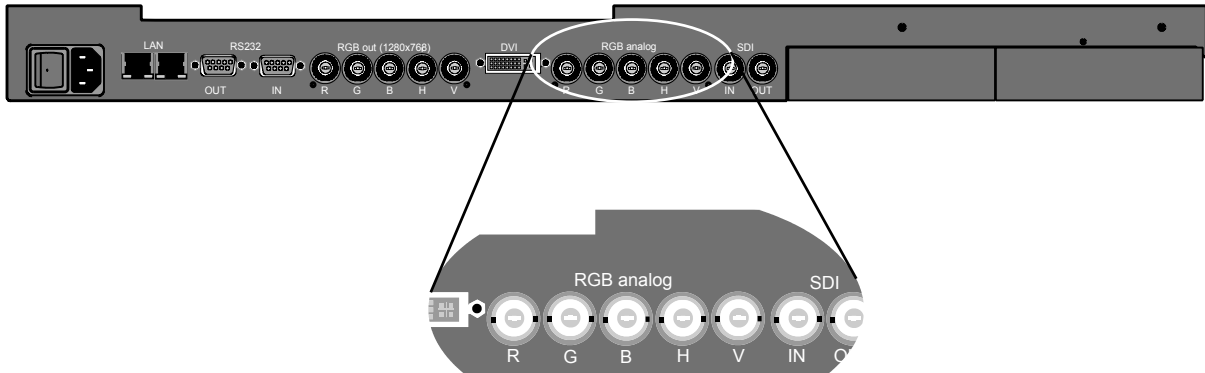

Image 4-3
RGB analog input

- Pixel clock : 20 .. 165 MHz
- Horizontal sync range : 15 .. 110 kHz
- Vertical sync range : 23 Hz .. 125 Hz
- Max input format : UXGA (1600x1200) @ 60 Hz
- RGBHV inputs : 0.7V_{pp} ±3 dB

Possible input sources

		Inputs				
		R	G	B	H	V
RGB inputs	RGBHV	R	G	B	H	V
	RGBS	R	G	B	S	-
	RG _s B	R	G _s	B	-	-

How to select the RGB source via the RCU?

1. Press **6** on the RCU.
The system scans the RGB analog input for a RGB input signal and detects automatically the sync.

How to select the RGB source via the menu structure

1. Press on the thumb wheel or press **ENTER** on the RCU to activate the menus.
The main menu will be displayed on the screen. (menu 4-3)
2. Turn the thumb wheel or use the up or down arrow keys to select *Input selection*.
The input selection menu will be displayed. (menu 4-4)
3. Turn the thumb wheel or use the up or down arrow keys to select **6 RGB**.
4. Press the thumb wheel or press **ENTER** on the RCU.
The internal system detects automatically the sync position (separate sync or sync on green).

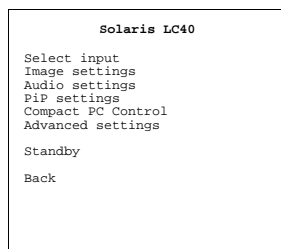

Menu 4-3

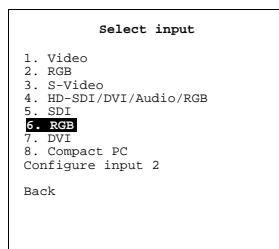

Menu 4-4

4.2.4 Serial Digital Interface

Specifications

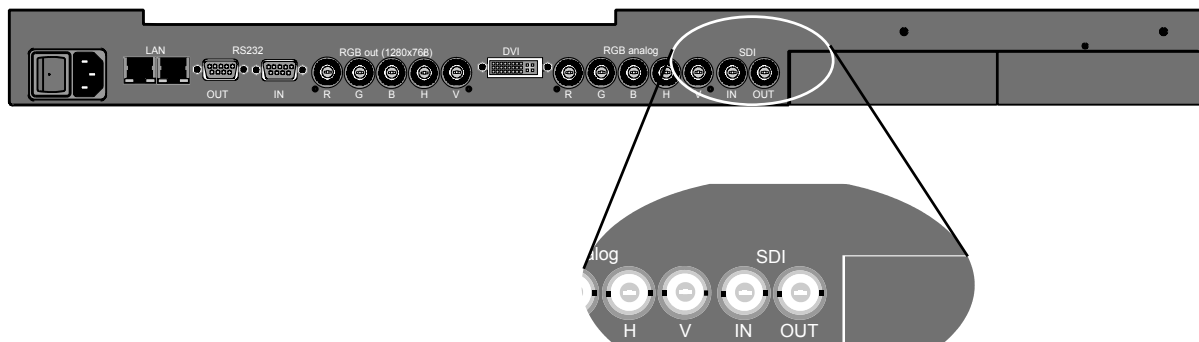

Image 4-4
SDI input

SMPT259M compatible serial digital signals only.

SDI input : BNC

SDI output : BNC (= loop through)

Typical : 0.8 V_{pp}

75 Ω terminated

Output impedance : 75 Ω

How to select the SDI input with the RCU?

1. Press **5** on the RCU

How to select the SDI input via the menu structure?

1. Press on the thumb wheel or press **ENTER** on the RCU to activate the menus.
The main menu will be displayed on the screen. (menu 4-5)
2. Turn the thumb wheel or use the up or down arrow keys to select *Input selection*.
The input selection menu will be displayed. (menu 4-6)
3. Turn the thumb wheel or use the up or down arrow keys to select **5 SDI**.
4. Press the thumb wheel or press **ENTER** on the RCU.

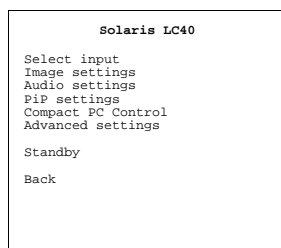

Menu 4-5

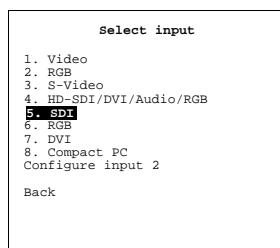

Menu 4-6

4.2.5 Compact PC module

Overview

The compact PC module is internally connected display. No external source connections are necessary. When input 8 is selected, the compact PC image will be displayed on the screen.



This input slot is NOT hot-pluggable. Make sure the system is switched off before inserting or removing a Compact PC module!

How to select with the RCU.

1. Press **8** on the RCU

How to select the Compact PC via the menu structure?

1. Press on the thumb wheel or press **ENTER** on the RCU to activate the menus.
The main menu will be displayed on the screen. (menu 4-7)
2. Turn the thumb wheel or use the up or down arrow keys to select *Input selection*.
The input selection menu will be displayed. (menu 4-8)
3. Turn the thumb wheel or use the up or down arrow keys to select **8 Compact PC**.
4. Press the thumb wheel or press **ENTER** on the RCU.

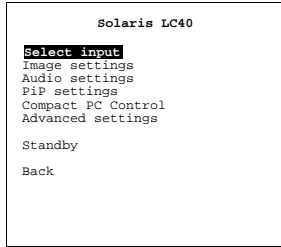

Menu 4-7

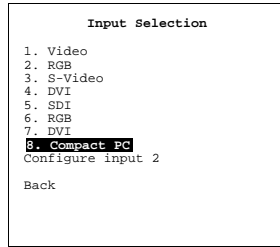

Menu 4-8

4.2.6 Video input module



This input slot is NOT hot-pluggable. Make sure the system is switched off before inserting or removing an input module!

Specifications

PAL B, G, D, H, I and N, combination PAL N, PAL M, NTSC M, NTSC-Japan, NTSC 4.43 and SECAM

Video : 1 V_{pp} ± 3dB

S-Video : Y= 1 V_{pp} ± 3dB, C = 300mV_{pp}

C_rY_cbHV inputs : -0.5V_{pp} to 0.5V_{pp}

Possible inputs

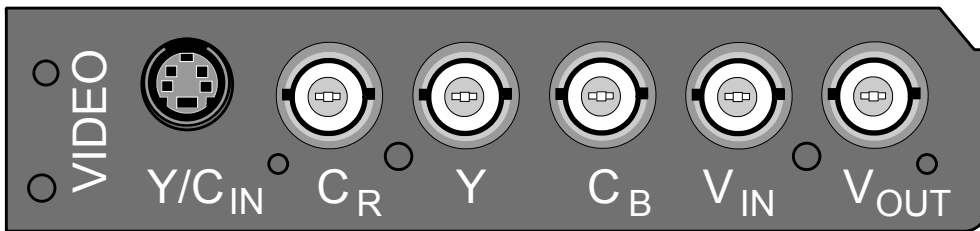

Image 4-5
Video input module

		Inputs					
		Y/C _{in}	C _r	Y	C _b	V _{in}	V _{out}
RGB inputs (15 kHz)	RGBS	-	R	G	B	S	-
	RG _s B	-	R	G _s	B	-	-
Component inputs	C _r Y _c bS	-	C _r	Y	C _b	S	-
	C _r Y _s C _b	-	Cr	Y _s	Cb	-	-

Video	Composite Video	-	-	-	-	Video	-
S-Video	S-Video	S-Video	-	-	-	-	-

Pin configuration 4 pin connector

View on input module :

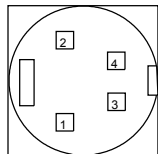

Image 4-6

For S-Video

- pin 1 : earth (ground) luminance
- pin 2 : earth (ground) chrominance
- pin 3 : luminance signal (Y) 1Vpp ±3dB
- pin 4 : chrominance signal (C) 300mVpp

For Video

- pin 1 : earth (ground) video Y
- pin 2 : earth (ground) video C
- pin 3 : video Y signal
- pin 4 : video C signal



Chrominance

The color component of a video signal that includes information about tint and saturation.



Luminance

The component of a video signal that includes information about its brightness.

How to configure the input 2

1. Press on the thumb wheel or press **ENTER** on the RCU to activate the menus.
The main menu will be displayed on the screen. (menu 4-9)
2. Turn the thumb wheel or use the up or down arrow keys to select *Input Selection*.
The input selection menu will be displayed. (menu 4-10)
3. Turn the thumb wheel or use the up or down arrow keys to select *Configure input 2*.
The configuration window will be displayed. (menu 4-11)
4. Turn the thumb wheel or use the up or down arrow keys to select the corresponding input.

YUV C_rY_sC_b source

SYUV C_rYC_bS source

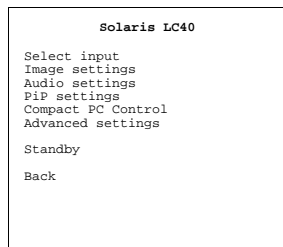

Menu 4-9

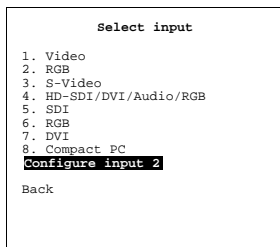

Menu 4-10

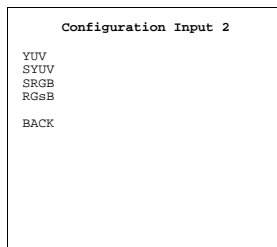

Menu 4-11

How to select an input via the RCU

1. For video : press **1** on the RCU.
For Component/RGB input : press **2** on the RCU.

4. Connections

For S-Video : press **3** on the RCU.

How to select an input via the menu structure

1. Press on the thumb wheel or press **ENTER** on the RCU to activate the menus.

The main menu will be displayed on the screen. (menu 4-12)

2. Turn the thumb wheel or use the up or down arrow keys to select *Input selection*.

The input selection menu will be displayed. (menu 4-13)

3. Turn the thumb wheel or use the up or down arrow keys to select the corresponding input (Video or S-Video or Component).
4. Press the thumb wheel or press **ENTER** on the RCU.

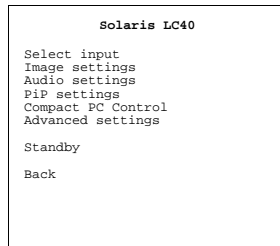

Menu 4-12

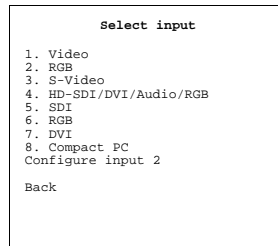

Menu 4-13

Loop through connection for Video

The composite video input (V_{in}) is connected in loop through with the V_{out} . This signal can be used to connect to the next device.

4.2.7 DVI input module (optional)



This input slot is NOT hot-pluggable. Make sure the system is switched off before inserting or removing an input module!

Specifications

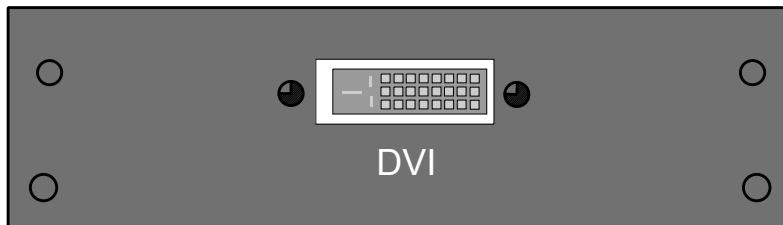

Image 4-7

As this module has the same specifications as the standard DVI input, "Digital Visual Interface (DVI) input", page 14 for the further specifications.



The optional input is automatically detected by the system and correctly filled out in the menu structure.

How to select with the RCU.

1. Press **4** on the RCU

How to select the DVI input via the menu structure?

1. Press on the thumb wheel or press **ENTER** on the RCU to activate the menus.

The main menu will be displayed on the screen. (menu 4-14)

2. Turn the thumb wheel or use the up or down arrow keys to select *Input selection*.

The input selection menu will be displayed. The correct input will be filled out immediately in input selection 4. (menu 4-15)

3. Turn the thumb wheel or use the up or down arrow keys to select **4 DVI**.

- Press the thumb wheel or press **ENTER** on the RCU.

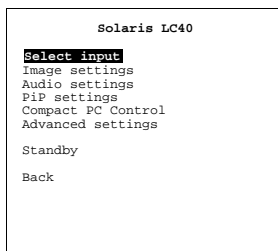

Menu 4-14

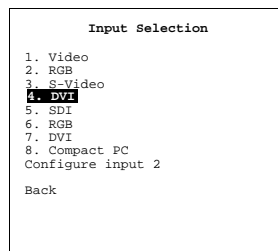

Menu 4-15

4.2.8 HD-SDI input module (optional)



This input slot is **NOT** hot-pluggable. Make sure the system is switched off before inserting or removing an input module!

Specifications

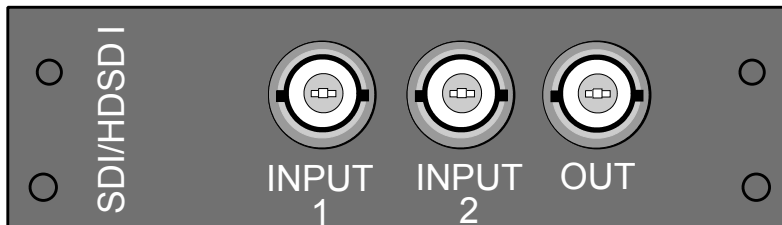

Image 4-8
HD-SDI input module

SDI/HD-SDI input 1: BNC

SDI/HD-SDI input 2: BNC

Auto input detection between input 1 and input 2

SDI/HD-SDI output : BNC (= loop through)

Typical : 0.8 V_{pp}

75 Ω terminated

Output impedance : 75 Ω

How to configure the HD-SDI input

- Press the thumb wheel or press **ENTER** on the RCU to activate the menus.
The main menu will be displayed on the screen. (menu 4-16)
- Turn the thumb wheel or use the up or down arrow keys to select *Input Selection*.
The input selection menu will be displayed. (menu 4-17)
- Turn the thumb wheel or use the up or down arrow keys to select *Configure HD-SDI*.
The configuration window will be displayed. Depending on a previous setting, two different view are possible. (menu 4-18)
- To set the selection automatic, select *Automatic select* and press **ENTER** to toggle to [Yes]. (menu 4-20)
- Select *Priority* and press **ENTER** to toggle between [input 1] and [input 2].
When two input signals are connected, the one set in Select input will have priority.
- To set the selection on non automatic, select *Automatic Select* and press **ENTER** to toggle to [No]. (menu 4-21)
- Select *Select input* and press **ENTER** to toggle between [input 1] and [input 2].

4. Connections

Only the signal on the selected input will be displayed.

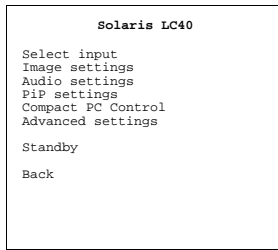

Menu 4-16

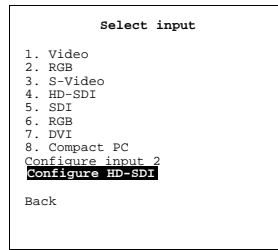

Menu 4-17

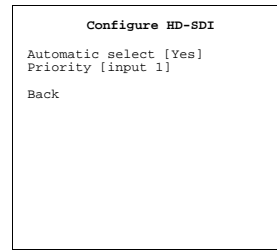

Menu 4-18

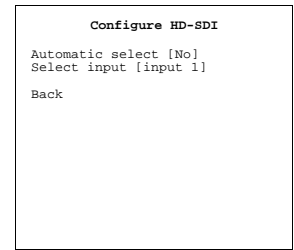

Menu 4-19

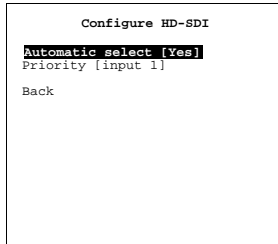

Menu 4-20

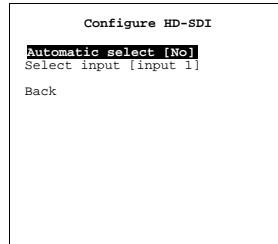

Menu 4-21

How to select with the RCU.

1. Press **4** on the RCU

How to select the SDI/HD-SDI input via the menu structure?

1. Press on the thumb wheel or press **ENTER** on the RCU to activate the menus.

The main menu will be displayed on the screen. (menu 4-22)

2. Turn the thumb wheel or use the up or down arrow keys to select *Input selection*.

The input selection menu will be displayed. The correct input will be filled out immediately in input selection 4. (menu 4-23)

3. Turn the thumb wheel or use the up or down arrow keys to select **4 HD-SDI**.
4. Press the thumb wheel or press **ENTER** on the RCU.

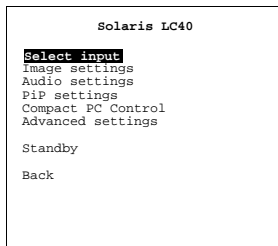

Menu 4-22

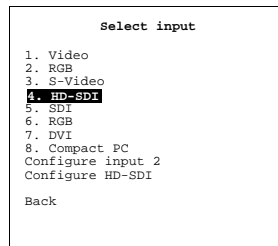

Menu 4-23

4.2.9 RGB input module (optional)



This input slot is **NOT** hot-pluggable. Make sure the system is switched off before inserting or removing an input module!

Specifications

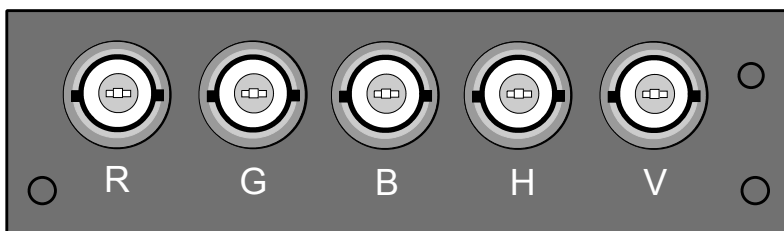

Image 4-9

RGBHV inputs : $0.7V_{pp} \pm 3$ dB

How to select with the RCU.

1. Press **4** on the RCU

How to select the RGB input via the menu structure?

1. Press on the thumb wheel or press **ENTER** on the RCU to activate the menus.

The main menu will be displayed on the screen. (menu 4-24)

2. Turn the thumb wheel or use the up or down arrow keys to select *Input selection*.

The input selection menu will be displayed. The correct input will be filled out immediately in input selection 4. (menu 4-25)

3. Turn the thumb wheel or use the up or down arrow keys to select **4 RGB**.
4. Press the thumb wheel or press **ENTER** on the RCU.

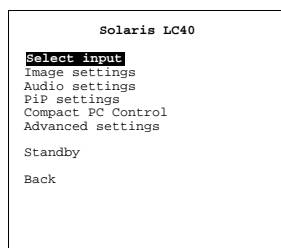

Menu 4-24

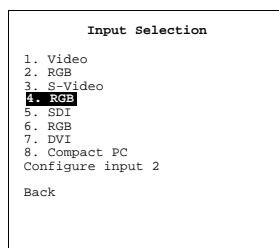

Menu 4-25

4.2.10 Audio pré-amp input (optional)



This input slot is **NOT** hot-pluggable. Make sure the system is switched off before inserting or removing an input module!

Specifications

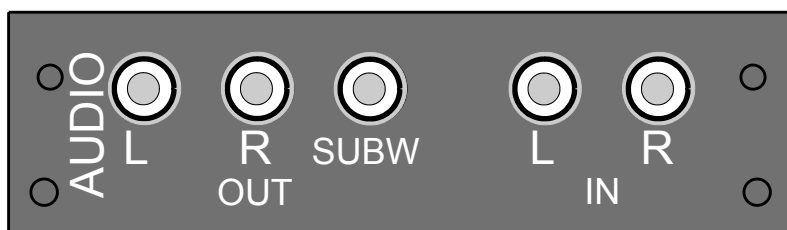
Image 4-10
Audio input

Left and right input channel : maximum $2.5V_{pp}$

Input Left-Right impedance : 50 k Ω

Left and right output : maximum $2.5V_{pp}$

Output Left-Right impedance : 1 k Ω

Output subwoofer impedance : 1 k Ω

4. Connections

Adjustment steps :

- Treble / bass : from -14dB to +14dB, steps of 2dB
- Balance : from -79dB to 0dB, steps of 1dB
- Volume adjustable in steps of 0.5dB
- Subwoofer out in steps of 1dB

Output specifications

Left and right output channel + subwoofer channel.

Use of the audio pré-amp module

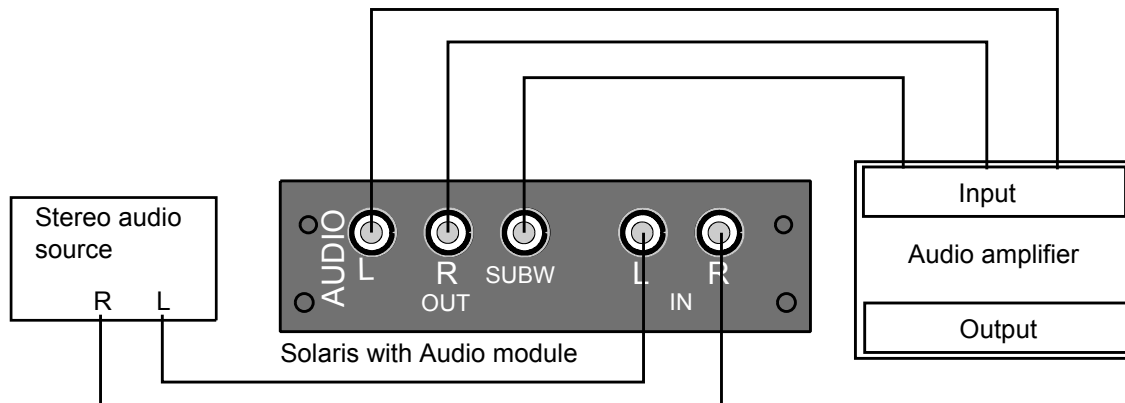

Image 4-11
Principle drawing use of audio pré-amp module

The Solaris audio module must be mounted between the audio source (DVD player, video source,...) and the audio destination (audio amplifier, active speakers ...). In this configuration, the user can control both video and audio parameters from one place (the Solaris OSD menu or any other control device attached to the Solaris serial port).



This module is NOT an audio amplifier.

4.3 RGB out at native screen resolution (WXGA)

Output

The processed signal, rotated or not rotated is available in screen format for loop through to the next Solaris LC40.

Be aware of the rotation setting of the next Solaris LC40. When the output is already rotated, do not rotate the input image again in the next Solaris LC40.

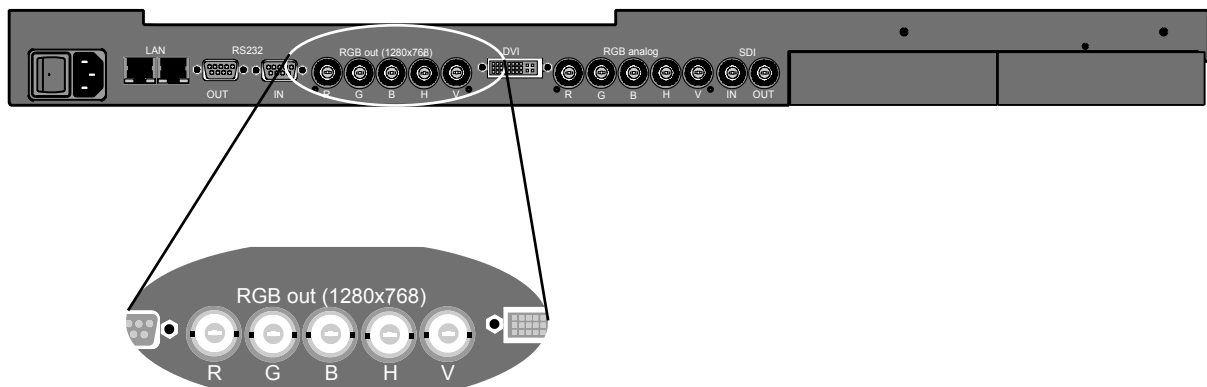

Image 4-12
RGB out on panel resolution



Although this is a standard analog RGBHV output, it is only meant to be used by another Solaris displays. The output signals are not CRT-compatible, so they may not display correctly on a standard monitor

4.4 Communication Connections

4.4.1 RS232 IN/OUT

What can be connected to the RS232 IN connection ?

The RS232 IN connection allows the Solaris LC40 to communicate with a computer e.g. IBM PC or Apple Macintosh.

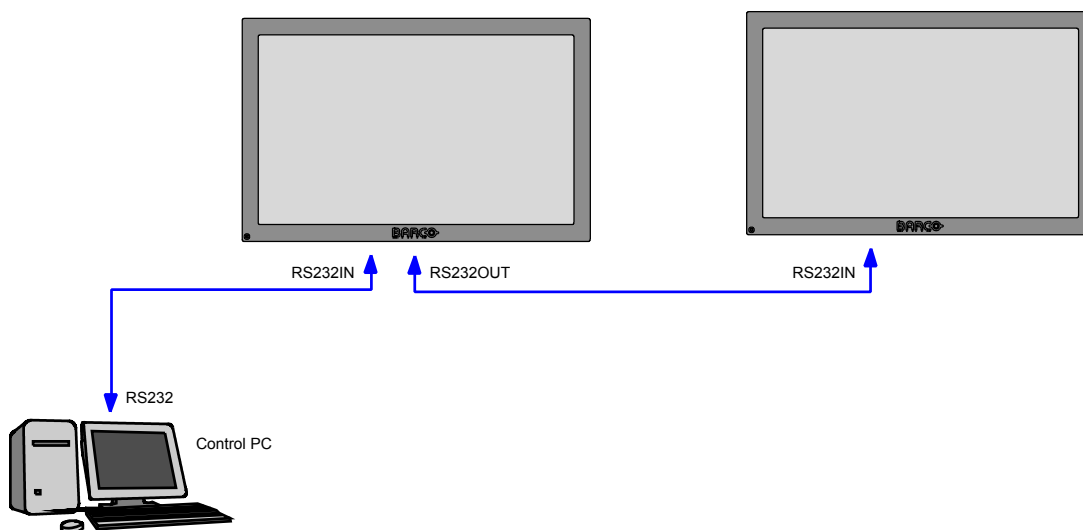

Image 4-13
RS232 connection

Applications of the RS232 connection

Remote control:

- easy adjustment of LCD panel via IBM PC (or compatible) or MAC connection.
- RS232 address range from 0 to 255.
- allow storage of multiple LCD panel configurations and set ups.
- wide range of control possibilities.

RS232 OUT

To make a loop through connection with other Solaris LC40's.

4.5 Cable cover

Why cable cover

With the cable cover, all connections are protected to be disconnected.

Mounting the cable cover.

1. Slide the cover over the connections.
2. Push the cover hooks into the holes. (image 4-14)
3. Slide the cover to the right.
4. Fix this position by turning in the screw on the left side.

4. Connections

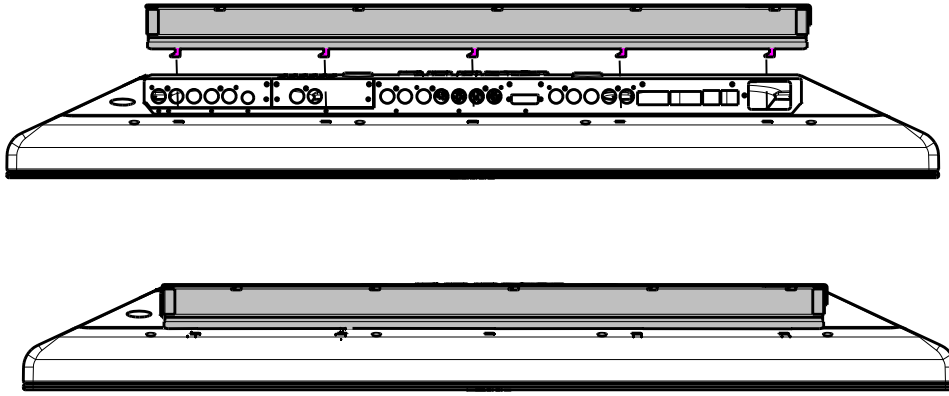

Image 4-14
Mounting cable cover

5. GETTING STARTED

Overview

- Terminology overview RCU
- Switching ON/OFF
- Using the RCU
- LCD panel address
- Locking the Solaris LC40 for IR signals
- Quick access to Picture in Picture

5.1 Terminology overview RCU

Overview

The following table gives an overview of the different functionalities of the keys on the RCU.

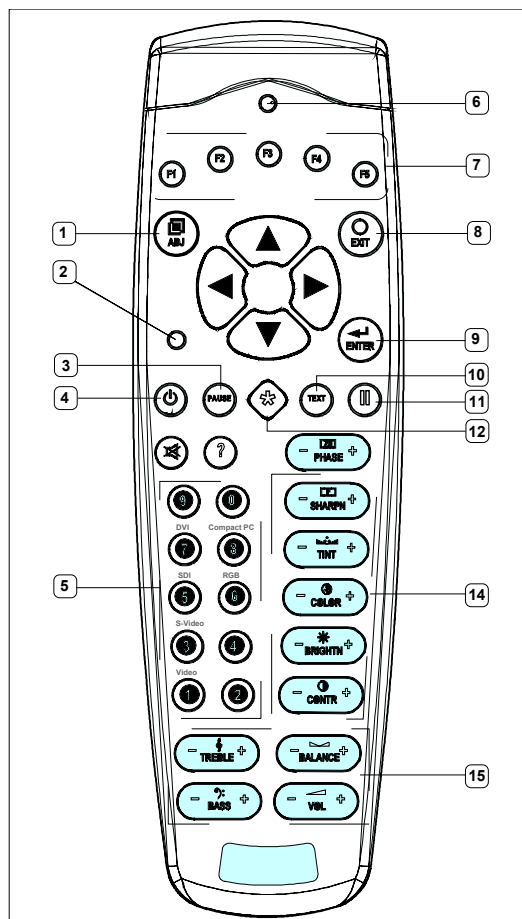

Image 5-1
RCU

Controls function description

Ref.	Function	Description
1	Adjust button	To enter the adjustment menus or the leave the adjustment menus.
2	Address button	To match the Remote Control with the Solaris LC40 that you are addressing (number between 0 and 9).
3	Pause button	To blank the image.
4	Standby button	To power up/down the Solaris LC40.

Ref.	Function	Description
5	Digit buttons	Allows to directly select sources. <ul style="list-style-type: none"> • 0. No source • 1. Video • 2. configurable input 2 • 3. S-Video • 4. Optional input • 5. SDI • 6. RGB • 7. DVI • 8. Compact PC • 9. Prefix for PiP source selection
6	RC operation indication	Lights up when a button on the remote control is pressed (Visual indication of remote control operation – Battery check).
7	Function keys	The function keys are reserved for picture in picture (PiP) functionality. F1 : PiP left corner bottom F2 : PiP left corner top F3 : Split screen F4 : PiP right corner top F5 : PiP right corner bottom
8	EXIT button	To go up one step in the menu structure.
9	ENTER button	To enter the adjustment menus or to confirm an adjustment with the adjustment menus.
10	TEXT	When text is on, press TEXT to switch off OSD display. Press TEXT again, OSD appears as defined in the OSD configuration window.
11	FREEZE	Press to freeze the image
12	* Button	Aspect ratio toggle button for the actual image
13	Picture controls	Allow to optimize the picture reproduction

Table 5-1

5.2 Switching ON/OFF

Main power up

1. When the Solaris LC40 was switched off when it was in standby, it will start up in standby. Continue with the standby procedure.
2. When the Solaris LC40 was displaying an image when switched off, it will start on the same source as it was playing on.

From standby to a real image with the RCU

1. Press the standby key, the same source will be displayed as before the Solaris LC40 went in standby
 Or,
 press the digit number of the source you want to display.

From standby to a real image with the thumb wheel

1. Press once on the thumb wheel, the same source will be displayed as before the Solaris LC40 went in standby.

Switching to Standby with the RCU

1. Press the standby button on the RCU.
 The last used source will be stored to start up on that source.

Switching to Standby with the thumb wheel

1. Press the thumb wheel once.
 The main menu will be displayed. (menu 5-1)

- Turn the thumb wheel to scroll through the menu and select *Standby*.
- Press the thumb wheel.

The display goes in standby.

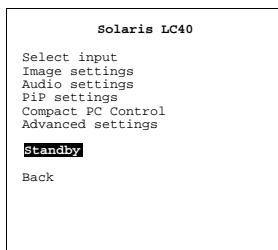

Menu 5-1

Power off

- The display is showing an image. Switch off with the main switch.
The last used source will be stored to start up on that source when switching on.
- Go first to standby and then switch off with the main switch.
The Solaris LC40 will always start up in standby.

5.3 Using the RCU

Pointing to the IR sensor.

- When using the wireless remote control, make sure you are within the effective operating distance (30m, 100ft in a straight line).
The remote control unit will not function properly if strong light strikes the sensor window or if there are obstacles between the remote control unit and the Solaris LC40 IR sensor. (image 5-2)

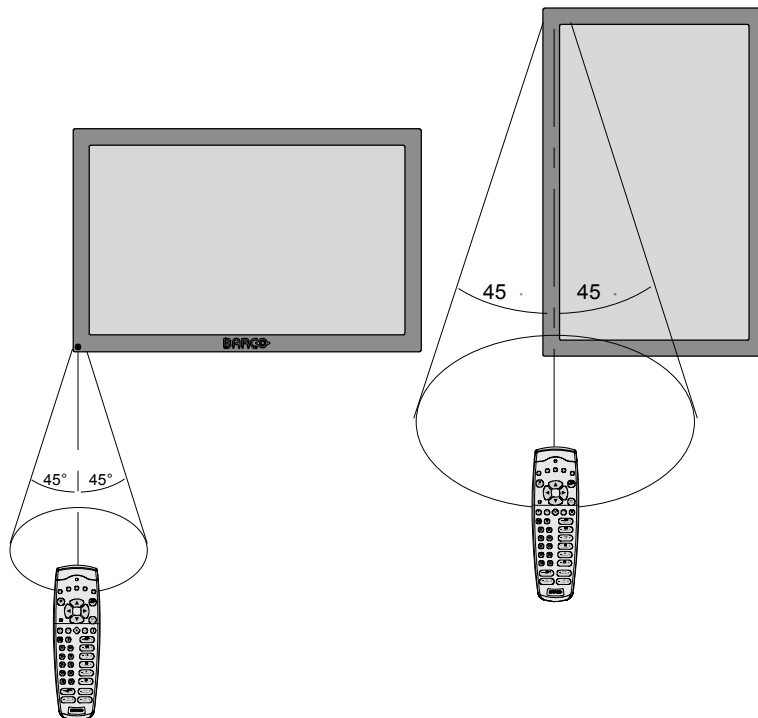

Image 5-2
IR angle

5.4 LCD panel address

Overview

- IR address
- Displaying and Programming IR addresses into the RCU
- RS232 address
- Controlling the Solaris LC40 with the RCU

5.4.1 IR address

Why a IR address ?

As more than one Solaris LC40 can be installed in a room, the separate Solaris LC40 should be separately addressable with an RCU. Therefore each Solaris LC40 has its own address.

Set up an individual IR Address.

The set up of a LCD panel IR address can be done via the software.

Solaris LC40 controlling.

Every Solaris LC40 requires an individual address between 0 and 9 which can be set in the *Service* menu.

When the address is set, the Solaris LC40 can be controlled by the remote control:



If it is necessary to control a specific LCD panel, then enter the LCD panel address into the RCU (only when that address is between 0 and 9). The Solaris LC40 with the corresponding address will listen to that specific RCU.

5.4.2 Displaying and Programming IR addresses into the RCU

Displaying the LCD panel IR Address on the Screen.

1. Press the **Address** key (recessed key on the RCU) with a pencil.

The Solaris LC40's address will be displayed in a 'Text box'



To continue using the RCU with that specific address, it is necessary to enter the same address with the digit buttons (address between 0 and 9) within 5 seconds after pushing the address key. For example : if the Address key displays LCD panel IR address 003, then press "3" digit button on the RCU to set the RCU's address to match the LCD panel's IR address. Do not press 0-0-3 . This will address the remote control to '0' and control all LCD panels in the room. If the address is not entered within 5 seconds, the RCU returns to its default address (zero address) and controls then all LCD panels in the room.

5.4.3 RS232 address

Why a RS232 address ?

As the Solaris LC40 can be controlled by a computer, the separate Solaris LC40 should be separately addressable. Therefore each Solaris LC40 has its own address.

Set up an individual RS232 Address.

The set up of a LCD panel RS232 address can be done via the software.

Solaris LC40 controlling.

Every Solaris LC40 requires an individual address between 0 and 255 which can be set in the *Service* menu.

When the address is set, the Solaris LC40 can be controlled by a computer:

5.4.4 Controlling the Solaris LC40 with the RCU

Input Selection

Key in the corresponding slot number with the digit keys on the RCU. The selected source will be displayed.

Picture Controls

When an image control is pressed, a text box with a bar scale, icon and function name of the control, e.g. 'brightness...' appears on the screen (only if *OSD* is ON). The length of the bar scale and the value of the numeric indication indicate the current memorized setting for this source. The bar scale changes as the arrows on the RCU are pressed.

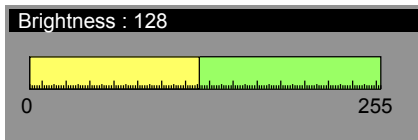

Image 5-3
Brightness setting

The picture settings are saved in the image file.

Brightness	Use the + button for a higher brightness. Use the - button for a lower brightness.
Contrast	Use the + button for a higher contrast. Use the - button for lower contrast.
Color	Use the + button for richer colors. Use the - button for lighter colors.
Tint (Hue)	Tint is only active for Video and S-Video when using the NTSC 4.43 or NTSC 3.58 system. Use the + button Use the - button.
Sharpness	Use the + button for a sharper picture. Use the - button for a softer picture.
Phase	Use the + or - button to adjust the phase.
Freeze	Press Freeze to freeze the displayed image.

Audio Controls

When an audio control is pressed, a text box with a bar scale, icon and function name of the control, e.g. 'volume...' appears on the screen (only if *OSD* is ON). The length of the bar scale and the value of the numeric indication indicate the current memorized setting for this source. The bar scale changes as the arrows on the RCU are pressed.

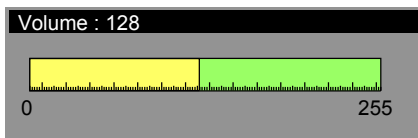

Image 5-4
Volume control

The audio settings are saved in the image file.

Volume	Volume control adjusts the volume. Use the + button for a higher volume. Use the - button for a lower volume.
Bass	Bass control adjusts the bass level (low tones). Use the + button for more low tones. Use the - button for less low tones.

5. Getting Started

Treble	Treble control adjusts the treble level (high tones). Use the + button for more high tones. Use the - button for less high tones.
Balance	Is only effective if a external amplifier with loudspeakers is connected to the audio output. The balance control adjust the sound level between the left and the right box. Use the + button for a higher sound level on the right box than on the left one. Use the - button for a higher sound level on the left box than on the right one.

The Pause Key

When the Pause key is pressed, the display is blanked.

To redisplay the image:

- Press **PAUSE** key

5.5 Locking the Solaris LC40 for IR signals

What is possible ?

The Solaris LC40 can be locked for any IR signal. When locked, IR signals send to the display will be ignored by the display. Unlocking is possible via the remote control by entering a 4 digit PIN code. The default factory PIN code is "0000".

This default PIN code or any other entered PIN code can be changed at anytime, see "Changing your PIN code", page 80

How to lock ?

1. Press **ENTER** on the RCU or press the thumb wheel once.

The main menu will be displayed. (menu 5-2)

2. Select *Service* and press **ENTER** or the thumb wheel.

The service menu will be displayed. (menu 5-3)

3. Select *IR locking* and press **ENTER**.

The *IR locking* menu will be displayed. (menu 5-4)

4. Select *Locking [off]* and press **ENTER** to toggle to [on].

As you cannot use the back button anymore, the menu will disappear after a few seconds.

Your display is locked for IR signals.

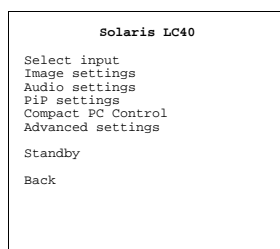

Menu 5-2

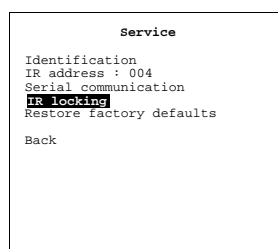

Menu 5-3

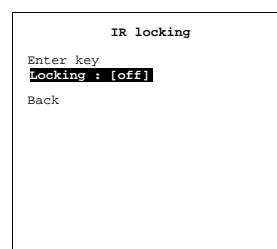

Menu 5-4

How to unlock ?

1. Point your RCU to the display and enter the 4 digit PIN code with the digit keys on the RCU.

When your PIN code is correct, all functions are accessible.

5.6 Quick access to Picture in Picture

Quick PiP source selection

Before selecting the source number (between 1 and 8) enter first 9, immediately followed by the source number.

E.g. to show source 4 in a PiP window, enter 94 with the digits on the RCU. The selected source will be displayed on the same place as it was previously displayed during previous PiP session.



A PiP source is always displayed in landscape.

Use of the function keys

When PiP is active, the following function are available when the key is pressed:

F1 first time	PiP window in left bottom corner. Small version.
F2 second time	PiP window in left bottom corner. Enlarged version.
F2 first time	PiP window in left top corner. Small version.
F2 second time	PiP window in left top corner. Enlarged version.
F3 first time	Split screen. For a landscape display : PiP source left, master source right. For a portrait display : PiP source top, master source bottom.
F3 second time	Split screen. The position of the sources will be swapped.
F4 first time	PiP window in right top corner. Small version.
F4 second time	PiP window in right top corner. Enlarged version.
F5 first time	PiP window in right bottom corner. Small version.
F5 second time	PiP window in right bottom corner. Enlarged version.

6. GETTING USED TO THE MENU STRUCTURE

Overview

- How to start up the menus
- Using the menus
- Adjusting a control in a Slider box

6.1 How to start up the menus

Box menu structure

The Solaris LC40 has a box based menu structure with a parent - child relationship. When selecting an item in parent menu box (higher level) it opens a child menu box (lower level) in which you can make other selections or it activates an adjustment.

How to start up

1. Press **ENTER** or **ADJUST** on the RCU
Or,
press on the thumb wheel on the back side of the panel. (menu 6-1)

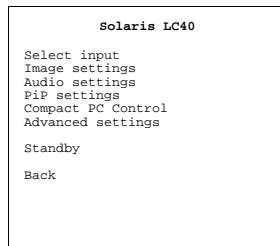

Menu 6-1

6.2 Using the menus

Layout

Non selectable items are grayed out in the menuboxes. When scrolling through the menu box content, the cursor jumps over the grayed out items.

Selecting an item

1. Use the up or down arrow keys on the RCU to select the desired item and press **ENTER** to select
Tip: When on the first item, push once on the up arrow key to select the last item in the list, or when on the last item (Back), push the down arrow key once again to select the first item.

Or,
turn the thumb wheel until the desired item is selected and press the thumb wheel.
Tip: When on the first item, turn the wheel left to arrive on the last item, or when on the last item (Back), turn the wheel a little further to arrive on the first item.

Go one level up

1. Press **EXIT**
Or,
select Back and press **ENTER** or press the thumb wheel.

Escape from the menus

1. Press **ADJUST** on the RCU.



The explanation of the menu structure in the next chapters will be done using the RCU. Of course, everything is possible with the thumb wheel.

6.3 Adjusting a control in a Slider box

Adjusting with normal speed.

1. Press the ↑ or ↓ keys to adjust a bar scale with normal speed. This adjustment is a fine adjustment.

The bar scale will move in the corresponding direction. (image 6-1)

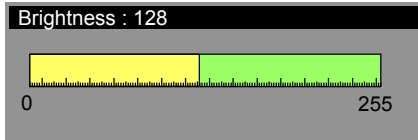

Image 6-1
Slider box adjustment

Short cuts for faster navigation in the slider box.

1. Press the digit keys 0 to 9 to make the slider setting jump to 0 to 90%.

E.g. pressing 5 jumps to the slider's center position.

This adjustment is a coarse adjustment and can be followed with a fine adjustment with the arrow keys.

7. INPUT SELECTION

Overview

- Start up the Input Selection
- Selecting an Input Source
- Configuring input 2
- Selecting Compact PC

7.1 Start up the Input Selection

Steps to be taken

1. Press **ENTER** or **ADJUST** to start up the menus. (menu 7-1)
2. Select *Select input*.
3. Press **ENTER**.

The *Select input* menu appears. (menu 7-2)

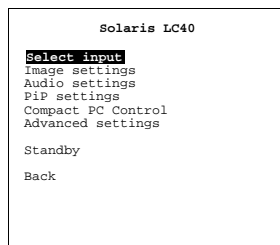

Menu 7-1

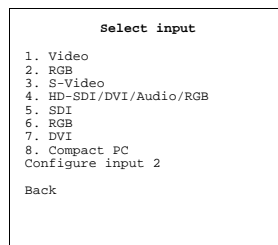

Menu 7-2

Remarks

When no module is inserted in the video input slot, line one indicate No module. There will be no indication next to line 2 and 3.

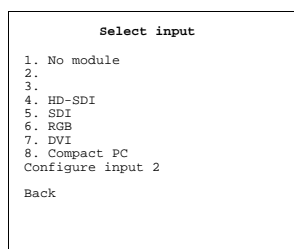

Menu 7-3

Line 4 will indicate the exact input name as the software detects itself the inserted input. The possibilities are : HD-SDI, DVI, RGB or Audio. When Audio is indicated in the menu, it will be grayed out as this is not an image source.

7.2 Selecting an Input Source

Steps to be taken

1. Scroll through the menu until the desired source is highlighted, e.g. SDI. (menu 7-4)
Note: *Input 2 can be configured depending on the input source.*

7. Input Selection

2. Press **ENTER** to select.

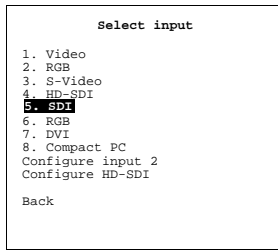

Menu 7-4

7.3 Configuring input 2

Steps to be taken

1. Select *Configure input 2* and press **ENTER**. (menu 7-5)
The configuration window will be displayed. (menu 7-6)
2. Select the corresponding input and press **ENTER**.

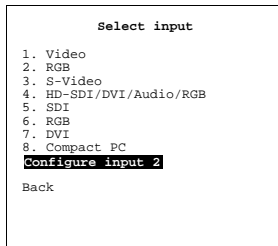

Menu 7-5

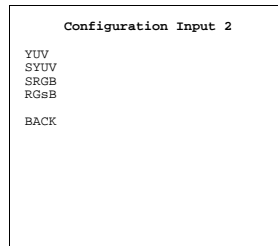

Menu 7-6

7.4 Selecting Compact PC

Overview

When Compact PC is selected, the content of the compact PC will be displayed on the display.

Custom applications running on this PC can now be displayed.

No external connection between the Compact PC and the Solaris LC40 is necessary except for the Ethernet connection when the internal hub is used. Source connections are connected internally by inserting the compact PC in its docking slot.

Steps to be taken

1. Select *Compact PC*. (menu 7-7)
2. Press **ENTER** to activate.
The compact PC content will be displayed.

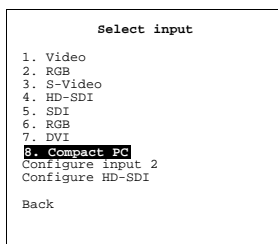

Menu 7-7



For further functionality of the Compact PC, see user manual of the Compact PC.



When no compact PC is inserted in the docking slot, a message *no signal* will be displayed and the display remains on input 8 until a new input is selected or the *When no signal* function activates.

8. IMAGE SETTINGS

Overview

- Image Settings Menu overview
- Aspect Ratio
- Brightness
- Contrast
- Color Saturation
- Tint (hue)
- Sharpness
- Viewport
- Phase

8.1 Image Settings Menu overview

Image settings menu

- Aspect ratio
 - 16/9
 - 15/9
 - 4/3
 - 4/3 zoom
 - Letterbox
 - Non linear
 - Horizontal shift
 - Horizontal size
 - Vertical shift
 - Vertical size
- Brightness
- Contrast
- Color saturation
- Tint
- Sharpness
- Viewport
- Phase

8.2 Aspect Ratio

What can be done ?

The aspect ratio setting forces the Solaris LC40 to display an image using a defined aspect ratio.

Aspect ratio	Description
16/9	Wide screen television format / anamorphic format, stretched format
15/9	Native display format
4/3	Standard television format
4/3 zoom	Standard television format enlarged
Letterbox	Standard television format including a 16 by 9 image format
Non linear	Smart stretched format.

How to change the aspect ratio?

1. Select *Image Settings*.

8. Image Settings

2. Press **ENTER** to select.
Image settings menu will be displayed (menu 8-1)
3. Select *Aspect ratio*.
4. Press **ENTER**.
The aspect ratio menu will be displayed. (menu 8-2)

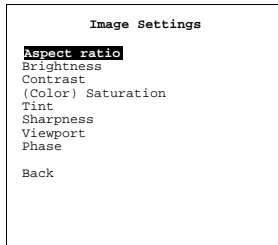

Menu 8-1

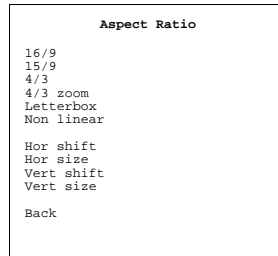

Menu 8-2

Shift and size of the image

Within the chosen aspect ratio (except for non linear), the image can be shifted vertically and horizontally or it can be resized in both directions.

Steps to be taken

1. Select the desired action.
2. Press **ENTER** to activate.
3. Use the arrow keys to execute the selected function.

8.3 Brightness

About Brightness

The brightness function is used to adjust the overall light output.

How to change the Brightness ?

1. Select *Image Settings*.
2. Press **ENTER** to select.
Image settings menu will be displayed (menu 8-3)
3. Select *Brightness*.
4. Press **ENTER** to activate.
A slider box appears.
5. Use the ↑ or ↓ to change the brightness.
The higher the value, the higher the brightness.

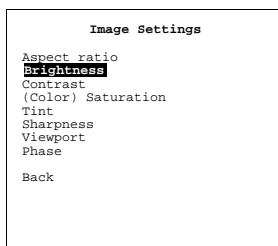

Menu 8-3

8.4 Contrast

About Contrast

The Contrast function is used to adjust the contrast between the light and dark areas of the displayed image.

How to change the Contrast ?

1. Select *Image Settings*.
2. Press **ENTER** to select.
Image settings menu will be displayed (menu 8-4)
3. Select *Contrast*.
4. Press **ENTER** to activate.
A slider box appears.
5. Use the ↑ or ↓ to change the contrast.
The higher the value, the higher the contrast.

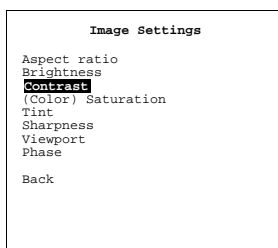

Menu 8-4

8.5 Color Saturation

About Color Saturation

The Color Saturation function is used to adjust color saturation levels.

How to change the Color Saturation ?

1. Select *Image Settings*.
2. Press **ENTER** to select.
Image settings menu will be displayed (menu 8-5)
3. Select *Color Saturation*.
4. Press **ENTER** to activate.
A slider box appears.
5. Use the ↑ or ↓ to change the Color Saturation.
The higher the value, the higher the color.

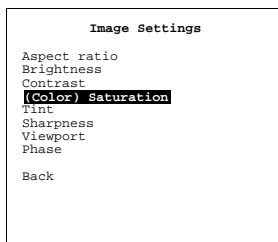

Menu 8-5

8.6 Tint (hue)

About Tint (hue)

The Tint function is used to adjust color hue to obtain true color reproduction and is only active for Video and S-Video when the NTSC color system is used. For PAL and SECAM sources, tint is not accessible.

How to change the Tint ?

1. Select *Image Settings*.
2. Press **ENTER** to select.
Image settings menu will be displayed (menu 8-6)
3. Select *Tint*.
4. Press **ENTER** to activate.
A slider box appears.
5. Use the ↑ or ↓ to change the Tint.
The higher the value, the higher the tint.



Menu 8-6

8.7 Sharpness

About Sharpness

The Sharpness function is used to adjust the image sharpness of video signals.

How to change the Sharpness ?

1. Select *Image Settings*.
2. Press **ENTER** to select.
Image settings menu will be displayed (menu 8-7)
3. Select *Sharpness*.
4. Press **ENTER** to activate.
A slider box appears.
5. Use the ↑ or ↓ to change the Sharpness.
The higher the value, the higher the sharpness.

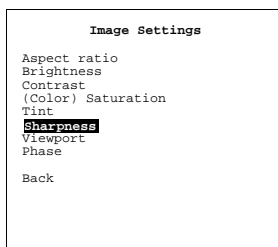

Menu 8-7

8.8 Viewport

Overview

- About Viewport
- Viewport creation
- Automatic Viewport function
- Total pixels setup

8.8.1 About Viewport

Overview

A viewport is a window on the input source. The source content will be cropped to the dimensions of that viewport window. The information in that window will be used for further signal processing.

A viewport is determined by its start position and its width and height.

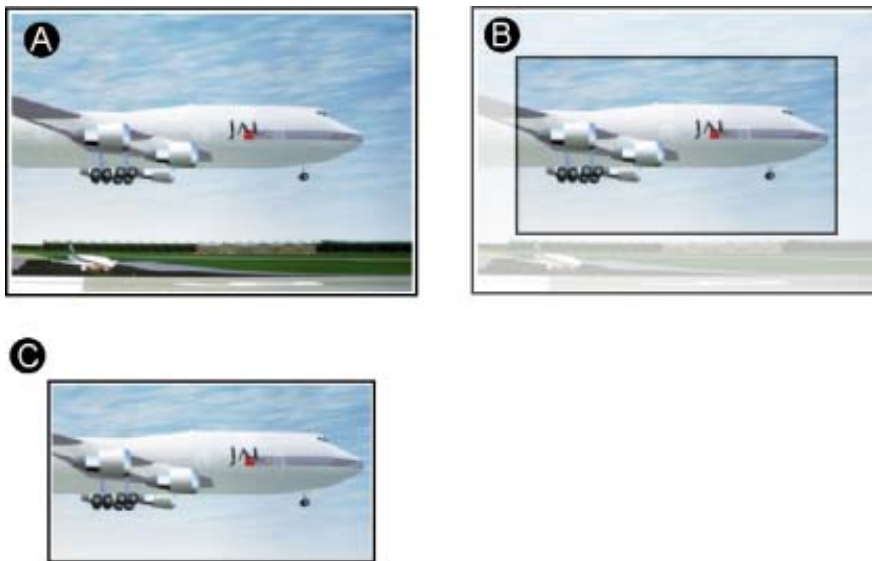

Image 8-1
Viewport

- A Input signal
- B Viewport creation
- C Cropped input signal at native resolution of display

8.8.2 Viewport creation

Start up of the viewport creation

1. Select *Image Settings*.
2. Press **ENTER** to select.
Image settings menu will be displayed. (menu 8-8)
3. Select *Viewport*.
4. Press **ENTER** to activate.

8. Image Settings

The Viewport menu will be displayed. (menu 8-9)

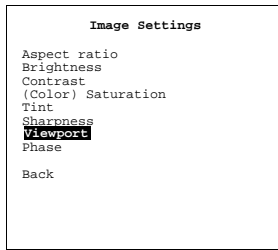

Menu 8-8

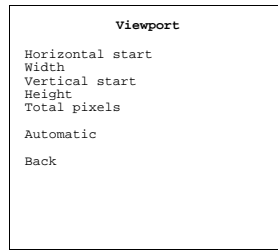

Menu 8-9

Different steps to create a viewport.

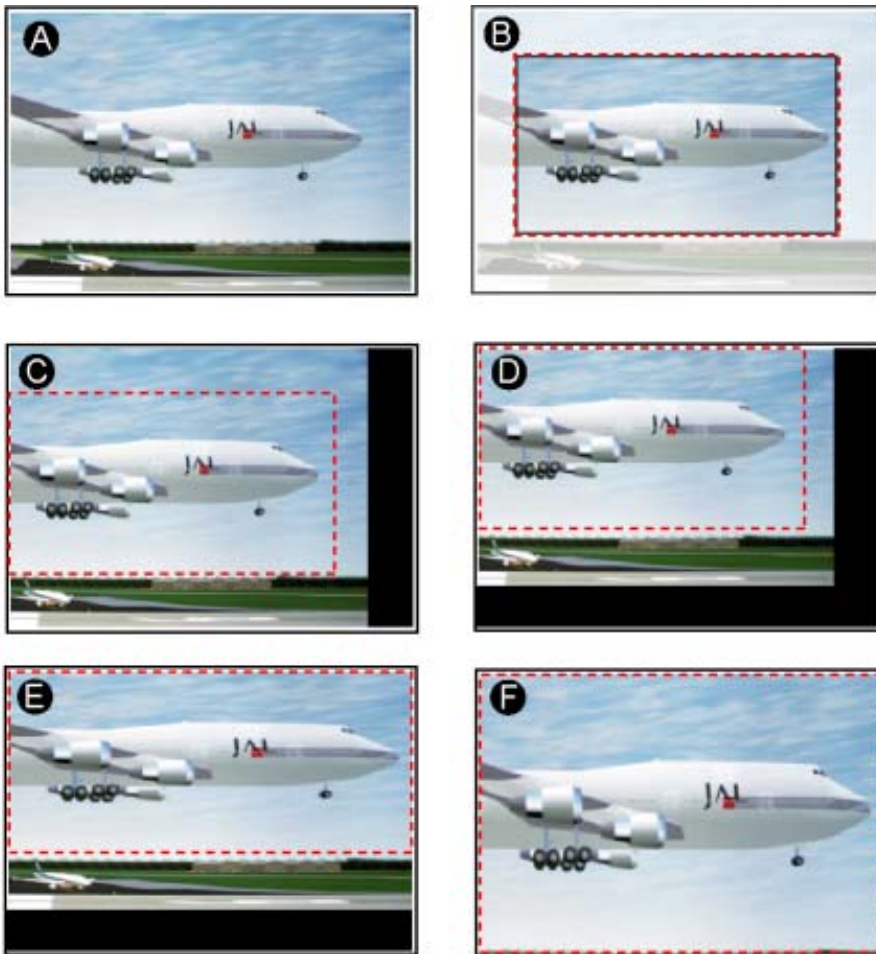

Image 8-2
Creation of a viewport, views on the screen while adjusting

- A Input signal
- B Desired image on the screen (viewport)
- C Horizontal start position
- D Vertical start position
- E Set up of viewport width
- F Set up of viewport height



Viewport creation only works correctly when the *total pixels* and *total lines* settings in the viewport menu are more or less correct: The other settings (Horizontal start, horizontal size, vertical start, vertical size) depend on these two settings. The software does not allow 'horizontal start' + 'horizontal size' to be larger than 'total pixels'. So, if the menu does not allow you to shift the image far enough, or set the image wide enough, it is very likely that the total amount of pixels is set too low. The same goes for the vertical parameters.

Creating a horizontal start position

1. Select *Horizontal start*. (menu 8-10)
2. Press **ENTER** to activate.

A slider bar will be displayed. The maximum indicated values are in pixels and depends on input source.

3. Use the \uparrow or \downarrow to set up the horizontal start position.

When set up the start position the image will move horizontally on the screen, see image 8-2 part C.

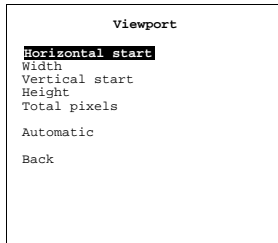

Menu 8-10

Creating a vertical start position

1. Select *Vertical start*. (menu 8-11)
2. Press **ENTER** to activate.

A slider bar will be displayed. The maximum indicated values are in lines and depends on input source.

3. Use the \uparrow or \downarrow to set up the vertical start position.

When set up the vertical start position the image will move vertically on the screen, see image 8-2 part D.

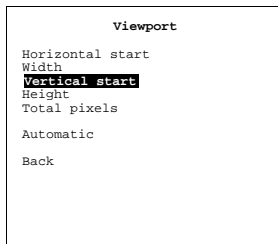

Menu 8-11

Creating the viewport width

1. Select *Width*. (menu 8-12)
2. Press **ENTER** to activate.

A slider bar will be displayed. The actual viewport setting will indicated.

3. Use the \uparrow or \downarrow to set up the width of the viewport.

When set up the width of viewport, the image will be rescaled to the width of the LCD panel, see image 8-2 part E.

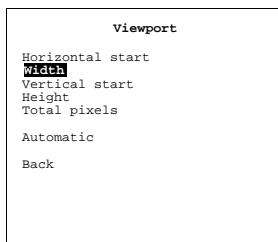

Menu 8-12

Creating the viewport height

1. Select *Height*. (menu 8-13)

8. Image Settings

2. Press **ENTER** to activate.

A slider bar will be displayed. The actual viewport setting will indicated.

3. Use the \uparrow or \downarrow to set up the height of the viewport.

When set up the height of viewport, the image will be rescaled to the height of the LCD panel, see image 8-2 part F.



Menu 8-13

8.8.3 Automatic Viewport function

About the Automatic function

When the automatic viewport function is selected, the reproduced image returns to the active area of the input signal.

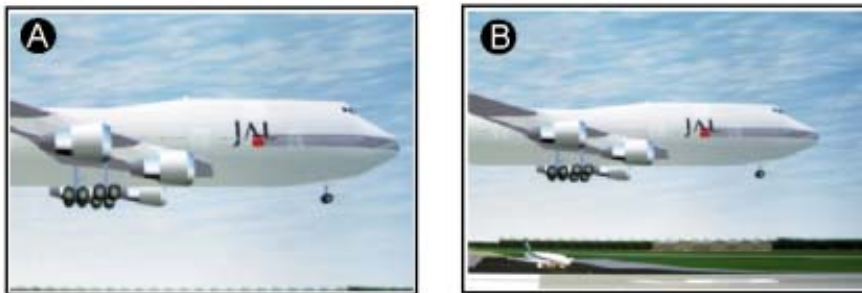

Image 8-3
Viewport automatic

- A Actual viewport image
- B Automatic viewport to active area



Automatic viewport detection only works correctly when the *total pixels* and *total lines* settings in the viewport menu are more or less correct: The other settings (Horizontal start, horizontal size, vertical start, vertical size) depend on these two settings. The software does not allow 'horizontal start' + 'horizontal size' to be larger than 'total pixels'. The same goes for the vertical parameters. So in the rare case the input source causes the wrong file to be selected, and that file happens to have a much too low setting for either of the two values 'total pixels' or 'total lines', the automatic viewport function will not function correctly, because it will be limited to the range in the 'total pixels' and 'total lines' values.

Steps to be taken

1. Select *Automatic*. (menu 8-14)
2. Press **ENTER** to activate.

A message will be displayed while the Solaris LC40 examines the input signal : "Detection busy".

The image jumps to the active area within the input signal.

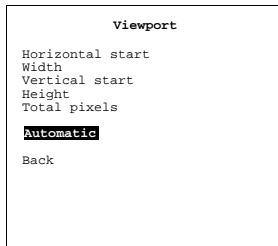

Menu 8-14

8.8.4 Total pixels setup

About total number of pixels

Enter the total number of pixels in regard with the total number of pixels in your source. When the total number of pixels is not correct (small differentiation), artifacts in the form of dark bars will be visible in the image. The more visible bars in the image, the more is the differentiation from the correct value.

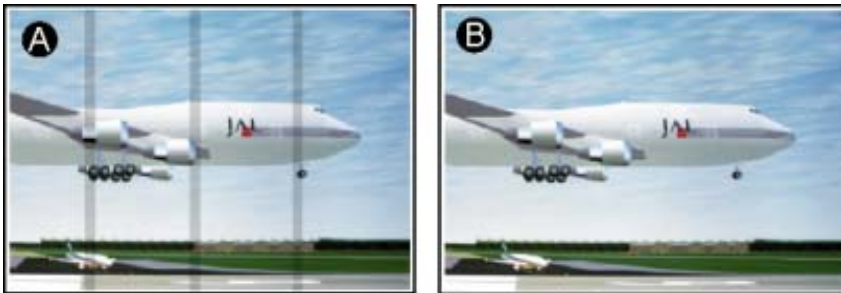
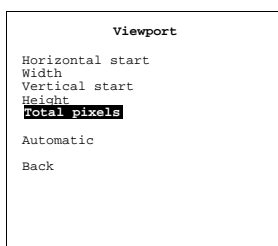

Image 8-4
Total number of pixels

- A Image with wrong total number of pixels
- B Correct adjusted image

How to set up

1. Select *Total pixels*. (menu 8-15)
2. Press **ENTER** to activate.
A slider bar will be displayed. The actual total pixel setting will indicated.
3. Use the ↑ or ↓ to set up the total pixels.



Menu 8-15

8.9 Phase

About Phase adjustment

When displaying computer patterns or graphics (RGB or YUV signals) which are very detailed (tilting, vertical stripes, etc.), jitter in picture (mis-sampling) may occur, causing horizontal stripes in portions of the screen. When this jitter occurs, adjust 'Phase' for optimum image.

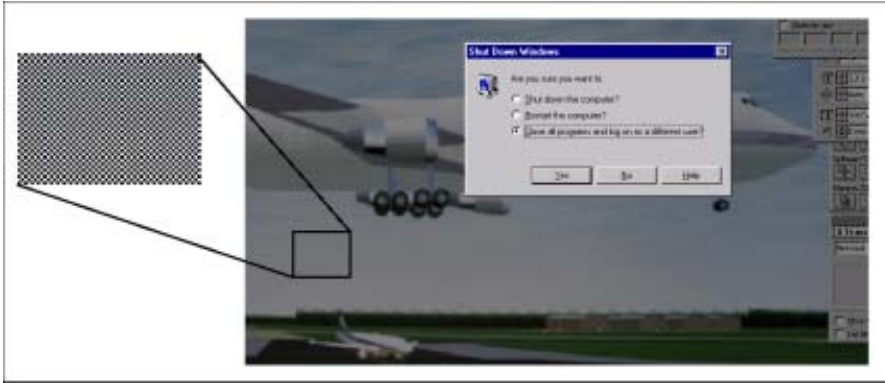

Image 8-5
Jittering on image

How to change the Phase ?

1. Select *Image Settings*.
2. Press **ENTER** to select.
Image settings menu will be displayed (menu 8-16)
3. Select *Phase*.
4. Press **ENTER** to activate.
A slider box appears.
5. Use the ↑ or ↓ to change the Phase and refine the jitter.
The higher the value, the higher the sharpness.



Menu 8-16

9. AUDIO SETTINGS

Overview

- Audio settings menu overview
- Starting up the audio controls
- Volume control
- Balance control
- Bass control
- Treble control
- Subwoofer control



Audio settings are only active when the Solaris LC40 is equipped with an audio pre-amplifier input board.

9.1 Audio settings menu overview

Overview

- Volume
- Balance
- Bass
- Treble
- Subwoofer

9.2 Starting up the audio controls

Steps to be taken

1. Press **ENTER** to enter the menu structure.
The main menu will be displayed. (menu 9-1)
2. Select *Audio settings*.
3. Press **ENTER** to activate.
The Audio settings menu will be displayed. (menu 9-2)

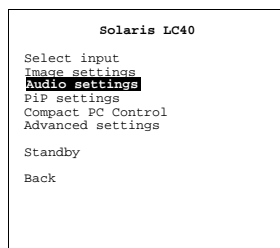

Menu 9-1

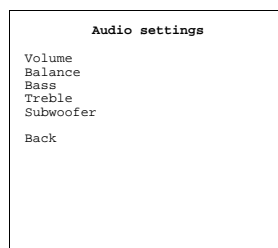

Menu 9-2

9.3 Volume control

Steps to be taken

1. Select *Volume* in the *Audio settings* menu. (menu 9-3)
2. Press **ENTER** to activate.

9. Audio Settings

A slider bar will be displayed.

3. Use the ↑ or ↓ to adjust the volume to the desired level.

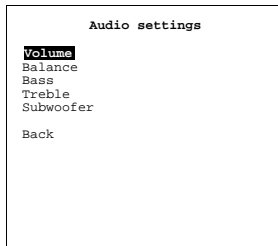

Menu 9-3

9.4 Balance control

Steps to be taken

1. Select *Balance* in the *Audio settings* menu. (menu 9-4)
2. Press **ENTER** to activate.

A slider bar will be displayed.

3. Use the ↑ or ↓ to adjust the balance of the audio output.

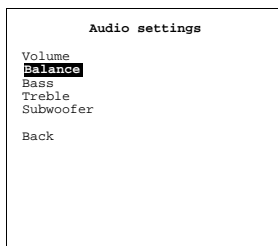

Menu 9-4

9.5 Bass control

Steps to be taken

1. Select *Bass* in the *Audio settings* menu. (menu 9-5)
2. Press **ENTER** to activate.

A slider bar will be displayed.

3. Use the ↑ or ↓ to adjust the bass (low tones) to the desired level.

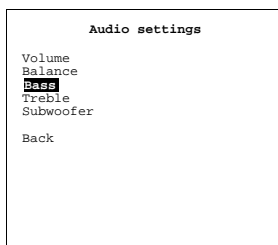

Menu 9-5

9.6 Treble control

Steps to be taken

1. Select *Treble* in the *Audio settings* menu. (menu 9-6)
2. Press **ENTER** to activate.
A slider bar will be displayed.
3. Use the ↑ or ↓ to adjust the treble (high tones) to the desired level.

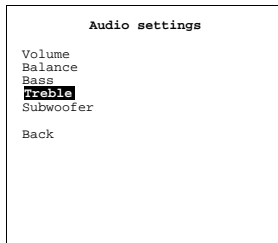

Menu 9-6

9.7 Subwoofer control

Steps to be taken

1. Select *Subwoofer* in the *Audio settings* menu. (menu 9-7)
2. Press **ENTER** to activate.
A slider bar will be displayed.
3. Use the ↑ or ↓ to adjust the subwoofer volume to the desired level.

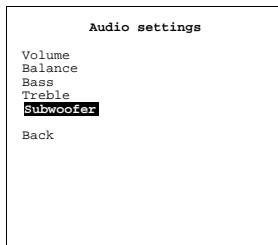

Menu 9-7

10. PIP SETTINGS

Overview

- Introduction to PiP
- Select PiP input
- PiP size
- PiP position

10.1 Introduction to PiP



PiP

PiP stands for "Picture in Picture" and allows to display multiple windows containing each of them an image. The windows may be of the video or data type.

What is possible ?

The Solaris LC40 allows to add one extra image (window) as picture in picture to the displayed image. This inserted image can be re-sized and repositioned on the screen.

The type of the inserted image depends on the type of the full image.

When the full image is e.g. a video source, only an insertion of non video source is possible.

10.2 Select PiP input

What can be done ?

The inserted image can be selected out of the list of available sources. The sources which cannot be selected depending the type of the master source are grayed out.

When no PiP is desired, select *no PiP source*.

How to select

1. Press **ENTER** or **ADJUST** to start up the menus. (menu 10-1)
2. Select *PiP settings*.
3. Press **ENTER** to select.

The *PiP settings* menu will be displayed. (menu 10-2)

4. Select *Select PiP input*.

5. Press **ENTER** to select

The *Select PiP input* window will be displayed. (menu 10-3)

Depending on the master source, some sources will be grayed out and are not selectable.

6. Select the desired PiP source.

The selected PiP source appears on the same place with the same settings as it was previously displayed during a previous PiP display.

When *No PiP source* is selected. PiP will be disabled.

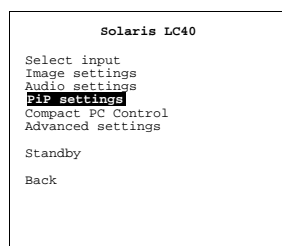

Menu 10-1

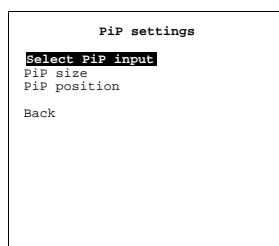

Menu 10-2

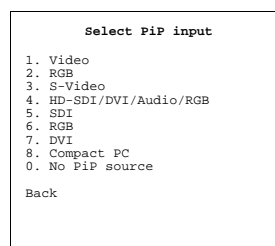

Menu 10-3

10.3 PiP size

What can be done ?

The size of the PiP window can be changed. That can be done proportionally in both directions or individually for width and height

Overview

- Scale
- Horizontal size
- Vertical size

10.3.1 Scale

How to scale

1. Press **ENTER** or **ADJUST** to start up the menus. (menu 10-4)
2. Select *PiP settings*.
3. Press **ENTER** to select.
The *PiP settings* menu will be displayed. (menu 10-5)
4. Select *PiP size*.
5. Press **ENTER** to select.
The *PiP size* menu will be displayed. (menu 10-6)
6. Select *Scale*.
7. Press **ENTER** to select.
8. Use the arrow keys to scale the PiP window.

The scaling will be done proportionally. The center of the window is fixed. The window be enlarged or reduced at the four corners at the same time. (image 10-1)

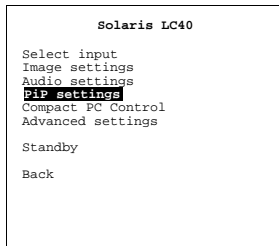

Menu 10-4

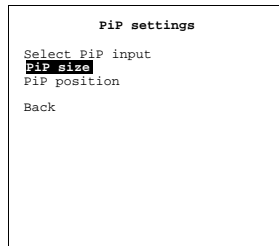

Menu 10-5

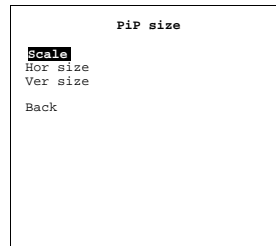

Menu 10-6



Image 10-1
Scaling PiP window



When the horizontal size or vertical size is extremely out of proportion and the scale is activated, the PiP window will be re-sized with an aspect ratio equal of those of the display (15:9).

10.3.2 Horizontal size

How to size horizontally

1. Press **ENTER** or **ADJUST** to start up the menus. (menu 10-7)
2. Select *PiP settings*.
3. Press **ENTER** to select.
The *PiP settings* menu will be displayed. (menu 10-8)
4. Select *PiP size*.
5. Press **ENTER** to select.
The *PiP size* menu will be displayed. (menu 10-9)
6. Select *Hor size*.
7. Press **ENTER** to select.
8. Use the ← or → keys to size the PiP window horizontally.

The center of the PiP image is taken as reference to enlarge or reduce the horizontal size. The indicated value is a percentage of the total PiP window size. (image 10-2)

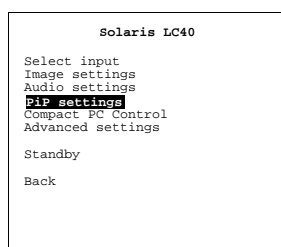

Menu 10-7

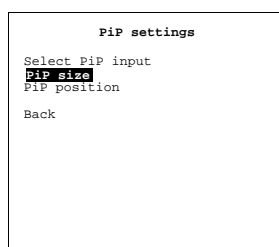

Menu 10-8

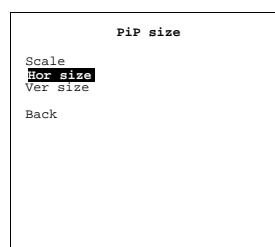

Menu 10-9

Image 10-2
Horizontal size PiP window

10.3.3 Vertical size

How to size horizontally

1. Press **ENTER** or **ADJUST** to start up the menus. (menu 10-10)
2. Select *PiP settings*.
3. Press **ENTER** to select.
The *PiP settings* menu will be displayed. (menu 10-11)
4. Select *PiP size*.
5. Press **ENTER** to select.
The *PiP size* menu will be displayed. (menu 10-12)
6. Select *Ver size*.
7. Press **ENTER** to select.
8. Use the ↑ or ↓ keys to size the PiP window vertically.

10. PiP Settings

The center of the PiP image is taken as reference to enlarge or reduce the vertical size. The indicated value is a percentage of the total PiP window size. (image 10-3)

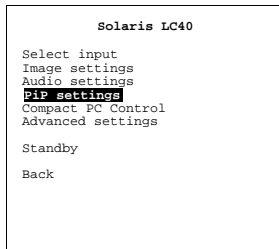

Menu 10-10

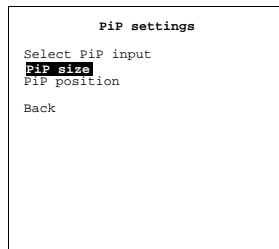

Menu 10-11

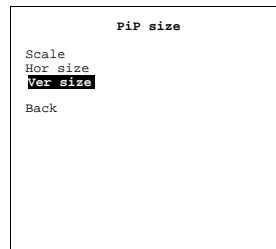

Menu 10-12



Image 10-3
Vertical size PiP window

10.4 PiP position

What can be done ?

The PiP window can be moved to any place on the display.

How to move

1. Press **ENTER** or **ADJUST** to start up the menus. (menu 10-13)
2. Select *PiP settings*.
3. Press **ENTER** to select.

The *PiP settings* menu will be displayed. (menu 10-14)

4. Press **ENTER** to select.
5. Use the arrow keys to move the PiP window to the desired position.

The bar scale indicated the position of the middle of the PiP window in comparison with the middle of the display. (image 10-4)

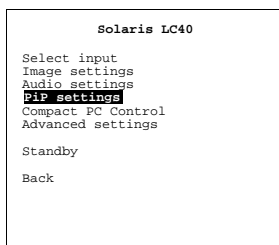

Menu 10-13

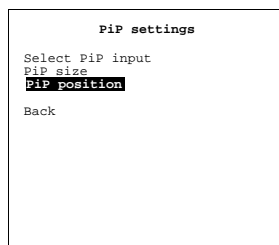

Menu 10-14



Image 10-4
Positioning PiP window

11. COMPACT PC CONTROL

Overview

- Display control by Compact PC

11.1 Display control by Compact PC

About display control

The display can be controlled by its internal processor or by an optional inserted compact PC. When the compact PC has granted the control all IR signals coming from the RCU will be switched through to the compact PC for further processing.

How to grant control to the compact PC ?

1. Press **ENTER** to enter the menu structure.

The main menu will be displayed. (menu 11-1)

2. Select *Compact PC Control*.

Note: *These selection is only available when the Solaris LC40 is displayed the output of the Compact PC (input selection 8).*

3. Press **ENTER** to grant the control to the Compact PC.

The compact PC menu will be displayed.

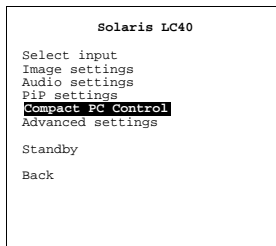

Menu 11-1



Normally with the **EXIT** key you can go one step upwards in the menu structure and return on this way to the main menu of the internal processor. If it does not work, use the **ADJUST** key to force the return to the main menu.

12. ADVANCED SETTINGS

Overview

- Advanced Settings menu overview
- Gamma
- Color Temperature
- Input Balance
- Noise Reduction
- Film mode detection
- Video Gain
- Display Settings
- Installation
- Service

12.1 Advanced Settings menu overview

Overview

- Gamma
 - Color temperature
 - Display white
 - Computer
 - Video
 - Film
 - Broadcast
 - Custom balance
- Input balance
- Noise reduction
- Film mode
- Video AGC
- Display settings
 - Rotate
 - Backlight
- Installation
 - File service
 - When no signal
 - OSD configuration
- Service
 - Identification screen
 - Service password
 - IR address
 - Serial communication
 - o RS232 address
 - o Baudrate
 - Terminal diagnosis
 - I2C diagnosis

12.2 Gamma

About Gamma

Gamma is an image quality enhancement function that offers a richer image by brightening the darker portions of the image without altering the brightness of the brighter portions.

How to change the gamma

1. Select *Advanced Settings*.
2. Press **ENTER** to activate.

The Advanced Settings menu will be displayed. (menu 12-1)

3. Select *Gamma*.
4. Press **ENTER** to select.

The Gamma menu will be displayed. The actual value will be indicated with a *. (menu 12-2)

5. Select the desired value and press **ENTER**.

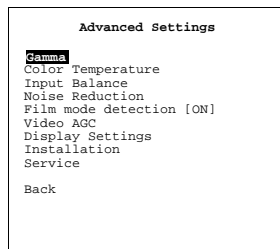

Menu 12-1

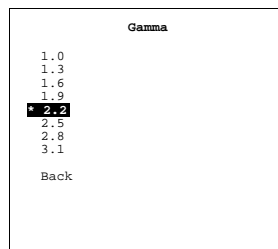

Menu 12-2

12.3 Color Temperature

What can be done ?

The color temperature can be selected according to the type of source:

There are 5 different preset color temperatures:

- Display white
- computer : 9300 K
- Video : 6500 K
- Film : 5400 K
- Broadcast : 3200 K

These calibrated presets can be selected and will provide optimum color tracking, the display allows however the setting of a personal color temperature, this is done in *Custom balance*

How to select a preset color temperature.

1. Select *Advanced Settings*.
2. Press **ENTER** to activate.

The Advanced Settings menu will be displayed. (menu 12-3)

3. Select Color Temperature.
4. Press **ENTER** to activate.

The Color temperature menu will be displayed. (menu 12-4)

The actual color temperature will be indicated by a *.

5. Use ↑ or ↓ to select the desired color temperature.
6. Press **ENTER** to confirm the selection.

The color temperature of the image is adapted and a * shows the active setting.

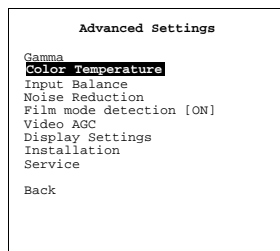

Menu 12-3

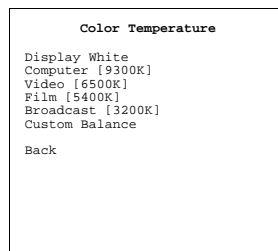

Menu 12-4

How to adjust the custom color balance.

1. Select *Advanced Settings*.
2. Press **ENTER** to activate.

The Advanced Settings menu will be displayed. (menu 12-5)

3. Select *Color Temperature*.

4. Press **ENTER** to activate.

The Color temperature menu will be displayed. (menu 12-6)

The actual color temperature will be indicated by a *.

5. Use ↑ or ↓ to select *Custom Balance*.

The Custom balance menu will be displayed. (menu 12-7)

6. Select respectively *Gain red*, *Gain green* and *Gain blue* and adjust with the arrow keys until the desired custom color balance is obtained.

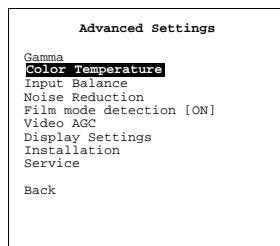

Menu 12-5

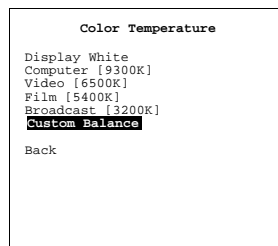

Menu 12-6

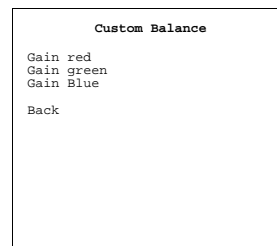

Menu 12-7

12.4 Input Balance

Overview

- Introduction to Input Balance
- Adjusting the input balance

12.4.1 Introduction to Input Balance

Introduction: Unbalanced color signals

When transporting signals, there is always a risk of deterioration of the information contained in the signals.

In case of information contained in the amplitude of the signals which is the case of data color signals (R, G, B), image 12-1, we are quite sure that the amplitude of these color signals is subject to alterations.

An example of alteration may be a DC component added to the signal, in the form of a DC offset repositioning the black level, since this **black level** (“**brightness**”) will become crucial later on (clamping circuit) it will result in “black not being black”.

Another value that is subject to alteration is the amplitude of the signal, resulting in an altered “Gain” of the signal (“**white level**” or **contrast**).

The alterations of the three color signals will happen independently i.e. the colors will end to be unbalanced, image 12-2

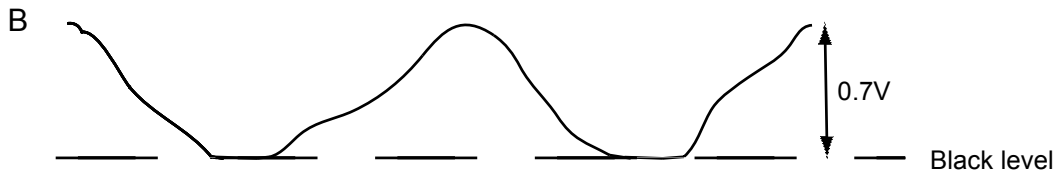

Image 12-1

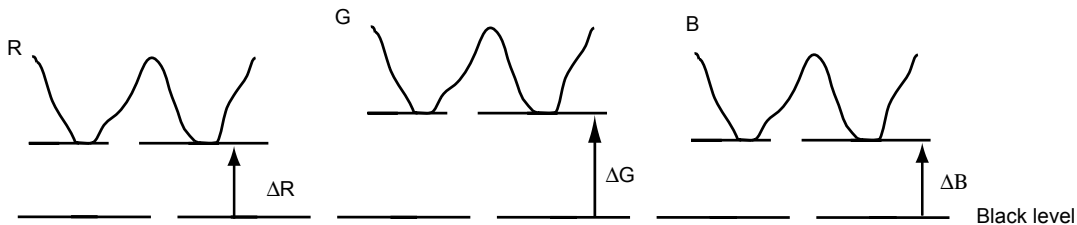

Image 12-2



One can conclude here that a good color tracking can only be met by using three previously (input) balanced color signals

Analog Digital Conversion

The analog color signals must pass through an Analog/Digital conversion circuit prior to any digital processing in the PMP.

A typical ADC transforms the analog value into an 8 bit coded digital signal.

The graphic shows that when converting a signal containing a DC offset component the range of the converter is not optimally used.

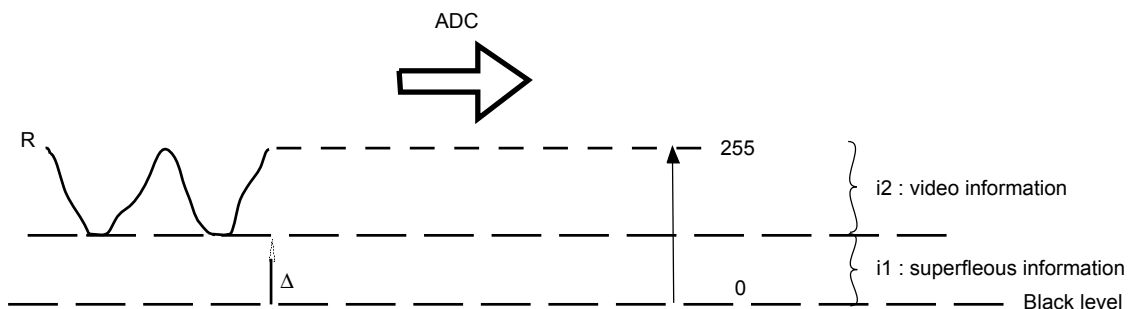

Image 12-3



One can conclude here that a good data conversion can only be met by using three previously (input) balanced color signals

The objective of input balancing

The objective in input balancing is to "set" the same black level and the same white level for the three colors of a particular input source.



Black level setting : brightness
White level setting : contrast

The same absolute black and white level for the three colors allow the same reference for Brightness and contrast control of the picture !

These two references also set the range in which the ADC will work for that particular source (this explains also why each input balance setting is linked to a particular source and thus saved in the image file).

12.4.2 Adjusting the input balance

How can it be done ?

To balance the three color signals of a particular source there are conditions; in fact we must know the black and the white level of the source i.e. :

1. The source in question must be able to generate a white signal, ideally a 100% white (background) full screen pattern
2. The source in question must be able to generate a black signal, ideally a 100% black (background) full screen pattern

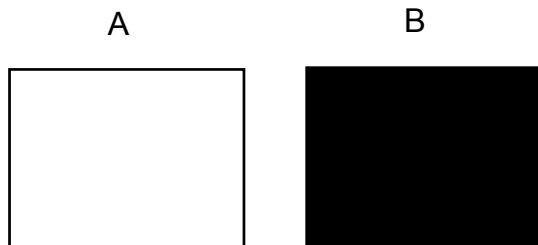

Image 12-4

White balance : In the projector, we will set the contrast for each color until we get a 100% light output picture when displaying a 100% white image (image A)

Black balance : In the projector, we will set the brightness for each color until we get a 0% light output picture when displaying a 100% black image (image B).



The changeover from min to max is indicated by the apparition of bright spots also called “digital noise”



An alternative to a full screen White/black pattern is the standard gray scale pattern, the white bar will be used for white balance and the black bar for black balance.

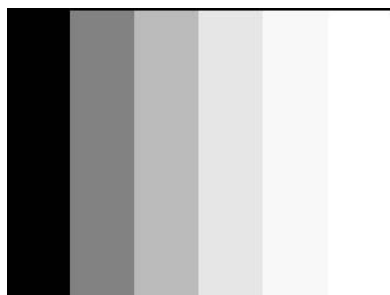

Image 12-5

Black balance

1. Select *Advanced Settings*.
2. Press **ENTER** to activate.
The Advanced Settings menu will be displayed. (menu 12-8)
3. Select *Input Balance*.
The Input Balance selection menu will be displayed. (menu 12-9)
4. Select *Black balance* and press **ENTER** to activate.
The black balance menu will be displayed. (menu 12-10)
5. Adjust the Brightness to a maximum value until there is no green noise visible in the black areas.
6. Select *Black balance red* and press **ENTER**.
A slider bar appears. Adjust with the ↑ or ↓ until there is no red noise visible in the black areas.
7. Select *Black balance blue* and press **ENTER**.

12. Advanced Settings

A slider bar appears. Adjust with the ↑ or ↓ until there is no blue noise visible in the black areas.

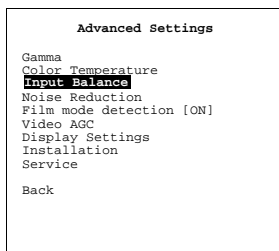

Menu 12-8

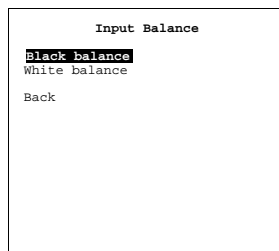

Menu 12-9

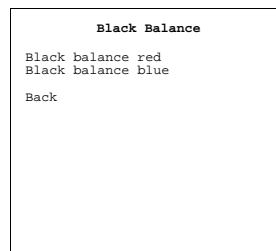

Menu 12-10

White balance

1. Select *Advanced Settings*.
2. Press **ENTER** to activate.

The Advanced Settings menu will be displayed. (menu 12-11)

3. Select *Input Balance*.

The Input Balance selection menu will be displayed. (menu 12-12)

4. Select *White balance* and press **ENTER** to activate.

The white balance menu will be displayed. (menu 12-13)

5. Adjust the Contrast to a maximum value until the green noise becomes visible in the white areas and return one step.
6. Select *White balance red* and press **ENTER**.

A slider bar appears. Adjust with the ↑ or ↓ until there the red noise becomes visible in the white areas and return one step.

7. Select *White balance blue* and press **ENTER**.

A slider bar appears. Adjust with the ↑ or ↓ until there the blue noise becomes visible in the white areas and return one step.

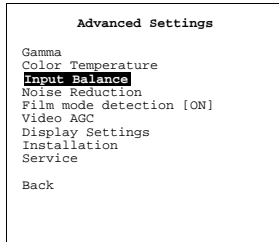

Menu 12-11

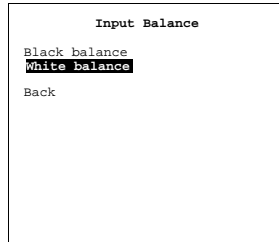

Menu 12-12

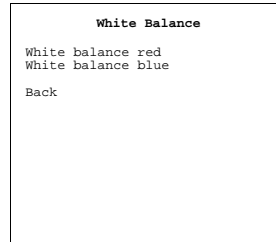

Menu 12-13

12.5 Noise Reduction

About Noise reduction

Reduces noise and pixel jitter in all video sources.

Noise reduction can be done manually or automatic. When set to automatic, the processor itself selects the best noise reduction level for the actual displayed image.

Switching between manual and automatic

1. Select *Advanced Settings*.
2. Press **ENTER** to activate.

The Advanced Settings menu will be displayed. (menu 12-14)

3. Select *Noise Reduction*.

The noise reduction menu will be displayed. (menu 12-15)

4. Select Manually or Automatic and press **ENTER** to toggle between [Manually] or [Automatic].

When Automatic is selected, the Adjust option is grayed out.

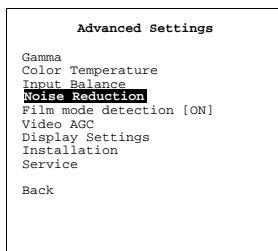

Menu 12-14

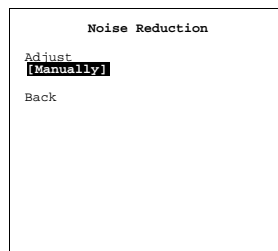

Menu 12-15

Adjusting the noise reduction manually.

1. Check first if the noise reduction is set to manually.
If yes, go to step 2
If no, Select first automatic and press **ENTER** to toggle to manually.
2. Select *Adjust*.
A slider bar will be displayed with the actual noise level reduction.
3. Use \uparrow or \downarrow to adjust the noise level to the desired value.
The higher the value, the higher the noise reduction.

12.6 Film mode detection

What can be done ?

Some sources like common DVD material are derived from cinema 24 Hz sources (2/2 or 3/2 pull down method).

The film mode detection insures that these converted signals are shown without artefacts.



This function may cause undesired effects on standard sources, therefore it can be disabled (OFF) at any time



2:2 pull-down

The process of transferring 24-frames/sec film format into video by repeating each frame (used for PAL DVD's) as two video fields. (AD)



3:2 pull-down

Method used to map the 24 fps of film onto the 30 fps (60 fields) or 25 fps (50 fields), so that one film frame occupies three video fields, the next two, etc. It means the two fields of every other video frame come from different film frames making operations such as rotoscoping impossible, and requiring care in editing. Some sophisticated equipment can unravel the 3:2 sequence to allow frame-by-frame treatment and subsequently re-compose 3:2. The 3:2 sequence repeats every five video frames and four film frames, the latter identified as A-D. Only film frame A is fully on a video frame and so exists at one time code only, making it the editable point of the video sequence.

How to switch the film mode

1. Select *Advanced Settings*.
2. Press **ENTER** to activate.
The Advanced Settings menu will be displayed. (menu 12-16)
3. Select *Film mode detection*.
4. Press **ENTER** to toggle between [on] and [off].

12. Advanced Settings

[on] : film mode detection is enabled.

[off] : film mode detection is disabled.

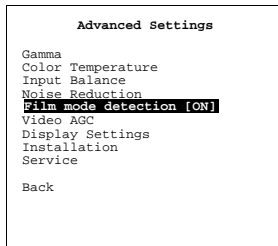

Menu 12-16

12.7 Video Gain

About Video Gain

The automatic gain control for video and S-Video sources can be switched off. Then it is possible to adjust the gain manually. When a YUV video signal, no AGC is available but the video gain can be adjusted.

How to adjust the video gain manually

1. Select *Advanced Settings*.

2. Press **ENTER** to activate.

The Advanced Settings menu will be displayed. (menu 12-17)

3. Select *Video gain*.

The Video gain menu will be displayed. (menu 12-18)

4. For Video and S-Video, select AGC. For YUV video, step 6.

5. Press **ENTER** to toggle between [ON] and [OFF].

ON Automatic gain control active, no manual video gain adjustment possible.

OFF Automatic gain control is disabled, manual video gain control is possible.

6. To adjust the video gain control, select *Video gain*.

A slider box appears.

7. Use \uparrow or \downarrow to change the video gain.

Nominal position : 100

Adjustable between 50 and 150.

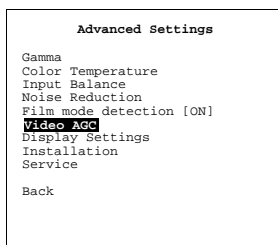

Menu 12-17

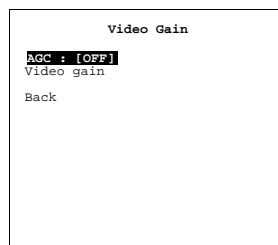

Menu 12-18

12.8 Display Settings

Overview

- Rotate
- Backlight

12.8.1 Rotate



Rotate is only available when the optional rotator module is inserted in the Solaris LC40.

About rotate

With the rotate function it is possible to go from a normal landscape image to a portrait image.

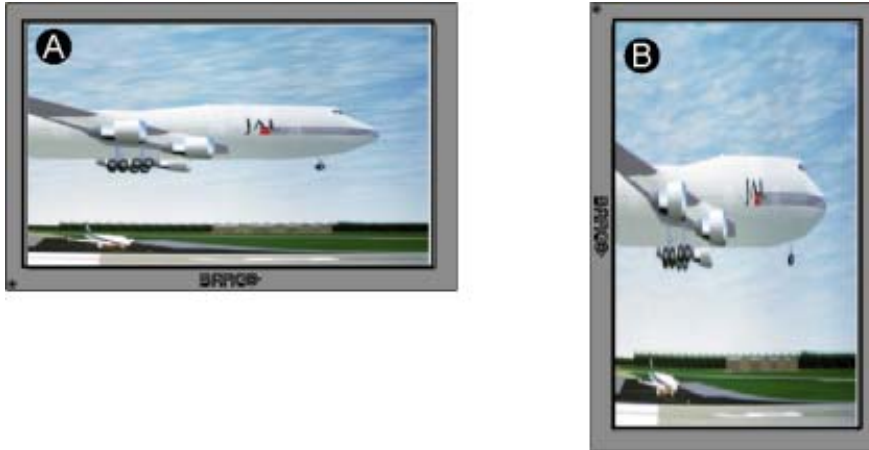

Image 12-6
Display rotation

- A Landscape
- B Portrait, with same input image

If you do not change anything to the viewport, the image will be compressed and stretched until it fills the display.

How to activate a rotation

1. Select *Advanced Settings*.
2. Press **ENTER** to activate.
The *Advanced Settings* menu will be displayed. (menu 12-19)
3. Select *Display Settings*.
4. Press **ENTER** to activate.
The *Display settings* menu will be displayed. (menu 12-20)
5. Select *Rotate*.
6. Press **ENTER** to toggle between *Landscape* and *portrait*.

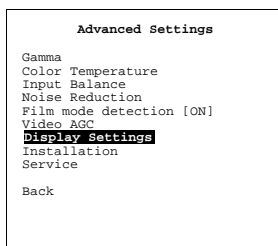

Menu 12-19

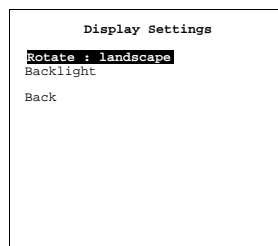

Menu 12-20

12.8.2 Backlight

About backlight

The backlight function can be used to adjust the display brightness for the different environment conditions. E.g. when installed in an environment with a lot of light the backlight should be increased.

How to change the backlight ?

1. Select *Advanced Settings*.
2. Press **ENTER** to activate.
The *Advanced Settings* menu will be displayed. (menu 12-21)
3. Select *Display Settings*.
4. Press **ENTER** to activate.
The *Display settings* menu will be displayed. (menu 12-22)
5. Select *Backlight*.
6. Press **ENTER** to activate.
A slider bar will be displayed with the actual backlight level filled out.
7. Use ↑ or ↓ to adjust the backlight level to desired level.

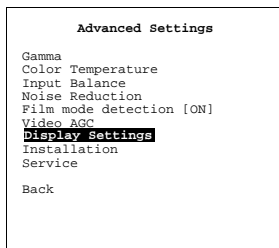

Menu 12-21

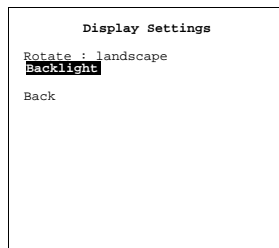

Menu 12-22

12.9 Installation

Overview

- File Services
- When no Signal
- Language Selection
- Tiled setup

12.9.1 File Services

12.9.1.1 Introduction to image files

Introduction

An image file contains the main characteristics of a source (number of active lines,...). The displays's memory contains a list of files corresponding to the most common sources, these are the standard files (file extension= *.s). When a new source corresponds to one of these files, a custom file (file extension=*.C) is created and saved for future use.

The maximum number of custom files that can be created is 63, the four last files are systematically overwritten.

When there is a little difference, the file can also be loaded and then edited until the source specs are reached.



The Load Automatic function creates automatically the best suited image file (custom file) for a new source.

Possible file manipulations

The possible file manipulations are :

- Load : installation of a file for a new source

12.9.1.2 Load file set up

About load file

With load file, a file containing source specific settings for that source, will be loaded. This load file can be done automatically by the system or manually by the user. When done automatically, the file which corresponds the best with the input source will be loaded. The priority will be given to a custom file. If no custom file is found, a standard file will be loaded.

How to set the load file property ?

1. Select *Advanced Settings*.
2. Press **ENTER** to activate.
The *Advanced Settings* menu will be displayed. (menu 12-23)
3. Select *Installation*.
4. Press **ENTER** to activate.
The *Installation* menu will be displayed. (menu 12-24)
5. Select *File services*.
6. Press **ENTER** to activate.
The File services menu will be displayed. (menu 12-25)
7. Select *Load [Automatic]* or *Load [Manually]*.
8. Press **ENTER** to toggle between *Automatic* and *Manually*.

Automatic The most corresponding file will be loaded automatically.

Manually The operator has the possibility to load a specific file.

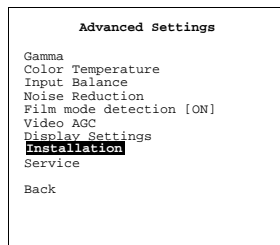

Menu 12-23

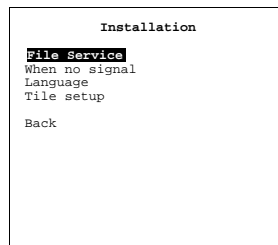

Menu 12-24

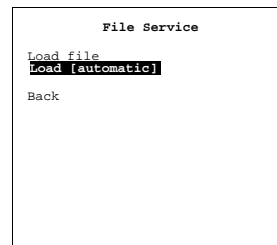

Menu 12-25

12.9.1.3 Loading a specific file

How to load a specific file

1. Select *Advanced Settings*.
2. Press **ENTER** to activate.
The *Advanced Settings* menu will be displayed. (menu 12-26)
3. Select *Installation*.
4. Press **ENTER** to activate.
The *Installation* menu will be displayed. (menu 12-27)
5. Select *File services*.
6. Press **ENTER** to activate.
The File services menu will be displayed. (menu 12-28)
7. Select *Load file*.
The load file menu will be displayed. (menu 12-29)

12. Advanced Settings

- If you want to load from a list of matching file, select *List matching files*.
If you want to load from the all available files, select *List all files*.
- Select the desired file and press **ENTER**.

While scrolling through the files, the image will be online adapted.

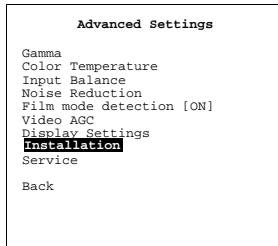

Menu 12-26

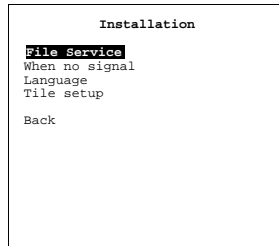

Menu 12-27

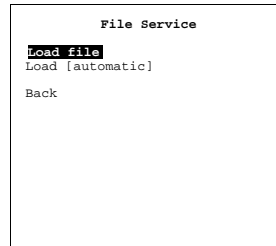

Menu 12-28

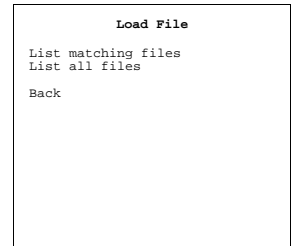

Menu 12-29

12.9.2 When no Signal

About When no signal

The Solaris LC40 can switch automatically to standby after a certain time when no signal is available on the inputs.

When no signal set up

- Select *Advanced Settings*.
- Press **ENTER** to activate.
The *Advanced Settings* menu will be displayed. (menu 12-30)
- Select *Installation*.
- Press **ENTER** to activate.
The *Installation* menu will be displayed. (menu 12-31)
- Select *When no signal*.
- Press **ENTER** to activate.
The *When no signal* menu will be displayed. (menu 12-32)
- Select *Standby [off]* or *Standby [on]* and press **ENTER** to toggle the *When no display* setting.

off when no input signal, the display stay on.

on when no input signal, the display goes to standby when the time installed in *Delay* is past.

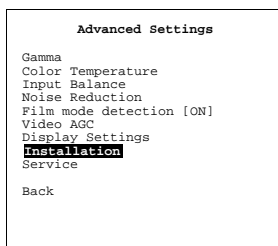

Menu 12-30



Menu 12-31

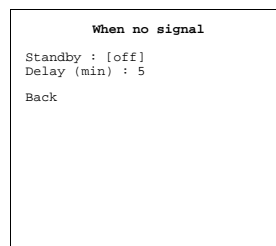

Menu 12-32

Delay set up

When no signal is *Standby [on]*:

- Select *Delay*. (menu 12-33)
- Press **ENTER** to activate.
The delay entering menu appears. (menu 12-34)
The first digit is highlighted.
- Enter a new delay time with the digit keys on your RCU

Or,
turn the thumb wheel to change the first digit. Press the thumb wheel to enter the selected value and to jump to the next digit. Handle in the same way for the second digit.

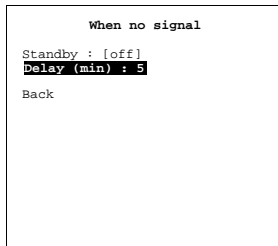

Menu 12-33

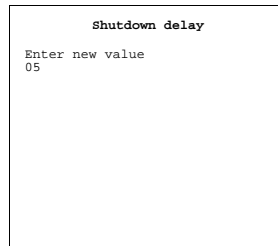

Menu 12-34

12.9.3 Language Selection

What can be done ?

The OSD language can be changed to one of the available languages.

How to change the language

1. Select *Advanced Settings*.
2. Press **ENTER** to activate.
The *Advanced Settings* menu will be displayed. (menu 12-35)
3. Select *Installation*.
4. Press **ENTER** to activate.
The *Installation* menu will be displayed. (menu 12-36)
5. Press **ENTER** to activate.
The language menu will be displayed. (menu 12-37)
The * indicates the actual active language.
6. Select the desired language and press **ENTER**.
The OSD will change to the selected language.

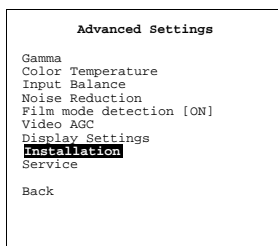

Menu 12-35

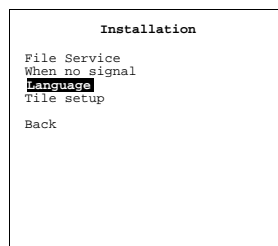

Menu 12-36

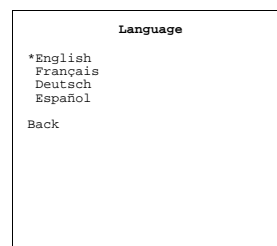

Menu 12-37

12.9.4 Tiled setup



This set up has to be done for each tile (display) in the configuration.

Tiled setup toggle

1. Select *Advanced Settings*.
2. Press **ENTER** to activate.
The *Advanced Settings* menu will be displayed. (menu 12-38)
3. Select *Installation*.

4. Press **ENTER** to activate.
The *Installation* menu will be displayed. (menu 12-39)
5. Press **ENTER** to activate.
The *Tile setup* menu will be displayed. (menu 12-40)
6. Select *Tiled setup* [yes] or [no].
7. Press **ENTER** to toggle between [yes] or [no].

[yes] The display is configured for a tiled setup.
[no] The display is configured as a stand alone display.

When [yes] is selected, the complete set up can be finished.

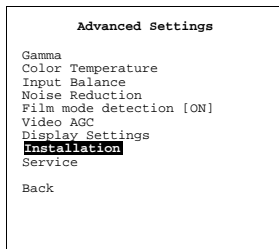

Menu 12-38



Menu 12-39

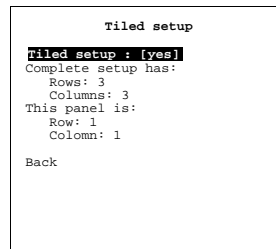

Menu 12-40

Set up of the complete configuration

1. Select *Rows* just below *Complete set*. (menu 12-41)
2. Press **ENTER** to select.
3. Enter the number of the rows available in the tiled configuration.
Maximum rows allowed : 99
4. Select *Columns* just below *Complete set*. (menu 12-42)
5. Press **ENTER** to select.
6. Enter the number of the columns available in the tiled configuration.
Maximum columns allowed : 99

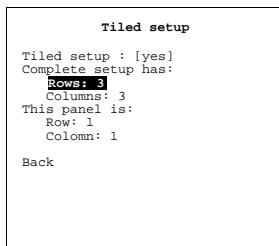

Menu 12-41

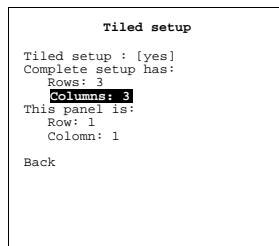

Menu 12-42

Tile set up

1. Select *Row* just below *This panel is*. (menu 12-43)
2. Press **ENTER** to select.
3. Enter the row number in which the display (tile) is situated. (image 12-7)
4. Select *Column* just below *This panel is*. (menu 12-44)
5. Press **ENTER** to select.

6. Enter the column number in which the display (tile) is situated.

```

Tiled setup
Tiled setup : [yes]
Complete setup has:
  Rows: 3
  Columns: 3
This panel is:
  Row: 1
  Column: 1
Back

```

Menu 12-43

```

Tiled setup
Tiled setup : [yes]
Complete setup has:
  Rows: 3
  Columns: 3
This panel is:
  Row: 1
  Column: 1
Back

```

Menu 12-44

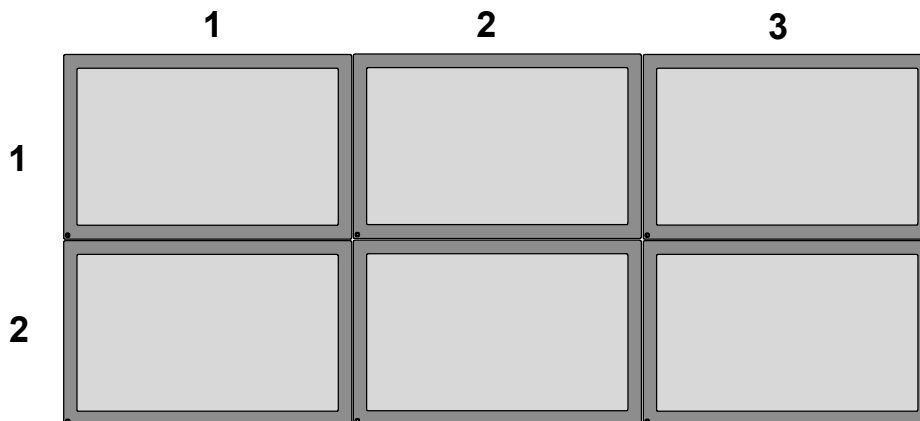

Image 12-7

Practical example to set up the configuration.

- Start with the first display and give it a IR address. Enter a logical pin code for the IR unlocking and set the IR locking on. As the PIN code contains four digits, use e.g. the first 2 digits to indicate the row and the second 2 digits to indicate the column.
- Set display per display on the same IR address, enter the logical PIN code and set the IR locking on.
- Unlock now the first display and set up the tile configuration and all other adjustments for that display. Set IR locking back on ON and continue with the next display.

12.10 Service

Overview

- Identification screen
- IR address
- Serial communication
- IR locking
- Restore Factory Defaults

12.10.1 Identification screen

The display's identification screen

The identification screen displays the display's main characteristics.

These are :

- Display type
- IR address
- RS232 address
- Serial number of the display
- Run time since first start up
- Software version

How to display the identification screen ?

1. Press **ENTER** to activate the menu structure.
2. Select Advanced Settings and press **ENTER** to activate.
The advanced settings menu will be displayed. (menu 12-45)
3. Select *Service*.
4. Press **ENTER** to select.
The service menu will be displayed. (menu 12-46)
5. Select *Identification*.
6. Press **ENTER** to display the identification screen. (menu 12-47)

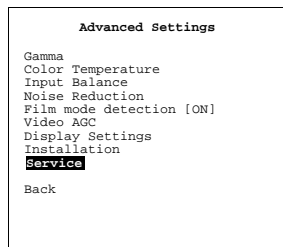

Menu 12-45

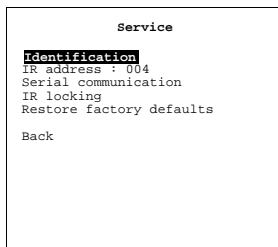

Menu 12-46

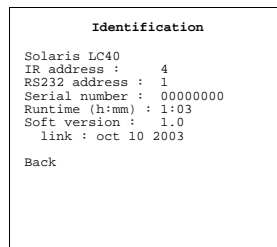

Menu 12-47

12.10.2 IR address

How to change the IR address ?

1. Press **ENTER** to activate the menu structure.
2. Select Advanced Settings and press **ENTER** to activate.
The advanced settings menu will be displayed. (menu 12-48)
3. Select *Service*.
4. Press **ENTER** to select.
The service menu will be displayed. (menu 12-49)
5. Select *IR address*.
6. Press **ENTER**.
The *IR address* box opens. (menu 12-50)
7. Use **↑** or **↓** to change the value.
Or,
enter the desired value with the digit keys on the RCU.
Or,
turn the thumb wheel until the desired value is displayed and press the thumb wheel.

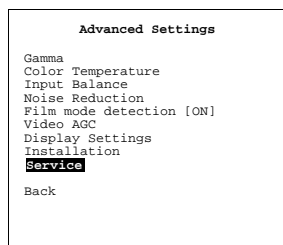

Menu 12-48

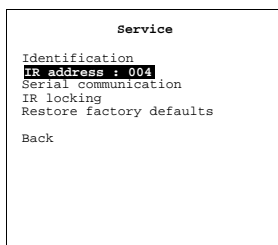

Menu 12-49

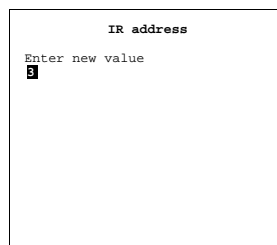

Menu 12-50

12.10.3 Serial communication

Overview

- RS232 address
- Changing the baudrate for RS232 communication

12.10.3.1 RS232 address

How to change the RS232 address ?

1. Press **ENTER** to activate the menu structure.
2. Select Advanced Settings and press **ENTER** to activate.
The advanced settings menu will be displayed. (menu 12-51)
3. Select *Service*.
4. Press **ENTER** to select.
The service menu will be displayed. (menu 12-52)
5. Select *Serial communication*.
6. Press **ENTER**.
The serial communication menu opens. (menu 12-53)
7. Select *RS232 address* and press **ENTER**.
The RS232 address change menu opens. (menu 12-54)
The first digit will be highlighted.
8. To change the address :
Use \uparrow or \downarrow to change the value.
For a highlighted value, use \uparrow or \downarrow to change this value or enter the desired value with the digit keys on the RCU
To go to the next digit : use the \leftarrow or \rightarrow to highlight another value.

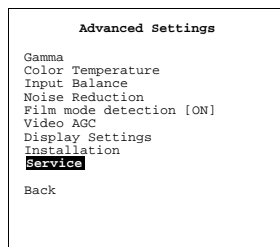

Menu 12-51

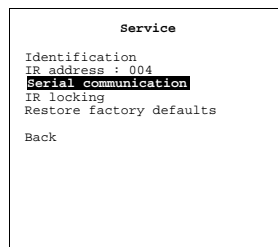

Menu 12-52

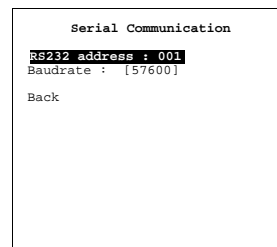

Menu 12-53

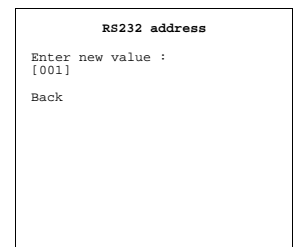

Menu 12-54

12.10.3.2 Changing the baudrate for RS232 communication

How to change the baudrate ?

1. Press **ENTER** to activate the menu structure.
2. Select Advanced Settings and press **ENTER** to activate.
The advanced settings menu will be displayed. (menu 12-55)
3. Select *Service*.
4. Press **ENTER** to select.
The service menu will be displayed. (menu 12-56)
5. Select *Serial communication*.
6. Press **ENTER**.
The serial communication menu opens. (menu 12-57)
7. Select *Baudrate*.
8. Press **ENTER** to scroll through the different possible values.

12. Advanced Settings

Possible values:

- 9600
- 19200
- 30400
- 57600
- 115200
- 230400

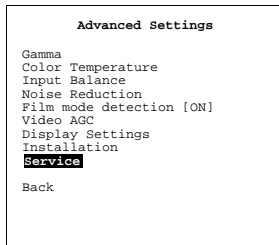

Menu 12-55

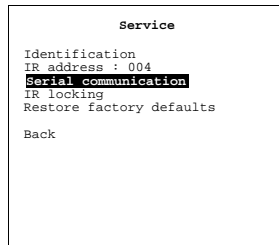

Menu 12-56

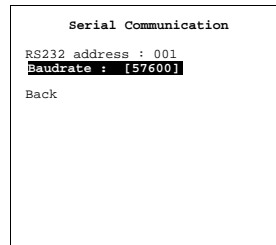

Menu 12-57

12.10.4 IR locking

Overview

- Locking the display
- Changing your PIN code

12.10.4.1 Locking the display

How to lock ?

1. Press **ENTER** on the RCU or press the thumb wheel once.

The main menu will be displayed. (menu 12-58)

2. Select *Service* and press **ENTER** or the thumb wheel.

The service menu will be displayed. (menu 12-59)

3. Select *IR locking* and press **ENTER**.

The *IR locking* menu will be displayed. (menu 12-60)

4. Select *Locking [off]* and press **ENTER** to toggle to [on].

As you cannot use the back button anymore, the menu will disappear after a few seconds.

Your display is locked for IR signals.

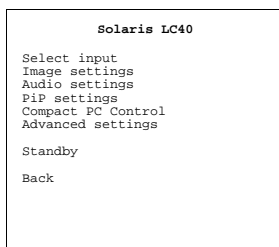

Menu 12-58

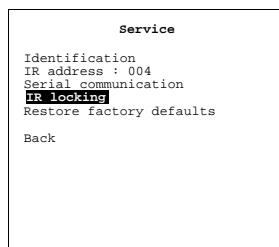

Menu 12-59

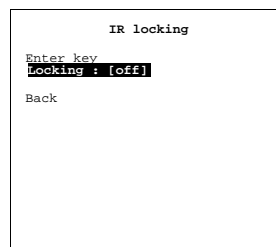

Menu 12-60

12.10.4.2 Changing your PIN code

What is possible ?

Your PIN code can be changed at anytime to a new PIN code. With this procedure you can also change the factory installed PIN code.

Factory default PIN code : 0000

How to change ?

1. Press **ENTER** on the RCU or press the thumb wheel once.
The main menu will be displayed. (menu 12-61)
2. Select *Service* and press **ENTER** or the thumb wheel.
The service menu will be displayed. (menu 12-62)
3. Select *IR locking* and press **ENTER**.
The *IR locking* menu will be displayed. (menu 12-63)
4. Select *Enter key* and press **ENTER**.
The IR key window opens. (menu 12-64)
The first digit will be highlighted.
5. To change the value :
Use \uparrow or \downarrow to change the value.
For a highlighted value, use \uparrow or \downarrow to change this value or enter the desired value with the digit keys on the RCU
To go to the next digit : use the \leftarrow or \rightarrow to highlight another value.

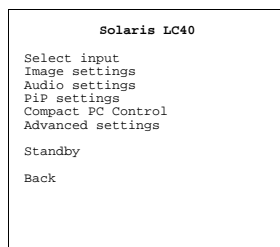

Menu 12-61

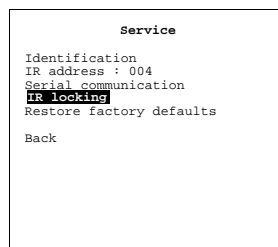

Menu 12-62

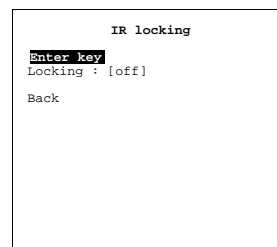

Menu 12-63

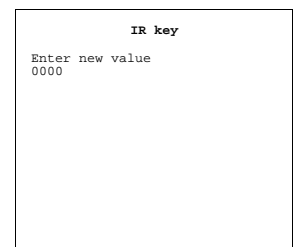

Menu 12-64

12.10.5 Restore Factory Defaults

What is possible ?

With the factory defaults setting it is possible to return to the factory stored settings for the display.

How to return to factory defaults

1. Press **ENTER** on the RCU or press the thumb wheel once.
The main menu will be displayed. (menu 12-65)
2. Select *Service* and press **ENTER** or the thumb wheel.
The service menu will be displayed. (menu 12-66)
3. Select *Restore factory defaults* and press **ENTER**.
The *Restore factory defaults* menu will be displayed. (menu 12-67)
4. Do you want to continue?
If yes, Select *Continue* and press **ENTER**.
A confirmation window will be displayed. (menu 12-68)
If no, select *Back* and press **ENTER**.
5. If you are sure to reset to the factory default, select *Yes* and press **ENTER**.
The factory defaults will be restored.

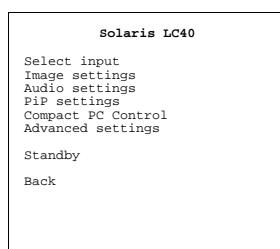

Menu 12-65

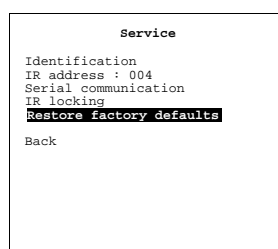

Menu 12-66

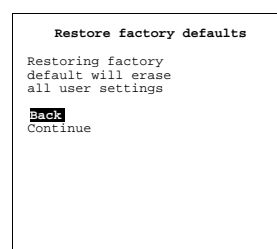

Menu 12-67

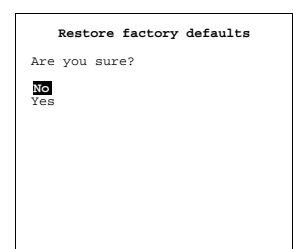

Menu 12-68

A. STANDARD SOURCE SET UP FILES

A.1 Table overview

Table

The following standard source files are pre-programmed in the display.

Name ¹	interlaced ²	Line duration ³	Total lines ⁴	Total pixels ⁵	Active lines ⁶	Active pixels ⁷
none	1	63556	263	858	240	675
vid525_2	1	63556	262	858	445	663
ntsc_osd	0	63556	262	858	226	650
vid625_2	1	64000	313	864	548	679
pal_osd	0	64000	312	864	274	662
pro_pal	0	32000	625	864	570	686
sdi_525	1	63556	262	858	232	690
sdi_625	1	64000	312	864	275	690
vga_txt	0	31777	449	900	400	720
vga_gr	0	31777	525	800	480	640
vga75iso	0	25397	525	800	480	640
vga_72v	0	26416	520	832	480	640
svga_56v	0	28445	625	1024	600	800
svga_60v	0	26400	628	1056	600	800
svga_72v	0	20799	667	1040	600	800
xga_60	0	20678	806	1344	768	1024
wsga_60	0	20370	818	1676	768	1280
xga_70v	0	17799	806	1328	768	1024
xga_70	0	17528	815	1368	768	1024
xga_75	0	16372	806	1408	768	1024
xga75_gs	0	16750	801	1328	768	1024
xga_72	0	17200	808	1376	768	1024
ews_50	0	19102	1047	1680	1024	1280
ews_60v	0	15709	1056	1728	1024	1280
ews_72	0	12992	1069	1690	1024	1280
ews_75	0	12504	1066	1688	1024	1280
sunews67	0	13949	1067	1632	1024	1280

1. Name : name of file, contains the settings

2. 0 = not interlaced, 1 = interlaced

3. Line duration in ns

4. Total lines in one field

5. Total pixels in one horizontal line

6. Active lines in one field

7. Active pixels in one horizontal line

A. Standard Source Set up Files

sunews76	0	12326	1066	1664	1024	1280
sg_60_1	0	15649	1065	1680	1024	1280
pro_ntsc	0	31777	525	910	480	735
ews_60	0	15649	1064	1680	1024	1280
sg_50	0	16000	1250	2085	1200	1600
sg_60_4	0	13333	1250	2085	1200	1600
1600_60v	0	13333	1250	2160	1200	1600
1600_65v	0	12308	1250	2160	1200	1600
1600_70v	0	11429	1250	2160	1200	1600
s1600_67	0	11200	1334	2240	1280	1600
hd_60p	0	22222	750	1650	720	1280
hd_30i	1	29630	563	2200	540	1920
hd_25i	1	35556	562	2640	540	1920
hd_24sf	1	37037	562	2750	540	1920
ews_85	0	10971	1072	1728	1024	1280
1280sqr	0	12550	1328	1506	1280	1280

B. OPTIONAL MOUNTING EQUIPMENT

Overview

- Wall Mounting Support
- Table mounting support

B.1 Wall Mounting Support

B.1.1 Kit content

Overview



Image B-1

B.1.2 Horizontal Wall Mounting Support

How to mount

1. Use the center cross (A) which indicates the middle of the Solaris LC40 to mark the drill holes (B) for the wall support. The diagonals of the Solaris LC40 must cross each other in the center of the center cross, see image B-5. image B-2)
Note: Attention, always mount the bracked with handle D at the top side.
2. Put the security handle (D) right up.
3. Slide a wall spacer over each bolt. (image B-3)
4. Turn the four bolts into the backside of the Solaris LC40 (A). (image B-4)
5. Hook the Solaris LC40 with the four bolts into the holes (C) of wall mount (image B-2).
6. Slowly lower the panel until it rest on the support.
7. Close the security handle by pushing it to the left.
Your panel is mounted to the wall. (image B-5)

B. Optional Mounting Equipment

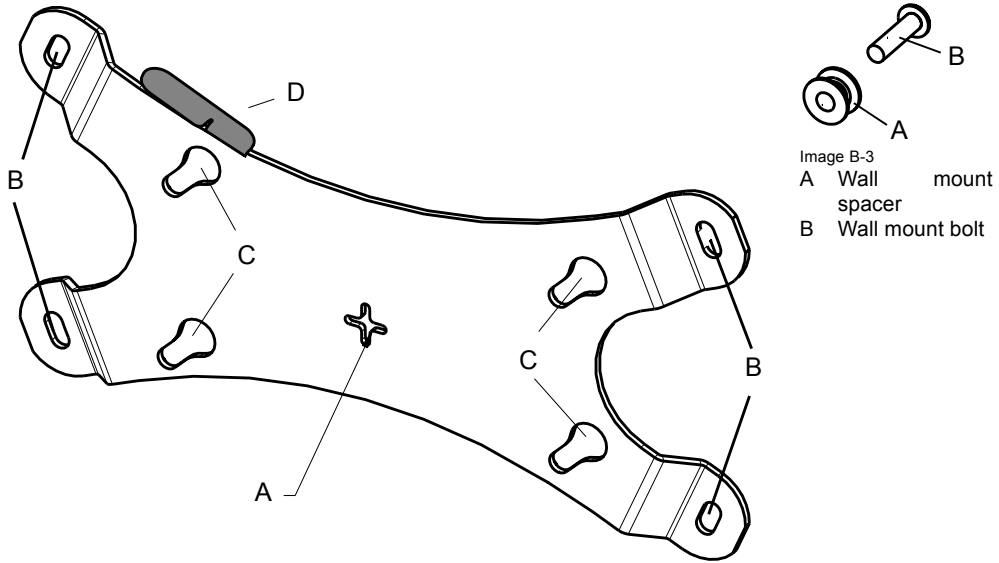

Image B-2
Wall mount support

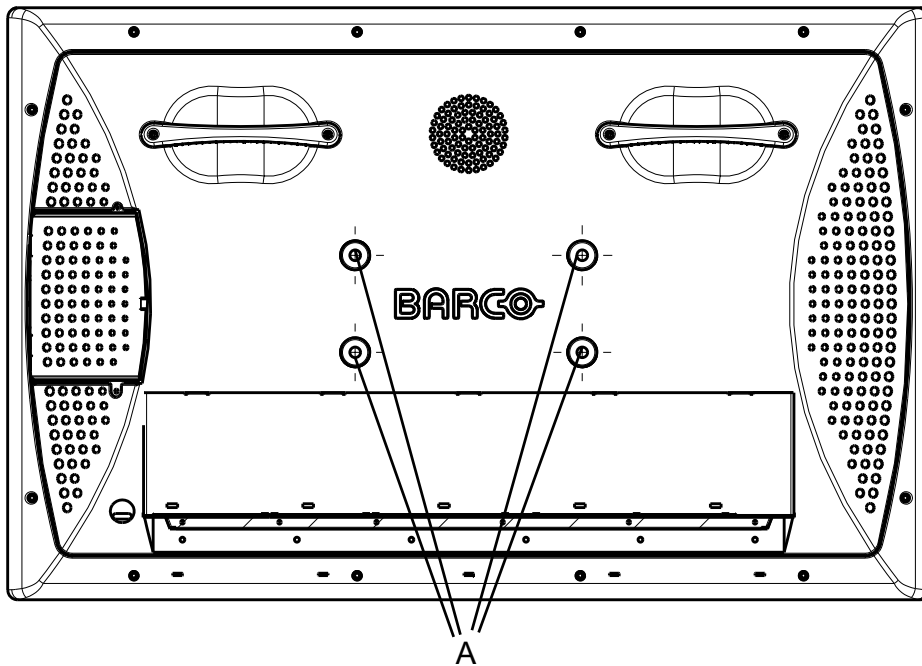

Image B-4

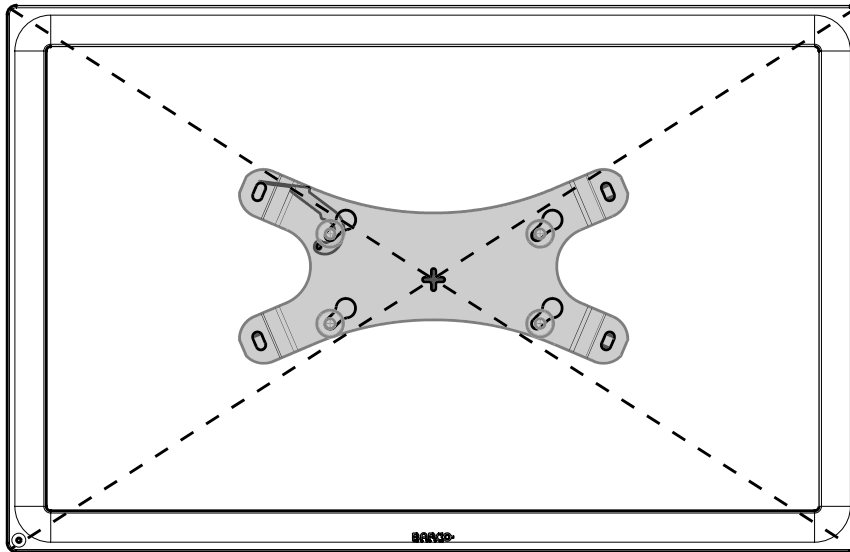

Image B-5
Final result

B.1.3 Vertical Wall Mounting Support

How to mount

1. Use the center cross (A) which indicates the middle of the Solaris LC40 to mark the drill holes (B) for the wall support. The diagonals of the Solaris LC40 must cross each other in the center of the center cross, see image B-9. image B-6)
Note: Attention, always mount the bracket in the way that handle D on the left side.
2. Put the security handle (D) to the left.
3. Slide a wall spacer over each bolt. (image B-7)
4. Turn the four bolts into the backside of the Solaris LC40 (A). (image B-8)
5. Hook the Solaris LC40 with the four bolts into the holes (C) of wall mount (image B-2).
6. Slowly lower the panel until it rest on the support.
7. Close the security handle by pushing it to the left.
Your panel is mounted to the wall. (image B-9)

B. Optional Mounting Equipment

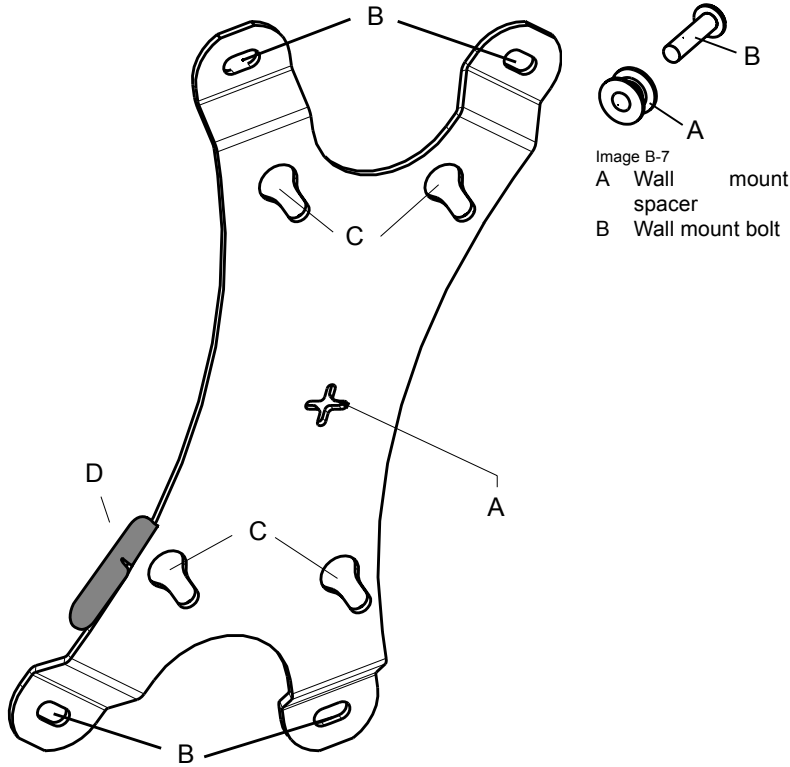

Image B-6

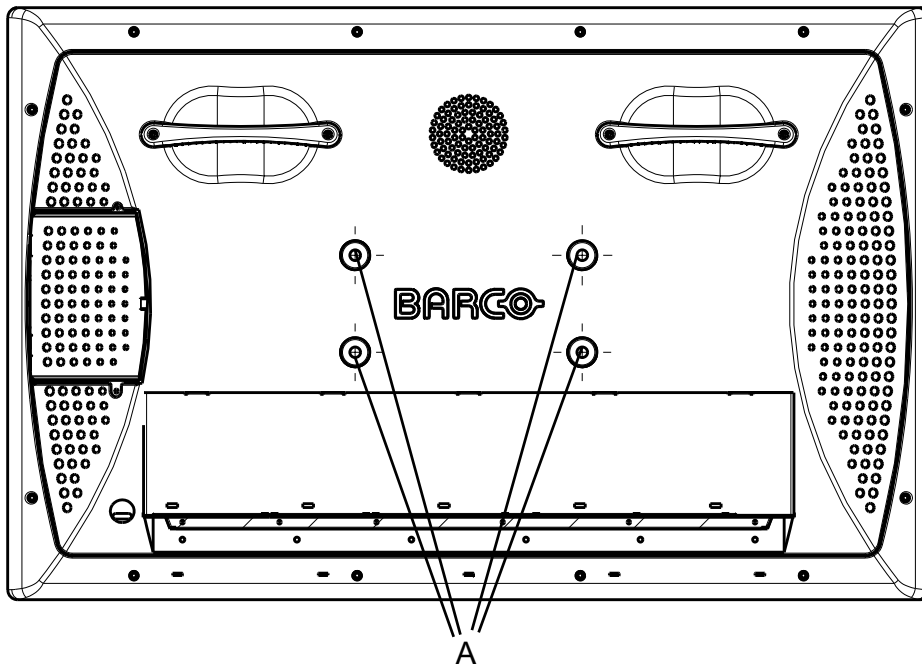

Image B-8

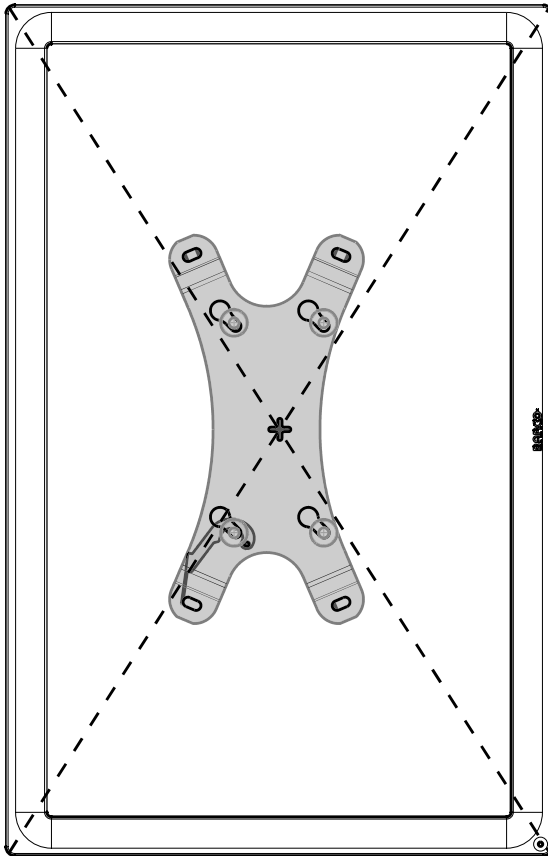

Image B-9
Final result

B.2 Table mounting support

How to use

1. Turn in a little bit four bolt on the backside of the Solaris LC40 (A). (image B-10)
2. Hook the panel into the mounting holes of the table mount support (A). (image B-11)
3. Slowly lower the panel until it rest on the support.
4. Secure by fixing the four bolts.
5. For easily cable connection, loosen wing nut B and turn the panel until it lays down.

The cables can be connected in an easy way. When finished, turn it back in its original position and secure wing bolt B.

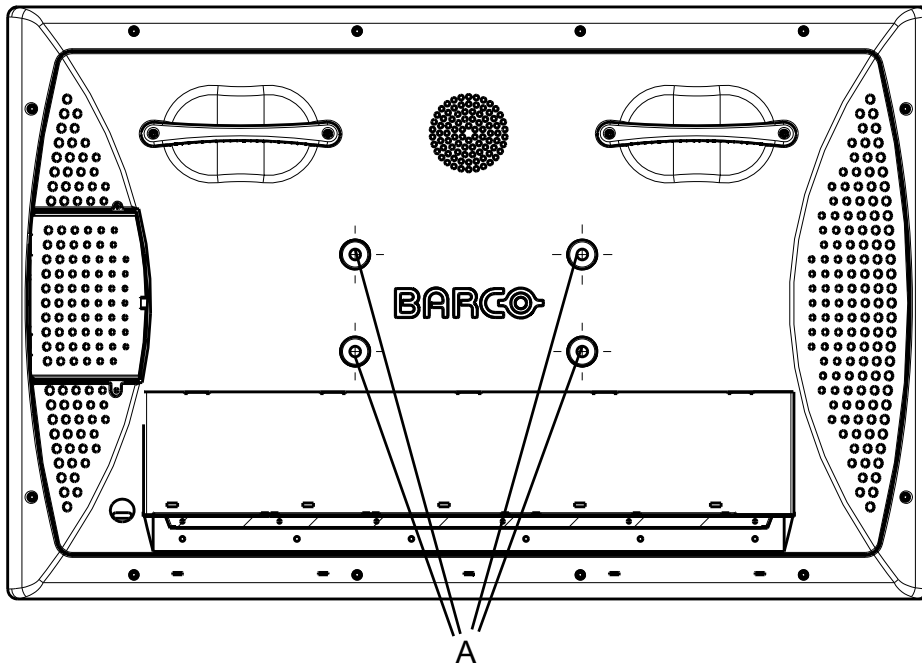

Image B-10

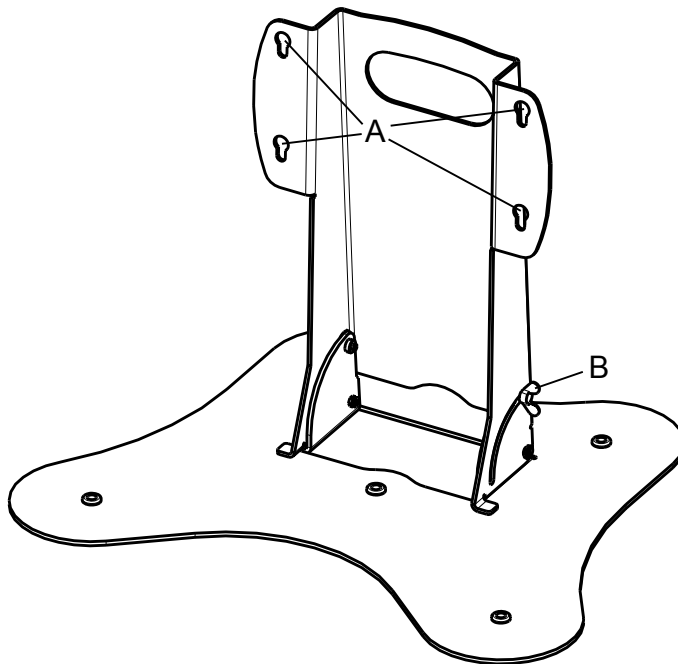

Image B-11

C. SPECIFICATIONS

C.1 Specifications Solaris LC40

Overview

Technology	TFT LCD
Hor. viewing angle	170°
Vert. viewing angle	170°
Lifetime	typical 50.000h
Weight	25kg / 55.1lbs
Contrast Ratio	600:1
Brightness	450NIT
Aspect Ratio	15:9
Power Requirements	Input: 85V-264V (50Hz-60Hz)
Power consumption	270W (330W including Compact PC)
Operating T°	5°C to 40°C (41°F to 104°F)
Regulation Compliance	UL, CE
Native resolution	1280 x 768 (W-XGA)
Active screen area	862mm x 517mm (33.9" x 20.4")
Active screen diagonal	1010mm (39.6")
Colors	16.8 million
Standard inputs for R9004120	DVI, RGBHV (on BNC), SDI Video PAL/NTSC/SECAM (CVBS in/out; S-Video in; YUV in)
Standard inputs for R9004125	DVI, RGBHV (on BNC), SDI
Humidity	Max. 85%
Control	Control over IP (including internal hub for LAN applications) RS232 control On Screen Display (OSD) IR Remote control

GLOSSARY

2:2 pull-down

The process of transferring 24-frames/sec film format into video by repeating each frame (used for PAL DVD's) as two video fields. (AD)

3:2 pull-down

Method used to map the 24 fps of film onto the 30 fps (60 fields) or 25 fps (50 fields), so that one film frame occupies three video fields, the next two, etc. It means the two fields of every other video frame come from different film frames making operations such as rotoscoping impossible, and requiring care in editing. Some sophisticated equipment can unravel the 3:2 sequence to allow frame-by-frame treatment and subsequently re-compose 3:2. The 3:2 sequence repeats every five video frames and four film frames, the latter identified as A-D. Only film frame A is fully on a video frame and so exists at one time code only, making it the editable point of the video sequence.

ANSI 73.11

American power plug to connect the power cord to the wall outlet.

CEE7

European power plug to connect the power cord to the wall outlet.

Chrominance

The color component of a video signal that includes information about tint and saturation.

DVI

Digital Visual Interface is a display interface developed in response to the proliferation of digital flat panel displays.

The digital video connectivity standard that was developed by DDWG (Digital Display Work Group). This connection standard offers two different connectors: one with 24 pins that handles digital video signals only, and one with 29 pins that handles both digital and analog video. This standard uses TMDS (Transition Minimized Differential Signal) from Silicon Image and DDC (Display Data Channel) from VESA (Video Electronics Standards Association).

DVI can be single or dual link.

Luminance

The component of a video signal that includes information about its brightness.

PiP

PiP stands for "Picture in Picture" and allows to display multiple windows containing each of them an image. The windows may be of the video or data type.

INDEX

A

- Address 30
 - Program 30
 - RCU 30
 - setting 30
 - IR address 30
 - RS232 address 30
- Advanced settings 63–65, 68–72, 74–75, 77–80
 - Color temperature 64
 - Display settings 70–71
 - Backlight 71
 - Rotate 71
 - Film mode detection 69
 - Gamma 63
 - Input balance 65
 - Installation 72, 74–75
 - File services 72
 - Language 75
 - Tiled setup 75
 - When no signal 74
 - Menu overview 63
 - Noise reduction 68
 - Service 77–80
 - Baudrate 79
 - Identification screen 77
 - IR address 78
 - IR locking 80
 - RS232 address 79
 - Serial communication 78
 - Video Gain 70
- Aspect ratio 41
- Audio settings 51–53
 - Balance control 52
 - Bass control 52
 - Overview 51
 - Start up 51
 - Subwoofer control 53
 - Treble control 53
 - Volume control 51

B

- Balance control 52
 - Menu structure 52
- Bass control 52
 - Menu structure 52
- Brightness 42

C

- Cable cover 25
- Color Saturation 43
- Color temperature 64–65
 - Custom balance 65
 - Preset values 64
- Communication connections 25
 - RS232 25
- Compact PC control 61
 - Display control 61
- Configuring input 2 19, 38
- Connections 13
 - Input sources 13
 - Power 13
- Contrast 43

D

- Dimensions 7–8
- Display settings 70–71
 - Backlight 71
 - Rotate 71

- DVI 14–15
 - Pin configuration 15
 - Specifications 14

E

- Electrical Safety 3

F

- Factory defaults 81
- Film mode detection 69

G

- Gamma 63
- Getting started 27–30
 - LCD panel address 30
 - RCU 27
 - Terminology 27
 - Switching Off 28
 - Switching On 28
 - Using the RCU 29

I

- Image settings 41–45, 48–49
 - Aspect ratio 41
 - Brightness 42
 - Color Saturation 43
 - Contrast 43
 - Menu overview 41
 - Phase 49
 - Sharpness 44
 - Tint (hue) 44
 - Viewport 45, 48–49
 - About 45
 - Automatic 48
 - Creation 45
 - Total pixels 49
- Input balance 65, 67
 - Adjust 67
 - Introduction 65
- Input connections 14, 16–18, 20–23
 - Audio pré-amp 23
 - Compact PC 17
 - DVI 14, 16
 - DVI input 20
 - Optional module 20
 - HD-SDI input 21
 - Optional module 21
 - RGB input 22
 - Optional module 22
 - SDI 17
 - Video input 18
- Input facilities 13
- Input selection 37–38
 - Compact PC 38
 - Configuring input 2 38
 - Source selection 37
 - Start up 37
- Input sources 13
 - Input facilities 13
- Installation 5, 72–75
 - File services 72–73
 - Introduction to image files 72
 - Load file 73
 - Load specific file 73
 - Language 75
 - Safety precautions 5
 - Tiled setup 75

When no signal 74
Installation Guidelines 11
 Configurations 11
 General 11
IR address 30
IR locking 32

L

Language setup 75
LCD panel 30, 32
 Controlling 30
 IR locking 32
Loop through connection 24
 RGB output 24

M

Menu structure 35–36
 Slider box 36
 Start up 35
 Use 35
Mounting equipment 85, 87, 89
 Table mounting support 89
 Wall mounting support 85, 87
 Horizontal 85
 Vertical 87

N

Noise reduction 68

P

Packaging 7
 Box content 7
 Way of 7
Phase 49
PIN code 80
 Change 80
PiP 32, 55–58
 Function keys 32
 Introduction 55
 PiP position 58
 PiP size 56–57
 Horizontal size 57
 Scale 56
 Vertical size 57
 Quick access keys 32
 Select PiP input 55
PiP position 58
PiP settings 55–58
 PiP position 58
 PiP size 56–57
 Horizontal size 57
 Scale 56
 Vertical size 57
 Select PiP input 55
PiP size 56–57
 Horizontal size 57
 Scale 56
 Vertical size 57

R

RCU 27
 Terminology 27
Remote control 12
 Battery insertion 12
RS232 address 30

S

S-Video 19
 Pin configuration 19
Safety 3
Safety Instructions 3–5
 General 3
 On cleaning 5
 On Shipping 5
 Protection on Servicing 4
Select PiP input 55
Service 77–81
 Baudrate 79
 Factory defaults 81
 Identification screen 77
 IR address 78
 IR locking 80
 Display 80
 PIN code 80
 RS232 address 79
 Serial communication 78
Sharpness 44
Slider box 36
Specifications 91
Standard Source Set up Files 83
 Table overview 83
Subwoofer control 53
 Menu structure 53
Switching off 28–29
 Power off 29
 To standby 28
Switching Off 28
Switching On 28
 From standby 28
 Main power up 28

T

Table mounting support 89
Tiled setup 75
Tint (hue) 44
Treble control 53
 Menu structure 53

U

Using the RCU 29

V

Video Gain 70
Viewport 45, 47–49
 About 45
 Automatic 48
 Creation 45
 Height 47
 Horizontal start 47
 Total pixels 49
 Vertical start 47
 Width 47
Volume control 51
 Menu structure 51

W

Wall mount support 85
 Kit content 85
Wall mounting support 85, 87
 Horizontal 85
 Vertical 87

Revision Sheet

To:

► **Barco nv Events/Documentation**
Noordlaan 5, B-8520 Kuurne
Phone: +32 56.36.89.70, Fax: +32 56.36.88.24
E-mail: antoon.dejaegher@barco.com, Web: www.barco.com

From: _____

Date: _____

Please correct the following points in this documentation (**R5976672/04**):

page

wrong

correct

Free Manuals Download Website

<http://myh66.com>

<http://usermanuals.us>

<http://www.somanuals.com>

<http://www.4manuals.cc>

<http://www.manual-lib.com>

<http://www.404manual.com>

<http://www.luxmanual.com>

<http://aubethermostatmanual.com>

Golf course search by state

<http://golfingnear.com>

Email search by domain

<http://emailbydomain.com>

Auto manuals search

<http://auto.somanuals.com>

TV manuals search

<http://tv.somanuals.com>