

**BARCO** **VISION**  
**508**

**R9002130**  
**R9002139**

## **OWNER'S MANUAL**

Due to constant research, the information in this manual is subject to change without notice.

Produced by BARCO NV, December 1998.  
All rights reserved.

Trademarks are the rights of their respective owners.

**BARCO n.v./Projection Systems**

Noordlaan 5

B-8520 Kurne

Belgium

Tel : +32/56/368211

Fax : +32/56/351651

E-mail : [sales.bps@barco.com](mailto:sales.bps@barco.com)

Visit Barco at the web : <http://www.barco.com>

Printed in Belgium

# BARCO

BARCO PROJECTION SYSTEMS

**BARCO** VISION  
508

R9002130  
R9002139

**OWNER'S MANUAL**

Date :  
071298

Rev :  
02

Art. No. :  
R5975039



# TABLE OF CONTENTS

<b>TABLE OF CONTENTS .....</b>	<b>I-1</b>	Geometry Adjustments .....	6-4
<b>SAFETY INSTRUCTIONS .....</b>	<b>1-1</b>	Horizontal Phase Adjustment .....	6-5
On safety .....	1-1	Raster Shift Adjustment .....	6-5
On installation .....	1-2	Left-Right (east-west) Adjustments .....	6-7
On servicing .....	1-2	Top-Bottom (north-south) Adjustments .....	6-8
On cleaning .....	1-2	Horizontal Size Adjustment .....	6-9
On repacking .....	1-2	Vertical Linearity Adjustment .....	6-9
On illumination .....	1-2	Horizontal Size Adjustment .....	6-10
		Blanking Adjustments .....	6-10
		Convergence Adjustment .....	6-12
<b>LOCATION AND FUNCTIONS OF CONTROL .....</b>	<b>2-1</b>	<b>SERVICE MODE .....</b>	<b>7-1</b>
Rear Panel Terminology .....	2-1	Starting up the Service mode .....	7-1
Front Panel Terminology .....	2-1	Overview flowchart 'Service' mode .....	7-1
Control panel terminology .....	2-2	Projector Set-up .....	7-2
a. The local keypad .....	2-2	Identification .....	7-2
b. RCU control panel terminology .....	2-2	Total Run Time .....	7-3
<b>CONNECTIONS .....</b>	<b>3-1</b>	Change password .....	7-3
Switching on/off .....	3-1	Change Projector Address .....	7-3
Signal input connection to the projector : .....	3-1	Change baudrate .....	7-4
Power (mains) cord connection .....	3-1	Power up mode .....	7-4
Connecting a Composite Video source. ....	3-2	Memory management .....	7-4
Connecting a S-Video to port 2 .....	3-2	Copy a block .....	7-5
Connecting a RGB Analog source with composite sync. ....	3-3	Deletion of blocks .....	7-5
Connecting a Component source. ....	3-4	Deleting block by block .....	7-5
Connecting a RF signal to the projector (optional) .....	3-4	Deletion of all blocks .....	7-6
Connecting an external audio signal (optional) .....	3-5	All settings to midposition .....	7-6
Peripheral equipment .....	3-5	Undo all settings to midpos .....	7-6
Connecting a RCVDS 05 switcher to the projector. ....	3-5	R & B convergence mid .....	7-7
Connecting a VS05 switcher to the projector. ....	3-5	Undo R & B convergence mid .....	7-7
Connecting an IR Remote Receiver to the projector .....	3-5	Green convergence mid .....	7-7
		Undo green convergence mid .....	7-7
<b>CONTROLLING .....</b>	<b>4-1</b>	Common Settings .....	7-8
Battery installation in the RCU. ....	4-1	G2 Adjustment .....	7-8
How to use the RCU .....	4-2	CRT run in cycle .....	7-8
Projector address .....	4-2	I2C Diagnostics .....	7-9
How to display a projector address? .....	4-2	<b>OPTIONS .....</b>	<b>8-1</b>
How to program an address into the RCU? .....	4-3	IR Receiver 800 .....	8-1
Input selection .....	4-3	Hardwired RCU. ....	8-1
Picture controls .....	4-4	RCVDS 05 Source Selector .....	8-1
The Pause key. ....	4-4	VS05 Switcher .....	8-1
Sound control with the RCU (optional) .....	4-5	Adapter and communication cables .....	8-1
		Ceiling mount CM50 .....	8-1
		Tuner kit .....	8-2
<b>START UP OF THE ADJUSTMENT MODE .....</b>	<b>5-1</b>	<b>APP. A : TUNER MODE .....</b>	<b>A-1</b>
Adjustment mode .....	5-1	Tuner mode .....	A-1
		How to activate the tuner mode ? .....	A-1
<b>RANDOM ACCESS ADJUSTMENT MODE .....</b>	<b>6-1</b>	Tuner setup .....	A-2
Starting up the random access adjustment mode. ....	6-1	Broadcasting System .....	A-2
Overview 'random Access Adjustment' mode. ....	6-1	Auto search .....	A-3
Selecting Setup Pattern .....	6-2	Manual search .....	A-3
Internal Cross Hatch Pattern .....	6-2	Organise channel list .....	A-4
Random access adjustment mode selection menu. ....	6-2	Bilingual .....	A-4
Picture Tuning .....	6-2	Teletext .....	A-5
Color Balance .....	6-3		
Gamma .....	6-3		
Blue stretch .....	6-3		
Decoding .....	6-3		
Color Select .....	6-4		

# 1

## SAFETY INSTRUCTIONS

### Notice on Safety

This equipment is built in accordance with the requirements of the international safety standards EN60950, UL 1950 and CSA C22.2 No.950, which are the safety standards of information technology equipment including electrical business equipment.

These safety standards impose important requirements on the use of safety critical components, materials and isolation, in order to protect the user or operator against risk of electric shock and energy hazard, and having access to live parts. Safety standards also impose limits to the internal and external temperature rises, radiation levels, mechanical stability and strength, enclosure construction and protection against the risk of fire.

Simulated single fault condition testing ensures the safety of the equipment to the user even when the equipment's normal operation fails.

### INSTALLATION INSTRUCTIONS

*Before operating this equipment please read this manual thoroughly, and retain it for future reference.*

*Installation and preliminary adjustments should be performed by qualified BARCO personnel or by authorized BARCO service dealers.*

### OWNER'S RECORD

The part number and serial number are located at the back side of the projector. Record these numbers in the spaces provided below. Refer to them whenever you call upon your BARCO dealer regarding this product.

PART NUMBER:

SER. NUMBER:

DEALER:

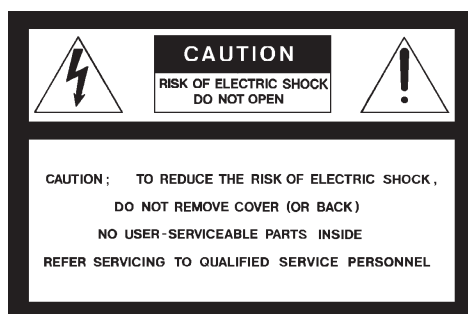

The lightning flash with an arrowhead within a triangle is intended to tell the user that parts inside this product may cause a risk of electrical shock to persons.



The exclamation point within a triangle is intended to tell the user that important operating and/or servicing instructions are included in the technical documentation for this equipment.

**WARNING**  
**TO PREVENT FIRE OR ELECTRICAL SHOCK HAZARD, DO NOT EXPOSE THIS EQUIPMENT TO RAIN OR MOISTURE**

### FEDERAL COMMUNICATION COMMISSION (FCC STATEMENT)

This equipment has been tested and found to comply with the limits of a class A digital device, pursuant to Part 15 of the FCC Rules. These limits are designed to provide reasonable protection against harmful interference when the equipment is operated in a commercial environment. This equipment generates, uses and can radiate radio frequency energy and, if not installed and used in accordance with the instruction manual, may cause harmful interference to radio communications. Operation of this equipment in a residential area is likely to cause harmful interference in which case the user will be required to correct the interference at his own expense.

Note :

The use of shielded cables is required to comply within the limits of Part 15 of FCC rules and EN55022.

- \* All the safety and operating instructions should be read before using this unit.
- \* The safety and operating instructions manual should be retained for future reference.
- \* All warnings on the equipment and in the documentation manuals should be adhered to.
- \* All instructions for operating and use of this equipment must be followed precisely.

### On safety

1. This product should be operated from an AC power source. This projector may be connected to an IT-power system.

Operating AC power voltage of the projector:

BARCOVISION 508  
Art. No. R9002130 (230V AC)  
Art. No. R9002139 (120V AC)

Consult your dealer to switch over from 230Vac to 120 Vac or from 120Vac to 230 Vac.

If you are not sure of the type of AC power available, consult your dealer or local power company.

2. This product is equipped with a 3-wire grounding plug, a plug having a third (grounding) pin. This plug will only fit into a grounding-type power outlet. This is a safety feature. If you are unable to insert the plug into the outlet, contact your electrician to replace your obsolete outlet. Do not defeat the purpose of the grounding-type plug.

**WARNING FOR THE CUSTOMERS:** THIS APPARATUS MUST BE GROUNDED (EARTHED) via the supplied 3 conductor AC power cable.

(If the supplied power cable is not the correct one, consult your dealer.)

## Safety Instructions

### A. Mains lead (Power cord) with CEE 7 plug:

The wires of the mains lead are colored in accordance with the following code.

Green and yellow: earth (safety earth)  
Blue: neutral  
Brown: line (live)

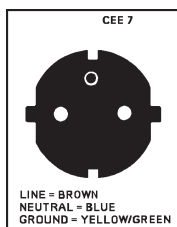

### B. Power cord with ANSI 73.11 plug:

The wires of the power cord are colored in accordance with the following code.

Green/yellow: ground  
White: neutral  
Black: line (live)

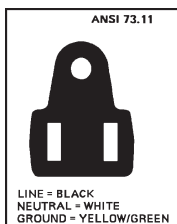

3. Do not allow anything to rest on the power cord. Do not locate this product where persons will walk on the cord.

To disconnect the cord, pull it out by the plug. Never pull the cord itself.

4. If an extension cord is used with this product, make sure that the total of the ampere ratings on the products plugged into the extension cord does not exceed the extension cord ampere rating. Also make sure that the total of all products plugged into the wall outlet does not exceed 15 amperes.

5. Never push objects of any kind into this product through cabinet slots as they may touch dangerous voltage points or short out parts that could result in a risk of fire or electrical shock.

Never spill liquid of any kind on the product. Should any liquid or solid object fall into the cabinet, unplug the set and have it checked by qualified service personnel before resuming operations.

6. Lightning - For added protection for this video product during a lightning storm, or when it is left unattended and unused for long periods of time, unplug it from the wall outlet. This will prevent damage to the projector due to lightning and AC power-line surges.

### On installation

1. Do not place this equipment on an unstable cart, stand, or table. The product may fall, causing serious damage to it.

2. Do not use this equipment near water.

3. Slots and openings in the cabinet and the back or bottom are provided for ventilation; to ensure reliable operation of the product and to protect it from overheating, these openings must not be blocked or covered. The openings should never be blocked by placing the product on a bed, sofa, rug, or other similar surface. This product should never be placed near or over a radiator or heat register.

The projector should not be placed in a built-in installation or enclosure unless proper ventilation is provided.

4. Do not block the projector cooling fans or free air movement under and around the projector. Loose papers or other objects may not be nearer to the projector than 4" on any side.

### On servicing

Do not attempt to service this product yourself, as opening or removing covers may expose you to dangerous voltage potentials and risk of electric shock!

Refer all servicing to qualified service personnel.

Unplug this product from the wall outlet and refer servicing to qualified service personnel under the following conditions:

tions:

a. When the power cord or plug is damaged or frayed.

b. If liquid has been spilled into the equipment.

c. If the product has been exposed to rain or water.

d. If the product does not operate normally when the operating instructions are followed.

Note : Adjust only those controls that are covered by the operating instructions since improper adjustment of the other controls may result in damage and will often require extensive work by a qualified technician to restore the product to normal operation.

e. If the product has been dropped or the cabinet has been damaged.

f. If the product exhibits a distinct change in performance, indicating a need for service.

**Replacement parts** - When replacement parts are required, be sure the service technician has used original BARCO replacement parts or authorized replacement parts which have the same characteristics as the BARCO original part. Unauthorized substitutions may result in degraded performance and reliability, fire, electric shock or other hazards. Unauthorized substitutions may void warranty.

**Safety check** - Upon completion of any service or repairs to this projector, ask the service technician to perform safety checks to determine that the product is in proper operating condition.

### On cleaning

**Unplug this product from the wall outlet before cleaning. Do not use liquid cleaners or aerosol cleaners. Use a damp cloth for cleaning.**

- To keep the cabinet looking brand-new, periodically clean it with a soft cloth. Stubborn stains may be removed with a cloth lightly dampened with mild detergent solution. Never use strong solvents, such as thinner or benzine, or abrasive cleaners, since these will damage the cabinet.

- To ensure the highest optical performance and resolution, the projection lenses are specially treated with an anti-reflective coating, therefore, avoid touching the lens. To remove dust on the lens, use a soft dry cloth. Do not use a damp cloth, detergent solution, or thinner.

### On repacking

Save the original shipping carton and packing material; they will come in handy if you ever have to ship your equipment. For maximum protection, repack your set as it was originally packed at the factory.

### On illumination

In order to obtain the best quality for the projected image, it is essential that the ambient light which is allowed to fall on the screen be kept to an absolute minimum.

When installing the projector and screen, care must be taken to avoid exposure to ambient light directly on the screen. Avoid adverse illumination on the screen from direct sunlight or fluorescent lighting fixtures.

The use of controlled ambient lighting, such as incandescent spot light or a dimmer, is recommended for proper room illumination. Where possible, care should also be taken to ensure that the floors and walls of the room in which the projector is to be installed are non-reflecting, dark surfaces. Brighter surfaces will tend to reflect and diffuse the ambient light and hence reduce the contrast of the projected image on the screen.

## 2

## LOCATION AND FUNCTIONS OF CONTROL

## Rear Panel Terminology

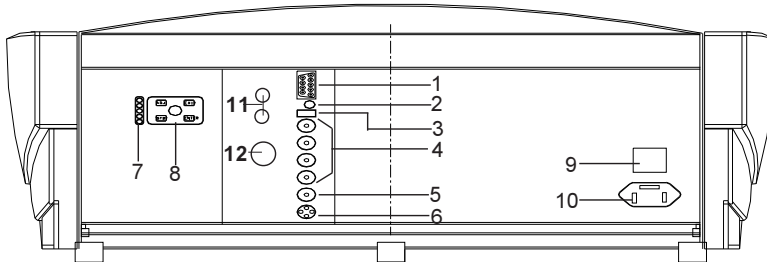

- |   |   |
|---|---|
| <p><b>1 Communication port (800 peripherals)</b></p> <ul style="list-style-type: none"> <li>• allows communication between the RCVDS switcher and the projector.</li> <li>• allows connection of a remote IR receiver unit to the projector.</li> </ul> <p><b>2 IR Remote</b> - Remote input for wired remote control</p> <p><b>3 IR sensor</b> Receiver for control signals transmitted from the RCU.</p> <p><b>4 RGB-S IN or (R-Y)Y(B-Y)-S IN (4x BNC connector):</b><br/> <i>RGB-S in</i> : allows a character generator, video camera, etc. having analog RGB output to be connected to the projector.<br/>       Line inputs: - signals RED-GREEN-BLUE<br/>                         - COMPOSITE sync. signal</p> <p><i>(R-Y)Y(B-Y)-S in</i> : allows to connect e.g. a professional VCR having component outputs to the projector.<br/>       Line inputs: - signals RED-LUMA, LUMA, BLUE-LUMA<br/>                         - COMPOSITE sync. signal</p> <p><b>5 VIDEO IN (Composite video, 1x BNC connector):</b> allows a video tape recorder, video camera, color receiver/monitor, etc. having video line output to be connected to the projector.</p> <p><b>6 S-VIDEO IN:</b> Separated Y/C (luma-chroma) signal inputs and outputs for higher quality playback of Super VHS signals (4-pin S-VIDEO connector).</p> | <p><b>7 Auto diagnosis display</b></p> <ul style="list-style-type: none"> <li>○ STD BY / NORMAL</li> <li>○ PAUSE</li> <li>○ COINCIDENCE</li> <li>○ EHT HOLD DOWN</li> <li>○ IRCODERXD</li> </ul> <p><b>8 Local key Pad</b></p> <p><b>9 Power (Mains) Switch:</b> Press this switch to turn on the projector.<br/>       Depending on the software set-up of the projector during installation, the projector switches to 'standby' or to 'operational mode'. If in standby, the standby led in the autodiagnosis display lights up.</p> <p><b>10 Power (Mains) input:</b> Connect the supplied ac power (mains) cord here and to the wall outlet.</p> <p><b>11 Audio output :</b> only if the tuner option is installed. Audio out to be connected to audio amplifier.</p> <p><b>12 RF input :</b> only if the tuner option is installed. Input for RF signals from a TV cable network or a TV antenna.</p> |
|---|---|

## Front Panel Terminology

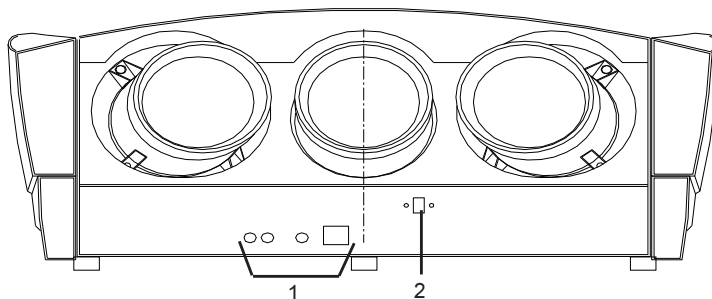

- 1 Audio ( Input, ON-OFF Switch, Output )**
- 2 IR SENSOR** Receiver for control signals transmitted from the RCU.

### Control panel terminology

#### a. The local keypad

**Gaining access**

The local keypad is at the rear side of the projector.

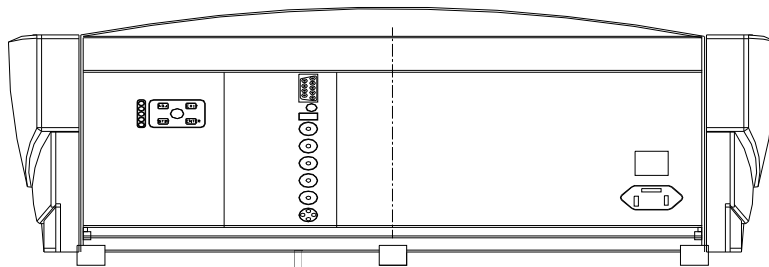

#### b. RCU control panel terminology

This remote control includes a battery powered infrared (IR) transmitter that allows the user to control the projector remotely. This remote control is used for source selection, control, adaptation and set-up. It includes automatic storing of :

- picture controls (Brightness, Sharpness,....)
- picture geometry adjustments
- convergence adjustments

Other functions of the remote control are:

- switching between standby and operational modes
- switching to "pause" (blanked picture, full power for immediate restarting)
- direct access to all connected sources
- variable adjustment speed : when pushing continuously on the arrow keys or the picture keys, the adjustment will be executed in an accelerated fashion.

RCU

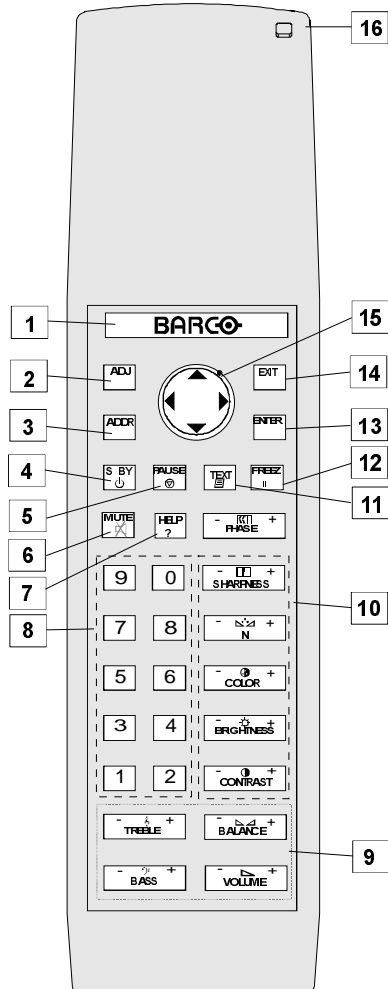

Local keypad

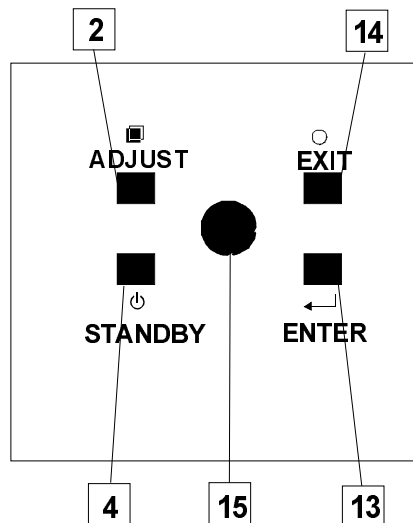

- stand-by
- pause/park
- sharpness
- tint
- color
- brightness
- contrast



- |   |   |
|---|---|
| <p><b>1</b> <b>BARCO key</b> : When a RF-tuner is built in (option), this key used to toggle between Video and tuner signal.</p> <p><b>2</b> <b>ADJ.</b> : adjust key, to enter or exit the adjustment mode.</p> <p><b>3</b> <b>Address key</b> (recessed key), to enter the address of the projector (between 0 and 9). Press the address key, followed by pressing one digit button between 0 and 9.</p> <p><b>4</b> <b>STBY</b> : stand by button :<br/>         - to initiate remote power up operation<br/>         - to stop projection without main power off.</p> <p><b>5</b> <b>Pause</b> :to blank the image, press PAUSE. The image disappears but full power is retained for immediate restarting.</p> <p><b>6</b> <b>Mute</b> : the picture stays while the audio is turned off. The power for the amplifiers stays.</p> <p><b>7</b> <b>Help.</b></p> <p><b>8</b> <b>Digit buttons</b> : direct input selection.</p> <p><b>9</b> <b>Audio control</b> : use these buttons to obtain the desired level (see also 'Controlling') for each audio function.</p> <p><b>10</b> <b>Picture controls</b> : use these buttons to obtain the desired level (see also 'Controlling') for each picture function.</p> | <p><b>11</b> <b>TEXT</b> :<br/>         During Video or RGB operation : when adjusting one of the image controls during a meeting, the displayed bar scale can be removed by pressing 'TEXT' key first. To re-display the bar scale on the screen, press 'TEXT' key again. 'TEXT' key is only active in operational mode. When 'TEXT' is off, no warning message will be displayed.<br/>         When in Tuner mode : this key is used to activate teletext.</p> <p><b>12</b> <b>FREEZ</b> : When in teletext mode (only when the tuner option is installed) this key is used to freeze the actual page.</p> <p><b>13</b> <b>ENTER</b> : to start up the adjustment mode or to confirm an adjustment or selection in the adjustment mode.</p> <p><b>14</b> <b>EXIT</b> : to leave the adjustment mode or to scroll upwards when in the adjustment mode.</p> <p><b>15</b> <b>Control disc</b> : to make menu selections when in the adjustment mode. Also allows to increment or decrement an adjustment in the adjustment mode.<br/>         control disc up = up arrow in the menus<br/>         control disc down = down arrow in the menus<br/>         control disc to the right = arrow to the right on the menus<br/>         control disc to the left = arrow to the left on the menus</p> <p><b>16</b> <b>RC operating indication</b> : lights up when a button on the remote control is pressed. (This is a visual indicator to check the operation of the remote control)</p> |
|---|---|

# 3

## CONNECTIONS

### Power (mains) cord connection

Use the supplied power cord to connect your projector to the wall outlet. Plug the female power connector into the male connector at the rear of the projector.

120/230 V  
4/2.5 A  
60/50 Hz  
300 W

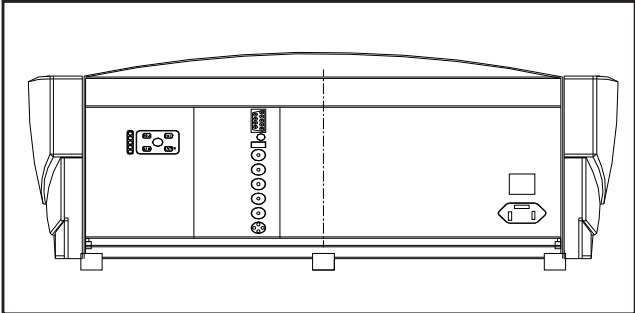

### Switching on/off

The projector is switched ON and OFF using the power (mains) switch ON/OFF.

Pressed : ON  
Not pressed : OFF

The projector can start now in the 'operational mode' (image displayed) or in the 'stand by mode', depending on the position of the 'power up' dip switch on the controller unit. This DIP switch is set during installation by a qualified technician. If you want to change this start up mode, call a qualified technician.

Stand by indication lamp :

No light up : Projector in operational mode  
Red : Projector is in stand by.

Leds on the rear plate of the projector

- STD BY / NORMAL
- PAUSE
- COINCIDENCE
- EHT HOLD DOWN
- IR CODE RXD

### Signal input connection to the projector :

- Composite Video
- S-Video
- RGSB or RGsB
- YsUV or YUVS [component input]

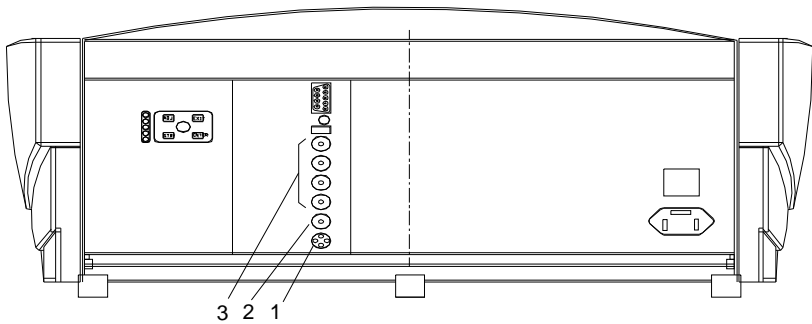

Source No	Projector input	Press digit button
1	Comp. Video	1
2	S-Video*	
3	RGsB	4
3	RGSB	5
3	YsUV	6
3	YUVS	7

\* Input signal Y/C (luma/chroma)

### Connecting a Composite Video source.

Composite video signals from a VCR, OFF air signal decoder, etc..

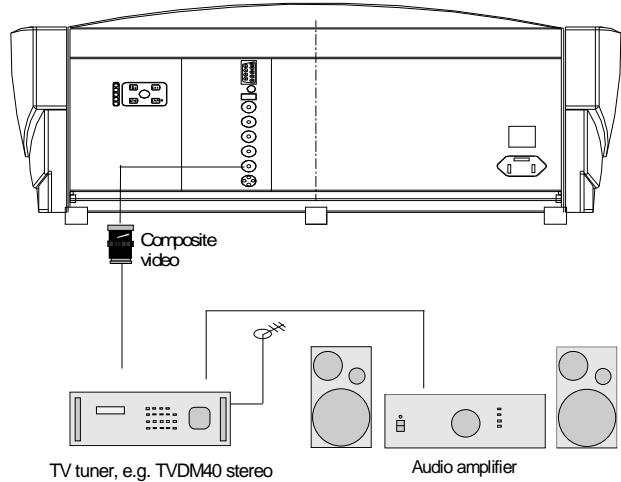

#### Video input selection :

- a. with the RCU : press digit button 1 or
- b. with the local keypad.
  - press **ADJUST** key, the General access menu is displayed on the screen.
  - use the control disc to highlight 1.
  - press **ENTER** to select the highlighted source.

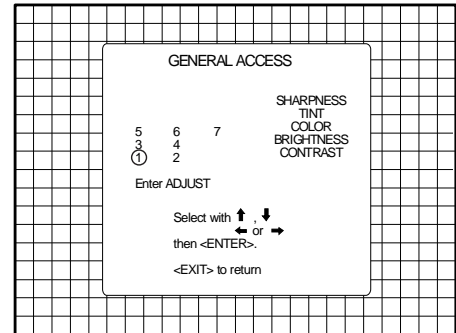

### Connecting a S-Video to port 2.

Separate Y-luma/C-chroma signals for higher quality playback of Super VHS signals.

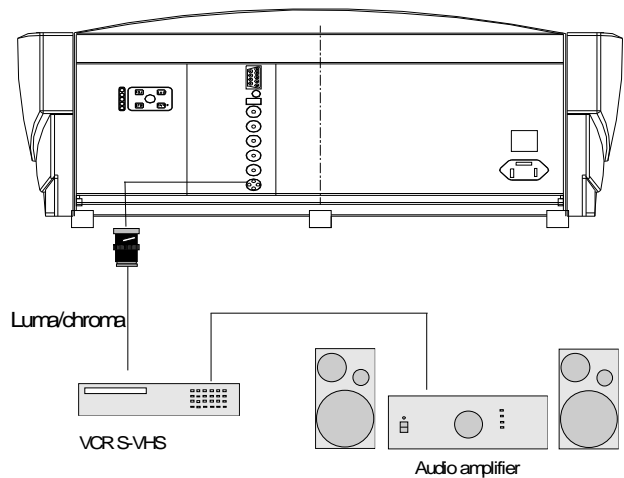

**Input selection**

- a. with the RCU : press digit button 2 or
- b. with the local keypad.

- press **ADJUST** key, the General access menu is displayed on the screen.
- use the control disc to highlight 2.
- press **ENTER** to select the highlighted source.

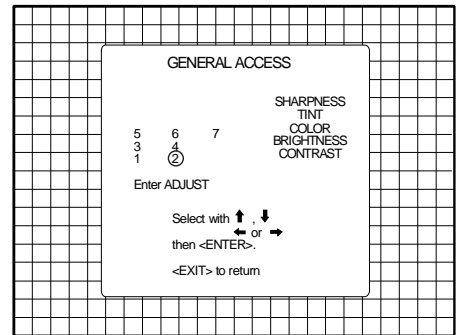

**Connecting a RGB Analog source with composite sync.**

RGB analog input terminals with composite sync input or with sync on green. The projector detects automatically where the sync signal is located.

Always use an interface when a computer and local monitor have to be connected to the projector. Examples of interfaces which can be applied :

Universal analog interface R9826100

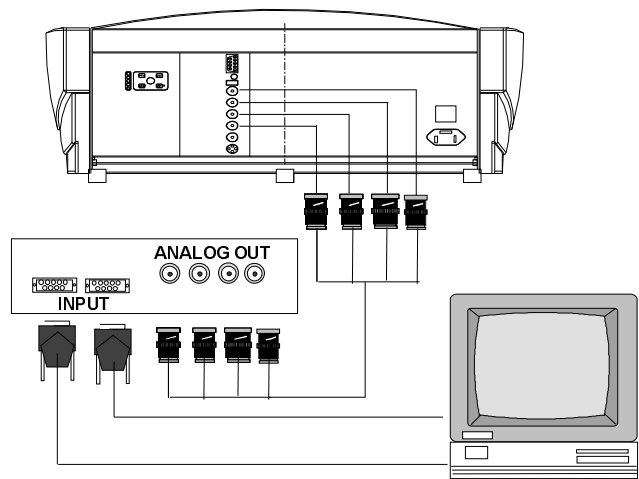

**RGBS (or RGsB) input selection**

- a. Press digit button 4 (or 5) on the RCU or
- b. With the local keypad :

- Press **ADJUST** key, the General access menu is displayed on the screen.
- Use the control disc to highlight 4 (or 5).
- Press **ENTER** to select the highlighted source.

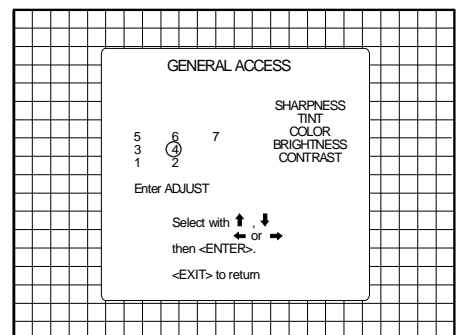

**Connecting a Component source.**

YUV analog input terminals with sync input or with sync on the luminance (Y) input.

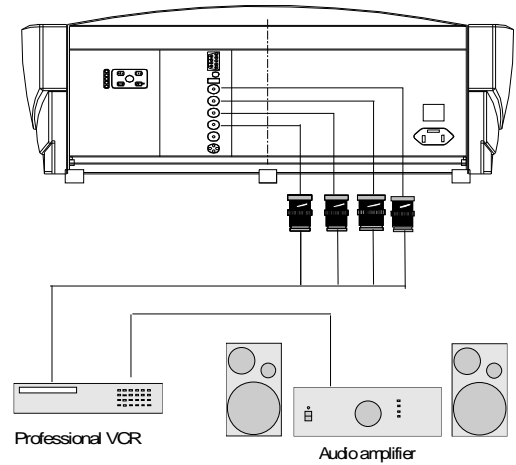

**YsUV or YUVS input selection**

- a. Press digit button 6 (for YsUV) or 7 (for YUVS) on the RCU or
- b. With the local keypad :
  - Press **ADJUST** key, the General access menu is displayed on the screen.
  - Use the control stick to highlight 6 (7 for YUVS).
  - Press **ENTER** to select the highlighted source.

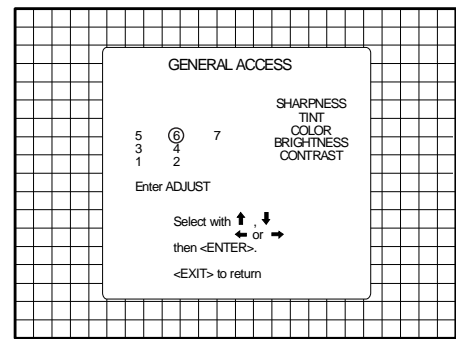

**Connecting a RF signal to the projector: (optional)**

The projector automatically detects the presence of a tuner.  
 Connect the RF signal to the RF input of projector  
 Connect the audio output to an audio amplifier.

To select the tuner option :

- a. Press the BARCO key to activate the tuner mode or
- b. With the local keypad :
  - Press **ADJUST** key to display the General access menu on the screen.
  - Use the control disc to highlight *Tuner*.
  - Press **ENTER** to activate the tuner mode.

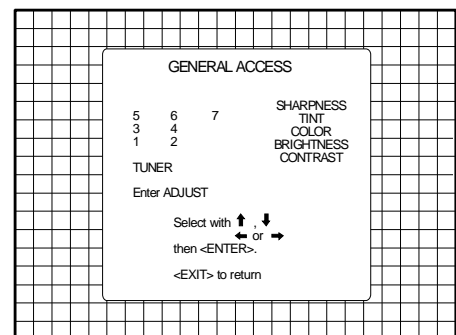
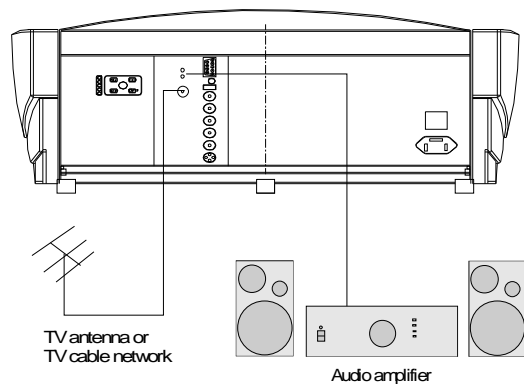

## Connecting an external audio signal to the projector: (optional)

Connect an external audio signal the audio input of projector is only possible when the tuner option is installed.

Connect your external source to the audio input (2 x cinch connector).

Connect external loudspeakers (Left and right) to the loudspeaker outputs of the projector.

Connecting speakers wires.

Peel back the vinyl covering and twist the wire core.

Push with your finger on the black lever of the R(right) speaker input and connect the speaker's minus (-) wire to the terminal. Remove your finger from the lever and gently pull the wire to confirm that it is securely connected.

Push with your finger on the red lever of the R(right) speaker input and connect the speaker's plus (+) wire to the terminal. Remove your finger from the lever and gently pull the wire to confirm that it is securely connected.

Repeat the same procedure for the left speaker.

Speaker switch.

With the switch on the front panel it is possible to select external loudspeakers or internal loudspeakers.

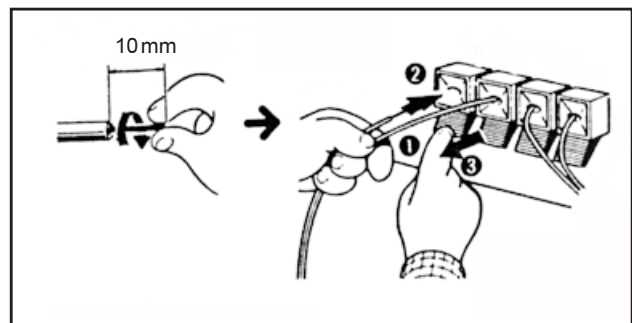
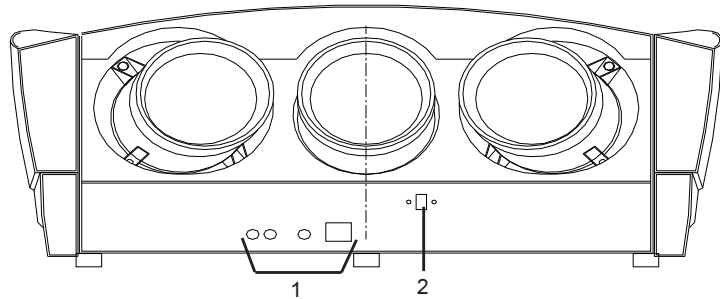

## Peripheral equipment

### Connecting a RCVDS 05 switcher to the projector.

- Up to 10 inputs (20 inputs when video and S-video) with the RCVDS 05 switcher and up to 90 inputs when 10 RCVDS switchers are linked via the expansion modules.
- Serial communication with the projector.
- Remote control buttons on the RCVDS to control the projector (source selection and analog settings)
- The selected source number will be displayed on a 2 digit display and the selected input modules will be indicated with a LED on the rear.

For more information about the use of the RCVDS 05, consult the Owner's Manual, order number: R5975765.

### Connecting a VS05 switcher to the projector.

The VS05 can switch up to 5 Composite Video sources, 3 S-Video Sources and 1 RGB analog or component Video source to the projector. In addition, the audio signal proper to the source, can be switched to an audio amplifier.

Order number : R9827890.

For more information about the use of the VS05, consult the Owner's Manual, order number: R5975245.

### Connecting an IR Remote Receiver to the projector

This infra-red receiver unit makes it possible to control the projector from another room. There is a communication line cable between the IR receiver and the projector or the RCVDS. The infrared control information from the Remote Control Unit is sent to the IR Remote Receiver. The IR Remote Receiver 800 displays the selected source on a 7-segment display.

Order number : R9827515.

## 4

## CONTROLLING

**Caution** : Do not display a stationary image with full brightness and contrast for longer than 20 min., otherwise you risk damage to the CRT's.

### Battery installation in the RCU.

A new battery is delivered inside the plastic bag with the power cord. Before using the RCU, install first the battery.

Remove the battery cover on the backside of the remote control by pushing the indicated handle a little to the bottom of the RCU. Lift up the top side of the cover at the same time (fig. 1).

Insert the new 9 V battery (E-block type, e.g. 6F22S or equivalent) in the lower compartment and connect the battery to the contact plate.

Insert the battery into the lower compartment and put the cover back.

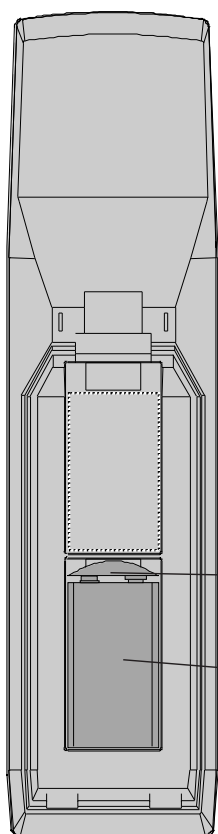

Contact plate

Battery

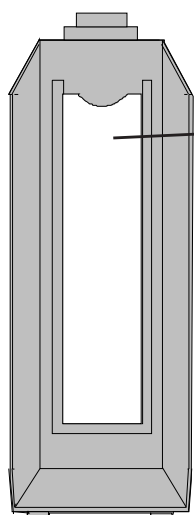

Insert here, behind the plastic cover, the 'Insert card for RCU'. You can cut out this card on one of the last pages of this manual.

fig.2

310a.DRW

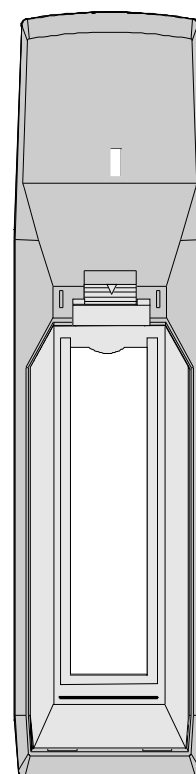

fig.1

## Controlling

The projector can be controlled with

- The RCU
- The hardwired RCU (cable not included)
- The local keypad.

Controlling the projector with the RCU and the hardwired RCU is the same.

### How to use the RCU

- Point the front of the RCU towards the reflective screen surface

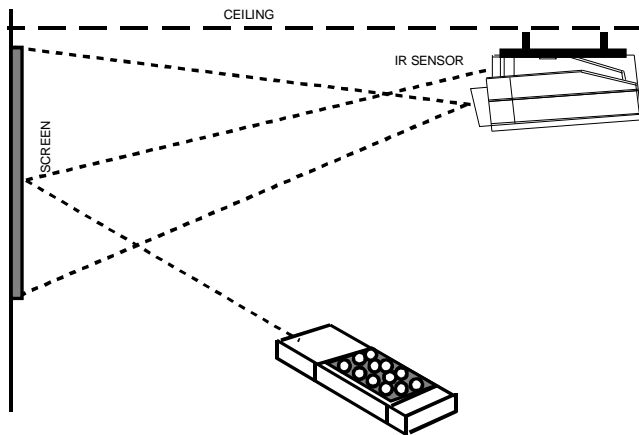

- Point the front of the RCU towards one of the IR sensors in the projector.

When using the wireless remote control, make sure you are within the effective operating distance (30m, 100ft in a straight line). The remote control unit will not function properly if strong light strikes the sensor window or if there are obstacles between the remote control unit and the projector's IR sensor.

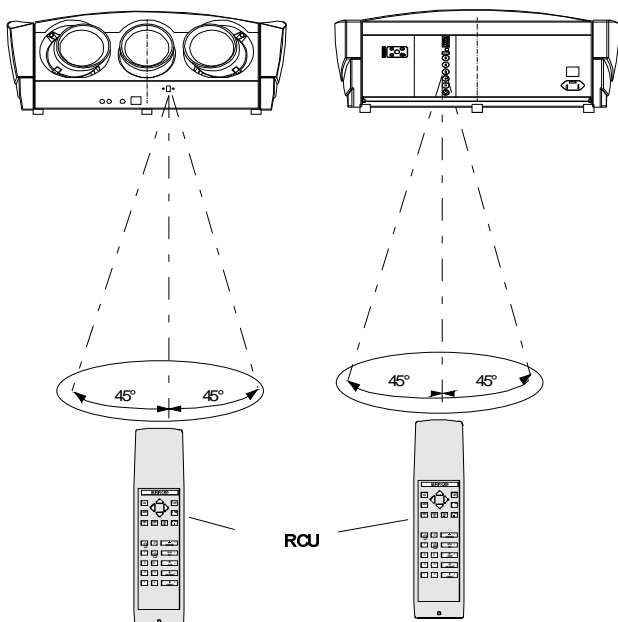

- RCU used in a hardwired configuration.

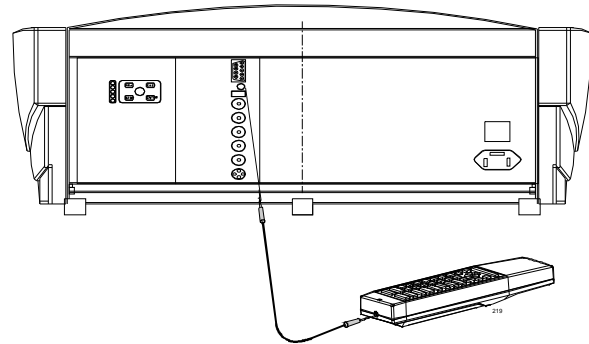

Plug one end of the remote cable in the connector on the bottom of the RCU and the second side in the connector in the rear panel of the projector labelled 'REMOTE'.

### Projector address

- Software set up of the projector address.

See 'Change Projector Address' in chapter 'Service mode'. Every projector requires an individual address between 0 and 255 which is set in the service mode. Only projectors with addresses between 0 and 9 can be controlled with the RCU.

- How to control the projector.

The projector's address may be set to any value between 0 and 255. When the address is set, the projector can be controlled with :

- the RCU for addresses between 0 and 9.
- Computer, e.g. IBM PC (or compatible), Apple MAC, etc. for addresses between 0 and 255.

Note : A projector will respond to an RCU set to an address of '0' regardless of what address is set in the projector itself.

- Using the RCU.

Before using the RCU, it is necessary to enter the projector address into the RCU (only when that address is between 1 and 9). The projector with the corresponding address will listen to that specific RCU.

When address 0, 'zero address' is programmed into the RCU, every projector, without exception will listen to the commands given by this RCU.

### How to display a projector address?

Press the ADDRESS key (recessed key on the RCU) with a pencil. The projector's address will be displayed in a 'Text box'. This text box disappears after a few seconds.

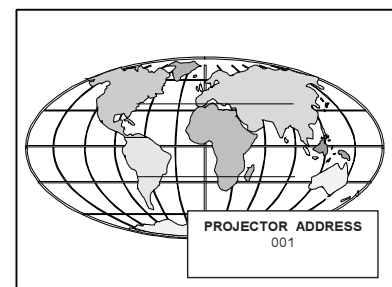



To continue using the RCU, it is necessary to enter an address with the digit buttons (address between 0 and 9). For example : if the Address key displays projector address 003, the press "3" digit button on the RCU to set the RCU's address to match the projector's address. Do not press digit 003. This will address the remote to '0' and control all projectors in the room.

### How to program an address into the RCU?

Press the ADDRESS key (recessed key on the RCU) with a pencil and enter the address with the digit buttons. That address can be any digit between 0 and 9.

### Input selection

Source No	Projector input	Press button
1	Comp. Video	1
2	S-Video	2
3	RGsB	4
3	RGBS	5
3	YsUV	6
3	YUVS	7

Two possible ways of selecting an input :

a) With the digit buttons on the RCU, it is possible to select one of the seven input sources, Video, S-Video, TV-Video, RGsB or RGBS, YsUV and YUV.

b) With the local keypad :  
press first the ADJUST key to display the *General access* menu.

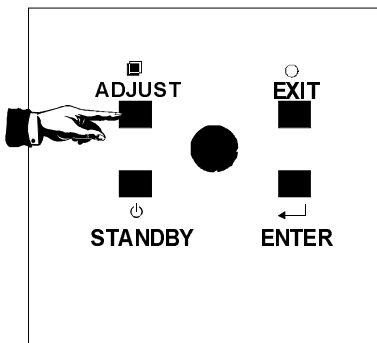

Use the control disc to highlight the desired source number. Push the control disc up or down to move the cursor up and down, push the

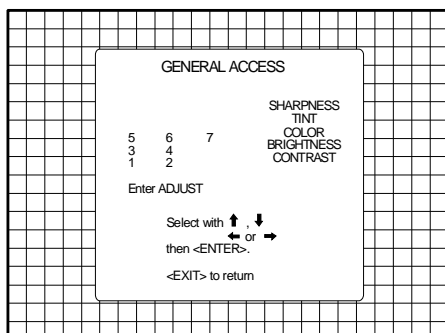

control disc to the left or to the right to move the cursor to the left and to the right.

Press ENTER to confirm your selection.

When a valid and available source is selected, there will be information displayed on the screen about that source. This information includes :

- Source number
- Horizontal frequency
- Vertical frequency

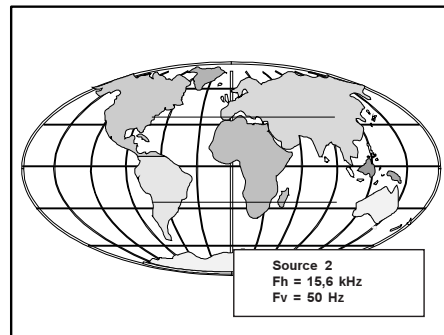

When the entry is a non valid source number, a warning appears on the screen : 'input not available'.

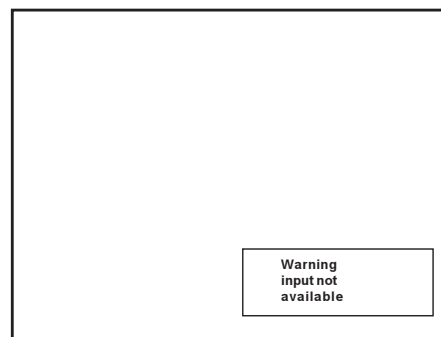

When a valid source number is selected, the projector will display this source or it will wait on the selected source number until the source becomes available. A message 'source not available' will be displayed for a short time.

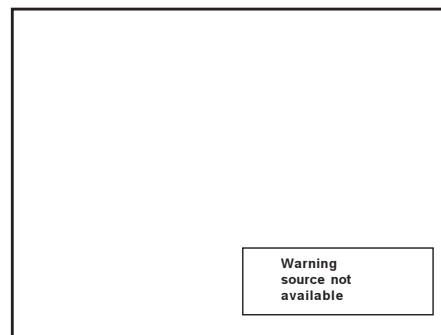

## Picture controls

The picture controls can be adjusted with :

- a) The RCU. The control keys are located on the left side of the key panel of the RCU and indicated with the name of the control and an icon.

When an image control is pressed, a text box with bar scale and the function name of the control, e.g. 'brightness...' appears on the screen (only if text is ON). The length of the bar scale indicates the current memorized setting for this source. The bar scale changes as the + or - buttons of the control are pressed.

- b) The local keypad

All controls are hidden in the General access menu.

- Press **ADJUST** to display the *General access* menu.
- Use the control disc to highlight the desired analog control and press **ENTER** to select.

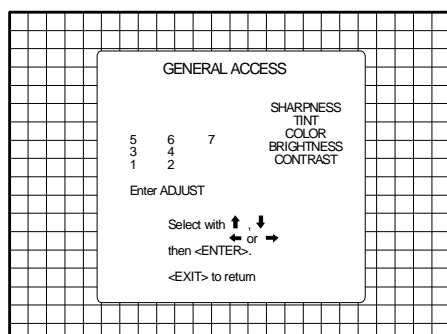
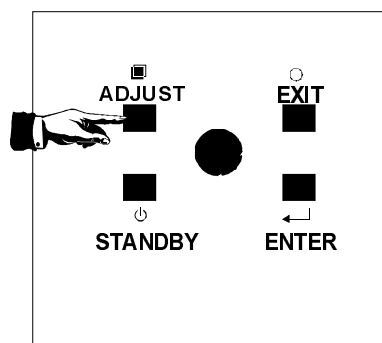

When a picture control is selected, a text box with bar scale and the function name of the control (e.g. brightness) appear on the screen. The length of the bar scale indicates the current memorized setting for this source (percentage scale). The bar scale changes as the control disc is pushed to the left or to the right.

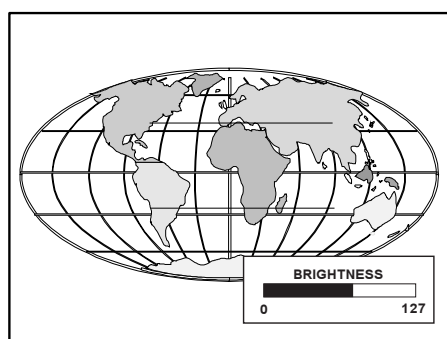

## Brightness Control

A correct 'brightness' setting is important for good image reproduction. Adjust the brightness with the + button and - button (RCU) or pushing the control disc to the left or to the right (local keypad) until the darkest parts of the picture appear black.

A bar scale gives a visual indication on the screen of the current brightness setting while pressing on the above indicated buttons. If the bar scale is not visible on the screen, press 'TEXT' once and retry the above indicated buttons.

The bar scale increases when pressing on the + button (higher brightness) and decreases when pressing on the - button (lower brightness).

## Contrast Control

A correct 'contrast' setting is important for good image reproduction. Adjust the contrast to the level you prefer, according to room lighting conditions.

A bar scale gives a visual indication on the screen of the current contrast setting while pressing the + or - buttons (RCU) or pushing the control disc to the left or to the right (local keypad). If the bar scale is not visible on the screen, press 'TEXT' key once and retry the above indicated buttons.

The bar scale increases when pressing on the + button (higher contrast) and decreases when pressing on the - button (lower contrast).

## Color Saturation Control

Color saturation is only active for Video and S-Video. Adjust the color intensity of the picture. Adjust the color saturation using the + and - buttons (RCU) or pushing the control disc to the left or to the right (local keypad). A bar scale gives a visual indication on the screen of the current color setting while pressing on the above indicated buttons. If the bar scale is not visible on the screen, press 'TEXT' key once and retry the above indicated buttons. The bar scale increases when pressing on the + button (richer colors) and decreases when pressing the - button (lighter colors).

## Tint Control

Tint is only active for Video and S-Video. Tint control is effective only when using the NTSC 4.43 or NTSC 3.58 system. A bar scale gives a visual indication on the screen of the current tint setting while pressing the + or - buttons (RCU) or pushing the control disc to the left or to the right (local keypad). If the bar scale is not visible on the screen, press the 'TEXT' key once and retry the above indicated buttons.

The bar scale increases when pressing on the + button and decreases when pressing the - button.

## Sharpness Control.

Sharpness control only active for Video and S-Video. A bar scale gives a visual indication on the screen of the current sharpness setting while pressing the + or - buttons (RCU) or pushing the control disc to the left or to the right (local keypad). If the bar scale is not visible on the screen, press 'TEXT' key once and retry the above indicated buttons.

The bar scale increases when pressing on the + button (sharper picture) and decreases when pressing on the - button (softer picture).

## The Pause key.

When the Pause key is pressed, the image projection is stopped but the projector remains with full power for immediate restart.

To restart the image :

- Press the Pause key,
- Select a source number.

## Sound control with the RCU (optional).

Only available when the tuner option is installed.

When an analog sound control is pressed, a bar scale and a number below the bar scale appear on the screen with name of the control, e.g. 'Volume' above it. The length of the bar scale and the number indicate the current setting for this source. The bar scale changes as the + or - buttons of the control are pressed.

The appearance of the text, bar scale and number can be prevented by pressing the 'TEXT' key. This button acts as a toggle switch, switching between 'ON' and 'OFF' each time the button is pressed. The latest position is memorized and is recalled when the power to the projector is switched OFF and ON again.

The analog sound controls can be adjusted in 'adjustment mode' as well as in 'operational mode'.

### Volume control

Adjust the volume with the + and - button until the desired level is obtained.

When TEXT is on; a bar scale and a number below the bar scale (between 0 and 100) give a visual indication on the screen of the current volume level while pressing on the + or - buttons.

The bar scale and numeric indicator increase when pressing the + button (higher sound level) and decrease when pressing the - button (lower sound level)

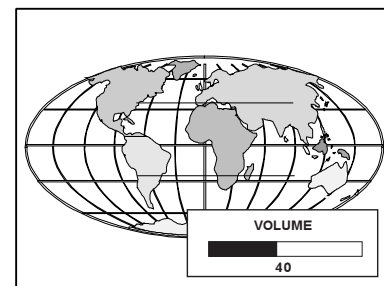

### Bass control

Adjust the bass level (low tones) with the + and - button until the desired level is obtained.

When TEXT is on; a bar scale and a number below the bar scale (between - 12 dB and + 15 dB) give a visual indication on the screen of the current bass level while pressing on the + or - buttons.

The bar scale and numeric indicator increase to the right when pressing the + button (higher bass reproduction) and increase to the left when pressing the - button (lower bass reproduction).

When on - 12 dB, the low tones are maximum suppressed. When on + 15 dB, the low tones are maximum amplified.

### Treble control

Adjust the treble level (high tones) with the + and - button until the desired level is obtained.

When TEXT is on; a bar scale and a number below the bar scale (between - 12 dB and + 12 dB) give a visual indication on the screen of the current treble level while pressing on the + or - buttons.

The bar scale and numeric indicator increase to the right when pressing the + button (higher treble reproduction) and increase to the left when pressing the - button (lower treble reproduction).

When on - 12 dB, the high tones are maximum suppressed. When on + 12 dB, the high tones are maximum amplified.

### Balance control

Adjust the balance with the + and - button until the desired balance is obtained.

When TEXT is on; a bar scale and a indicator below the bar scale (between L and R) give a visual indication on the screen of the current balance setting while pressing the + and - buttons.

The bar scale increase to the right while pressing the + button (higher sound level on the right box than on the left one) and increase to the left when pressing the - button (higher sound level on the left box than on the right one).

### Mute

When the 'Mute' key is pressed, the sound reproduction will be interrupted. To reproduce the sound, press 'Mute' key again.

# 5

## START UP OF THE ADJUSTMENT MODE

### Adjustment mode

All picture geometry and convergence adjustments are made while in the 'Adjustment mode'. Two possible ways to enter the adjustment mode :

a) Using the RCU.

Press the **ADJUST** key.  
The projector displays the path selection menu.

b) Using the local keypad.

Press the **ADJUST** key.  
The projector displays the *General access menu*.

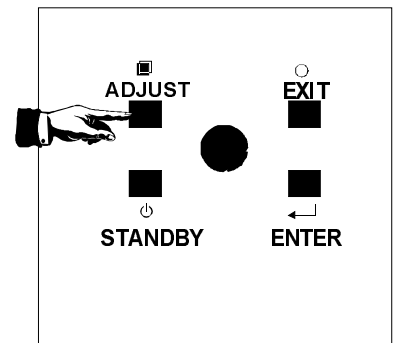

Use the control disk to highlight *enter ADJUST* and press **ENTER**. The path selection menu will be displayed.

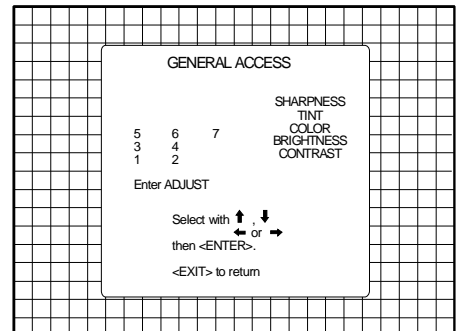

Note : to adjust the Analog picture control while in the 'Adjustment mode', press the **ADJUST** key. The next General Access menu will be displayed.

Push the control disk up or down to select the analog control to be adjusted and press the **ENTER** key to confirm.

When the analog control is adjusted the projector returns automatically to the General access menu. When you want to return to the Adjustment mode, press **EXIT**, otherwise select *quit ADJUST* and press **ENTER** to return to operational mode.

You are now in the '*Adjustment mode*'. The control disk is used to make menu selections and also vertical and horizontal adjustments. The **ENTER** and **EXIT** keys are used to move forward and backward through the menu structure. The **ADJUST** key can be used to terminate the adjustment mode while a path selection menu (head menu) is displayed.

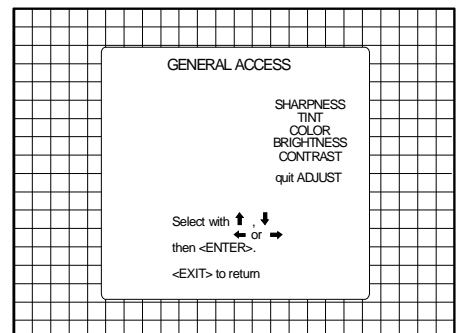

There are 4 possible paths to follow once in the Adjustment mode. They are :

**INSTALLATION** - Installation should be selected if the projector has been relocated and/or a different screen size is desired.

When selecting 'Installation', the user or operator will be warned to call a qualified technician to perform the installation procedure (see example of projected warning on next page).

**GUIDED** - Guided should be selected if the user intends to perform a complete alignment of the projected image. All of the necessary geometry and convergence adjustments are made in a predetermined sequence.

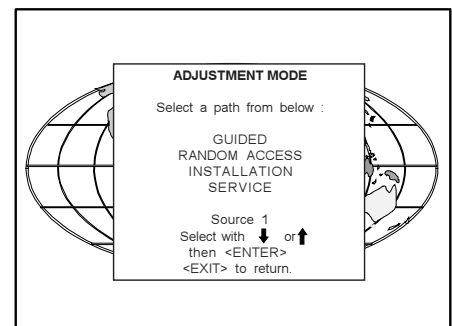

**RANDOM ACCESS** - Random Access should be selected if the user intends to make only a few adjustments.

**SERVICE** - Service should be selected if the user intends to delete blocks, change password or apply information.

While in Guided or Random Access adjustment Mode, the user may use an external source, an internally generated genlocked pattern or an internally generated multifrequency cross hatch pattern as a setup pattern.

**Warning during the start up of the installation mode**

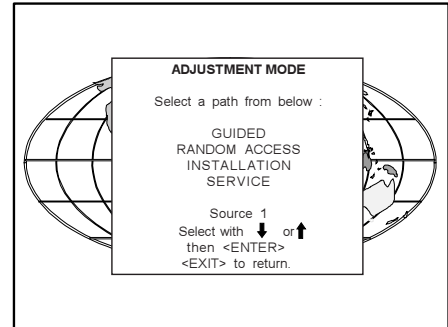

Some items in the Adjustment mode are password protected. While selecting such an item, the projector asks you to enter your password. (Password protection is only available when the password DIP switch on the controller module is in the ON position. Contact a BARCO authorized technician when no password is requested during the adjustment procedure and password protection is desired.) Your password contains 4 digits.

a) Adjusting the projector with the RCU.

Enter the digits with the numeric keys on the RCU.

Example : 2 3 1 9

For each digit entered, a 'X' appears on the screen under the displayed text 'enter password'.

When your password is correct, you get access to the 'Adjustment mode'. When the entered password is wrong, The message 'Wrong password !!!' will be displayed. The projector stays on the previous selected item.

Factory programmed password : **0000**

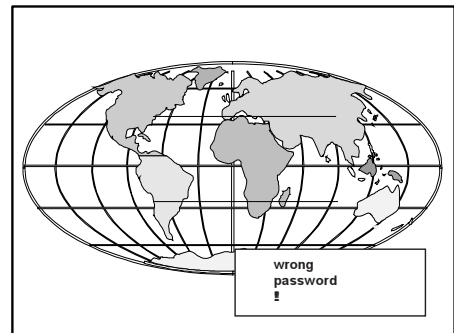
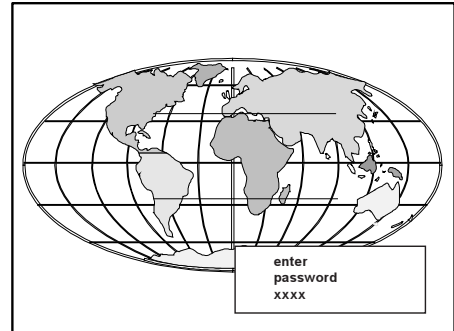

b) adjusting the projector with the local keypad.

When the 'compose password' menu is displayed, select with control disk the first digit of your password and press ENTER. Continue by selecting the second digit with the control disk and press ENTER. Handle in the same way for the third and fourth digit.

When your password is correct, you get access to the 'Adjustment mode'.

When the entered password is wrong, the message 'Wrong password' will be displayed.

Once the password is correctly entered, all other password protected items are accessible without re-entering your password. When re-entering the adjustment mode, it will be necessary to enter your password again when selecting a password protected item.

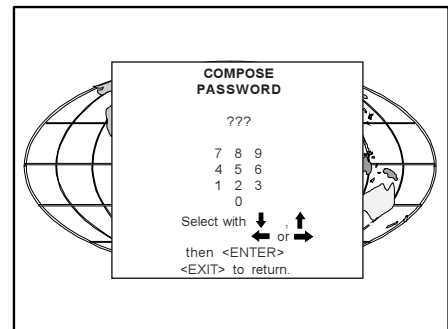

# 6

## RANDOM ACCESS ADJUSTMENT MODE

### Starting up the random access adjustment mode.

Push the control disc up or down to highlight "RANDOM ACCESS" and then press ENTER.

Some items in the Random access mode are password protected (when the password function is enabled). Enter your password to continue. All other password protected items are now also available if you stay in the adjustment mode.

ENTER continues to Setup Pattern Selection  
EXIT returns to operational mode

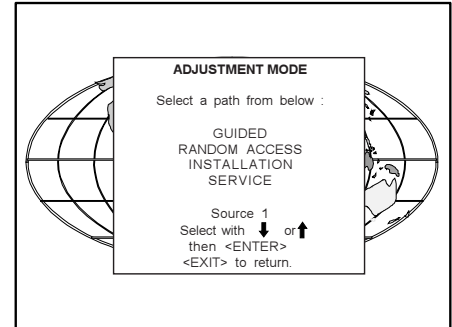

### Overview 'random Access Adjustment' mode.

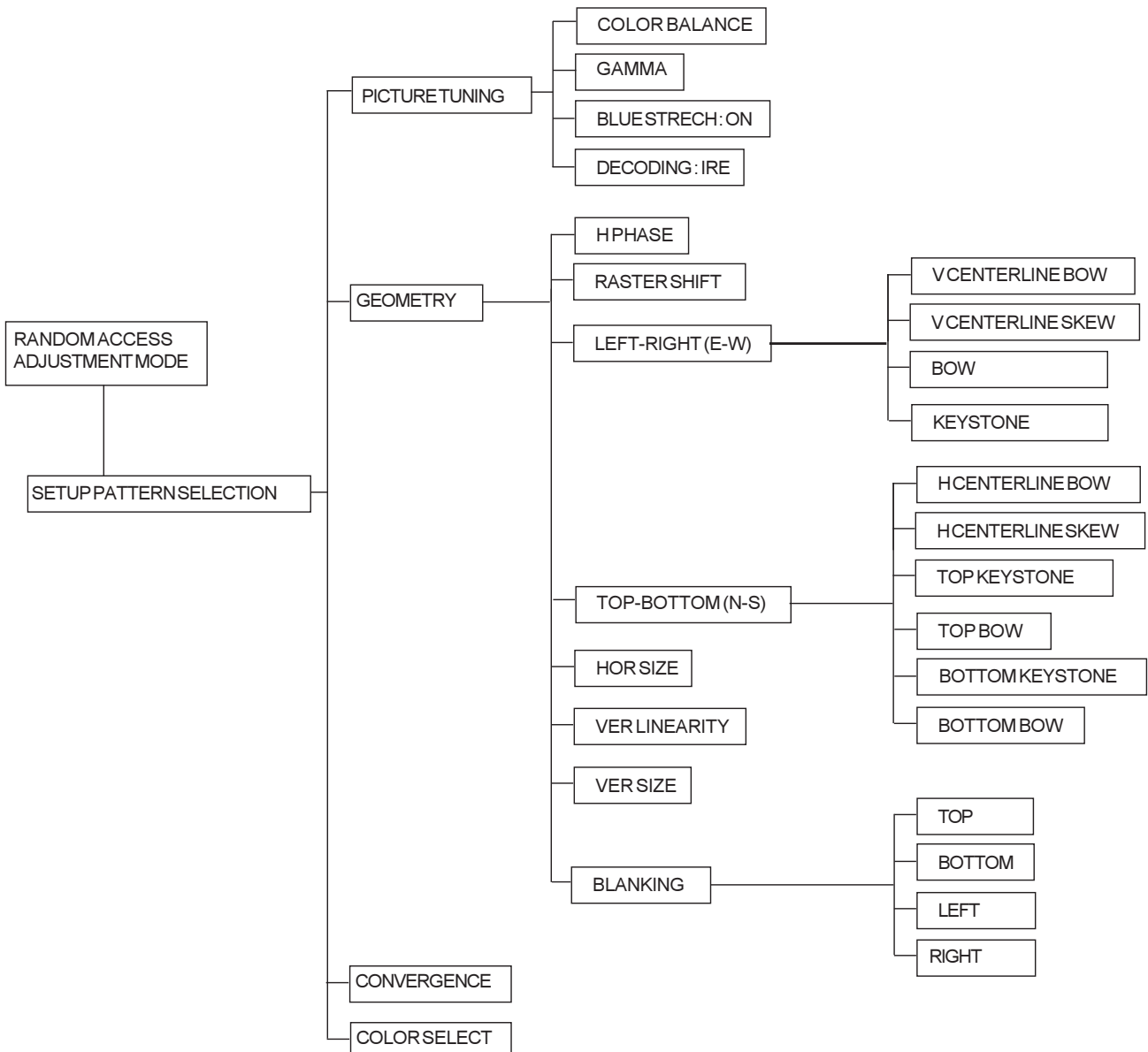

### Selecting Setup Pattern

If an external source is connected to the projector, this menu will be displayed. Push the control disc up or down to highlight the desired setup pattern and then press **ENTER**.

*Genlocked pattern* : internally generated cross hatch pattern, locked on the external source.

*Internal # pattern* : internally generated cross hatch pattern and locked on internal generated sync signals. (No external source necessary)

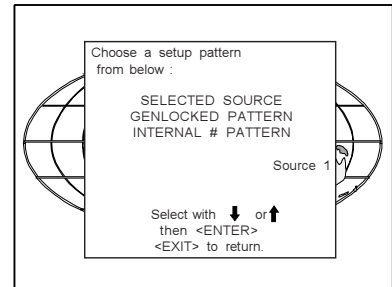

**ENTER** continues to Random Access Adjustment Mode or Internal # Pattern Selection  
**EXIT** returns to Path Selection menu  
**ADJUST** returns to Operational mode

If no external source is connected to the projector, the internal cross hatch pattern menu will be displayed.

*Note: The menus in this manual are created for an external source, connected to one of the inputs, and the 'Genlocked Pattern' is selected.*

### Internal Cross Hatch Pattern

The Internal # pattern menu will be displayed if the internal cross hatch pattern has been selected or if no source is connected to the projector.

The table below lists the 8 fixed factory preset frequencies available. Another 8 blocks are custom programmable.

Push the control disc up or down to highlight the desired cross hatch frequency. Push the control disc to the left or to the right to scroll to another page. Press **ENTER** if the desired block is selected.

kHz/Hz

15.6/50	PAL/SECAM
15.7/60	NTSC

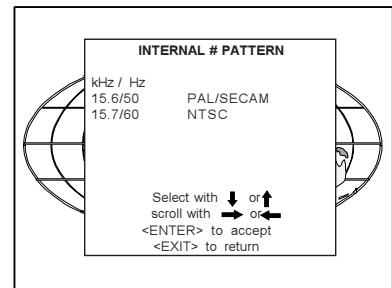

**ENTER** continues to the Random Access Adjustment Mode.  
**EXIT** returns to the Setup Pattern Selection menu.

### Random access adjustment mode selection menu.

This is the main menu for the Random Access adjustment mode. Through this menu, the following adjustments and features are accessible :

- Picture Tuning
  - Color Balance
  - Gamma
  - Blue Stretch : ON/OFF
  - Decoding (NTSC signal)
- Geometry
- Convergence
- Color select

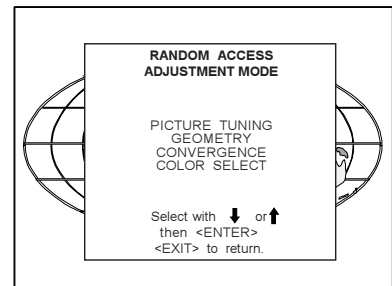

### Picture Tuning

Highlight *Picture tuning* by pushing the control disc up or down and press **ENTER**. The Picture tuning menu will be displayed. Depending on the input source, the 'Picture tuning' menu will display different items.

- Color Balance
- Gamma
- Blue Stretch : ON/OFF
- Decoding : EBU/IRE

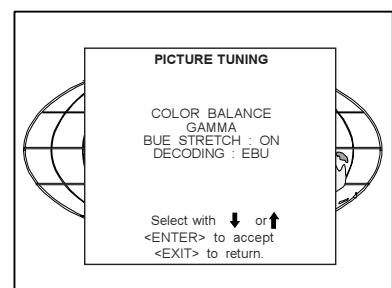

## Color Balance

The Color Balance function is used to select or adjust the color temperature of white used by the projector.

The Color Balance can be adjusted on two different ways :

- fixed color balance. You have the choice between 3200 K (reddish), 4900 K, 6500 K (white) or 9300 K (bluish).
- Custom white and black balance.

### Fixed Color Balance.

Highlight one of the 4 preprogrammed color temperatures with the control disc and press **ENTER** to display the desired color balance.

### Custom Color Balance.

Select custom white balance by pushing the control disc up or down and press **ENTER** to start the adjustment.

Push the control disc up or down to adjust the red gain and push the control disc to the left or to the right to adjust the blue gain. A bar scale indicates the amount of adjustment. Same for green.

Select custom black balance with the control disc and press **ENTER** to start the adjustment.

Push the control disc up or down to adjust the red cut-off and push the control disc to the left or to the right to adjust the blue cut-off. Same for green.

When the color balance is adjusted, press **EXIT** to return to the picture tuning menu.

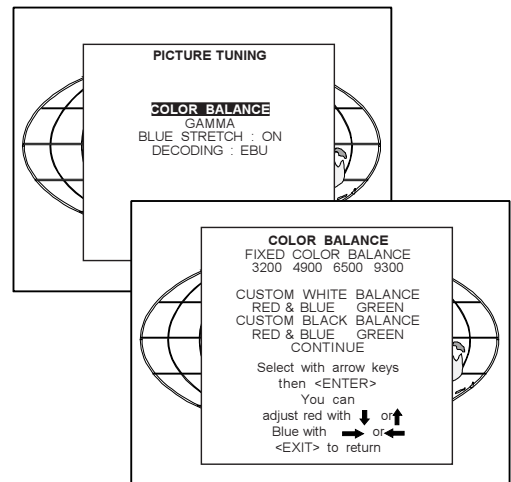

## Gamma

The gamma adjust function acts on the luminance content of the input signals. It has a non-linear amplification characteristics. At minimum gamma ( $< 1$ ) the lower parts of the signal are amplified with higher gain.

**ENTER** will select the gamma function.  
**EXIT** will return to the Random Access Adjustment menu.

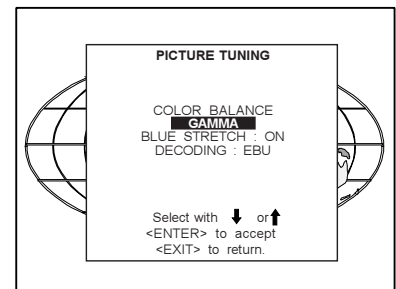

## Blue stretch

Whenever blue stretch is toggled to the ON position the blue channel gets additional amplification if the blue signal is greater than 80% of the nominal signal amplitude. In that case the white point is shifted towards higher colour temperature so that whiteparts of a picture seem to be brighter.

**ENTER** will toggle between on and off.  
**EXIT** will return to the random access selection menu.

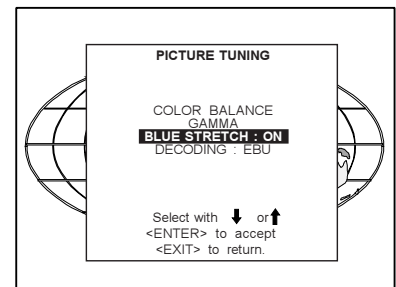

## Decoding

Only for NTSC signals.

The possibility is offered to decode the NTSC signals via the normal European EBU standard.

Highlight Decoding by pushing the control disc up or down and press **ENTER** to toggle between IRE and EBU (only available when a NTSC video signals is connected to the projector).

**ENTER** will toggle Decoding between EBU and IRE.  
**EXIT** will return to the Guided Adjustment menu.

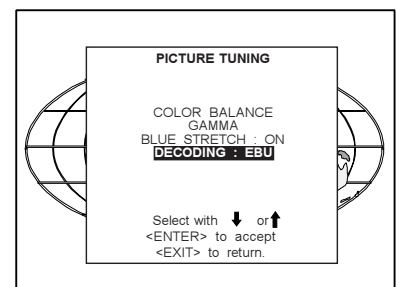



## Color Select

Highlight *COLOR SELECT* by pushing the control disc up or down and press **ENTER** to display the color select menu.

**ENTER** continues to the color select menu.  
**EXIT** will return to Internal Crosshatch Selection or Setup Pattern Selection Menu.  
**ADJUST** returns to operational mode.

Use the control disc to highlight a color (CRT) or combination of colors to display the projected image in that specific color.  
 To select a new color, press **ENTER**, the color selection menu appears again on the screen. To terminate the color select procedure, press **EXIT**.

**ENTER** continues with the selected color or color combination.  
**EXIT** returns to the Random access main menu.

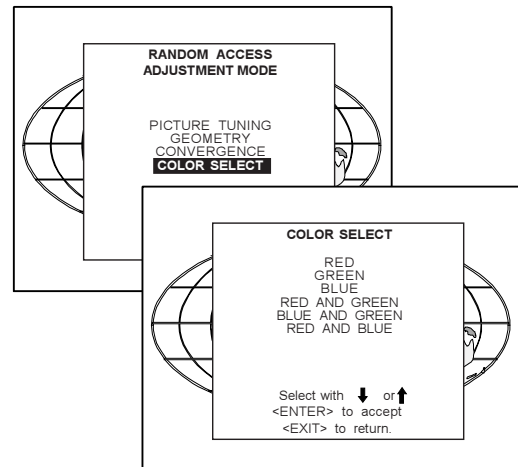

## Geometry Adjustments

The geometry adjustments have to be done only on the green image. These adjustments are automatically implemented for the other color images : Left-right (EW) and Top-Bottom Corrections, Blanking, Horizontal Amplitude, Vertical Amplitude, Vertical Linearity and Horizontal Phase.

Highlight *GEOMETRY* by pushing the control disc up or down and press **ENTER** to display the geometry menu.

**ENTER** will display Geometry menu.  
**EXIT** will return to Internal Crosshatch Selection or Setup Pattern Selection Menu.  
**ADJUST** returns to operational mode.

Within the Geometry Adjustment menu, the following adjustments are available :

- Horizontal Phase (not for internal # pattern).
- Raster Shift
- Left-Right Corrections
- Top-Bottom Corrections
- Horizontal Size
- Vertical Linearity
- Vertical Size
- Blanking

The convergence corrections are disabled during geometry corrections. The blanking corrections are only enabled during the blanking adjustments.

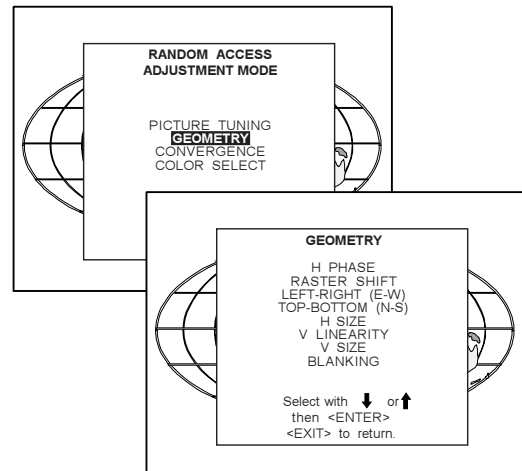

## Horizontal Phase Adjustment

Push the control disc up or down to highlight *H PHASE* on *Geometry menu* and then press **ENTER**.

Note : No horizontal phase adjustment is available on the internal # pattern.

For external sources :

If the raster shift is correctly adjusted, the H Phase text box is projected in the middle of the raster. At that moment, the "><" icon indicates the middle of the raster.

Adjust the H Phase control until the middle of the projected image is equal with the middle of >< icon.

Note :

- If the genlocked pattern was selected, the external source will be displayed.

A bar scale and a number indicator (between 0 and 100) on the screen give a visual indication of the horizontal phase adjustment.

**ENTER** continues to geometry menu .

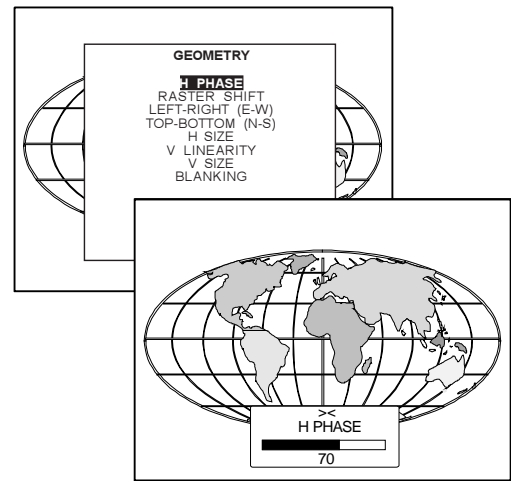

Push the control disc to the right to correct

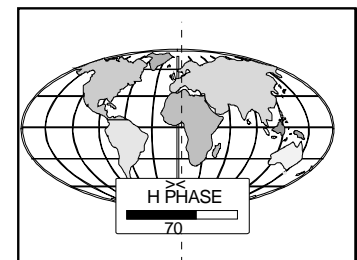

Push the control disc to the left to correct

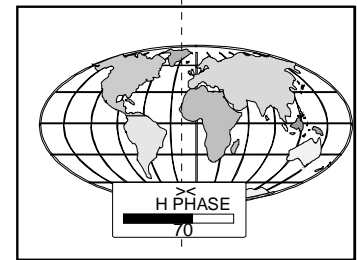

## Raster Shift Adjustment

The green raster must be centered both horizontally and vertically on the center of the CRT surface. To center the green raster, look into the green lens and use the control disc to move the raster.

### CAUTION

*It is necessary to look into the lenses to perform these adjustments. To avoid eye discomfort while looking into the lenses, reduce the contrast and gradually increase the brightness level until the raster becomes visible on the face of the CRT.*

**ENTER** will select green raster shift adjustment  
**EXIT** returns to random access adjustment mode menu.

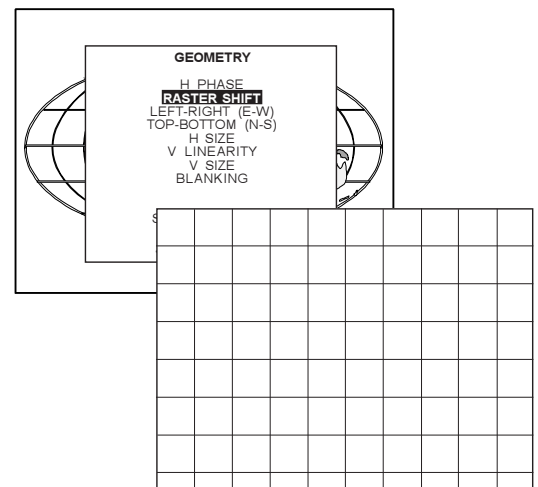

**Warning :** In order to ensure maximum CRT longevity and to avoid CRT damage, do not shift the raster outside the phosphor area of the CRT.

To start the adjustment, use the control disc to highlight Raster shift and press ENTER to display the green raster on the phosphor.

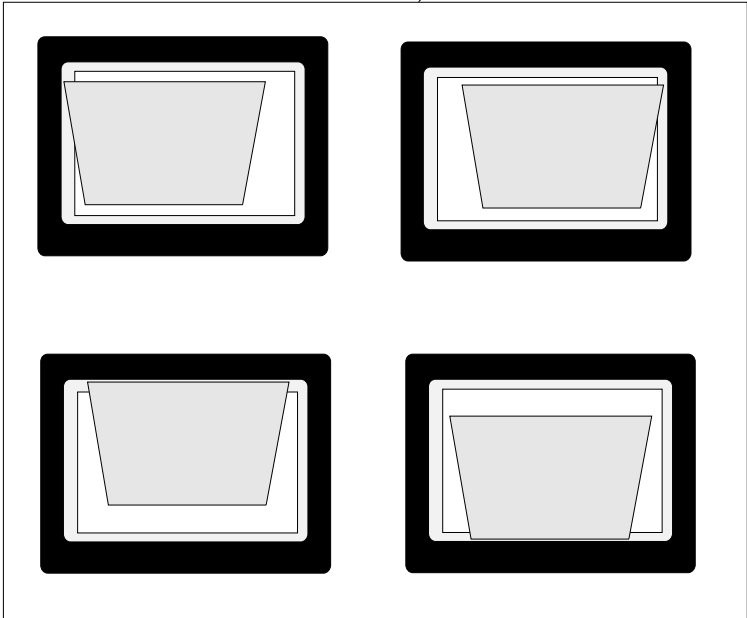
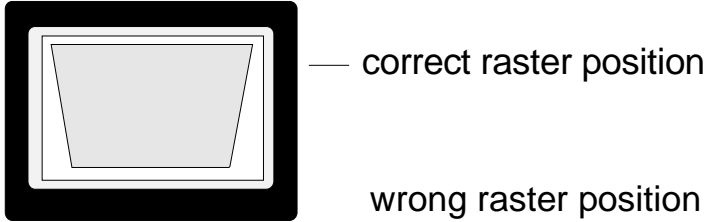
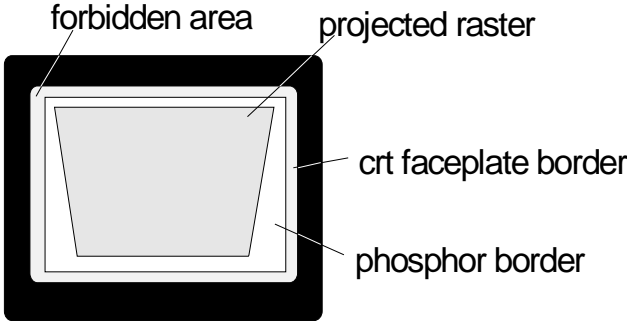

Press EXIT to return to the Geometry menu.

## Left-Right (east-west) Adjustments

Left-right and center adjustments affect only the vertical lines of the projected image.

To start up the left-right and center adjustments, follow the next procedure :

Push the control disc up or down to highlight *LEFT-RIGHT (EW)* on the geometry menu and then press **ENTER**.

**ENTER** will select Left-Right adjustment menu  
**EXIT** returns to random access adjustment mode main menu.  
**ADJUST** returns to operational mode

Only the green image is displayed while making left-right adjustments. The red and blue images will automatically be corrected in the same manner. Convergence corrections are automatically disabled for the duration of these adjustments.

The following adjustments can be executed

- vertical centerline bow
- vertical centerline skew
- side keystone (left - right)
- side bow (left - right)

All adjustment are indicated on the screen with the function name, a bar scale and a number between 0 and 100.

Adjust the next alignments until the vertical lines are straight.

To enter an alignment, push the control disc up or down to highlight a function and press **ENTER** to activate this function.

Press **EXIT** to return.

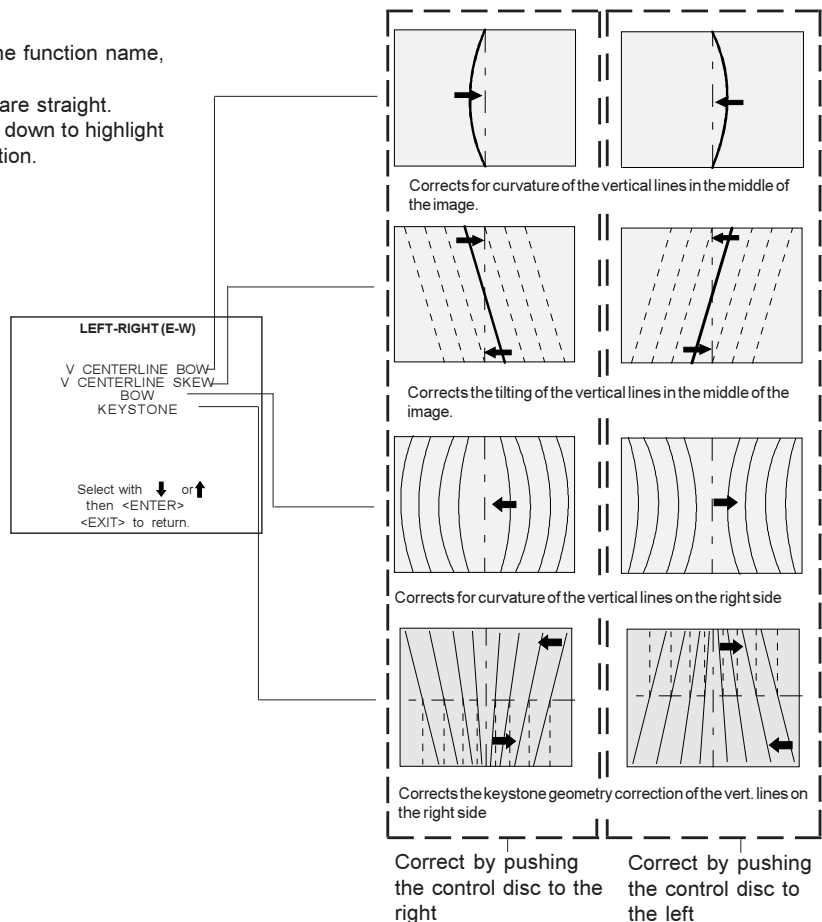
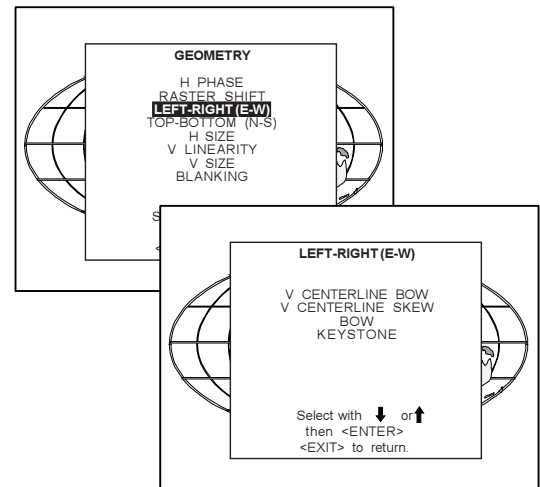

### Top-Bottom (north-south) Adjustments

Top-Bottom and center adjustments affect only the horizontal lines of the projected image.

To start up the Top-Bottom and center corrections, follow the next procedure :

Push the control disc up or down to highlight **TOP-BOTTOM (N/S)** on the geometry menu and then press **ENTER**.

*Only the green image is displayed while making top-bottom adjustments. The red and blue images will automatically be corrected in the same manner. Convergence corrections are automatically disabled for the duration of these adjustments.*

The following adjustments can be executed :

- Horizontal centerline bow
- Horizontal centerline skew
- Top bow
- Top keystone
- Bottom bow
- Bottom keystone

All adjustment are indicated on the screen with the function name, a bar scale and a number between 0 and 100.

Adjust the next alignments until the vertical lines are straight. To enter an alignment, push the control disc up or down to highlight a function and press **ENTER** to activate this function. Press **EXIT** to return.

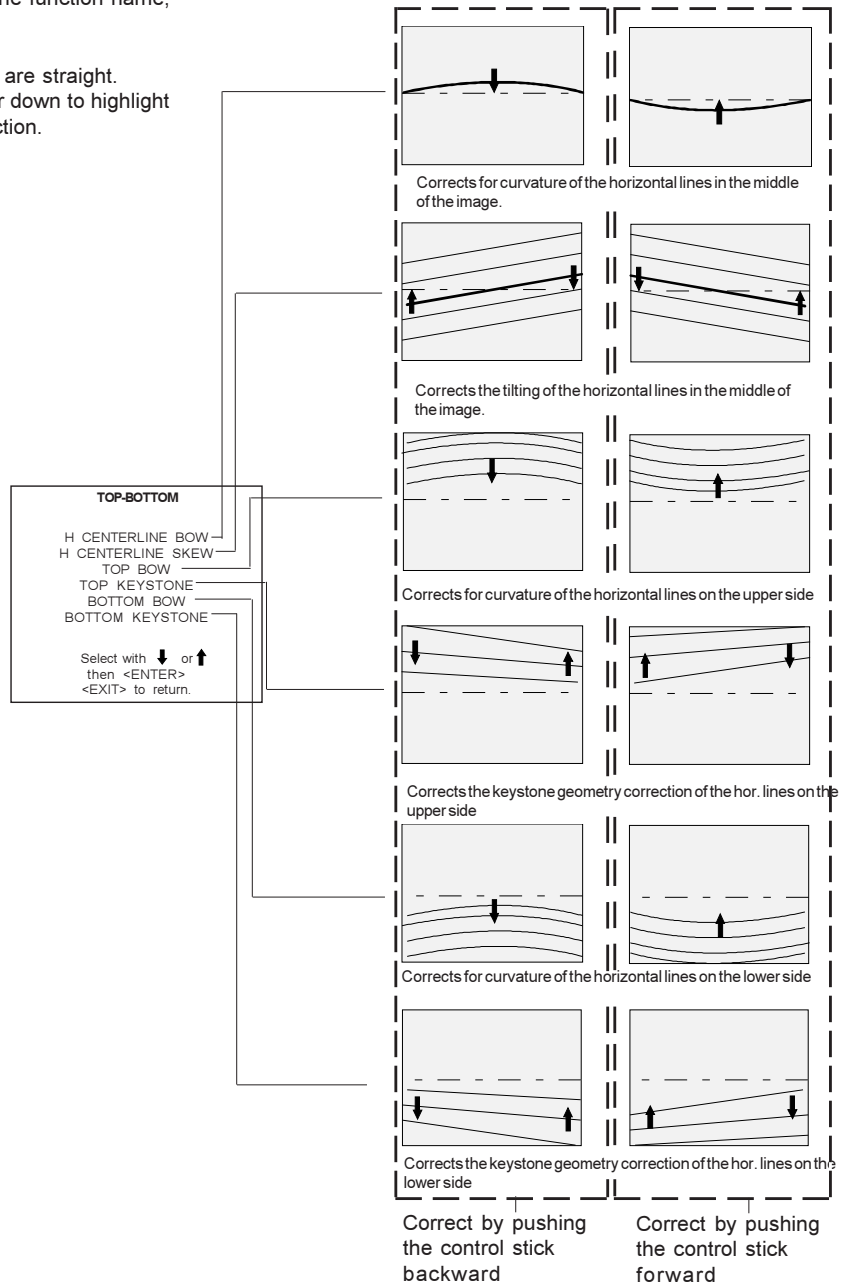
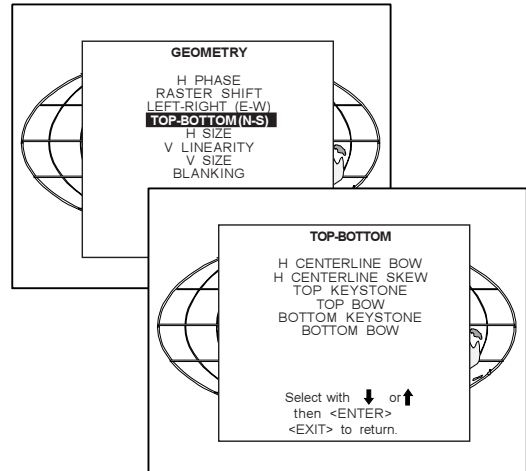

## Horizontal Size Adjustment

Push the control disc up or down to highlight *H SIZE* on the Geometry menu and then press **ENTER**.

**ENTER** will select horizontal size adjustment.

**EXIT** returns to random access adjustment mode menu.

**ADJUST** returns to operational mode.

Adjust the horizontal size by pushing the control disc to the right or to the left until the exact image width is obtained.

Note :

- If the internal # pattern was selected, this pattern remains on the screen.
- If the genlocked pattern was selected, the external source will be displayed.

A bar scale and a numeric indicator help to gauge the horizontal size adjustment.

*Hint : In order to avoid loss of resolution in the projected image and to ensure maximum CRT longevity, do not use an excessively small horizontal size setting.*

**EXIT** will return to Geometry.

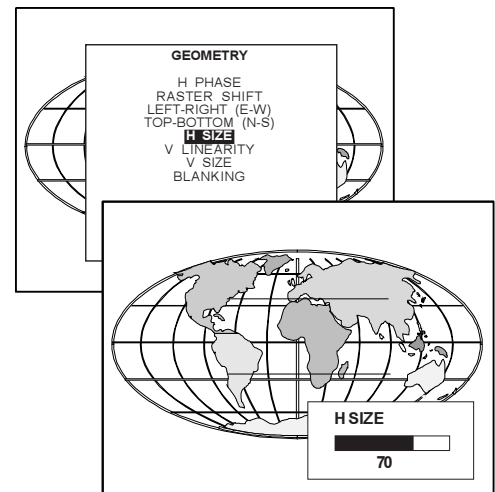

H size too large

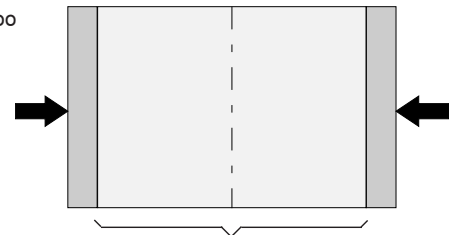

Ideal image width

H size too small

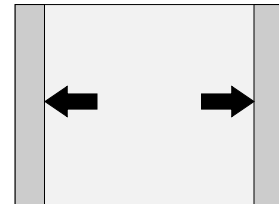

## Vertical Linearity Adjustment

The vertical linearity adjustment function corrects for vertical non-linearities which extend from the center of the image to the top and bottom of the image.

Push the control disc up or down to highlight *V LINEARITY* on the Geometry menu and then press **ENTER**.

**ENTER** will select vertical linearity adjustment.

**EXIT** returns to random access adjustment mode menu.

**ADJUST** returns to operational mode.

Adjust the vertical linearity with the control disc until the distances between the horizontal lines of the set up pattern are equal from top to bottom.

**EXIT** will return to the Geometry menu.

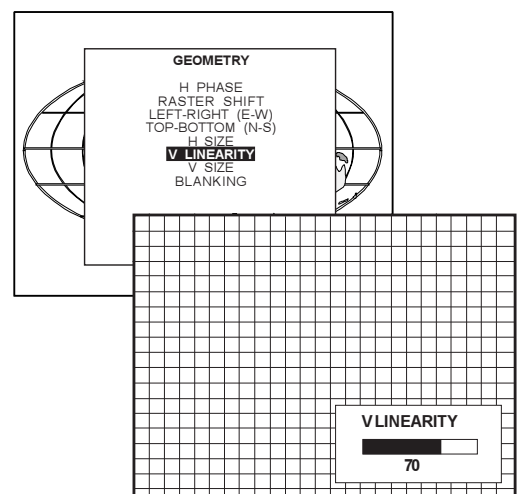
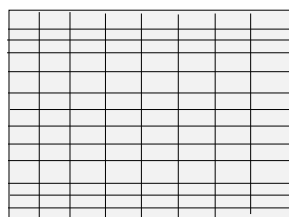

### Horizontal Size Adjustment

Push the control disc up or down to highlight *V SIZE* on the Geometry menu and then press **ENTER**.

**ENTER** will select vertical size adjustment.  
**EXIT** returns to random access adjustment mode menu.  
**ADJUST** returns to operational mode.

Adjust the horizontal size by pushing the control disc to the right or to the left until the exact image width is obtained.

Note :  
- If the internal # pattern was selected, this pattern remains on the screen.  
- If the genlocked pattern was selected, the external source will be displayed.

A bar scale and a numeric indicator help to gauge the horizontal size adjustment.

Hint : In order to avoid loss of resolution in the projected image and to ensure maximum CRT longevity, do not use an excessively small vertical size setting.

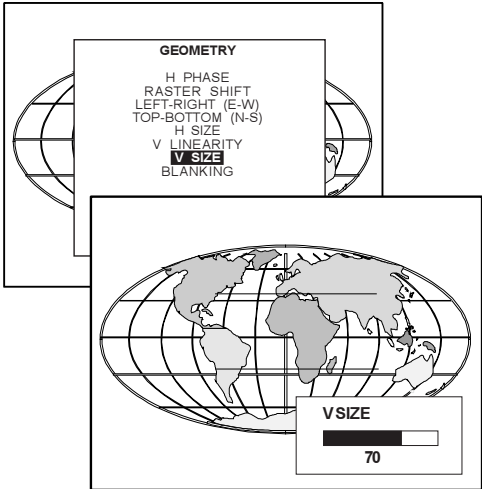

**EXIT** will return to Geometry.

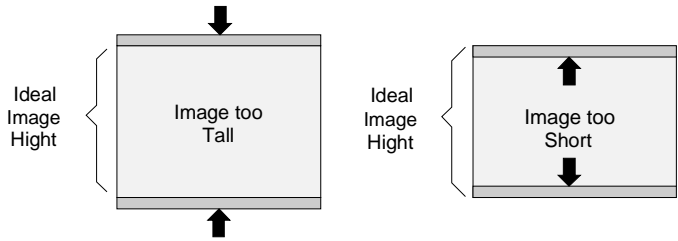

### Blanking Adjustments

Blanking adjustments affect only the edges of the projected image and are used to frame the projected image on to the screen and to hide or black out unwanted information (or noise). A 0% on the bar scale indicates no blanking.

To start up the Blanking adjustments, follow the next procedure :

Push the control disc up or down to highlight *BLANKING* on the Geometry menu and then press **ENTER**.

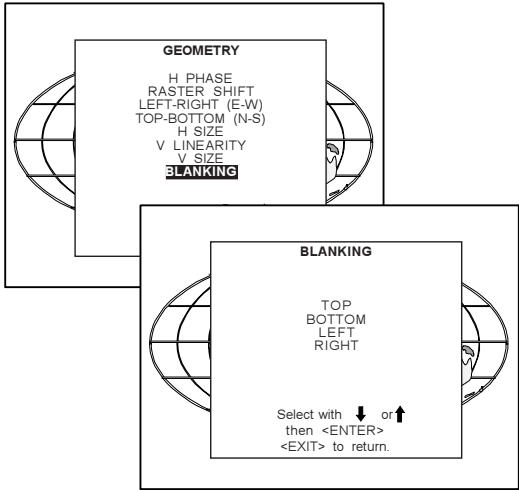

The following blanking corrections are possible :

- Top blanking
- Bottom blanking
- Left blanking
- Right blanking

Therefore :  
- If the internal # pattern was selected, this pattern remains on the screen.  
- If the genlocked pattern was selected, the external source will be displayed.

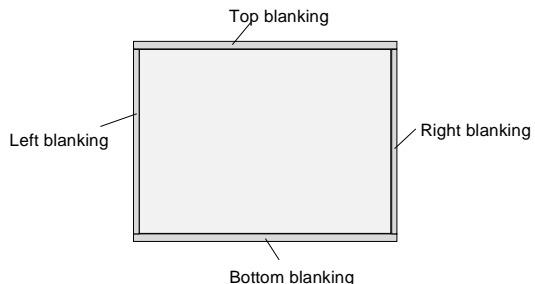

## Random Access Adjustment Mode

Adjust the next blanking alignments until the image is correctly framed or the unwanted information is blanked out.  
To enter a blanking alignment, push the control disc up or down to highlight a function and press ENTER to activate this function.

Press EXIT to return.

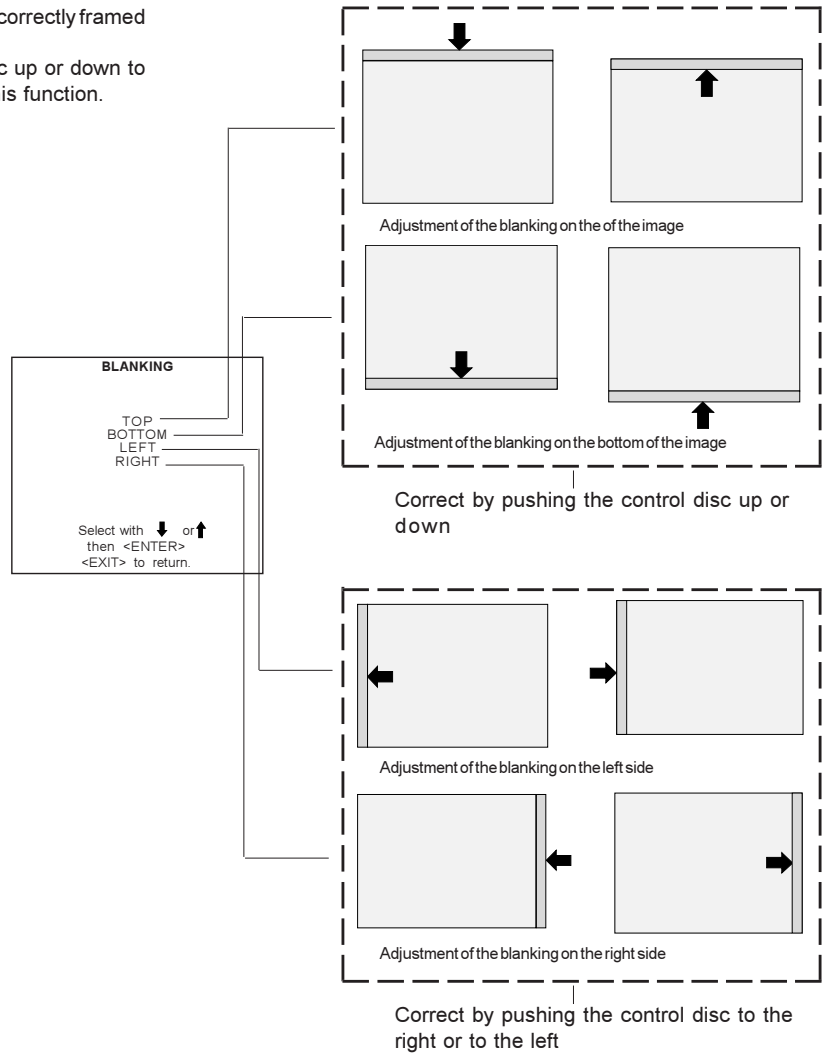



### Convergence Adjustment

Convergence adjustments affect both the horizontal and vertical lines of the setup pattern. These adjustments are performed on the red image while superimposed on the green image and then on the blue image while superimposed on the green image.

Note : the green convergence adjustments can be added as an option. When these are available, start always with 'green only'. This option will also be indicated on the convergence menu.

Highlight first 'Green only' when available by pushing the control disc up or down and press ENTER to display the convergence adjustment menu.

The screen area is divided into 13 areas.

Use the control disc to move the box to the desired zone and then press ENTER to begin the convergence adjustment. Start the convergence adjustment with zone one and continue as mentioned in the diagram hereafter.

Use the control disc to make horizontal or vertical convergence adjustments in the selected zone and then press ENTER to move the box to another zone or EXIT to return to the Convergence menu.

ENTER toggles the control disc between zone selection and zone adjustment .  
EXIT returns to convergence menu

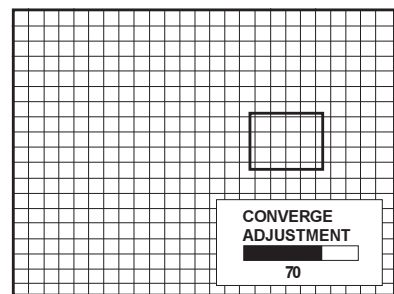
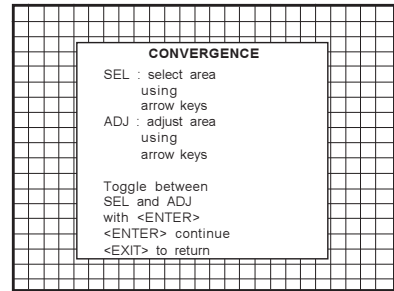
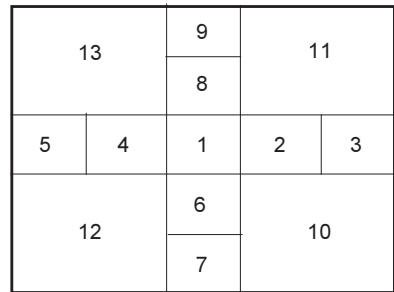
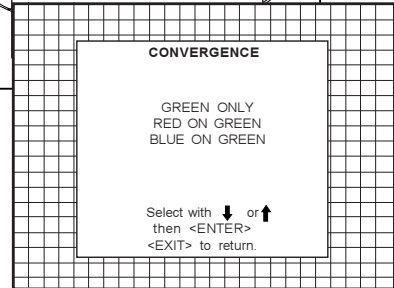
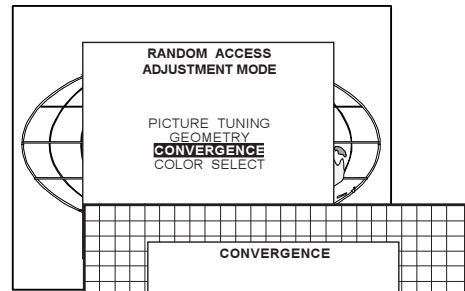
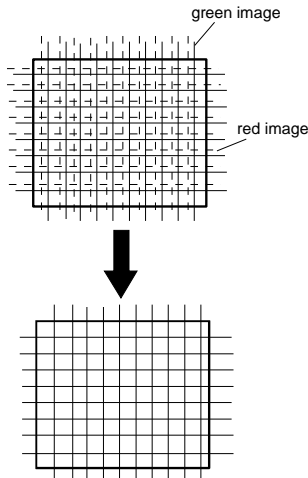

# 7

## SERVICE MODE

### Starting up the Service mode.

Use the control disc to highlight 'Service' and then press ENTER.

Some items in the Service mode are password protected (when the password function is active). Enter your password to continue. All other password protected items are now also available if you stay in the adjustment mode.

ENTER continues to the Service Mode main menu.  
EXIT returns to the Operational mode.

The service items are combined in two service menus. To switch from the first to the second menu or vice versa, push the control disc forward or backward to select 'more...'

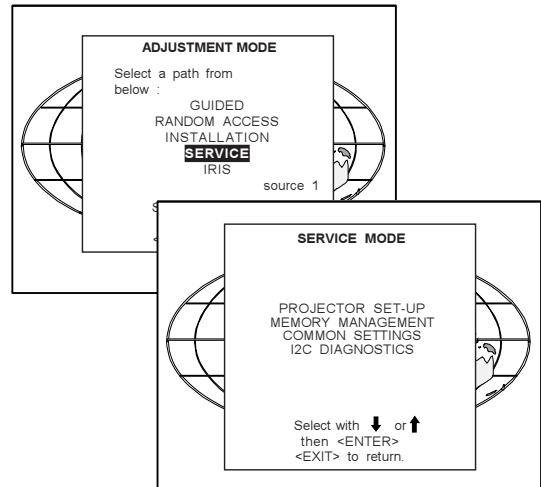

### Overview flowchart 'Service' mode.

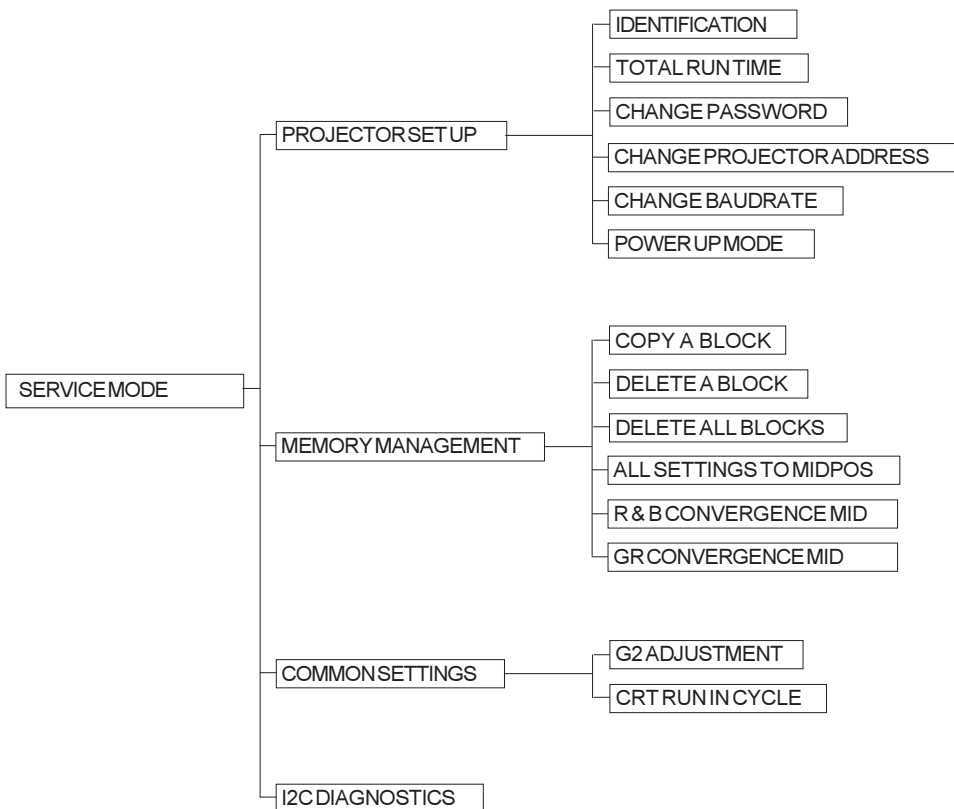

## Projector Set-up

Highlight '*Projector Set-Up*' by pushing the control disc up or down and press **ENTER** to display the projector set-up menu.

Within the projector set-up menu, the following items can be consulted or set to the desired setting :

- Identification
- Total run time
- Change password
- Change projector address
- Change baudrate
- Power up mode

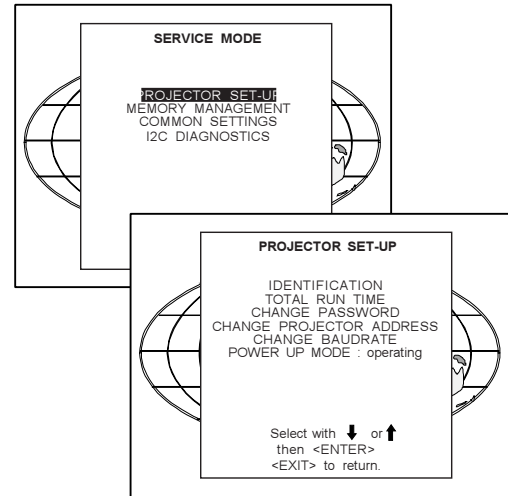

## Identification

Highlight '*Identification*' with the control disc and press **ENTER**.

**ENTER** will start the selected item.  
**EXIT** returns to the Service mode menu.

The '*Identification*' screen gives information concerning :

- Projector address. To change the address of your projector, contact a qualified service technician.
- Software version.
- Configuration.
  - Possible installations :
    - \* Front-ceiling
    - \* Front-table
    - \* Rear-ceiling
    - \* Rear-table
- Baud rate PC : transfer speed for communication with an IBM PC (or compatible) or MAC. The baud rate of the projector must be the same as the baud rate of the connected computer. When there is a difference, contact a qualified service technician to make the appropriate changes.
- Text ON/OFF
  - Indicates in operational mode if the bar scale and number indicator will be displayed and if warnings and failures will be displayed.
  - ON : displayed
  - OFF : not displayed

The status can be changed by pressing the 'TEXT' key once on the RCU.
- Serial no. : indicates the fabrication number of the projector. This number can be useful when calling for technical assistance.

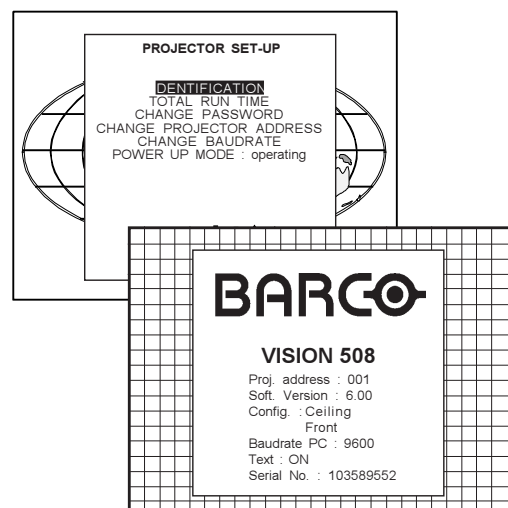

## Total Run Time

Highlight 'Total Run Time' with the control disc and press **ENTER** to display the amount of time the projector has played since its first start up at the factory.

**ENTER** gives the selected item.  
**EXIT** returns to the Service mode menu.  
**ADJUST** returns to the Operational mode.

Note : all projectors leave the factory after a burn-in period of approximately 100 hours.

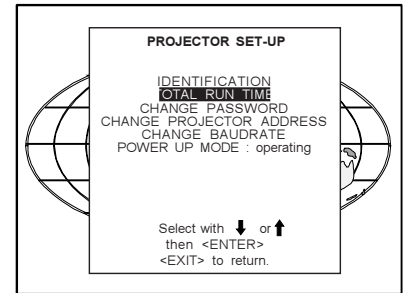

## Change password

This item is password protected.

Highlight 'Change Password' with the control disc and press **ENTER**.

**ENTER** will display the selected item.  
**EXIT** will return to the Path Selection main menu.  
**ADJUST** will return to the Operational mode.

The current password is displayed. The new password must consist of 4 digits between 0 and 9. Push the control disc to the left or to the right to select the digits to be changed. Use the numeric keys to enter the new digits.

Press **ENTER** to save the new password. Before saving the new password, a confirmation screen will be displayed.

Press **EXIT** to return to the Projector Set-up menu without saving the new password.

When the displayed password is correct, press **ENTER** to save. If not correct, press **EXIT** to cancel the saving.

**ENTER** saves the entered password.  
**EXIT** returns without saving.

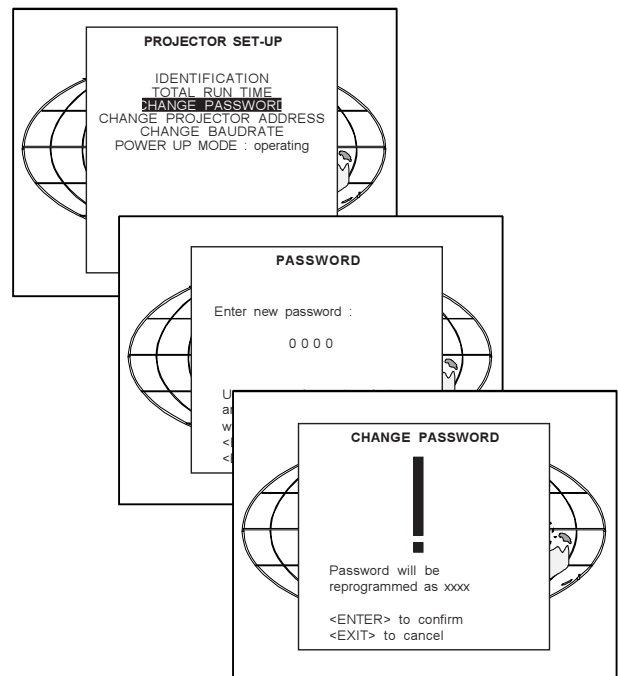

## Change Projector Address

Every projector requires an individual address between 0 and 255. This address can be software installed.

To change that address, push the control disc up or down to highlight 'Change Projector Address' and press **ENTER**. The Change Projector Address menu will be displayed and the actual address will be filled in.

**ENTER** displays the 'Change Projector Address' menu.  
**EXIT** returns to the Service mode main menu.

The first digit is highlighted. Select the individual digits by pushing the control disc to the right or to the left. Reprogram with the digit keys on the RCU.

Press **ENTER** to confirm.

Press **EXIT** to return to the projector set up menu.

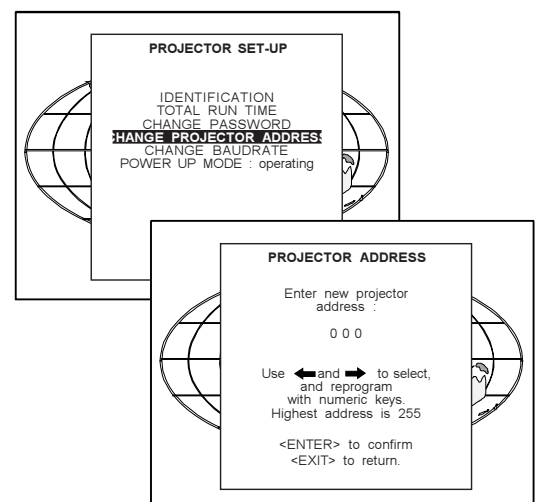

## Change baudrate

The communication speed between projector and computer has 8 possible speeds. The baud rate speed can be software set up. Highlight 'Change Baudrate' by pushing the control disc up or down and press **ENTER** to display the Baud rate menu.

The following baud rates are available :

- 9600
- 4800
- 2400
- 1200
- 600
- 300
- 150
- 110

The actual baud rate will be highlighted. To change the baud rate, push the control disc up or down or to the left or to the right to select the desired baud rate and press **ENTER** to accept this baud rate.

**ENTER** to accept the selected baud rate.  
**EXIT** to return without changing the baud rate.

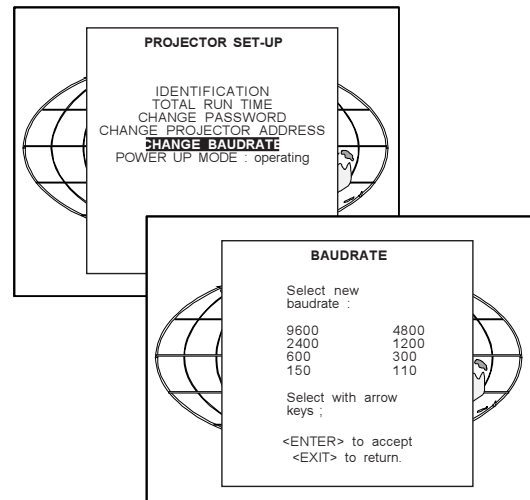

## Power up mode

When pressing the power switch, the projector can start up in 'operating mode' or in 'stand-by mode'.

Operating mode : the projector start up and displays image .

Stand-by mode : the projector start up in stand-by and waits until the stand-by button or a digit key is pressed.

To change the Power up mode, select Power Up mode by pushing the control disc up or down and press **ENTER** to toggle between 'Operating' and 'Standby'.

**ENTER** to toggle between operating and standby.  
**EXIT** to return to the Service menu.

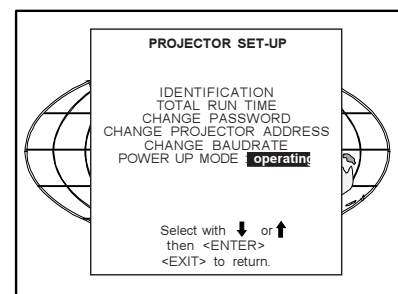

## Memory management

Highlight 'Memory management' by pushing the control disc up or down and press **ENTER** to display the memory management menu. Within the memory management menu, the following items can be consulted or executed :

- copy a block
- delete a block
- delete all blocks
- all settings to midposition
- R & B convergence to mid
- Gr convergence mid (only if green convergence is available)

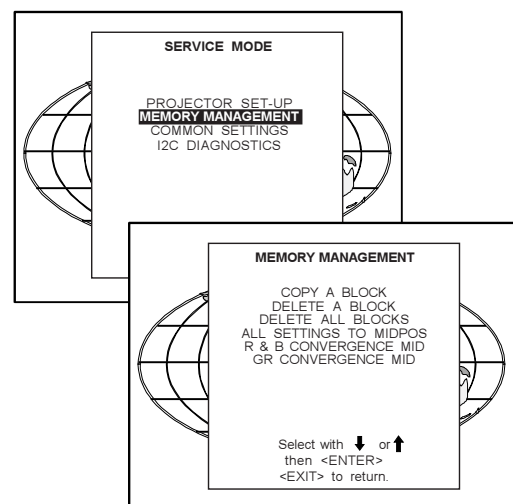

## Copy a block

The copy a block function copies the settings of a selected block into the active block.

Highlight *copy a block* with the control disc and press **ENTER**.

**ENTER** will select the highlighted item.  
**EXIT** returns to the Path Selection main menu.  
**ADJUST** returns to the Operational mode.

To copy the settings of a closed block to the block you are working on (active block), use the control disc to select a block. All existing settings will be overwritten with the new settings.

Press **ENTER** to copy the selected block. A confirmation screen will be displayed.

**ENTER** displays a confirmation screen.  
**EXIT** returns to the Service Mode main menu.

If you are certain you wish to copy the contents of the selected block into the active block, press **ENTER**.  
**EXIT** cancels the copy procedure and returns without copying the block.

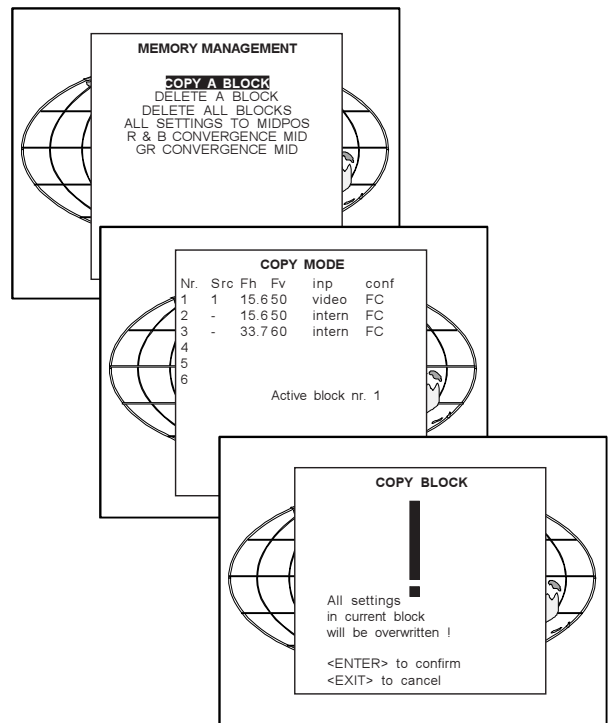

## Deletion of blocks

This item is password protected.

The delete function is used to clear all data (settings) from an adjustment block.

A delete can be given :

- block by block
- or
- for all blocks.

### Deleting block by block

The 'delete a block' function deletes the settings of a selected block. Highlight 'Delete a block' with the control disc and press **ENTER**.

**ENTER** will select the pointed item.  
**EXIT** returns to the Path Selection main menu.  
**ADJUST** returns to the Operational mode.

Push the control disc up or down to select the desired adjustment block. Press **ENTER** to delete the selected adjustment block. A confirmation menu will be displayed.

**ENTER** displays the confirmation menu.  
**EXIT** returns to the Service Mode main menu.

**ENTER** will delete the selected block.  
**EXIT** cancels the deletion procedure and returns to the Service mode main menu.

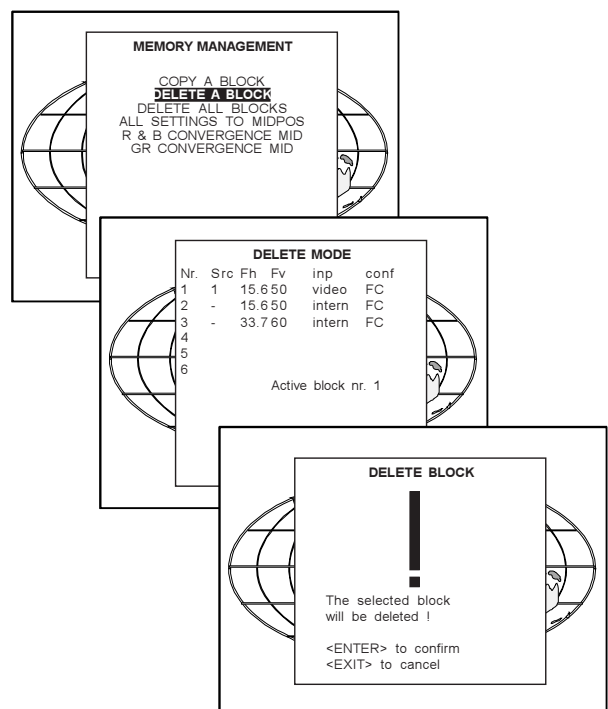

### Deletion of all blocks

Highlight *'delete all blocks'* with the control disc and press **ENTER**.

**ENTER** gives a confirmation message before deleting.  
**EXIT** returns to the Path Selection main menu.

If you are certain you wish to delete all blocks, press **ENTER** to confirm, otherwise press **EXIT** to return.  
 Once **ENTER** is pressed, all block headers and adjustment settings are permanently removed and cannot be restored.

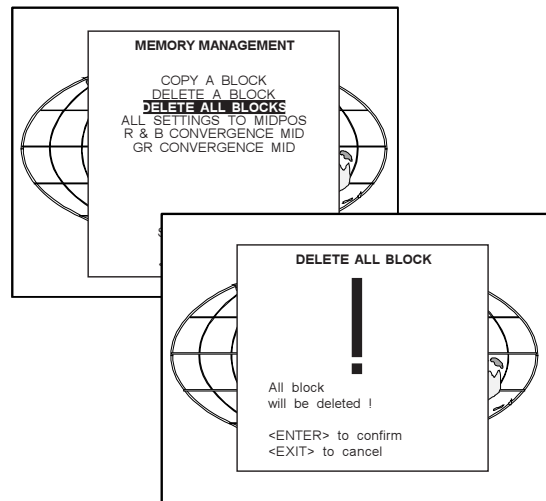

### All settings to midposition

Item is password protected.

Highlight *'All settings to midposition'* with the control disc and press **ENTER** to set all settings to their midposition.  
 A confirmation menu will be displayed first.

**ENTER** displays a Confirmation screen.  
**EXIT** returns to the Service menu.

**ENTER** will set all settings to their midposition. **EXIT** will cancel the operation to set all settings to their midposition.

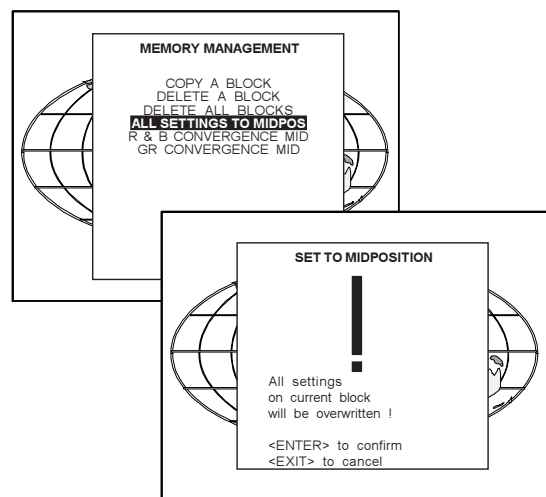

### Undo all settings to midpos

When "All settings to midpos" is selected, all settings are set to their midposition. To cancel this action, select 'Undo all settings to midpos' by pushing the control disc up or down and press **ENTER**. 'Undo all settings to Midposition' is displayed in the Memory management menu in stead off 'All settings to midposition' when this latter is pressed.

An undo is possible as long as the projector is playing on the same source (= same adjustment block) even when some adjustments as geometry or convergence are already readjusted. When undo is pressed all settings are reset to the previous settings.

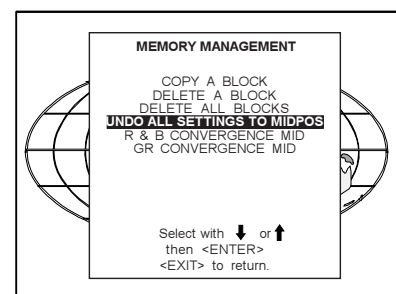

### R & B convergence mid

Item is password protected.

Highlight 'R & B convergence mid' with the control disc and press ENTER to set all convergence settings to their midposition. A confirmation screen will be displayed first.

ENTER sets the convergence settings to their midposition. EXIT cancels the procedure to set the convergence settings to their midposition.

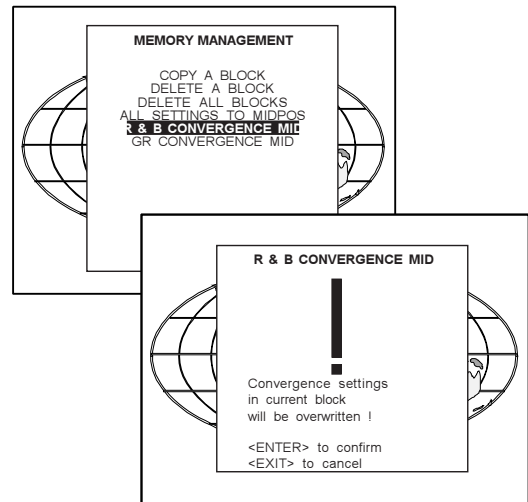

### Undo R & B convergence mid

When "R & B convergence mid" is selected, all convergence settings are set to their midposition. To cancel this action, select 'Undo R & B convergence mid' by pushing the control disc up or down and press ENTER. 'Undo R & B convergence mid' is displayed in the Memory management menu in stead off 'R & B convergence mid' when this latter is pressed.

An undo is possible as long as the projector is playing on the same source (= same adjustment block) even when some adjustments are already readjusted. When undo is pressed all settings are reset to the previous settings.

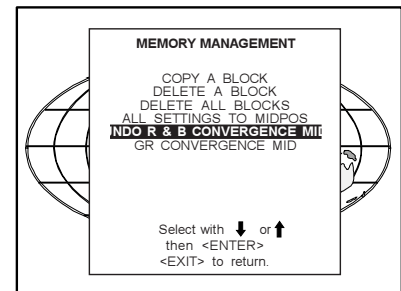

### Green convergence mid

Only available when the projector is equipped with green convergence adjustments.

Highlight 'Gr convergence mid' by pushing the control disc up or down and press ENTER to switch off the green convergence.

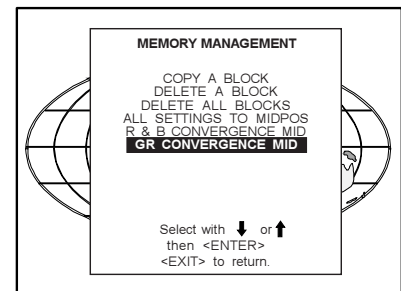

### Undo green convergence mid

Only available when the projector is equipped with green convergence adjustments.

The item 'Undo green convergence mid' will automatically be displayed when the green convergence is switched to midposition. Press ENTER to switch on the green convergence.

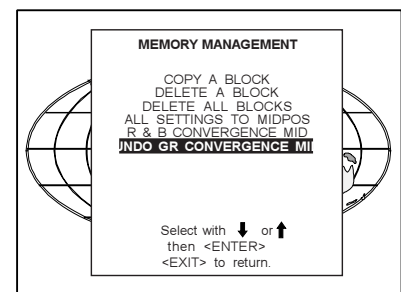



## Common Settings

Highlight 'Common settings' by pushing the control disc up or down and press **ENTER** to display the common settings menu.

Within the common settings menu, the following items can be set up or executed :

- G2 adjustment
- CRT run in cycle

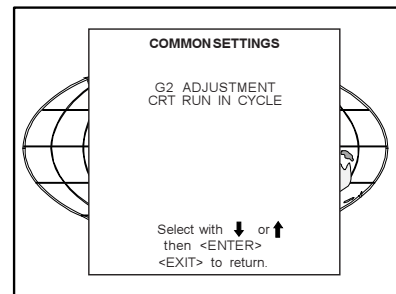
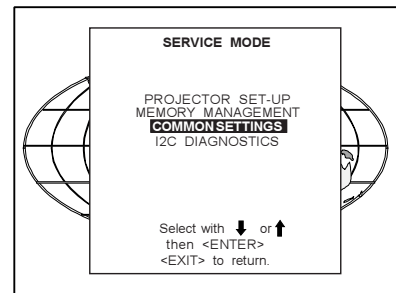

## G2 Adjustment

Item is password protected.

Highlight 'G2 adjust' with the control disc and press **ENTER** to continue.

A safety notice will be displayed on the screen as it is necessary to open the top cover to adjust the G2.

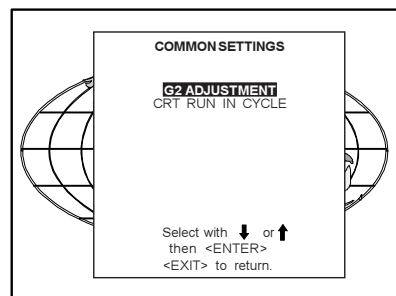

**ENTER** selects the G2 adjustment.  
**EXIT** returns to the Common settings menu.  
**ADJUST** returns to the Operational mode.

**'G2 adjustment should be performed by BARCO personnel, or BARCO authorized dealers'.**

If you are qualified, press **ENTER** to continue. If not qualified, press **EXIT** to return to the Common settings menu. Further description of the G2 adjustment is given in the Installation manual.

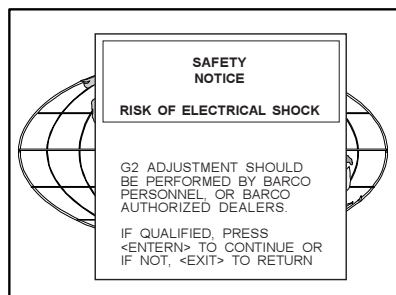

## CRT run in cycle

The CRT run in cycle option can only be activated when memory blocks on an internal # pattern are available. When one or more such blocks are available, a flashing white image (5sec on, 5 sec off) is generated and that for 5 min on the first internal block. In the next 5 min, a second internal block will be used to generate the flashing white image. The image will also be shifted in a vertical way to prevent a CRT burn in. To quit the CRT run in cycle option, press **EXIT**.

Highlight 'CRT run in cycle' with the control disc and press **ENTER** to start.

**ENTER** selects the CRT run in cycle option.

**EXIT** returns to the Path Selection main menu.  
 If a memory block adjusted on an internal # pattern is available,

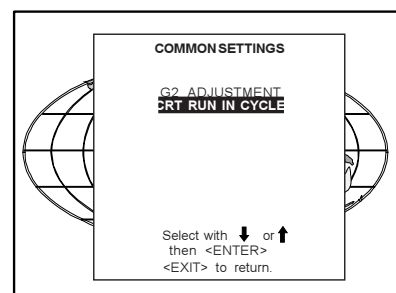

## Service Mode

the CRT run in cycle will start when pressing ENTER. If no such a block is available, the projector cannot run the CRT run in option and leaves the adjustment mode.

If you still want to run CRT run in cycle, create first a memory block on an internal # pattern and restart the CRT run in option.

ENTER starts the 'CRT run in' when an internal generated # pattern is available.

EXIT returns to the Path Selection main menu.

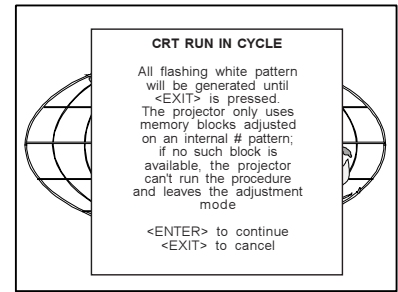

## I2C Diagnostics

Highlights 'I2C Diagnostics' by pushing the control disc up or down and press ENTER.

The I2C diagnostics menu gives an overview of the I2C failures inside the projector.

To scroll through the failure list, push the control disc up or down. The I2C address, IC number and module name will be given in I2C diagnostic menu.

When no errors are detected, the following message will appear on the screen :

"No errors on i2c-bus detected".

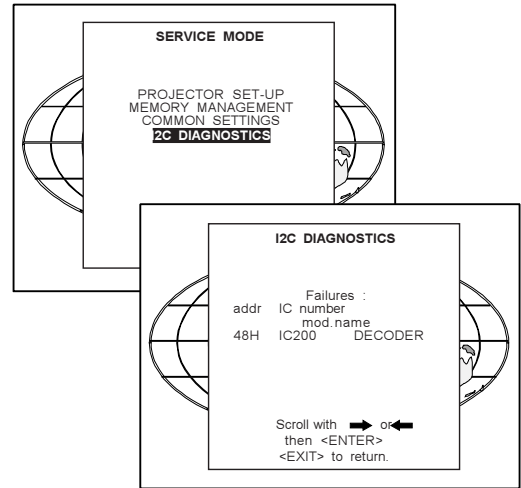

## 8

## OPTIONS

**IR Receiver 800**

This infrared receiver unit makes it possible to control the projector from another room.

There is a communication line with cable between the IR receiver and the projector or the RCVDS05. The control information from the RCU can now be sent to this IR receiver.

The IR receiver 800 displays the selected source on a 7-segment display.

Order number : R9827515

**Hardwired RCU.**

The control signals from the RCU can be sent to the projector via a wired connection.

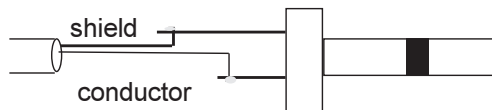

Preparing your remote cable :

Use a shielded cable with a maximum length of 100 m and two mini-jack 3.5 mm connectors (order number : R3131991).

- Peel back the vinyl covering of the cable on both sides and twist the wire core.
  - Solder a jack plug as shown in drawing above to each end of the cable.
- shield = ground  
conductor = data information

When the cable is ready, plug one side in the remote control and the other side in the connector on the rear of the projector labelled 'remote'.

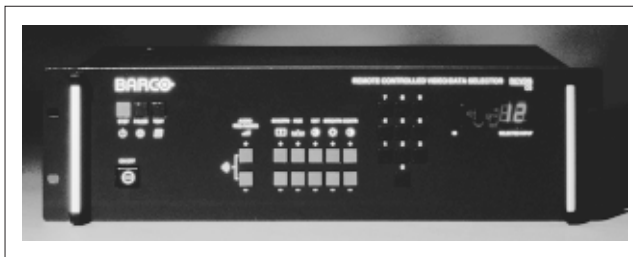
**RCVDS 05 Source Selector**

An optional RCVDS05 makes it possible to connect up to 20 sources to the projector. When RCVDS's are linked via the expansion module, even 90 inputs can be connected to the projector.

The selected source number will be displayed on a 2 digit display and the selected input module will be indicated with a LED on the rear.

Order Numbers RCVDS 05: 110V: 9827888  
9827889  
220V: 9827880  
9827881

**VS05 Switcher**

The VS05 is a versatile Video and HDTV source selector for all BARCO's digitally controlled large screen projectors. It offers the possibility to connect and switch up to 5 different Video sources, 3 different S-Video sources and 1 RGB Analog source to a BARCO projector. In addition, the audio signal proper to the source, can be switched to an audio amplifier.

Order Numbers: 110V: 9827890  
220V: 9827899

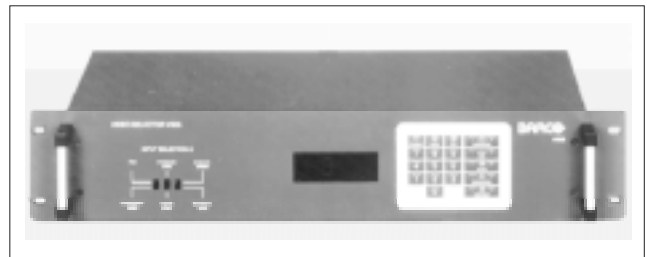
**Adapter and communication cables**

BARCO provides several cables to connect peripheral equipment to the projector.

*a. D9-D9 communication cable*

- To connect an IBM PC (or compatible) to the projector.
- To connect a RCVDS05 to the projector.
- To connect a IR receiver to the RCVDS05 to the projector.
- To be used as extension cable for all other adapter cables.

Available length : 5 m (16ft), order number R982770; 15 m(50ft), order number R9827560; and 30 m (100ft), order number R9827570

*b. Din Mini8-D9 adapter cable.*

- To connect a Macintosh computer to the RETROGRAPHICS 808s.
- Available length : 1 m (3,2 ft), order number R9827640.

*c. D25-D9 adapter cable*

- To connect a workstation to the RETROGRAPHICS 808s.
- Available length : 1 m (3,2 ft), order number R9827630

*d. 5 BNC to 5 BNC cable*

- To connect an analog source to the BNC input of the projector
- Available length : 60 cm, order number R9828260  
150 cm, order number R9828261  
5 m, order number R9828262  
15 m, order number R9828263

**Ceiling mount CM50**

This suspension system enables to mount any projector from the BARCO 700 series to the ceiling without using any mechanical interface, and to adapt the projector perfectly to the local mounting requirements.

Order number CM50 with pulley : R9827990

Order number CM50 without pulley : R9827991.

### Tuner kit

With one of the four available tuner kits, it is possible to receive RF signals from a TV cable network or a TV antenna. The four kits are designed to fulfil the different broadcasting systems worldwide.

Order number BG/L tuner : R9828590  
Order number I tuner : R9828600  
Order number MN tuner : R9828610  
Order number DK tuner : R9828620



## TUNER MODE

### Tuner mode

With one of the four available tuner kits, it is possible to receive RF signals from a TV cable network or a TV antenna. The four kits are designed to fulfil the different Broadcasting systems worldwide. These kits are :

Order no.	Broadcasting System	Audio Type	Teletext
R9828590	BG/L	FM - FM&NICAM	TXT
R9828600	I	FM - FM&NICAM	TXT
R9828610	MN	MTS	CC
R9828620	DK	No stereo	no TXT

FM-FM : dual carrier FM coded discrete stereo transmissions, analogue.

NICAM : Digital two channel audio transmissions with sub-code selection of bi-lingual operation.

MTS : Used in conjunction with NTSC. Consists of two independant carriers each carrying a discrete channel. One channel provides stereo sound. The second carrier carries a Secondary Audio Program which is used for a second language or a descriptive commentary for the blind.

CC : (Closed Captioning) Transmitted on line 21 of NTSC transmissions contains subtitling information only.

Teletext : An information service of 200-700 "pages" covering a wide range of topics

### How to activate the tuner mode ?

#### 1. Using the RCU.

Press the **BARCO** key. The last selected channel will be displayed.

To switch to another channel :

- push the control disk up or down
- or
- enter the channel number with the digit keys.

When a new channel is displayed, a text box appears on the screen with preselection number, the channel name (when entered) and the sound reproduction.

When you want to leave the tuner mode, press the BARCO key again.

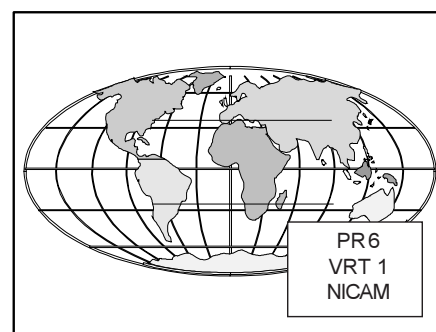

#### 2. Using the local keypad.

Press the **ADJUST** key.

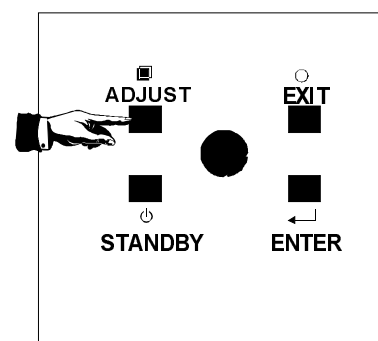

## Tuner Mode

The projector displays the *General access menu*.  
Use the control disk to highlight *TUNER* and press **ENTER**. The last selected channel will be displayed.  
To switch to another channel, push the control disc up or down.

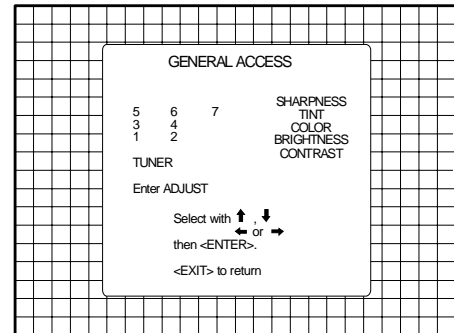

When a new channel is displayed, a text box appears on the screen with preselection number, the channel name (when entered) and the sound reproduction.

When you to leave the tuner mode, select tuner on the general access menu again and press **ENTER**.

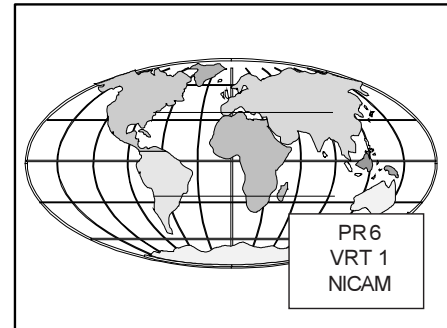

## Tuner setup

To enter 'Tuner Setup', press **ADJUST** to display the adjustment mode menu.  
Highlight 'Tuner Setup' by pushing the control disc up or down and press **ENTER** to display the Tuner Setup menu.

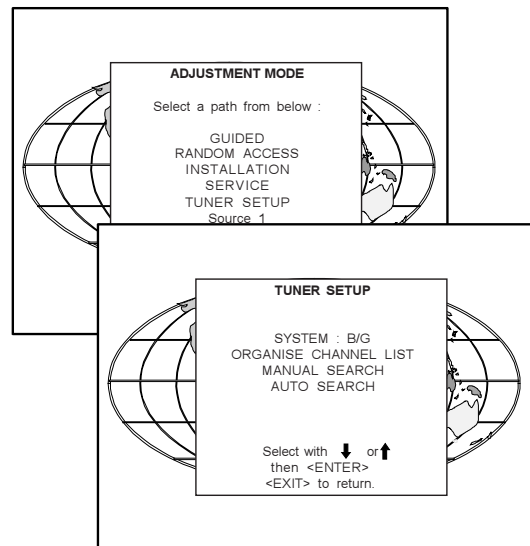

## Broadcasting System

The broadcasting system is the way the signals are transmitted through the air. Barco designed 4 different tuners to fulfil the different broadcasting systems worldwide.

Changing the broadcasting system is only necessary for the BG/L system.

BG system : European standard.

L or L' : French standard.

To change the broadcasting system, push the control disc up or down to select 'System' and press **ENTER** to switch to a different system.

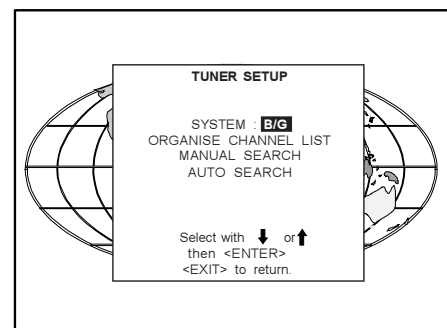

## Auto Search

All channel information will be overwritten and the channel list will be reorganised completely.

The projector scans the entire VHF and UHF band for the available TV frequencies. It starts in the lower frequency range and it stores each found frequency in another preselection in a consecutive order. It takes around 2 to 3 minutes to complete the entire TV spectrum.

To start auto search, push the control disc up or down to select the 'Auto Search' function and press **ENTER** to select.

A warning will be displayed that all information will be overwritten. Press **ENTER** to confirm and to start up the auto search action.

When the first frequency is found, the auto search menu with the frequency and the preselection indication will be displayed. While this menu is visible, a projector will execute a small fine tuning for that channel.

When the entire TV spectrum is finished, the projector goes back to the beginning of the TV spectrum and when the first identical source is found, it stops.

It is possible to reorganise the channel list to your wishes and to add additional information to the channel list. See 'Organise Channel List'.

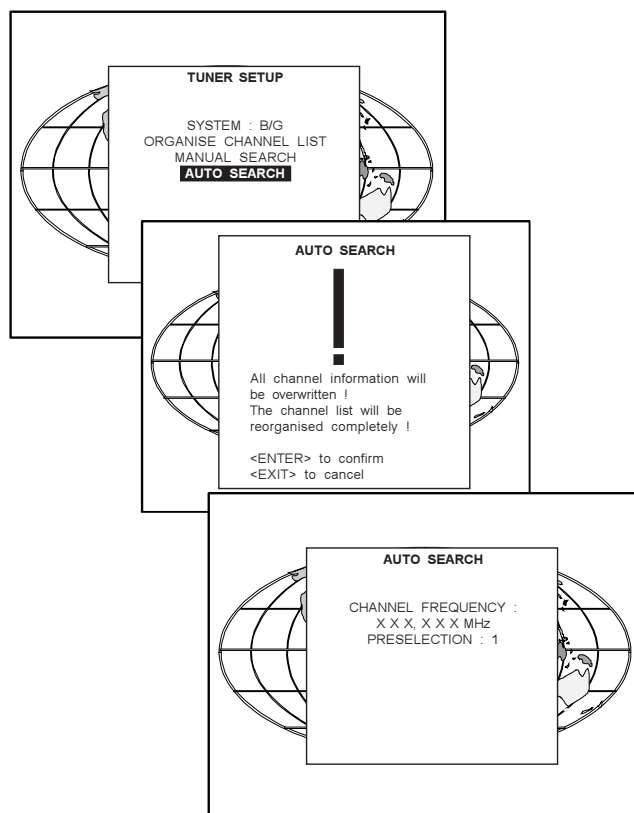

## Manual Search

The desired channels can be search manually.

Highlight 'Manual Search' by pushing the control disc up or down and press **ENTER** to display the manual search menu.

The last selected source will be displayed.

Push the control disc up or down to select the next available frequency. When a channel frequency is found, it stops and displays the frequency.

Fine tuning is possible by pushing the control disc to the right or to the left.

The preselection indication will be blinking on the next available preselection number. If this preselection is ok, press **ENTER** to store the displayed image in that program location. If another preselection is desired, press the corresponding digits with the numeric keys and press **ENTER** to store the displayed image in that program location.

Press **EXIT** to return to the 'Tuner Setup' menu.

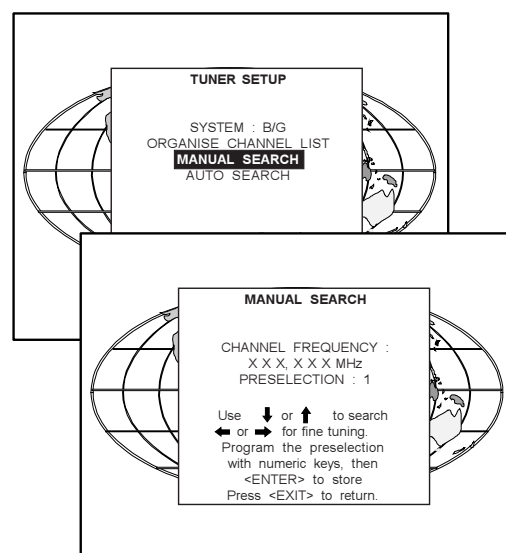

## Organise Channel List

Once the TV frequencies are entered in the channel list, this list can be ordered according your own preferences.

Highlight '*Organise Channel List*' by pushing the control disc up or down and press **ENTER** to select. The channel list will be displayed.

To reorganise the channel list :

- select a frequency with the control disc.
- press **ENTER** to copy this frequency to the clipboard.
- select the new location with the control disc.
- press **ENTER** to paste that frequency on the new location. All other frequencies starting from the new location will move up one position in the list.

To delete a frequency in the channel list :

- select a frequency with the control disc.
- press **ENTER** to copy this frequency to the clipboard.
- press **TEXT** to delete the selected frequency. A warning will appear on the screen. If you really want to delete, press **ENTER** to confirm. Otherwise press **EXIT** to cancel.

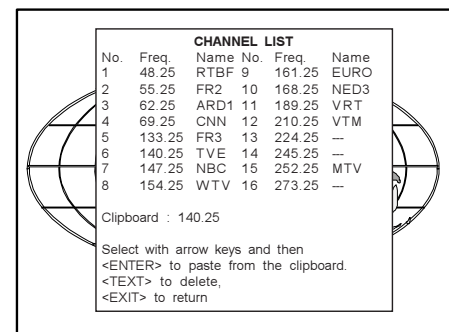
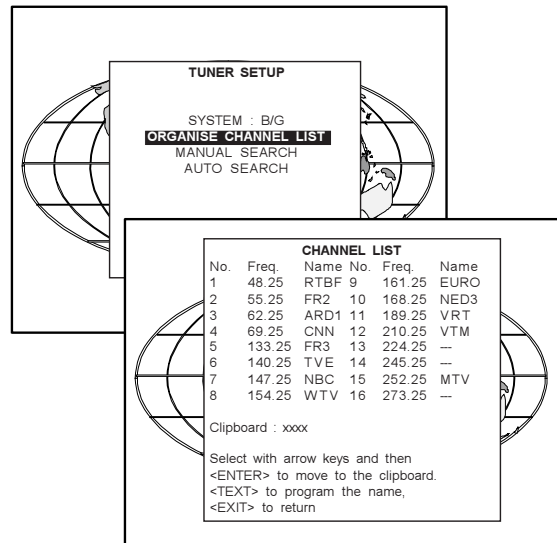

Next to the frequency, it is possible to fill in a name for that channel. This name will be displayed each time this preselection is selected.

To enter a name for a channel, follow the next steps :

- select a frequency with the control disc.
- press **TEXT** to reprogram the name. The 'Compose' menu will be displayed.
- the first position blinks.
- select with the control disc the desired character on the displayed keyboard.
- press **ENTER** to select.
- the second position starts blinking and can be programmed in the same way.

Maximum 6 position can be entered in the same way.

When the name is programmed, press **EXIT** to return to the channel list.

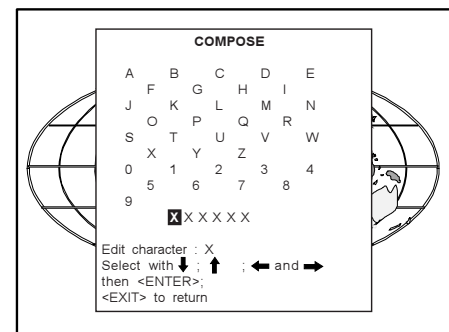

## Bilingual : sound A

This menu option is only visible when a dual sound transmission is available on the selected channel.

Highlight '*Bilingual : Sound A*' by pushing the control disc up or down and press **ENTER** to toggle between Sound A or Sound B.

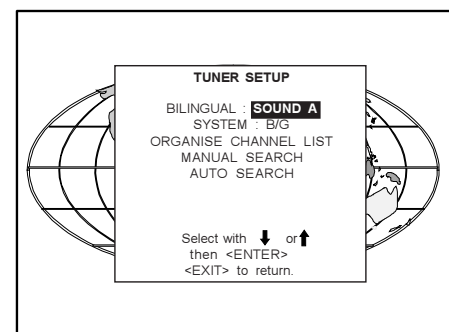



## Teletext

This teletext function is only available when operating in tuner mode.  
To enter the teletext mode, press the TEXT key.

The following keys on the RCU has a function in the teletext mode :

TEXT : a 3 way toggle key



NUM key (0 ...9)

To enter directly the page numbers (3 digits), e.g. 730, press the digit 7-3-0 successively.

The number of the chosen page will appear in the top left-hand corner of the screen. The digits in the normal page number position will rotate according to the page transmission order. When the requested page number appears, the old page will be replaced by the new one.

FREEZ key

If you wish to stop temporarily the search for a page or the automatic rotation of some pages, then press the **FREEZ** key. To allow normal operation, press this button again.

ENTER key

To display a particular sub-page of a page. Select first your page. Press **ENTER** to display at the top left corner a T followed by 4 blanks. Enter the sub-page number. E.g. sub-page 4 : enter digits 0004. The selected sub-page will be displayed on the screen and remains on the screen. This page will frequently updated.

HELP key

To display concealed information. Some teletext pages contain concealed information such as answers to puzzles. To reveal this information press the **HELP** key.

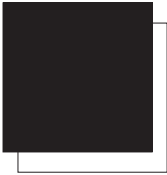

# INSERT CARD

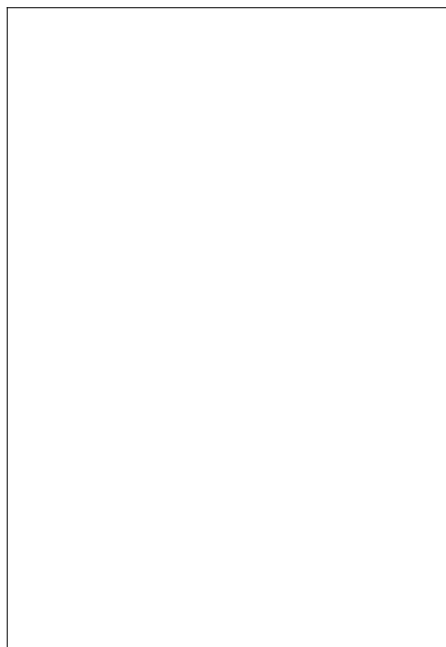

RCU	
INPUT SOURCES	
PROJECTOR	
1	Comp Video
2	S-Video
3	
4	RGsB
5	RGBS
6	YsUV
7	YUVS

RCU	
INPUT SOURCES	
PROJECTOR	
1	
2	
3	
4	
5	
6	
7	

INPUT SOURCES	
RCVDS	
1	
2	
3	
5	
6	
7	
8	
9	
10	

INPUT SOURCES	
RCVDS	
1	
2	
3	
5	
6	
7	
8	
9	
10	



## Free Manuals Download Website

<http://myh66.com>

<http://usermanuals.us>

<http://www.somanuals.com>

<http://www.4manuals.cc>

<http://www.manual-lib.com>

<http://www.404manual.com>

<http://www.luxmanual.com>

<http://aubethermostatmanual.com>

Golf course search by state

<http://golfingnear.com>

Email search by domain

<http://emailbydomain.com>

Auto manuals search

<http://auto.somanuals.com>

TV manuals search

<http://tv.somanuals.com>