

UL2000M

ULTRALINK

User's manual



Version 1.2 August 2006

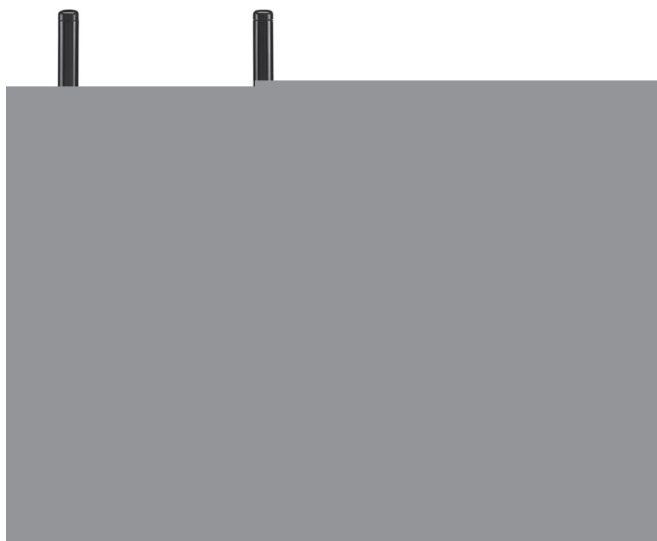

www.behringer.com



ROOM

risk of electric shock, do not remove the top cover (or the rear cover) unless the user is qualified for servicing to qualified



→ risk of fire or electric shock if the appliance is exposed to moisture. The apparatus should not be placed in or near objects filled with liquids, such as vases, should be used with the apparatus.



G

TABLE OF CONTENTS

1. INTRODUCTION	4
1.1 Before you get started	4
1.1.1 Shipment	4
1.1.2 Registration	4
1.1.3 Initial operation of the receiver	4
1.1.4 Initial operation of the microphone	5
1.1.5 Online registration	5
2. ULR2000 RECEIVER	6
2.1 Control elements and connections	6
2.1.1 The front	6
2.1.2 Display	7
2.1.3 The back	8
2.2 Menu items in detail	8
2.2.1 TUNE	8
2.2.2 SCAN	9
2.2.3 SQUELCH	9
2.2.4 AUTOMUTE	10
2.2.5 DISPLAY	10
2.2.6 LOCK	10
2.2.7 PRESET	11
3. ULM2000 MICROPHONE	12
3.1 Control elements	12
3.2 Hand-held transmitter operation	12
3.2.1 Turning the microphone on	12
3.2.2 Channel setting	12
3.2.3 Setting your own frequency	13
3.2.4 Preset	14
3.2.5 Mic Gain	15
3.2.6 Auto Mute	15
3.2.7 Turning the microphone off	16
3.3 Status query	16
3.3.1 Battery condition and transmission channel	16
3.3.2 Transmission frequency	17
3.3.3 Preset	17
3.3.4 Mic Gain	17
3.3.5 Auto Mute	17
3.5 ULM2000 level setting	17
4. APPLICATION EXAMPLE	18
5. INSTALLATION	18
5.1 Installation information	18
5.2 Installation in a rack	19
5.3 Audio connections	20
6. SPECIFICATIONS	21
6.1 ULR2000 receiver	21
6.2 ULM2000 microphone	22
FEDERAL COMMUNICATIONS COMMISSION COMPLIANCE INFORMATION	23
MICROPHONE QUICK START GUIDE	24

ULTRALINK UL2000M

1. INTRODUCTION

Thank you very much for expressing your confidence in the ULTRALINK Series by purchasing this unit. With the UL2000M from BEHRINGER, you have acquired a modern, high-performance wireless transmission system.

Thanks to its amazing set of features, you can use the UL2000M in all situations in which the highest sound quality and mobility are a must, e.g. live concerts, events and video productions.

Depending on your local wireless transmission regulations, you can use up to 20 systems simultaneously.

The ULR2000 receiver uses two complete receiver channels, which are automatically tuned to the same frequency. This function requires no attention from the user. This so-called True Diversity technology enables outstanding disturbance-free signal transmission. This way, you can profit from the greatest freedom of movement and can fully concentrate on what's essential: your music.

GB

The IRC compander system guarantees an extremely wide transmission dynamic range. Since vocals benefit from this characteristic most, the UL2000M is ideal for such applications.

The microphone features a high-quality Panasonic® capsule with a cardioid polar pattern. Therefore, it primarily picks up the sound from the front and less so from the sides. The signal entering the microphone from the back is mostly suppressed. This way, the microphone's propensity to creating feedback is very negligible, even in live situations.

The ULTRALINK Series equipment features 3 factory presets, each with 8 permanent, interference-free channels. This allows you to use several systems in parallel without them influencing one another. Additionally, you have the option of storing 8 of your own frequencies in a user preset, thus individually addressing your own needs.

Determining which microphone is assigned to which receiver is done either by observing the transmission channel in the display or by comparing the transmission frequency. In addition, the ULTRALINK equipment from BEHRINGER leaves you the option to color-code your gear for easy identification.

Beyond that, both units feature other useful functions, such as Scan and Auto Mute. This way, no wishes are left open during practice or in live situations.

 **The following instructions are intended to familiarize you with the unit's controls, so that you can learn all of its functions. After having thoroughly read these instructions, store them in a safe place for future reference.**

1.1 Before you get started

1.1.1 Shipment

The UL2000M was carefully packed at the factory to assure secure transportation. Should the condition of the cardboard box suggest that damage may have taken place, please inspect the unit immediately and look for physical indications of damage.

 **Damaged units should NEVER be sent directly to us. Please inform the dealer from whom you acquired the unit immediately as well as the transportation company from which you took delivery of the unit. Otherwise, all claims for replacement/repair may be rendered invalid.**

 **Always use the original packaging to avoid damage due to storage or shipment.**

 **Never leave children unsupervised with the unit or its packaging.**

 **Please dispose of all packaging materials in an environmentally friendly manner.**

1.1.2 Registration

Before powering up the unit for the first time, you **have to register** it with your local postal/telecommunication authority! Additional information is available there.

1.1.3 Initial operation of the receiver

Assure adequate ventilation and never place your ULR2000 receiver on top of an amplifier or near radiators to avoid overheating.

The wall power unit (model: E-SPS1) included in the delivery supplies the power to your ULR2000. Only use the external power supply delivered with the unit!

The interchangeable AC plugs can be swapped at any time, adapting to various socket types in different countries (Fig. 1.1).

1. Keep the button (A) on the front side of the power supply pressed to release the plug. Pull the plug out and let go of the button.
2. Insert a different plug into the power supply unit. The plug is securely snapped into place when you hear a click.

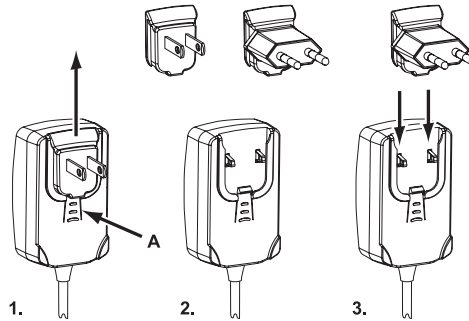

Fig. 1.1: Swapping plugs on the switching power supply unit



1.1.4 Initial operation of the microphone

The ULM2000 microphone requires one or two 9V batteries. Of course, using only one 9V battery decreases the effective uptime. When using only one battery, it does not matter which of the two battery compartments you use. Either one will work.

 **When running the unit on two batteries, please make sure that both batteries are equally fresh. Therefore, whenever changing batteries, always use two brand-new batteries.**

When the battery is nearly depleted, the LED located on the bottom of the microphone will start to blink rapidly. Simultaneously, a special inaudible signal is sent to the ULR2000 receiver, and "LowBat" is shown in its display. To assure dependable operation of the transmitter-receiver system, change the transmitter batteries as soon as possible after seeing the "LowBat" message.

To change the transmitter (mic) batteries:

1. Twist the upper part of the microphone grip while firmly holding its lower portion.
2. Pull the battery compartment out of the microphone until you reach its stop position.
3. Remove the old batteries. Insert one or two fresh 9V batteries.
4. Slide the upper part of the microphone over its lower portion and firmly screw it on.

1.1.5 Online registration

Please do remember to register your new BEHRINGER equipment right after your purchase by visiting www.behringer.com (alternatively www.behringer.de) and kindly read the terms and conditions of our warranty carefully.

Should your BEHRINGER product malfunction, our goal is to have it repaired as quickly as possible. To arrange for warranty service, please contact the retailer from whom the equipment was purchased. Should your BEHRINGER dealer not be located in your vicinity, you may directly contact one of our subsidiaries. Corresponding contact information is included in the original equipment packaging (Global Contact Information/European Contact Information). Should your country not be listed, please contact the distributor nearest you. A list of distributors can be found in the support area of our website (www.behringer.com).

Registering your purchase and equipment with us helps us process your repair claims quicker and more efficiently.

Thank you for your cooperation!

ULTRALINK UL2000M

2. ULR2000 RECEIVER

2.1 Control elements and connections

In this chapter, different control elements of your ULR2000 will be described, explained in detail, and you will get useful information on how to use them.

2.1.1 The front

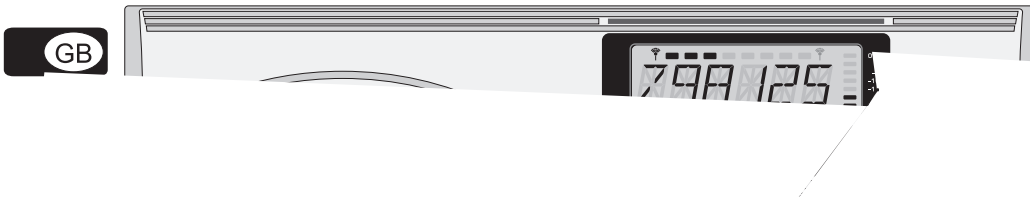

6 COLOR CODE

Each BEHRINGER ULTRALINK transmitter can be color-coded using a color ring; this way you can easily differentiate between multiple transmitters (set to different frequencies). To easily match a transmitter to a receiver, you can also attach color-coded strips to each receiver.

7 ANTENNA

Two bar antennae can be connected to the ANTENNA 1 and ANTENNA 2 connectors.

2.1.2 Display

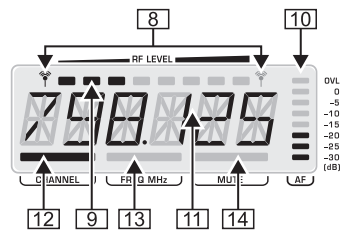

Fig. 2.2: Closeup of the ULR2000 display

8 (antenna symbol)

These two antenna symbols indicate which antenna signal is currently being processed. The left symbol lights up when the signal from the left-hand antenna (ANTENNA 1) is stronger, and the right symbol shows that the signal from the right-hand antenna (ANTENNA 2) is being processed.

9 RF LEVEL

The 8-level RF LEVEL display shows the reception strength of the carrier frequency (Radio Frequency) on the ULR2000.

If not a single bar is shown, the carrier frequency is not being received. Bad reception is indicated with 1 - 3 bars; signal noise may be somewhat higher in this case. The more bars are shown, the better the reception of the transmitter carrier frequency on the ULR2000.

10 AF

Similar to a distortion gauge on a mixer or an amplifier, the 8-level AF indicator shows how loud the demodulated audio signal (Audio Frequency) is.

If the signal has no amplitude or if the amplitude is low, no bars are shown. The maximum undistorted AF-level is received when 7 bars (and not 8!) light up.

Only when the audio signal is overdriving or when no RF signal can be received (the receiver creates too much noise), 8 bars are shown in the LCD.

11 Alphanumeric display

All the values and letters relevant to the operation of your ULR2000 are shown in the 6-digit alphanumeric display: for example, channel number, channel color, frequency and menu items.

12 CHANNEL

If the ULR2000 is in the basic setting (menu not selected), pressing the ▲ UP and ▼ DOWN buttons changes the transmission channel within the selected preset.

If CHANNEL is lit, the individual *channel numbers* are shown (CHAN1, CHAN2, ...).

Also, when storing a user-selected frequency in the user preset, a channel number is entered.

13 FREQ MHz

If FREQ MHz lights up, changing the transmission channel using the ▲ UP and ▼ DOWN buttons also displays the *frequency* of the selected channel.

If neither CHANNEL nor FREQ MHz are lit, the display is indicating the *channel color* (BLUE, RED, ...) of the set channel. When storing a user-selected frequency in the user preset, you will be asked to enter a channel color.

ULTRALINK UL2000M

14 MUTE

MUTE indicates that the ULR2000's output is being muted.

If the received and demodulated AF starts getting weaker, the noise increases; the signal-to-noise ratio gets smaller.

The SQUELCH menu item lets you enter a threshold value (in dB) for the signal-to-noise ratio. If this ratio gets smaller than the threshold value, the receiver automatically mutes the signal (ch. 2.2.3).

2.1.3 The back

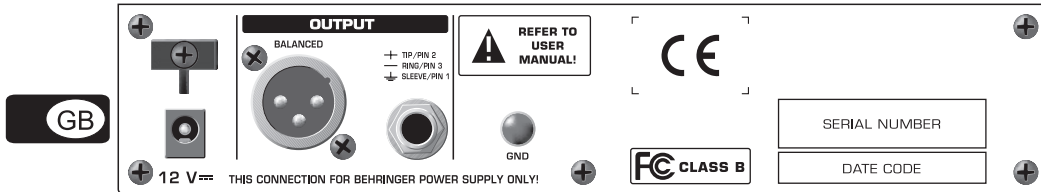

4. If a valid frequency value is set, press the SET button again. In the display, you are asked to enter where you want to save your settings. Depending on the basic settings (ch. 2.2.5), the ULR2000 asks you to enter a channel color (BLUE, RED, ...) or a channel number (CHAN1, CHAN2, ...).
5. A storage location can be selected by pressing the ▲ UP or ▼ DOWN buttons.
6. Press the SET button again to store your frequency at the location you selected. The procedure is now over, and the basic settings are shown in the display again (channel number, channel frequency or channel color).

 **A user-selected frequency is always stored in the user preset (Preset 1)! If necessary, the unit automatically switches to this preset.**

2.2.2 SCAN

Similar to a tuner in a radio or a TV set, the ULR2000 automatically searches for a transmitter when in SCAN mode. For it to work, the transmitter (e.g. the ULM2000) must be turned on!



1. Press the SET button to get to the menu.
2. Press the ▲ UP button once to get to SCAN.
3. Press the SET button again to get to the SCAN submenu. The display shows the current frequency.
4. Either press ▲ UP or ▼ DOWN. This way, you determine if the scan is going to be performed in the ascending or descending direction. The scan begins.
5. As soon as the ULR2000 recognizes the transmitter frequency, it is shown in the display. If this frequency is not the frequency you were looking for, you can start a new scan by pressing the ▲ UP or ▼ DOWN buttons.
6. If the receiver found the correct frequency, press the SET button again. In the display, you are asked to enter where you want to save your settings. Depending on the basic settings, the ULR2000 asks you to enter a channel color (BLUE, RED, ...) or a channel number (CHAN1, CHAN2, ...).
7. A storage location can be selected by pressing the ▲ UP or ▼ DOWN buttons.
8. Press the SET button again to store your frequency at the location you selected. The procedure is now over, and the basic settings are shown in the display again.

 **A scan can also be halted manually (e.g. in case the receiver is unable to locate a transmitter). To do this, press the SET button; the scan is immediately interrupted. Now, you can either start another scan (see lines 4 and 5), or the frequency shown can be stored (see lines 6, 7 and 8).**

2.2.3 SQUELCH

With wireless signal transmission, restricted reception conditions may cause the transmission of additional noise and interference. The Squelch function lets you adjust if the ULR2000 is muted under such conditions. You can also enter the noise level that will trigger the mute function:

- ▲ 0 dB: the receiver is not muted
- ▲ low dB value: the receiver is muted only if substantial noise is transmitted with the signal
- ▲ high dB value: the receiver is muted even if the noise floor is low

Setting a Squelch value

1. Press the SET button to get to the menu.
2. Press the ▲ UP button twice to get to SQUELCH.
3. Press the SET button again to get to the SQUELCH submenu. The display shows the current dB value.
4. Press the ▲ UP or the ▼ DOWN buttons to adjust the dB value of the noise limiter. Values between 0 and 40 dB can be selected in 5-dB increments.

 **If a squelch value of 0 dB is set, the receiver will not mute the signal no matter how noise-saturated the incoming signal is.**

5. Press the SET button to store your dB value. The procedure is now over, and the basic settings are shown in the display again.

ULTRALINK UL2000M

2.2.4 AUTO MUTE

If the transmitter is turned on, off, or is switched to another channel without first muting the receiver, or if the transmission drops out due to weak batteries, audible noise will result. Even if the noise limiter is enabled on the receiver (ch. 2.2.3), it still requires some time to react, and such noise can not be suppressed safely.

To bridge this latency time, the ULR2000 offers a practical Auto Mute function:

- ▲ When the ULM2000 is being turned off, when you are switching channels or during low-battery indication, an inaudible send signal is being transmitted.
- ▲ The ULR2000 recognizes this signal and automatically mutes the output before the transmitter is actually turned off, switched to another channel or before it powers down on its own due to battery charge being too low.

 **For the Auto Mute function to work, it has to be activated on both the transmitter and the receiver!**

GB

Activating/deactivating the Auto Mute function

1. Press the SET button to get to the menu.
2. Press the ▲ UP button three times to get to A.MUTE.
3. Press the SET button again to get to the A.MUTE submenu. Depending on the current setting, the display shows ON or AMTOFF.
4. Press the ▲ UP or the ▼ DOWN buttons to turn the auto mute function on or off.
5. Press the SET button to save your settings. The procedure is now over, and the basic settings are shown in the display again.

2.2.5 DISPLAY

When you power the ULR2000 on, its basic settings are loaded. That means that the channel you selected last is shown; you can change this channel immediately without going to menu by using the ▲ UP and ▼ DOWN buttons.

There are 3 different ways to show the selected channel in the display. You can decide for yourself which representation is the most appropriate for your applications:

- ▲ The exact channel carrier frequency is shown (FREQU).
- ▲ The channel number is shown in the display (CHANNL).
- ▲ The color assigned to the channel is shown in the display (COLOR).

Changing the ULR2000's basic settings

1. Press the SET button to get to the menu.
2. Press the ▼ DOWN button three times to get to DISPL.
3. Press the SET button again to get to the DISPL submenu. The display shows the current basic parameter.
4. Press the ▲ UP and ▼ DOWN buttons to set one of the 3 parameters (FREQU, CHANNL or COLOR).
5. Press the SET button to store the parameter for the basic setting. The procedure is now over, and the new basic setting is shown in the display.

2.2.6 LOCK

To prevent your settings from accidentally being changed, you can activate the keylock function (LOCK). With the exception of the SET button, all other buttons (including the Power button) are locked. If one of those buttons is pressed, "LOCKED" is shown in the display.

Activating LOCK

1. Press the SET button to get to the menu.
2. Press the ▼ DOWN button twice to get to LOCK.
3. Press the SET button again to get to the LOCK submenu. The display shows LOCOFF.
4. Press the ▲ UP and ▼ DOWN buttons once to activate the keylock function. The display shows LOC ON.
5. Press the SET button to activate the keylock function. The procedure is now over, and the basic settings

are shown in the display again.

Deactivating LOCK

1. Press the SET button. LOC ON is shown in the display.
2. Press the ▲ UP or ▼ DOWN button once to select LOCOFF.
3. Press the SET button confirm, hence deactivating the keylock function. The procedure is now over, and the basic settings are shown in the display again.

2.2.7 PRESET

The ULR2000 lets you work with 4 presets, each with 8 channels.

Factory presets (Presets 2, 3 and 4)

In the ULR2000, there are 3 factory presets (each with 8 interference-free channels). That means that all 8 channels of one preset can run simultaneously with 8 different transmitters and receivers without causing mutual interference.

The channels in the 3 factory presets are all assigned to different frequencies. This way, you can always select a frequency range that assures the best signal transmission.

The following table shows which frequencies are stored in the factory presets.



CHANNEL	PRESET 2	PRESET 3	PRESET 4
1	798,700 MHz	798,400 MHz	798,100 MHz
2	799,950 MHz	798,950 MHz	798,650 MHz
3	800,650 MHz	799,800 MHz	799,500 MHz
4	801,050 MHz	801,450 MHz	801,150 MHz
5	802,850 MHz	803,250 MHz	802,950 MHz
6	804,500 MHz	803,650 MHz	803,350 MHz
7	805,350 MHz	804,350 MHz	804,050 MHz
8	805,900 MHz	805,600 MHz	805,300 MHz

Table 2.1: Factory preset frequencies (presets 2,3 and 4)

User preset (Preset 1)

Preset 1 is meant for the user. Frequencies of your own choice can be stored in the 8 storage slots of this preset.

If you have not stored any of your own frequencies, the frequencies stored in the user preset (Preset 1) are identical to the frequencies stored in Preset 3.

Loading a preset

1. Press the SET button to get to the menu.
2. Press the ▼ DOWN button once to get to PRESET.
3. Press the SET button again to get to the PRESET submenu. The display shows the currently active preset.
4. Press the ▲ UP and ▼ DOWN buttons to select the desired preset. The display shows PSET 1 (2, 3 or 4).
5. Press the SET button to load up the preset you selected. The procedure is now over, and the basic setting is shown in the display again.

3. ULM2000 MICROPHONE

3.1 Control elements

In this chapter, different control elements of your ULM2000 will be described, explained in detail, and you will get useful information on how to use them.

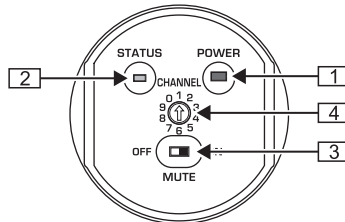

Fig. 3.1: ULM2000's underside

- 1 **POWER**
To power the hand-held transmitter on or off, keep the POWER button pressed for at least 2 seconds. Briefly pressing the POWER button confirms your choices when entering values (refers to later chapters). Additionally, you can check the current transmitter settings (selected channel and battery condition).
- 2 **STATUSLED**
Through repeated blinking, the status LED gives the account of the current settings for all parameters. We differentiate between 3 different blinking tempos:
 - ▲ The LED blinks **slowly** when you, for example, successfully leave the programming mode.
 - ▲ To give the account of the channel number or individual frequency values, the LED blinks with **medium** tempo.
 - ▲ **Rapid** blinking indicates an error, for example an empty battery or a faulty entry.
- 3 **MUTE switch**
Engaging the MUTE switch mutes the microphone. Additionally, the ULM2000 can be switched to programming mode by selecting the digits 9 or 0; or, you can get a readout of a specific unit setting.
- 4 **SELECTION SWITCH**
Using a screwdriver, you can select different values on the SELECTION SWITCH. For example, you can select a channel number and the frequency.

The **SERIAL NUMBER** is located on the transmitter battery compartment. To get to the serial number, please open the battery compartment (see ch. 1.1.4).

3.2 Hand-held transmitter operation

A brief overview with the graphic representation on operating the transmitter is found on the last page of this user manual (QUICK REFERENCE GUIDE).

3.2.1 Turning the microphone on

1. Press the POWER button located at the bottom of the microphone and keep it pressed for 2 seconds.
2. A blink code follows, indicating the battery condition:
1 = Battery is nearly empty . . . 5 = Battery is fully charged
3. Afterward, a second blink code indicates to which channel the transmitter is currently set.
1 = channel 1 is selected . . . 8 = channel 8 is selected

3.2.2 Channel setting

You can comfortably select a channel within a preset by using the selection switch [4]. In doing so, it is irrelevant whether the microphone is on or off.

Changing the channel when the transmitter is already powered on

 **During this procedure, the transmitter may not be set to mute!**

1. Turn the selection switch to one of the positions 1 - 8, corresponding to the desired channel number. If a valid value is selected (i.e. neither 9 nor 0), the LED blinks quickly once as a confirmation.
2. Briefly press the POWER button. The LED blinks with medium tempo. The number of individual flashes within one cycle corresponds to the value/channel number selected on the selection switch.

 **If an invalid channel number is selected (0 or 9), the channel selected last remains selected.**

Changing the channel when the transmitter is powered off

1. Turn the selection switch to one of the values (1 - 8), corresponding to the desired channel number.
2. If you turn on the transmitter, the channel you selected is automatically loaded.

 **If an invalid channel number was selected (0 or 9), the channel selected last remains selected.**

3.2.3 Setting your own frequency



A carrier frequency in the range between 798.1 and 805.9 MHz can be freely selected. This frequency is stored in a self-assignable user preset (Preset 1).

 **The carrier frequency can only be set in 25-kHz steps. The frequency you select has to be a multiple of 25 kHz. If you select a frequency that is not a multiple of 25 kHz or does not lie in the frequency range between 798.1 and 805.9 MHz, the ULM2000 gives off an error message (the LED blinks quickly 5 times).**

1. Engage MUTE. The transmitter can now be switched to the programming mode.
2. Turn the selection switch to 9 and confirm your selection by keeping the POWER button pressed for about 2 seconds. The LED indicates confirmation by blinking once with medium tempo and blinking once slowly. The transmitter is now in the programming mode and awaits the entry of a 6-digit frequency.
3. Enter all 6 digits one after another in the following fashion:
 - ▲ Select the desired value on the selection switch, for example 4. If a valid value is selected, the LED blinks quickly once as a confirmation. This way, you can be sure that a correct value is entered (in regard to the frequency range and divisibility by 25 kHz) even before confirming your selection.
 - ▲ Confirm your selection by briefly pressing the POWER button.
 - ▲ If the end frequency value you entered is valid, the LED blinks quickly once more. If the frequency value is invalid, the LED blinks quickly 5 times, and the unit is no longer in the programming mode. In this case, start anew with step 2.
After a brief interruption, a second blink code is given: the LED blinks corresponding to the value selected (in this case, 4 times) with medium tempo.



 **The value 0 is indicated by a very short blink of the LED, and you will easily tell a 0 from a 1.**

 **If no entry is made for more than 5 seconds (either on the selection switch or by pressing the POWER button), the LED blinks quickly 5 times, and the programming mode is aborted.**

After entering the 6 digits for the frequency value, enter another value to indicate the channel number under which the frequency will be stored.

4. Select a desired channel number on the selection switch, for example channel 2 (possible values: 1 - 8). If a valid value is selected, the LED blinks quickly once to confirm. This way, you can be sure that a correct channel number is being entered even before confirming your selection.
5. Confirm your selection by briefly pressing the POWER button.
6. When a valid value is selected, the LED blinks briefly again. When an invalid value is selected, the LED blinks quickly 5 times and the unit is no longer in the programming mode. In this case, start anew with step 2.
After a brief interruption, a second blink code is given: the LED blinks corresponding to the value selected (in this case, 2 times) with medium tempo.

ULTRALINK UL2000M

7. After a second blink pause, an additional blink code is given as a confirmation:
 - ▲ A successfully stored frequency is signaled with 2 slow blinks. The transmitter leaves the programming mode.
 - ▲ If the LED blinks quickly 5 times, the frequency was not stored. In this case, start anew with step 2.
-  **If no entry is made for more than 5 seconds (either on the selection switch or by pressing the POWER button), the LED blinks quickly 5 times, and the programming mode is aborted.**
8. Disengage the MUTE switch.
-  **A user-assigned frequency is automatically stored in the user preset (Preset 1)!**

3.2.4 Preset

The ULM2000 lets you work with 4 presets, each with 8 channels.

GB

Factory presets (Presets 2, 3 and 4)

In the ULM2000, there are 3 factory presets (each with 8 interference-free channels). That means that all 8 channels of one preset can run simultaneously with 8 different transmitters and receivers without causing interference to one another.

The channels in the 3 factory presets are all assigned to different frequencies. This way, you can always select a frequency range that assures the best signal transmission.

The following table shows which frequencies are stored in the factory presets.

CHANNEL	PRESET 2	PRESET 3	PRESET 4
1	798,700 MHz	798,400 MHz	798,100 MHz
2	799,950 MHz	798,950 MHz	798,650 MHz
3	800,650 MHz	799,800 MHz	799,500 MHz
4	801,050 MHz	801,450 MHz	801,150 MHz
5	802,850 MHz	803,250 MHz	802,950 MHz
6	804,500 MHz	803,650 MHz	803,350 MHz
7	805,350 MHz	804,350 MHz	804,050 MHz
8	805,900 MHz	805,600 MHz	805,300 MHz

Table 3.1: Factory preset frequencies (presets 2,3 and 4)

User preset (Preset 1)

Preset 1 is meant for the user. Frequencies of your own choice can be stored in the 8 storage slots of this preset.

If you have not stored any of your own frequencies, the frequencies stored in the user preset (Preset 1) are identical to the frequencies stored in Preset 3.

Loading a preset

1. Engage MUTE. The transmitter can now be switched into the programming mode.
2. Turn the selection switch to 0 and confirm your selection by keeping the POWER button pressed for 2 seconds. As a confirmation, the LED blinks slowly once and then once again with medium tempo. The transmitter is now in the programming mode and waits for you to enter a one-digit number.
3. Select the desired preset number on the selection switch, e.g. 3 (possible choices: 1 - 4). If a valid selection is made, the LED blinks once quickly to confirm your selection. This way, you can be sure that a correct value is entered (in regard to the selection of presets, Mic Gain and Auto Mute) even before confirming your selection.

 **Selecting 5 or 6 changes the Mic Gain setting (ch. 3.2.5). Selecting 7 or 8 changes the Auto Mute settings (ch. 3.2.6). Values 9 and 0 are invalid.**

4. Confirm your selection by briefly pressing the POWER button.
5. If the selection you made is valid, the LED blinks quickly once again. An invalid selection is indicated with 5 quick blinks, and the unit is immediately no longer in the programming mode. In this case, start anew with step 2.
After a brief break, a second blink code is given: The LED blinks according to the value selected (for example, in this case 3 times) with medium tempo.

 **If no entry is made for more than 5 seconds (either on the selection switch or by pressing the POWER button), the LED blinks quickly 5 times, and the programming mode is aborted.**

6. After a second brief blink break, an additional blink code is given as a confirmation:
 - ▲ Successful loading of a preset is signaled with two slow blinks. The unit leaves the programming mode.
 - ▲ If the preset could not be loaded, the LED blinks quickly 5 times. In this case, start anew with step 2.
7. After setting the desired preset, disengage the MUTE switch.

3.2.5 Mic Gain

You have the option to adjust the ULM2000 to the level of the signal being transmitted. If you talk very softly into the microphone, we recommend the "High Gain" setting; if the sound is loud, select "Low Gain." This way, optimal transmitter drive is achieved.



1. Engage MUTE. The transmitter can now be switched into the programming mode.
2. Turn the selection switch to 0 and confirm your selection by keeping the POWER button pressed for 2 seconds. As a confirmation, the LED blinks slowly once and then once again with medium tempo. The transmitter is now in the programming mode and waits for you to enter a one-digit number.
3. Select one of the following two digits on the selection switch:
 - ▲ Low Gain: select 5
 - ▲ High Gain: select 6

If a valid selection is made, the LED blinks quickly once to confirm your selection. This way, you can be sure that a correct value is entered (in regard to preset, MicGain and Auto Mute selection) even before confirming your selection.

 **Selecting the values 1 thru 4 changes the preset settings (ch. 3.2.4). Selecting 7 or 8 changes the Auto Mute settings (ch. 3.2.6). Values 9 and 0 are invalid.**

4. Confirm your selection by briefly pressing the POWER button.
5. If the selection you made is valid, the LED blinks quickly once again. An invalid selection is indicated with 5 quick blinks, and the unit is immediately no longer in the programming mode. In this case, start anew with step 2.

After a brief break, a second blink code is given: The LED blinks according to the value selected (for example, in this case 3 times) with medium tempo.

 - ▲ Low Gain: the LED blinks once with medium tempo.
 - ▲ High Gain: the LED blinks twice with medium tempo.

 **If no entry is made for more than 5 seconds (either on the selection switch or by pressing the POWER button), the LED blinks quickly 5 times, and the programming mode is aborted.**

6. After a second brief blink break, an additional blink code is given as a confirmation:
 - ▲ Successful loading of a preset is signaled with two slow blinks. The transmitter leaves the programming mode.
 - ▲ If the setting for Mic Gain could not be stored, the LED blinks quickly 5 times. In this case, start anew with step 2.
7. Disengage MUTE.

3.2.6 Auto Mute

If the transmitter is turned on, off or switched to another channel without first muting the receiver, or if the transmission fails due to weak batteries, audible noise will result. Even if the squelch circuit is turned on at the receiver end, it still requires some time to react, and such noise can not be suppressed safely.

To bridge this latency time, the ULM2000 offers a practical Auto Mute function:

- ▲ When the ULM2000 is being turned off, when you are switching channels or during low-battery indication, an inaudible send signal is being transmitted.
- ▲ The ULR2000 recognizes this signal and automatically mutes the output before the transmitter is actually turned off, switched to another channel or before it powers down on its own due to battery charge being too low.

ULTRALINK UL2000M

 For the Auto Mute function to work, it has to be activated on both the transmitter and the receiver!

Activating/deactivating the Auto Mute function

1. Engage MUTE. The transmitter can now be switched into the programming mode.
2. Turn the selection switch to 0 and confirm your selection by keeping the POWER switch pressed for 2 seconds. As a confirmation, the LED blinks slowly once and then once again with medium tempo. The transmitter is now in the programming mode and waits for you to enter a one-digit number.
3. Select one of the following two digits on the selection switch:
 - ▲ Activate Auto Mute: select 7
 - ▲ Deactivate Auto Mute: select 8

If a valid selection is made, the LED blinks quickly once to confirm your selection. This way, you can be sure that a correct value is entered (in regard to preset, MicGain and Auto Mute selection) even before confirming your selection.

 **Selecting the values 1 through 4 changes the preset settings (ch. 3.2.4). Selecting 5 or 6 changes the Mic Gain settings (ch. 3.2.5). Values 9 and 0 are invalid.**

4. Confirm your selection by briefly pressing the POWER button.
5. If the selection you made is valid, the LED blinks quickly once again. An invalid selection is indicated with 5 quick blinks, and the unit is immediately no longer in the programming mode. In this case, start anew with step 2.
After a brief break, a second blink code is given:
 - ▲ Auto Mute activated: the LED blinks once at middle tempo.
 - ▲ Auto Mute engaged: the LED blinks twice at middle tempo.

 **If no entry is made for more than 5 seconds (either on the selection switch or by pressing the POWER button), the LED blinks quickly 5 times, and the programming mode is aborted.**

6. After a second brief blink break, an additional blink code is given as a confirmation:
 - ▲ Two slow blinks signal that the Auto Mute setting was changed. The transmitter leaves the programming mode.
 - ▲ If the setting for Auto Mute could not be stored, the LED blinks quickly 5 times. In this case, start anew with step 2.
7. Disengage MUTE.

3.2.7 Turning the microphone off

To turn of the transmitter, keep the POWER button pressed for 2 seconds. A long blink confirms that microphone is being turned off.

 **The transmitter stores the frequency and the channel settings. These parameters are restored to these same values the next time you turn the unit on.**

3.3 Status query

While you are using your microphone, you may want to check the "transmission channel," "battery condition," "transmission frequency," "preset," "Mic Gain" and "Auto Mute" parameters. The status of these parameters can be checked without having to turn the microphone off and back on.

3.3.1 Battery condition and transmission channel

1. Turn the selection switch to 0. The position of the MUTE switch does not matter.
2. Briefly press the POWER button.
3. Just like when powering the microphone on, the microphone status is indicated with medium-tempo blink codes:
 - ▲ battery condition: 1 = battery is nearly empty . . . 5 = battery is fully loaded
 - ▲ selcted channel: 1 = channel 1 is selected. . . 8 = channel 8 is selected

 If the receiver is not powered on, no status is indicated. Briefly pressing the POWER button will neither turn the transmitter on nor off!

3.3.2 Transmission frequency

1. Turn the selection switch to 9. The position of the MUTE switch is irrelevant.
2. Briefly press the POWER button.
3. Just like during programming, 6 blink medium-tempo codes indicate the individual digits that make up the transmission frequency. Individual codes are separated from one another by brief pauses.

 The value 0 is signaled by a very short blink of the LED, and you will easily tell a 0 from a 1.

 If the receiver is not powered on, no status is indicated. Briefly pressing the POWER button will neither turn the transmitter on nor off!



3.3.3 Preset

1. Make sure that the microphone is not set to mute (MUTE switch is set to OFF).
2. Turn the selection switch to 1, 2, 3 or 4 and confirm your selection by briefly pressing the POWER button.
3. The LED indicates the preset number with the corresponding number of medium-tempo blinks.

3.3.4 Mic Gain

1. Make sure that the microphone is not set to mute (MUTE switch is set to OFF).
2. Turn the selection switch to 5 or 6 and confirm your selection by briefly pressing the POWER button.
3. The LED indicates the Mic Gain status with the corresponding number of medium-tempo blinks:
 - ▲ Low Gain: The LED blinks once with medium tempo.
 - ▲ High Gain: The LED blinks twice with medium tempo.

3.3.5 Auto Mute

1. Make sure that the microphone is not set to mute (MUTE switch is set to OFF).
2. Turn the selection switch to 7 or 8 and confirm your selection by briefly pressing the POWER button.
3. The LED indicates the Auto Mute status with the corresponding number of medium-tempo blinks:
 - ▲ Auto Mute turned off: The LED blinks once with middle tempo.
 - ▲ Auto Mute turned on: The LED blinks twice with middle tempo.

3.5 ULM2000 level setting

 To optimally set the level on your ULM2000, the High Gain or Low Gain setting has to be set to the level of the signal being transmitted (ch. 3.2.5).

Adjust the gain control in the microphone channel of your mixing console so that the peak LED lights up only occasionally or never at all. The EQ controls in the microphone channel should be set to mid-travel position to start with. To get the sound you want, try changing the mic position relative to the sound source or even move the microphone around in the recording room of your studio. Adjusting the angle at which walls face the sound source can also be helpful. Only when the desired basic sound has been achieved should you start to use equalizers and signal processors, if any at all (remember: less is often more!)

ULTRALINK UL2000M

4. APPLICATION EXAMPLE

Fig. 4.1 shows how easy it is to use the products from the BEHRINGER ULTRALINK Series. Simply connect the balanced XLR output on the ULR2000 to the XLR input on your mixing console. Of course, you can use the receiver's TRS output to connect to the next device in the signal path.

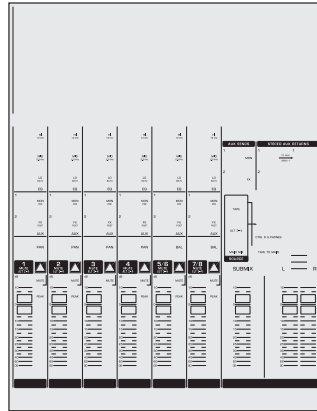
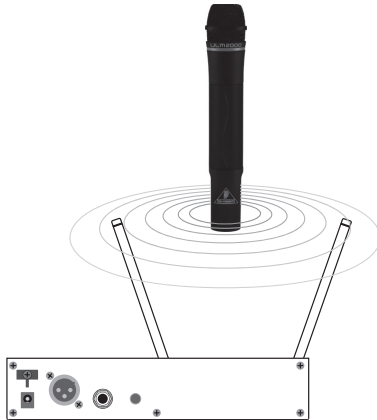

5.2 Installation in a rack

The ULR2000's antennae are located in the front of the unit. This allows unproblematic installation in a rack.

Each unit is delivered with a rack bracket and a connecting joint. This way, you can choose:

1. If you wish to install only one unit in a rack, mount a rack bracket to one of the sides. In this case, you will not need the included connecting joint. Now, install one side of the receiver into the rack.
2. To install 2 receivers in a rack, first connect the two receivers to one another at the bottom using the connecting joint. Mount one rack bracket on the left side of one unit and one rack bracket on the right side of the other unit. Now, both ULR2000s can be installed in a rack.

 **To assure good reception, if possible, install the ULR2000 as high in a rack as possible, so that the antennae protrude above the upper edge of the rack.**

The ULR2000 requires one height unit (1 HE) for installation in a 19-inch rack. Please assure that there are additional 10 cm (4 inches) of free space in the back for connecting cables.

GB

For installation in a rack, use M6 machine screws and nuts.

Be sure that there is plenty of space around the unit for cooling and, to avoid overheating, please do not place the ULR2000 on top of power amplifiers or other heat-emitting equipment.

If you wish to install more than 2 units in a rack, please make sure that there is enough space between them (fig. 5.1). The lower unit's antennae may not perturb against the upper unit's antennae. Otherwise, they could interfere with one another, causing a decrease in reception quality.

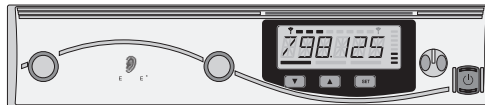



Please ensure that only qualified personnel install and operate the ULM2000. During installation and operation, the user must be sufficiently grounded. Electrostatic charges might affect the operation of the unit.

6. SPECIFICATIONS

6.1 ULR2000 receiver

RF characteristics

Receiver principle	True Diversity
Modulation	wideband FM
Frequency range	794 - 810 MHz
Receiving frequencies (for EU/US/CA)	320 frequencies, between 798.1 - 805.9 MHz, adjustable in 25-kHz increments
Channels	8, freely programmable and switchable
Channel bandwidth	< 200 kHz
Channel spacing (min.)	400 kHz
Nominal/peak deviation	± 32 kHz / ± 48 kHz
Frequency stability	< ± 15 ppm
Sensitivity (with compander)	< 2.0 μ V for 47 dB (A) _{eff} SNR
Antenna inputs	2 BNC connectors
Antenna input impedance	50 Ω
Range	100 m (nominal), coupled with the ULM2000 transmitter under optimal environmental conditions



AF characteristics (coupled to ULM2000)

Noise reduction	high-performance IRC compander system, Pre-/Deemphase
AF frequency response	30 - 19000 Hz (-3dB)
THD (at nom. deviation and 1kHz _{NF})	0.4 %
SNR (at peak deviation)	> 105 dB (A)
Noise limiter switching threshold	0 - 125 μ V, adjustable
Output voltage (at nom./peak deviation, 1kHz _{NF})	9.5 dBu / 12.5 dBu balanced @ XLR and jack connector
Output voltage level adjustment	0 - 40 dB
Temperature range	14°F - 122°F (-10°C to +50°C)

In compliance with

ETS 300 445, ETS 300 422, FCC

Power supply

Adapter	12 V DC adapter, model: E-SPS1
Mains voltage	100 - 240 V~, 50 - 60 Hz
Rated Current	250 mA

Dimensions/Weight

Dimensions (W x H x D)	approx. 8 1/3" x 1 3/4" x 4 7/8" (211 mm x 44 mm x 124 mm)
Weight	approx. 1.3 lbs (0.650 kg)

ULTRALINK UL2000M

6.2 ULM2000 microphone

RF characteristics

Modulation	wideband FM
Frequency range	794 - 810 MHz
Transmission frequencies (for EU/US/CA)	320 frequencies, between 798.1 - 805.9 MHz, adjustable in 25-kHz increments
Channels	8, freely programmable and switchable
Channel bandwidth	< 200 kHz
Channel spacing (min.)	400 kHz
Nominal/peak deviation	± 32 kHz / ± 48 kHz
Frequency stability	< ± 15 ppm
Antenna	integrated
Range	100 m (nominal), coupled with the ULR2000 receiver under optimal environmental conditions



AF characteristics (coupled to ULR2000)

Noise reduction	high-performance compander system, Pre-/Deemphase
RF system AF frequency response	30 - 19000 Hz (-3dB)
THD (at nom. deviation and 1kHz _{NF})	< 0.4 %
SNR (at peak deviation)	> 105 dB (A)

Microphone

Type	Panasonic® back electret condenser with FET impedance converter
Pickup pattern	Unidirectional (cardioid)
Sensitivity	-47 dB (0 dB = 1 V/Pa, 1 kHz)
Frequency response curve	100 - 18000 Hz
Max. input sound pressure	> 120 dB SPL
SNR	> 60 dB
Temperature range	14°F - 122°F (-10°C to +50°C)

In compliance with

ETS 300 445, ETS 300 422, FCC

Power supply

Power consumption	2 x 9 V alkaline cell (IEC 6LR61-PP3)
Standby current	typ. 75 mA
Operating time	typ. 31 mA
	> 12 hours

Dimensions/Weight

Dimensions (W x H x D)	approx. 1 7/8" x 10" x 1 7/8" (48 mm x 254 mm x 48 mm)
Weight	approx. 0.5 lbs (0.250 kg)

BEHRINGER makes every effort to ensure the highest standards of quality. Necessary modifications are carried out without notice. Thus, the specifications and design of the device may differ from the information given in this manual.

Technical specifications and appearance subject to change without notice. The information contained herein is correct at the time of printing. The names of companies, institutions or publications pictured or mentioned and their respective logos are registered trademarks of their respective owners. Their use neither constitutes a claim of the trademarks by BEHRINGER nor affiliation of the trademark owners with BEHRINGER. BEHRINGER accepts no liability for any loss which may be suffered by any person who relies either wholly or in part upon any description, photograph or statement contained herein. Colors and specification may vary slightly from product. Products are sold through our authorised dealers only. Distributors and dealers are not agents of BEHRINGER and have absolutely no authority to bind BEHRINGER by any express or implied undertaking or representation. No part of this manual may be reproduced or transmitted in any form or by any means, electronic or mechanical, including photocopying and recording of any kind, for any purpose, without the express written permission of BEHRINGER International GmbH. BEHRINGER® is a registered trademark.

ALL RIGHTS RESERVED. © 2006 BEHRINGER International GmbH,
Hanns-Martin-Schleyer-Str. 36-38, 47877 Willich-Münchheide II, Germany.
Tel. +49 2154 9206 0, Fax +49 2154 9206 4903

**FEDERAL COMMUNICATIONS COMMISSION
COMPLIANCE INFORMATION**



Responsible party name: BEHRINGER USA, Inc.
Address: 18912 North Creek Parkway, Suite 200
Bothell, WA 98011, USA
Phone/Fax No.: Phone: +1 425 672 0816,
Fax: +1 425 673 7647



hereby declares that the product

ULR2000

complies with the FCC rules as mentioned in the following paragraph:

This equipment has been tested and found to comply with the limits for a Class B digital device, pursuant to part 15 of the FCC Rules. These limits are designed to provide reasonable protection against harmful interference in a residential installation. This equipment generates, uses and can radiate radio frequency energy and, if not installed and used in accordance with the instructions, may cause harmful interference to radio communications. However, there is no guarantee that interference will not occur in a particular installation. If this equipment does cause harmful interference to radio or television reception, which can be determined by turning the equipment off and on, the user is encouraged to try to correct the interference by one or more of the following measures:

- ▲ Reorient or relocate the receiving antenna.
- ▲ Increase the separation between the equipment and receiver.
- ▲ Connect the equipment into an outlet on a circuit different from that to which the receiver is connected.
- ▲ Consult the dealer or an experienced radio/TV technician for help.

Operation is subject to the following two conditions:

- (1) this device may not cause harmful interference, and
- (2) this device must accept any interference received, including interference that may cause undesired operation.

Notice:

Changes or modifications made to this equipment not expressly approved by BEHRINGER International GmbH may void the FCC/ IC authorization to operate this equipment.

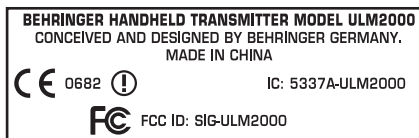

Operation of this device is subject to the following two conditions:

- (1) this device may not cause interference, and
- (2) this device must accept any interference, including interference that may cause undesired operation of the device.

Notice:

Changes or modifications made to this equipment not expressly approved by BEHRINGER International GmbH may void the FCC/ IC authorization to operate this equipment.

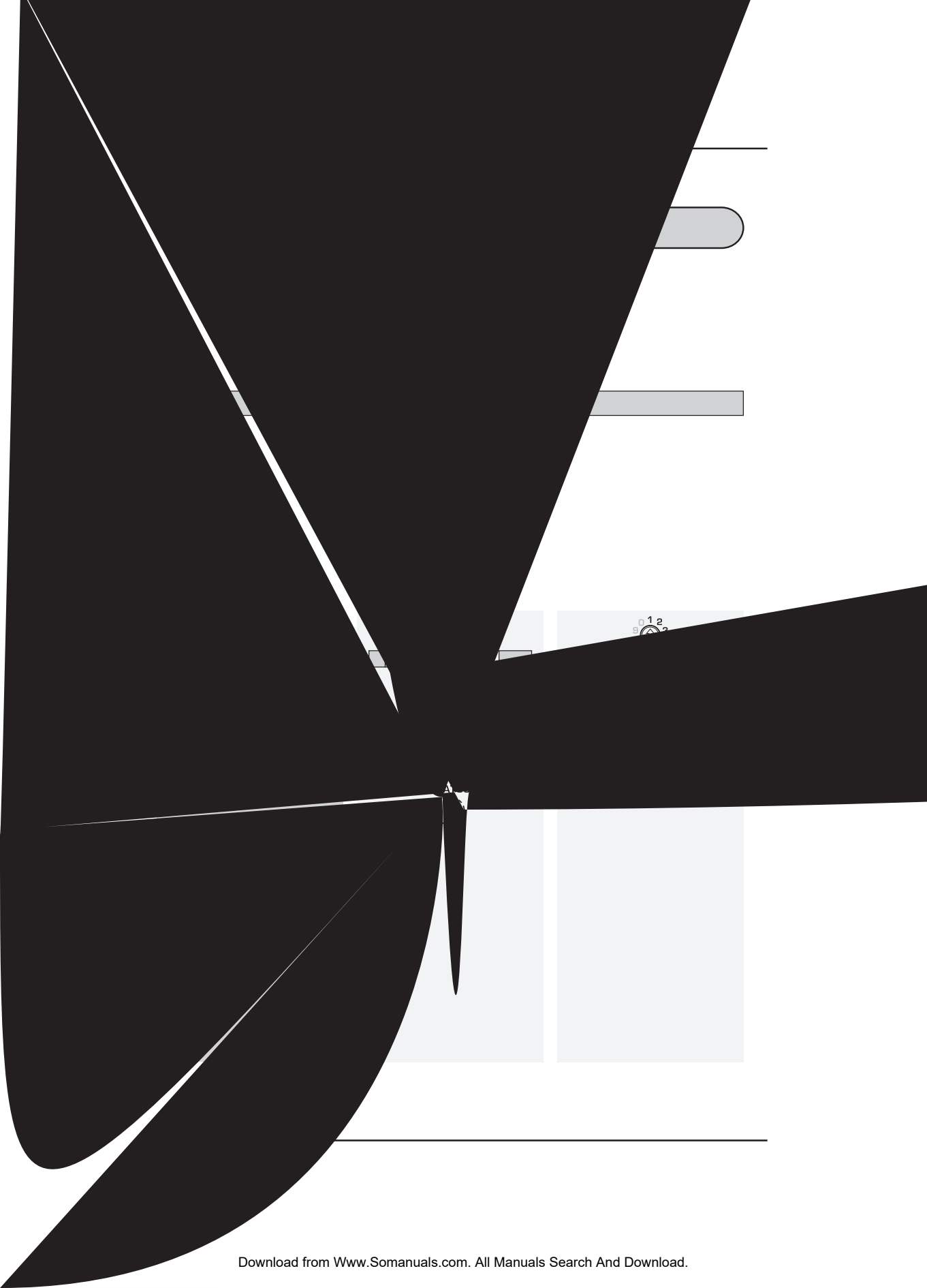

Free Manuals Download Website

<http://myh66.com>

<http://usermanuals.us>

<http://www.somanuals.com>

<http://www.4manuals.cc>

<http://www.manual-lib.com>

<http://www.404manual.com>

<http://www.luxmanual.com>

<http://aubethermostatmanual.com>

Golf course search by state

<http://golfingnear.com>

Email search by domain

<http://emailbydomain.com>

Auto manuals search

<http://auto.somanuals.com>

TV manuals search

<http://tv.somanuals.com>