

LARGE-DIAPHRAGM STUDIO CONDENSER MICROPHONE C-3

User's Manual

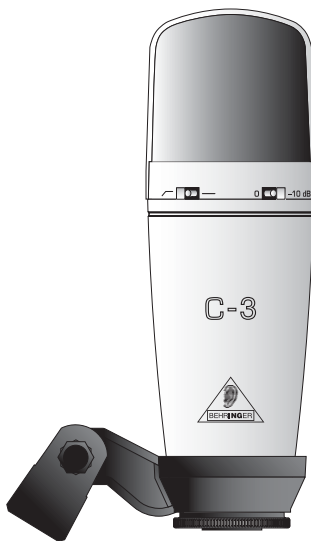

Version 1.0 March 2006



www.behringer.com



1. SAFETY PRECAUTIONS

Please read all safety precautions and operating instructions before attempting to operate the unit. Keep all safety precautions and operating instructions for future reference.

Water and moisture:

Condenser microphones are extremely moisture-sensitive. Never use your microphone in close proximity to water (e.g. bath tubs, wash basins, sinks, washing machines, pools, etc.).

Power supply:

Always use the power supply specified in the operating instructions.

Damage:

Take care not to drop your microphone as this can lead to severe damage. BEHRINGER assumes no liability for any damage caused by the user.

Service and care:

After each use, wipe the microphone down with a soft cloth and place it back into its protective casing (included with the microphone).

Caution:

Never dismount the screen holding the capsule, as this can damage the microphone! Never try to modify the printed circuit board inside your C-3! This can lead to microphone damage that cannot be repaired. Any such attempt will void the warranty.

2. POWER SUPPLY

Your condenser mic C-3 needs a phantom power supply (+48 V). If your C-3 is connected to a microphone preamp and supplied with phantom power, the LED on the microphone lights up. BEHRINGER assumes no liability for any damage caused by a defective phantom power supply. Always mute the sound reinforcement system before you switch on the phantom power supply.

3. DIRECTIVITY

Your C-3 is a large-diaphragm microphone featuring a double membrane. This allows you to choose between three different pickup patterns - cardioid, omnidirectional and figure eight. Make your selection using the switch located at the back of your microphone.

3.1 Cardioid

Microphones with this polar pattern (switch position: middle, ) are most sensitive to sound coming from in front of the microphone, and also to a lesser extent from the sides. Sound coming from behind the microphone will be greatly attenuated. This makes the cardioid polar pattern most suitable for recording individual instruments or vocals within a group.

3.2 Figure Eight

Microphones featuring the figure eight polar pattern (switch position: left, ) are most sensitive to sound coming from either directly in front of or directly behind the microphone. Sound coming from either side or above / below is greatly attenuated. This polar pattern is perfectly suited as a reporter mic for two speakers. This pattern can also allow you to create a natural reverb or delay effect. This is achieved by placing the microphone between the sound source and a wall. The direct sound reaches the „front“ membrane first, the reflected sound reaches the „rear“ membrane a short time later. You can adjust the delay / reverb time by changing the distance from the mic to the wall.

3.3 Omnidirectional

If you use the C-3 with the omnidirectional polar pattern selected (switch position: right, ) , the microphone is equally susceptible to sound coming from all directions. This polar characteristic is particularly well suited to sessions in which a natural sounding recording is sought, or when several sound sources surround the C-3.

4. LOW CUT-FILTER AND SIGNAL LEVEL ATTENUATION

The low cut filter is activated via the left switch located at the front of your C-3 (switch position: left, ) . Disruptive, low-frequency sounds such as subsonic noise, snapping and wind sounds can be filtered out. When the low cut filter is active, when recording a voice from a close distance, you get an almost entirely linear frequency response.

The switch located on the front right side of your C-3 activates the -10 dB signal level attenuation (switch position: right, -10 dB). This function is particularly recommended when recording impulse sound sources with high sound pressure (e.g. a bass drum).



5. MICROPHONE INSTALLATION

A holder is screwed onto your microphone, allowing you to attach it to mic stands with a 3/8" or 5/8" thread. An adapter has been included. First dismantle the microphone **1** from the stand mount adapter **2** by detaching the fine-thread shoulder screw **3** at the bottom end of the microphone. Fasten the adapter onto the microphone stand, place the microphone into it and tighten the screw again.

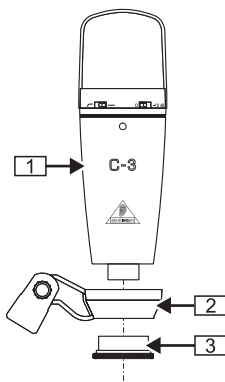

Fig. 5.1: Attaching the microphone stand

Basically, the microphone in the stand mount adapter should stand upright and face the sound source at a right angle. The angle of the microphone to the sound source influences the sound of the recording; therefore, experiment with different positions until you achieve the desired sound. To this end, you can rotate the mic in the stand mount adapter by loosening the screw somewhat and tightening it again.

If necessary, you can bend the microphone out of its vertical position by using the hinge on the microphone stand.



Please make sure to handle the microphone shaft with attention and care to avoid damaging the screw thread. In no situation should you ever apply excessive force.

Of course, you can detach the C-3 from the stand mount adapter and attach it to a commercially available suspension mount.

6. AUDIO CONNECTION

Use a balanced XLR microphone cable with the following pin assignment: pin 1 = shielding; pin 2 = +; pin 3 = -. Since your C-3 features gold-plated contact points throughout, we recommend that you use only microphone cables with gold-plated connectors.

7. LEVEL SETTING/ADJUSTING THE BASIC SOUND

Adjust the gain control in the microphone channel of your mixing console so that the peak LED lights up only occasionally or never at all. The EQ controls in the microphone channel should be set to mid-travel position to start with; low cut filter and signal level attenuation should be switched off. To get the sound you want, try changing the mic position relative to the sound source or even move the microphone around in the recording room of your studio. Adjusting the angle at which walls face the sound source can also be helpful. Only when the desired basic sound has been achieved, should you start to use equalizers and signal processors, if any at all (remember: less is often more!)



Due to the extremely linear frequency response and the high sonic resolution of your C-3, there is no need for high-frequency "EQing" that can heavily influence the signal and unnecessarily increase the noise level. The C-3 provides that much-desired transparency which often gets lost during recording and mixing.

8. WARRANTY

 **The currently applicable warranty conditions can be found on our website at <http://www.behringer.com>; alternatively via fax +49 2154 9206 4199 or telephone +49 2154 9206 4166.**

9. SPECIFICATIONS

Transducer type:	condenser, 16 mm
Polar pattern:	cardioid, figure 8, omni
Connection:	gold-plated balanced XLR connector
Open circuit sensitivity:	-40 dBV/pa (10 mV/pa)
Frequency response:	40 Hz - 18 kHz
Max. SPL ($\leq 0,5\%$ THD @ 1 kHz):	142 dB
Equivalent noise level:	23 dBA (IEC 651)
Dynamic range:	119 dB
Rated Impedance	350 Ω
Supply voltage:	+48 V
Supply current:	7.0 mA
Dimensions:	\varnothing shaft: 54 mm, length: 180 mm
Weight:	approx. 0.45 kg

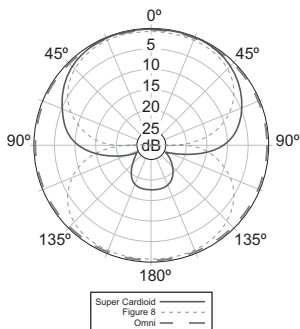

Polar pattern

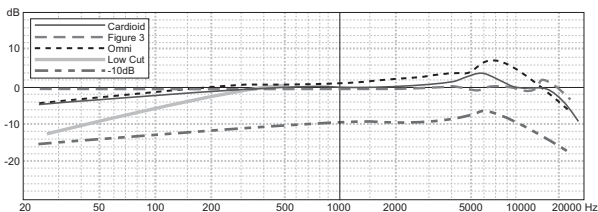

Frequency response

BEHRINGER is constantly striving to maintain the highest professional standards. As a result of these efforts, modifications may be made from time to time to existing products without prior notice. Specifications and appearance may differ from those listed or illustrated.

Technical specifications and appearance subject to change without notice. The information contained herein is correct at the time of printing. The names of companies, institutions or publications pictured or mentioned and their respective logos are registered trademarks of their respective owners. Their use neither constitutes a claim of the trademarks by BEHRINGER® nor affiliation of the trademark owners with BEHRINGER®. BEHRINGER® accepts no liability for any loss which may be suffered by any person who relies either wholly or in part upon any description, photograph or statement contained herein. Colours and specification may vary slightly from product. Products are sold through our authorised dealers only. Distributors and dealers are not agents of BEHRINGER® and have absolutely no authority to bind BEHRINGER® by any express or implied undertaking or representation. No part of this manual may be reproduced or transmitted in any form or by any means, electronic or mechanical, including photocopying and recording of any kind, for any purpose, without the express written permission of BEHRINGER Spezielle Studioteknik GmbH. BEHRINGER® is a registered trademark.

ALL RIGHTS RESERVED. © 2006
BEHRINGER Spezielle Studioteknik GmbH,
Hanns-Martin-Schleyer-Str. 36-38,
47877 Willich-Münchheide II, Germany.
Tel. +49 2154 9206 0, Fax +49 2154 9206 4903

Free Manuals Download Website

<http://myh66.com>

<http://usermanuals.us>

<http://www.somanuals.com>

<http://www.4manuals.cc>

<http://www.manual-lib.com>

<http://www.404manual.com>

<http://www.luxmanual.com>

<http://aubethermostatmanual.com>

Golf course search by state

<http://golfingnear.com>

Email search by domain

<http://emailbydomain.com>

Auto manuals search

<http://auto.somanuals.com>

TV manuals search

<http://tv.somanuals.com>