

MX2442A

EURODESK®

User's Manual

Version 1.1 May 2002

ENGLISH

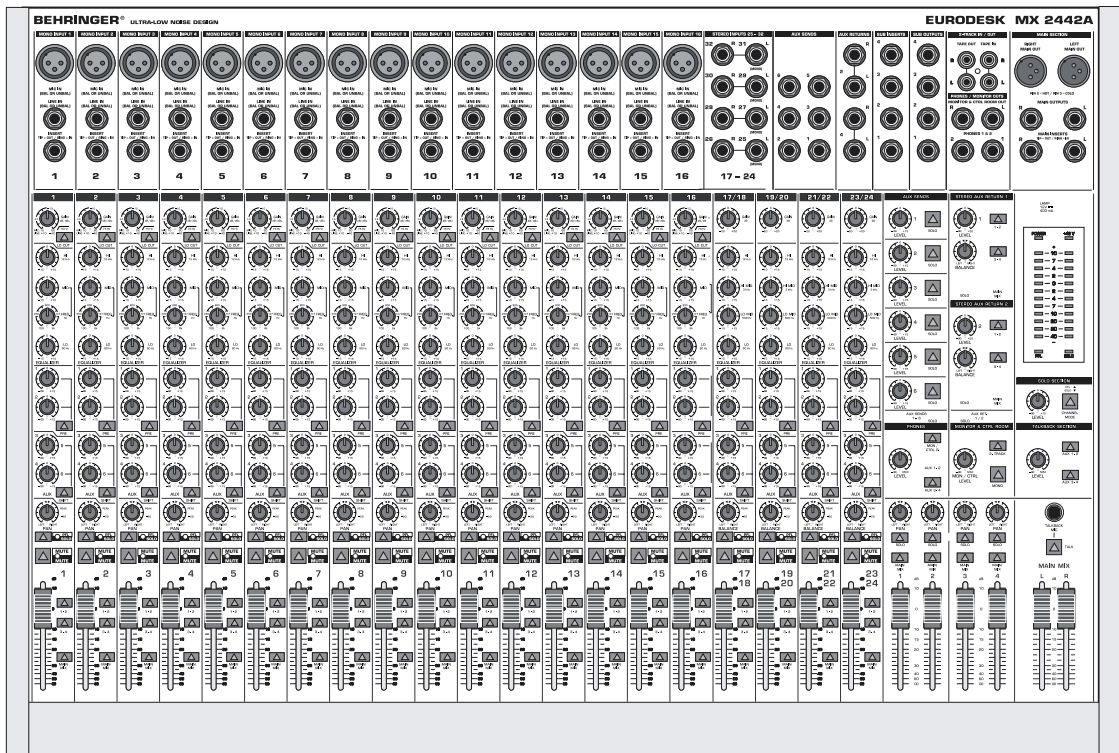

www.behringer.com

SAFETY INSTRUCTIONS

CAUTION: To reduce the risk of electrical shock, do not remove the cover (or back). No user serviceable parts inside; refer servicing to qualified personnel.



WARNING: To reduce the risk of fire or electrical shock, do not expose this appliance to rain or moisture.



This symbol, wherever it appears, alerts you to the presence of uninsulated dangerous voltage inside the enclosure - voltage that may be sufficient to constitute a risk of shock.



This symbol, wherever it appears, alerts you to important operating and maintenance instructions in the accompanying literature. Read the manual.

DETAILED SAFETY INSTRUCTIONS:

All the safety and operation instructions should be read before the appliance is operated.

Retain Instructions:

The safety and operating instructions should be retained for future reference.

Heed Warnings:

All warnings on the appliance and in the operating instructions should be adhered to.

Follow instructions:

All operation and user instructions should be followed.

Water and Moisture:

The appliance should not be used near water (e.g. near a bathtub, washbowl, kitchen sink, laundry tub, in a wet basement, or near a swimming pool etc.).

Ventilation:

The appliance should be situated so that its location or position does not interfere with its proper ventilation. For example, the appliance should not be situated on a bed, sofa rug, or similar surface that may block the ventilation openings, or placed in a built-in installation, such as a bookcase or cabinet that may impede the flow of air through the ventilation openings.

Heat:

The appliance should be situated away from heat sources such as radiators, heat registers, stoves, or other appliance (including amplifiers) that produce heat.

Power Source:

The appliance should be connected to a power supply only of the type described in the operating instructions or as marked on the appliance.

Grounding or Polarization:

Precautions should be taken so that the grounding or polarization means of an appliance is not defeated.

Power-Cord Protection:

Power supply cords should be routed so that they are not likely to be walked on or pinched by items placed upon or against them, paying particular attention to cords and plugs, convenience receptacles and the point where they exit from the appliance.

Cleaning:

The appliance should be cleaned only as recommended by the manufacturer.

Non-use Periods:

The power cord of the appliance should be unplugged from the outlet when left unused for a long period of time.

Object and Liquid Entry:

Care should be taken so that objects do not fall and liquids are not spilled into the enclosure through openings.

Damage Requiring Service:

The appliance should be serviced by qualified service personnel when:

- The power supply cord or the plug has been damaged; or
- Objects have fallen, or liquid has been spilled into the appliance; or
- The appliance has been exposed to rain; or
- The appliance does not appear to operate normally or exhibits a marked change in performance; or
- The appliance has been dropped, or the enclosure damaged.

Servicing:

The user should not attempt to service the appliance beyond that is described in the Operating Instructions. All other servicing should be referred to qualified service personnel.

FOREWORD

Dear Customer,

Welcome to the team of EURODESK users and thank you very much for expressing your confidence in BEHRINGER products by purchasing the MX2442A.

It is one of my most pleasant tasks to write this letter to you, because it is the culmination of many months of hard work delivered by our engineering team to reach a very ambitious goal: creating an outstanding device that will become a standard tool used by studios and PA companies. The task to design the MX2442A certainly meant a great deal of responsibility, which we assumed by focusing on you, the discerning user and musician. It also meant a lot of work and night shifts to accomplish this goal. But it was fun, too. Developing a product usually brings a lot of people together, and it really is a great feeling when everybody who participated in such a project can be proud of what we've achieved!

It is our philosophy to share our joy with you, because you are the most important member of the BEHRINGER family. With your highly competent suggestions for new products you've greatly contributed to shaping our company and making it successful. In return, we guarantee you uncompromising quality (manufactured under ISO9000 certified management system) as well as excellent technical and audio properties at an extremely affordable price. All of this will enable you to fully unfold your creativity without being hampered by budget constraints.

We are often asked how we are able to produce such high-grade devices at such unbelievably low prices. The answer is quite simple: it's you, our customers! Many satisfied customers means large sales volumes enabling us to get better conditions of purchase for components, etc. Isn't it only fair to pass this benefit back to you? Because we know that your success is our success, too!

I would like to thank all people whose help on "Project MX2442A" has made it all possible. Everybody has made very personal contributions, starting from the designers of the unit via the many staff members in our company to you, the user of BEHRINGER products.

My friends, it's been worth the trouble!

Thank you very much,

A handwritten signature in black ink, consisting of a stylized 'U' followed by a flourish and a horizontal line extending to the right.

Uli Behringer

EURODESK®

Professional, ultra low-noise design 24-channel 4-bus recording & live-mixing console

- ▲ 24 microphone/line inputs, 16 mono and 4 stereo
- ▲ Ultra low-noise, discrete microphone preamps with +48 V phantom power and switchable low-cut filter
- ▲ 24 balanced line inputs and 16 balanced XLR microphone inputs with gold-plated contact surface
- ▲ 4 subgroups equipped with independent pan pots, separate soloing, main mix switches and individual insert sockets
- ▲ 6 master aux sends with gain control and soloing function
- ▲ 2 multi-functional stereo aux returns featuring individual level and pan controls, solo and routing switches
- ▲ Ultra-musical original EURODESK 4-band EQ (stereo channels) and 3-band EQ with semi-parametric mids (mono channels)
- ▲ 2 pre/post fader switchable aux sends and 4 permanent post fader located aux sends for maximum flexibility of monitoring functions and effects routing
- ▲ Insert facility on all mono channels, subgroups and the main mix
- ▲ Clear and easy comprehensible design as split console, input and main sections divided
- ▲ State of the art 4580 ICs and high-quality components guarantee crystal-clear audio performance and excellent noise figures
- ▲ RCA sockets for 2-track recorders (input and output), input assignable to main mix or monitor section
- ▲ Extremely high headroom—offering more dynamic range
- ▲ External power supply design provides endless power resources, superior transient response and noise-free audio
- ▲ Balanced inputs and main mix outputs for highest possible signal quality
- ▲ LED indicators for Mute, Solo-In-Place and Pre-Fader-Listen functions
- ▲ Individual outputs for main mix, control room and headphones
- ▲ Extremely versatile headphones and talkback section
- ▲ High-precision, 8-digit LED metering device for input channels, main mix and subgroups
- ▲ Highest quality faders for main mix, channels and subgroups as well as sealed potentiometers
- ▲ BNC connector for 12 V gooseneck lights
- ▲ Extremely rugged construction ensures long life even under the most demanding conditions
- ▲ Manufactured under ISO9000 certified management system

TABLE OF CONTENTS

1. THE MANUAL	6
1.1 Nomenclature	6
1.2 Structure	6
1.3 The Separate View Sheet	6
2. EURODESK OVERVIEW	6
2.1 Architecture	6
2.2 Metering	7
2.3 Power Supply Unit (PSU)	8
3. MONO INPUT CHANNELS	8
3.1 Input Level Setting	8
3.2 Equalizer	9
3.3 Aux Sends	9
3.4 Routing & Muting	9
4. STEREO INPUT CHANNELS	10
4.1 Input Level Setting	10
4.2 Equalizer	10
4.3 Aux Sends	10
4.4 Routing & Muting	10
5. SUBGROUPS AND INSERTS	11
5.1 Subgroups	11
5.2 Insert Points	11
6. MAIN SECTION	13
6.1 Aux Masters	13
6.2 Monitoring	14
6.3 Headphones	14
6.4 SOLO/PFL	14
6.5 2-Track In- and Output	14
6.6 Talkback	15
7. CONNECTIONS	15
7.1 EURODESK MX2442A Back Panel/Serial Number	15
7.2 EURODESK MX2442A Patchfield and Plug Wiring Scheme	16
7.3 Audio Connections	16
8. SETTING UP	18
8.1 Selecting Inputs	18
8.2 Initializing Channels for Gain Setting	18
8.3 Auditioning a Signal and Setting Up a Channel	18
8.4 Desk Normalization	19
9. MIXING TOPICS	19
9.1 Equalization	19
9.2 Gain Optimization	20
10. MODIFICATIONS	21
11. SPECIFICATIONS	22
12. WARRANTY	23

1. THE MANUAL

Thank you for expressing your confidence in us by purchasing the EURODESK MX2442A. Our first task in writing this manual is to make you feel comfortable with the special terms that are used to describe your EURODESK MX2442A and its proper use.

 **Reading this manual will make you aware of the many possibilities the EURODESK MX2442A offers you. Please keep this manual safely for future reference.**

Your BEHRINGER MX2442A was carefully packed in the factory and the packaging was designed to protect the unit from rough handling. Nevertheless, we recommend that you carefully examine the packaging and its contents for any signs of physical damage, which may have occurred during transit.

 **If the unit is damaged, please do not return it to BEHRINGER, but notify your dealer and the shipping company immediately, otherwise claims for damage or replacement may not be granted. Shipping claims must be made by the consignee.**

1.1 Nomenclature

Most specialist subjects are not really all that difficult provided you understand the language used, and the vocabulary of mixing is pretty straight-forward. Nevertheless, it should be clear what certain terms mean. A "slot" in a recorder will always be referred to as a track, while that in a mixer will invariably be a channel. A group will always refer to a sub-mix of channels. Similarly the term "band" will be mentioned only in conjunction with frequency.

1.2 Structure

Working with complex systems like live or studio mixing consoles, it is impossible to deal with all the features and possibilities at the same time. Therefore, we have divided the EURODESK manual into separate chapters to make it easier to find any kind of information and tips. Sometimes you will find cross references where subjects overlap.

You will, for example, find information about channel EQs in chapters 3.2 and 4.2 while the general use of equalizers has, according to its importance, its own chapter.

1.3 The Separate View Sheet

On a separate sheet you will find drawings showing the front, the connector panel and the rear panel of your EURODESK. The block diagram is shown, too. Always keep this sheet available while studying this manual.

All EURODESK functions will be numbered consistently throughout the manual, whether they be in the text or in an illustration.

2. EURODESK OVERVIEW

2.1 Architecture

The MX2442A is a typical split console. As such, the inputs and outputs occupy separate areas of the board. This makes it easier to visualize the signal path compared to an in-line design which uses combined input/output channels. The main section on the right hand side handles all the outputs (as well as 4 stereo aux returns and a 2-track tape input) while the input channels are located on the left.

The configuration is 24 into 4 into 2. This means that there are 24 channel inputs in total (there are 16 mono and four stereo channels), assignable to four subgroup buses (plus the main mix) which in turn may be blended into the main mix stereo output. The subgroups (configurable as stereo pairs if required) are provided for connecting to a multitrack tape recorder, or for use as a mixing aid during mix-down or during a live concert. Every channel, and both stereo aux returns can access at least one of the four existing subgroups, or the main mix directly, via comprehensive routing matrices. Four out of six aux sends can be accessed simultaneously. Every single input channel can be routed in two ways to the aux send buses: two pre- and four post-, or six post-fader, for live or studio operating environments respectively.

Input channels

The first 16 input channels are mono, with a choice of balanced mic (XLR, +48 V phantom power switchable) or line (1/4" TRS) inputs, both with exceptional gain architecture. Inputs 17/18 to 23/24 are configured as stereo input channels, accepting all line level signals.

Every channel has MUTE, SOLO/PFL and comprehensive EQ. A high-quality 60 mm fader feeds the main mix and/or subgroup buses depending on the assign switch position. A constant-power channel PAN also selects between odd and even-numbered subgroup buses.

Subgroups

For ease and flexibility, four mono subgroups with PAN and SOLO functions are provided. Each has its own individual output, and each may also be assigned to the main mix.

Aux sends

The MX2442A provides six master aux send outputs, each with separate SOLO switch.

Stereo aux returns

In the mid-upper section you will find two stereo aux returns, each of them equipped with a SOLO switch, BALANCE and LEVEL controls.

Main mix outputs/additional features

The main mix output level is being controlled via a pair of high-quality 60 mm faders. The main section also includes assignable headphones or control room outputs. The monitor (or control room) outputs are independently adjustable in level, and the integral talkback mic is routable to 4 of the 6 aux buses, i.e. all possible pre-fader (cue) sends.

A BNC connector is provided for a gooseneck lamp for those dark winter's night mixes.

Inserts

All mono channels, subgroups and the main mix have insert points for the connection of dynamics processors etc.

2.2 Metering

All input channels feature signal (-20 dB) and overload LEDs, while the L and R output has a pair of 12 digit bargraph meters. The main mix (L/R) meters also have clip LEDs (+28/22 dB: balanced/unbalanced). Alternatively, the LEDs in the main section are used to display the mono PFL, stereo SOLO or the 2-track input (in general, what you hear is what you see).

 **The master clip LEDs (+22 dBu) should never be allowed to illuminate. If they do, reduce either the main mix faders or the group(s) and/or channel fader(s), or (as a last resort) the channel input gain(s). Maybe it's time to do a round of PFL metering.**

 **In SOLO/PFL mode a 0 dB meter reading matches an internal operating level of 0 dBu (0.775 V). However, when looking at the mix, 0 dB is referenced to +4 dBu, the 2-track operating level. I.e. if only one signal is present in the main mix bus, soloing that signal will cause the meter reading to increase by +4 dB.**

2.3 Power Supply Unit (PSU)

In common with most desks of this size, the EURODESK has several hundreds of line level operational amplifiers (op-amps) inside. When being driven hard, many desks begin to show signs of stress due to power supply limitations. Not so with the EURODESK. Due to the vast power resources of its external power supply unit, the sound should stay clean and crisp and tight right up to the operating limits of the op-amps themselves.

The EURODESK's external PSU connects to the desk at the rear of the console via a multiway connector. Give an extra 1/2 U of rack space to allow air to circulate around the heatsinks employed for heat dissipation since the EURODESK PSU chucks out a massive 100 Watts.

Please note:

On the rear of your PSU you will find the mains connector / fuse holder / voltage selector. Before you connect the unit, please make sure that the displayed voltage corresponds to your mains supply.

If you intend to change the operating voltage, remove the fuse holder and twist it by 180 degrees before you re-insert it. Matching the two markers indicates the selected voltage.

Note that the **correct fuse type and rate** must be installed, corresponding to the mains voltage.

Connect the PSU to the mains power supply by the enclosed mains cable, then use the mains switch to power up your power supply unit and EURODESK.

 **Never connect or disconnect your EURODESK and power supply unit when the power supply unit is "on"! Always start connecting your MX2442A to the PSU, check if the PSU is turned "off", plug into mains and then power up the PSU and thereby your EURODESK.**

3. MONO INPUT CHANNELS

Each channel comes with a balanced line level input on 1/4" TRS jack, and an XLR mic input. Press the PHANTOM switch [2] at the back panel if required. The mic amp circuit ([6]) has an unusually wide gain range from 10 dB to 60 dB, is of extreme low-noise design, and utilizes high-current conjugate pair vintage transistor circuitry to deliver an incredibly warm and transparent sound.

When a jack is plugged into the balanced (self-unbalancing) line input, the gain structure can match any line level from +10 to -40 dBu. The crucial operating levels +4 dBu and -10 dBV are clearly and accurately legended ([6]).

3.1 Input Level Setting

The channel input level is determined by the GAIN trimpot [6]. Use SOLO/PFL [18] to accurately monitor the channel input on the left/right master output bargraph meters. This also sends the SOLO/PFL-ed signal to the left and right speakers.

 **For level setting (as opposed to localized listening) choose to use the mono PFL bus rather than the post-fader (post-channel pan) stereo solo bus (CHANNEL MODE switch [46] not depressed). SOLO/PFL never interrupts the mix at the main recording outputs. It follows that aux sends and subgroups must also be unaffected, since they contribute directly to the main mix.**

In addition to switchable SOLO/PFL metering, a couple of channel LEDs ([15] / [16]) illuminate when a signal is present (-20 dB), or if a channel is going into overload. These LEDs are particularly useful when using extreme EQ settings, or adding a dynamics processor via an insert.

You do not want the overload light to come on except very intermittently during a take or a mix. If it does light persistently, reduce the input gain (see also the essential section 8: "SETTING UP").

3.2 Equalizer

All mono input channels are fitted with a semi-parametric 3-band EQ, plus a switchable low-cut filter for eliminating unwanted subsonics. The upper [8](#) and lower [11](#) shelving controls have their frequencies fixed at 12 kHz and 80 Hz respectively. The midrange control [9](#) is semi-parametric with a peaking response Q fixed at 1 octave, sweepable from 100 Hz - 8 kHz ([10](#)). All three bands have up to 15 dB of cut and boost, with a center detent for "off". Thirdly, there is a steep high pass (low-cut) filter [7](#), slope @ 18 dB/oct, for reducing floor rumble, breath noise and popping, woolly bottom end etc.

 **The combination of shelf boost at 80 Hz together with low-cut at 75 Hz results in a peaking response, useful for adding warmth to vocals and instruments, and a firm bottom to kick drums and basses, without losing control of low-frequency speaker cones.**

3.3 Aux Sends

All six aux sends [12](#) are mono and post-EQ. Aux sends 3 - 6 are fixed post-fader while 1/2 can be configured pre-fader using the PRE switch [13](#). A SHIFT switch ([14](#)) toggles the second control pair either to aux send 3/4 or 5/6.

 **For almost all FX send purposes, you will want aux sends to be post-fader, so that when a fader level is adjusted, any reverb send from that channel follows the fader. Otherwise, when the fader is pulled down, the reverb from that channel would still be audible. For cueing purposes, aux sends will usually be set pre-fader, i.e. independent of the channel fader.**

 **Most reverbs etc. internally sum up the left and right inputs. The very few that do not may be driven in true stereo by using 2 aux sends.**

 **There is +15 dB of gain on every aux send. Such a high boost is usually only appropriate where the channel fader is set around -15 dB or lower. Here, an almost exclusively wet signal will be heard. In most consoles, such a wet mix requires the use of a pre-setting for the channel aux send, losing fader control. With the EURODESK you can have a virtually wet mix with fader control.**

Channels may be altered for pre-EQ aux sends (see section 10: "MODIFICATIONS").

3.4 Routing & Muting

Routing means selecting which bus you want a channel to address. There are three stereo buses in the EURODESK MX2442A (plus a stereo solo bus). Main mix and the subgroups are selected via the assign switches [21](#), [22](#), [23](#). SOLO/PFL have already been explained in section 3.1.

Channel PAN [17](#) positions the output of the channel in the stereo field. Its constant-power design ensures there are no level discrepancies whether a signal is hard-panned, center-stage, or somewhere in-between. Such pin-point accuracy will be a revelation if you have been working on consoles with lower quality circuits.

All stereo buses follow channel PAN. Usually, only one of the buses will be selected for a particular channel.

 **An exception to this rule is when laying down voice takes. It is often convenient to have the mic channel(s) routed to all potential take tracks simultaneously, since you are often dropping in quickly between four or more tracks. It means one less button to press each time you switch tracks.**

The level to the group and main left and right buses is ultimately determined by the channel fader [20](#). It is designed to give a smooth logarithmic taper of a type more usually associated with megabuck consoles. The low level performance particularly is far smoother than that of a "normal budget" fader.

The MUTE button [19](#), like that for SOLO [18](#) is ergonomically placed immediately above the channel fader, and has an associated LED for excellent visual status indication of this much-used feature. Engaging mute is equivalent to setting a fader level of minus infinity. Therefore, pre-fader aux sends are unaffected when applying mute.

4. STEREO INPUT CHANNELS

The stereo input channel consists of almost the same controls as the mono input channel except for the input, the EQ and the BALANCE control. For further information on the remaining controls, please refer to section 3 "MONO INPUT CHANNELS".

Every stereo channel has two line level inputs on 1/4" jacks. If only the left input is used, it will work as mono channel.

 **This feature is disabled, if the inputs and outputs of the EURODESK are wired permanently to a patchbay.**

The channel input sensitivity is variable between +/- 20 dB by adjusting GAIN [6], enabling a perfect match with all common line-level sources including multitrack tape outputs, MIDI and other electronic instruments and effects units, all of which are normally designed to operate at either -10 dBV or +4 dBu.

4.1 Input Level Setting

Input level setting works in the same ways as on mono channels (see section 3.1).

4.2 Equalizer

All stereo input channels are fitted with four-band, fixed-frequency EQ. Bands 1 and 4 are shelving, while bands 2 and 3 have a peaking response, with their Q set at 2 octaves. The upper [8] and lower [11] shelving controls have their turnover frequencies fixed at 12 kHz and 80 Hz, whereas the midrange controls [25] and [26] have their bell center frequencies set at 3 kHz and 500 Hz. All bands have up to 15 dB of cut and boost, with a center detent for "off".

 **A stereo equalizer is generally preferable to using two mono equalizers when EQ-ing a stereo signal, as often discrepancies between left and right settings can occur.**

4.3 Aux Sends

These are the same as for mono channels (see section 3.3). Please note that first the stereo signal is turned into a mono sum before entering aux send.

4.4 Routing & Muting

The only difference here from the mono channel described in 3.4 is in the substitution of the pan control by the BALANCE control ([27]).

As long as a channel is run in mono, there is no difference at all.

In stereo operation however, this control functions as a BALANCE control [27], determining the relative balance of the left and right channel signals which are being sent to the left and right main mix, or odd and even subgroup buses. For example, with the BALANCE control turned fully clockwise, only the right portion of the channel's stereo signal will be routed to the selected buses, the left portion is faded out.

5. SUBGROUPS AND INSERTS

5.1 Subgroups

The principal routes to multitrack are via the subgroup outputs. There are four mono (or two stereo) subgroups. All channels can access all of them, as can aux returns 1 and 2 ([35] & [36]). The subgroup level is determined by the SUBGROUP fader [54], while the signal level may be accurately checked by solo-ing ([51]).

Subgroup outputs can also be assigned to the main mix during mixdown by pressing the MAIN MIX switch [53], in which case stereo position in the L/R mix is determined by the subgroup's PAN pot [50].

 **Try inserting compression/de-essing/an exciter or a noise gate on grouped signals (e.g. backing vocals, drums, layered synths).**

 **Try merging a dry signal with a little wet, then compressing the sum heavily. Though the reverb proportion will be low when a signal is present, the resultant reverb tail pumped up by the compressor at the start of each silence will give the illusion that the reverb was massive at the time. (The listener will be left wondering how the singer could sound so dear in such wet acoustics!)**

5.2 Insert Points

Insert points are useful for adding dynamic processing or equalization to a channel, a group, or the mix. Unlike reverbs etc., which are usually added to the dry signal, dynamic processing is normally applied across an entire signal. Here, an aux send would be inappropriate. Instead, the signal is intercepted somewhere along the channel, fed through the dynamics processor and/or EQ, then returned to the console at the same point where it left. The insert point is normalized, i.e. the signal is only interrupted when a jack is plugged into it.

All mono input channels have got insert points, as have the subgroups and the main mix. Each insert point is accommodated on a single TRS jack socket wired tip = send, ring = return, sleeve = ground/screen. Inserts are always pre-fader, and also pre-EQ/pre-aux sends for channels.

 **The insert points may be used as pre-EQ-outputs without interrupting the signal. By switching them to a patchbay the insert points can be used in a more complex manner since the sends and returns dispose of separate inserts.**

 **If you want to insert a dynamics processor etc. into one of the stereo channels, it must be done between the source output and the EURODESK, since these channels have no bona-fide insert point.**

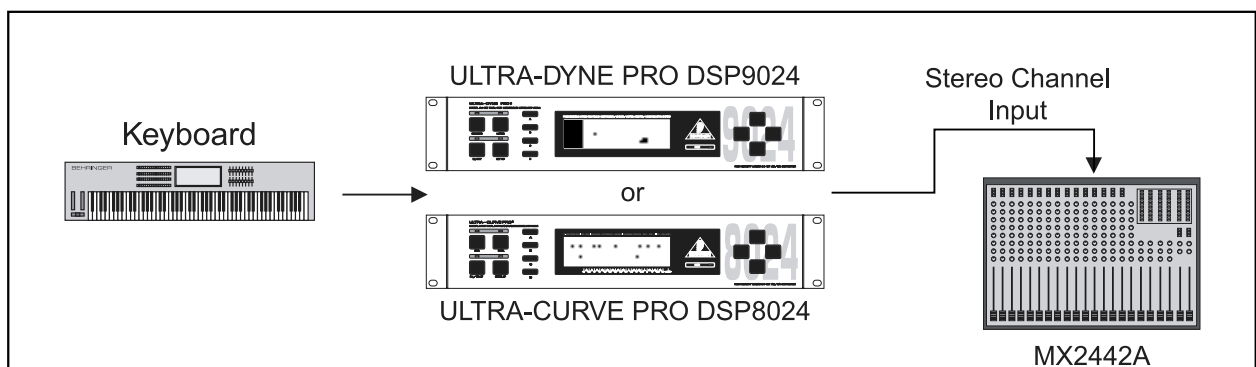

Fig. 5.1: Inserting into a stereo channel

- ☞ Please note that we didn't draw the ground/screen connection in the following graphics to keep them as simple as possible.
- ☞ If you want to insert an external EQ or dynamics processor post-EQ, a subgroup insert should be used as follows:

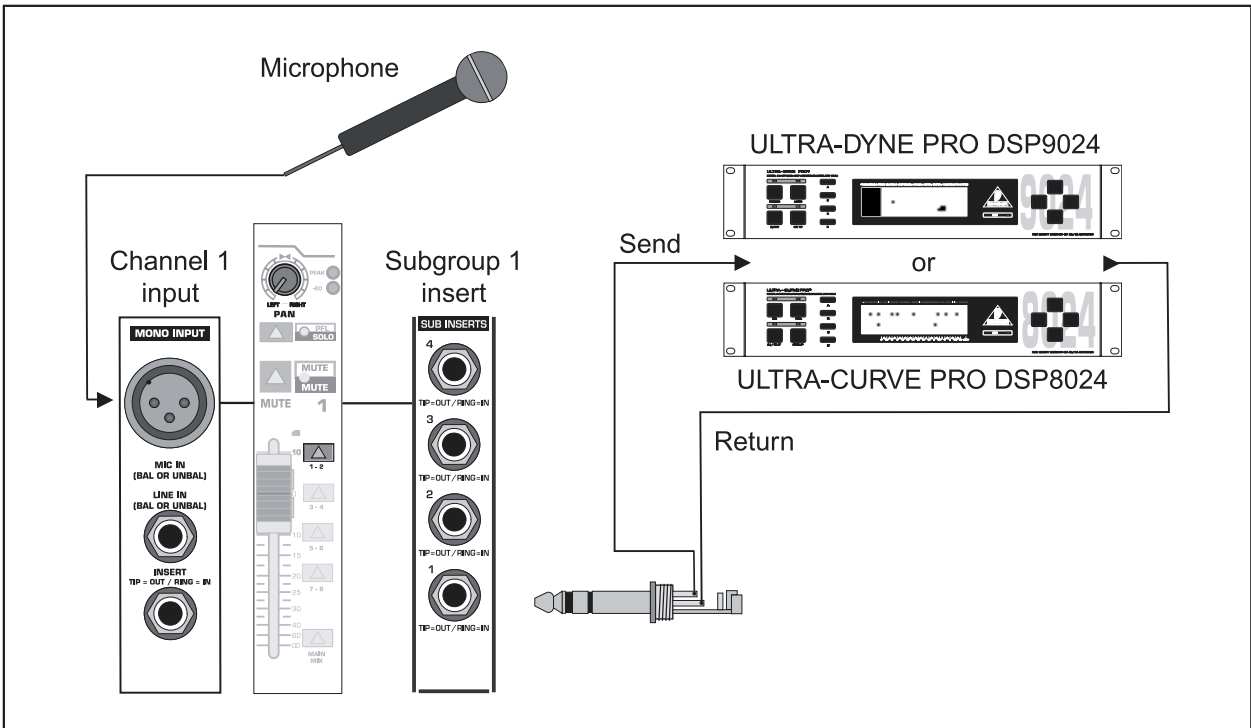

Fig. 5.2: Inserting an external EQ/dynamics processor post channel EQ

In this arrangement you might find that compression tends to soften the perceived amount of (especially treble) EQ applied. The solution here is to apply more EQ. This creates a real “pressure” sound, great for high energy music such as dance.

In the above example, any aux sends to effects should be applied before the EQ/dynamics processing takes place. If you want the aux sends to be post-processing, you will need to address the signal to one of the subgroups and then insert the EQ/dynamics processor between the corresponding subgroup output (insert send) and a channel input (insert return). You can now reclaim the channel 2 input as follows: By applying the channel's insert send you can route out an instrument's signal being plugged into the line input, treat it with an EQ/dynamics processor, and then reroute it via a subgroup (insert return) to the master section. An additional patch enables channel EQ to be placed onto a subgroup without reducing the number of line inputs available:

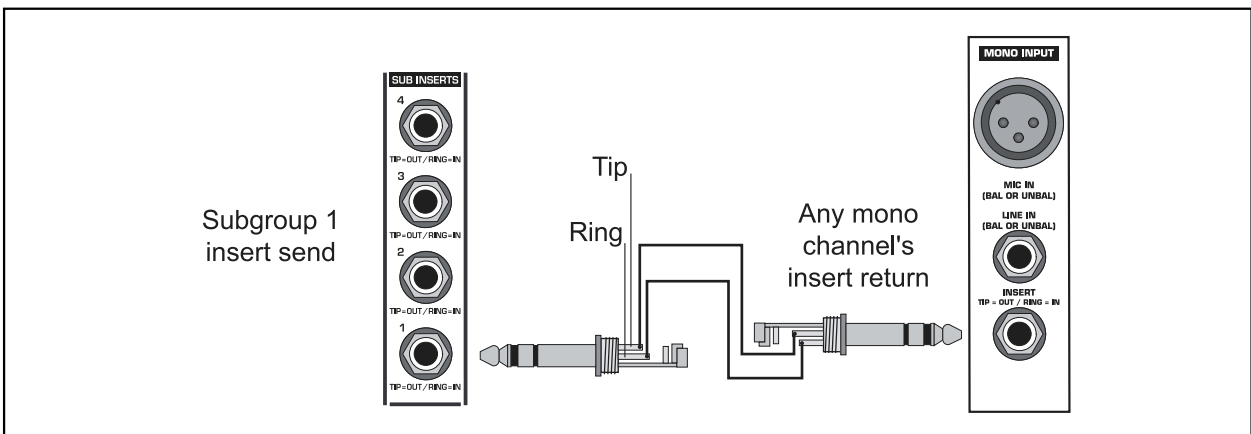



Fig. 5.3: Making use of the channel EQ for shaping subgroup signals by applying inserts

-  EURODESK insert points are, of course, simultaneously inputs and outputs. For goodness sake, get them onto a patchbay, where they can appear as independent sockets, and do away with all these fiddly Y-connectors that always seem to be the first to get knotted in the flightcase. Now it is possible to do the incredibly useful patch shown in fig. 5.3 without having to make up what would amount to a ring-to-tip, tip-to-ring stereo patch lead.
-  Insert points may also be used as pre-EQ direct outputs without interrupting the signal flow. See fig. 7.1 “Direct out connection”.

6. MAIN SECTION

6.1 Aux Masters

Aux sends

Much of the main section (situated left and below the bargraph meters) is taken up by master aux sends and returns.

Stacked in a vertical column are six master AUX SEND LEVEL pots [28], one for each bus. Each has a gain structure of $-\infty$ to +15 dB. The extra 15 dB of gain comes in once a knob passes a center detent (representing the “normal” unity gain position), enabling insensitive outboard FX to be properly driven. Each aux send has a SOLO button [29], and, as with other areas of the mixer, a local SOLO LED [30], which starts flashing when any of the aux master sends are solo-ed.

(This is to help you see exactly *what* has been solo-ed. Any experienced engineer will have had occasion to painstakingly search through *every* SOLO button on his / her console trying to find out why one of the main SOLO LEDs was flashing, while the control room monitors remained silent!)



Aux returns

On the right hand side are the stereo aux returns, which can also be seen as two additional mono or stereo line inputs. On these inputs there is up to 20 dB of gain available. Alternatively, a **mono** (center-panned) signal may be returned by plugging into the **left** aux return jack only.

-  **This feature is disabled if all line-level I/Os from the EURODESK are wired permanently to a patchbay.**

Aux returns 1 & 2

Aux returns 1 and 2 have full group routing matrices to enable returning FX to be sent to tape, plus main mix bus assignment. The functions for aux return 1 (mirrored by aux return 2) are: routing-switches [35], [36], [37], LEVEL [31], BALANCE [32] and SOLO [33]. Level controls the amount of signal being blended into the mix or a group, while balance controls the relative amounts of left and right processed signal. Be sure to have BALANCE control in center-position, if you're not actually working with it.

-  **As always, there are exceptions to the rule above. Some short stereo delay effects (say 30 ms to left, 50 ms to right) cause a psycho acoustic effect where the earlier delay seems louder. A similar effect is noticeable when harmonizing in stereo: A slight pitch shift upwards will seem louder than one that goes down. In both cases use BALANCE [32] to compensate. (An analogy comes from greece: the columns of the Parthenon in Athens are slightly bowed so as to appear straight.)**
-  **When carrying out the setup mentioned above or any other stereo imaging exercise, don't just rely on the control room monitors. Get a pair of headphones and listen in stereo and in reverse stereo, to allow for any hearing discrepancy between your ears.**

SOLO

Below the aux returns lies a local SOLO LED [34]. This flashes whenever a SOLO button in the column above is pressed.

6.2 Monitoring

Though most of you will want to audition the main mix most of the time there are exceptions. These include SOLO/PFL and 2-TRACK playback [43]. The bargraph meters follow whatever source is being auditioned (the meters won't make much sense if more than one source is selected).

 **Altering what goes into the control room monitors does not affect the signal from the main mix outputs. That offers to you the opportunity to do a quick SOLO during a mix whenever you want without having to start again!**

The MONITOR/CTRL LEVEL pot [42] sets the level to the control room monitors. This is sourced post the main mix stereo fader setting. Your fades couldn't be heard otherwise.

Don't rely on a single pair of loudspeakers to audition your mix. You'd better use a variety of different speakers.

Lastly, there is a MONO button [44], useful for checking the phase correlation and/or coherence of a stereo signal. Again, this does not affect the main mix outputs.

6.3 Headphones

The headphones may be sourced from the monitor/control room mix [39], and/or the pre/post-fader switchable aux sends 1/2 [40] and/or the post-fader aux sends 3/4 [41]. Two headphones sockets are provided on the connector panel.

The headphone mix level is controlled by a LEVEL pot [38], and the gain is sufficient to drive headphones directly. This is fine for a MIDI suite with overdub booth, but for the bigger studio's headphone network using a separate headphones distribution amplifier like the BEHRINGER POWERPLAY PRO HA4600 is recommended: This allows independent level and EQ-settings for four headphone mixes; a total of 12 headphones can be connected.

6.4 SOLO/PFL

SOLO

SOLO is short for Solo-in-Place, and is the preferred method for auditioning an isolated signal, or group of signals. Whenever a SOLO button is pressed, all unselected channels are muted in the monitors. Stereo panning is maintained. The SOLO bus is derived from the output of the channel pans, aux sends, stereo line inputs and subgroups, and is always post-fader.

PFL

Pressing the channel mode switch [46] once disengages the stereo solo bus, and replaces it with a separate mono PFL (Pre-Fader Listen) bus. Now any channel which is solo-ed, isn't. It is PFL-ed instead. PFL should always be used for gain-setting.

The channel mode (PFL or SOLO) is indicated by a pair of status LEDs (located below the bargraph meter [68]), pot [45] controls the SOLO level, which will normally be set to unity gain (center detent) to match the in-the-mix level.

6.5 2-Track In- and Output

2-track input

The 2-track input is on unbalanced RCA plugs, and is primarily made for auditioning mix playback from tape. The 2-track switch [43] routes this signal to the control room monitors.

With the MON/CTR LEVEL control [42] fully clockwise, your 2-track input will be matched to the semi-professional level -10 dBV. For higher output recording sources (e.g. +4 dBu) turn the level of [42] down.

 **The 2-track input could usefully be connected to the output of a hi-fi pre-amp or integrated amplifier, allowing you to easily audition a variety of sources (e.g. CD, phono etc.).**

2-track output

A pair of balanced XLR and jack connectors deliver the main mix output to your 2-track recorder (or PA system) at +4 dBu. Alternative RCA (-10 dBV) connectors are provided, too.

The level to tape is ultimately determined by precision faders [57]. Main mix insert points are provided for patching a gate, a compressor etc. pre-fader. This is important: Connecting a compressor or gate after the 2-track output would disrupt any attempt to acquiring a smooth fade using the output faders.

Although the 2-track output is primarily designed for recording, it can also be used as a PA feed, or as a send to the input of your sampler. In fact, up to three simultaneous destinations can be serviced without resorting to a patchbay or splitter leads—there are three separate 2-track outputs on your EURODESK!

6.6 Talkback

The built-in flush-mounted mic [55] is activated by depressing the non-latching TALK switch [56] just above the MAIN MIX faders. Engaging talkback dims the control room monitors, (not lights!) by -20 dB to avoid feedback. This does not affect the other talkback routes.

Talkback level is set by [47], and the mic can be routed to any or all of auxes 1/2 and 3/4 ([48], [49])—in other words, every possible pre-fader (cue) aux send—to enable you to talk to artists remotely through their headphones or personal stage mixes.

Sometimes you will want a much higher rejection of feedback than a flush-mounted talkback mic could ever provide. When running a live concert mix, a dynamic mic plugged into a spare channel and routed to all the pre-fader sends only will do the job.

7. CONNECTIONS

7.1 EURODESK MX2442A Back Panel/Serial Number

DC power in

This circular multiway connector distributes the different DC operating voltages delivered by the PSU: +/-18 V (audio circuits), +48 V (mic phantom power), +12 V (lamp) and +5 V (LEDs).

Phantom power switch

When using capacitor mics, +48 V DC can be switched globally on or off by [2] (also see “Mic inputs”).

 **Care should be taken NOT to plug mics into the console (or stagebox) while the phantom power [2] is on. Also mute the monitor / PA speakers when turning phantom power on or off. Allow 1 minute after powering up for the system to equilibrate before setting input gains.**

Serial number

Please complete and return the warranty card within 14 days of the date of purchase. Otherwise, you will lose your right to the extended warranty. Alternatively, you can register online at our website under www.behringer.com.

Your BEHRINGER MX2442A was carefully packed in the factory and the packaging was designed to protect the unit from rough handling. Nevertheless, we recommend that you carefully examine the packaging and its contents for any signs of physical damage, which may have occurred during transit.

 **If the unit is damaged, please do not return it to BEHRINGER, but notify your dealer and the shipping company immediately, otherwise claims for damage or replacement may not be granted. Shipping claims must be made by the consignee.**

 **Before you connect your MX2442A to the mains, please make sure that your local voltage matches the voltage required by the unit.**

 **Please note that the PSU and mixer heat up during operation. This is absolutely normal.**

7.2 EURODESK MX2442A Patchfield and Plug Wiring Scheme

Most of the inputs (inserts being the major exception) are balanced.

 **Unbalanced equipment may be connected to balanced inputs/outputs. Either use mono 1/4" jacks or connect ring and barrel of TRS jacks (or pin 1 and 3 of XLR plugs).**

Mono input channels 1 - 16

Insert points: unbalanced send and return on a single 1/4" TRS socket, wired tip = send, ring = return, sleeve = ground/screen.

Line inputs: balanced 1/4" TRS sockets, wired tip = hot (+ve), ring = cold (-ve), sleeve = ground/screen.

Mic inputs: XLR-type connectors, wired pin 1 = ground/screen, 2 = hot (+ve), 3 = cold (-ve), for balanced low-level operation.

Stereo input channels 17 - 24

Four stereo pairs. Unbalanced 1/4" TRS sockets, wired tip = hot (+ve), sleeve = ground/screen.

Aux sends

Unbalanced 1/4" TRS sockets, wired tip = hot (+ve), sleeve = ground/screen.

Stereo aux returns

Two stereo pairs on balanced 1/4" sockets, wired tip = hot (+ve), ring = cold (-ve), sleeve = ground/ screen.

Subgroup inserts

For inserting into a subgroup signal. Unbalanced send and return on a single 1/4" TRS socket, wired tip = send, ring = return, sleeve = ground/screen.

Subgroup outputs

Primarily designed for feeding a multitrack recorder. Unbalanced 1/4" TRS sockets, wired tip = hot (+ve), sleeve = ground/screen.

2-track in-/outputs

RCA sockets for use with tape recorders etc., signal = main mix. Use custom-made RCA cables for the 2-track in/out traffic (center post = signal (+ve), sleeve = ground/screen).

Monitor & control room outputs

Will feed a pair of speakers (via an amp, of course). Balanced 1/4" TRS sockets, wired tip = hot (+ve), ring = cold (-ve), sleeve = ground/screen.

Phones outputs

Will feed two headphones. 1/4" TRS socket, wired tip = left signal, ring = right signal, sleeve = ground/screen.

Main inserts

For inserting into the main mix signal. Unbalanced send and return on a single 1/4" TRS socket, wired tip = send (out), ring = return (in), sleeve = ground/screen.

Main outputs (TS sockets)

Unbalanced 1/4" TS sockets, wired tip = hot (+ve), sleeve = ground/screen.

Main outputs (XLR)

Balanced XLR, wired pin 1 ground/screen, pin 2 hot (+ve), pin 3 cold (-ve). Maximum level is +28 dBu.

7.3 Audio Connections

You will need a lot of cables for different purposes. On the next page you will find some figures to make sure you have got the right ones.

 **All outputs are ground-compensated (decoupled from the mains supply earth) to eliminate the possibility of ground loops.**

 **Please make sure that every part of your equipment is connected to the mains earth. To avoid any risk of electric shock never disconnect the mains earth from any part of your equipment!**

 **Please ensure that only qualified persons install and operate the EURODESK. During installation and operation the user must have sufficient electrical contact to earth. Electrostatic charges might affect the operation of the EURODESK!**

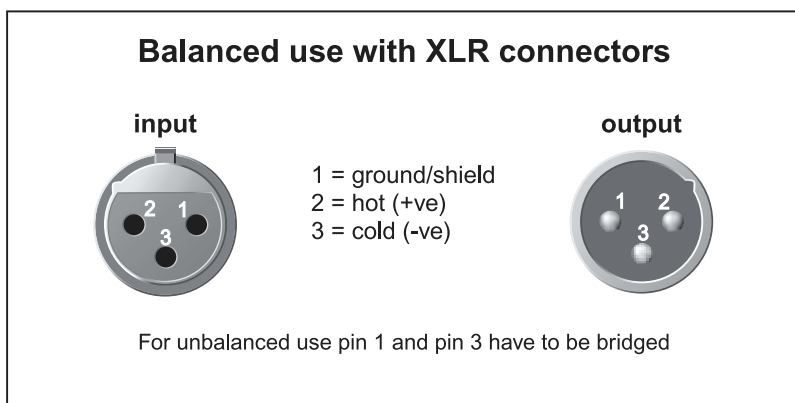
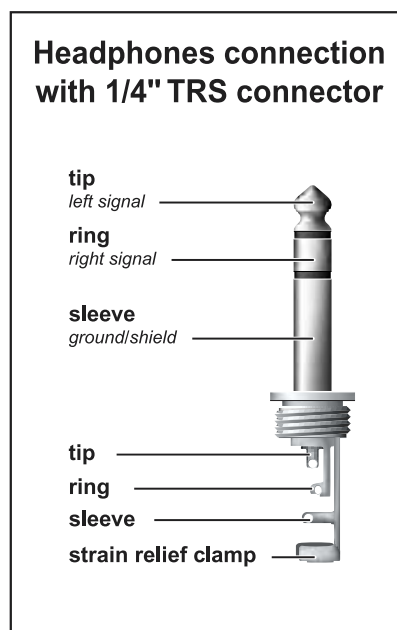
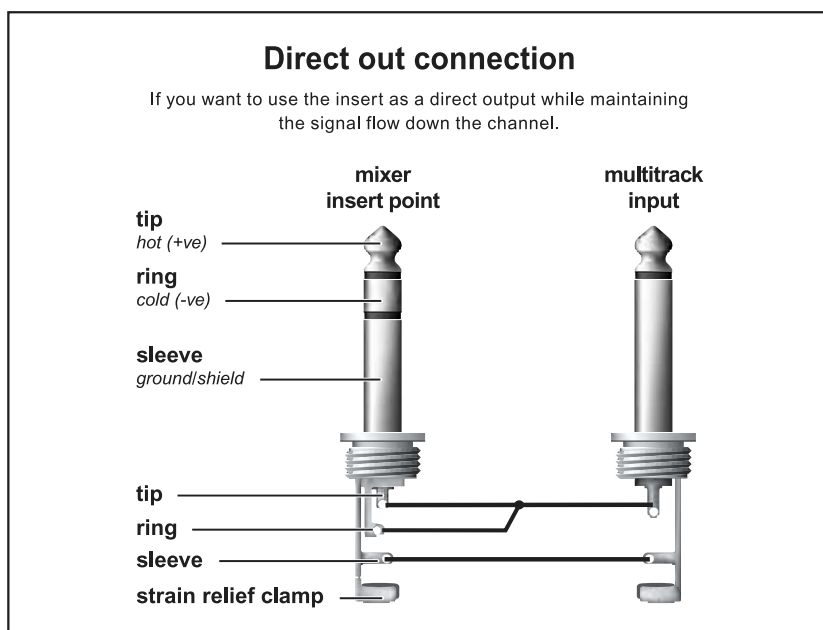
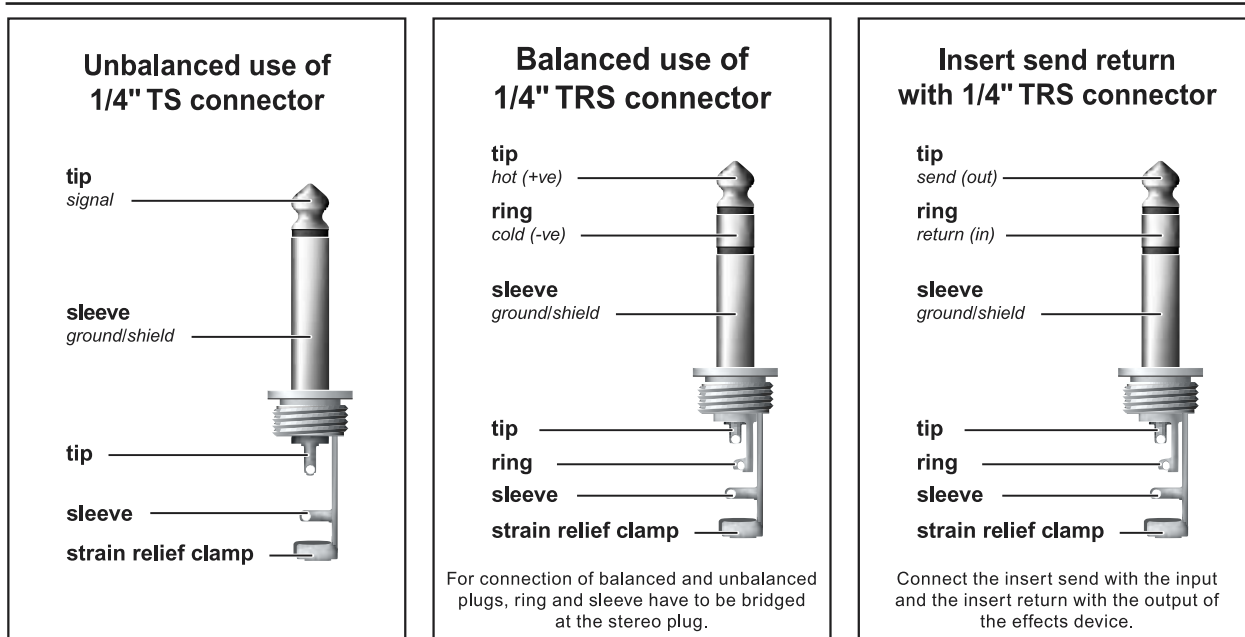



Fig. 7.1: Different plug types

8. SETTING UP

8.1 Selecting Inputs

1) Mono channels accept mic or line level inputs. If you are using the mic input, make sure nothing is connected to the line input (and vice-versa). Please note that mic inputs are many times more sensitive than line inputs!

 **Do not connect mics with phantom power switched on. NEVER ever use unbalanced mic cables with phantom power switched on! Shorting +48 V DC to earth can cause serious damage.**

2) Stereo channels accept line level signals. Any stereo channel can be run in mono simply by connecting it into the left jack socket only.

 **This feature is disabled if all line level in-/outputs from the EURODESK are wired permanently to a patchbay.**

The stereo channels are suitable for a variety of line level sources including MIDI instruments, effects outputs, and tape returns from multitrack.

3) Stereo aux inputs are primarily designed for returning effects units, though these too may be given over to multitrack returns or MIDI instrument outputs.

8.2 Initializing Channels for Gain Setting

1) Set gain to minimum and all aux sends to "off" (fully counterclockwise).

2) Set EQ to flat (all knobs at 12 o'clock).

3) Where applicable, set the LO CUT switch "on" for most mics, "off" for signals with desired low-frequency content.

4) Set CHANNEL MODE to PFL (up).

5) Depress the SOLO switch .

8.3 Auditioning a Signal and Setting Up a Channel

1) Make a typical noise, or roll the tape. There should now be some activity at the main bargraph meters , indicating the PFL level.

2) Adjust the GAIN control until transient peaks are regularly hitting +2 dB. Continuous signals should not exceed 0 dB.

3) With FX units, MIDI instruments and multitrack tape recorders (pro +4 dBu, semi-pro -10 dBV), it is important to match the operating level of the desk to that of your machine. If you are not sure which level your external equipment requires, try a 0 dB setting first. If the signal is too low, turn the GAIN pot to the right.

 **A -10 dBV nominal operating level for an effects processor almost certainly means 0 dB on the unit's input or output meter. If the FX processor has indication only for input level, ensure that the output gives comparable, i.e. "unity", gain.**

4) If EQ is adjusted at any time, repeat steps 8.3 1) & 2).

5) If an insert is used to patch in a compressor, gate, EQ etc., use the outboard processor's bypass or effect off switch to A/B monitor the effected and bypassed signals, which should be level matched. (If the unit does not have a bypass switch or equivalent, you will have to keep connecting and disconnecting the device until you achieve unity gain.)

6) SOLO switch up. Move onto next channel.

8.4 Desk Normalization

All board settings should be set to the normal default condition before or after every session. Usually faders are set to zero (minus infinity) EQs set flat, trim pots and channel aux sends turned fully anticlockwise etc. Many controls have a natural initial setting. For EQ cut and boost this is unity gain. However, some settings, such as selecting pre or post for channel aux sends, will depend on the operating environment (e.g. studio or live), or on an engineer's preferred way of working.

9. MIXING TOPICS

9.1 Equalization

Few people buying the EURODESK will need to be told how an equalizer works. But how to get the best out of it? Well, that's another story.

In the beginning EQ was an instrument for removing unwanted frequencies, or compensating for imperfect microphone response curves, or bumps in a studio acoustics. It was a corrective device. Tamla Motown turned that notion upside down in the sixties with the novel idea that you try to find for each instrument a characteristic frequency not shared by the other instruments in the mix. Then you whack up it's gain. This makes individual voices punch through a mix in a slightly unnatural but exciting way. In general, corrective EQ usually involves broadband (slope) contouring together with narrow-band notching of unwanted resonances. The narrower the notch or "Q", the less the total signal will be affected.

 **Finding bad resonances is made easier by first frequency sweeping in boost mode.**

"Motown" EQ is achieved by applying boost in a fairly broadband way. The broader the band, the more musical but less instrument-specific the effect. Applying boost over a narrow bandwidth will sound "Honky". The two semi-parametric bands of the EURODESK EQ have their Q fixed at 1, a typical and sensible value. For sounds which require drastic corrective EQ (remember no MIDI instrument should need it), it is advisable to have a couple of channels of fully comprehensive equalisation in your rack. (You can always bounce tracks through the outboard EQ, freeing up the unit for the next task). Check out our BEHRINGER ULTRA-CURVE PRO DSP8024, which promises to be another price/performance buster.

The EURODESK EQ might be applied to a signal as follows: First, trim the LF and HF shelves to achieve the required slope or "LOUDNESS". (These controls mirror the tone controls of a typical hi-fi amp.) Now use the semi-parametric mid band to boost the nicest frequency, or to cut the nastiest. Over all channels in the mix, if too many of the nicest frequencies coincide then you might have to settle for second best, in some cases. Often you might want to boost two nice frequencies. Really nasty frequencies will need notching. Time to go outboard.

 **Use the Lo Cut filter to tighten up channels in a mix: maybe remove it only for the bass, kick drum, toms, tablas, didgeridoo and other deliberate subsonics (when recording classical music ignore this advice).**

 **Combining the 75 Hz Lo Cut filter with an increase at 80 Hz will produce a bell-type EQ that has a more focused impact than simply increasing the bass.**





 **Please keep in mind that the EQ can also be used to cut frequencies.**

After each change at the EQ settings, always check and, if necessary, adjust the input gain.

9.2 Gain Optimization

PFL (Pre-Fader-Listening) is the way to set a desk level. Setting up the channel input gain is discussed in the essential sections 3 & 4. Optimum master aux send levels will be dependent on the sensitivity of the FX device being driven, but unity gain is a useful starting point. As the mix progresses, more and more channels are likely to be sending to effects via the aux buses, and it's best to PFL all sends (aux, subgroup) just before setting up for the final mix.

Outboard reverbs etc. should all be made to work hard. There's no point in having an 85 dB dynamic range if the input meter of your reverb is barely flickering. On the other hand, digital distortion is not one of the nicer noises around. Fortunately, you can SOLO the FX returns. Here, you'll have to trust your ears to detect digital distortion, since different outboard processors calibrate their meters differently, and their dynamic range is not sufficient to allow, say, 15 dB of headroom (as is the case with DAT etc.). The PFL/SOLO meter, on the other hand, looks only at the desk's analog aux input level, if you hear distortion, but the meter says you're just hitting 0 dB, then it must be coming from the aux send amp or the FX unit. If PFL on the aux send reveals nothing amiss, turn down the input on the FX unit, and turn up the desk's aux return.

-  **In most of the cases, distortion in the aux send > FX > aux return loop will come from the FX unit (FX GAIN TOO HIGH), and the same goes for a high noise level (FX GAIN TOO LOW).**
-  **Noisy FX (or synth) returns can be greatly improved by the addition of single-ended noise reduction between FX output and aux (or channel) returns. The BEHRINGER DENOISER SNR2000 is ideally suited for this purpose.**
-  **We've found that using analog single ended noise reduction can help warm the sound of certain digital reverbs which sound too cold/metallic, and also give that "Echoplex" sound to digital delay decays.**
-  **Analog multitrack tape should be driven quite hard, since its dynamic range (without noise reduction) is likely to be 20 to 30 dB worse than other elements in the recording chain. Try to record bright. You can always mix back duller. Brightening up an off-tape signal will bring up the level of tape noise.**
-  **When mixing or recording, keep the channel fader levels around or below 0 dB. If you do find the faders creeping up or down, apply a suitable offset over all channel faders, and try to control your bad habit in future!**

10. MODIFICATIONS

The following modifications require some knowledge in soldering. Only attempt that if you are experienced in using an iron on PCBs. Otherwise, refer to qualified personnel. After modification the BEHRINGER warranty becomes discretionary.

Links should not be threaded into holes on the PCB. They should be soldered to the tinned areas around the holes, and bowed slightly upwards in between.

Aux sends 1/2 > pre-EQ

All channel aux sends are post-EQ. If you want to convert them, carry out the modification described below to each channel. The right PCB area is indicated by a yellow printing (see figures below).

- 1) Disconnect power supply.
- 2) Cut the "post" track.
- 3) Add in a "pre" link.
- 4) Repeat for all channels you want to be modified.

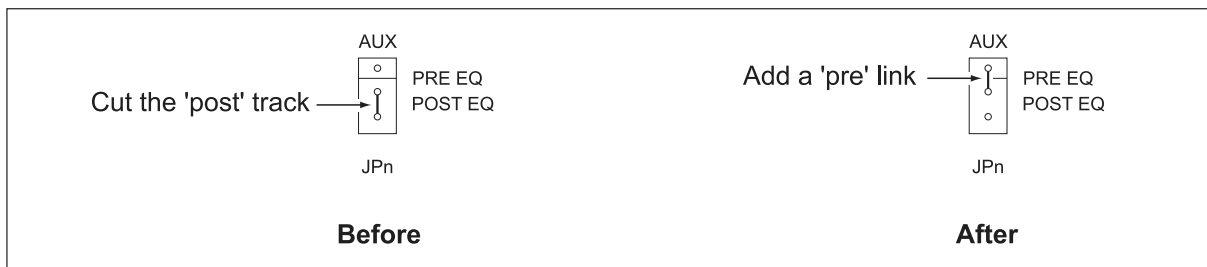

Fig. 10.1: Aux send > pre-EQ modification on mono channels

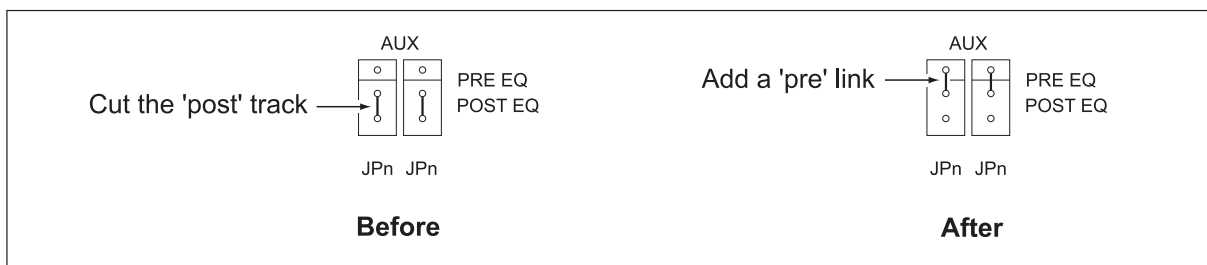

Fig. 10.2: Aux send > pre-EQ modification on stereo channels

11. SPECIFICATIONS

Input channels

Mic input	Electronically balanced, discrete input configuration
Mic E.I.N. (22 Hz - 22 kHz)	129.0 dBu, 150 Ohm source 117.3 dBqp, 150 Ohm source 132.0 dBu, input shorted 122.0 dBqp, input shorted
Distortion (THD & N)	0,007% @ +4 dBu, 1 kHz, bandwidth 80 kHz
Gain range	+10 dB to +60 dB
Max input (Mic)	+12 dBu
Line input	Electronically balanced
Gain range	Unity to +40 dB
Max input (line)	+22 dBu
Channel fader range	+10 dB to -85 dB
Aux send gain range	From "off" to "Unity" to +15 dB

Equalization

Hi shelving	12 kHz +/-15 dB, Q fixed at 2 oct.
Hi mid bell (Ch 17-24)	3 kHz +/-15 dB, Q fixed at 2 oct.
Mid sweep (Ch 1-16)	100 Hz - 8 kHz +/-15 dB, Q fixed at 1 oct.
Lo mid bell (Ch 17-24)	500 Hz +/-15 dB, Q fixed at 2 oct.
Lo shelving	80 Hz +/-15 dB, Q fixed at 2 oct.
Low-cut (high pass) filter	75 Hz, 18 dB/oct.

Channel insert

Max in/out	+22 dBu
Channel to channel crosstalk	-95 dB @ 1 kHz

Subgroup section

Noise	Bus noise @ fader 0 dB: -105.0 dBr (ref.: +4 dBu); -92.0 dBr (ref.: +4 dBu, all input channels assigned, Unity gain, channels muted); -87.0 dBr (ref.: +4 dBu, all input channels assigned, Unity gain)
-------	--

Submaster output

Max. output	+22 dBu balanced/unbalanced
Fader range	+10 dB to -85 dB

Main mix section

Noise	Bus noise @ fader 0 dB: -102.0 dBr (ref.: +4 dBu); -92.0 dBr (ref.: +4 dBu, all input channels assigned, Unity gain, channels muted); -87.0 dBr (ref. +4 dBu, all input channels assigned, Unity gain)
Max output	+28 dBu balanced, +22 dBu unbalanced

Aux returns

Gain range	From "off" to "Unity" to +20 dB
------------	---------------------------------

Aux sends

Max. output	+22 dBu
-------------	---------

General

Distortion (THD & N)	0.007 %, @ +4 dBu, 1 kHz, bandwidth 80 kHz
Frequency response	20 Hz - 40 kHz +/-1 dB any input to any output; 10 Hz -120 kHz +/-3 dB

Physical dimensions

(H x W x D) Mixer	approx. 2 1/8" / 3 13/16" x 28 3/8" x 19 1/2" (approx. 54 / 97 mm x 720 mm x 495 mm)
Weight	approx. 12 kg
(H x W x D) Power Supply Unit	approx. 3 1/2" x 17 1/8" x 9 3/4" (approx. 86 mm x 435 mm x 246 mm)
Weight	approx. 7 kg

BEHRINGER is constantly striving to maintain the highest professional standards. As a result of these efforts, modifications may be made from time to time to existing products without prior notice. Specifications and appearance may differ from those listed or shown.

12. WARRANTY

§ 1 WARRANTY CARD/ONLINE REGISTRATION

To be protected by the extended warranty, the buyer must complete and return the enclosed warranty card within 14 days of the date of purchase to BEHRINGER Spezielle Studiotechnik GmbH, in accordance with the conditions stipulated in § 3. Failure to return the card in due time (date as per postmark) will void any extended warranty claims. Based on the conditions herein, the buyer may also choose to use the online registration option via the Internet (www.behringer.com or www.behringer.de).

§ 2 WARRANTY

1. BEHRINGER (BEHRINGER Spezielle Studiotechnik GmbH including all BEHRINGER subsidiaries listed on the enclosed page, except BEHRINGER Japan) warrants the mechanical and electronic components of this product to be free of defects in material and workmanship for a period of one (1) year* from the original date of purchase, in accordance with the warranty regulations described below. If the product shows any defects within the specified warranty period that are not excluded from this warranty as described under § 3 and 4, BEHRINGER shall, at its discretion, either replace or repair the product using suitable new or reconditioned parts. In the case that other parts are used which constitute an improvement, BEHRINGER may, at its discretion, charge the customer for the additional cost of these parts.

2. If the warranty claim proves to be justified, the product will be returned to the user freight prepaid.

3. Warranty claims other than those indicated above are expressly excluded.

§ 3 RETURN AUTHORIZATION NUMBER

1. To obtain warranty service, the buyer (or his authorized dealer) must call BEHRINGER (see enclosed list) during normal business hours **BEFORE** returning the product. All inquiries must be accompanied by a description of the problem. BEHRINGER will then issue a return authorization number.

2. Subsequently, the product must be returned in its original shipping carton, together with the return authorization number to the address indicated by BEHRINGER.

3. Shipments without freight prepaid will not be accepted.

§ 4 WARRANTY REGULATIONS

1. Warranty services will be furnished only if the product is accompanied by a copy of the original retail dealer's invoice. Any product deemed eligible for repair or replacement by BEHRINGER under the terms of this warranty will be repaired or replaced within 30 days of receipt of the product at BEHRINGER.

2. If the product needs to be modified or adapted in order to comply with applicable technical or safety standards on a national or local level, in any country which is not the country for which the product was originally developed and manufactured, this modification/adaptation shall not be considered a defect in materials or workmanship. The warranty does not cover any such modification/adaptation, irrespective of whether it was carried out properly or not. Under the terms of this warranty, BEHRINGER shall not be held responsible for any cost resulting from such a modification/adaptation.

3. Free inspections and maintenance/repair work are expressly excluded from this warranty, in particular, if caused by improper handling of the product by the user. This also applies to defects caused by normal wear and tear, in particular, of faders, potentiometers, keys/buttons and similar parts.

4. Damages/defects caused by the following conditions are not covered by this warranty:

- ▲ improper handling, neglect or failure to operate the unit in compliance with the instructions given in BEHRINGER user or service manuals.

- ▲ connection or operation of the unit in any way that does not comply with the technical or safety regulations applicable in the country where the product is used.

- ▲ damages/defects caused by force majeure or any other condition that is beyond the control of BEHRINGER.

5. Any repair or opening of the unit carried out by unauthorized personnel (user included) will void the warranty.

6. If an inspection of the product by BEHRINGER shows that the defect in question is not covered by the warranty, the inspection costs are payable by the customer.

7. Products which do not meet the terms of this warranty will be repaired exclusively at the buyer's expense. BEHRINGER will inform the buyer of any such circumstance. If the buyer fails to submit a written repair order within 6 weeks after notification, BEHRINGER will return the unit C.O.D. with a separate invoice for freight and packing. Such costs will also be invoiced separately when the buyer has sent in a written repair order.

§ 5 WARRANTY TRANSFERABILITY

This warranty is extended exclusively to the original buyer (customer of retail dealer) and is not transferable to anyone who may subsequently purchase this product. No other person (retail dealer, etc.) shall be entitled to give any warranty promise on behalf of BEHRINGER.

§ 6 CLAIM FOR DAMAGES

Failure of BEHRINGER to provide proper warranty service shall not entitle the buyer to claim (consequential) damages. In no event shall the liability of BEHRINGER exceed the invoiced value of the product.

§ 7 OTHER WARRANTY RIGHTS AND NATIONAL LAW

1. This warranty does not exclude or limit the buyer's statutory rights provided by national law, in particular, any such rights against the seller that arise from a legally effective purchase contract.

2. The warranty regulations mentioned herein are applicable unless they constitute an infringement of national warranty law.

* Customers in the European Union please contact BEHRINGER Germany Support for further details.

The information contained in this manual is subject to change without notice. No part of this manual may be reproduced or transmitted in any form or by any means, electronic or mechanical, including photocopying and recording of any kind, for any purpose, without the expressed written permission of BEHRINGER Spezielle Studiotechnik GmbH. BEHRINGER, EURODESK, DENOISER, ULTRA-DYNE, ULTRA-CURVE, ULTRA-Q, ULTRAPATCH and POWERPLAY are registered trademarks ALL RIGHTS RESERVED. © 2002 BEHRINGER Spezielle Studiotechnik GmbH. BEHRINGER Spezielle Studiotechnik GmbH, Hanns-Martin-Schleyer-Str. 36-38, 47877 Willich-Münchheide II, Germany Tel. +49 (0) 21 54 / 92 06-0, Fax +49 (0) 21 54 / 92 06-30

Free Manuals Download Website

<http://myh66.com>

<http://usermanuals.us>

<http://www.somanuals.com>

<http://www.4manuals.cc>

<http://www.manual-lib.com>

<http://www.404manual.com>

<http://www.luxmanual.com>

<http://aubethermostatmanual.com>

Golf course search by state

<http://golfingnear.com>

Email search by domain

<http://emailbydomain.com>

Auto manuals search

<http://auto.somanuals.com>

TV manuals search

<http://tv.somanuals.com>