

# MINIAMP AMP800



## User's Manual

Version 1.1 October 2005



[www.behringer.com](http://www.behringer.com)



## MINIAMP AMP800

### IMPORTANT SAFETY INSTRUCTIONS

**CAUTION:** To reduce the risk of electric shock, do not remove the top cover (or the rear section). No user serviceable parts inside; refer servicing to qualified personnel.

**WARNING:** To reduce the risk of fire or electric shock, do not expose this appliance to rain and moisture. The apparatus shall not be exposed to dripping or splashing and no objects filled with liquids, such as vases, shall be placed on the apparatus.



This symbol, wherever it appears, alerts you to the presence of uninsulated dangerous voltage inside the enclosure—voltage that may be sufficient to constitute a risk of shock.



This symbol, wherever it appears, alerts you to important operating and maintenance instructions in the accompanying literature. Please read the manual.

#### DETAILED SAFETY INSTRUCTIONS:

- 1) Read these instructions.
- 2) Keep these instructions.
- 3) Heed all warnings.
- 4) Follow all instructions.
- 5) Do not use this apparatus near water.
- 6) Clean only with dry cloth.
- 7) Do not block any ventilation openings. Install in accordance with the manufacturer's instructions.
- 8) Do not install near any heat sources such as radiators, heat registers, stoves, or other apparatus (including amplifiers) that produce heat.
- 9) Do not defeat the safety purpose of the polarized or grounding-type plug. A polarized plug has two blades with one wider than the other. A grounding type plug has two blades and a third grounding prong. The wide blade or the third prong is provided for your safety. If the provided plug does not fit into your outlet, consult an electrician for replacement of the obsolete outlet.
- 10) Protect the power cord from being walked on or pinched particularly at plugs, convenience receptacles, and the point where they exit from the apparatus.
- 11) Only use attachments/accessories specified by the manufacturer.
- 12) Use only with the cart, stand, tripod, bracket, or table specified by the manufacturer, or sold with the apparatus. When a cart is used, use caution when moving the cart/apparatus combination to avoid injury from tip-over.
- 13) Unplug this apparatus during lightning storms or when unused for long periods of time.
- 14) Refer all servicing to qualified service personnel. Servicing is required when the apparatus has been damaged in any way, such as power supply cord or plug is damaged, liquid has been spilled or objects have fallen into the apparatus, the apparatus has been exposed to rain or moisture, does not operate normally, or has been dropped.
- 15) CAUTION - These service instructions are for use by qualified service personnel only. To reduce the risk of electric shock do not perform any servicing other than that contained in the operation instructions unless you are qualified to do so.



# MINIAMP

## Ultra-Compact 4-Channel Stereo Headphone Amplifier

- ▲ Ultra-compact 9.5" headphone amplifier system for studio and stage applications
- ▲ 4 totally independent stereo high-power amplifier sections
- ▲ Highest sonic quality with virtually all types of headphones even at maximum volume
- ▲ Phones Level control plus accurate 6-digit LED output meter per channel for easy level monitoring
- ▲ 2 balanced stereo main inputs with independent Level and Balance controls for individual mixes, selectable for all 4 headphone amplifiers
- ▲ Accurate 6-digit LED main input meter for precise level indication of both line inputs
- ▲ Dual headphone outputs on each channel on front and rear panels allow a total of 8 headphones to be connected at the same time
- ▲ Parallel Link Output allows cascading of several headphone amplifiers
- ▲ High-quality potentiometers and illuminated switches for long-term reliability
- ▲ Ultra low-noise audio operational amplifiers offer outstanding sound performance
- ▲ All Mini Series models can be stacked on top of each other to create an ultra-compact signal processor solution
- ▲ High-quality components and exceptionally rugged construction ensure long life
- ▲ Conceived and designed by BEHRINGER Germany

GB

### FOREWORD



GB

Dear Customer,

Thank you very much for expressing your confidence in BEHRINGER products by purchasing the MINIAMP AMP800.

Writing this foreword for you gives me great pleasure, because it represents the culmination of many months of hard work delivered by our engineering team to achieve a very ambitious goal: presenting four stereo amplifier sections in one compact and flexible headphone amplifier. The task of designing our new AMP800 certainly meant a great deal of responsibility, which we assumed by focusing on you, the discerning user and musician. Meeting your expectations also meant a lot of work and night shifts. But it was fun, too. Developing a product usually brings a lot of people together, and what a great feeling it is when everybody who has participated in such a project can be proud of what they've achieved.

It is our philosophy to share our enjoyment with you, because you are the most important member of the BEHRINGER team. With your highly competent suggestions for new products, you've made a significant contribution to help shape our company and make it successful. In return, we guarantee you uncompromising quality, as well as excellent

technical and audio properties at an extremely reasonable price. All of this will enable you to give free rein to your creativity without being hampered by budget constraints.

We are often asked how we manage to produce such high-quality devices at such unbelievably low prices. The answer is quite simple: it's you, our customers! Many satisfied customers mean large sales volumes enabling us to get better purchasing terms for components, etc. Isn't it only fair to pass this benefit on to you? Because we know that your success is our success too!

I would like to thank all of those who have made the AMP800 possible. You have all made your own personal contributions, from the developers to the many other employees at this company, and to you, the BEHRINGER user.

My friends, it's been worth the effort!

Thank you very much,

Uli Behringer

**TABLE OF CONTENTS**

**1. INTRODUCTION ..... 5**  
    1.1 Before you begin ..... 5  
        1.1.1 Shipment ..... 5  
        1.1.2 Initial operation ..... 6  
        1.1.3 Online registration ..... 6  
**2. CONTROL ELEMENTS ..... 6**  
    2.1 Front panel ..... 6  
    2.2 Rear panel ..... 7  
**3. SETUP EXAMPLE ..... 8**  
**4. AUDIO CONNECTIONS ..... 9**  
**5. SPECIFICATIONS ..... 10**  
**6. OTHER MINI PRODUCTS ..... 11**  
**7. WARRANTY ..... 12**



**1. INTRODUCTION**

Thank you very much for expressing your confidence in our products by purchasing one of our headphone amplifier systems. This 4-channel stereo headphone amplifier is designed for use with all types of headphones and therefore provides maximum flexibility. Its high-power stereo amplifiers guarantee the highest sonic quality. The ultra low-noise 4580 operational amplifiers ensure outstanding audio performance.

**Please read the manual carefully and keep it around for future reference.**

**1.1 Before you begin**

**1.1.1 Shipment**

Your AMP800 was carefully packed at the factory, and the packaging was designed to protect the unit from rough handling. Nevertheless, we recommend that you carefully examine the packaging and its contents for any signs of physical damage that may have occurred during transit.

**If the unit is damaged, please do NOT return it to BEHRINGER. Instead, notify your dealer and the shipping company immediately. Otherwise, claims for damage or replacement may not be honored.**

**Always use the original packing carton to prevent damage during storage or transport.**

**Make sure that no children are left unsupervised with the AMP800 or its packaging.**

**Please ensure proper disposal of all packing materials.**

## MINIAMP AMP800

### 1.1.2 Initial operation

Do not put the AMP800 on any equipment that generates intense heat, for example an amplifier. Ensure that the ventilation openings that are located on the top panel of the AMP800 are not covered or blocked.

 **To power the AMP800, use only the power supply unit that is delivered with your equipment.**

### 1.1.3 Online registration

Please do remember to register your new BEHRINGER equipment right after your purchase by visiting [www.behringer.com](http://www.behringer.com) (alternatively [www.behringer.de](http://www.behringer.de)) and kindly read the terms and conditions of our warranty carefully.

GB

Should your BEHRINGER product malfunction, our goal is to have it repaired as quickly as possible. To arrange for warranty service, please contact the retailer from whom the equipment was purchased. Should your BEHRINGER dealer not be located in your vicinity, you may directly contact one of our subsidiaries. Corresponding contact information is included in the original equipment packaging (Global Contact Information/European Contact Information). Should your country not be listed, please contact the distributor nearest you. A list of distributors can be found in the support area of our website ([www.behringer.com/support](http://www.behringer.com/support)).

Registering your purchase and equipment with us helps us process your repair claims quicker and more efficiently.

Thank you for your cooperation!

## 2. CONTROL ELEMENTS

The AMP800 is a headphone amplifier that includes 4 Headphone Channels, so you can share the AMP800 with other musicians. In addition, each musician can choose between 2 audio channels: Input Channel A and Input Channel B.

 **Ensure that only qualified personnel set up and operate the AMP800.**

### 2.1 Front panel

This section describes how to use the front panel of the AMP800, illustrated as follows:

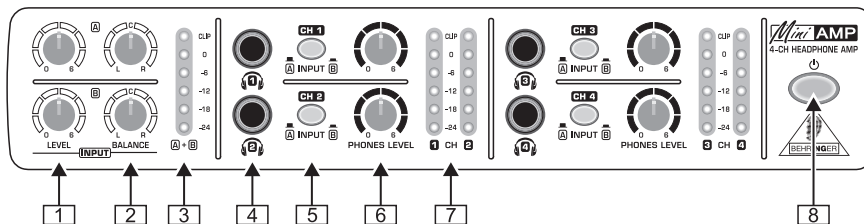

Fig. 2.1: AMP800 front panel

In the previous illustration, each control element is associated with a callout, for example **1**. In this section, use these callouts to identify details about each control element.

For each Input Channel (A and B), the front panel includes control elements **1** and **2**. To manage the signal in each of these Input Channels, use these control elements:

- 1** **LEVEL control:** To adjust the input level of a signal, turn this control toward **0** (minimum level) or, alternatively **6** (maximum level).

## MINIAMP AMP800

- 2] **BALANCE control:** To adjust the stereo image of a signal, turn this control toward **L** (left) or, alternatively **R** (right).
- 3] **A + B meter:** To monitor the combined level of both signals (A and B), use this meter. An LED glows next to the value that identifies the combined level (-24 dB to 0 dB). If the signal is too strong, the **CLIP** LED glows. Most of the time, the optimal level is 0 dB (a full signal).

For each Headphone Channel (1, 2, 3, and 4), the front panel includes control elements 4] through 7]. To manage each Headphone Channel, use these control elements:

- 4] **(headphone) connector:** To connect a headphone, use this stereo, 1/4" TRS connector. For details about TRS plugs, see 4. **AUDIO CONNECTIONS**.
- 5] **INPUT button:** To select an Input Channel, push this button. When you listen to:
  - ▲ Input Channel A, this button is not pushed in and not lit
  - ▲ Input Channel B, this button is pushed in and lit
- 6] **PHONES LEVEL control:** To adjust the level of a headphone signal, turn this control toward **0** (minimum volume) or, alternatively **6** (maximum volume).
- 7] **CH meter:** To monitor the level of a headphone signal, use this meter. An LED glows next to the value that identifies the headphone volume (-24 dB to 0 dB). If the signal is too strong, the **CLIP** LED glows. Most of the time, the optimal volume is 0 dB (a full signal).
- 8] **(power) button:** To turn the AMP800 on and off, push this button. When you turn the AMP800:
  - ▲ on, this button is pushed in and lit
  - ▲ off, this button is not pushed in and not lit



**When you finish using the AMP800, unplug the power supply unit from the power source. As long as the power supply unit is connected to a power source, the power supply unit consumes energy.**

## 2.2 Rear panel

This section describes how to use the rear panel to set up the AMP800.

The following illustrates the rear panel of the AMP800:

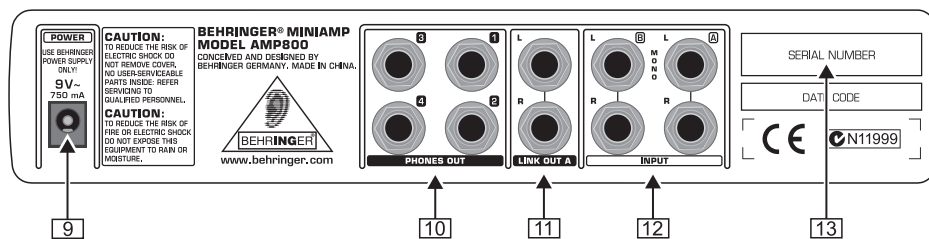

Fig. 2.2: AMP800 rear panel

In the previous illustration, each control element is associated with a callout, for example 1]. In this section, use these callouts to identify details about each control element:

- 9] **POWER connector:** To power the AMP800, connect the power supply unit to this connector. This power supply unit is delivered with the AMP800.
- 10] **PHONES OUT connectors:** For each Headphone Channel (1, 2, 3, and 4), the rear panel includes an additional headphone connector, which is a stereo, 1/4" TRS connector.

## MINIAMP AMP800

- [11] **LINK OUT A connectors:** If you need more than the 4 Headphone Channels that a single AMP800 provides, connect these balanced, ¼" TRS connectors (Left and Right) to the inputs of another AMP800. The LINK OUT A connectors send only the signal of Input Channel A, without any LEVEL or BALANCE settings.
- [12] **INPUT connectors:** For each Input Channel (A and B), the rear panel includes 2 balanced, ¼" TRS connectors (Left and Right). Connect them to the outputs of a mixer, a CD player, or a soundcard. For mono signals, use only the L connector.
- ☞ **If the output is balanced and you insert unbalanced, ¼" TS plugs in the INPUT connectors, the signal level will decrease 6 dB. To raise the signal level, use the relevant LEVEL control ( [1] ).**



- [13] **SERIAL NUMBER:** To register the AMP800, use this unique serial number.

For details about TS and TRS plugs, see 4. AUDIO CONNECTIONS.

### 3. SETUP EXAMPLE

The following example illustrates the role of the AMP800 in your audio setups:

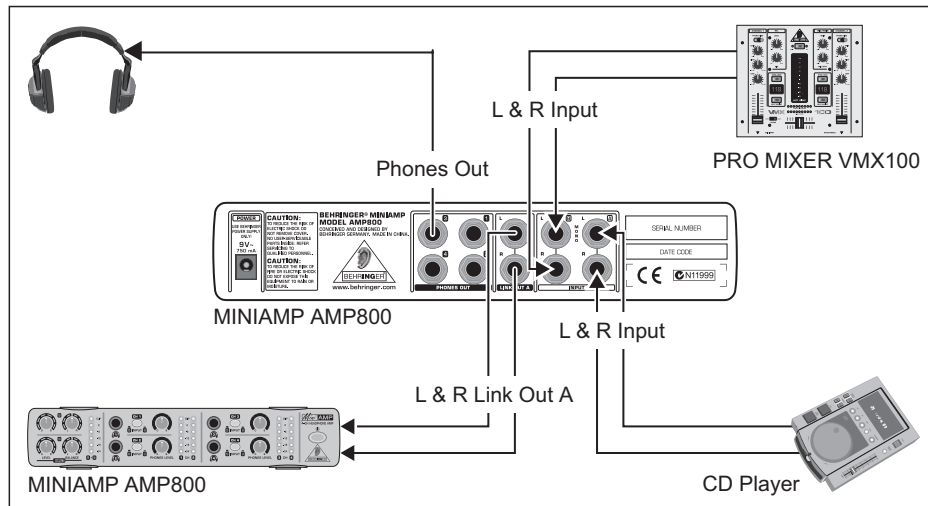

Fig. 3.1: Setup example

#### About setting up with other MINI products

The AMP800 belongs to the MINI suite of BEHRINGER products. You can set up the AMP800 with these products. For details, see 6. OTHER MINI PRODUCTS.



**4. AUDIO CONNECTIONS**

The following provides illustrations of patch cords that include unbalanced, ¼" TS plugs and balanced, ¼" TRS plugs:

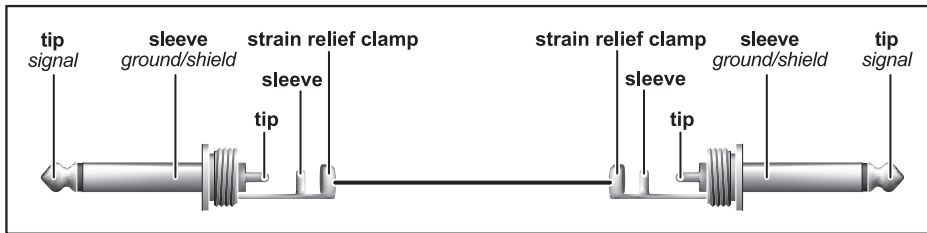

*Fig. 4.1: Patch cord with unbalanced, ¼" TS plugs*

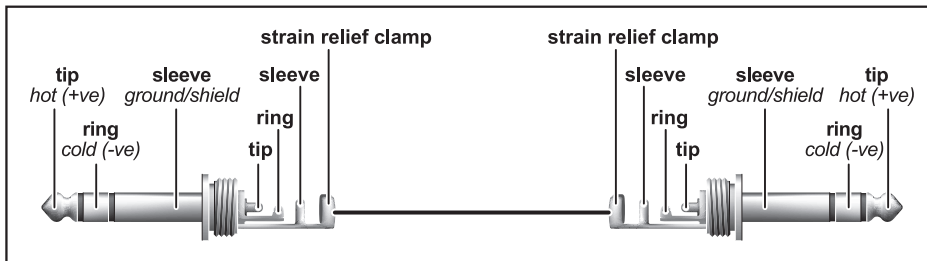

*Fig. 4.2: Patch cord with balanced, ¼" TRS plugs*

## MINIAMP AMP800

---

### 5. SPECIFICATIONS

#### INPUT

Type	¼" TRS connector, balanced
Impedance	approx. 20 kΩ, balanced approx. 10 kΩ, unbalanced
CMRR	40 dB typ. @ 1 kHz

#### PHONES OUT



Type	¼" TRS connector, stereo
Impedance	min. 100 Ω
Max. output level	+13 dBu @ 100 Ω load

#### LINK OUT A

Type	¼" TRS connector, balanced
------	----------------------------

#### SYSTEM SPECIFICATIONS

Frequency response	10 Hz to 120 kHz, -3 dB
Dynamic range	108 dB, 10 Hz to 22 kHz (100 Ω load)
Distortion	0.007 % typ. (100 Ω load)
Crosstalk	< 80 dBu @ 1 kHz
Signal-to-noise ratio	10 Hz to 22 kHz < 95 dB @ 0 dBu, a-weighted

#### AMPLIFIER

Max. output level	+21 dBm / 124 mW (100 Ω load)
Min. output impedance	47 Ω

#### POWER SUPPLY

Mains connection	external power supply, 9 V~ / 750 mA
Mains voltage	
USA/Canada	120 V~, 60 Hz
U.K./Australia	240 V~, 50 Hz
China	220 V~, 50 Hz
Europe	230 V~, 50 Hz
Japan	100 V~, 50 - 60 Hz
Power consumption	11 W

#### DIMENSIONS/WEIGHT

Dimensions (H x W x D)	approx. 1.89" (48 mm) x 9.55" (242.6 mm) x 4.72" (120 mm)
Weight	approx. 1.09 lbs. (0,495 kg)

BEHRINGER constantly strives to maintain the highest quality standards. Modifications may be made, if necessary, without prior notice. The specifications and appearance of the equipment may therefore differ from those listed or illustrated.

**6. OTHER MINI PRODUCTS**

The MINIAMP belongs to the MINI suite of BEHRINGER products, which can operate together and are introduced below:

**MINIFEX FEX800**

**Ultra-compact 9.5" stereo multi-effects processor for studio and stage applications**

- ▲ 16 awesome FX presets in 24-bit/48 kHz resolution including reverb, delay, chorus, flanger, phaser, rotary speaker, pitch shifter and multi-effects
- ▲ Intuitive FX Preset control with LED's indicating the selected program

**MINICOM COM800**

**Ultra-compact 9.5" stereo modeling compressor for studio and stage applications**

- ▲ 16 awesome preset models for the most typical compression applications (vocal, drums, guitar, keyboard, etc.)
- ▲ Dedicated Compressor Modeling control with LED's indicating the selected dynamics program



**MINIMIC MIC800**

**Ultra-compact 9.5" microphone modeling preamp for studio and stage applications**

- ▲ High-end preamplifier for all microphone, instrument and line-level sources. Perfectly complements studio-grade condenser mics
- ▲ Ultra-flexible Preamp Modeling allows you to quickly optimize your recordings

**MINIMON MON800**

**Ultra-compact 9.5" monitor matrix mixer for studio and stage applications**

- ▲ Dedicated input section with 4 selectable and mixable stereo inputs
- ▲ Accurate 6-digit LED main stereo output meters for precise level indication

**MINIFBQ FBQ800**

**Ultra-compact 9.5" graphic equalizer for studio and stage applications**

- ▲ Revolutionary FBQ Feedback Detection System instantly reveals critical frequencies and can also be used as Audio Analyzer
- ▲ Additional Low Cut filter removes unwanted frequencies, e. g. floor rumble

**MINIBEAT BEAT800**

**Ultra-compact 9.5" dual beat counter/phono preamp for studio and stage applications**

- ▲ Intelligent dual BPM counters with Tempo Difference indicator
- ▲ Ultra-flexible Beat Assist and Sync Lock functions

**MINIMIX MIX800**

**Ultra-compact 9.5" karaoke machine for studio and stage applications**

- ▲ Revolutionary Voice Canceller—effectively eliminates vocals from any stereo source while retaining most music elements
- ▲ Integrated digital echo/reverb processor in 24-bit/40 kHz resolution for ultimate vocal enhancement

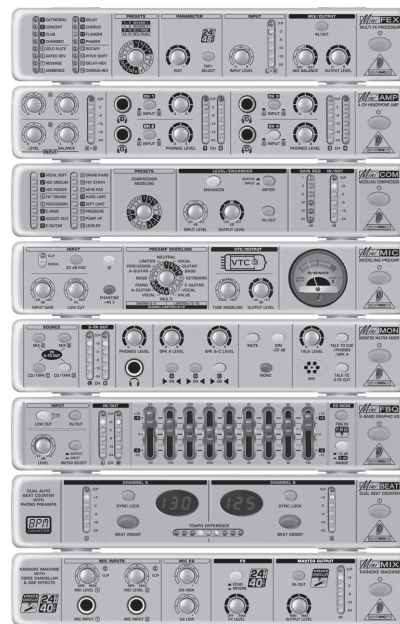

*MINI products stack on top of each other*

### 7. WARRANTY

#### § 1 OTHER WARRANTY RIGHTS AND NATIONAL LAW

1. This warranty does not exclude or limit the buyer's statutory rights provided by national law, in particular, any such rights against the seller that arise from a legally effective purchase contract.
2. The warranty regulations mentioned herein are applicable unless they constitute an infringement of national warranty law.

#### § 2 ONLINE REGISTRATION

Please do remember to register your new BEHRINGER equipment right after your purchase by visiting [www.behringer.com](http://www.behringer.com) (alternatively [www.behringer.de](http://www.behringer.de)) and kindly read the terms and conditions of our warranty carefully.



Registering your purchase and equipment with us helps us process your repair claims quicker and more efficiently.

Thank you for your cooperation!

#### § 3 WARRANTY

1. BEHRINGER (BEHRINGER International GmbH including all BEHRINGER subsidiaries listed on the enclosed page, except BEHRINGER Japan) warrants the mechanical and electronic components of this product to be free of defects in material and workmanship for a period of one (1) year\* from the original date of purchase, in accordance with the warranty regulations described below. If the product shows any defects within the specified warranty period that are not excluded from this warranty as described under § 5, BEHRINGER shall, at its discretion, either replace or repair the product using suitable new or reconditioned parts. In the case that other parts are used which constitute an improvement, BEHRINGER may, at its discretion, charge the customer for the additional cost of these parts.
2. If the warranty claim proves to be justified, the product will be returned to the user freight prepaid.
3. Warranty claims other than those indicated above are expressly excluded.

#### § 4 RETURN AUTHORIZATION NUMBER

1. To obtain warranty service, the buyer (or his authorized dealer) must call BEHRINGER (see enclosed list) during normal business hours **BEFORE** returning the product. All inquiries must be accompanied by a description of the problem. BEHRINGER will then issue a return authorization number.
2. Subsequently, the product must be returned in its original shipping carton, together with the return authorization number to the address indicated by BEHRINGER.
3. Shipments without freight prepaid will not be accepted.

#### § 5 WARRANTY REGULATIONS

1. Warranty services will be furnished only if the product is accompanied by a copy of the original retail dealer's invoice. Any product deemed eligible for repair or replacement under the terms of this warranty will be repaired or replaced.
2. If the product needs to be modified or adapted in order to comply with applicable technical or safety standards on a national or local level, in any country which is not the country for which the product was originally developed and manufactured, this modification/adaptation shall not be considered a defect in materials or workmanship. The warranty does not cover any such modification/adaptation, irrespective of whether it was carried out properly or not. Under the terms of this warranty, BEHRINGER shall not be held responsible for any cost resulting from such a modification/adaptation.
3. Free inspections and maintenance/repair work are expressly excluded from this warranty, in particular, if caused by improper handling of the product by the user. This also applies to defects caused by normal wear and tear, in particular, of faders, crossfaders, potentiometers, keys/buttons, tubes, guitar strings, illuminants and similar parts.

## MINIAMP AMP800

4. Damages/defects caused by the following conditions are not covered by this warranty:
- ▲ improper handling, neglect or failure to operate the unit in compliance with the instructions given in BEHRINGER user or service manuals.
  - ▲ connection or operation of the unit in any way that does not comply with the technical or safety regulations applicable in the country where the product is used.
  - ▲ damages/defects caused by force majeure or any other condition that is beyond the control of BEHRINGER.
5. Any repair or opening of the unit carried out by unauthorized personnel (user included) will void the warranty.
6. If an inspection of the product by BEHRINGER shows that the defect in question is not covered by the warranty, the inspection costs are payable by the customer.
7. Products which do not meet the terms of this warranty will be repaired exclusively at the buyer's expense. BEHRINGER will inform the buyer of any such circumstance. If the buyer fails to submit a written repair order within 6 weeks after notification, BEHRINGER will return the unit C.O.D. with a separate invoice for freight and packing. Such costs will also be invoiced separately when the buyer has sent in a written repair order.

GB

### § 6 WARRANTY TRANSFERABILITY

This warranty is extended exclusively to the original buyer (customer of retail dealer) and is not transferable to anyone who may subsequently purchase this product. No other person (retail dealer, etc.) shall be entitled to give any warranty promise on behalf of BEHRINGER.

### § 7 CLAIM FOR DAMAGES

Failure of BEHRINGER to provide proper warranty service shall not entitle the buyer to claim (consequential) damages. In no event shall the liability of BEHRINGER exceed the invoiced value of the product.

\* Customers in the European Union please contact BEHRINGER Germany Support for further details.

---

Technical specifications and appearance subject to change without notice. The information contained herein is correct at the time of printing. The names of companies, institutions or publications pictured or mentioned and their respective logos are registered trademarks of their respective owners. Their use neither constitutes a claim of the trademarks by BEHRINGER® nor affiliation of the trademark owners with BEHRINGER®. BEHRINGER® accepts no liability for any loss which may be suffered by any person who relies either wholly or in part upon any description, photograph or statement contained herein. Colours and specification may vary slightly from product. Products are sold through our authorised dealers only. Distributors and dealers are not agents of BEHRINGER® and have absolutely no authority to bind BEHRINGER® by any express or implied undertaking or representation. No part of this manual may be reproduced or transmitted in any form or by any means, electronic or mechanical, including photocopying and recording of any kind, for any purpose, without the express written permission of BEHRINGER Spezielle Studiotechnik GmbH. BEHRINGER® is a registered trademark.

ALL RIGHTS RESERVED. © 2005 BEHRINGER Spezielle Studiotechnik GmbH,  
Hanns-Martin-Schleyer-Str. 36-38, 47877 Willich-Münchheide II, Germany.  
Tel. +49 2154 9206 0, Fax +49 2154 9206 4903

## Free Manuals Download Website

<http://myh66.com>

<http://usermanuals.us>

<http://www.somanuals.com>

<http://www.4manuals.cc>

<http://www.manual-lib.com>

<http://www.404manual.com>

<http://www.luxmanual.com>

<http://aubethermostatmanual.com>

Golf course search by state

<http://golfingnear.com>

Email search by domain

<http://emailbydomain.com>

Auto manuals search

<http://auto.somanuals.com>

TV manuals search

<http://tv.somanuals.com>