

OIE 22500 XP

# Built-in Oven User Manual



## **Please read this manual first.**

Dear Customer,

We would like you to obtain best performance with your product that has been manufactured in modern facilities and passed through strict quality control procedures.

Therefore, we advise you to read through this User Manual carefully before using your product and keep it for future reference. If you hand over the product to someone else, deliver the User Manual as well.

## **The User Manual will help you use the product in a fast and safe way.**

- Read the User Manual before installing and operating the product.
- You must strictly observe the safety instructions.
- Keep this User Manual within easy reach for future reference.
- Also read other documents supplied with the product.  
Remember that this User Manual may also be applicable for several other models.  
Differences between models are explicitly identified in the manual.

## **Explanation of symbols**

Throughout this User Manual the following symbols are used:

 Important information or useful hints about usage.

 Warning for hazardous situations with regard to life and property.

 Warning for electric shock.

 Warning for risk of fire.

 Warning for hot surfaces.



**Arçelik A.Ş.**  
Karaağaç caddesi No:2-6  
34445 Söğütözü/İstanbul/TURKEY  
Made in TURKEY

# Table of Contents

---

<b>1</b>	<b>General information</b> .....	<b>4</b>	Initial heating .....	17	
	Overview .....	4			
	Technical specifications .....	5			
	Accessories .....	5			
<b>2</b>	<b>Important safety instructions</b> 7		<b>5</b>	<b>How to operate the oven</b> .... <b>18</b>	
	General safety.....	7		General information on baking, roasting	
	Safety for children.....	8		and grilling .....	18
	Safety when working with electricity .	8		How to operate the electric oven.....	18
	Intended use .....	9		Operating modes.....	20
<b>3</b>	<b>Installation</b> .....	<b>10</b>		How to operate the oven control unit	23
	Before installation .....	10		Using the keylock.....	25
	Installation and connection.....	12		Using the clock as an alarm .....	25
	Disposal .....	14		Cooking times table .....	27
	Disposing of packaging material .....	14		How to operate the grill .....	28
	Future Transportation .....	14		Cooking times table for grilling .....	28
	Disposing of the old product .....	15	<b>6</b>	<b>Maintenance and care</b> .....	<b>29</b>
<b>4</b>	<b>Preparation</b> .....	<b>16</b>		General information .....	29
	Tips for saving energy .....	16		Cleaning the control panel.....	29
	Initial use.....	16		Cleaning the oven .....	29
	Initial time setting.....	16		Removing the oven door.....	30
	First cleaning of the appliance.....	17		Removing the door inner glass .....	31
			<b>7</b>	<b>Troubleshooting</b> .....	<b>33</b>

# 1 General information

## Overview

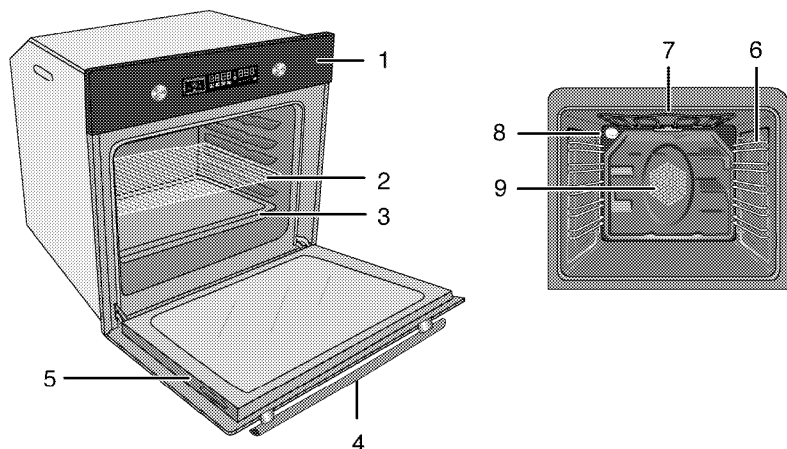

- |   |               |   |                                |
|---|---------------|---|--------------------------------|
| 1 | Control panel | 6 | Shelf positions                |
| 2 | Wire shelf    | 7 | Grill heating element          |
| 3 | Tray          | 8 | Lamp                           |
| 4 | Handle        | 9 | Fan motor (behind steel plate) |
| 5 | Door          |   |                                |

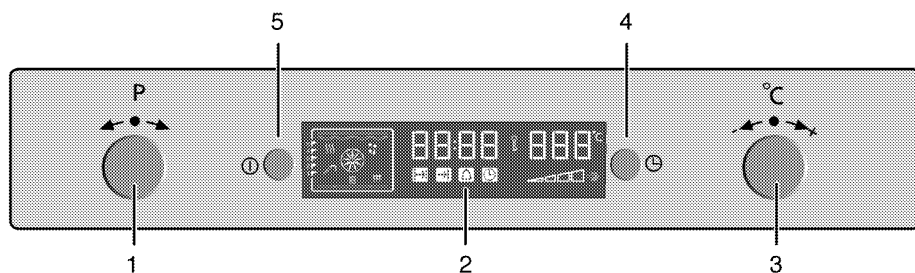

- |   |   |   |               |
|---|---|---|---------------|
| 1 | Program selection knob                    | 4 | Menu button   |
| 2 | Digital timer                             | 5 | ON/OFF button |
| 3 | Temperature-time increase/decrease button |   |               |

## Technical specifications

Voltage / frequency	220-240 V ~ 50 Hz
Total power consumption	2.4 kW
Fuse	min. 16 A
Cable type / section	H05VV-FG 3 x 1,5 mm <sup>2</sup>
Cable length	max. 2 m
External dimensions (height / width / depth)	595 mm/594 mm/567 mm
Installation dimensions (height / width / depth)	**590 or 600 mm/560 mm/min. 550 mm
Main oven	<b>Multifunction oven</b>
Energy efficiency class <sup>#</sup>	A
Inner lamp	15/25 W
Grill power consumption	2.2 kW

<sup>#</sup> Basics: Information on the energy label of electrical ovens is given in accordance with the EN 50304 standard. Those values are determined under standard load with bottom-top heater or fan assisted heating (if any) functions.

Energy efficiency class is determined in accordance with the following prioritization depending on whether the relevant functions exist on the product or not. 1-Cooking with eco-fan, 2- Turbo slow cooking, 3- Turbo cooking, 4- Fan assisted bottom/top heating, 5-Top and bottom heating.

\*\* See. *Installation*, page 10.

 Technical specifications may be changed without prior notice to improve the quality of the product.

 Figures in this manual are schematic and may not exactly match your product.

 Values stated on the product labels or in the documentation accompanying it are obtained in laboratory conditions in accordance with relevant standards. Depending on operational and environmental conditions of the product, these values may vary.

## Accessories

 Accessories supplied can vary depending on the product model. Not every accessory described in the user manual may exist on your product.

### Oven tray

Used for pastries, frozen foods and big roasts.

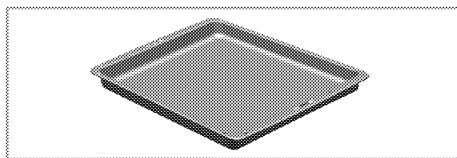

### Deep tray

Used for pastries, large roasts, juicy dishes, and for collecting the fat while grilling.

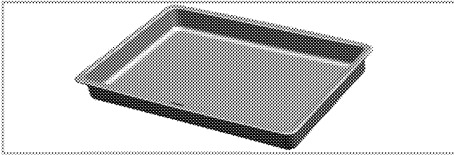

### Cake tray

Used for pastries such as cookies and biscuits.

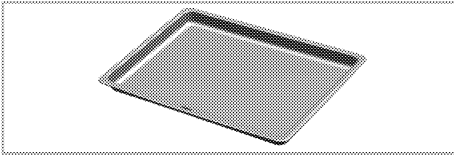

### Small oven tray

Used for small portions. This oven tray is placed onto the wire shelf.

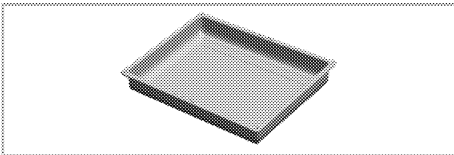

### Wire Shelf

Used for roasting and for placing the food to be baked, roasted or cooked in casserole dishes to the desired rack.

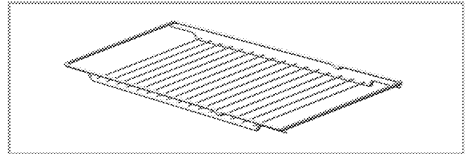
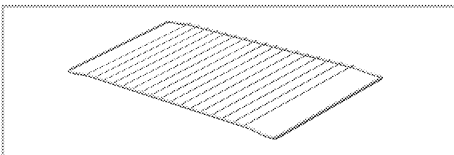

### Placing the wire shelf and tray onto the telescopic racks properly

Telescopic racks allow you to install and remove the trays and wire shelf easily.

When using the tray and wire shelf with telescopic racks, make sure that the pins at the rear section of the telescopic rack stands against the edges of the wire shelf and tray.

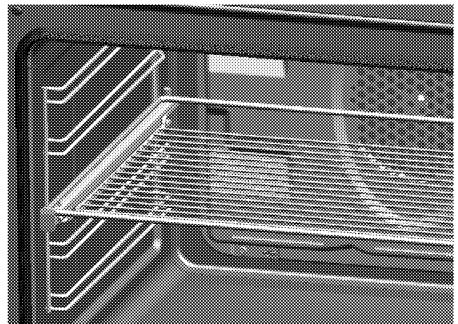
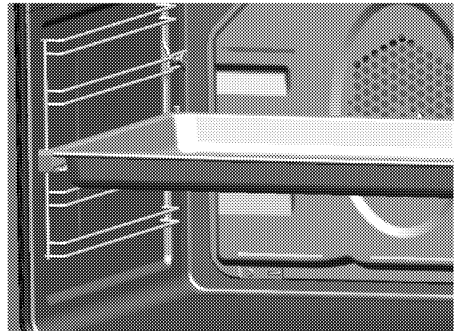

## 2 Important safety instructions

---

This section contains safety instructions that will help you avoid risk of injury and damage. All warranties will become void if you do not follow these instructions.

### General safety

- This product is not intended to be used by persons with physical, sensory or mental disorders or unlearned or inexperienced people (including children) unless they are attended by a person who will be responsible for their safety or who will instruct them accordingly for use of the product. Children must be supervised to prevent them from tampering with the product.
- Connect the product to an earthed outlet/line protected by a fuse of suitable capacity as stated in the "Technical specifications" table. Have the earthing installation made by a qualified electrician while using the product with or without a transformer. Our company shall not be liable for any problems arising due to the product not being earthed in accordance with the local regulations.
- If the supply cord is damaged, it must be replaced by the manufacturer, its service agent or similar qualified persons in order to avoid a hazard.
- Do not operate the product if it is defective or has any visible damage.
- Do not carry out any repairs or modifications on the product. However, you may remedy some troubles that do not require any repairs or modifications. See *Troubleshooting, page 33*.
- Never wash down the product with water! There is the risk of electric shock!
- Never use the product when your judgment or coordination is impaired by the use of alcohol and/or drugs.
- Product must be disconnected from the mains during installation, maintenance, cleaning and repair procedures.
- Installation and repair procedures must always be performed by Authorized Service Agents. The manufacturer shall not be held responsible for damages arising from procedures carried out by unauthorized persons which may also void the warranty.
- Be careful when using alcoholic drinks in your dishes. Alcohol evaporates at high temperatures and may cause fire since it can ignite when it comes into contact with hot surfaces.
- Do not heat closed tins and glass jars in the oven. The pressure that would build-up in the tin/jar may cause it to burst.
- Do not place any flammable materials close to the product as the sides may become hot during use.



- Do not place baking trays, dishes or aluminium foil directly onto the bottom of the oven. The heat accumulation might damage the bottom of the oven.
- Keep all ventilation slots clear of obstructions.
- Product may be hot when it is in use. Never touch the hot burners, inner sections of the oven, heaters and etc.
- Always use heat resistant oven gloves when putting in or removing dishes into/from the hot oven.
- Do not use the product with front door glass removed or cracked.
- Rear surface of the oven gets hot when it is in use. Make sure that the gas/electrical connection does not contact the rear surface; otherwise, connections can get damaged.
- Do not trap the mains cable between the oven door and frame and do not route it over hot surfaces. Otherwise, cable insulation may melt and cause fire as a result of short circuit.
- Make sure that the product function knobs are switched off after every use.

 Product must be installed by a qualified person in accordance with the regulations in force. Otherwise, the warranty shall become void.

## Safety for children

- Electrical and/or gas products are dangerous to children. Keep children away from the product

when it is operating and do not allow them to play with the product.

- Accessible parts of the appliance will become hot whilst the appliance is in use. Children should be kept away until the product has cooled down.
- "**CAUTION:** Accessible parts may be hot when the grill is in use. Young children should be kept away."
- Do not place any items above the appliance that children may reach for.
- When the door is open, do **not** load any heavy object on it and do **not** allow children to sit on it. It may overturn or door hinges may get damaged.
- The packaging materials will be dangerous for children. Keep the packaging materials away from children. Please dispose of all parts of the packaging according to environmental standards.

## Safety when working with electricity

Defective electric equipment is one of the major causes of house fires.

- Any work on electrical equipment and systems should only be carried out by authorised and qualified persons.
- In case of any damage, switch off the product and disconnect it from the mains. To do this, turn off the fuse at home.
- Make sure that fuserating is compatible with the product.

## **Intended use**

This product is designed for domestic use. Commercial use will void the guarantee.

"CAUTION: This appliance is for cooking purposes only. It must not be used for other purposes, for example room heating."

This product should not be used for warming the plates under the grill,

drying towels, dish cloths etc. by hanging them on the oven door handles. This product should also not be used for room heating purposes.

The manufacturer shall not be liable for any damage caused by improper use or handling errors.

The oven can be used for defrosting, baking, roasting and grilling food.

## 3 Installation

---

Refer to the nearest Authorised Service Agent for installation of the product. Make sure that the electric and gas installations are in place before calling the Authorised Service Agent to have the product ready for operation. If not, call a qualified electrician and fitter to have the required arrangements made.



 Preparation of location and electrical and gas installation for the product is under customer's responsibility.

 The product must be installed in accordance with all local gas and/or electrical regulations.

 Prior to installation, visually check if the product has any defects on it. If so, do not have it installed.  
Damaged products cause risks for your safety.

### Before installation

The appliance is intended for installation in commercially available kitchen cabinets. A safety distance must be left between the appliance and the kitchen walls and furniture. See figure (values in mm).

- Surfaces, synthetic laminates and adhesives used must be heat resistant (100 °C minimum).
- Kitchen cabinets must be set level and fixed.
- If there is a drawer beneath the oven, a shelf must be installed between oven and drawer.
- Carry the appliance with at least two persons.
- A minimum distance of 30 mm must be provided to the side cabinets in case of self-cleaning ovens (pyrolysis).
-  Do not install the appliance next to refrigerators or freezers. The heat emitted by the appliance will lead to an increased energy consumption of cooling appliances.
-  The door and/or handle must not be used for lifting or moving the appliance.
-  If the appliance has wire handles, push the handles back into the side walls after moving the appliance.

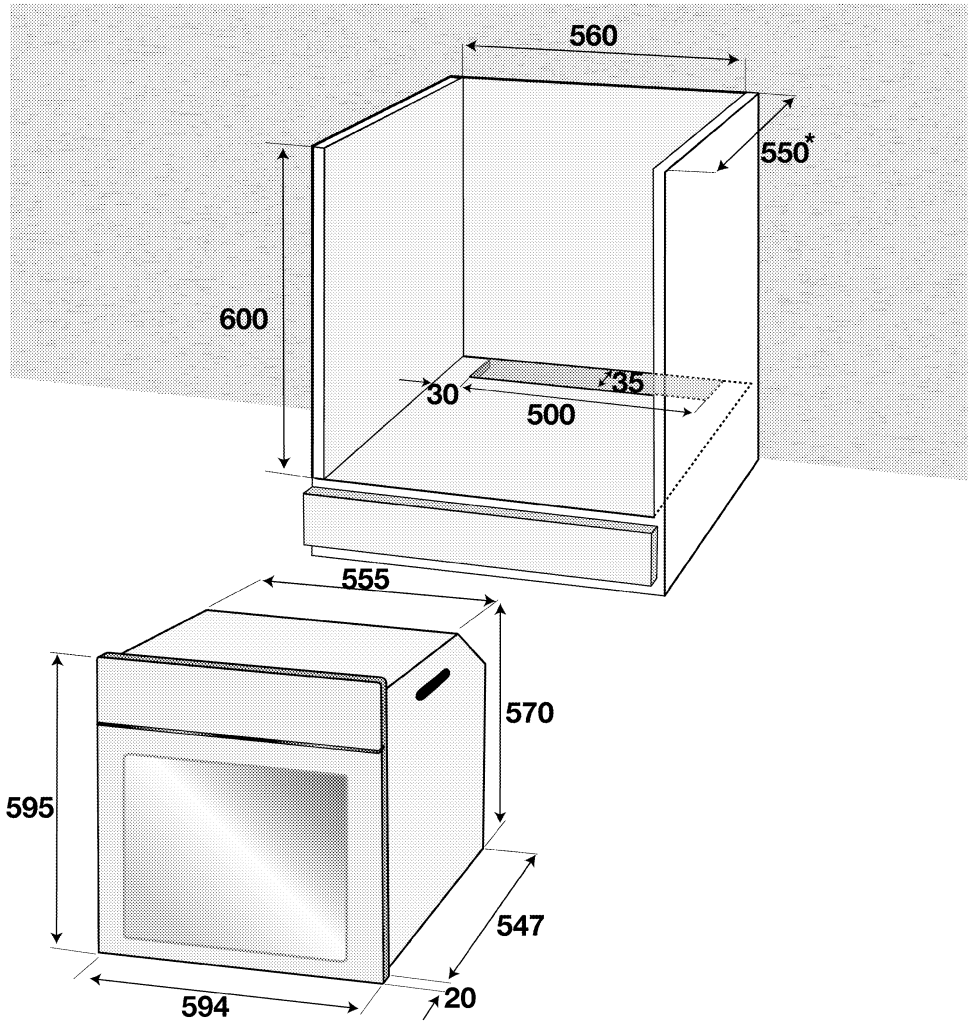

\* min.

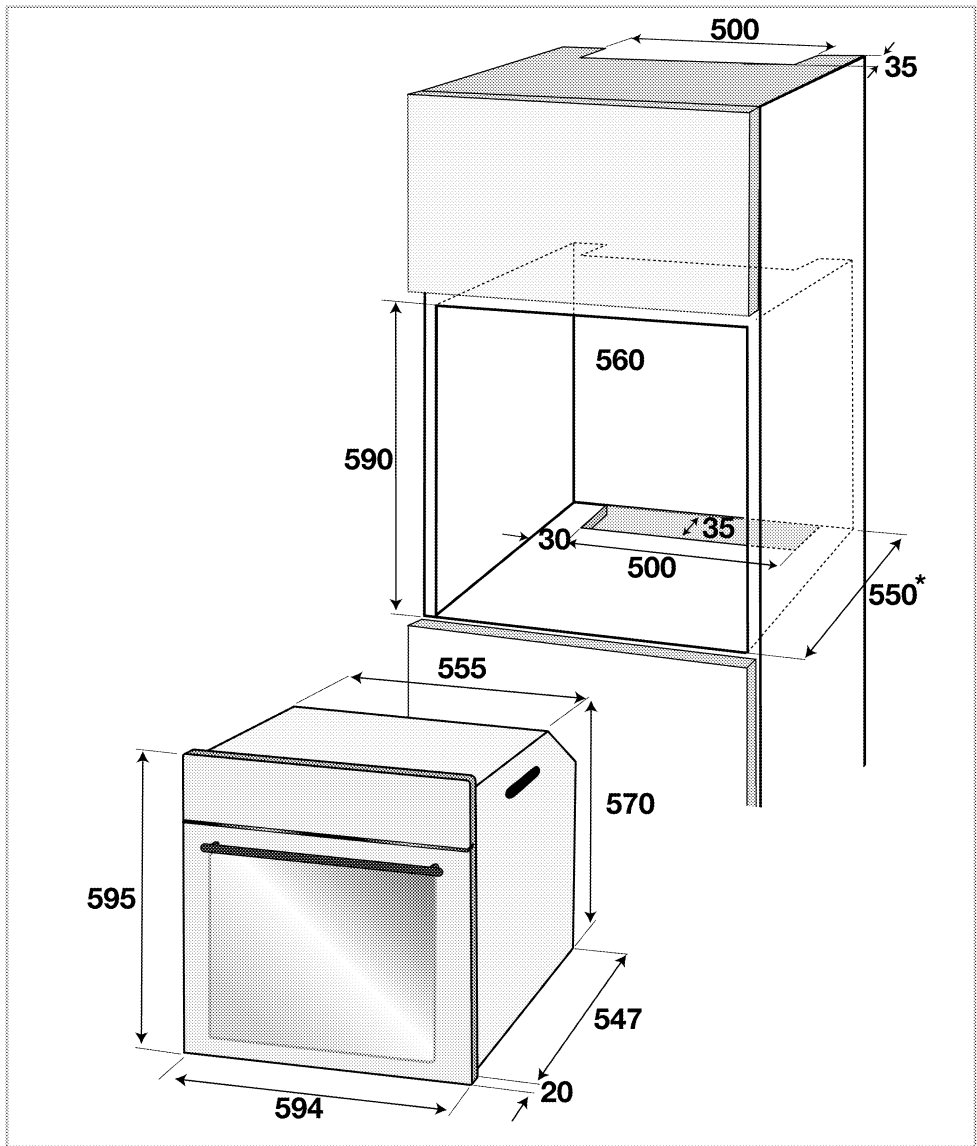

\* min.

## Installation and connection

- The product must be installed in accordance with all local gas and electrical regulations.

### Electrical connection

Connect the product to a grounded outlet/line protected by a fuse of suitable capacity as stated in the "Technical specifications" table. Have the grounding installation made by a qualified electrician while using the

product with or without a transformer. Our company shall not be liable for any damages that will arise due to using the product without a grounding installation in accordance with the local regulations.

⚠ The product must be connected to the mains supply only by an authorised and qualified person. The product's warranty period starts only after correct installation.

Manufacturer shall not be held responsible for damages arising from procedures carried out by unauthorised persons.

⚠ The power cable must not be clamped, bent or trapped or come into contact with hot parts of the product. A damaged power cable must be replaced by a qualified electrician. Otherwise, there is risk of electric shock, short circuit or fire!

- Connection must comply with national regulations.
- The mains supply data must correspond to the data specified on the type label of the product. Open the front door to see the type label.
- Power cable of your product must comply with the values in "Technical specifications" table.

⚠ Before starting any work on the electrical installation, disconnect the product from the mains supply. There is the risk of electric shock!

## Connecting the power cable

1. If it is not possible to disconnect all poles in the supply power, a disconnection unit with at least 3 mm contact clearance (fuses, line safety switches, contactors) must be connected and all the poles of this disconnection unit must be adjacent to (not above) the product in accordance with IEE directives. Failure to obey this instruction may cause operational problems and invalidate the product warranty.

Additional protection by a residual current circuit breaker is recommended.

### If a cable is supplied with the product:

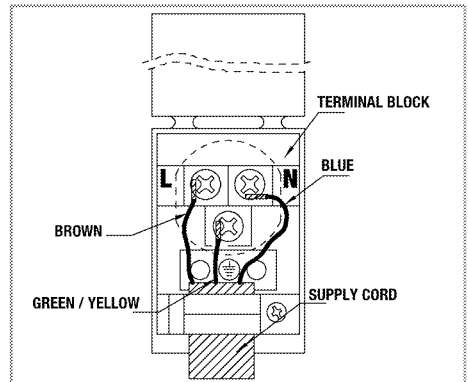

2. **For single-phase connection,** connect the wires as identified below:
  - Brown/Black cable = L (Phase)
  - Blue/Grey cable = N (Neutral)
  - Green/yellow cable = (E)  $\perp$  (Ground)

## Installing the product

1. Slide the oven into the cabinet, align and secure it while making

sure that the power cable is not broken and/or trapped.

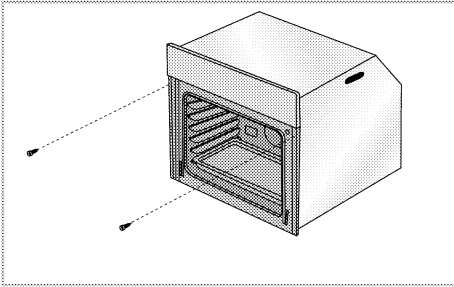

Secure the oven with 2 screws as illustrated.

### For products with cooling fan

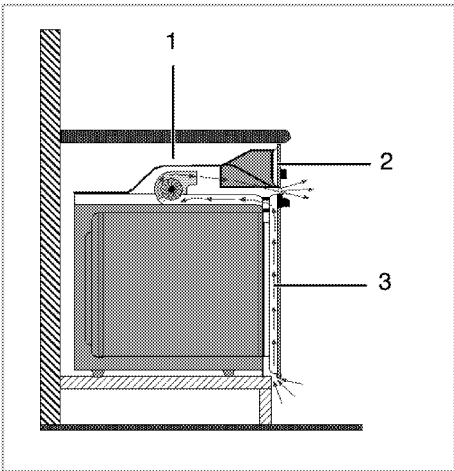

- 1 Cooling fan
- 2 Control panel
- 3 Door

The built-in cooling fan cools both the built-in cabinet and the front of the product.

-  Cooling fan continues to operate for about 20-30 minutes after the oven is switched off.

## Final check

1. Plug in the power cable and switch on the product's fuse.
2. Check the functions.

## Disposal

### Disposing of packaging material

Packaging materials are dangerous to children. Keep packaging materials in a safe place out of reach of children. Packaging materials of the product are manufactured from recyclable materials. Dispose of them properly and sort in accordance with recycled waste instructions. Do not dispose of them with normal domestic waste.

### Future Transportation

- Keep the product's original carton and transport the product in it. Follow the instructions on the carton. If you do not have the original carton, pack the product in bubble wrap or thick cardboard and tape it securely.
- To prevent the wire grill and tray inside the oven from damaging the oven door, place a strip of cardboard onto the inside of the oven door that lines up with the position of the trays. Tape the oven door to the side walls.
- Do not use the door or handle to lift or move the product.
-  Do not place any objects onto the product and move it in upright position.

-  Check the general appearance of your product for any damages that might have occurred during transportation.

## Disposing of the old product



Dispose of the old product in an environmentally friendly manner. This equipment bears the selective sorting symbol for waste electrical and electronic equipment (WEEE). This means that this equipment must be handled pursuant to European Directive 2002/96/EC in order to be

recycled or dismantled to minimize its impact on the environment. For further information, please contact local or regional authorities.

Electronic equipments not included in the selective sorting process are potentially dangerous for the environment and human health due to the presence of hazardous substances. Refer to your local dealer or solid waste collection centre in your area to learn how to dispose of your product. Before disposing of the product, cut off the power cable plug and make the door lock (if any) unusable to avoid dangerous conditions to children.



## 4 Preparation

### Tips for saving energy

The following information will help you to use your appliance in an ecological way, and to save energy:

- Use dark coloured or enamel coated cookware in the oven since the heat transmission will be better.
- While cooking your dishes, perform a preheating operation if it is advised in the user manual or cooking instructions.
- Do not open the door of the oven frequently during cooking.
- Try to cook more than one dish in the oven at the same time

whenever possible. You can cook by placing two cooking vessels onto the wire shelf.

- Cook more than one dish one after another. The oven will already be hot.
- You can save energy by switching off your oven a few minutes before the end of the cooking time. Do not open the oven door.
- Defrost frozen dishes before cooking them.

### Initial use

#### Initial time setting

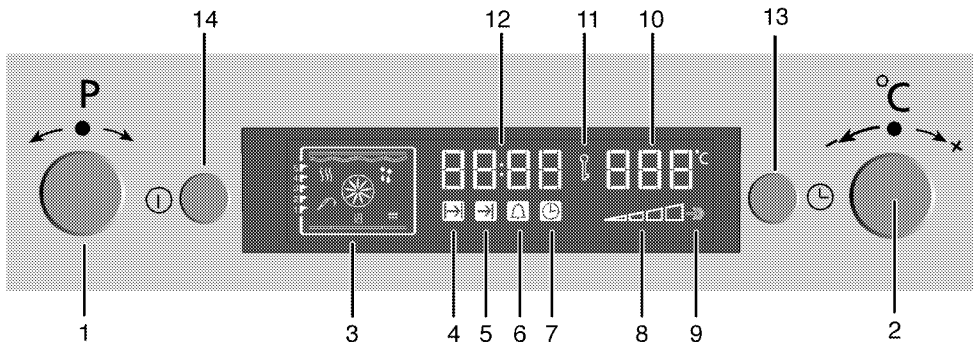

- |    |                                       |    |               |
|----|---------------------------------------|----|---------------|
| 1  | Program selection button              | 13 | Menu button   |
| 2  | Temperature-Time Adjustment button    | 14 | On/Off button |
| 3  | Function display                      |    |               |
| 4  | Cooking time symbol                   |    |               |
| 5  | End of cooking time symbol            |    |               |
| 6  | Alarm symbol                          |    |               |
| 7  | Clock symbol                          |    |               |
| 8  | Oven Inner Temperature symbol         |    |               |
| 9  | Booster (rapid pre-heating) indicator |    |               |
| 10 | Temperature Indicator field           |    |               |
| 11 | Keylock symbol                        |    |               |
| 12 | Time Indicator Field                  |    |               |

1. Twist the Temperature-Time Adjustment knob (2) to + or - slightly to set the time when the oven is operated for the first time.

-  If the current time is not set, time setting will start increasing up from **12:00**. Clock icon '7' will remain lit to indicate that the current time has not been set. This icon will disappear once the time is set.

### Adjust the time afterwards

1. Press Menu button (13) with short intervals until Clock symbol (7) is activated.
2. Twist the Temperature-Time Adjustment knob (2) to "+" or "-" slightly to set the current time.

-  Current time settings are cancelled in case of power failure. It needs to be readjusted. Current time can not be changed when any of the oven functions is in use.

### First cleaning of the appliance

-  The surface might get damaged by some detergents or cleaning materials. Do not use aggressive detergents, cleaning powders/creams or any sharp objects during cleaning.

1. Remove all packaging materials.
2. Wipe the surfaces of the appliance with a damp cloth or sponge and dry with a cloth.

### Initial heating

Heat up the product for about 30 minutes and then switch it off. Thus,

any production residues or layers will be burnt off and removed.

-  Hot surfaces may cause burns! Do not touch the hot surfaces of the product. Keep children away from the product and use oven gloves.

### Electric oven

1. Take all baking trays and the wire grill out of the oven.
2. Close the oven door.
3. Select Static position.
4. Select the highest grill power; See *How to operate the electric oven, page 18*.
5. Operate the oven for about 30 minutes.
6. Turn off your oven; See *How to operate the electric oven, page 18*

### Grill oven

1. Take all baking trays and the wire grill out of the oven.
2. Close the oven door.
3. Select the highest grill power; see *How to operate the grill, page 28*.
4. Operate the oven about 30 minutes.
5. Turn off your grill; see *How to operate the grill, page 28*

-  Smoke and smell may emit for a couple of hours during the initial operation. This is quite normal. Ensure that the room is well ventilated to remove the smoke and smell. Avoid directly inhaling the smoke and the smell that emits.

## 5 How to operate the oven

### General information on baking, roasting and grilling

-  Be careful when opening the oven door as steam may escape. Exiting steam can scald your hands, face and/or eyes.

#### Tips for baking

- Use non-sticky coated appropriate metal plates or aluminum vessels or heat-resistant silicone molds.
- Make best use of the space on the rack.
- Place the baking mold in the middle of the shelf.
- Select the correct rack position before turning the oven or grill on. Do not change the rack position when the oven is hot.
- Keep the oven door closed.

#### Tips for roasting

- Treating whole chicken, turkey and big-piece meats with dressings such as lemon juice and black pepper before cooking will increase the cooking performance.
- It lasts about 15 to 30 minutes longer to roast the meat with bones when compared to roasting the same size of meat without bones.
- Each centimeter of the meat thickness requires approximately 4 to 5 minutes of cooking time.
- Let meat rest in the oven for about 10 minutes after the cooking time is over. The juice is better distributed all over the roast and

does not run out when the meat is cut.

- Fish should be placed on the middle or lower rack in a heat-resistant plate.

#### Tips for grilling

When meat, fish and poultry are grilled, they quickly get brown, have a nice crust and do not get dry. Flat pieces, meat skewers and sausages are particularly suited for grilling as are vegetables with high water content such as tomatoes and onions.

- Distribute the pieces to be grilled on the wire shelf or in the baking tray with wire shelf in such a way that the space covered does not exceed the size of the heater.
- Slide the wire shelf or baking tray with grill into the desired level in the oven. If you are grilling on the wire shelf, slide the baking tray to the lower rack to collect fats. Add some water in the tray for easy cleaning.

-  Foods that are not suitable for grilling carry the risk of fire. Only grill food which is suitable for intensive grilling heat. Do not place the food too far in the back of the grill. This is the hottest area and fatty food may catch fire.

### How to operate the electric oven

Your oven is equipped with pop-out knobs that protrude when you press them.

1. Press inwards to protrude the knob and then turn it to make the desired setting.

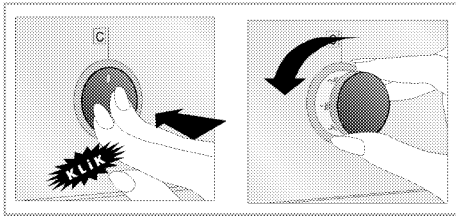

2. When the cooking process is finished, turn the knob to off (upper) position and press it inwards.

### How to operate the oven

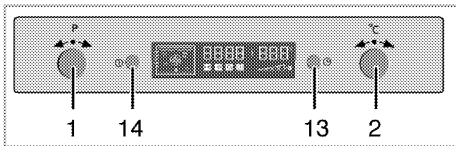

- 1 Program selection knob
- 2 Temperature-time increase/decrease button
- 13 Menu button
- 14 ON/OFF button

1. Press On/Off button (14) for about 1 second to switch on the oven.

### Select temperature and operating mode

Once the oven is switched on, blank function display appears.



When the display is in this mode, cooking time, end of cooking time and Booster (quick heating) function can be set.

- i** Oven will switch off automatically within 10 seconds if no oven setting is made on this screen.

1. Twist the Program Selection knob (1) slightly to right or left to set the desired operating mode.
2. Twist the Temperature-Time Adjustment knob (2) to "+" or "-" slightly to set the desired temperature.

» Your oven will readily start operating in the desired function and will increase the inner temperature to the set temperature.

» Active heaters and recommended tray position appears in the Function display.

» If the temperature is not set before, recommended temperature for the set function will be displayed in temperature screen.

### Function table:

Function table indicates the functions that can be used in the oven and their respective maximum and minimum temperatures.

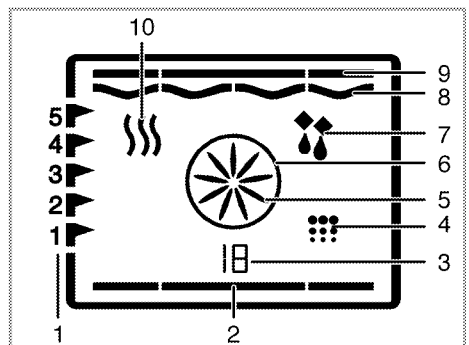

- 1 Rack positions
- 2 Bottom heater
- 3 Function number
- 4 Cleaning position

- 5 Boost fan
- 6 Boost heater
- 7 Operating with fan position
- 8 Grill heater
- 9 Top heater
- 10 Keep warm
- \* Functions vary depending on the product model!

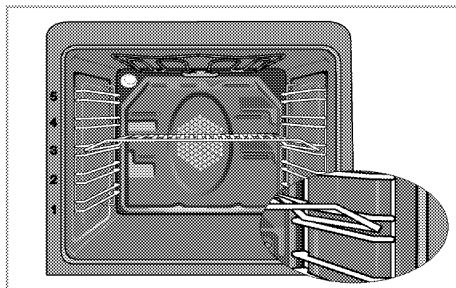

### Rack positions (For models with wire shelf)

It is important to place the wire shelf onto the side rack correctly. Wire shelf must be inserted between the side racks as illustrated in the figure. Do not let the wire shelf stand against the rear wall of the oven. Slide your wire shelf to the front section of the rack and settle it with the help of the door in order to obtain a good grill performance.

### Operating modes

The order of operating modes shown here may be different from the arrangement on your product.



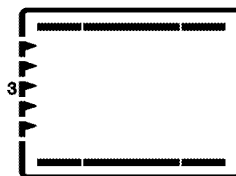

#### 1. Top and bottom heating



Food is heated simultaneously from the top and bottom. For example, it is suitable for cakes, pastries, or cakes and casseroles in baking moulds. Cook with one tray only.

Suitable rack position will be displayed on screen.

Function table	Recommended temperature (°C)	Temperature range (°C)
Static	200	40-280
Static + Fan	175	40-280
Full grill	280	40-280
Grill	280	40-280
Bottom heating	180	40-220
Warm keeping	60	40-100

-  Maximum adjustable cooking time in modes except warm keeping is limited with 6 hours due to safety reasons. Program will be cancelled in case of power failure. You must reprogram the oven.
-  While making any adjustment, related symbols on the clock will flash.
-  Current time cannot be set while the oven is operating in any function, or if semi-automatic or full automatic programming is made on the oven.
-  Even if the oven is off, oven lamp lights up when the oven door is opened.

### Switching off the electric oven

Press On/Off key (14) for about 2 second to switch off the oven.

2. **Fan supported bottom/top heating**



Hot air heated by the bottom and top heaters is evenly distributed throughout the oven rapidly by means of the fan. Cook with one tray.

3. **Full grill+Fan**



Hot air heated by the full grill is distributed very fast in the oven by means of the fan. It is suitable for grilling large amount of meat.

- Put big or medium-sized portions in correct rack position under the grill heater for grilling.
- Set the temperature to maximum level.
- Turn the food after half of the grilling time.

4. **Full grill**



Large grill at the ceiling of the oven is in operation. It is suitable for grilling large amount of meat.

- Put big or medium-sized portions in correct rack position under the grill heater for grilling.
- Set the temperature to maximum level.
- Turn the food after half of the grilling time.

5. **Grill**

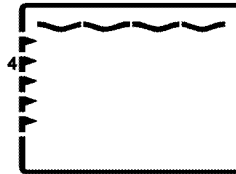

Small grill at the ceiling of the oven is in operation. Suitable for grilling and gratin dishes.

- Put small or medium-sized portions in correct shelf position under the grill heater for grilling.
- Set the temperature to maximum level.
- Turn the food after half of the grilling time.

6. **Bottom heating**

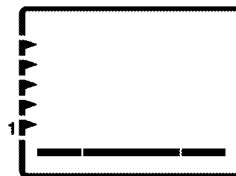

Only bottom heating is in operation. It is suitable for pizza and for subsequent browning of food from the bottom.

7. **Keep warm**

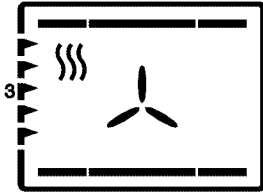

Used for keeping food at a temperature ready for serving for a long period of time.

8. **Operating with fan**



The oven is not heated. Only the fan (in the rear wall) is in operation. Frozen granular food is thawed slowly at room temperature and cooked food is cooled down.

9. **Pyrolysis - economy mode**

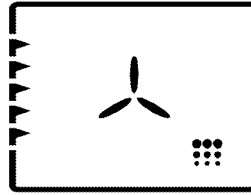

This function allows the oven to clean itself at a high temperature. It is recommended for lightly soiled ovens. Read the description in the cleaning section to use this function.

10. **Pyrolysis**

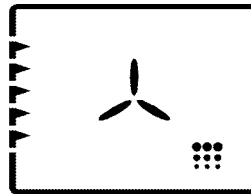

This function allows the oven to clean itself at a high temperature. Read the description in the cleaning section to use this function.

## How to operate the oven control unit

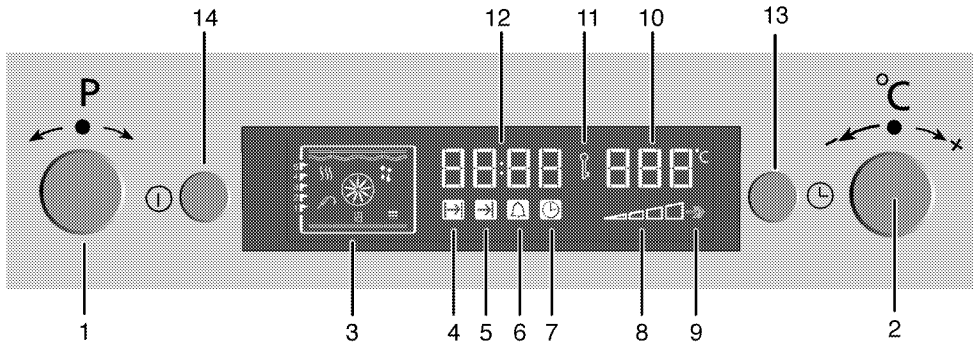

- 1 Program selection button
- 2 Temperature-Time Adjustment button
- 3 Function display
- 4 Cooking time symbol
- 5 End of cooking time symbol
- 6 Alarm symbol
- 7 Clock symbol
- 8 Oven Inner Temperature symbol
- 9 Booster (rapid pre-heating) indicator
- 10 Temperature Indicator field
- 11 Keylock symbol
- 12 Time Indicator Field
- 13 Menu button
- 14 On/Off button

### Enable semi-automatic operation

In this operation mode, you may adjust the time period during which the oven will operate (cook time).

1. Press On/Off button (14) to switch on the oven.
2. Twist the Program Selection knob (1) slightly to right or left to set the desired operating mode.

3. When the oven is switched on, press Menu button (13) with short intervals to activate the Cooking Time symbol (4).
  - » Cooking time symbol (4) remains lit after setting the cooking time.
4. Twist the Temperature-Time Adjustment knob (2) to "+" or "-" slightly to set the cooking time.
  - » The oven will be heated up to the set temperature and will maintain this temperature until the end of the cooking time you selected. The oven lamp is lit during the cooking process.
5. Put your dish into the oven.
6. Twist the Temperature-Time Adjustment knob (2) to "+" or "-" slightly to set the cooking temperature.
  - » All segments of the inner oven temperature symbol (8) will turn on when your oven reaches the set temperature.
7. After the cooking process is completed, "End" appears on the display and the alarm sounds.



8. Press Menu (13) or On/Off (14) button to silence the alarm.
  - » Alarm is silenced, oven is switched off automatically and the current time is displayed.

### Switch on fully automatic operation

In this operation mode you can adjust cooking time and end of cooking time.

1. Press On/Off button (14) to switch on the oven.
2. Twist the Program Selection knob (1) slightly to right or left to set the desired operating mode.
3. Press Menu button (13) with short intervals to activate the Cooking Time symbol (4).
4. Twist the Temperature-Time Adjustment knob (2) to "+" or "-" slightly to set the cooking time.
  - » Cooking Time symbol (4) remains lit after setting the cooking time.
5. Press Menu button (13) with short intervals to activate the End of Cooking Time symbol (5).
6. Twist the Temperature-Time Adjustment knob (2) to "+" or "-" slightly to set the end of cooking time.
  - » After setting the end of cooking time, End of Cooking Time symbol (5) remains lit.
7. Put your dish into the oven.
8. Twist the Temperature-Time Adjustment knob (2) to "+" or "-" slightly to set the cooking temperature.
  - » Oven timer automatically calculates the startup time for cooking by deducting the cooking time from the end of cooking time you have set. Selected operation mode is activated when the startup time of cooking has

come and the oven is heated up to the set temperature. It maintains this temperature until the end of cooking time. The oven lamp is lit during the cooking process.

-  All segments of the inner oven temperature symbol (8) will turn on when your oven reaches the set temperature.
9. After the cooking process is completed, **"End"** appears on the display and the alarm sounds.
10. Press Menu (13) or On/Off (14) button to silence the alarm.
  - » Alarm is silenced, oven is switched off automatically and the current time is displayed. Oven lamp turns off.

-  If you want to cancel the semi-automatic or automatic programming after you have set them, you need to reset the cooking time.

### Setting the booster (Quick Pre-heating)

Use Booster (Rapid Pre-heating) function to make the oven reach the desired temperature faster.

-  Booster can be set only when the oven is operating. Booster cannot be selected in defrosting and cleaning positions. Booster settings will be cancelled in case of power outage.

1. Press Menu button (2) with short intervals until Booster (Quick pre-heating) symbol (9) is activated.
  - » **"OFF"** will appear on the display.
2. Twist the Temperature-Time Adjustment knob (2) to "+" slightly to activate the Booster function.

- » Once the Booster is activated, 'On' will appear on the display and the Booster symbol will remain lit.
  - » Booster symbol disappears as soon as the oven reaches the desired temperature and oven resumes operating in the function it was in before the Booster function.
3. To deactivate the Booster function, press Menu button (13) with short intervals until Booster symbol (9) is activated.
    - » "On" will appear on the display.
  4. Twist the Temperature-Time Adjustment knob (2) to "-" slightly to deactivate the Booster function.
    - » "OFF" will appear on the display.

## Using the keylock

### Activating the keylock

You can prevent oven from being used by activating the Keylock function.

-  Keylock can be used either when the oven is operating or not. Oven can be switched off by keeping the On/Off button (14) pressed for 2 seconds even when the keylock is activated while the oven is operating.

1. Press the key (13) with short intervals until the Keylock symbol (11) is activated.
  - » "OFF" will appear on the display.

2. Turn the knob (2) to '+' slightly to activate the keylock.
  - » Once the keylock is activated, "On" appears on the display and the Keylock symbol remains lit.

### Deactivate the keylock

1. Press the key (13) to activate the Keylock symbol (11).
  - » "On" will appear on the display.
2. Turn the knob (2) to '-' slightly to deactivate the keylock.
  - » Once the keylock is deactivated, "OFF" appears on the display and Keylock symbol (11) disappears.

-  Oven keys are not functional when the Keylock function is activated. Keylock settings will not be cancelled in case of power outage.

## Using the clock as an alarm

You can use the clock of the product for any warning or reminder apart from the cooking programme.

The alarm clock has no influence on the functions of the oven. It is only used as a warning. For example, this is useful when you want to turn food in the oven at a certain point of time. Alarm clock will give a signal once the time you set is over.

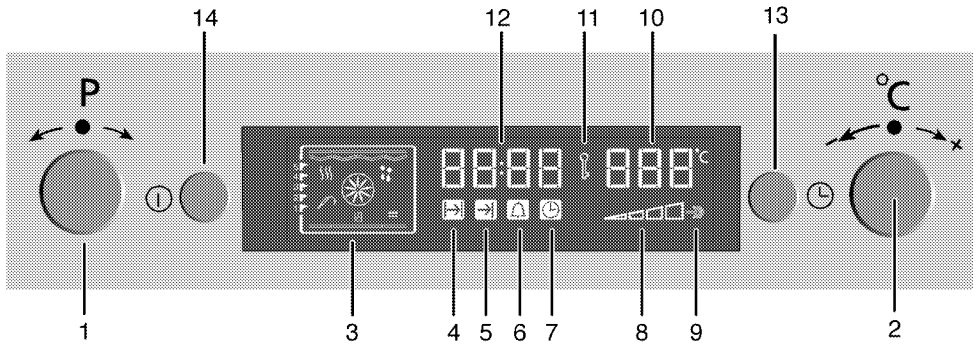

- 1 Program selection button
- 2 Temperature-Time Adjustment button
- 3 Function display
- 4 Cooking time symbol
- 5 End of cooking time symbol
- 6 Alarm symbol
- 7 Clock symbol
- 8 Oven Inner Temperature symbol
- 9 Booster (rapid pre-heating) indicator
- 10 Temperature Indicator field
- 11 Keylock symbol
- 12 Time Indicator Field
- 13 Menu button
- 14 On/Off button

### Using the clock as an alarm

**i** The alarm clock has no influence on the functions of the oven. It is only used as a warning. For example, this is useful when you want to turn food in the oven at a certain point of time. Alarm clock will give a signal once the time you set is over.

**i** Maximum alarm time can be 23 hours and 59 minutes.

**i** Alarm clock can be used either when the oven is operating or not.

### To set the alarm

1. Press Menu button (13) with short intervals until Alarm symbol (6) is activated.
2. Twist the Temperature-Time Adjustment knob (2) to "+" or "-" slightly to set the alarm time.
  - » Alarm symbol remains lit after setting the alarm time.
3. After the alarm time is finished, Alarm symbol will start flashing and an alarm signal is heard.
4. Press any key to stop the alarm.

### If you want to cancel the alarm:















1. Press Menu button (13) with short intervals until Alarm symbol (6) is activated.
2. Twist Temperature-Time Adjustment knob (2) to "-" slightly until "00:00" appears on the display.

## Cooking times table

 The timings in this chart are meant as a guide. Timings may vary due to temperature of food, thickness, type and your own preference of cooking.

## Baking and roasting

 1st rack of the oven is the **bottom** rack.

Dish	Cooking level number		Rack position	Temperature (°C)	Cooking time (approx. in min.)
**Cakes in tray	One level		3	175	25 ... 30
**Cakes in mould	One level		2	175	40 ... 50
**Cakes in cooking paper	One level		3	175	25 ... 30
**Sponge cake	One level		3	200	5 ... 10
**Cookie	One level		3	175	25 ... 30
**Dough pastry	One level		2	200	30 ... 40
**Rich pastry	One level		2	200	25 ... 35
**Leaven	One level		2	200	35 ... 45
**Lasagna	One level		2 - 3	200	30 ... 40
**Pizza	One level		2	200 ... 220	15 ... 20
Beef steak (whole) / Roast	One level		3	25 min. 250/max, then 180 ... 190	100 ... 120
Leg of Lamb (casserole)	One level		3	25 min. 220 then 180 ... 190	70 ... 90
Roasted chicken	One level		2	15 min. 250/max, then 180 ... 190	55 ... 65
Turkey (5.5 kg)	One level		1	25 min. 250/max, then 180 ... 190	150 ... 210
Fish	One level		3	200	20 ... 30

(\*\*) In a cooking that requires preheating, preheat at the beginning of cooking until the oven temperature symbol **(8)** attains the last level.

### Tips for baking cake

- If the cake is too dry, increase the temperature by 10 and decrease the cooking time.
- If the cake is wet, use less liquid or lower the temperature by 10°C.
- If the cake is too dark on top, place it on a lower rack, lower the temperature and increase the cooking time.
- If cooked well on the inside but sticky on the outside use less

liquid, lower the temperature and increase the cooking time.

### Tips for baking pastry

- If the pastry is too dry, increase the temperature by 10 and decrease the cooking time. Dampen the layers of dough with a sauce composed of milk, oil, egg and yoghurt.
- If the pastry takes too long to bake, pay care that the thickness of the pastry you have prepared does not exceed the depth of the tray.
- If the upper side of the pastry gets browned, but the lower part is not cooked, make sure that the amount of sauce you have used

for the pastry is not too much at the bottom of the pastry. Try to scatter the sauce equally between the dough layers and on the top of pastry for an even browning.

- i** Cook the pastry in accordance with the mode and temperature given in the cooking table. If the bottom part is still not browned enough, place it on one lower rack next time.

### Tips for cooking vegetables

- If the vegetable dish runs out of juice and gets too dry, cook it in a pan with a lid instead of a tray. Closed vessels will preserve the juice of the dish.
- If a vegetable dish does not get cooked, boil the vegetables beforehand or prepare them like canned food and put in the oven.

### How to operate the grill

- ⚠** Close oven door during grilling. Hot surfaces may cause burns!

### Switching on the grill

1. Press On/Off key (14) for about 1 second to switch on the oven.
2. Twist the Program Selection knob (1) slightly to right or left to set the grill function.
3. Twist the Temperature-Time Adjustment knob (2) to "+" or "-"

### Cooking times table for grilling

#### Grilling with electric grill

Food	Insertion level	Grilling time (approx.)
Fish	4...5	20...25 min. #
Sliced chicken	4...5	25...35 min.
Lamb chops	4...5	20...25 min.
Roast beef	4...5	25...30 min. #
Veal chops	4...5	25...30 min. #
Toast bread	4	1...2 min.

# depending on thickness

slightly to set the desired temperature.

### Switching off the grill

1. Press On/Off key (14) for about 2 second to switch off the oven.

### Rack positions

Grill performance will decrease if the wire grill stands against rear part of the oven. Slide your wire grill to the front section of the rack and settle it with the help of the door in order to obtain the best grill performance.

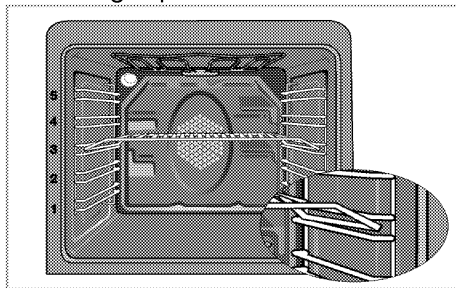

- i** Do not use the top rack for grilling.
- i** Foods that are not suitable for grilling carry the risk of fire. Only grill food which is suitable for intensive grilling heat. Do not place the food too far in the back of the grill. This is the hottest area and fatty food may catch fire.

## 6 Maintenance and care

### General information

Service life of the product will extend and the possibility of problems will decrease if the product is cleaned at regular intervals.

- ⚠ Disconnect the product from mains supply before starting maintenance and cleaning works. There is the risk of electric shock!
- ⚠ Allow the product to cool down before you clean it. Hot surfaces may cause burns!
- Clean the product thoroughly after each use. In this way it will be possible to remove cooking residues more easily, thus avoiding these from burning the next time the appliance is used.
- No special cleaning agents are required for cleaning the product. Use warm water with washing liquid, a soft cloth or sponge to clean the product and wipe it with a dry cloth.
- Always ensure any excess liquid is thoroughly wiped off after cleaning and any spillage is immediately wiped dry.
- Do not use cleaning agents that contain acid or chloride to clean the stainless or inox surfaces and the handle. Use a soft cloth with a liquid detergent (not abrasive) to wipe those parts clean, paying attention to sweep in one direction.

- ⓘ The surface might get damaged by some detergents or cleaning materials. Do not use aggressive detergents, cleaning powders/creams or any sharp objects during cleaning.
- ⓘ Do not use steam cleaners for cleaning.

### Cleaning the control panel

Clean the control panel and control knobs with a damp cloth and wipe them dry.

- ⓘ Do not remove the control buttons/knobs to clean the control panel. Control panel may get damaged!

### Cleaning the oven

#### To clean the side wall

1. Remove the front section of the side rack by pulling it in the opposite direction of the side wall.
2. Remove the side rack completely by pulling it towards you.

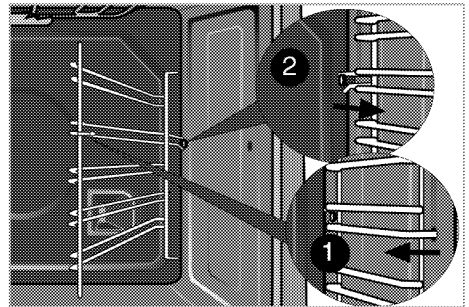

## Pyrolytic self-cleaning

 Hot surfaces cause burns!  
Do not touch the product during self cleaning step and keep children away from it. Keep at least 30 minutes before removing the remnants.

The oven is equipped with pyrolytic self-cleaning. The oven is heated to approx. 480 °C and existing dirt is burned to ashes. A strong smoke development may arise. Provide for good ventilation. The pyrolysis should be used after approx. every 10th oven usage.



1. Remove all accessories from the oven. In models with side rack; do not forget to take out the side racks.
2. Before the cleaning cycle, remove dirt from exterior surfaces and oven interior with a damp cloth.

 Do not clean the door gasket. Fiberglass gasket is highly sensitive and can get damaged easily.

In case of a damage on the oven door gasket, replace with the new one from the authorized service.

1. "Pyrolysis"  Select the pyrolytic function (self-cleaning).



 **eco** It is advised to use economic cleaning function if the oven does not have too much dirt.

If this function is used for heavy dirt, there won't be sufficient cleaning. For such cases, pyrolysis function  should be applied after economic cleaning  **eco** cycle finished.

» The self-cleaning time appears in the display. This duration can not be adjusted.

» The end of self cleaning cycle can be adjusted.

 The health of some birds is extremely sensitive to the fumes given off during the Self-Cleaning cycle. Always move birds to another closed and well ventilated room. Keep the kitchen well-ventilated during the Self-Cleaning cycle.

1. Oven door cannot be opened and lock symbol  appears on the time display during self cleaning. It remains locked for a while after the pyrolysis function ends. Do not force the door lock with handle until lock symbol  disappears.
2. After a clean cycle, remove soil deposits with vinegar water.

## Clean oven door

To clean the oven door, use warm water with washing liquid, a soft cloth or sponge to clean the product and wipe it with a dry cloth.

 Don't use any harsh abrasive cleaners or sharp metal scrapers for cleaning the oven door. They could scratch the surface and destroy the glass.

## Removing the oven door

1. Open the front door (1).
2. Open the clips at the hinge housing (2) on the right and left hand sides of the front door by pressing them down as illustrated in the figure.

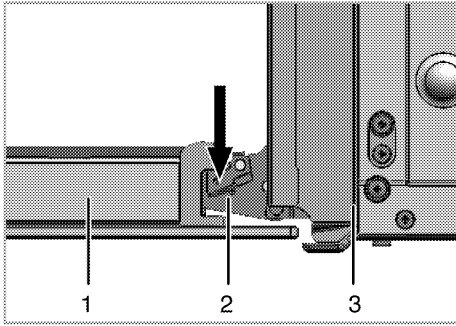

- 1 Front door
- 2 Hinge
- 3 Oven

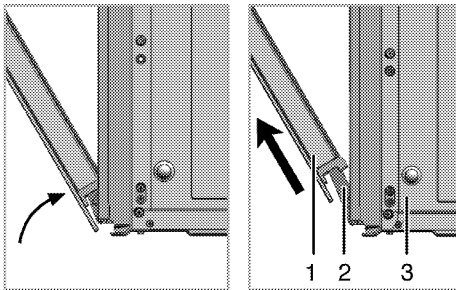

- 3. Move the front door to half-way.
- 4. Remove the front door by pulling it upwards to release it from the right and left hinges.

**i** Steps carried out during removing process should be performed in reverse order to install the door. Do not forget to close the clips at the hinge housing when reinstalling the door.

## Removing the door inner glass

The inner glass panel of the oven door can be removed for cleaning.

- 1. Open the oven door.

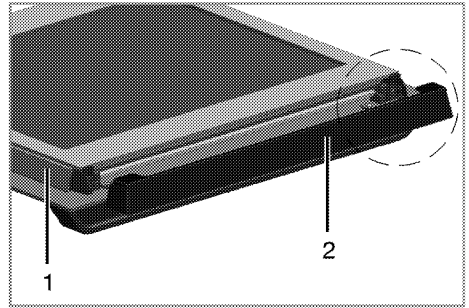

- 1 Plastic part
  - 2 Frame
2. Pull towards yourself and remove the plastic part installed to upper section of the front door (1).

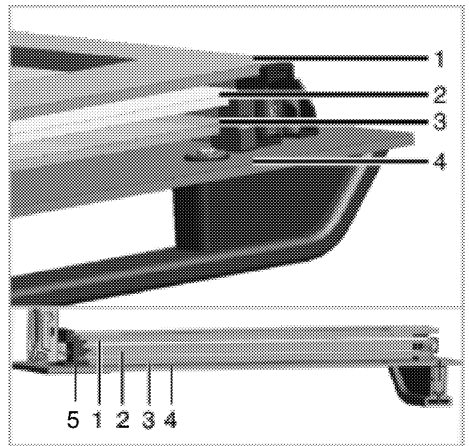

- 1 Innermost glass panel
- 2 Second inner glass panel
- 3 Third inner glass panel
- 4 Outer glass panel
- 5 Plastic glass panel slot-Lower



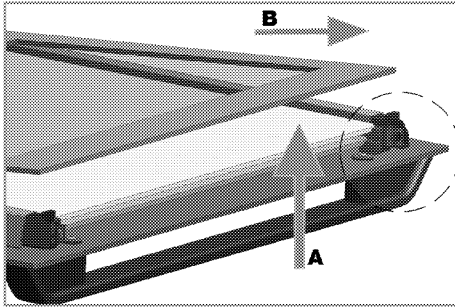

As illustrated in figure, raise the innermost glass panel slightly in direction **A** and pull it out in direction **B**.

4. Repeat the same procedure to remove the second and third glass panels.

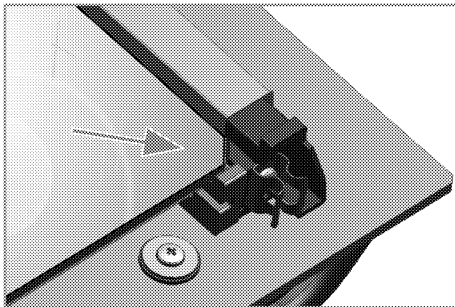

The first step to regroup the door is reinstalling second and third inner glass panels (2, 3).

As illustrated in figure, place the chamfered corner of the glass panel so that it will rest in the chamfered corner of the plastic slot.

Since the second and third inner glass panels are interchangeable, their order of installation is not important.

When installing the innermost glass panel (1), make sure that the printed side of the panel faces towards the second glass panel.

It is important to seat lower corners of all inner glass panels into the lower plastic slots (5).

Push the plastic part towards the frame until you hear a "click".

- i** All glass panels must be reinstalled after cleaning.

## Replacing the oven lamp

- ⚠** Before replacing the oven lamp, make sure that the product is disconnected from mains and cooled down in order to avoid the risk of an electrical shock. Hot surfaces may cause burns!

- i** The oven lamp is a special electric light bulb that can resist up to 300 °C. See *Technical specifications, page 5* for details. Oven lamps can be obtained from Authorised Service Agents.

- i** Position of lamp might vary from the figure.

### If your oven is equipped with a round lamp:

1. Disconnect the product from mains.
2. Turn the glass cover counter clockwise to remove it.

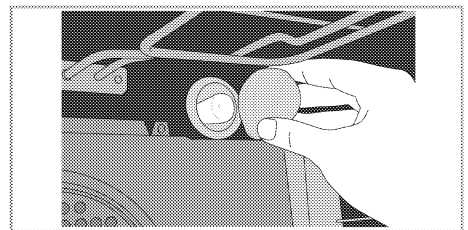

3. Remove the oven lamp by turning it counter clockwise and replace it with the new one.
4. Install the glass cover.

## 7 Troubleshooting

### Oven emits steam when it is in use.

 It is normal that steam escapes during operation. This is not a fault.

### Product emits metal noises while heating and cooling.

 When the metal parts are heated, they may expand and cause noise. This is not a fault.

### Product does not operate.

- The mains fuse is defective or has tripped. >>> *Check fuses in the fuse box. If necessary, replace or reset them.*
- Product is not plugged into the (grounded) socket. >>> *Check the plug connection.*
- Buttons/knobs/keys on the control panel do not function. >>> *Keylock may be enabled. Please disable it. (See. Using the keylock, page 25 )*

### Oven light does not work.

- Oven lamp is defective. >>> *Replace oven lamp.*
- Power is cut. >>> *Check if there is power. Check the fuses in the fuse box. If necessary, replace or reset the fuses.*

### Oven does not heat.

- Function and/or Temperature are not set. >>> *Set the function and the temperature with the Function and/or Temperature knob/key.*
- Power is cut. >>> *Check if there is power. Check the fuses in the fuse box. If necessary, replace or reset the fuses.*

 Consult the Authorised Service Agent or the dealer where you have purchased the product if you can not remedy the trouble although you have implemented the instructions in this section. Never attempt to repair a defective product yourself.



Printed in Turkey  
Part no: 285.4413.11  
Rev: AA/ 30.11.2011

## Free Manuals Download Website

<http://myh66.com>

<http://usermanuals.us>

<http://www.somanuals.com>

<http://www.4manuals.cc>

<http://www.manual-lib.com>

<http://www.404manual.com>

<http://www.luxmanual.com>

<http://aubethermostatmanual.com>

Golf course search by state

<http://golfingnear.com>

Email search by domain

<http://emailbydomain.com>

Auto manuals search

<http://auto.somanuals.com>

TV manuals search

<http://tv.somanuals.com>