

BEKO

*installation, operation &
food storage instructions*

ASD241B

ASD241S

ASD241X

ASL141B

ASL141S

ASL141W

ASL141X



get the **best** from your new refrigerator

Please read this manual first!

Dear Customer,

We hope that your product, which has been produced in modern plants and checked under the most meticulous quality control procedures, will provide you with effective service.

For this, we recommend you to carefully read the entire manual of your product before using it and keep it at hand for future references.





The user manual will help you use the product in a fast and safe way.

- Read the manual before installing and operating your product.
- Follow the instructions, especially those for safety.
- Keep the manual in an easily accessible place as you may need it later.
- Besides, read also the other documents provided with your product.

Please note that this manual may be valid for other models as well.

Symbols and their descriptions

This instruction manual contains the following symbols:

	Important information or useful usage tips.
	Warning against dangerous conditions for life and property.
	Warning against electric voltage.
	Packaging materials of the product are manufactured from recyclable materials in accordance with our National Environment Regulations.

1 Important instructions for safety and environment	3	5 Operating the product	12
2 Your refrigerator	6	5.1. Indicator panel	12
3 Installation	7	5.2. Neo-Frost Cooling System	15
3.1. Appropriate installation location	7	5.3. Freezing fresh food	15
3.2. Installing the plastic wedges.	7	5.4. Recommendations for preserving the frozen food	16
3.3. Electrical connection	8	5.5. Placing the food.	16
3.4. Adjusting the feet.	8	5.6. Deep-freeze information.	16
3.5. Illumination lamp	8	5.7. Icematic and ice storage container	17
3.6. Door open warning.	9	5.8. Ice making.	17
3.7. Transportation of the product	9	5.9. Chiller compartment.	18
4 Preparation	10	5.10. Butter & cheese section	18
4.1. Things to be done for energy saving	10	5.11. Egg section	18
4.2. Efficient operation	10	5.12. Crisper	18
4.3. Recommendations on the fridge compartment.	10	5.13. Odour filter	19
4.4. Initial use.	10	5.14. Drip tray	19
		5.15. Water Dispenser	20
		5.16. Using the water dispenser	20
		5.17. Filling the water dispenser's tank	20
		5.18. Cleaning the water tank	21
		6 Maintenance and cleaning	22
		6.1. Avoiding bad odours.	22
		6.2. Protecting the plastic surfaces	22
		7 Troubleshooting	23

1 Important instructions for safety and environment

- Do not connect your appliance to the electricity supply until all packing and transit protectors have been removed.
- If transported horizontally leave to stand upright for at least 4 hours before switching on to allow compressor oil to settle
- If you are discarding an old refrigerator with a lock or latch fitted to the door, disable the lock/latch, ensure that it is left in a safe condition to prevent the entrapment of young children.
- This fridge/freezer must only be used for its intended purpose i.e the storing and freezing of edible foodstuff.
- Do not dispose of the appliance on a fire. At **BEKO**, the care and protection of our environment is an ongoing commitment. This appliance which is among the latest range introduced is particularly environment friendly. Your appliance contains non CFC / HFC natural substances in the cooling system (Called R600a) and in the insulation (Called cyclopentane) which are potentially flammable if exposed to fire. Therefore, take care not to damage, the cooling circuit / pipes of the appliance in transportation and in use. In case of damage do not expose the appliance to fire or potential ignition source and immediately ventilate the room where the appliance is situated.
- We suggest you contact your local authority for disposal information and facilities available.
- See Installation Instructions on page 8 for information on suitable location.
- To obtain the best possible performance and trouble free operation from your appliance it is very important to carefully read these instructions.
- On delivery, check to make sure that the product is not damaged and that all the parts and accessories are in perfect condition.
- Ensure that the plug remains readily accessible. Do not use multiple adapter or extension cable.
- Failure to observe these instructions may invalidate your right to free service during the guarantee period.
- Keep ventilation openings, in the appliance enclosure or in the built-in structure, clear of obstruction.
- Do not use mechanical devices or other means to accelerate the defrosting process, other than those recommended by the manufacturer.
- Do not damage the refrigerant circuit.
- Do not use electrical appliances inside the food storage compartments of the appliance, unless they are of the type recommended by the manufacturer.
- We suggest you keep these instructions in a safe place for easy reference.
- This appliance can be used by children aged from 8 years and above and persons with reduced physical, sensory or mental capabilities or lack of experience and knowledge if they have been given supervision or instruction concerning use of the appliance in a safe way and understand the hazards involved. Children shall not play with the appliance. Cleaning and user maintenance shall not be made by children without supervision.
- Children should be supervised to ensure that they do not play with the appliance.

Electrical requirements

Before you insert the plug into the wall socket make sure that the voltage and the frequency shown on the rating plate inside the appliance corresponds to your electricity supply.

Rating label is on the left hand side of fridge inner liner.

Important instructions for safety and environment

We recommend that this appliance be connected to the mains supply via a suitable switched and fused socket. The appliance must be positioned so that the plug is accessible.

Should the mains lead of the appliance become damaged or should it need replacing at any time, it must be replaced by a special purpose made mains lead which can only be obtained from a **BEKO** authorised service agent.

Warning! This appliance must be earthed

If the fitted moulded plug is not suitable for your socket, then the plug should be cut off and an appropriate plug fitted. Destroy the old plug which is cut off as a plug with bared cord could cause a shock hazard if inserted into a socket elsewhere in the house.

The moulded plug on this appliance incorporates a 13 A fuse. Should the fuse need to be replaced an ASTABEAB approved BS 1362 fuse of the same rating must be used. Do not forget to refit the fuse cover. In the event of losing the fuse cover the plug must not be used until a replacement fuse cover has been fitted.

Colour of the replacement fuse cover must be the same colour as that visible on the pin face of the plug. Fuse covers are available from any good electrical store.

Important! Fitting A Different Plug

As the colours of the wires in the mains lead of this appliance may not correspond with the coloured markings identifying the terminals in your plug proceed as follows: (See diagram).

1. Connect the green-yellow or green (Earth) wire to the terminal in the plug marked 'E' or with the symbol \oplus or coloured green and yellow or green.
2. Connect the blue (Neutral) wire to the terminal in the plug marked 'N' or coloured black.
3. Connect the brown (Live) wire to the terminal in the plug marked 'L' or coloured red.

With alternative plugs a 13 A fuse must be fitted either in the plug or adaptor or in the main fuse box. If in doubt contact a qualified electrician.

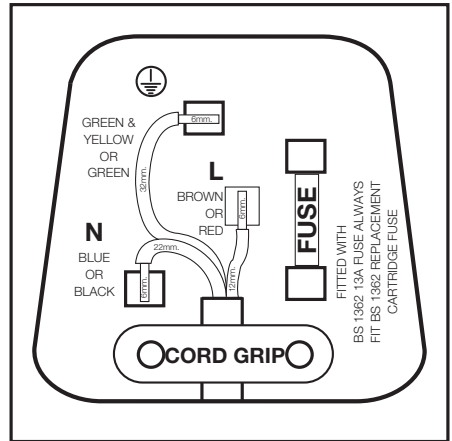

Important instructions for safety and environment

Energy saving tips

1. Ensure your appliance is installed in a well ventilated area.
2. Ensure the time between buying chilled/frozen food and placing them in your appliance is kept at minimum, particularly in summer. We recommend you use a cool bag or a special carrier bag to carry perishable food.
3. Do not leave the door (s) of your appliance open longer than necessary and ensure they are closed properly after each opening.
4. Defrost frozen food in the fridge compartment, so that frozen food acts as an ice pack to assist cooling in the fridge.
5. Energy consumption of this appliance is measured while freezer compartment is loaded without use of top shelf lid and the drawers except the bottom drawer. It is advised that freezer compartment is loaded without use of drawers except the bottom drawer in order to achieve maximum loading capacity.

Compliance with WEEE Directive and Disposing of the Waste Product:

This product complies with EU WEEE Directive (2012/19/EU). This product bears a classification symbol for waste electrical and electronic equipment (WEEE). This product has been manufactured with high quality parts and materials which can be reused and are suitable for recycling. Do not dispose of the waste product with normal domestic and other wastes at the end of its service life. Take it to the collection center for the recycling of electrical and electronic equipment. Please consult your local authorities to learn about these collection centers.

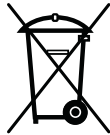

Compliance with rohs directive:

The product you have purchased complies with EU RoHS Directive (2011/65/EU). It does not contain harmful and prohibited materials specified in the Directive.

Package information

Packaging materials of the product are manufactured from recyclable materials in accordance with our National Environment Regulations. Do not dispose of the packaging materials together with the domestic or other wastes. Take them to the packaging material collection points designated by the local authorities.

2 Your refrigerator

Congratulations on your choice of a BEKO quality Appliance which has been designed to give you service for many years.

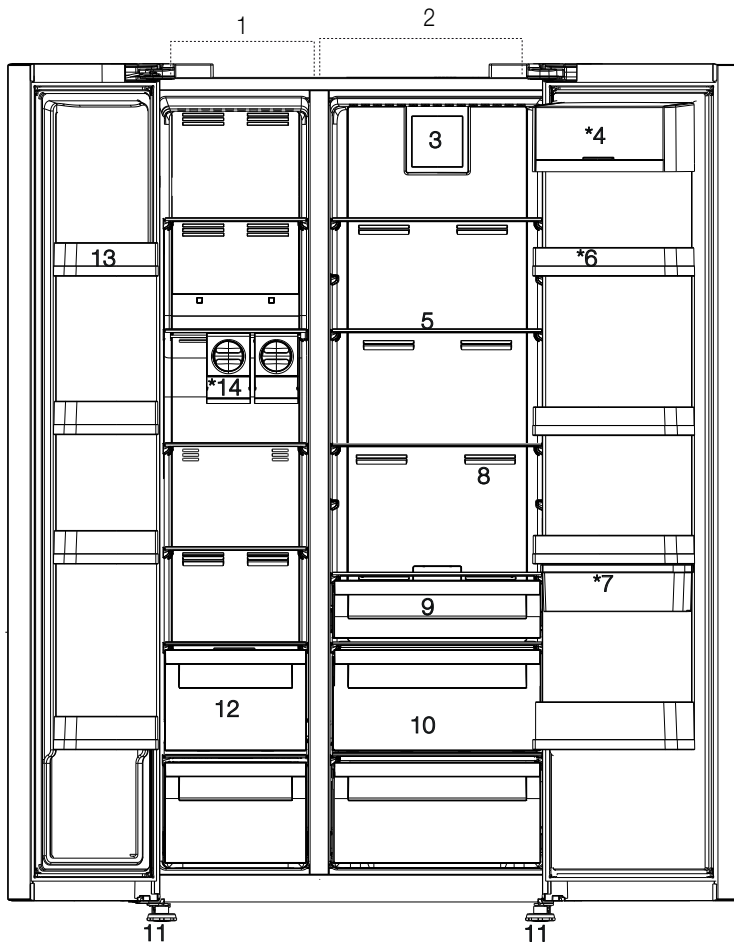

- | | |
|--|--------------------------------------|
| 1- Freezer compartment | 8- Odour filter |
| 2- Fridge compartment | 9- Chiller compartment |
| 3- Fan | 10- Crisper compartment |
| 4- Butter-cheese compartments | 11- Adjustable feet |
| 5- Glass shelves | 12- Frozen food storage compartments |
| 6- Fridge compartment door racks and egg compartment | 13- Freezer compartment door racks |
| 7- Water dispenser tank | 14- Ice makers |



*Optional: Figures in this user manual are schematic and may not match the product exactly. If the relevant parts are not available in the product you purchased, it applies to other models.

3 Installation

Always have the repair procedures carried out by the Authorised Service Agent. Manufacturer shall not be held liable for damages that may arise from procedures carried out by unauthorised persons. To make the product ready for use, make sure that the electricity installation is appropriate before calling the Authorised Service Agent. If not, call a qualified electrician to have any necessary arrangements carried out.

	Preparation of the location and electrical installation at the place of installation is under customer's responsibility.
	Product must not be plugged in during installation. Otherwise, there is the risk of death or serious injury!
	WARNING: Manufacturer shall not be held liable for damages that may arise from procedures carried out by unauthorised persons.
	WARNING: Prior to installation, visually check if the product has any defects on it. If so, do not have it installed. Damaged products cause risks for your safety.
	Make sure that the power cable is not pinched or crushed while pushing the product into its place after installation or cleaning procedures.

3.1. Appropriate installation location



WARNING: If the door of the room where the product will be placed is too small for the product to pass, then the product's doors can removed and the product turned aside to pass it through.

- Choose a place at where you would use the product comfortably.
- Install the product at least 30 cm away from heat sources such as hobs, ovens, heaters and stoves. Product must not be subjected to direct sun light and kept in humid places after installation.
- Appropriate air ventilation must be provided around your product in order to achieve an efficient operation. If the product is to be placed in a recess in the wall, pay attention to leave at least 5 cm distance with the ceiling and side walls.
- Do not place the product on the materials such as rugs or carpets.
- Place the product on an even floor surface to prevent jolts.
- Do not install the product in places where the temperature falls below 5°C.



If two coolers are to be installed side by side, there should be at least 4 cm distance between them.

3.2. Installing the plastic wedges

Plastic wedges are used to create the distance for the air circulation between the product and the rear wall. Insert the 2 plastic wedges onto the rear ventilation cover as illustrated in the figure. To install the wedges, remove the screws on the product and use the screws given in the same pouch with the wedges.

Installation

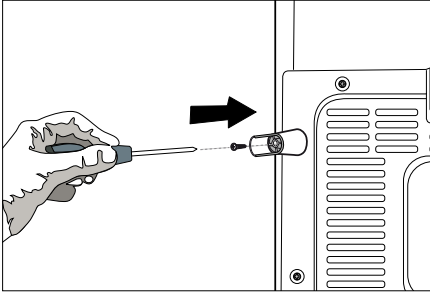
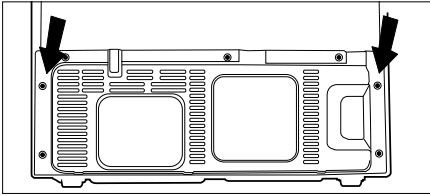

3.3. Electrical connection

Connect the product to a grounded outlet protected by a fuse complying with the values in the rating plate. Our company shall not be liable for any damages that will arise when the product is used without grounding in accordance with the local regulations.

- Electrical connection must comply with national regulations.
- Power cable plug must be within easy reach after installation.
- The voltage and allowed fuse or breaker protection are specified in the Rating Plate which is affixed to interior of the product. If the current value of the fuse or breaker in the house does not comply with the value in the rating plate, have a qualified electrician install a suitable fuse.

- The specified voltage must be equal to your mains voltage.
- Do not make connections via extension cables or multi-plugs.



WARNING: Damaged power cable must be replaced by the Authorised Service Agents.



WARNING: If the product has a failure, it should not be operated unless it is repaired by the Authorised Service Agent! There is the risk of electric shock!

3.4. Adjusting the feet

If the product stands unbalanced after installation adjust the feet. Taking help from someone to slightly lift the refrigerator will facilitate this process.



WARNING: First unplug the product. Product must not be plugged in when adjusting the feet. There is the risk of electric shock!

Turn the front feet to balance the product. The corner where the foot exists is lowered when you turn in the direction of arrow and raised when you turn it in the opposite direction.

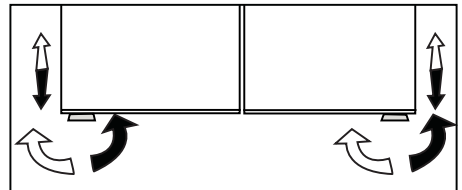

3.5. Illumination lamp

Do not attempt to repair yourself but call the Authorised Service Agent if the LED illumination lamps do not go on or are out of order.



3.6. Door open warning

(This feature is optional)

An audio warning signal will be given when the door of your product is left open for 1 minute. This warning will be muted when the door is closed or any of the display buttons (if any) are pressed.

3.7. Transportation of the product

1. Unplug the product before transporting it.
2. Remove any other connections.
3. Secure the shelves, accessories, crisper and etc. in the refrigerator by adhesive tape before repackaging it.

	Packaging must be adequate and the rules of transportation printed on the package must be followed.
	Original packaging and foam materials should be kept for future transportations.
	WARNING: Packaging materials are dangerous for the children. Keep packaging materials in a safe place away from reach of the children.

4 Preparation

4.1. Things to be done for energy saving



Connecting the product to electric energy saving systems is risky as it may restrict operation of the product.

- Do not leave the doors of your refrigerator open for a long time.
- Do not put hot food or drinks in your refrigerator.
- Do not overload the refrigerator. Cooling capacity will fall when the air circulation inside is hindered.
- Do not place the refrigerator in places subject to direct sunlight. Install the product at least 30 cm away from heat sources such as hobs, ovens, heaters and stoves.
- Store your food in refrigerator in closed containers.
- Thawing frozen food in fridge compartment will both provide energy saving and preserve the food quality.



The ambient temperature of the room where you install the refrigerator should at least be 5°C. Operating your refrigerator under cooler conditions than this is not recommended.



Inside of your refrigerator must be cleaned.



If two coolers are to be installed side by side, there should be at least 4 cm distance between them.

4.2. Efficient operation

Specified energy consumption value of your refrigerator is determined under maximum load by removing the freezer compartment upper rack and while other racks and two bottom drawers are in place. There is no harm to remove a shelf or drawer to accommodate the shapes and size of food to be frozen.

4.3. Recommendations on the fridge compartment

- Do not allow the food to touch the temperature sensor in fridge compartment. To allow the fridge compartment to keep its ideal storage temperature, sensor must not be hindered by food.
- Do not put hot food and beverages inside the product.

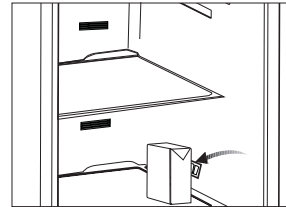
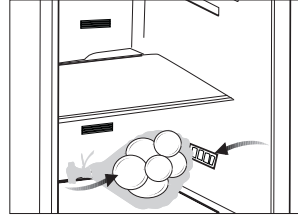

4.4. Initial use

Before starting to use the product, check that all preparations are made in accordance with the instructions in sections "Important instructions for safety and environment" and "Installation".

- Clean the interior of the refrigerator as recommended in the "Maintenance and cleaning" section. Check that inside of it is dry before operating it.
- Plug the refrigerator into the grounded wall outlet. When the door is opened the interior illumination will turn on.

Preparation

- Run the refrigerator without putting any food for 6 hours and do not open its door unless absolutely necessary.



You will hear a noise when the compressor starts up. The liquids and gases sealed within the refrigeration system may also give rise to noise, even if the compressor is not running and this is quite normal.



Front edges of the refrigerator may feel warm. This is normal. These areas are designed to be warm to avoid condensation.

5 Operating the product

5.1. Indicator panel

Indicator panels may vary according to the product model.

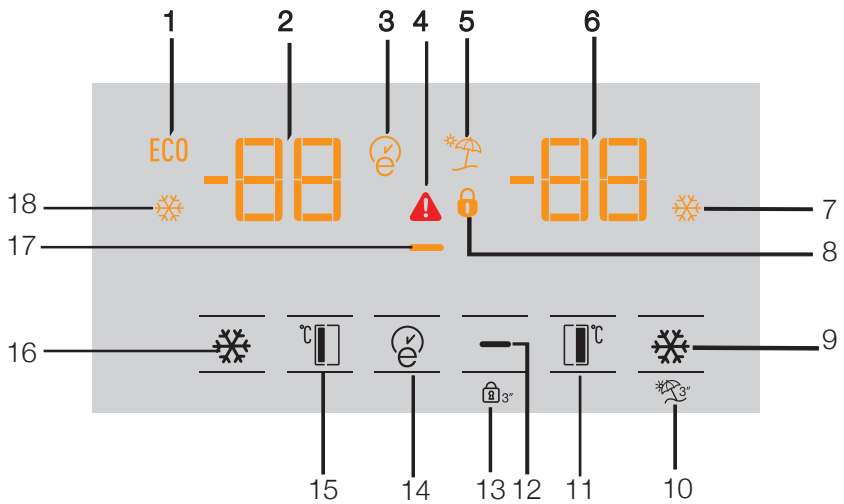

- 1- Economic usage indicator
- 2- Freezer compartment setting indicator
- 3- Eco fuzzy indicator
- 4- High temperature/ error warning indicator
- 5- Vacation function indicator
- 6- Fridge compartment temperature setting indicator
- 7- Quick cooling indicator
- 8- Key lock indicator
- 9- Quick cooling function button
- 10- Vacation function button
- 11- Fridge setting function button
- 12- Energy saving function (display off) button
- 13- Key lock button
- 14- Eco fuzzy button
- 15- Freezer compartment setting button
- 16- Quick freeze function button
- 17- Energy saving indicator
- 18- Quick freeze indicator



***Optional:** Figures in this user manual are schematic and may not match the product exactly. If the subject parts are not included in the product you have purchased, then those parts are valid for other models.

Operating the product

1. Economic usage indicator:

This symbol is illuminated when the freezer compartment is set to -18°C as the most economical setting value. Economic usage indicator is turned off when quick cooling or quick freeze functions are selected.

2. Freezer compartment setting indicator

Indicates the temperature set for the Freezer Compartment.

3. Eco fuzzy indicator:

This indicator is illuminated after 6 hours when eco fuzzy is activated.

4. High temperature/ error warning indicator

This light comes on during high temperature failures and error warnings. Please refer to "remedies advised for troubleshooting" section on your manual if you observe that this light is illuminated.

5. Vacation function indicator

Indicates that vacation is activated. When the vacation function is activated, "- -" is displayed on the fridge compartment temperature indicator and no active cooling is performed on the fridge compartment. It is not suitable to keep the food in the fridge compartment when this function is activated. The freezer will continue to operate to the set temperature. To cancel this function press **vacation function** button again.

6. Fridge compartment temperature setting indicator:

Indicates the temperature set for the Fridge Compartment.

7. Quick cooling indicator:

This symbol is illuminated when the Quick cooling function is on.

8. Key lock indicator

Use this function if you want to prevent changing of the temperature setting of the refrigerator. To activate this function press **key lock** button again.

9. Quick cooling function button

Quick cooling indicator is illuminated when quick cooling function is activated and fridge compartment temperature indicator is displayed as 1. To cancel this function press Quick cooling button again. Quick cooling indicator will turn off and refrigerator will return to its normal settings. Quick cooling function is cancelled automatically in 1 hour if you do not cancel it before. If you want to cool large amounts of fresh food, press the Quick cooling button before putting the food into the fridge compartment.

10. Vacation function button

Indicates that vacation is activated.

11. Fridge setting function button:

This function allows you to make the fridge compartment temperature setting. Press this button to set the temperature of the fridge compartment to 8,7,6,5,4,3,2 and 1 respectively.

12. Energy saving function (display off) button:

Energy saving symbol is illuminated and Energy saving function is activated when you press this button. When energy saving function is activated, all symbols on the display other than energy saving symbol will turn off. When the Energy Saving function is activated, if any button is pressed or the door is opened, energy saving function will be cancelled and the symbols on display will return to normal. Energy saving symbol is turned off and energy saving function is deactivated when you press this button again.

13. Key lock button:

Press key lock button simultaneously for 3 seconds. Key lock icon will light up and key lock mode will be activated. Buttons will not function if the Key lock mode is active. Press key lock button simultaneously for 3 seconds again. Key lock icon will turn off and the key lock mode will be exited.

Operating the product

14. Eco fuzzy button:

Press and hold eco fuzzy button for 3 seconds to activate eco fuzzy function. Refrigerator will start operating in the most economic mode at least 6 hours later and the economic usage indicator will turn on when the function is active. Press and hold eco fuzzy function button for 3 seconds to deactivate eco fuzzy function.

15. Freezer compartment setting button:

This function allows you to make the freezer compartment temperature setting. Press this button to set the temperature of the freezer compartment to -18, -19, -20, -21, -22, -23 and -24 respectively.

16. Quick freeze function button:

Quick freeze is good for freezing large amounts of fresh food to keep the nutrients and taste locked in.

Quick freeze indicator is illuminated when quick freeze function is activated and fridge compartment temperature indicator is displayed as -27. To cancel this function press quick freeze button again. Quick freeze indicator will turn off and refrigerator will return to its normal settings. Quick freeze function is cancelled automatically in 24 hour if you do not cancel it before. If you want to freeze large amounts of fresh food, press the quick freeze button before putting the food into the freezer compartment.

17. Energy saving indicator:

This symbol ("") is illuminated when the energy saving function is activated.

18. Quick freeze indicator:

This symbol is illuminated when the Quick freeze function is on.

Operating the product

5.2. Neo-Frost Cooling System

Thanks to the two separate cooling systems, cooling speed is much faster than traditional refrigerators. Air in the fridge is kept with optimal humidity which is essential for fruit and vegetables and the freezer maintains a dry environment. Odours are also not transferred from the fridge to freezer and vice versa.

5.3. Freezing fresh food

- Wrap the food or place in a covered container before putting them in the freezer.
 - Hot food and beverages must cool down to the room temperature before putting them in the freezer.
 - The foodstuff that you want to freeze must be fresh and in good quality.
 - Divide the food into portions according to your family's daily or meal based consumption needs.
- Pack the food in an airtight manner to prevent them from drying even if they are going to be stored for a short time.
 - Materials to be used for packaging must be tear-proof and resistant to cold, humidity, oils and acids and they must also be airtight. Moreover, they must be made from easy-to-use materials that are suitable for deep-freezers.
 - Frozen food must be used immediately after they are thawed and they should never be re-frozen.
 - Do not freeze too large quantities of food at one time. The quality of the food is best preserved when it is frozen right through to the core as quickly as possible.
 - Placing warm food into the freezer compartment causes the cooling system to operate continuously until the food is frozen solid.

Freezer Compartment Setting	Fridge Compartment Setting	Remarks
-18°C	4°C	This is the normal recommended setting.
-20, -24 or -24°C	4°C	These settings are recommended when the ambient temperature exceeds 30°C.
Quick Freeze	4°C	Use when you wish to freeze your food in a short time. Your refrigerator will return to its previous mode when the process is over.
-18°C or colder	2°C	Use these settings if you think that your fridge compartment is not cold enough because of the hot ambient conditions or frequent opening and closing of the door.
-18°C or colder	Quick Fridge	Use this function when you place a large amount into the fridge compartment or when you need to cool your food quickly. It is recommended that you activate Quick Fridge function 4-8 hours before placing a lot of food at once.

Operating the product

5.4. Recommendations for preserving the frozen food

- Frozen food that you have purchased should be stored in accordance with the frozen food manufacturer's instructions for a  (4 star) frozen food storage compartment.
- Note the following to ensure that the high quality achieved by the frozen food manufacturer and the food retailer is maintained:
 1. Put packets in the freezer as quickly as possible after purchase.
 2. Make sure that contents of the package are labelled and dated.
 3. Check whether the "Use By" and "Best Before" dates on the packaging are exceed or not.

5.5. Placing the food

Freezer compartment shelves	Various frozen food such as meat, fish, ice cream, vegetables and etc.
Egg section	Eggs
Refrigerator compartment shelves	Food in pans, covered plates and closed containers
Door shelves of fridge compartment	Small and packaged food or beverage (such as milk, fruit juice, beer and etc.)
Crisper	Vegetables and fruits
Chiller compartment	Delicatessen products (cheese, butter, salami and wrapped fresh meat and fish.)

5.6. Deep-freeze information

Food must be frozen as rapidly as possible when they are put in a refrigerator in order to keep them in good quality.

The TSE norm requires (according to certain measurement conditions) the refrigerator to freeze at least 4.5 kg of food at 32°C ambient temperature to -18°C or lower within 24 hours for every 100-litres of freezer volume.

It is possible to preserve the food for a long time only at -18°C or lower temperatures.

You can keep the freshness of food for many months (at -18°C or lower temperatures in the deep freeze).



Divide the food into portions according to your family's daily or meal based consumption needs.



Pack the food in an airtight manner to prevent them from drying even if they are going to be stored for a short time.

- Materials necessary for packaging:
- Cold resistant adhesive tape
- Self-adhesive label
- Rubber bands
- Pen

Materials to be used for packaging the foodstuff must be tear-proof and resistant to cold, humidity, odour, oils and acids.

Foods to be frozen should not be allowed to come in contact with the previously frozen items to prevent them from getting thawed partially.



Frozen food must be used immediately after they are thawed and they should never be re-frozen.

Operating the product

5.7. Icematic and ice storage container

***optional**

Using the Icematic'

Fill the Icematic with water and place it into its seat.

Your ice will be ready approximately in two hours. Do not remove the Icematic from its seating to take ice.

Turn the knobs on the ice reservoirs clockwise by 90° degrees.

Ice cubes in the reservoirs will fall down into the ice storage container below.

Then, you may take out the ice storage container and serve the ice cubes.

If you wish, you may keep the ice cubes in the ice storage container.

Ice storage container

Ice storage container is only intended for accumulating the ice cubes. Do not freeze water in it. Otherwise, it will break.

5.8. Ice making

***optional**

Fill the ice container with water and place it into the freezer compartment.

Your ice will be ready approximately in two hours.

You can remove the ice in the ice container by removing it from the freezer and twisting it.

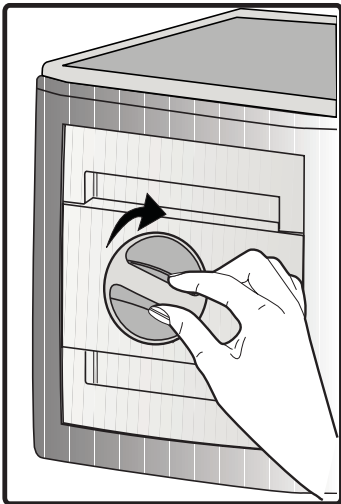
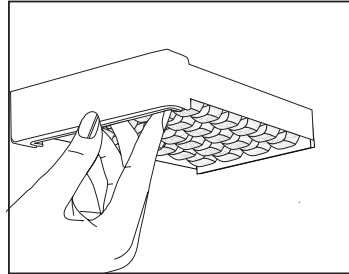

5.9. Chiller compartment

*optional

The chiller compartment maintains a lower temperature than the rest of the fridge, ideal for storing fresh meat fish and deli items.

You can increase the inner volume of your refrigerator by removing any of the chiller compartments:

1. Pull the compartment towards yourself until it stops.
2. Lift the compartment about 1 cm up and pull towards yourself to remove it from its seating.

5.10.Butter & cheese section

*optional

Store food such as butter, cheese and margarine in this section.

5.11.Egg section

You can install the egg holder to the desired door or body shelf.

Never keep the egg holder in the freezer compartment.

5.12.Crisper

Crisper of the refrigerator is designed specially to keep the vegetables fresh without losing their humidity. For this purpose, cool air circulation is intensified around the crisper in general. Remove the door shelves that stand against the crisper before removing the crispers.

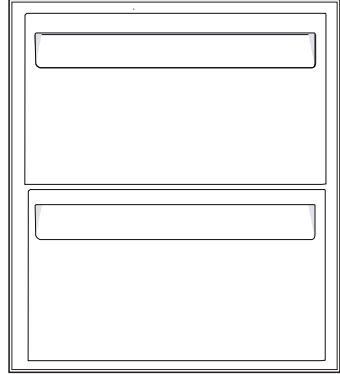

Operating the product

5.13. Odour filter

***optional**

Odour filter prevents unpleasant odour build-up in your refrigerator.

Pull the cover into which the odour filter is installed downwards from the front section and remove as illustrated. Leave the filter under sunlight for one day. Filter will be cleaned during this time. Install the filter back to its place.

Odour filter must be cleaned once in a year.

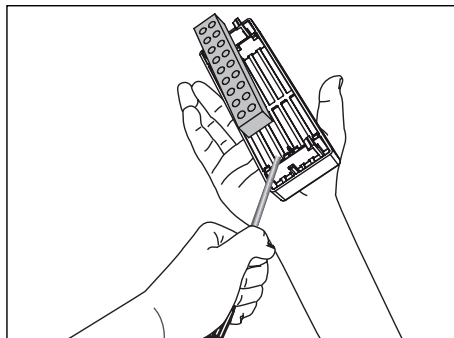
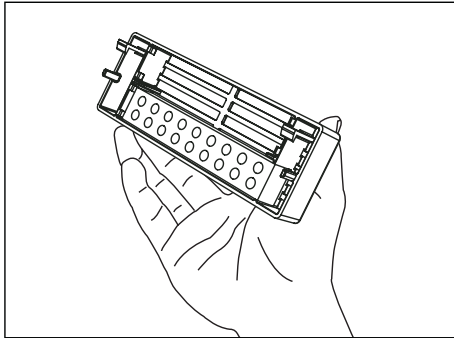
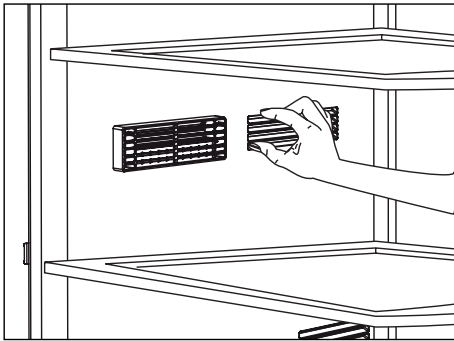

5.14. Drip tray

***optional**

Water that dripped while using the water dispenser accumulates in the spillage tray. You can remove the tray by pulling it to yourself or pressing on its edge (depending on the model). Remove the water with a sponge or a soft cloth.

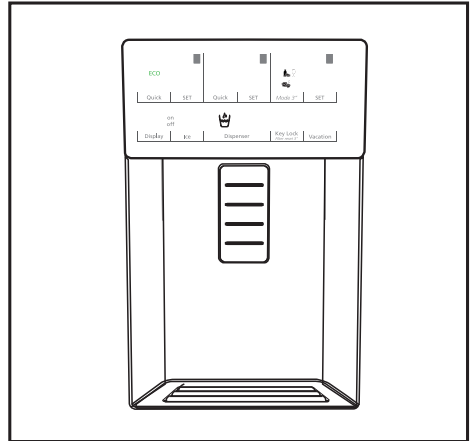

Operating the product

5.15. Water Dispenser

*optional

The water dispenser will provide chilled water on tap, without the need for any plumbing. As you will not have to open your fridge door frequently to retrieve water, this will also save you energy.

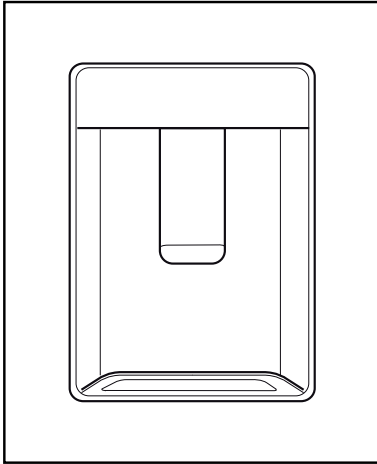

5.16. Using the water dispenser

Push the lever of the water dispenser with your glass. The dispenser will cease operating once you release the lever.

When operating the water dispenser, maximum flow can be obtained by pressing the lever fully. Please remember that the amount of flow from the dispenser is subject to the degree you press the lever.

As the level of the water in your glass/container rises, slightly lessen the pressure on the lever to prevent the overspill. If you slightly press the lever, the water will drip; this is quite normal and not a failure.

5.17. Filling the water dispenser's tank

Water tank filling reservoir is located inside the door rack. Open the reservoir cover and pour in clean drinking water. And then, close the lid.

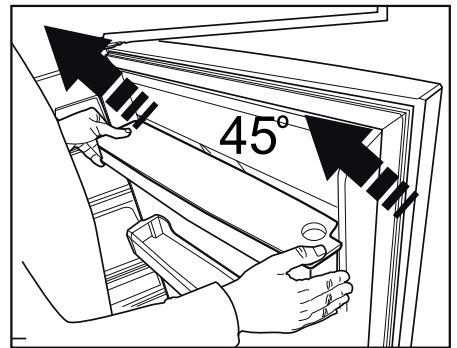
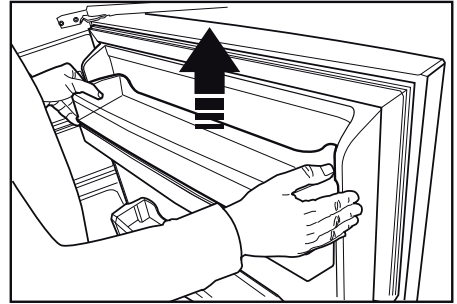

Do not fill the water reservoir with any other liquid except for water such as fruit juices, carbonated beverages or alcoholic drinks which are not suitable to use in the water dispenser. Water dispenser will be irreparably damaged if these kinds of liquids are used. Warranty does not cover such usages. Some chemical substances and additives contained in these kinds of drinks/liquids may damage the water tank.

Operating the product



Use clean and pure drinking water only.



Capacity of the water tank is 2 liters; do not overfill.



Push the lever of the water dispenser with a rigid glass. If you are using disposable plastic glasses, push the lever with your fingers from behind the glass.

5.18.Cleaning the water tank

- Remove the water filling reservoir inside the door rack.
- Remove the door rack by holding from both sides.
- Grab the water tank from both sides and remove it with an angle of 45 C.
- Clean the water tank by removing its lid.

Important:

Components of the water tank and water dispenser should not be washed in dishwasher.

Water tray

Water that dripped while using the water dispenser accumulates in the spillage tray.

Take out the plastic strainer as shown in the figure. With a clean and dry cloth, remove the water that has accumulated

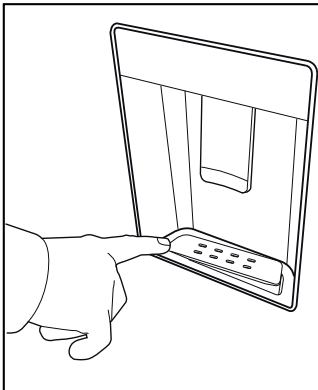

6 Maintenance and cleaning

Cleaning your fridge at regular intervals will extend the service life of the product.



WARNING: Unplug the product before cleaning it.

- Never use gasoline, benzene or similar substances for cleaning purposes.
- Never use any sharp and abrasive tools, soap, household cleaners, detergent and wax polish for cleaning.
- Dissolve one teaspoon of bi-carbonate in half litre of water. Soak a cloth with the solution and wrung it thoroughly. Wipe the interior of the refrigerator with this cloth and the dry thoroughly.
- Make sure that no water enters the lamp housing and other electrical items.
- If you will not use the refrigerator for a long period of time, unplug it, remove all food inside, clean it and leave the door ajar.
- Check regularly that the door gaskets are clean. If not, clean them.
- To remove door and body shelves, remove all of its contents.
Remove the door shelves by pulling them up. After cleaning, slide them from top to bottom to install.
- Never use cleaning agents or water that contain chlorine to clean the outer surfaces and chromium coated parts of the product. Chlorine causes corrosion on such metal surfaces.

6.1 Avoiding bad odours

Materials that may cause odour are not used in the production of our refrigerators. However, due to inappropriate food preserving conditions and not cleaning the inner surface of the refrigerator as required can bring forth the problem of odour. Pay attention to following to avoid this problem:

- Keeping the refrigerator clean is important. Food residuals, stains, etc. can cause odour. Therefore, clean the refrigerator with bi-carbonate dissolved in water every 15 days. Never use detergents or soap.
- Keep the food in closed containers. Microorganisms spreading out from uncovered containers can cause unpleasant odours.
- Never keep the food that have passed best before dates and spoiled in the refrigerator.

6.2 Protecting the plastic surfaces

Do not put liquid oils or oil-cooked meals in your refrigerator in unsealed containers as they damage the plastic surfaces of the refrigerator. If oil is spilled or smeared onto the plastic surfaces, clean and rinse the relevant part of the surface at once with warm water.

7 Troubleshooting

Please review this list before calling the service. It will save your time and money. This list includes frequent complaints that are not arising from defective workmanship or material usage. Some of the features described here may not exist in your product.

The refrigerator does not operate.

- The plug is not inserted into the socket correctly. >>> *Insert the plug into the socket securely.*
- The fuse of the socket which your refrigerator is connected to or the main fuse may have blown out. >>> *Check the fuse.*

Condensation on the side wall of the fridge compartment (MULTIZONE, COOL CONTROL and FLEXI ZONE).

- Ambient is very cold. >>> *Do not install the refrigerator in places where the temperature falls below 5 °C.*
- Door has been opened frequently. >>> *Do not open and close the door of refrigerator frequently.*
- Ambient is very humid. >>> *Do not install your refrigerator into highly humid places.*
- Food containing liquid is stored in open containers. >>> *store food in closed containers*
- Door of the refrigerator is left ajar. >>> *Do not leave the doors of your refrigerator open for a long time.*
- Thermostat is set to a very cold level. >>> *Set the thermostat to a suitable level.*

Compressor is not running

- Protective thermic of the compressor will blow out during sudden power failures or plug-out plug-ins as the refrigerant pressure in the cooling system of the refrigerator has not been balanced yet. The refrigerator will start running approximately after 6 minutes. Please call the Authorised Service Agent if the refrigerator does not start at the end of this period.
- The fridge is in defrost cycle. >>> *This is normal for a full-automatically defrosting refrigerator. Defrosting cycle occurs periodically.*
- The refrigerator is not plugged into the socket. >>> *Make sure that the plug is fit into the socket.*
- Temperature settings are not made correctly. >>> *Select the suitable temperature value.*
- There is a power outage. >>> *Refrigerator returns to normal operation when the power restores.*

The operation noise increases when the refrigerator is running.

- The operating performance of the refrigerator may change due to the changes in the ambient temperature. It is normal and not a fault.

The refrigerator is running frequently or for a long time.

- New product may be larger than the previous one. Larger refrigerators operate for a longer period of time.
- The room temperature may be high. >>> *It is normal that the product operates for longer periods in hot ambient.*
- The refrigerator might be plugged in recently or might be loaded with food. >>> *When the refrigerator is plugged in or loaded with food recently, it will take longer for it to attain the set temperature. This is normal.*
- Large amounts of hot food might be put in the refrigerator recently. >>> *Do not put hot food into the refrigerator.*
- Doors might be opened frequently or left ajar for a long time. >>> *The warm air that has entered into the refrigerator causes the refrigerator to run for longer periods. Do not open the doors frequently.*
- Freezer or fridge compartment door might be left ajar. >>> *Check if the doors are closed completely.*
- The refrigerator is adjusted to a very low temperature. >>> *Adjust the refrigerator temperature to a warmer degree and wait until the temperature is achieved.*
- Door seal of the fridge or freezer may be soiled, worn out, broken or not properly seated. >>> *Clean or replace the seal. Damaged/broken seal causes the refrigerator to run for a longer period of time in order to maintain the current temperature.*

Troubleshooting

Freezer temperature is very low while the fridge temperature is sufficient.

- The freezer temperature is adjusted to a very low value. >>> *Adjust the freezer temperature to a warmer degree and check.*

Fridge temperature is very low while the freezer temperature is sufficient.

- The fridge temperature is adjusted to a very low value. >>> *Adjust the fridge temperature to a warmer degree and check.*

Food kept in the fridge compartment drawers is frozen.

- The fridge temperature is adjusted to a very low value. >>> *Adjust the fridge temperature to a higher value and check.*

Temperature in the fridge or freezer is very high.

- The fridge temperature is adjusted to a very high value. >>> *Fridge compartment temperature setting has an effect on the temperature of the freezer. Change the temperatures of the fridge or freezer and wait until the relevant compartments attain a sufficient temperature.*
- Doors are opened frequently or left ajar for a long time. >>> *Do not open the doors frequently.*
- Door is ajar. >>> *Close the door completely.*
- The refrigerator is plugged in or loaded with food recently. >>> *This is normal. When the refrigerator is plugged in or loaded with food recently, it will take longer for it to attain the set temperature.*
- Large amounts of hot food might be put in the refrigerator recently. >>> *Do not put hot food into the refrigerator.*

Vibrations or noise.

- The floor is not level or stable. >>> *If the refrigerator rocks when moved slowly, balance it by adjusting its feet. Also make sure that the floor is strong enough to carry the refrigerator, and level.*
- The items put onto the refrigerator may cause noise. >>> *Remove the items on top of the refrigerator.*

There are noises coming from the refrigerator like liquid flowing, spraying, etc.

- Liquid and gas flows occur in accordance with the operating principles of your refrigerator. >>> *It is normal and not a fault.*

Whistle comes from the refrigerator.

- Fans are used in order to cool the refrigerator. It is normal and not a fault.

Condensation on the inner walls of refrigerator.

- Hot and humid weather increases icing and condensation. *It is normal and not a fault.*
- Doors are opened frequently or left ajar for a long time. >>> *Do not open the doors frequently. Close them if they are open.*
- Door is ajar. >>> *Close the door completely.*

Humidity occurs on the outside of the refrigerator or between the doors.

- There might be humidity in the air; this is quite normal in humid weather. >>> *When the humidity is less, condensation will disappear.*

Troubleshooting

Bad odour inside the refrigerator.

- No regular cleaning is performed. >>> *Clean the inside of the refrigerator regularly with a sponge, lukewarm water or carbonate dissolved in water.*
- Some containers or package materials may cause the smell. >>> *Use a different container or different brand packaging material.*
- Food is put into the refrigerator in uncovered containers. >>> *Keep the food in closed containers. Microorganisms spreading out from uncovered containers can cause unpleasant odours.*
- Remove the foods that have expired best before dates and spoiled from the refrigerator.

The door is not closing.

- Food packages are preventing the door from closing. >>> *Replace the packages that are obstructing the door.*
- The refrigerator is not completely even on the floor. >>> *Adjust the feet to balance the refrigerator.*
- The floor is not level or strong. >>> *Also make sure that the floor is level and strong enough to carry the refrigerator.*

Crispers are stuck.

- The food is touching the ceiling of the drawer. >>> *Rearrange food in the drawer.*



WARNING: If you cannot eliminate the problem although you follow the instructions in this section, consult your dealer or the Authorised Service Agent. Never try to repair a non-functional product yourself.

GUARANTEE DETAILS

Your new Beko product is guaranteed against the cost of breakdown repair for 2 years from the date of the original purchase.

What is covered?

- Repairs necessary as a result of faulty materials, defective components or manufacturing defect.
- The cost of functional replacement parts, but excluding consumable items.
- The labour costs of a Beko approved repairer to carry out the repair.

What is not covered?

- Transit, delivery or accidental damage or misuse and abuse.
- Cabinet or appearance parts, including control knobs, flaps, handles or container lids.
- Accessories or consumable items including but not limited to, ice trays, scrapers, cutlery baskets, filters and light bulbs.
- Repairs required as a result of unauthorised repair or inexperienced installation that fails to meet the requirements contained in the user instruction book.
- Repairs to products used on commercial or non-residential household premises.
- Loss of frozen food in freezers or fridge/freezers. (Food loss insurance is often included within your household contents insurance policy, or may be available separately from your retailer).

Important notes.

- Your Beko product is designed and built for domestic household use only.
- The guarantee will be void if the product is installed or used in commercial or non-residential domestic household premises.
- The product must be correctly installed, located and operated in accordance with the instructions contained in the User Instructions Booklet provided.
- Professional installation by a qualified Electrical Domestic Appliance Installer is recommended for all Washing Machines, Dishwashers and Electric Cookers
- Gas Cookers must only be installed by a Gas Safe (or BORD GAIS) registered Gas Installer.
- The guarantee is given only within the boundaries of the United Kingdom and the Republic of Ireland.
- The guarantee is applicable only to new products and is not transferable if the product is resold.
- Beko disclaims any liability for incidental or consequential damages.
The guarantee does not in anyway diminish your statutory or legal rights.

HOW TO OBTAIN SERVICE

Please keep your purchase receipt or other proof of purchase in a safe place; you will need to have it should the product require attention under guarantee.

You should also complete the details below; it will help us assist you when requesting service. (The model number is printed on the Instruction Booklet and the serial number is printed on the Rating Label affixed to the appliance)

Model No: Serial No: Retailer: Date of purchase:

For service under guarantee simply telephone the appropriate number below

UK Mainland & Northern Ireland

Fridges & Freezers	0845 6004903
Electric Cookers	0845 6004902
Gas & Dual Fuel Cookers	0845 6004905
Washing Machines & Dishwashers	0845 6004906

Republic of Ireland

All Refrigeration, All Cookers Washing Machines & Dishwashers	01 862 3411
--	-------------

Before requesting service please check the trouble-shooting guide in the Operating Instructions as a charge may be levied where no fault is found even though your product may still be under guarantee.

Service once the manufacturers guarantee has expired.

If you have purchased an extended guarantee please refer to the instructions contained within the extended guarantee agreement document. Otherwise please call the appropriate number above where service can be obtained at a charge.

Should you experience any difficulty in obtaining service please contact the Beko Customer Help-Line. Tel: 0845 6004911 e-mail: service@beko.co.uk

BEKO



BEKO plc
Beko House
1 Greenhill Crescent
Watford
Hertfordshire
WD18 8QU
Tel: 0845 6004911
Fax: 0845 6004922
e-mail: service@beko.co.uk
website: www.beko.co.uk

Printed in Turkey
57 3771 0000/AC
Part no:
Revision no:

Free Manuals Download Website

<http://myh66.com>

<http://usermanuals.us>

<http://www.somanuals.com>

<http://www.4manuals.cc>

<http://www.manual-lib.com>

<http://www.404manual.com>

<http://www.luxmanual.com>

<http://aubethermostatmanual.com>

Golf course search by state

<http://golfingnear.com>

Email search by domain

<http://emailbydomain.com>

Auto manuals search

<http://auto.somanuals.com>

TV manuals search

<http://tv.somanuals.com>