

BKS 2123

# Vacuum Cleaner

## User Manual

**BEKO**

Download from [Www.Somanuals.com](http://www.somanuals.com). All Manuals Search And Download.

## **Read this manual prior to initial operation of the product!**

Dear Customer,

We hope that your product, which has been manufactured in modern facilities and passed through a strict quality control procedure, will give you very good results.

We advise you to read through this manual carefully before using your product and keep it for future reference.

### **The User Manual will help you use your machine in a fast and safe way.**

- Read the User Manual before installing and starting your product.
- In particular, follow the instructions related to safety.
- Keep this User Manual within easy reach for future reference.
- Also read all additional documents supplied with this product.

Remember that this User Manual is also applicable for several other models. Differences between models will be identified in the manual.



This product has been produced in environmentally friendly, modern facilities



## CONTENT

---

<b>1 Important Safeguards</b>	<b>2</b>
<b>2 Technical Aspects Of Your Machine</b>	<b>3</b>
<b>3 How To Use</b>	<b>4-9</b>
<b>4 How To Clean</b>	<b>10-11</b>

---

# 1 Important Safeguards

---

Basic safety Precautions should always be followed when using electrical appliances including the following :

1. If the voltage written under the label of your vacuum cleaner is appropriate with the mains voltage in your house; you can use your vacuum cleaner. Otherwise motor may burn.

2. Do not leave your vacuum cleaner plugged. Unplug it when you do not use or when service is necessary.

3. Do not use your vacuum cleaner on wet surfaces and outside the house.

4. This appliance is not intended for use by persons (including children) with reduced physical, sensory or mental capabilities, or lack of experience and knowledge, unless they have been given supervision or instruction concerning use of the appliance by a person responsible for their safety.

Children should be supervised to ensure that they do not play with the appliance.

5. If the power cord or plug is damaged, any drop or fall occurred, left outside, get wet or your device is not working; consult to authorized services.

6. Do not carry your device by pulling from its cable. Protect the cable from sharp edges, hot surfaces and be careful to not to closely pressed between a door and a door frame.

7. Do not unplug it by pulling from its cord. Unplug it by holding from the plug.

8. Do not touch the plug or the device with wet hands.

9. Do not drop any objects in to any open parts of your device. Make sure that the air passage holes and channels are open.

10. Keep your hands and hair away from the working parts of the machine.

11. Do not use your vacuum cleaner to clean flammable objects such as cigarettes, matches, hot ashes.

12. Do not use your vacuum cleaner without a paper filter or other filters are attached.

13. Turn on all of the control buttons on your vacuum cleaner before unplugging.

14. Do not vacuum burnable or flammable liquids. Do not use your device where these kinds of liquids exist.

15. Unplug it when attaching or changing the accessories delivered with your vacuum cleaner.

16. Do not operate your vacuum cleaner while keeping it vertical.

17. Small pieces of dust may cause clog of dust bag. This will terminate the air passage from the dust bag. In this case the dust bag must be changed although the dust bag is not completely filled.

## 2 Technical Aspects Of Your Machine

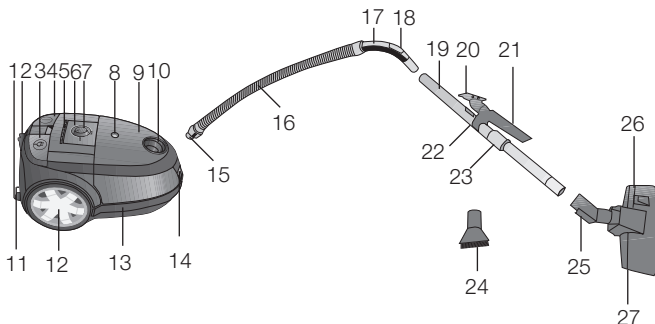

- 1- Plug and the power cord
- 2- Brush parking area
- 3- Cable twisting button
- 4- On-Off button with power variator
- 5- Carrying handle
- 6- Blue indicator light
- 7- Vacuum control button
- 8- Dust indicator
- 9- Front cover
- 10- Hose inlet
- 11- Exhaust filter area
- 12- Wheel
- 13- Body protection rubber
- 14- Front cover opening pin
- 15- 360 degrees turnable hose adaptor
- 16- Elastic hose
- 17- Handle
- 18- Air control slide
- 19- Telescopic extension pipe
- 20- Upholstery brush
- 21- Crevice tool
- 22- Accessories carrying piece
- 23- Telescopic control pin

- 24- Dust brush
- 25- Brush park projection
- 26- Brush control pin
- 27- Parquet carpet brush

**Max. Power :** 2300 W

**Net weight :** 6.6 kg

**Voltage and frequency :** 220-240V AC 50 Hz

**Dust volume :** 4 lt

**Usage radius :** 9 m

**Filtration layer :** 7 levels

### 3 How To Use

Pull the plug and the cable located at the back, outside; plug it. Stop pulling when you see the yellow sign on the cable, red sign comes after yellow sign, never pull when you see the red sign. Otherwise you may give harm to the cable twister of your product.

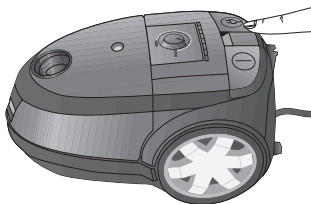

Push the on-off button with power variator in order to operate your vacuum cleaner. When the on-off button with power variator is pushed, the blue indicator light around the vacuum control button will be on.

You can control the vacuum power of your product with the vacuum power control button located on the body of your device while operating.

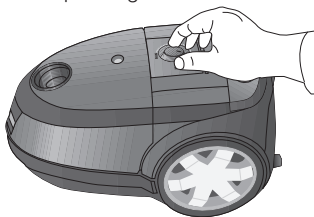
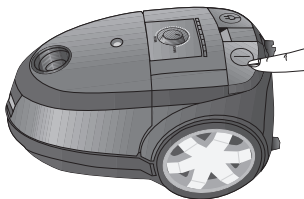

Push the cable twister button on the device in order to twist the cable after the operation of the vacuum cleaner is finished. Do not step on the cable twister button. The mechanism may receive harm in case of stepping onto it strongly.

**Note:** If your carpet brush sticks to your carpet because of the high vacuum power of your product, you may decrease the vacuum power by this button.

You may reduce the vacuum power a little bit without using the vacuum power control on your product, by pulling the slide back when you want, using the air control slide on the handle.

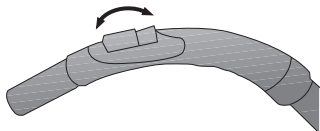

Do not clean by rubbing the edge of the handle to carpets and coac-hes, otherwise the edge will melt and can not be used anymore. Use the brushes and accessories delivered with your product for cleaning.

#### Dust indicator

It shows the fullness proportion of your dust bag. If the indicator shows the red position more than %50, then it means that the changing time of the dust bag has arrived. The dust bag must be changed although dust is not collected fully in the dust bag, if slight pieces of dust is filled the pores of the dust bag. If the indicator shows fully red, change the bag immediately, otherwise the motor protector thermostat will operate to terminate your product and your product will not work for 30 minutes. In this case change the dust bag, wait your product to get cold and then operate.

#### Dust indicator

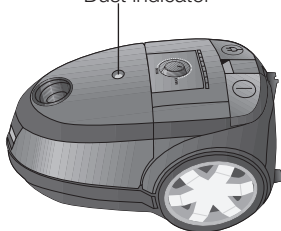

If you preferred to use a cloth filter, empty the cloth bag and wash in warm water when the dust indicator shows red. You may use soap when you wash the cloth bag. The cloth bag should be inserted into its place after it is dried for 24 hours. While you are inserting the cloth bag into its place make sure that no space is left on the back-side and fully closed, otherwise dusts may escape into your motor and cause harm.

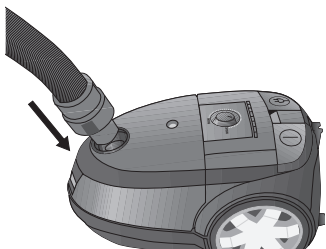

Picture 1

Push the bails on the hose adaptor and pull it backwards in order to take the hose adaptor out of the vacuum cleaner.

You can carry your product by holding from its handle. If you want to carry it vertically hold it from the cavity area for carrying located below the product.

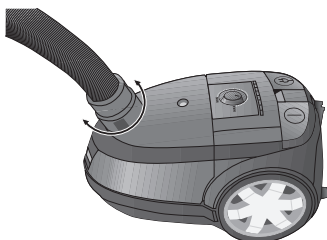

Picture 2

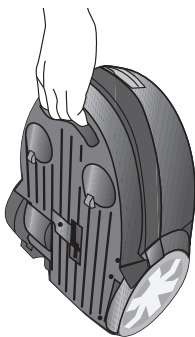
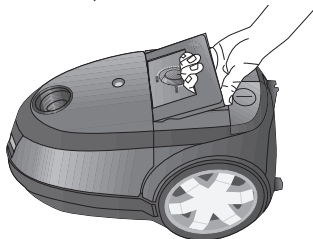

The hose adaptor of your product has a property of turning 360 degrees. By this property it provides an ergonomic usage during cleaning.

You can attach the hose adaptor by pushing the hose adaptor in the direction of the arrow without pushing the nails as shown in picture 1. Make sure that the nails on the hose adaptor are fitted into their places as shown in picture 2.



The sides and the wheels of your product is covered with protective rubber against crashes. By this way, straching your product and harming your furnitures are prevented.

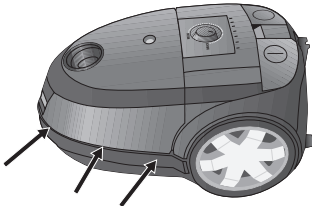

**How to use the extention pipe**  
The extention pipe of your product has telescopic property. In order to extend the pipe, push the pin shown in the picture and pull it from the edge by your hand. You may arrange its lenght as you wish.

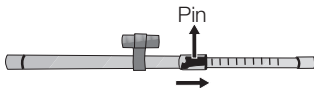

**How to use the accessories**  
There is an accessories carrying adaptor on the extention pipe. You can use 2 of the accessories you wish by attaching on it. If you don't want to use this adaptor, you can take its screw with a screw driver and take the piece out of the telescopic extention pipe.

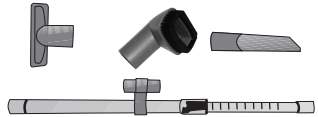

**Crevice tool**  
It can be used in crevice places such as interiors of furnitures and coaches.



**Upholstery brush**  
It can be used to clean floor coverings, steps, inside of your car, coaches, furniture, etc.

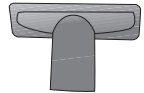

**Dust brush**  
Dust brush is used for taking the dusts of fragile objects and curtains.



How to use the parquet, carpet brush

There is a control mechanism on the left side of the parquet carpet brush. By the help of this control mechanism the brush is brought into the desired conditions suitable for the surface to be cleaned.

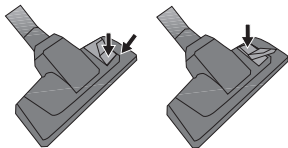

- a. In order to clean the rugs and the carpets, use your brush in normal condition. (Hair brushes are hidden.)
- b. In order to clean hard floor coverings such as parquet, vinyl floor covering, linoleum and flat surfaces such as walls without scratching, change the position of the control mechanism and clean on the hair brushes.

**Warning:** The carpet brush may stick to your carpet closely since the vacuum power of your vacuum cleaner is very high. For this reason it may cause exhausting arm and back aches. In order not to face such a problem, reduce the vacuum power of the product.

**Turning off and parking**

The operation of the vacuum cleaner is stopped by pushing on the on-off button with power variator located on the body.

Do not unplug it immediately in order to stop the operation of your product, first push the on-off button with power variator to stop the operation of the product.

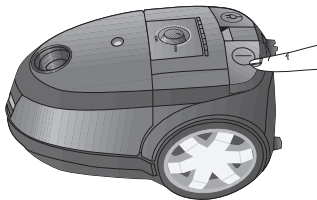

You can park your vacuum cleaner in two different ways: vertical and horizontal. You can attach the brushes parking place in to the parking socket at the back of the product in order to park vertically.

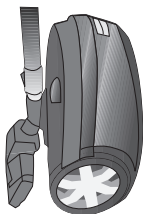

Also you can attach the parking place at the back of your brush into the parking socket located at the back of your product and park horizontally.

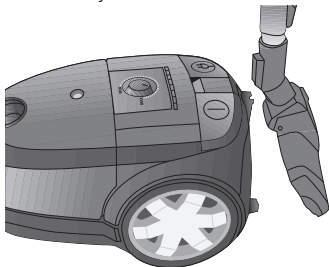

Change your dust bag when the dust indicator glows red or if the vacuum power of your vacuum cleaner is not at the desired level. In order to change the dust bag, first open the front cover by lifting the pin located in the front. After opening, take it out by sliding it up over the cradle where full dust bag is located. The cover will not be closed before a new dust bag is inserted. Please do not force to close the cover otherwise plastic sections may harm.

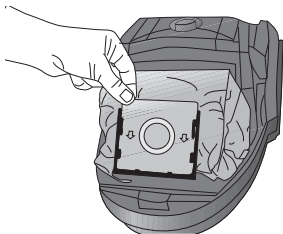

**Warning:** The dust bags purchased from unauthorised places other than services and dealers are not original. The dust bags which are not original are at very low quality. For this reason they are torn in a short time and your product becomes useless. For the breakdowns stemmed from using fake dust bags are considered out of warranty.

#### Cloth dust bag

If you use cloth dust bags instead of paper, you may empty it and reuse for many times. If the dust bag in your device is cloth then take the bag out as explained in “changing the paper filter”.

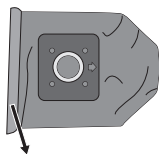

Cloth filter clips

## 4 How To Clean

You can clean cloth dust bags as follows:

- Hold the dust bag over a dust bin upside down. Take the clips off by pushing to the side.
- Wash the cloth bag in warm water by hand. After washing, leave it to dry and never use before it is completely dried.
- Close the bag by pushing the clips on the lower edge of the bag. If you are using a cloth bag we recommend you to change the motor filter once a year.

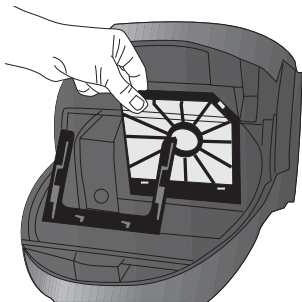

How to clean the motor filter

When the motor protection filter is extremely dusted, take it out and clean.

Also take the motor protection filter out and shake every time when the dust bag is changed. Buy a new motor protection filter from the service and change once in every 5 paper filter change. Otherwise filter loses its effect since it finishes its usage life. On the other hand it may cause the motor to work louder and live shorter. Motor protection filter does not have a property such as being washed, it loses its effects when washed and causes the motor to be harmed.

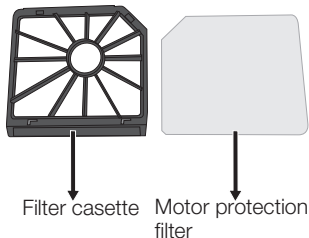

## Taking off the exhaust cover and exhaust filters

On every fifth change of dust bag, with the change of motor protection filter; open the exhaust cover at the back where the air gets out of your product, by pushing on the pin as shown in the picture in order to take the hepa filter and sponge filter located inside.

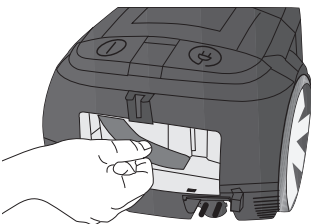
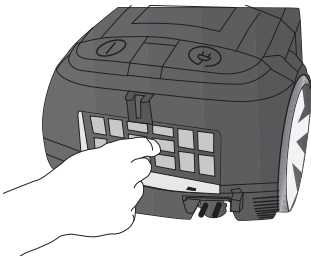
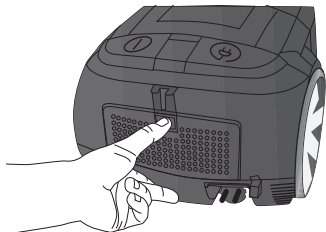
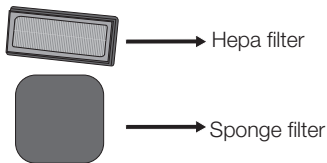

Wash the hepa filter and the sponge filter in warm water and leave them to dry for 24 hours. Attention! Do not use devices such as hair dryers or stoves which give hot air out in order to dry. Do not insert the hepa filter and sponge into their places before they are completely dried, otherwise humidity odour may be delivered, water splash may occur at the backside and filters may be harmed.

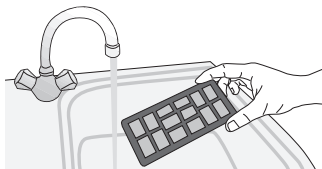
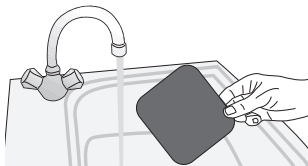

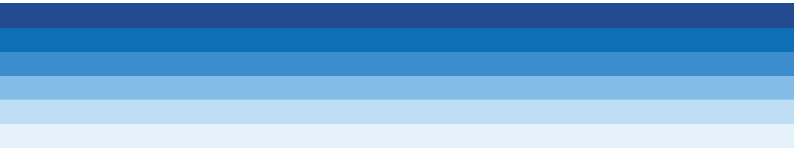

## Free Manuals Download Website

<http://myh66.com>

<http://usermanuals.us>

<http://www.somanuals.com>

<http://www.4manuals.cc>

<http://www.manual-lib.com>

<http://www.404manual.com>

<http://www.luxmanual.com>

<http://aubethermostatmanual.com>

Golf course search by state

<http://golfingnear.com>

Email search by domain

<http://emailbydomain.com>

Auto manuals search

<http://auto.somanuals.com>

TV manuals search

<http://tv.somanuals.com>