

Washing Machine

D1 5061 B

D1 5062 B

D1 5081 B

D1 5081 BS

D1 5082 B

D1 5101 B

D1 5102 B

D1 5102 BS

BEKO

Please read this manual first!

Dear Customer,

We hope that your product which has been manufactured in modern facilities and passed through a strict quality control procedure will give you the best results. Therefore, we advise you to read through this manual carefully before using your product and keep it for future reference.

This operation manual will...

...help you use your machine in a fast and safe way.

- Please read the Operation Manual before installing and starting your machine.
- Particularly follow the instructions related to safety.
- Keep this Operating Manual within easy reach. You may need it in the future.
- Please read all additional documents supplied with this machine.

Please note that this Operating Manual may be applicable for several other models. Differences between models will be identified in the manual.

Explanation of symbols

Throughout this Operation Manual the following symbols are used:

- ⓘ Important information or useful hints about usage.
- ⚠ Warning for hazardous situations with regard to life and property.
- ⚡ Warning for supply voltage.

TABLE OF CONTENTS

1 Your Washing Machine	4	Changing the program after the program has started	19
Overview	4	Child-proof lock	20
Specifications	5	Ending the program through canceling	20
2 Warnings	6	End of Program	20
General Safety	6	6 Quick instructions for daily use	21
First Use	6	7 Cleaning and care	23
Intended use	6	Detergent drawer	23
Safety instructions	7	The loading door and the drum	23
If there are children in your house...	7	Body and control panel	23
3 Installation	8	Inlet water filters	23
Removing packaging reinforcement	8	Draining any remaining water and cleaning the pump filter	24
Opening the transportation locks	8	8 Troubleshooting	26
Appropriate installation location	8		
Adjusting the feet	8		
Connecting to the water supply.	9		
Connecting to the drain	9		
Electrical connection	10		
Destroying the packaging material	10		
Disposing of the old machine	10		
4 Initial preparations for washing	11		
Sorting the laundry	11		
Preparing clothes for washing	11		
Correct load capacity	11		
Loading door	12		
Detergents and softeners	12		
5 Selecting a Program and Operating Your Machine	14		
Control panel	14		
Turning the machine on	15		
Program selection	15		
Spin Speed selection	16		
Program selection and consumption table	17		
Auxiliary functions	18		
Starting the Program	18		
Progressing a program	18		

1 Your Washing Machine

Overview

Figure 1

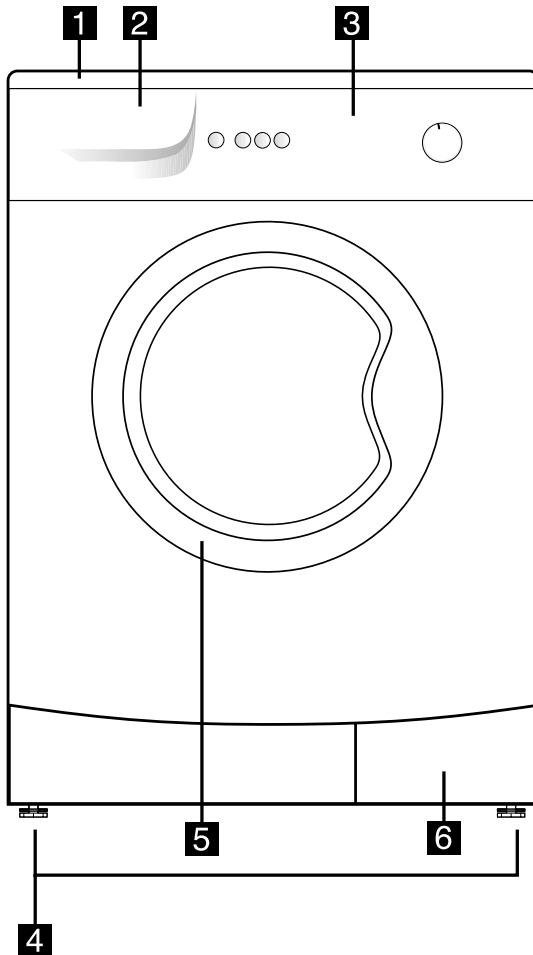

- | | |
|---------------------------|---------------------------------|
| 1 Top Lid | 4 Height-adjustable Feet |
| 2 Detergent Drawer | 5 Loading Door |
| 3 Control Panel | 6 Filter Cap |

Specifications

Models	D1 5061 B	D1 5081 B	D1 5081 BS	D1 5101 B	D1 5062 B	D1 5082 B	D1 5102 B	D1 5102 BS
Maximum dry laundry capacity (kg)	5	5	5	5	5	5	5	5
Height (cm)	84	84	84	84	84	84	84	84
Width (cm)	60	60	60	60	60	60	60	60
Depth (cm)	55	55	55	55	55	55	55	55
Net Weight (kg)	61	62	62	62	61	62	62	62
Electricity (V/Hz.)	220-240 V / 50hz							
Total Current (A)	10	10	10	10	10	10	10	10
Total Power (W)	2100-2500							
Spinning cycle (rpm max.)	600	800	800	1000	600	800	1000	1000

Specifications of this appliance may change without notice to improve the quality of the product. Figures in this manual are schematic and may not match your product exactly.

Values stated on the machine labels or in the documentation accompanying it are obtained in laboratory in accordance with the relevant standards. Depending on operational and environmental conditions of the appliance, values may vary.

2 Warnings

Please read the following information. Otherwise, there may be the risk of personal injury or material damage. Moreover, any warranty and reliability commitment will become void.

General Safety

- Never place your machine on a carpet covered floor. Otherwise, lack of airflow from below of your machine may cause electrical parts to overheat. This may cause problems with your washing machine.
- If the power cable or mains plug is damaged you must call Authorized Service for repair.
- Check water hoses for wear. Do not use old/used water inlet hoses. These may cause stains on your laundry.
- Fit the drain hose into the discharge housing securely to prevent any water leakage and to allow machine to take in and discharge water as required. It is very important that the water intake and drain hoses are not folded, squeezed, or broken when the appliance is pushed into place after it is installed or cleaned.
- Your washing machine is designed to continue operating in the event of a power interruption. You cannot cancel any program by pressing the "On/Off button." Your machine will not resume its program when the power restores. Press the "Start/Pause/Cancel" button for 3 seconds to cancel the program (See, Canceling a Program)
- There may be some water in your machine when you receive it. This is from the quality control process and is normal. It is not harmful to your machine.
- Some problems you may encounter may be caused by the infrastructure. Press "Start/Pause/Cancel" button

for 3 seconds to cancel the program set in your machine before calling the authorized service.

First Use

- To prepare your machine for washing, carry out your first washing process without loading your machine and with detergent under "Cottons 90°C" program.
- Ensure that the cold and hot water connections are made correctly when installing your machine. Otherwise, your laundry may come out hot at the end of the washing process and may wear out.
- If the current fuse or circuit breaker is less than 16 Amperes, please have a qualified electrician install a 16 Ampere fuse or circuit breaker.
- While using with or without a transformer, do not neglect to have the grounding installation laid by a qualified electrician. Our company shall not be liable for any damages that may arise when the machine is used on a line without grounding.
- To make your machine ready for use, please be sure that the tap water supply and water drainage systems are appropriate before calling the authorized service. If they are not, call a qualified plumber to have any necessary arrangements carried out.

Intended use

- This product has been designed for home use.
- The appliance may only be used for washing and rinsing of textiles that are marked accordingly.
- Only detergents, softeners and supplements suitable for washing machines may be used.
- Observe the care instructions labeled on textile products and any other instructions given by

companies that produce detergents for your machine.

Safety instructions

- This appliance must be connected to an earthed outlet protected by a fuse of suitable capacity.
- The supply and draining hoses must always be securely fastened and remain in an undamaged state.
- Fit the draining hose to a washbasin or bathtub securely before starting up your machine. There may be a risk of being scalded due to high washing temperatures!
- Never open the loading door or remove the filter while there is still water in the drum. Otherwise, there may be the risk of flooding and possible injury due to the hot water.
- Never force to open the locked loading door! The loading door will be ready to open just a few minutes after the washing cycle comes to an end.
- Unplug the machine when it is not in use.
- Never wash down the appliance with a water hose! There is the risk of electric shock! Always disconnect from the mains by unplugging before cleaning.
- Never touch the plug with wet hands. Never unplug by pulling on the cable, always pull out from the plug only. Do not operate the machine if the power cord or plug is damaged.
- Never attempt to repair the machine yourself. Otherwise, you may be putting yours and other's lives in danger.
- For malfunctions that cannot be solved by information in the operating manual:
Turn off the machine, unplug it, turn off the water tap and contact an authorized service agent.

If there are children in your house...

- Electrical appliances may be dangerous for the children. Keep children away from the machine when it is operating. Do not let them tamper with the machine.
- Close the loading door when you leave the area where the machine is located.
- Store all detergents in a safe place out of reach of the children.

3 Installation

Removing packaging reinforcement

Tilt the machine to remove the packaging reinforcement. Remove the packaging reinforcement by pulling the ribbon.

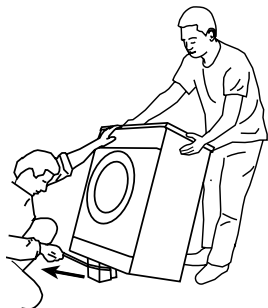

Opening the transportation locks

- ⓘ Transportation safety bolts must be removed before operating the washing machine! Otherwise, the machine will be damaged!
- 1. Loosen all the bolts with a spanner until they rotate freely ("C")

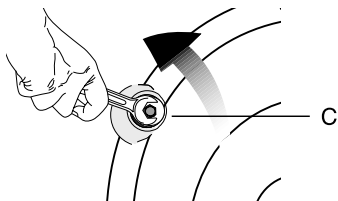

2. Remove transportation safety bolts by turning them gently.

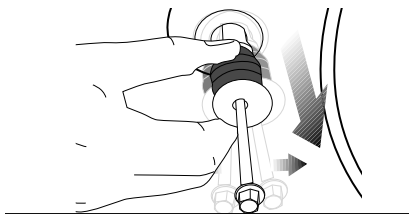

3. Fit the covers (supplied in the bag with the Operation Manual) into the holes on the rear panel. ("P")

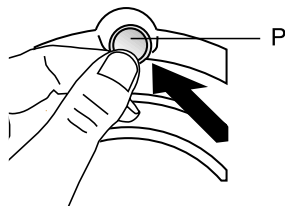

- ⓘ Keep the transportation safety bolts in a safe place to reuse when the washing machine needs to be moved again in the future.
- ⓘ Never move the appliance without the transportation safety bolts properly fixed in place!

Appropriate installation location

Install the appliance in environments which have no risk of freezing, in a stable and level position.

- ⓘ The floor must be capable of carrying the load on it!
- ⓘ If the washing machine and a drier are placed on top of each other, their approximate weight together may reach 180 kg when they are full.

Important:

- Do not place the appliance on top of the power cable.
- Keep at least 1cm distance from the edges of other furniture.
- Place the machine on a firm surface; do not position it on a long pile rug or suchlike surfaces.

Adjusting the feet

- ⓘ Do not use any tools to loosen the lock nuts. Otherwise, they can be damaged.
- 1. Manually (by hand) loosen the lock nuts on the feet.
- 2. Adjust them until the machine stands level and firmly.

3. Important: Tighten all lock nuts up again.

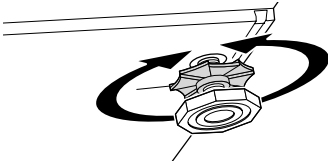

Connecting to the water supply.

Important:

- The water supply pressure required to run the machine must be 1-10 bar (0,1 – 10 MPa). (Practically, it is necessary to have 10 – 80 liters of water flowing from the tap in one minute to have your machine run smoothly.) Attach a pressure-reducing valve if the water pressure is higher.
- Connect the special hoses supplied with the machine to the water intake valves on the machine. The hose bearing the “red” sign (90°C max) is the hot water inlet and the hose bearing the “blue” sign (25°C max) is for the cold water inlet.

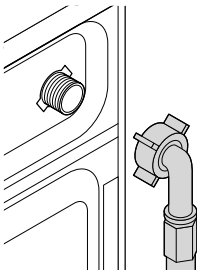

- In order to prevent water leakage that may occur at the connection points, there are rubber seals (4 seals for the models with double water inlet and 2 seals for other models) attached to the hoses. These seals should be used at the tap and machine connection ends of the hoses. The plain end of the hose fitted with a filter must be attached

to the tap and the elbowed end must be attached to the machine. Tighten the nuts of the hose well by hand; never use wrenches to tighten the nuts.

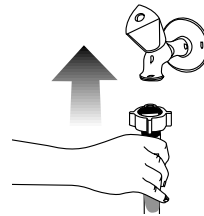

- Open the taps completely after making the hose connection to check if there is any water leakage at the connection points. Turn off the tap and remove the nut in case of any leakage. Retighten the nut carefully after checking the seal. To prevent any water leakage and any other damage to be caused by it, keep the taps closed when the machine is not in use.
- Models with a single water inlet should not be connected to the hot water tap. Laundry may be damaged or the appliance may switch to protection mode and not work.

When returning the appliance to its place after maintenance or cleaning, care should be taken not to fold, squeeze or block the hoses.

Connecting to the drain

The water discharge hose can be attached to the edge of a washbasin or bathtub. The drain hose should be firmly fitted into the drain as to not get out of its housing.

Important:

- The end of the drain hose can be directly connected to the wastewater drain or to the washbasin. The fitting must always be secured in all types of

connections. Your house may be flooded if the hose gets out of its housing during water discharging.

- The hose should be attached to a height of at least 40 cm, and 100 cm at most.
- In case the hose is elevated after laying it on the floor level or close to the ground (less than 40 cm above the ground), water discharge becomes more difficult and the laundry may come out wet. Therefore, the heights described in the figure should be followed.

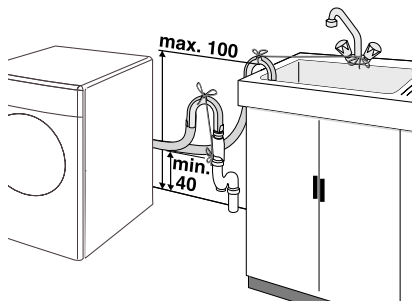

- To prevent dirty water refilling the machine, and to allow for easy discharge, the end of the hose must not be submerged in the drain water. The end of the hose must be able to take in air. The hose should be pushed into the drainage for more than 15 cm. If it is too long you may have it shortened.
- The end of the hose should not be bent, it should not be stepped on and it must not be folded between the drain and the machine.
- If the length of the hose is too short, you may add an extension hose to the original section. The length of the hose must not be longer than 3.2 m after coming out of the machine. To avoid water leakage failures, the connection between the extension hose and the drain hose of the product must be fitted well with an appropriate clamp as not to come off and leak.

Electrical connection

Connect the machine to an earthed outlet protected by a fuse of suitable capacity.

Important:

- Connection should comply with national regulations.
 - Power cord plug must be within easy reach after installation.
 - The voltage and the allowed fuse protection are specified in the section "Technical Specifications".
 - The specified voltage must be equal to your mains voltage.
 - Connection via extension cords or multi-plugs should not be made.
- ⚠ A damaged power cable must be replaced by a qualified electrician.
- ⚠ The appliance must not be operated unless it is repaired! There is the risk of electric shock!

Destroying the packaging material

Packaging material can be dangerous to children. Keep the packaging materials out of reach of children or dispose them by classifying according to waste directives. Do not dispose them together with normal domestic wastes. Packaging materials of your machine are manufactured from recyclable materials.

Disposing of the old machine

Dispose of your old appliance in an environmental friendly manner.

- You may refer to your local agent or solid waste collection center in your municipality to learn how to dispose of your machine.

Before disposing of your old washing machine, cut off the mains plug and make the door lock unusable.

4 Initial preparations for washing

Sorting the laundry

- Sort the laundry according to type of fabric, color, and degree of soiling and permissible water temperature. Always follow the advice on the garment labels.

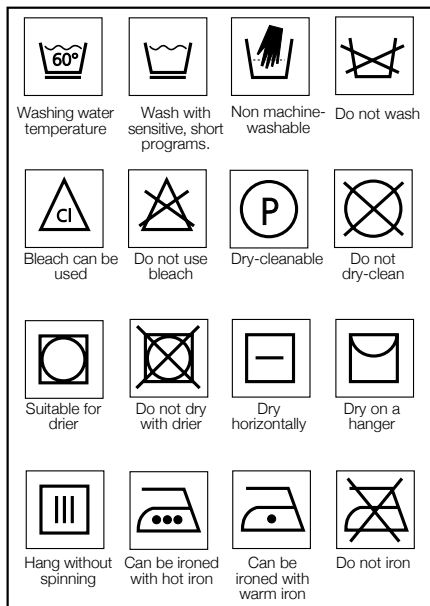

Preparing clothes for washing

Laundry items with metal attachments such as, bras, belt buckles and metal buttons will damage the machine. Remove metal attachments or place the items in a clothing bag, pillow case, or something similar.



- Empty pockets and remove all foreign objects such as coins, pens and paper clips. If possible, turn pockets out and brush.
- Place small items like infants' socks and nylon stockings, etc. in a laundry bag, pillow case or something similar. This will also save your laundry from getting lost.
- Place curtains in the machine with care. Remove curtain rails and pullers.
- Fasten zippers, sew loose buttons and mend rips and tears.
- Wash "machine washable" or "hand washable" labeled products only with an appropriate program.
- Do not wash colors and whites together. New, dark colored cottons may release a lot of dye. Wash them separately.
- Tough stains must be treated properly before washing. If you are not sure, check with a dry cleaner.
- Use only dyes/color changers and lime removers suitable for machine wash. Always follow the instructions on the packaging.
- Wash trousers and delicate clothes turned inside out.
- Keep laundry items made of Angora wool in the freezer for a few hours before washing. This will reduce pilling.

Correct load capacity

- The maximum load capacity depends on the type of laundry, the degree of soiling and the washing program you wish to use.
- The machine adjusts the amount of water according to the amount of laundry placed inside.
- Please follow the information in the "Program Selection Table". Washing results will degrade when the machine is overloaded.

Following weights are given as examples.

Laundry type	Weight (gr.)
Bathrobe	1200
Napkin	100
Duvet cover	700
Bed Sheet	500
Pillowcase	200
Tablecloth	250
Towel	200
Evening gown	200
Underclothing	100
Men's coveralls	600
Men's shirt	200
Men's pajamas	500
Blouse	100

Loading door

The door is locked during program operation. The door can be opened after some time following the program end.

- Open the loading door.
- Place laundry items loosely in the machine.
- Push the loading door until it clicks into place tightly. Ensure that no items are caught in the door.

Detergents and softeners

Detergent drawer

The detergent drawer is composed of three compartments:

The detergent dispenser may be in two different types according to the model of your machine.

- (I) for prewash
- (II) for main wash
- (III) siphon
- (*❄️) for softener

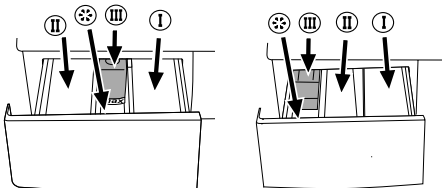

Detergent, softener and other cleaning agents

Add detergent and softener before starting the washing program.

Never open the detergent dispenser drawer while the washing program is running!

When using a program without pre-wash, no detergent should be put into the pre-wash compartment (Compartment no. I).

A program without pre-wash should not be selected if a detergent bag or a dispensing ball is going to be used. You can place the detergent bag or the dispensing ball directly among the laundry in your machine.

Choosing the detergent type

The type of detergent to be used depends on the type and color of fabric.

- Use different detergents for colored and white clothes.
- Wash woolens with a special detergent specifically for woolens.
- Use only detergents manufactured specifically for washing machines.

Detergent quantity

The amount of washing detergent to be used depends on the amount of laundry, the degree of soiling and water hardness.

- Do not use amounts exceeding the quantities recommended on the package to avoid problems of excessive foam, poor rinsing, financial savings and finally, environmental protection.
- Use small amounts of detergent at a suitable measure for small amounts of laundry or for only slightly soiled laundry.
- Use exact measures for highly concentrated detergents.

	Detergent quantity
for prewashing	1/2 measure
for main washing	1 measure
with hard water	an additional 1/2 measure

for washing machines and always follow the instructions on the package.

Softener

Put the softener into the softener compartment of the detergent dispenser.

- Use the proportions recommended on the packet.
- Never exceed the (> max <) level marking; otherwise, the softener will be wasted without being used.
- If the softener has lost its fluidity, dilute dense softener with water before placing it in the detergent drawer.

Liquid detergent

When using liquid or gel washing detergents, please note the following:

- The liquid detergent may leave stains on your laundry if time delay feature is selected.
- Do not use liquid detergent if you want to wash using the time delay feature.
- Do not use liquid detergent for the main wash in a cycle with pre-wash.
- Use the detergent manufacturer's measuring cup and follow the instructions on the package.

Starch

- Add liquid starch, powder starch or the dyestuff into the softener compartment as instructed on the package.
- Never use fabric softener and starch together in the same washing cycle.
- Wipe the inside of the drum after using starch.

Eliminating lime formation

- When required, use only appropriate lime removers developed specifically

5 Selecting a Program and Operating Your Machine

Control panel

Figure 2

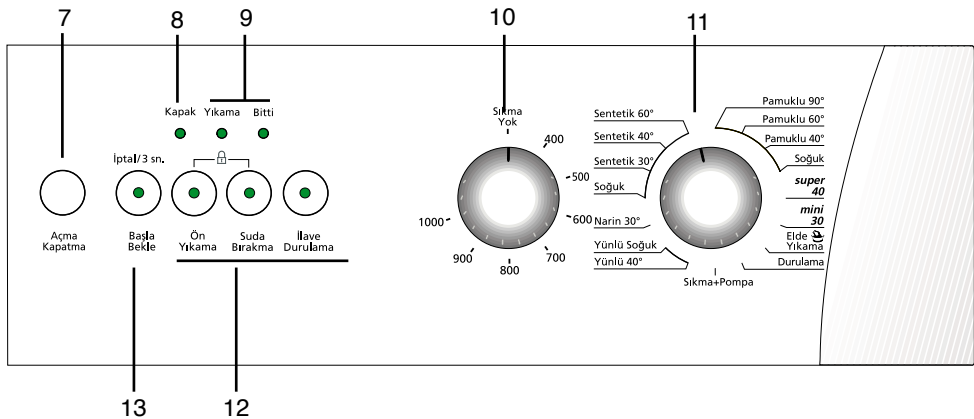

- 7 - On/Off Button
- 8 - Door Indicator
- 9 - Program Follow-up Indicator
- 10 - Child-proof Lock Indicator
- 11 - Spin Speed Adjustment Knob
- 12 - Program Selection Knob
- 13 - Time Delay Key
- 14 - Auxiliary Function Keys
- 15 - Start/Pause/Cancel Button

Turning the machine on

You can prepare the machine for program selection by pressing the the "On/Off" button. When the "On/Off" button is pressed, the "Lid" light illuminates indicating that the door is unlocked. Press the "On/Off" button again to shut down the machine.

- ❗ Pressing the "On/Off" button does not necessarily mean that the program has started. Press "Start/Pause/Cancel" button to start the program.

Program selection

Select the appropriate program from the program table and the following washing temperature table according to type, amount and degree of soiling of the laundry. Select the desired program with the program selection button.

- ❗ Each of these main programmes comprise of a complete washing process, including washing, rinsing and, if required, spin cycles.

90°C	Normally soiled, white cottons and linens. (Ex.: coffee table covers, tablecloths, towels, bed sheets)
60°C	Normally soiled, fade proof colored linens, cottons or synthetic clothes (Ex.: shirts, nightgowns, pajamas) and lightly soiled white linen clothes (Ex.: underwear)
40°C- 30°C- Cold	For delicate clothes (Ex.: lace curtains), blended clothes including synthetics and woolens.

- ❗ Programs are limited with the highest spin speed appropriate for that particular type of cloth.
- ❗ Sort the laundry according to type of fabric, color, degree of soiling and permissible water temperature when

choosing a program.

- ❗ Always select the lowest required temperature. Higher temperature means higher power consumption.
- ❗ For further program details, see, "Program Selection Table"

Main programs

Depending on the type of textile, the following main programs are available:

•Cottons

You can wash your durable clothes with this program. Washes with vigorous washing movements in a longer washing cycle. It is recommended for your cotton items (such as bed sheets, duvet and pillowcase sets, bathrobes, underclothing, etc.).

•Synthetics

You can wash your less durable clothes on this program. Washes with gentler washing movements and in shorter washing cycles. It is recommended for your synthetic clothes (such as shirts, blouses, synthetic/cotton blended garments, etc.). For curtains and lace, using the "Synthetic 40" program with pre-wash and anti-creasing functions selected is recommended. Detergent should not be put in the pre-wash compartment. Less detergent should be put in the main wash compartment as loose knit fabrics (lace) foam too much due to its meshed structure.

•Delicates

You can wash your delicate clothes on this program. It has more sensitive washing movements and does not make intermediate spinning compared to the synthetic program. It must be used for clothes for which sensitive washing is recommended.

•Woolens

You can wash your machine-washable woolen garments on this program. Wash by selecting the proper temperature according to the labels of your clothes. It is recommended to use appropriate detergents for woolens.

•Hand Wash

You can wash your woolen/delicate

clothes that bear “not machine-washable” labels for which hand wash is recommended on this program. It washes the laundry with very tender washing movements without damaging your clothes.

speed selection knob, the machine will spin in the maximum possible rpm in the default setting of the selected program.

Additional programs

For special cases, there are also extra programs available:

❗ Additional programs may differ according to the features of your machine.

• Super

This program washes for a longer period at 40°C and gives the same result as the "Cottons 60°C" program, thus it saves energy. It is suitable for clothes for which you cannot use the "Cottons 60 °C" program.

• Mini

This program is used to quickly wash (30 minutes) a small amount of lightly soiled cotton garments.

Special programs

For specific applications, you can select any of the following programs:

• Rinse

This program is used when you want to rinse or starch separately.

• Pump+spin

This program spins with maximum possible rpm in the default setting after the water drains from the machine.

❗ You should use a lower spin speed for delicate laundries.

Spin Speed selection

You can have your clothes spun at the maximum rpm selection on your machine by using the selection knob in models equipped with an rpm selection knob. In order to protect your clothes, your machine will not spin above 800 rpm on synthetic programs and 600 rpm on woolens program. Furthermore, if you want to skip the spin cycle and take your clothes out, turn the rpm selection knob to “no spin” position.

In machines not equipped with a spin

Program selection and consumption table

Programme		Max. Load (kg)	Programme Duration (~min)	Water Consumption (l)	Energy Consumption (kWh)	Prewash	Rinse Plus	Rinse Hold	Spin speed reduction	No Spin	No Heat
Cottons	90	5	155	45	1.70	•	•	•	•	•	•
Cottons	60**	5	140	45	0.95	•	•	•	•	•	•
Cottons	40	5	150	45	0.65	•	•	•	•	•	•
Super	40	5	180	45	0.65				•	•	•
Synthetics	60	2.5	120	55	0.90	•	•	•	•	•	•
Synthetics	40	2.5	125	55	0.55	•	•	•	•	•	•
Delicate	30	2	85	60	0.40		•	•	•	•	•
Woollens	40	1.5	75	60	0.40		•	•	•	•	•
Hand wash	30	1	55	50	0.21				•	•	•
Mini	30	2.5	30	40	0.16				•	•	•

• : Selectable

* : Automatically selected, not cancellable.

** : Energy Label programme (EN 60456)

Water and power consumption and programme duration may differ from the table shown, subject to changes in water pressure, water hardness and temperature, ambient temperature, type and amount of laundry, selection of auxiliary functions, and fluctuations in the supply voltage.

ⓘ The auxiliary functions in the table may differ according to the model of your machine.

Auxiliary functions

Auxiliary function selection keys

- Desired auxiliary function depending on the program is selected.
- Some combinations cannot be selected together.
- Warning signal on the selected auxiliary function will light up.

Auxiliary function buttons may differ according to the model of your machine.

Auxiliary function selection

If an auxiliary function that should not be selected together with a previously selected function is chosen, the first selected function will be cancelled and the last auxiliary function selection will remain active.

Auxiliary function that is not compatible with the program cannot be selected. (see, "Program Selection Table")

Pre-wash

A pre-wash is only worthwhile for heavily soiled laundry. Without pre-wash you save energy, water, detergent and time.

- ① Pre-wash without detergent is recommended for lace and curtains. Less detergent should be put in the main wash compartment as loose knit fabrics (lace) foam too much due to its meshed structure.

Rinse Plus

With this function, you can increase the number of current rinsing steps. Thus, sensitive skins' risk of being affected by the remainder detergent on the clothes will be decreased.

Rinse hold

If you do not want to unload your clothes immediately after the cotton, synthetics, woolen and delicate fabrics program, you may release your clothes inside the machine in the last rinsing water by pressing the rinse hold button in order to prevent your clothes become wrinkled. After this process you may spin your laundry by pressing "Start/Pause/Cancel" button or you may end

the program by pressing "Start/Pause/Cancel" button for 3 sec.

- In the machines equipped with spin speed selection knob or button, you can spin by selecting the desired spin speed and press "Start/Pause/Cancel" button.
- As for machines not equipped with a spin speed selection knob, you can end the program without a spin cycle by pressing the "Start/Pause/Cancel" button and draining the water. If you wish your clothes be spun, you can spin them by selecting "pump+spin" program.

Reducing Speed

You may use the speed reduction button whenever you wish to spin your clothes below the maximum spin speed. When speed reduction button is pressed, spin speed will be at the minimum rpm given on the panel.

No spin

You may use this program if you do not want to spin your clothes at the end of cottons, synthetics, woolen or delicate programs.

No Heat

If you wish to wash your clothes in cold water, you can use this program.

Starting the Program

1. Press "Start/Pause/Cancel" button to start the program.
2. "Start/Pause/Cancel" button will light up to indicate that the program has started.
3. The door is locked and the "Lid" light fades.

Progressing a program

Progress of a running program is shown through the program follow-up indicator.

- At the beginning of every program step, the relevant indicator lamp will light up and light of the completed step will turn off. The symbol that is lit up at the far right of the series of symbols indicates the step that is being carried out.

The "Wash" light on the program follow-up indicator illuminates when "Start/Pause/Cancel" button is pressed after selecting the washing program. The "Program finished" lamp illuminates and the "Wash" light will fade when the program comes to an end. The "Lid" light flashes. Meanwhile, the door will stay locked for your safety and when it is safe to open, the "Lid" and "Program Finished" lights remain on.

You can put your machine into "Pause" mode by pressing the "Start/Pause/Cancel" button when it is operating. In this case, the "Start/Pause/Cancel" light will flash. Some changes in program settings can be made in pause mode (See. Changing a Program) and if "Pause" mode is entered at an appropriate step of the program, the adding laundry function may be used. (See, Adding and taking out laundry). Press "Start/Pause/Cancel" button again to return to the "Wash" mode from "Pause" mode. In this case the "Start/Pause/Cancel" button will light up continuously and the machine will resume operating from the step it was paused.

- If the machine is not spinning, the program may be in rinse hold mode or the automatic spin correction system has been activated because of unbalanced distribution of laundry in the machine.

Changing the program after the program has started

You can use this feature after your machine has started to wash different textile groups in the same batch of clothes under higher or lower temperatures.

For example;

Press and hold the "Start/Pause/Cancel" button for 3 seconds to "Cancel" the program in order to select "Cottons 40" program instead of "Cottons 60"

program.

Select the "Cottons 40" program by rotating the program knob.

Press "Start/Pause/Cancel" button to start the program.

- ❗ The program which is selected first will go on even if the program selection button is moved and another program mode is selected while the machine is operating. You must cancel the ongoing program in order to change the washing program. (See, Canceling a Program)

Selecting or cancelling an auxiliary function/temperature/spin speed

1. Press the "Start/Pause/Cancel" button to switch the machine to "Pause" mode.
 2. Change the auxiliary function's temperature and spin speed.
- Press "Start/Pause/Cancel" button to start the program.

- ❗ The selection to be made must be appropriate. For example, if your machine is on the main wash cycle, you may select additional rinse auxiliary function, but you cannot select pre-wash.
- ❗ The spin speed and temperature which are selected first will keep on being valid even if the position of the spin speed or temperature selection knob is changed. Press the "Start/Pause/Cancel" button and switch the machine to "Pause" mode in order to change the spin speed or temperature. New spin speed or temperature can be selected.

Adding/removing laundry in standby mode

If you want to add more laundry into the machine after the washing cycle has started, put the machine into "Pause" mode by pressing the "Start/Pause/Cancel" button. The "Lid" lamp on the program follow-up indicator will light up

steadily after 1-2 minutes if the water level in the machine is suitable. Laundry may be added or taken out by opening the door. If the "Lid" lamp does not light up continuously at the end of this time, the water level in the machine is not suitable and laundry cannot be added. You can resume the program by pressing the "Start/Pause/Cancel" button again.

Child-proof lock

There is a childproof lock to prevent any program interruption because of pressing the keys while the program is on. In order to activate the childproof lock, press on the 1st and 2nd auxiliary function keys from the left simultaneously for 3 seconds after the washing program has started. 1st auxiliary function light will flash continuously.

To start a new program after the program is over or to interfere the program, childproof lock should be deactivated. To deactivate the child-proof lock, press the same buttons for 3 sec.

Ending the program through canceling

The program which is selected first will keep on going even if the position of the program selection button is changed. A new program can be selected or started after "Program is cancelled" in order to change the washing program.

To cancel any selected program;

- Press "Start/Pause/Cancel" button for 3 seconds. The machine starts to discharge the water. "Wash" and "Program Finished" lights will light up.
- "Start/Pause/Cancel" and "Wash" lights will go off after discharging process is over and the "Lid" light will start flashing.
- "Lid" lamp will light up continuously when the door is unlocked. You can select and start a new program.

- If the program is cancelled in the middle of the process, "Wash" and "Program Finished" lights will light up. The machine can drain all the water or can take in water for 3 times at most to cool down the clothes and complete draining process.
- When the water discharging process is completed, the "Wash" light will go off, "Program Finished" light will light up and the "Lid" light will continuously flash until the door is unlocked. You can make a new program selection when the "Lid" light is illuminated continuously.

End of Program

The "Program Finished" lamp on the program follow-up indicator will light up when the program comes to an end.

The lid is unlocked 2 minutes later, the "Program Finished" and "Lid" lamps will light up continuously. The machine is now ready for a second cycle.

If any key is pressed when the machine is at the end of the program or if the position of the selection knob is changed, the "Program Finished" light will go off and only the "Lid" lamp will remain as lit. Meanwhile, if the door is still locked, the "Lid" light will continue flashing until the door is opened. Press the "On/Off" button to shut down the machine.

6 Quick instructions for daily use

Preparation

1. Turn the tap on completely. Check if the hoses are connected tightly.
2. Place the laundry in the machine.
3. Add detergent and softener.

Starting

1. Press the "On/Off" button.
2. Select the programme and the temperature.
3. If required (according to your machine's model):
 - select any auxiliary function,
 - adjust the spin speed,
 - set the time delay,
4. Close the loading door.
5. Press Start/Pause/Cancel button.

Canceling a program

- Press "Start/Pause/Cancel" button for 3 seconds. The machine starts to discharge the water. "Wash" and "Program Finished" lights will light up.
- "Start/Pause/Cancel" and "Wash" lights will go off after discharging process is over and the "Lid" light will start flashing.
- If the program is cancelled in the middle of the process, "Wash" and "Program Finished" lights will light up. The machine can drain all the water or can take in water for 3 times at most to cool down the clothes and complete draining process. When water discharging process is completed, "Wash" light will go off, "Program Finished" light will light up and the "Lid" light will continuously flash until the door is allowed to be opened. You can make a new program selection when the "Lid" light is lit continuously.

Adding more laundry

You may add more laundry into the machine at the beginning of washing.

- ⓘ Machine allows adding more laundry during a later step only if the water level is low enough to open the loading door or if the temperature in the machine is low enough.

In order to add laundry after the start-up of the program:

1. Press Start/Pause/Cancel button. Wait until the door is allowed to open. "Lid" lamp will light up continuously when the door is allowed to open.
2. Open the loading door and put in more laundry.
3. Close the loading door.
4. Press Start/Pause/Cancel button.

Program is in rinse hold mode

- ⓘ After the machine fills with water in the final rinse step, clothes can be soaked in the machine as long as desired.

When it reaches this position while the machine is running, the "Start/Pause/Cancel" light will flash.

In the machines equipped with spin speed selection knob, you can spin by selecting the desired spin speed and press "Start/Pause/Cancel" button. As for machines not equipped with a spin speed selection knob, you can end the program without spinning by pressing the "Start/Pause/Cancel" button to drain the water. You may spin your clothes whenever you wish to by selecting the spin program.

Re-spinning the laundry

The control system for an unbalanced load can pause the spinning in cases when the distribution of the laundry in the drum is not balanced.

If you want to re-spin the clothes:

1. Rearrange the previously placed clothes in machine.
2. Select Spin+Pump program.

3. Set the spin speed if spin speed adjustment is available on your machine.
4. Press “Start/Pause/Cancel” button.

After the program is finished

1. “Program finished” lamp will light up on the program follow-up indicator. The lid can be opened after 2 minutes when the “Program Finished” and “Lid” lamps light up continuously.
2. Press the On/Off button to shut down the machine.
3. Turn the water tap off.
4. Eliminate any folding of the rubber seal on the loading door and check for impurities.
5. Leave the loading door and detergent drawer open to dry.

7 Cleaning and care

Detergent drawer

Remove any powder residue buildup in the drawer. To do this;

1. Press the dotted point on the siphon in the softener compartment and pull towards you until the compartment is removed from the machine.

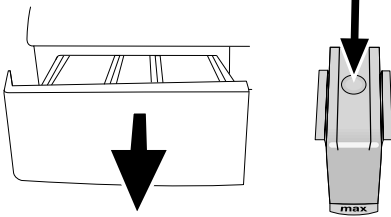

- ❗ If more than a normal amount of water and softener mixture starts to gather in the softener compartment, the siphon must be cleaned.
2. Wash the dispenser drawer and the siphon with plenty of lukewarm water in a washbasin. Wear protective gloves or use an appropriate brush to avoid touching the residues in the drawer when cleaning.
3. Replace the drawer into its housing after cleaning. Check if the siphon is in its original location.

The loading door and the drum

After each wash:

- Check if there are any foreign substances in the drum.
 - Open the hole in the bellow with the aid of a toothpick if it is clogged.
- ❗ Foreign metal substances in your machine can cause rust stains. In such cases:
Clean the drum with a stainless steel cleaning agent. Never use steel wool or wire wool.

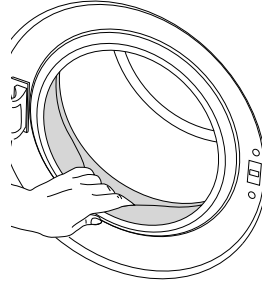

Body and control panel

When necessary:

- Wipe the exterior panels of your machine with soapy water or mild detergent. Dry it with a soft cloth.
 - Use only a soft and damp cloth to clean the control panel.
- ❗ Never use a sponge or scrubbing material. These will damage the painted and plastic parts.

Inlet water filters

There is a filter at the end of each water intake valve at the back side of the machine and also at the end of each water intake hose where they are connected to the tap. These filters prevent the foreign substances and dirt in the water to enter into the machine. Filters should be cleaned as they get dirty.

- Close the taps.
- Remove the nuts of the water intake hoses to clean the surfaces of the filters on the water intake valves with an appropriate brush.
- If the filters are very dirty, you can pull them out by means of pliers and clean them.
- Take out the filters on the flat ends of the water intake hoses together with the gaskets and clean thoroughly under streaming water.
- Replace the gaskets and filters carefully to their places and tighten the hose nuts by hand.

Draining any remaining water and cleaning the pump filter

Filter system in your machine prevents solid items such as buttons, coins and fabric fibers clogging the pump propeller during discharging of the washing water. Thus, a good water discharger is achieved and the pump life is extended.

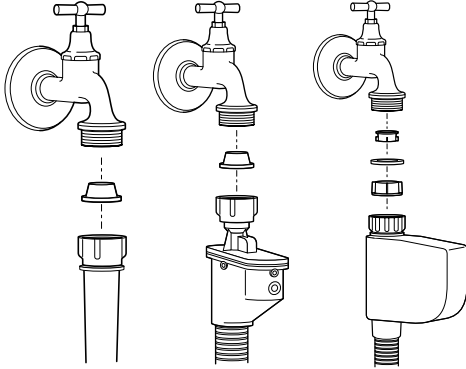

- If your machine fails to drain the water, the pump filter may be clogged. You may have to clean it every 2 years or whenever it is plugged. Water must be drained off to clean the pump filter.

In addition, water may have to be drained off completely in the following cases:

- before transporting the machine (e.g. when moving house)
- when there is the danger of frost

In order to clean the dirty filter and discharge the water;

1- Unplug the machine to cut off the supply power.

- ⚠ There may be water at 90°C in the machine. Therefore, the filter must be cleaned only after the inside water is cooled down to avoid hazard of scalding.

2- Open the filter cap. The filter cap may be composed of one or two pieces according to the model of your machine. If it is composed of two pieces, press the tab on the filter cap downwards and pull the piece out towards yourself.

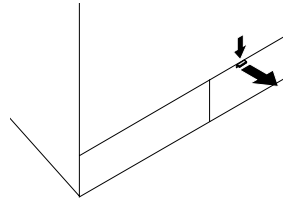

If it is composed of one piece, hold it from both sides and open it by pulling out.

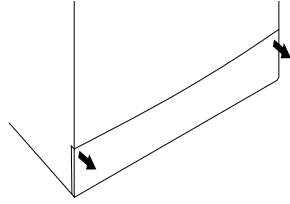

3- An emergency drain hose is supplied with some of our models. Others are not supplied with this item.

If your product is supplied with an emergency drain hose, do the following as shown in the figure below:

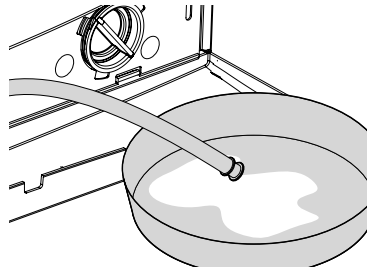

- Pull out the pump outlet hose from its housing.
- Place a large container at the end of the hose. Drain the water off into the container by pulling out the plug at the end of the hose. If the amount of water to be drained off is greater than the volume of the container, replace the plug, pour the water out, then resume the draining process.
- After draining process is completed, replace the plug into the end of the

hose and fit the hose back into its place.

If your product is not supplied with an emergency drain hose, do the following as shown in the figure below:

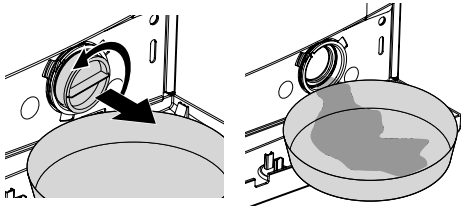

- Place a large container in front of the filter to receive water flowing from the filter.
- Loosen pump filter (anticlockwise) until water starts to flow out of it. Direct the flowing water into the container you have placed in front of the filter. You can use a piece of cloth to absorb any spilled water.
- When there is no water left, turn the pump filter until it is completely loose and remove it.
- Clean any residues inside the filter as well as fibers, if any, around the propeller region.
- If your product has a water jet feature, be sure to fit the filter into its housing in the pump. Never force the filter while replacing it into its housing. Fit the filter fully into its housing; otherwise, water may leak from the filter cap.

4- Close the filter cap.

Close the two-piece filter cap of your product by pushing the tab on it.

Close the one-piece filter cap of your product by fitting the tabs on the bottom into their positions and pushing the upper part of it.

8 Troubleshooting

Problem	Cause	Explanation / Suggestion
Program cannot be started or selected.	Machine may have switched to self protection mode due to an infrastructure problem (such as line voltage, water pressure, etc.).	Reset your machine by pressing "Start/Pause/Cancel" button for 3 seconds. (see, Canceling a Program)
Water in the machine.	There may be some water in your machine when you receive it. This is from the quality control process and is normal.	It is not harmful to your machine.
There is water coming from the bottom of the machine.	There might be problems with hoses or the pump filter.	Be sure the seals of the water inlet hoses are securely fitted. Tightly attach the drain hose to the tap. Make sure that the pump filter is completely closed.
Machine does not fill with water.	Tap may be turned off.	Open the inlet water taps fully.
	Water inlet hose might be bent.	Flatten the water intake hose.
	Water inlet filter might be clogged.	Clean the water intake filter.
	The loading door may be ajar.	Close the loading door.
Machine does not discharge water.	Water outlet hose might be clogged or twisted.	Clean or flatten the hose.
	Pump filter may be clogged.	Clean the pump filter.
Machine vibrates or shakes.	Machine feet might have not adjusted.	Adjust the machine feet.
	Transportation safety bolts might have not been removed.	Remove the transportation safety bolts.
	There may be a small amount of laundry in the machine.	Add more laundry to the machine.
	The machine may be overloaded or the clothes may be distributed unevenly.	Reduce the amount of laundry in the machine or balance the load by hand.
	There machine might be touching a solid surface	Ensure that nothing touches the machine.
Machine stopped shortly after the program started.	Machine can stop temporarily due to low voltage.	It will resume operating when the voltage is back to the normal level.

The water being taken in is directly discharged.	Improper position of the drain hose.	Connect the water draining hose as described in the operation manual.
No water can be seen in the machine during washing.	This is not a problem. The water level is not visible from the outside of the machine.	
The door is jammed.	Water level might be above the lower level of the door.	Run either the "Pump" or "Spin" program.
	Machine might be heating up the water or it may be at the spinning cycle.	Wait until the process is over.
	Due to an electrical mechanism, the door can only be opened a few minutes after the program has stopped.	Wait until the process is over.
Machine fills with water when a process is cancelled.	Inside of machine may be hot.	For safety reasons, water should be cycled in and out a couple times.
Washing time takes longer than the time specified in the manual	Water pressure may be low.	The machine will wait until there is a sufficient amount of water, which may lengthen the washing time to avoid poor washing results due to insufficient water.
	Supply voltage may be low.	Washing time is lengthened to avoid poor washing results when the supply voltage is low.
	Input temperature of water may be low.	Cycle time lengthens to heat up the water when the input water is cold. Also, washing time can be lengthened to avoid poor washing results.
	There may be an imbalance of laundry in the machine.	The automatic spin correction system might have been activated due to the unbalanced distribution of the laundry in the drum. The laundry in the drum may be clustered (bundled laundry in a bag). Laundry should be rearranged and re-spun. No spinning is performed when the laundry is not evenly distributed in the drum to prevent any damage to the machine and to its environment.
	Number of rinses and/or amount of rinse water might have increased.	Water amount is increased to obtain a better rinse and a rinse cycle is added when necessary.

It continuously washes. Remaining time does not count down.	In the case of a paused countdown while taking in water: Timer will not countdown until the machine is filled with the correct amount of water.	The machine will wait until there is a sufficient amount of water to avoid poor washing results due to lack of water. Then the timer will start to count down.
	In the case of a paused countdown at the heating step: Time will not count down until the selected temperature for the program is reached	
	In the case of a paused countdown at the spinning step: There may be an imbalance of laundry in the machine.	The automatic spin correction system might have been activated due to the unbalanced distribution of the laundry in the drum. The laundry in the drum may be clustered (bundled laundry in a bag). Laundry should be rearranged and re-spun. No spinning is performed when the laundry is not evenly distributed in the drum to prevent any damage to the machine and to its environment.
It continuously spins. Remaining time does not count down.	There may be an imbalance of laundry in the machine.	The automatic spin correction system might have been activated due to the unbalanced distribution of the laundry in the drum. The laundry in the drum may be clustered (bundled laundry in a bag). Laundry should be rearranged and re-spun. No spinning is performed when the laundry is not evenly distributed in the drum to prevent any damage to the machine and to its environment.
It did not spin.	There may be an imbalance of laundry in the machine. Therefore, the program might have been completed without spinning.	The automatic spin correction system might have been activated due to the unbalanced distribution of the laundry in the drum. The laundry in the drum may be clustered (bundled laundry in a bag). Laundry should be rearranged and re-spun. No spinning is performed when the laundry is not evenly distributed in the drum to prevent any damage to the machine and to its environment.
	The machine will not spin if the water has not completely drained.	<ul style="list-style-type: none"> - Check the filter. - Check the drain hose.

<p>Washing performance is poor: Laundry turns gray</p>	<ul style="list-style-type: none"> - Using insufficient amount of detergent for a long time, - Washing at low temperatures for a long time, - Using insufficient amount of detergent for hard waters (soil can stick to the laundry), - Using excessive amount of detergent (detergent can stick to the laundry). 	<ul style="list-style-type: none"> - Use the recommended amount of detergent appropriate for water hardness and the laundry. - Select the proper temperature for the laundry to be washed. - If the water hardness is high, using an insufficient amount of detergent can cause laundry to turn gray over time. - It is difficult to eliminate such grayness once it occurs.
<p>Washing performance is poor: Stain could not be removed, not cleaned. Laundry could not be whitened.</p>	<p>Insufficient amount of detergent used.</p>	<p>Use recommended amount of detergent appropriate for the laundry.</p>
	<p>Excessive laundry loaded into machine</p>	<p>Do not load the machine in excess.</p>
	<p>Wrong program and temperature might have been selected.</p>	<p>Select the proper program and temperature for the laundry to be washed.</p>
	<p>Improper detergent may have been used.</p>	
<p>Washing performance is poor: Oily stains appear on laundry.</p>	<p>Oily accumulations on the drum may have stuck to the laundry.</p>	<p>Such odors and bacteria layers may be formed on the drum as a result of continuous washing at lower temperatures and/or in short programs. Leave the detergent dispenser drawer as well as the loading door of the machine ajar after each washing. Thus, a humid environment favorable for bacteria cannot be created inside the machine. Machine must be operated empty either at 60°C or 90°C program with detergent every 6 months.</p>
<p>Washing performance is poor: Bad odor</p>	<p>Oily accumulations on the drum may have stuck to the laundry.</p>	<p>Machine must be operated empty either at 60°C or 90°C program with detergent every 6 months.</p>
<p>Color of the clothes faded.</p>	<p>Excessive laundry might have been loaded in.</p>	<p>Do not overload the machine.</p>
	<p>Detergent may have gotten damp.</p>	<p>Store detergent in a closed and dry place. Do not keep them under high temperatures.</p>
	<p>A higher temperature might have been selected.</p>	<p>Select the proper program and temperature according to the type and soiling degree of the laundry.</p>

It does not rinse well.	The amount, brand and storage conditions of the detergent used might not be appropriate.	Store detergent in a closed and dry place. Do not keep them under high temperatures.
	Detergent might have been put in the wrong compartment.	If detergent is put in the prewash compartment although prewash cycle is not selected, the machine can take this detergent during rinsing or softener step.
	Machine filter may be clogged.	Check the filter.
	Drain hose may be folded.	Check the drain hose.
	Intermediate spins may be skipped.	There may be an imbalance of laundry in the machine. The laundry in the drum may be clustered (bundled laundry in a bag). Laundry should be rearranged and re-spun. No spinning is performed when the laundry is not evenly distributed in the drum to prevent any damage to the machine and to its environment.
Clothes stiffened.	Insufficient amount of detergent used.	If the water hardness is higher, using insufficient amount of detergent can cause the laundry to become stiff in time. Use appropriate amount of detergent according to the water hardness.
	The detergent may have been placed into the wrong compartment; the detergent may be mixed with the softener.	If detergent is put in the prewash compartment although prewash cycle is not selected, the machine can take this detergent during rinsing or softener step. Softener should not come into contact with detergent when being added. Wash and clean the drawer with hot water.
Clothes do not smell like the softener.	Insufficient amount of detergent used.	If the water hardness is higher, using insufficient amount of detergent can cause the laundry to become stiff in time. Use appropriate amount of detergent according to the water hardness.
	The detergent may have been placed into the wrong compartment; the detergent may be mixed with the softener.	If detergent is put in the prewash compartment although prewash cycle is not selected, the machine can take this detergent during rinsing or softener step. Softener should not come into contact with detergent when being added. Wash and clean the drawer with hot water.

Detergent residue in the dispensing drawer.	Detergent may have been put in wet dispenser drawer.	Dry the detergent drawer before putting in detergent.
	Detergent may have gotten damp.	Store detergent in a closed and dry place. Do not keep them under high temperatures.
	Water pressure might be low	
	The detergent in the main wash compartment might have gotten wet while taking in the prewash water..	The detergent dispenser outlet (holes) may have a problem. There might be problems with the detergent dispenser valves.
	Detergent might be mixed with the bleaching agent.	Softener should not come into contact with detergent when being added.
There is detergent left on the laundry.	Excessive laundry might have been loaded in.	Do not load the machine in excess.
	Wrong program and temperature might have been selected.	Select the proper program and temperature for the laundry to be washed.
	Wrong detergent may have been used.	Use wool detergents for woolens.
	You may not be using proper detergent for automatic washing machines.	Use only automatic washing machine detergents in your washing machine.
	Excessive amount of	
Machine does work. No light is on.	Detergent may have been used plugged in the mains outlet.	Use only sufficient amount of detergent. Plug should be checked.
	Fuse may have blown may have been used for a small amount of laundry.	Fuse should be checked.
	Power switch may have tripped ON/OFF button might	Use only sufficient amount of detergent. Power switch should be checked.
	Have not been pressed. Detergent may have been stored improperly.	This button must be pressed. Store detergent in a closed and dry location. Do not store in excessively hot places.
The machine does not start after the program was selected and the 'Start/Pause/Cancel' button was pressed.	Type of material being washed (lace items will cause excessive foam due to their meshed structure).	Use smaller amounts of detergent for lace items.
	Detergent might have been put in the wrong compartment.	If you put detergent in the prewash compartment although you have not selected a prewash cycle, the machine can take this detergent during rinsing or softener step.
"Washing" and "Start/Pause/Cancel" lights are flashing after the program is started.	Water may have been cut off after softener being released early.	You can restart your machine by pressing the "Start/Pause/Cancel" button for a short time after. Waiting until the softener is pulled out the softener into the washer early) during the fill or rinse cycles. There might be problems with the valves.
The "Lid" light is flashing.	It shows the safety period until the door lock is opened.	For your safety, the front door can only be opened 2 minutes after the program is completed. The "Lid" light will flash during this period.

Free Manuals Download Website

<http://myh66.com>

<http://usermanuals.us>

<http://www.somanuals.com>

<http://www.4manuals.cc>

<http://www.manual-lib.com>

<http://www.404manual.com>

<http://www.luxmanual.com>

<http://aubethermostatmanual.com>

Golf course search by state

<http://golfingnear.com>

Email search by domain

<http://emailbydomain.com>

Auto manuals search

<http://auto.somanuals.com>

TV manuals search

<http://tv.somanuals.com>