

BELKIN®

Powerline Turbo Ethernet Adapter



User Manual

F5D4071

Table of Contents

1. Introduction	1
Features	1
Product Specifications	2
System Requirements	3
Package Contents	3
2. Installing and Setting Up the Adapters.	4
3. Configuration	8
Diagnose Powerline Network	8
Setting Up Security on a Local HomePlug Device	10
Setting Up Security on a Network HomePlug Device	11
4. Information	14

Introduction

Thank you for purchasing the Powerline Turbo Ethernet Adapter (the Adapter). Most people don't enjoy buying long and expensive Ethernet cables or pulling the cables from one place to another, but the Adapter offers one of the easiest ways to enjoy home or small-business networking. Users can now experience a total network solution with the Adapter. The Powerline Turbo Ethernet Adapter operates on the HomePlug® Powerline Specification 1.0 Turbo standard, providing up to 85Mbps* bandwidth over home AC wiring. Since the home power lines are the most pervasive medium in households with multiple outlets in every room, the Adapter allows multiple home desktop and notebook computers to be networked to share an Internet connection, printers, and files, and play games without any additional wiring.

The installation of the Adapter only requires that a 10/100Mbps network adapter is installed on the computers. This makes the Powerline Turbo Ethernet Adapter compatible with any device, including Mac, Windows, and UNIX machines.

For security, all HomePlug devices are equipped with 56-bit DES encryption. The private home power grid plus encryption makes HomePlug significantly more secure than competing technologies.

The Powerline Turbo Ethernet Adapter provides the best solution for no-new-wires home networking. With easy plug-and-play installation, and the reliability of HomePlug Ethernet's products, the Powerline Turbo Ethernet Adapter is the best solution for high-speed networking.

Features

- Up to 85Mbps* bandwidth over standard home power lines
- Estimated range of 300m in wall power lines
- HomePlug signal easily passes through circuit breaker
- 56-bit DES encryption ensures data security
- Encryption completed by hardware, without sacrifice to bandwidth
- Uses IEEE 802.3 computer interface
- Plug-and-play installation
- HomePlug Powerline Specification 1.0 Turbo-compliant

Introduction

POWERLINE NETWORKING

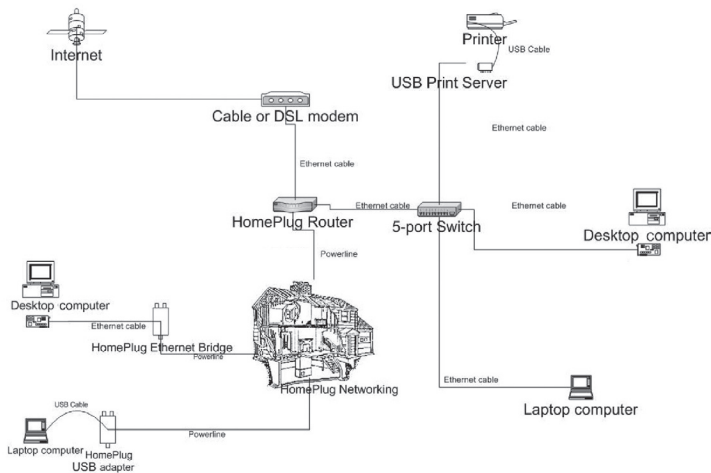

Product Specifications

Computer Interface: IEEE 802.3/802.3u

Operating Temperature: 32–104 degrees F (0–40 degrees C)

Storage Temperature: -4–176 degrees F (-20–80 degrees C)

Humidity: Max. 5%–90% (non-condensing)

Typical Operating Range: Up to 300m in wall power lines

*The standard transmission rate—85Mbps—is the physical data rate. Actual data throughput will be lower.



Powerline Link LED

On	Another HomePlug® unit detected
Blinking	Powerline network activity

Ethernet Link LED

On	Connected to Ethernet
Blinking	Ethernet network activity

System Requirements

- At least 2 HomePlug devices
- Available Ethernet port on each computer or network
- Available power outlet
- Standard home powerline wiring
- CD-ROM drive

Package Contents

- Two Powerline Turbo Ethernet Adapters
- HomePlug Quick Installation Guide
- HomePlug User Manual (on CD)
- Installation CD
- Limited Warranty Card
- Two Power Cables
- Two CAT5/RJ45 Ethernet Cables
- Two Wall Plug Adapters

Installing and Setting Up the Adapters

Overview

Installation of the Powerline Turbo Ethernet Adapter takes only minutes and does not require setting up long wires throughout the house. Simply install the included software CD and after installation, physically plug the unit into the computer and the wall outlet. Users have the option to adjust security functions and the network platform once installation is complete.

Running the InstallShield Wizard

1. Insert the CD into your CD-ROM drive and wait for the setup screen to appear. If the CD-ROM does not automatically run the CD, click on “Start” in the bottom left corner of your screen (for most Microsoft Windows operating systems) and go to “Run”. Type in: “(CD Drive Letter):\eth\setup.exe” and click “OK”.
2. Once the software loads, the following dialog box will appear:

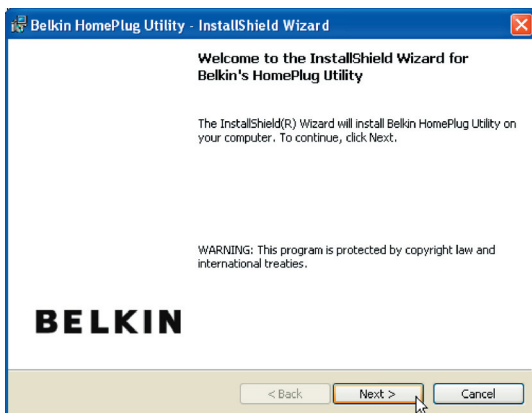

Installing and Setting Up the Adapters

3. Click “Next” to continue the installation:

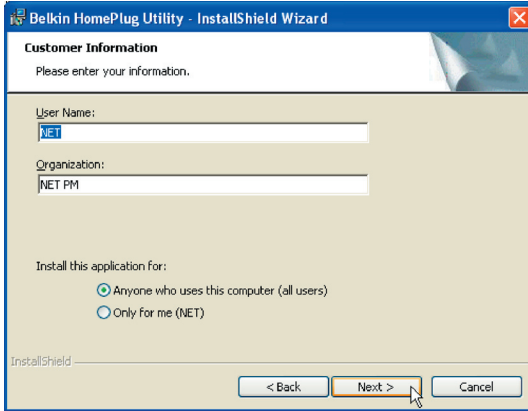

4. Please enter the user name and organization information. The “Install this application for” option is applicable to circumstances in which multiple logins are applied. For example, if you only want to allow yourself access to that particular account, then select “Only for me”. If you don’t have multiple accounts or you want to allow all users to access the utility, choose “Anyone who uses this computer (all users)”. Then, click “Next” to continue.

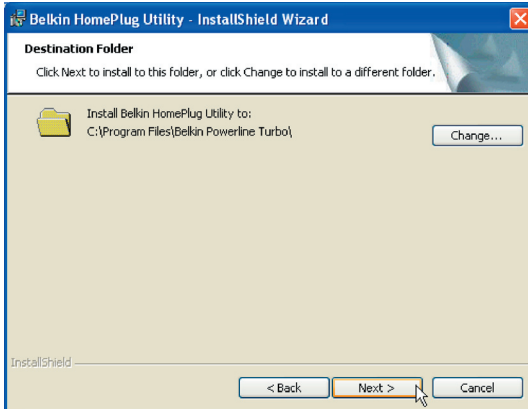

Installing and Setting Up the Adapters

This section allows you to change the default directory where the program is installed. If you don't want to change the directory, click "Next" to continue the installation process.

5. This section allows you to go back to change the settings or to install the utility. If you wish to change the previous options, click "Back". If not, click the "Install" button.
6. Installation is complete. Click "Finish" to exit the wizard. Refer to the following diagrams to set up your hardware connections.

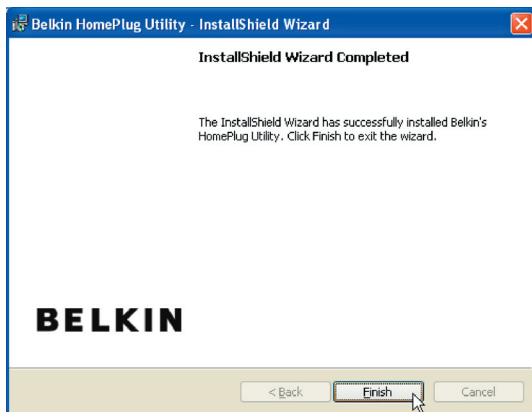

Installing and Setting Up the Adapters

Hardware Setup

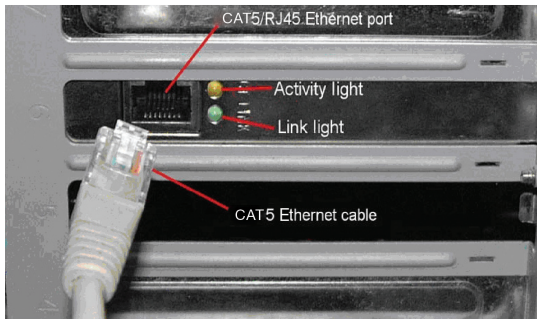

1. Plug your network cable into the computer's RJ45 network adapter port.
2. Plug the other end of your network cable into the RJ45 port located at the back of the Adapter. re Setup
3. Plug the power cable into the power connector at the back of the Adapter.
4. Plug the power plug of your power cable directly into a power outlet in the wall.

NOTE: Do not plug the device into a UPS or power strip with surge protection. The Adapter has its own power filter for protection against surges.

1

2

3

4

section

Configuration

Overview

The Adapter uses 56-bit DES encryption to block access from the outside. The key is set by using the HomePlug Configuration Utility on the CD. By default, the protection is enabled. However, it is recommended that you change the default network password. All your HomePlug devices must use the same network password in order for the computers to be networked. Make sure that all devices are loaded with the same network password.

Diagnose Powerline Network

Part 1: Diagnose a Local HomePlug Device

Double-click the “Belkin HomePlug Utility” icon on your desktop to open the utility shown in the screen below.

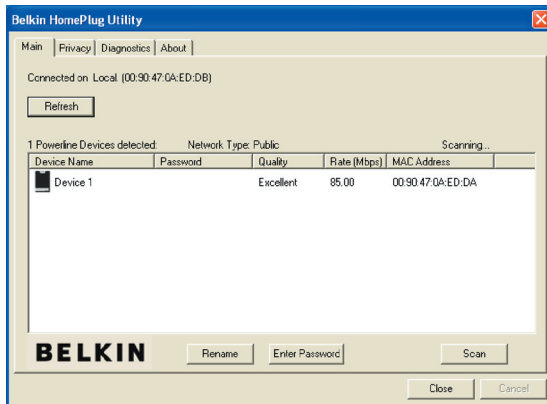

The “Main” tab shows the HomePlug units that are connected to the current computer and other devices on the network. It also tells you the MAC address of each device. It lets you refresh the window, if you change devices, and also allows you to connect to different networks if multiple units are connected to your computer.

Note: If the link quality is poor, and appears red, or the MAC address of any of the units connected to this computer appears to be all 0s, then you may have a defective unit. Please contact technical support.

Note: If you do not see ANY units in the device status, and there is a device connected to your computer, try unplugging and re-plugging all devices. Also make sure that the cable connecting your computer to the HomePlug device is the right type and is working correctly. If everything seems to be correct, and you do not see anything in the “Device” window, try rebooting your computer. If the problem still persists, please contact technical support.

Part 2: Diagnose a Network HomePlug Device

The “Main” tab shows all the other HomePlug units on your powerline network. It represents them by MAC address, and also shows the available bandwidth to each unit (units farther away from the current computer might have a lower data rate). If you add or subtract units from your home network, you might want to re-scan, by clicking the “Scan” button. This will re-scan the network and refresh with any changes.

Note: Only units with the same network password will appear; please verify that they all have the same network password (case-sensitive).

Note: If a unit shows a MAC address of all 0s, this unit may not have a solid connection, or may not connect at all. If this is the case, please contact technical support.

Note: If there are units in your home that do not appear in this network scan, unplug and re-plug all devices (only do this with the units that do not appear in the network screen). If the problem persists, move the unit closer to this current unit (adjacent plugs in the same wall socket is preferred). If the problem still persists and that unit still does not appear on the network, then the unit may be defective and you will need to contact technical support. Otherwise, if you view the unit working, distance might be the only issue.

The networked HomePlug devices can be renamed by selecting the device and clicking “Rename”.

Setting Up Security on a Local HomePlug Device

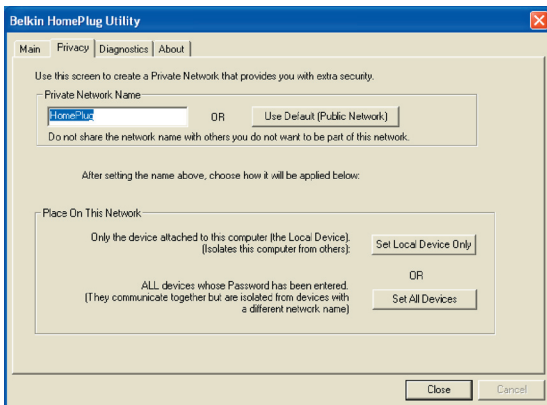

The “Privacy” tab allows you to change the network password to the unit that is currently connected to this computer. This network password encrypts all data that is sent from this unit using 56-bit data encryption standard (DES). The DES encryption is very secure and difficult to crack.

Note: Every unit on your home network MUST have the same network password in order for connectivity to be established throughout your home. The default network password is “HomePlug”.

Setting Up Security on a Network HomePlug Device

1. The “Privacy” tab allows users to use one primary computer to control the network password of all units on the home network.
2. You will have to go back to the “Main” tab first to enter the DEK (Device Encryption Key) for each networked HomePlug device. Select the device and click “Enter Password”.

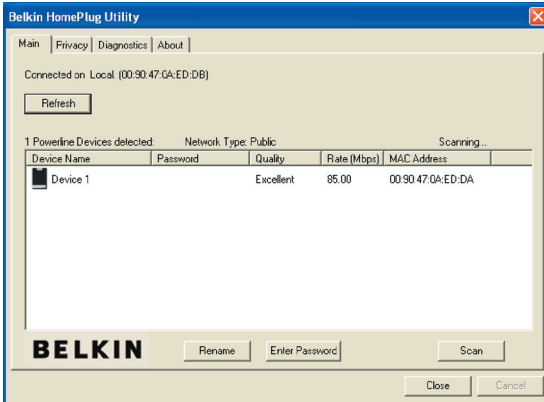

Configuration

3. In the following window, enter the DEK located on the bottom of each device into the “Password” field.



4. You can change the password for all networked devices from one computer using this utility, instead of changing the password individually.

Note: The DEK is unique for EACH HomePlug device. To use this utility, you will need to input the DEK for each unit.

5. The network password can be changed on all devices on which DEKs have been entered. On the “Privacy” tab, simply change the private network name (network password) and click “Set all devices”.

Diagnostics

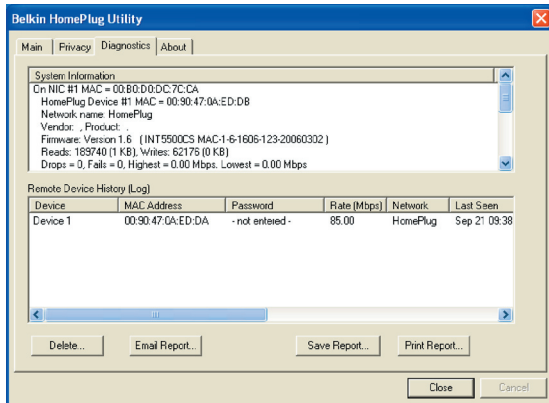

This page provides diagnostics information for your HomePlug network. It also allows you to create, email, and print a report of this information.

Technical Support

You can find technical support information at www.belkin.com/networking or www.belkin.com. If you want to contact technical support by phone, please call:

US: 877-736-5771

800-223-5546 ext. 2263

310-898-1100 ext. 2263

UK: 0845 607 77 87

Australia: 1800 235 546

New Zealand: 0800 235 546

Singapore: 65 64857620

Europe: www.belkin.com/support

Information

FCC Statement

DECLARATION OF CONFORMITY WITH FCC RULES FOR
ELECTROMAGNETIC COMPATIBILITY

We, Belkin International, Inc., of 501 West Walnut Street, Compton, CA 90220, declare under our sole responsibility that the product,

F5D4071

to which this declaration relates, complies with Part 15 of the FCC Rules. Operation is subject to the following two conditions: (1) this device may not cause harmful interference, and (2) this device must accept any interference received, including interference that may cause undesired operation.

Caution: Exposure to Radio Frequency Radiation.

The radiated output power of this device is far below the FCC radio frequency exposure limits. Nevertheless, the device shall be used in such a manner that the potential for human contact during normal operation is minimized.

When connecting an external antenna to the device, the antenna shall be placed in such a manner to minimize the potential for human contact during normal operation. In order to avoid the possibility of exceeding the FCC radio frequency exposure limits, human proximity to the antenna shall not be less than 20cm (8 inches) during normal operation.

Federal Communications Commission Notice

This equipment has been tested and found to comply with the limits for a Class B digital device, pursuant to Part 15 of the FCC Rules. These limits are designed to provide reasonable protection against harmful interference in a residential installation.

This equipment generates, uses, and can radiate radio frequency energy. If this equipment does cause harmful interference to radio or television reception, which can be determined by turning the equipment off and on, the user is encouraged to try and correct the interference by one or more of the following measures:

- Reorient or relocate the receiving antenna.
- Increase the distance between the equipment and the receiver.
- Connect the equipment to an outlet on a circuit different from that to which the receiver is connected.
- Consult the dealer or an experienced radio/TV technician for help.

Modifications

The FCC requires the user to be notified that any changes or modifications to this device that are not expressly approved by Belkin International, Inc., may void the user's authority to operate the equipment.

Europe – EU Declaration of Conformity

This device complies with the essential requirements of the R&TTE Directive 1999/5/EC. The following test methods have been applied in order to prove presumption of conformity with the essential requirements of the R&TTE Directive 1999/5/EC:

- EN60950-1:2001 A11:2004

Safety of Information Technology Equipment



Česky [Czech]	<i>[Jméno výrobce]</i> tímto prohlašuje, že tento <i>[typ zařízení]</i> je ve shodě se základními požadavky a dalšími příslušnými ustanoveními směrnice 1999/5/ES.
Dansk [Danish]	Undertegnede <i>[fabrikantens navn]</i> erklærer herved, at følgende udstyr <i>[udstyrets typebetegnelse]</i> overholder de væsentlige krav og øvrige relevante krav i direktiv 1999/5/EF.
Deutsch [German]	Hiermit erkläre <i>[Name des Herstellers]</i> , dass sich das Gerät <i>[Gerätetyp]</i> in Übereinstimmung mit den grundlegenden Anforderungen und den übrigen einschlägigen Bestimmungen der Richtlinie 1999/5/EG befindet.
Eesti [Estonian]	Käesolevaga kinnitab <i>[tootja nimi = name of manufacturer]</i> seadme <i>[seadme tüüp = type of equipment]</i> vastavust direktiivi 1999/5/EÜ põhinõuetele ja nimetatud direktiivist tulenevatele teistele asjakohastele sätetele.
English	Hereby, <i>[name of manufacturer]</i> , declares that this <i>[type of equipment]</i> is in compliance with the essential requirements and other relevant provisions of Directive 1999/5/EC.
Español [Spanish]	Por medio de la presente <i>[nombre del fabricante]</i> declara que el <i>[clase de equipo]</i> cumple con los requisitos esenciales y cualesquiera otras disposiciones aplicables o exigibles de la Directiva 1999/5/CE.
Ελληνική [Greek]	ΜΕ ΤΗΝ ΠΑΡΟΥΣΑ <i>[name of manufacturer]</i> ΔΗΛΩΝΕΙ ΟΤΙ <i>[type of equipment]</i> ΣΥΜΜΟΡΦΩΝΕΤΑΙ ΠΡΟΣ ΤΙΣ ΟΥΣΙΩΔΕΙΣ ΑΠΑΙΤΗΣΕΙΣ ΚΑΙ ΤΙΣ ΛΟΙΠΕΣ ΣΧΕΤΙΚΕΣ ΔΙΑΤΑΞΕΙΣ ΤΗΣ ΟΔΗΓΙΑΣ 1999/5/ΕΚ.
Français [French]	Par la présente <i>[nom du fabricant]</i> déclare que l'appareil <i>[type d'appareil]</i> est conforme aux exigences essentielles et aux autres dispositions pertinentes de la directive 1999/5/CE.
Italiano [Italian]	Con la presente <i>[nome del costruttore]</i> dichiara che questo <i>[tipo di apparecchio]</i> è conforme ai requisiti essenziali ed alle altre disposizioni pertinenti stabilite dalla direttiva 1999/5/CE.

Information

Latviski [Latvian]	Ar šo [name of manufacturer / izgatavotāja nosaukums] deklarē, ka [type of equipment / iekārtas tips] atbilst Direktīvas 1999/5/EK būtiskajām prasībām un citiem ar to saistītajiem noteikumiem.
Lietuvių [Lithuanian]	Šiuo [manufacturer name] deklaruojau, kad šis [equipment type] atitinka esminius reikalavimus ir kitas 1999/5/EB Direktyvos nuostatas.
Nederlands [Dutch]	Hierbij verklaart [naam van de fabrikant] dat het toestel [type van toestel] in overeenstemming is met de essentiële eisen en de andere relevante bepalingen van richtlijn 1999/5/EG.
Malti [Maltese]	Hawnhekk, [isem tal-manifattur], jiddikjara li dan [il-mudel tal-prodott] jikkonforma mal-htigijiet essenzjali u ma provvedimenti oħrajn rilevanti li hemm fid-Dirrettiva 1999/5/EC.
Magyar [Hungarian]	Alulírott, [gyártó neve] nyilatkozom, hogy a [...] típus] megfelel a vonatkozó alapvető követelményeknek és az 1999/5/EC irányelv egyéb előírásainak.
Polski [Polish]	Niniejszym [nazwa producenta] oświadczam, że [nazwa wyrobu] jest zgodny z zasadniczymi wymogami oraz pozostałymi stosownymi postanowieniami Dyrektywy 1999/5/EC.
Português [Portuguese]	[Nome do fabricante] declara que este [tipo de equipamento] está conforme com os requisitos essenciais e outras disposições da Directiva 1999/5/CE.
Slovensko [Slovenian]	[Ime proizvajalca] izjavlja, da je ta [tip opreme] v skladu z bistvenimi zahtevami in ostalimi relevantnimi določili direktive 1999/5/ES.
Slovensky [Slovak]	[Meno výrobcu] týmto vyhlasuje, že [typ zariadenia] spĺňa základné požiadavky a všetky príslušné ustanovenia Smernice 1999/5/ES.
Suomi [Finnish]	[Valmistaja = manufacturer] vakuuttaa täten että [type of equipment = laitteen tyyppimerkintä] tyyppinen laite on direktiivin 1999/5/EY oleellisten vaatimusten ja sitä koskevien direktiivin muiden ehtojen mukainen.
Svenska [Swedish]	Härmed intygar [företag] att denna [utrustningstyp] står i överensstämmelse med de väsentliga egenskapskrav och övriga relevanta bestämmelser som framgår av direktiv 1999/5/EG.

Belkin International, Inc., Limited Lifetime Product Warranty

What this warranty covers.

Belkin International, Inc. ("Belkin") warrants to the original purchaser of this Belkin product that the product shall be free of defects in design, assembly, material, or workmanship.

What the period of coverage is.

Belkin warrants the Belkin product for the lifetime of the product.

What will we do to correct problems?

Product Warranty.

Belkin will repair or replace, at its option, any defective product free of charge (except for shipping charges for the product).

What is not covered by this warranty?

All above warranties are null and void if the Belkin product is not provided to Belkin for inspection upon Belkin's request at the sole expense of the purchaser, or if Belkin determines that the Belkin product has been improperly installed, altered in any way, or tampered with. The Belkin Product Warranty does not protect against acts of God such as flood, lightning, earthquake, war, vandalism, theft, normal-use wear and tear, erosion, depletion, obsolescence, abuse, damage due to low voltage disturbances (i.e. brownouts or sags), non-authorized program, or system equipment modification or alteration.

How to get service.

To get service for your Belkin product you must take the following steps:

1. Contact Belkin International, Inc., at 501 W. Walnut St., Compton CA 90220, Attn: Customer Service, or call (800)-223-5546, within 15 days of the Occurrence. Be prepared to provide the following information:
 - a. The part number of the Belkin product.
 - b. Where you purchased the product.
 - c. When you purchased the product.
 - d. Copy of original receipt.
2. Your Belkin Customer Service Representative will then instruct you on how to forward your receipt and Belkin product and how to proceed with your claim.

Information

Belkin reserves the right to review the damaged Belkin product. All costs of shipping the Belkin product to Belkin for inspection shall be borne solely by the purchaser. If Belkin determines, in its sole discretion, that it is impractical to ship the damaged equipment to Belkin, Belkin may designate, in its sole discretion, an equipment repair facility to inspect and estimate the cost to repair such equipment. The cost, if any, of shipping the equipment to and from such repair facility and of such estimate shall be borne solely by the purchaser. Damaged equipment must remain available for inspection until the claim is finalized. Whenever claims are settled, Belkin reserves the right to be subrogated under any existing insurance policies the purchaser may have.

How state law relates to the warranty.

THIS WARRANTY CONTAINS THE SOLE WARRANTY OF BELKIN. THERE ARE NO OTHER WARRANTIES, EXPRESSED OR, EXCEPT AS REQUIRED BY LAW, IMPLIED, INCLUDING THE IMPLIED WARRANTY OR CONDITION OF QUALITY, MERCHANTABILITY OR FITNESS FOR A PARTICULAR PURPOSE, AND SUCH IMPLIED WARRANTIES, IF ANY, ARE LIMITED IN DURATION TO THE TERM OF THIS WARRANTY.

Some states do not allow limitations on how long an implied warranty lasts, so the above limitations may not apply to you.

IN NO EVENT SHALL BELKIN BE LIABLE FOR INCIDENTAL, SPECIAL, DIRECT, INDIRECT, CONSEQUENTIAL OR MULTIPLE DAMAGES SUCH AS, BUT NOT LIMITED TO, LOST BUSINESS OR PROFITS ARISING OUT OF THE SALE OR USE OF ANY BELKIN PRODUCT, EVEN IF ADVISED OF THE POSSIBILITY OF SUCH DAMAGES.

This warranty gives you specific legal rights, and you may also have other rights, which may vary from state to state. Some states do not allow the exclusion or limitation of incidental, consequential, or other damages, so the above limitations may not apply to you.

Information

1

2

3

4

section

BELKIN®

Powerline Turbo Ethernet Adapter

BELKIN®

www.belkin.com

Belkin Tech Support

US: 877-736-5771

800-223-5546 ext. 2263

310-898-1100 ext. 2263

UK: 0845 607 77 87

Australia: 1800 235 546

New Zealand: 0800 235 546

Singapore: 65 64857620

Europe: www.belkin.com/support

Belkin International, Inc.

501 West Walnut Street

Los Angeles, CA 90220, USA

310-898-1100

310-898-1111 fax

Belkin Ltd.

Express Business Park, Shipton Way

Rushden, NN10 6GL, United Kingdom

+44 (0) 1933 35 2000

+44 (0) 1933 31 2000 fax

Belkin Ltd.

4 Pioneer Avenue

Tuggerah Business Park

Tuggerah, NSW 2259, Australia

+61 (0) 2 4350 4600

+61 (0) 2 4350 4700 fax

Belkin B.V.

Boeing Avenue 333

1119 PH Schiphol-Rijk, The Netherlands

+31 (0) 20 654 7300

+31 (0) 20 654 7349 fax

Free Manuals Download Website

<http://myh66.com>

<http://usermanuals.us>

<http://www.somanuals.com>

<http://www.4manuals.cc>

<http://www.manual-lib.com>

<http://www.404manual.com>

<http://www.luxmanual.com>

<http://aubethermostatmanual.com>

Golf course search by state

<http://golfingnear.com>

Email search by domain

<http://emailbydomain.com>

Auto manuals search

<http://auto.somanuals.com>

TV manuals search

<http://tv.somanuals.com>