



WI500

Digital Projector

Home Cinema Series

User Manual

Table of contents

Important safety instructions.....	5	Using the projector	29
Overview.....	8	Turning the projector on.....	29
Shipping contents.....	8	Selecting an input source	30
Standard accessories.....	8	Using the menus.....	31
Optional accessories.....	8	Securing the projector.....	31
Replacing the remote control batteries.....	9	Using a security cable lock.....	31
Remote control effective range	9	Utilizing the password function	32
Projector features	11	Adjusting the projected image	34
Projector exterior view	12	Adjusting the projection angle	34
Controls and functions.....	13	Correcting picture distortion.....	34
Control panel	13	Using the preset and user modes	35
Remote control.....	14	Fine-tuning the picture quality	36
Positioning your projector	15	Advanced picture quality controls	38
Choosing a location	15	Adjusting the sound.....	41
Obtaining a preferred projected image size	16	Selecting the aspect ratio	42
How to determine the position of the projector for a given screen size	16	Freezing the image.....	43
How to determine the recommended screen size for a given distance.....	16	Using the test pattern	43
Projection dimensions	18	Magnifying and searching for details ..	43
Shifting the projection lens vertically	20	Operating in a high altitude environment.....	44
Connecting with video equipment	21	Displaying more than one image source simultaneously	45
Preparations.....	21	Watching 3D content	46
Connecting HDMI devices.....	22	Personalizing the projector menu display	47
Connecting component-video devices ...	23	Locking control keys	47
Connecting S-Video or video devices.....	23	Turning the projector off.....	48
Connecting a computer	24	On-Screen Display (OSD) menus.....	49
Using the Wireless		Additional information.....	58
Transmitter	25	Care of the projector	58
Product specification	25	Lamp information.....	59
Supported timing for wireless HDMI input timing	25	Getting to know the lamp hour.....	59
Power indicator	26	Extending lamp life	59
Message and meaning	26	Timing of replacing the lamp	60
Wireless transmitter synchronization	27	Replacing the lamp	61
		Indicators	63
		Troubleshooting.....	64
		Specifications.....	65

Warranty and Copyright
information72

Thank you for your purchase of this quality BenQ video projector! It has been designed to provide you with an enjoyable home theater viewing experience. For the best results, please read this manual through carefully as it is your guide through the control menus and operation.

Important safety instructions

Your projector is designed and tested to meet the latest standards for safety of information technology equipment. However, to ensure safe use of this product, it is important that you follow the instructions mentioned in this manual and marked on the product.

1. Please read this user manual before you operate your projector. Keep this manual in a safe place for future reference.

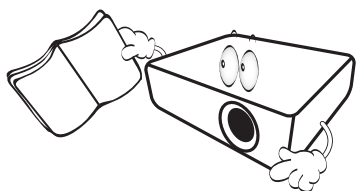

2. Always place the projector on a level, horizontal surface during operation.

- Do not place the projector on an unstable cart, stand, or table as it may fall and be damaged;
- Do not place inflammables near the projector;
- Do not use if tilted at an angle of more than 10 degrees left to right, nor at angle of more than 15 degrees front to back.

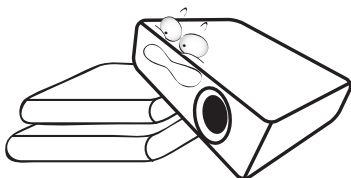

3. Do not store the projector on end vertically. Doing so may cause the projector to fall over, causing injury or resulting in damage.

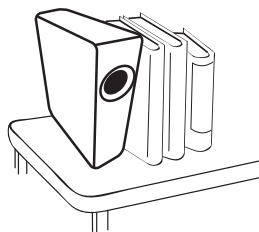

4. Do not place the projector in any of the following environments:

- space that is poorly ventilated or confined. Allow at least 50 cm clearance from walls and free flow of air around the projector;
- locations where temperatures may become excessively high, such as the inside of a car with all windows closed;
- locations where excessive humidity, dust, or cigarette smoke may contaminate optical components, shorten the projector's lifespan and darken the screen;

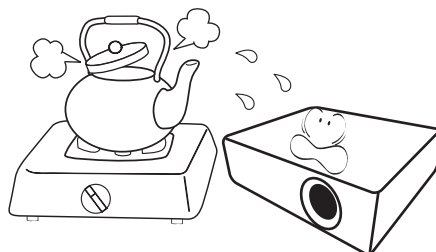

- locations near fire alarms;
- locations with an ambient temperature above 35°C/95°F;
- locations where altitude is higher than 1500 meters/4920 feet above sea level.

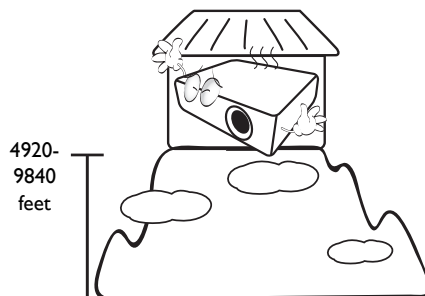

5. Do not block the vents holes while the projector is on (even in standby mode):

- Do not cover the projector with any item;
- Do not place the projector on a blanket, bedding or any other soft surface.

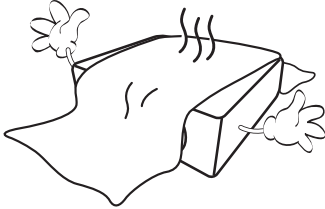

9. Do not look straight into the projector lens during operation. It may harm your sight.

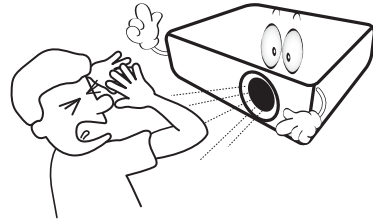

6. In areas where the mains power supply voltage may fluctuate by ± 10 volts, it is recommended that you connect your projector through a power stabilizer, surge protector or uninterruptible power supply (UPS) as appropriate to your situation.

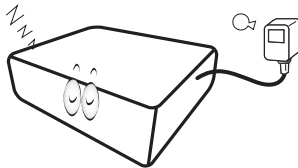

10. Do not operate the projector lamp beyond the rated lamp life. Excessive operation of lamps beyond the rated life could cause a lamp to break on rare occasions.

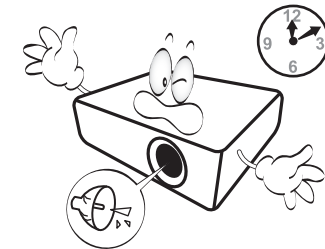

7. Do not step on the projector or place any objects upon it.

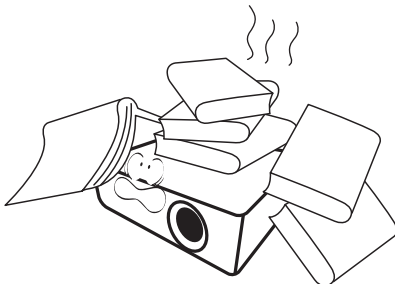

11. The lamp becomes extremely hot during operation. Allow the projector to cool for approximately 45 minutes prior to removing the lamp assembly for replacement.

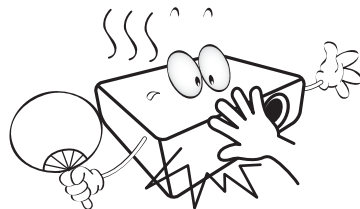

8. Do not place liquids near or on the projector. Liquids spilled into the projector will void your warranty. If the projector does become wet, disconnect it from the power point and call BenQ to have the projector repaired.

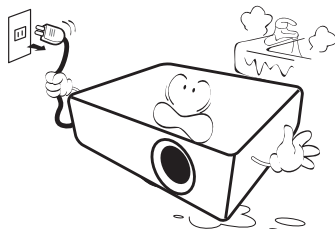

12. This projector is capable of displaying inverted images for ceiling mount installation. Use only BenQ's Ceiling Mount Kit for mounting.

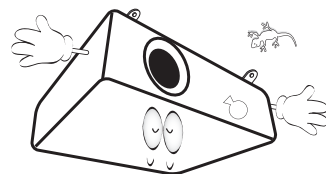

13. Never attempt to replace the lamp assembly until the projector has cooled down and is unplugged from the power supply.

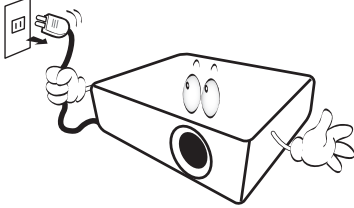

14. When you think service or repair is required, take the projector only to a suitably qualified technician.

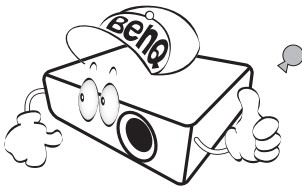

15. Do not attempt to disassemble this projector. There are dangerous high voltages inside which may cause death if you should come into contact with live parts. The only user serviceable part is the lamp which has its own removable cover. See page 61.

Under no circumstances should you ever undo or remove any other covers. Refer servicing only to suitably qualified professional service personnel.

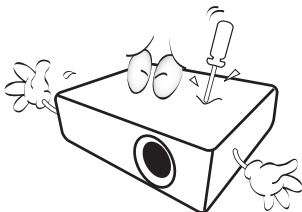

Notice

Please keep the original packing for possible future shipment. If you need to pack your projector after use, adjust the projection lens to an appropriate position, put the lens cushion around the lens, and fit the lens cushion and projector cushion together to prevent damage during transportation.

Moisture condensation

Never operate the projector immediately after moving it from a cold location to a hot location. When the projector is exposed to such a change in temperature, moisture may condense on the crucial internal parts. To prevent the projector from possible damage, do not use the projector for at least 2 hours when there is a sudden change in temperature.

Avoid volatile liquids

Do not use volatile liquids, such as insecticide or certain types of cleaner, near the projector. Do not have rubber or plastic products touching the projector for a long time. They will leave marks on the finish. If cleaning with a chemically treated cloth, be sure to follow the cleaning product's safety instructions.

Disposal

This product contains the following materials which are harmful to human bodies and environment.

- Lead, which is contained in solder.
- Mercury, which is used in the lamp.

To dispose of the product or used lamps, consult your local environment authorities for regulations.

Overview

Shipping contents

Carefully unpack and verify that you have the items below. Some of the items may not be available depending on your region of purchase. Please check with your place of purchase.

Standard accessories

 Some of the accessories may vary from region to region.

The warranty card is only supplied in some specific regions. Please consult your dealer for detailed information.

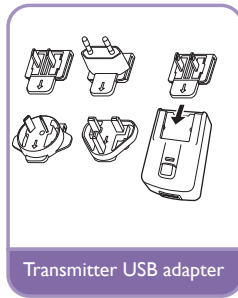
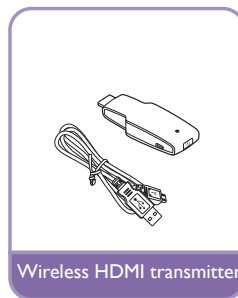
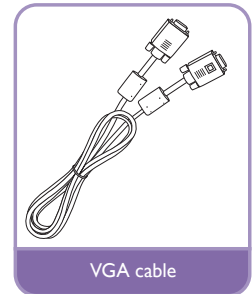
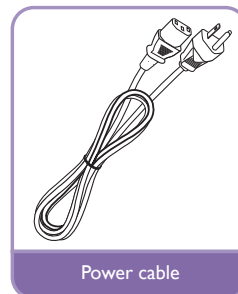
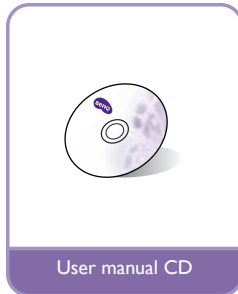
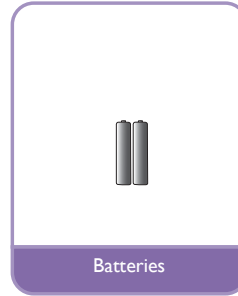
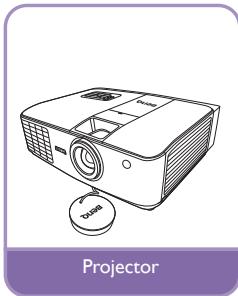

Optional accessories

1. Spare lamp kit
2. RS232 cable
3. Universal ceiling mount kit

Replacing the remote control batteries

1. To open the battery cover, turn the remote control over to view its back, push on the finger grip on the cover and slide it up in the direction of the arrow as illustrated. The cover will slide off.
2. Remove any existing batteries (if necessary) and install two AAA batteries observing the battery polarities as indicated in the base of the battery compartment. Positive (+) goes to positive and negative (-) goes to negative.
3. Refit the cover by aligning it with the base and sliding it back down into position. Stop when it clicks into place.

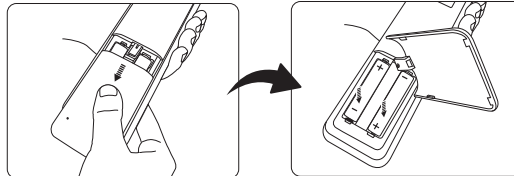

- ⚠ • **Avoid leaving the remote control and batteries in an excessive heat or humid environment like the kitchen, bathroom, sauna, sunroom or in a closed car.**
- **Replace only with the same or equivalent type recommended by the battery manufacturer.**
- **Dispose of the used batteries according to the manufacturer's instructions and local environment regulations for your region.**
- **Never throw the batteries into a fire. There may be danger of an explosion.**
- **If the batteries are dead or if you will not be using the remote control for an extended period of time, remove the batteries to avoid damage to the remote control from possible battery leakage.**

Remote control effective range

The remote control must be held at an angle within 30 degrees perpendicular to the projector's IR remote control sensor(s) to function correctly. The distance between the remote control and the sensor(s) should not exceed 8 meters (~ 26 feet).

Make sure that there are no obstacles between the remote control and the IR sensor(s) on the projector that might obstruct the infra-red beam.

- Operating the projector from the front
- Operating the projector from the top

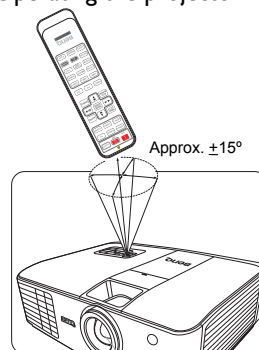
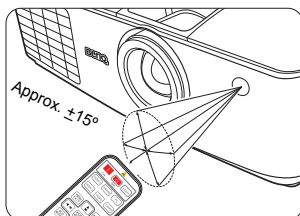

⚠ Ceiling mounting the projector

We want you to have a pleasant experience using your BenQ projector, so we need to bring this safety matter to your attention to prevent damage to person and property.

If you intend to mount your projector on the ceiling, we strongly recommend that you use a proper fitting BenQ projector ceiling mount kit and that you ensure it is securely and safely installed.

If you use a non-BenQ brand projector ceiling mount kit, there is a safety risk that the projector may fall from the ceiling due to an improper attachment through the use of the wrong gauge or length screws.

You can purchase a BenQ projector ceiling mount kit from the place you purchased your BenQ projector. BenQ recommends that you also purchase a separate Kensington lock compatible security cable and attach it securely to both the Kensington lock slot on the projector and the base of the ceiling mount bracket. This will perform the secondary role of restraining the projector should its attachment to the mounting bracket become loose.

Projector features

- **Full HD compatible**

The projector is compatible with Standard Definition TV (SDTV) 576i, Enhanced Definition television (EDTV) 480p, 576p and High Definition TV (HDTV) 720p, 1080i/p 60Hz formats, with the 1080p format providing a true 1:1 image reproduction.

- **High picture quality**

The projector provides excellent picture quality due to its high resolution, excellent home theater brightness, high contrast ratio, vivid color and rich gray-scale reproduction.

- **Vivid color reproduction**

The projector features a 6-segment color wheel to produce realistic color depth and range unattainable with lesser segment color wheels.

- **Rich gray-scale**

When viewed in a darkened environment, the automatic gamma control provides excellent gray-scale images which reveal details in shadows and in night or darkened scenes.

- **Wide variety of inputs and video formats**

The projector supports a wide variety of inputs for connection to your video and PC equipment, including component video, S-Video, and composite video, as well as dual HDMI, PC, and an output trigger for connection to automated screen and environment lighting systems.

- **ISF certified calibration control**

To reach a higher standard of performance, the projector incorporates ISF NIGHT and ISF DAY mode settings in its OSD menus, which requires professional calibration service from authorized ISF installers.

- **3D function**

To enhance your sense of presence when watching 3D movies, videos, and sporting events by presenting the depth of the images through HDMI interface.

- **2D 3D conversion**

With the **2D 3D Conversion** function, you can convert 2D content into 3D images for 3D effect.

- **Wireless**

The projector allows you to wirelessly project the FHD image from HDMI output devices, such as Blu-ray players, DVD players, and desktop PCs, etc.

- **CEC**

When you connect the projector to any HDMI CEC-compatible devices, such as DVD players, activating the **CEC** function enables you to turn both devices on and off with one remote controller.

 **Due to different design of HDMI CEC for each device, some devices might not be able to operate correctly.**

- **Frame interpolation**

With motion estimation and compensation technology, picture smoothness and clarity are enhanced.

- **Built-in speaker(s)**

Built-in speaker(s) provide(s) mixed mono audio when an audio input is connected.

- **Intuitive lens shift**

The intuitive control over lens shift lever provides flexibility in setting-up your projector.

- **SmartEco**

SmartEco™ technology saves lamp power consumption up to 70% depending on the content brightness level when **SmartEco** mode is selected.

Projector exterior view

Front and upper side view

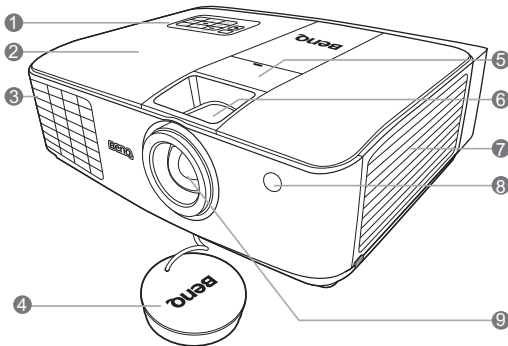

Rear and lower side view

See ["Connecting with video equipment"](#) on page 21 for connection details.

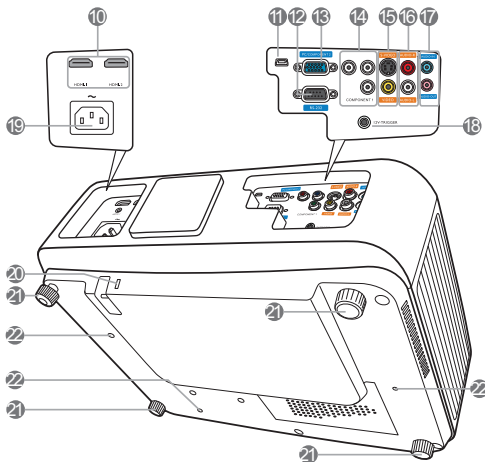

1. Control panel (See ["Control panel"](#) on page 13 for details.)
2. Lamp cover
3. Vent
4. Lens cap
5. Lens shift cover
6. Focus and Zoom ring
7. Vent
8. Front IR sensor
9. Projection lens
10. HDMI ports
11. Mini USB port
(Used for service)
12. RS-232 control port
Used to interface with a PC or home theater control/automation system.
13. RGB (PC)/Component video (YPbPr/YCbCr) signal input jack
14. Component Video inputs (RCA) support Y/Pb/Pr or Y/Cb/CR video signal
15. S-Video input (mini 4-pin DIN)
Composite Video input (RCA)
16. Audio (L/R) input jacks
17. Audio output jack
Audio output jack
18. 12VDC output terminal
Used to trigger external devices such as an electric screen or light control, etc. Consult your dealer for how to connect these devices.
19. AC power cable inlet
20. Kensington lock slot
21. Adjuster feet
22. Ceiling mount holes

Controls and functions

Control panel

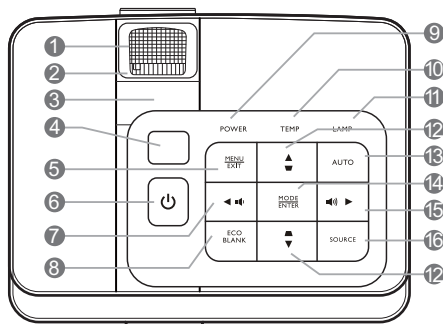

1. Focus ring

Adjusts the focus of the projected image.

2. Zoom ring

Adjusts the size of the image.

3. Lens shift cover

4. Top IR remote sensor

5. MENU/EXIT

Turns on the On-Screen Display (OSD) menu.

Goes back to previous OSD menu, exits and saves menu settings.

6. POWER

Toggles the projector between standby mode and on.

7. ◀ Left/ 🔊

Decreases the projector volume.

When the On-Screen Display (OSD) menu is activated, the #7, #12, and #15 keys are used as directional arrows to select the desired menu items and to make adjustments.

8. ECO BLANK

Used to blank the screen picture.

9. POWER indicator light

Lights up or flashes when the projector is under operation.

10. TEMPERATURE warning light

Lights up red if the projector's temperature becomes too high.

11. LAMP indicator light

Indicates the status of the lamp. Lights up or flashes when the lamp has developed a problem.

12. Keystone/Arrow keys (▼/▲ Up, ▲ / ▼ Down)

Manually corrects distorted images resulting from an angled projection.

When the On-Screen Display (OSD) menu is activated, the #7, #12, and #15 keys are used as directional arrows to select the desired menu items and to make adjustments.

13. AUTO

Automatically determines the best picture timings for the displayed image.

14. MODE/ENTER

Selects an available picture setup mode.

Activates the selected On-Screen Display (OSD) menu item.

15. ▶ Right/ 🔊

Increases the projector volume.

When the On-Screen Display (OSD) menu is activated, the #7, #12, and #15 keys are used as directional arrows to select the desired menu items and to make adjustments.

16. SOURCE

Displays the source selection bar.

Remote control

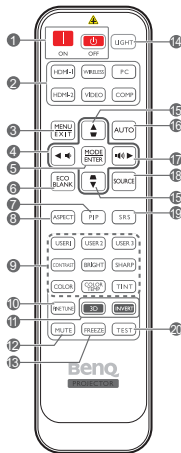

- 1. POWER ON/OFF**
Toggles the projector between on and off mode.
- 2. Source selection keys**
Selects an input source for display.
- 3. MENU/EXIT**
Turns on the On-Screen Display (OSD) menu. Goes back to previous OSD menu, exits and saves menu settings.
- 4. ◀ Left**
Decreases the projector volume.
When the On-Screen Display (OSD) menu is activated, the #4, #15, and #17 keys are used as directional arrows to select the desired menu items and to make adjustments.
- 5. MODE/ENTER**
Selects an available picture setup mode. Activates the selected On-Screen Display (OSD) menu item.
- 6. ECO BLANK**
Used to blank the screen picture.
- 7. PIP**
Displays the **PIP** (Picture In Picture) menu.
- 8. ASPECT**
Selects the display aspect ratio.
- 9. Picture quality adjustment keys**
These function keys perform the same tasks as specified in the OSD menu. For details, please refer to ["Fine-tuning the picture quality" on page 36.](#)
- 10. FINE TUNE**
Displays the **"Color Temperature Fine Tuning"** menu. For details, please refer to ["Setting a preferred color temperature" on page 38.](#)
- 11. 3D/INVERT**
Enters the **"3D"** menu directly and toggles the invert function between on and off.
- 12. MUTE**
Toggles projector audio between on and off.
- 13. FREEZE**
Freezes the projected image.
- 14. LIGHT**
The LED backlight lights up and stays on for approximately 10 seconds when pressing any key on the remote control. Pressing any other keys within the 10-second window turns off the LED backlight.
- 15. Keystone/Arrow keys (▲/▲ Up, ▼ / ▼ Down)**
Manually corrects distorted images resulting from an angled projection.
When the On-Screen Display (OSD) menu is activated, the #4, #15, and #17 keys are used as directional arrows to select the desired menu items and to make adjustments.
- 16. AUTO**
Automatically determines the best picture timings for the displayed image.
- 17. ▶ Right**
Increases the projector volume.
When the On-Screen Display (OSD) menu is activated, the #4, #15, and #17 keys are used as directional arrows to select the desired menu items and to make adjustments.
- 18. SOURCE**
Displays the source selection bar.
- 19. SRS**
Enables or disables the SRS function.
- 20. TEST**
Displays the test pattern.

Positioning your projector

Choosing a location

Your projector is designed to be installed in one of four possible installation locations.

Your room layout or personal preference will dictate which installation location you select. Take into consideration the size and position of your screen, the location of a suitable power outlet, as well as the location and distance between the projector and the rest of your equipment.

1. Front:

Select this location with the projector placed near the floor in front of the screen. This is the most common way to position the projector for quick setup and portability.

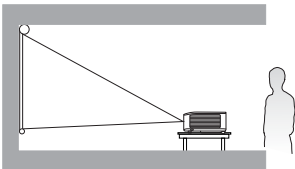

2. Front Ceiling:

Select this location with the projector suspended from the ceiling in front of the screen.

Purchase the BenQ Projector Ceiling Mount Kit from your dealer to mount your projector on the ceiling.

*Set **Front Ceiling** after you turn the projector on.

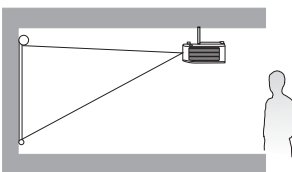

3. Rear:

Select this location with the projector placed near the floor behind the screen.

Note that a special rear projection screen is required.

*Set **Rear** after you turn the projector on.

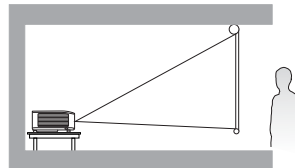

4. Rear Ceiling:

Select this location with the projector suspended from the ceiling behind the screen.

Note that a special rear projection screen and the BenQ Projector Ceiling Mount Kit are required for this installation location.

*Set **Rear Ceiling** after you turn the projector on.

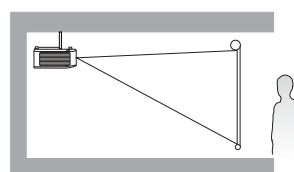

*To set the projector position:

1. Press **MENU/EXIT** on the projector or remote control and then press **◀/▶** until the **System Setup** menu is highlighted.
2. Press **▲/▼** to highlight **Projector Position** and press **◀/▶** until the correct position is selected.

Obtaining a preferred projected image size

The distance from the projector lens to the screen, the zoom setting, and the video format each factors in the projected image size.

The projector should always be placed horizontally level (like flat on a table), and positioned directly perpendicular 90° right-angle square) to the screen. This prevents image distortion caused by angled projections (or projecting onto angled surfaces). If the projector is mounted on a ceiling, it must be mounted upside-down.

If the projector is positioned further away from the screen, the projected image size increases, and the vertical offset also increases proportionately.

When determining the positions of the screen and projector, you will need to account for both the projected image size and the vertical offset dimension, which are directly proportional to the projection distance.

This projector is equipped with a movable lens. See ["Shifting the projection lens vertically" on page 20](#) for details. You can see the diagrams on pages 18 and 19 for the vertical offset values in the dimension tables that are measured when the lens is shifted fully up or down.

How to determine the position of the projector for a given screen size

1. Determine the aspect ratio of your screen, 16:9 or 4:3?
2. Refer to the table and find the closest match to your screen size in the left columns labelled ["Screen dimensions"](#). Using this value, look across this row to the right to find the corresponding average distance from screen value in the column labelled ["Average"](#). This is the projection distance.
3. Decide the exact position of your projector according to the position of your screen and the adjustable lens shift range.

<Example>

If you are using a 120-inch, 4:3-aspect-ratio screen, please refer to ["The screen aspect ratio is 4:3 and the projected picture is 16:9"](#). The average projection distance is 3409 mm.

How to determine the recommended screen size for a given distance

This method can be used for situations where you have purchased this projector and would like to know what screen size will fit in your room.

The maximum screen size is limited by the physical space available in your room.

1. Determine the aspect ratio of your screen, 16:9 or 4:3?
2. Measure the distance between the projector and where you want to position the screen. This is the projection distance.
3. Refer to the table and find the closest match to your measurement in the average distance from screen column labelled ["Average"](#). Check that your measured distance is between the min. and max. distances listed on either side of the average distance value.
4. Using this value, look across that row to the left to find the corresponding screen diagonal listed in that row. That is the projected image size of the projector at that projection distance.

<Example>

If you have a 16:9-aspect-ratio screen and your measured projection distance was 4000 mm, please refer to ["The screen aspect ratio is 16:9 and the projected picture is 16:9"](#). The closest match in the ["Average"](#) column is 4024 mm. Looking across this row shows that a 130-inch screen is required.

Checking the min. and max. projection distance values in the columns of ["Projection distance <D> \[mm\]" on page 18](#) indicates that the 4000 mm measured projection distance will also fit the 120 and 140-inch size screens. The projector can be adjusted (using the zoom control) to display on these different screen sizes at the projection distance. Be aware that these different screens have different vertical offset values.

If you place the projector in a different position (to that recommended), you will have to tilt it down or up to center the image on the screen. In these situations, some image distortion will occur. Use the Keystone function to correct the distortion. See ["Correcting picture distortion" on page 34](#) for details.

Projection dimensions

Installation for a 16:9 ratio screen

Floor Installation

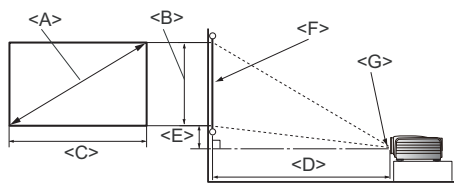

<F>: Screen

<G>: Center of lens

Ceiling Installation

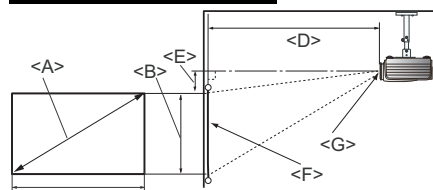

<F>: Screen

<G>: Center of lens

■ The screen aspect ratio is 16:9 and the projected picture is 16:9

Screen dimensions			Projection distance <D> [mm]			Lowest/Highest lens position <E> [mm]
Diagonal <A> [inch (mm)]	Height [mm]	Width <C> [mm]	Min distance (with max zoom)	Average	Max distance (with min zoom)	
42 (1067)	523	930	1000	1300	1600	26
50 (1270)	623	1107	1190	1548	1905	31
60 (1524)	747	1328	1429	1857	2286	37
70 (1778)	872	1550	1667	2167	2667	44
80 (2032)	996	1771	1905	2476	3048	50
84 (2134)	1046	1860	2000	2600	3200	52
90 (2286)	1121	1992	2143	2786	3429	56
100 (2540)	1245	2214	2381	3095	3810	62
110 (2794)	1370	2435	2619	3405	4190	68
120 (3048)	1494	2657	2857	3714	4571	75
130 (3302)	1619	2878	3095	4024	4952	81
140 (3556)	1743	3099	3333	4333	5333	87
150 (3810)	1868	3321	3571	4643	5714	93
160 (4064)	1992	3542	3810	4952	6095	100
170 (4318)	2117	3763	4048	5262	6476	106
180 (4572)	2241	3985	4286	5571	6857	112
190 (4826)	2366	4206	4524	5881	7238	118
200 (5080)	2491	4428	4762	6190	7619	125
250 (6350)	3113	5535	5952	7738	9524	156

☞ The above numbers are approximate and may be slightly different from the actual measurements. Only the recommended screen sizes are listed. If your screen size is not in the table above, please contact your dealer for assistance.

Installation for a 4:3 ratio screen

The illustrations and table below are provided for those users who already have 4:3 aspect ratio screens or intend to purchase 4:3 aspect ratio screens to view 16:9 ratio projected images.

Floor Installation

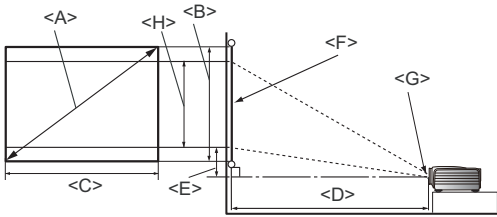

<F>: Screen <G>: Center of lens

Ceiling Installation

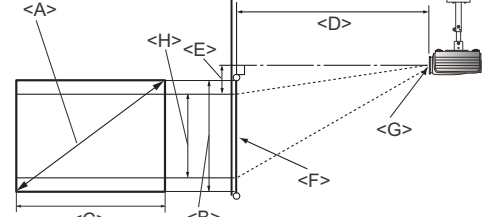

<F>: Screen <G>: Center of lens

■ The screen aspect ratio is 4:3 and the projected picture is 16:9

Screen dimensions			Projection distance <D> [mm]			Lowest/ Highest lens position <E> [mm]	Image height <H> [mm]
Diagonal <A> [inch (mm)]	Height [mm]	Width <C> [mm]	Min distance (with max zoom)	Average	Max distance (with min zoom)		
50 (1270)	762	1016	1093	1421	1748	29	572
60 (1524)	914	1219	1311	1705	2098	34	686
70 (1778)	1067	1422	1530	1989	2448	40	800
80 (2032)	1219	1626	1748	2273	2797	46	914
90 (2286)	1372	1829	1967	2557	3147	51	1029
100 (2540)	1524	2032	2185	2841	3497	57	1143
110 (2794)	1676	2235	2404	3125	3846	63	1257
120 (3048)	1829	2438	2623	3409	4196	69	1372
130 (3302)	1981	2642	2841	3693	4546	74	1486
140 (3556)	2134	2845	3060	3977	4895	80	1600
150 (3810)	2286	3048	3278	4262	5245	86	1715
160 (4064)	2438	3251	3497	4546	5595	91	1829
170 (4318)	2591	3454	3715	4830	5944	97	1943
180 (4572)	2743	3658	3934	5114	6294	103	2057
190 (4826)	2896	3861	4152	5398	6644	109	2172
200 (5080)	3048	4064	4371	5682	6993	114	2286
230 (5842)	3505	4674	5026	6534	8042	131	2629

☞ The above numbers are approximate and may be slightly different from the actual measurements. Only the recommended screen sizes are listed. If your screen size is not in the table above, please contact your dealer for assistance.

Shifting the projection lens vertically

The vertical lens shift control provides flexibility for installing your projector. It allows the projector to be positioned slightly above or below the top level of the projected images.

The lens shift (offset) is expressed as a percentage of the projected image height. It is measured as an offset from the projected image's vertical center. You can use the lever to shift the projection lens upwards or downwards within the allowable range depending on your desired image position.

To use the lens shift lever:



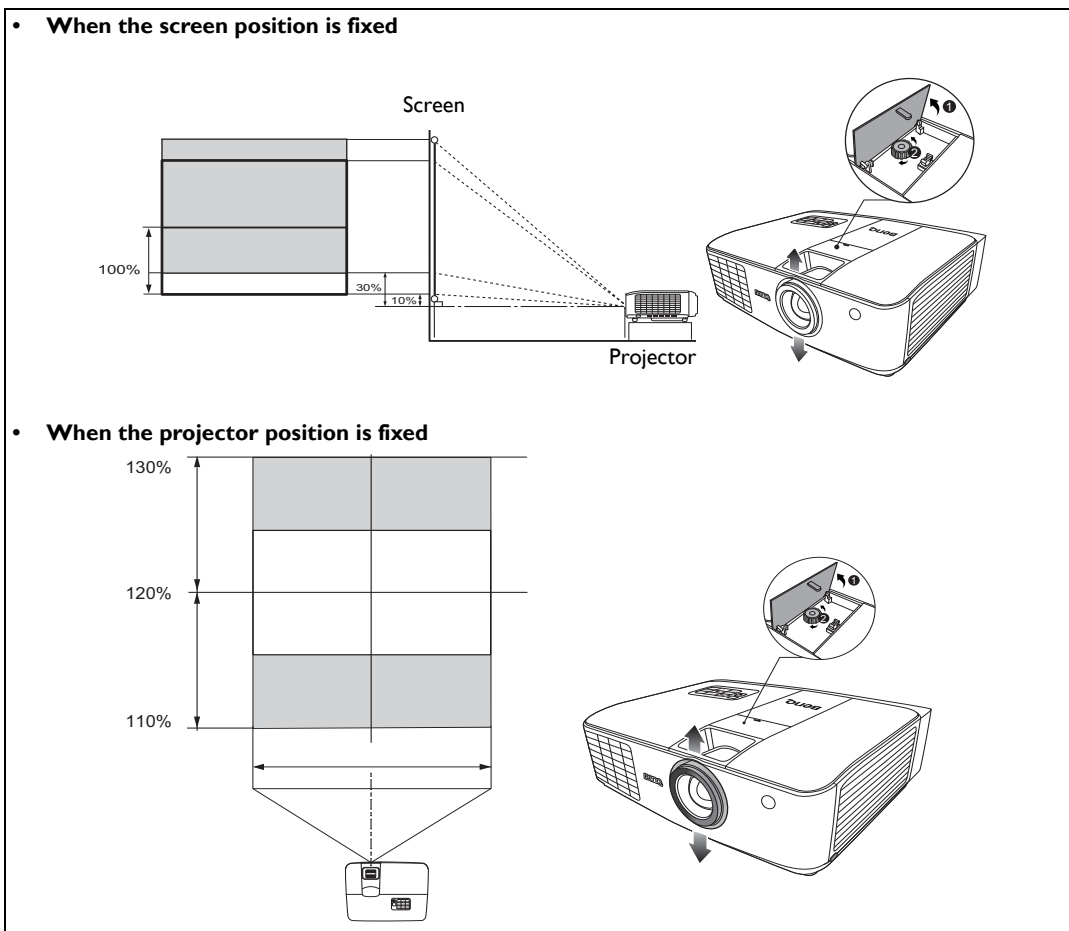







1. Release the lever by turning it counterclockwise.
2. Move the lever to adjust the projected image position.
3. Lock the lever by turning it clockwise.



- **Please do not over-tighten the lever.**
- **Lens shift adjustment will not result in a degraded picture quality. In the unlikely event that the image distortion is produced, see ["Adjusting the projected image"](#) on page 34 for details.**

Connecting with video equipment

You can connect the projector to any type of video equipment, such as a VCR, DVD player, Blu-ray player, digital tuner, cable or satellite decoder, video game console or digital camera. You can also connect it to a desktop or laptop PC or Apple Macintosh system. You need only connect the projector to a source device using just one of the connecting methods, however each provides a different level of video quality. The method you choose will most likely depend upon the availability of matching terminals on both the projector and the Video source device as described below:

Terminal name	Terminal appearance	Reference	Picture quality
HDMI		"Connecting HDMI devices" on page 22	 Best
Component Video		"Connecting component-video devices" on page 23	 Better
S-Video		"Connecting S-Video or video devices" on page 23	 Good
Video		"Connecting S-Video or video devices" on page 23	 Normal
PC (D-SUB)		"Connecting a computer" on page 24	 Better

Preparations

When connecting a signal source to the projector, be sure to:

1. Turn off all equipment before making any connections.
2. Use only the correct type cables for each source with proper type plugs.
3. Ensure that all cable plugs are firmly fitted to the equipment jacks.

 **Note that all cables shown in the following connection diagrams may not be supplied with the projector (See "Shipping contents" on page 8 for details). Most cables are commercially available from electronics stores.**

Connecting HDMI devices

- Connecting HDMI devices to the projector with HDMI cables
HDMI (High-Definition Multimedia Interface) supports uncompressed video data transmission between compatible devices like DTV tuners, DVD players, Blu-ray players and displays over a single cable. It provides pure digital viewing and listening experience. You should use an HDMI cable when making connection between the projector and HDMI devices.

HDMI device: DVD player, digital tuner, etc.

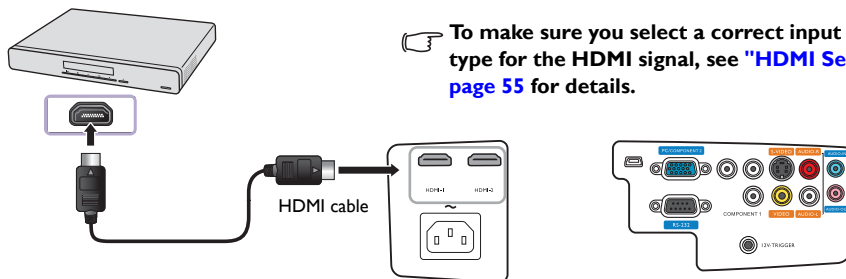

- Connecting HDMI devices to the projector wirelessly
You may also make a wireless connection between the projector and HDMI devices. As your projector is equipped with the built-in HDMI receiver, when you plug the supplied wireless HDMI transmitter into any HDMI devices, the projector will display the contents from the connected HDMI source. See ["Using the Wireless Transmitter"](#) on page 25 for details.

To prevent signal interference with the projected image, while using this projector, please make sure that there are no other devices which support 5GHz wireless signals within 3 meters from the projector, such as access points/routers, wireless cards/dongles, 5.8GHz wireless mice, 5.8GHz digital phones, some Wimax products, some Autopass cards, or devices with 802.11 AC Wi-Fi.

☞ Since different power of your wireless/radiation devices which operate in the 5GHz frequency band (e.g. industrial routers or home digital phones, etc.) will potentially impact projected image, the suggested distance could be over 3 meters away from the projector.

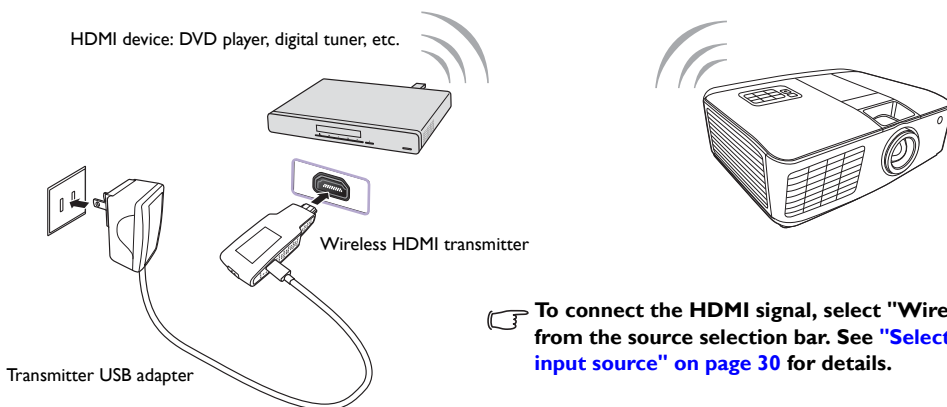

Connecting component-video devices

Be sure to match the corresponding colors between the cables and the terminals. The RCA type component video jacks are provided for connection to video output devices. You should also connect the separate audio cable to a suitable audio amplifier.

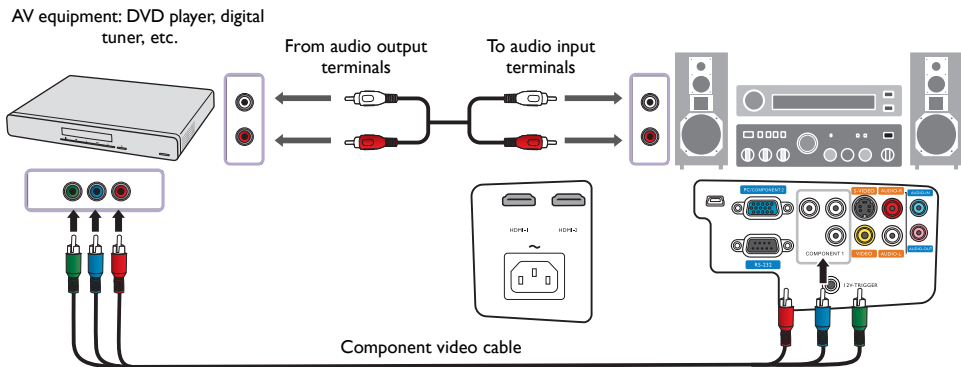

Connecting S-Video or video devices

You need to connect only S-Video or composite Video cable from the same device, never both at the same time. You should also connect the separate audio cable to a suitable audio amplifier.

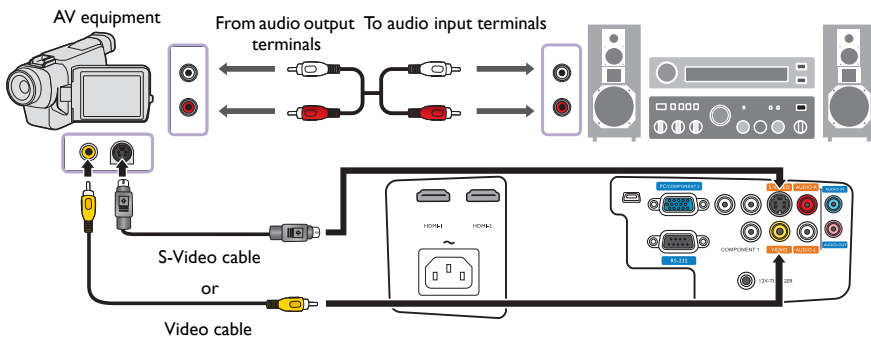

- If you have already made a **Component Video** connection between the projector and the video source device, you need not connect to this device again using an **S-Video** or **composite Video** connection as this makes an unnecessary second connection of poorer picture quality. You need only connect using a **composite Video** connection if both **Component Video** and **S-Video** are not supplied on the video source device (for example, with some analog video cameras).
- If the selected video image is not displayed after the projector is turned on and the correct video source has been selected, please check that the video source device is turned on and operating correctly. Also check that the signal cables have been connected correctly.

Connecting a computer

Connect the projector to a computer with a VGA cable.

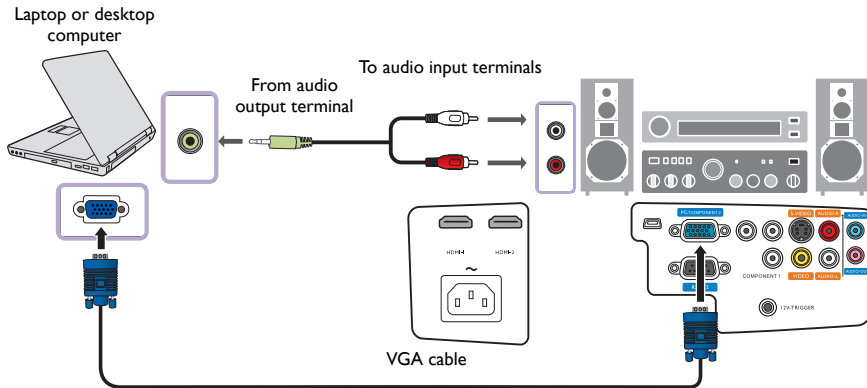

Many laptops do not turn on their external video ports when connected to a projector. Usually a key combination like Fn + F3 or CRT/LCD key turns the external display on/off. Locate a function key labeled CRT/LCD or a function key with a monitor symbol on the laptop. Press Fn and the labeled function key simultaneously. Refer to your laptop's documentation to discover your laptop's key combination.

Using the Wireless Transmitter

Product specification

Wireless Transmitter Specification	
Host Interface	HDMI type A x1 for input from HDMI player devices
Button	Total 1 button for registration with Rx (Hold over 3 seconds)
Operating voltage	5V+/- 5% for micro USB
Power Consumption	3 Watt (max.) @1080p/59Hz (5V/0.6A) 2.4 Watt (max.) @720p/60Hz (5V/0.48A)
Up/Down Link Data Rate	Downlink channel with up to 1 Mbps for data and control Uplink channel with up to 100 Kbps for data and control
Wireless Operating Range	0~8m NLOS (no walls) Indoor. The transmission quality varies in the system board and surrounding environment.

The BenQ Wireless Transmitter for your model may well function perfectly with these HDMI devices:

Model	Source
1	PS3 Player (Game console)
2	Philips-BDP3100 (BD player)
3	Desktop PC with ASUS Graphic Card ENGTS250
4	Desktop PC with ASUS Graphic Card EMGTS450
5	Sony BDP-S360 (BD player)
6	LG BD 350 (BD player)

 At the time of writing, BenQ has done the testing with the devices listed above. Using an HDMI device not in this compatibility list with our wireless transmitter may not work correctly.

Supported timing for wireless HDMI input timing

- Supported timing for Video input

Timing	Resolution	Vertical frequency (Hz)	H-frequency (kHz)	Dot Clock Frequency (MHz)
480p	720x480	59.94	31.47	27
480p	720x480	60	31.5	27.027
576p	720x576	50	31.25	27
720/50p	1280x720	50	37.5	74.25
720/59	1280x720	59.94	44.955	74.175
720/60p	1280x720	60	45	74.25
1080/29.97p	1920x1080	29.97	16.858	37.063
1080/30p	1920x1080	30	33.75	74.25
1080/50i	1920x1080	50	28.13	74.25
1080/59i	1920x1080	59.94	33.716	74.175
1080/60i	1920x1080	60	33.75	74.25
1080/50p	1920x1080	50	56.25	148.5
1080/59p	1920x1080	59.94	67.432	148.35

1080/60p	1920x1080	60	67.5	148.5
1080/24p*	1920x1080	24	27	74.25

*Supported timing for 3D signal with Frame Packing format.

- Supported timing for PC input

Resolution	Mode	Refresh rate (Hz)	H-frequency (kHz)	Clock (MHz)
640 x 480	VGA_60	59.94	31.469	25.175
	VGA_72	72.809	37.861	31.5
800 x 600	SVGA_60	60.317	37.879	40
	SVGA_72	72.188	48.077	50
1024 x 768	XGA_60	60.004	48.363	65
	XGA_70	70.069	56.476	75
1366 x 768	60	60	47.7	85.5
1280 x 768	1280 x 768_60	59.87	47.776	79.5
1280 x 1024	SXGA_60	60.02	63.981	108
1360 x 768	1360 x 768_60	60.015	47.712	85.5

Power indicator

Status	LED
Step 1: Power On	none
Step 2: Registration	slow blinking
Step 3: Linking	slow blinking
Step 4: Connected	none
Step 5: Play Video	solid

Message and meaning

Message	Meaning
Linking	If the wireless network between the projector and the HDMI device has been established before, when power is on, this message appears to notify that the network is making connection.
Wireless off	Notifies wireless network failure after searching for three minutes.
Connecting to BenQ Tx	Notifies a successful connection with the HDMI device.
Connected to BenQ Tx, please check video source	Notifies no signal from the HDMI device.

Wireless transmitter synchronization

The factory default configuration will pair your HDMI source device with the projector. If the connection fails, follow the procedures below to set the pairing.

1. Connect the wireless transmitter to an HDMI source device. (e.g. Blu-ray, DVD player, AV-R player, set top boxes, or games consoles)

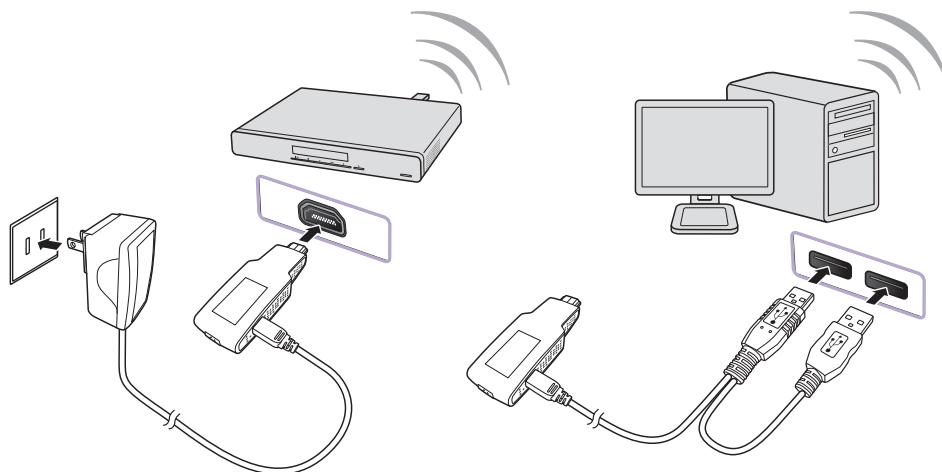

2. Turn on the projector.
3. Select **Wireless** in the source selection bar.
4. Press **MENU/EXIT** on the projector or remote control, and select the **System Setup** menu.
5. Set **Wireless Sync** to **On**.

 **When Wireless Sync is on, the projector will not respond to any key commands from the projector or remote control, except the power [On] and power [Off] keys. If you've accidentally started this function, please re-start the projector to save the settings.**

6. Press the buttons on the remote control in the following sequence:

 (for 3 ~ 6 seconds) >  > .

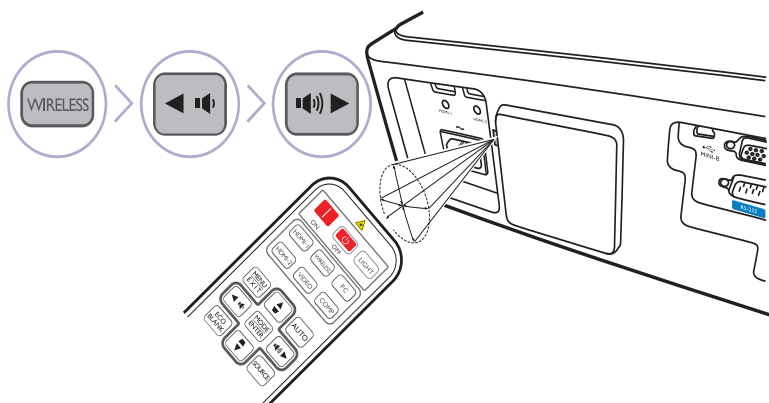

 **Please point the remote control toward the IR sensor on the rear of the projector.**

7. When the **Select Video Source** menu displays, select **Settings**.
8. In the **Settings** menu, select **Add New Video Source**.

9. When the message "**Please Press Registration Button on Transmitter**" displays, press the button on the wireless transmitter.

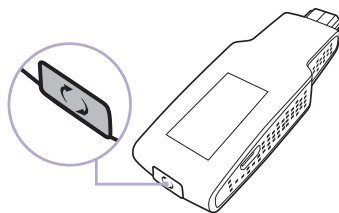

10. When the message "**Adding BENQ Tx**" displays, and select **OK**.
11. When the message "**Adding BENQ Tx**" disappears, the sync function has completed successfully.
12. Restart the projector to reset the settings.

Using the projector

Preparations

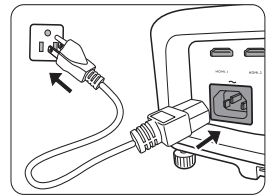

1. Plug in and turn all of the connected equipment on.
2. If not already in, plug the supplied power cable into the AC inlet on the rear of the projector.
3. Plug the power cable into a wall power outlet and turn the wall switch on.

 Please use the original accessories (e.g. power cable) only with the device to avoid possible dangers such as electric shock and fire.



Turning the projector on

Follow the steps below.

1. Make sure the Power light is orange after power has been applied.
2. Press and hold **POWER** (⏻) on the projector or  on the remote control to turn the projector on. As soon as the lamp lights up, a "Power On Tone" will be heard. The POWER indicator light flashes green and stays green when the projector is on.
 To turn off the ring tone, see "[Turning off the Power On/Off Ring Tone](#)" on page 41 for details.
3. The fans will start operating, and a start-up image displays on the screen for a few seconds while it warms up.
 The projector will not respond to further commands while it is warming up.
4. If you are prompted for a password, press the arrow keys to enter a six-digit password. See "[Utilizing the password function](#)" on page 32 for details.
5. "Source Searching..." will be displayed on the screen before the projector identifies the input source. This message will remain on the screen until a valid signal is detected. See "[Selecting an input source](#)" on page 30 for details.
6. If the horizontal frequency of the input source exceeds the range of the projector, the message "No Signal" will be displayed on the screen. This message will remain on-screen until you change the input source to an appropriate one.

Selecting an input source

The projector can be connected to multiple equipment at the same time. When the projector is first turned on, it will attempt to reconnect with the input source which was in use when the projector was last shut down.



NOTE: When automatically searching for a valid input source, the projector cycles through the available signals following the sequence from top to bottom as the source selection bar shows.

To select the video source:

- Using the remote control or projector
 1. Press **SOURCE** on the projector or remote control. A source selection bar displays.
 2. Press **▲/▼** until your desired signal is selected and press **MODE/ENTER**.
- Using the OSD menu
 1. Press **MENU/EXIT** and then press **◀/▶** until the **System Setup** menu is highlighted.
 2. Press **▼** to highlight **Input Source** and press **MODE/ENTER**. The source selection bar displays.
 3. Press **▲/▼** repeatedly until your desired signal is selected and press **MODE/ENTER**.

Once detected, the selected source information will display on the screen for seconds. If there are multiple pieces of equipment connected to the projector, you can go back to the source selection bar again to search for other signals.

You can also rename the source:

1. Press **MENU/EXIT** and then press **◀/▶** until the **System Setup** menu is highlighted.
 2. Press **▼** to highlight **Source Rename** and press **MODE/ENTER**. The **Source Rename** page displays.
 3. Press **▲/▼/◀/▶** until your desired character is selected and press **MODE/ENTER**.
- If you want the projector to automatically search for the signals, select **On** in the **System Setup > Auto Source Search** menu.
1. Adjust the projected picture to the size that you need using the zoom ring.
 2. Sharpen the picture by rotating the focus ring.

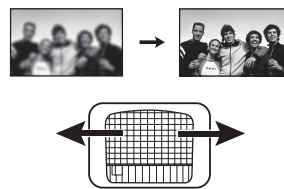
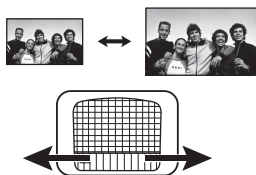

Using the menus

The projector is equipped with multilingual On-Screen Display (OSD) menus for making various adjustments and settings.

Below is the overview of the OSD menu.

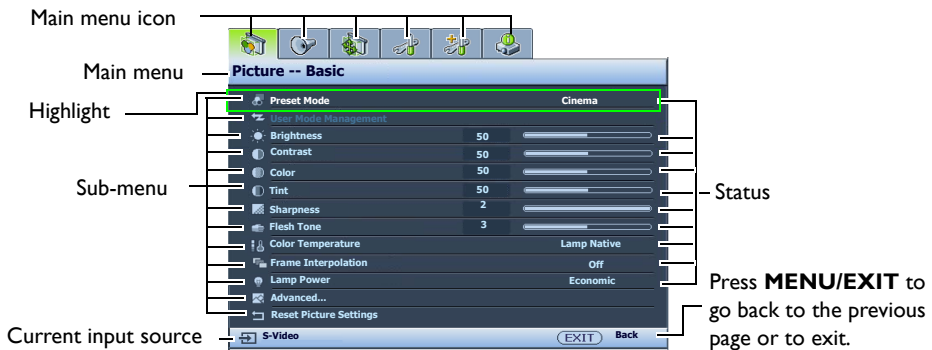

To use the OSD menus, please set the OSD menu to your familiar language.

1. Press **MENU/EXIT** on the projector or remote control to turn the OSD menu on.
3. Press **▼** to highlight **Language** and press **◀/▶** to select a preferred language.

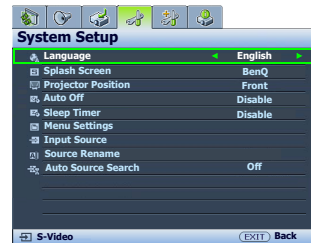

2. Use **◀/▶** to highlight the **System Setup** menu.



4. Press **MENU/EXIT** twice* on the projector or remote control to leave and save the settings.

*The first press leads you back to the main menu and the second press closes the OSD menu.

Securing the projector

Using a security cable lock

The projector has to be installed in a safe place to prevent theft. Otherwise, purchase a lock, such as the Kensington lock, to secure the projector. You can locate a Kensington lock slot on the projector. See item 20 on page 12 for details.

A Kensington security cable lock is usually a combination of key(s) and the lock. Refer to the lock's documentation for finding out how to use it.

Utilizing the password function

For security purposes and to help prevent unauthorized use, the projector includes an option for setting up password security. The password can be set through the On-Screen Display (OSD) menu. Once the password is set and this function is selected, the projector is password-protected. Users who do not know the correct password can not use the projector.

! You will be inconvenienced if you activate the password functionality and subsequently forget the password. Print out this manual (if necessary) and write the password you used in this manual, and keep the manual in a safe place for later recall.

Setting a password

☞ Once a password has been set and activated, the projector cannot be used unless the correct password is entered every time the projector is started.

1. Press **MENU/EXIT** on the projector or remote control and then press **◀/▶** until the **Advanced Setup** menu is highlighted.
2. Press **▼** to highlight **Password** and press **MODE/ENTER**. The **Password** page displays.
3. Highlight **Change Password** and press **MODE/ENTER**. The **Input Password** page displays.
4. As the picture indicates, the four arrow keys (**▲**, **▶**, **▼**, **◀**) respectively represent 4 digits (1, 2, 3, 4). According to the password you desire to set, press the arrow keys on the remote control or projector to enter six digits for the password.

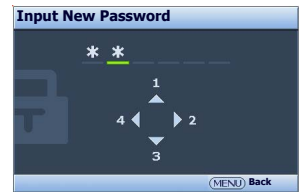

Confirm the new password by re-entering the new password.

Once the password is set, the OSD menu returns to the **Password** page.

IMPORTANT: The digits being input will display as asterisks on-screen. Write your selected password down here in this manual in advance or right after the password is entered so that it is available to you should you ever forget it.

Password: _ _ _ _ _

5. Highlight **Power On Lock** and then press **◀/▶** to select **On**.
6. Confirm the current password.
7. To leave the OSD menu, press **MENU/EXIT**.

If you forget the password

If the password function is activated, you will be asked to enter the six-digit password every time you turn on the projector. If you enter the wrong password, the password error message as pictured to the right displays lasting for three seconds, and the **Input Password** page follows. You can retry by entering another six-digit password, or if you did not record the password in this manual, and you absolutely do not remember it, you can use the password recall procedure. See ["Entering the password recall procedure" on page 33](#) for details.

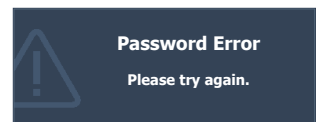

If you enter an incorrect password 5 times in succession, the projector will automatically shut down in a short time.

Entering the password recall procedure

1. Make sure the **Input Password** page displays on screen. Press and hold **AUTO** on the projector or remote control for 3 seconds. The projector will display a coded number on the screen.

 **"XXX"**, as shown in the illustration at right, are numbers that vary depending on different models.

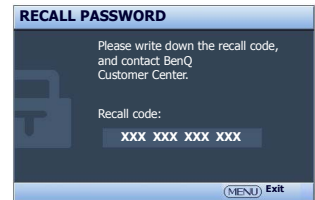

2. Write down the number and turn off your projector.
3. Seek help from the local BenQ service center to decode the number. You may be required to provide proof of purchase documentation to verify that you are an authorized user of the projector.

Changing the password

1. Press **MENU/EXIT** on the projector or remote control and then press **◀/▶** until the **Advanced Setup** menu is highlighted.
2. Press **▲/▼** to highlight **Password** and press **MODE/ENTER**. The **Password** page displays.
3. Highlight **Change Password** and press **MODE/ENTER**. The **Input Current Password** page displays.
4. Enter the old password.
 - If the password is correct, the message **"Input New Password"** displays.
 - If the password is incorrect, the password error message displays lasting for three seconds, and the message **"Input Current Password"** displays for your retry. You can either press **MENU/EXIT** to cancel the change or try another password.
5. Enter a new password.

IMPORTANT: The digits being input will display as asterisks on-screen. Write your selected password down here in this manual in advance or right after the password is entered so that it is available to you should you ever forget it.

Password: _ _ _ _ _

Keep this manual in a safe place.

6. Confirm the new password by re-entering the new password.
7. You have successfully assigned a new password to the projector. Remember to enter the new password next time the projector is started.
8. To leave the OSD menu, press **MENU/EXIT**.

Disabling the password function

To disable password protection, go back to the **Advanced Setup > Password** menu. Highlight **Power On Lock** and then press **◀/▶** to select **Off**. The message **"Input Current Password"** displays. Enter the current password.

- If the password is correct, the OSD menu returns to the **Password** page with **"Off"** shown in the row of **Power On Lock**. You will not have to enter the password next time when turning on the projector.
- If the password is incorrect, the password error message displays lasting for three seconds, and the message **"Input Current Password"** displays for your retry. You can either press **MENU/EXIT** to cancel the change or try another password.

Note that though the password function is disabled, you need to keep the old password in hand should you ever need to re-activate the password function by entering the old password.

Adjusting the projected image

Adjusting the projection angle

There are four adjuster feet on the bottom of the projector. These can be used if necessary to change the projection angle. Screw the feet in or out as appropriate to aim and level the projection angle.

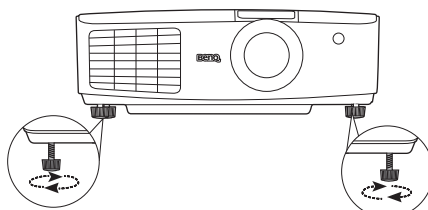

☞ If the screen and the projector are not perpendicular to each other, the projected image becomes vertical trapezoidal. To correct this problem, see ["Correcting picture distortion" on page 34](#) for details.

Correcting picture distortion

Keystoning occurs when the projector is not perpendicular to the screen and is where the projected picture displays visible as a trapezoid shape like either of the following:

- Two parallel sides (left and right, or top and bottom) but is noticeably wider on either side.
- No parallel sides.

To correct the picture's shape, you can perform the following steps.

1. Adjust the projection angle. Move the projector to be in front of the center of the screen with the center of the lens level with the screen.
2. If the picture is still distorted, or the projector is unable to be positioned as described above, you will need to manually correct the picture.
 - Using the remote control or projector
 - i. Press one of the Arrow/Keystone keys on the remote control or projector (Up ▲/▼, Down ▼/▲) to display the Keystone page.
 - ii. See step [iii](#) below for further operation.
 - Using the OSD menu
 - i. Press **MENU/EXIT** and then press ◀/▶ until the **Display** menu is highlighted.
 - ii. Press ▼ to highlight **Keystone** and press **MODE/ENTER**. The keystone correction page displays.
 - iii. Press the key whose keystone icon is opposite to the shape of the projected picture. Continue pressing the same key or press the other keys until you are satisfied with the shape. The values on the lower portion of the page change while pressing. When the values reach their maximum or minimum with repeated key presses, the picture's shape will stop changing. You will not be able to change the picture further in that direction.



Using the preset and user modes

Selecting a preset mode

The projector is preset with several pre-defined picture modes so that you can choose one to suit your operating environment and input source picture type.

To select a preset mode that suits your need:

1. Press **MENU/EXIT** and then press ◀/▶ until the **Picture -- Basic** menu is highlighted.
2. Press ▼ to highlight **Preset Mode**.
3. Press ◀/▶ until your desired mode is selected.

These modes consist of preset values suitable for various projection situations as described below:

- **Cinema:** With well-balanced color saturation and contrast with a low brightness level, this is most suitable for enjoying movies in a totally dark environment (as you would find in a commercial cinema).
- **Dynamic:** Maximizes the brightness of the projected image. This mode is suitable for environments where extra-high brightness is required, such as using the projector in well lit rooms.
- **Standard:** It is slightly brighter than **Cinema** mode, and suitable for use in rooms where there is a small amount of ambient light.
- **3D:** It is optimized to bring up 3D effects when watching 3D contents.
 **This mode is only available when 3D function is enabled.**
- **User 1/User 2/User 3:** Recalls the customized settings. See ["Setting the User 1/User 2/User 3 mode" on page 35](#) for details.

Fine-tuning the selected picture mode

The pre-defined picture mode settings can be altered via the available items shown in the **Picture -- Basic** menus.

To fine-tune the picture mode:

1. Press **MENU/EXIT** and then press ◀/▶ until the **Picture -- Basic** menu is highlighted.
2. Press ▼ to highlight the item you want to adjust and press ◀/▶ to set your desired value. Your selection is automatically stored in the projector and associated with that input source.
See ["Fine-tuning the picture quality" on page 36](#) and ["Advanced picture quality controls" on page 38](#) for details.

Each time you change the picture mode, the projector also changes the setting to the one which was last set for that particular picture mode on that particular input. If you change the input source, the most recently used picture mode and settings for that input and resolution will be restored.

Setting the User 1/User 2/User 3 mode

There are three user-definable modes if the current available picture modes are not suitable for your need. You can use one of the picture modes (except the selected User mode) as a starting point and customize the settings.

1. In the **Picture -- Basic** menu, highlight **Preset Mode** and press ◀/▶ to select **User 1, User 2, or User 3** mode.
2. Press ▼ to highlight **User Mode Management**.

 **This function is only available when User 1, User 2, or User 3 mode is selected up in the Preset Mode sub-menu item.**

3. Press **MODE/ENTER** to display the **User Mode Management** page.
4. Press ▼ to highlight **Reference Mode** and press **MODE/ENTER**.

5. Press ▼ to highlight a picture mode that is closest to your need and press **MODE/ENTER** and **MENU/EXIT** to go back to the **User Mode Management** page.
6. Here you can rename the **User 1**, **User 2**, or **User 3** mode by pressing ▼ to highlight **Rename User Mode** and press **MODE/ENTER**. The **Rename User Mode** page displays.
7. Press ▲/▼/◀/▶ until your desired character is selected and press **MODE/ENTER**.
8. Press **MENU/EXIT** to go back to the main menu once you are done.
9. Press ▼ to select a sub-menu item to be changed and adjust the value with ◀/▶. See "[Fine-tuning the picture quality](#)" on page 36 and "[Advanced picture quality controls](#)" on page 38 for details.
10. When all settings have been done, press **MENU/EXIT** to save and leave the settings.

Resetting the picture mode

All of the adjustments you've done in the **Picture -- Basic** menus can be returned to the factory preset values with a key press on the highlight of **Reset**.

To reset the picture mode to the preset factory values:

1. In the **Picture -- Basic** menu, highlight **Preset Mode** and press ◀/▶ to select the picture mode (including **User 1**, **User 2**, or **User 3**) you want to reset.
2. Press ▼ to highlight **Reset Picture Settings** and press **MODE/ENTER**. The confirmation message displays.
3. Press ◀/▶ to highlight **Reset** and press **MODE/ENTER**. The picture mode will return to the factory preset settings.
4. Repeat steps 1-3 if you want to reset other picture modes.

☞ Do not be confused with the **Reset Picture Settings** function here with the **Reset All Settings** in the **Advanced Setup** menu. The **Reset All Settings** function returns most of the settings to the factory preset values system wide. See "[Reset All Settings](#)" on page 56 for details.

Fine-tuning the picture quality

No matter what picture mode you have selected, you are able to fine-tune those settings to fit every presentation purpose. Those adjustments will be saved to the preset mode you are at when you exit the OSD menu.

Adjusting Brightness

Highlight **Brightness** in the **Picture -- Basic** menu and adjust the values by pressing ◀/▶ on the projector or remote control.

The higher the value, the brighter the picture. And the lower the setting, the darker the picture. Adjust this control so the black areas of the picture appear just as black and that detail in the dark areas is visible.



Adjusting Contrast

Highlight **Contrast** in the **Picture -- Basic** menu and adjust the values by pressing ◀/▶ on the projector or remote control.

The higher the value, the greater the contrast. Use this to set the peak white level after you have previously adjusted the **Brightness** setting to suit your selected input and viewing environment.



Adjusting Color

Highlight **Color** in the **Picture -- Basic** menu and adjust the values by pressing ◀/ ▶ on the projector or remote control.

Lower setting produces less saturated colors; setting to the minimum value makes the image black and white. If the setting is too high, colors on the image will be overpowering, which makes the image unrealistic.

Adjusting Tint

Highlight **Tint** in the **Picture -- Basic** menu and adjust the values by pressing ◀/ ▶ on the projector or remote control.

The higher the value, the more reddish the picture becomes. The lower the value, the more greenish the picture becomes.

Adjusting Sharpness

Highlight **Sharpness** in the **Picture -- Basic** menu and adjust the values by pressing ◀/ ▶ on the projector or remote control.



The higher the value, the sharper the picture becomes. The lower the value, the softer the picture becomes.

The **Brightness, Color, Contrast, Sharpness, and Tint** functions can also be accessible by pressing **BRIGHTNESS, COLOR, CONTRAST, SHARP, and TINT** on the remote control to display the adjustment bar and then you can press ◀/ ▶ to adjust the values.

Adjusting Flesh Tone

This function adjusts accurate color primaries resulting in natural looking flesh tones with excellent color saturation.

Highlight **Flesh Tone** in the **Picture -- Basic** menu and adjust the values by pressing ◀/ ▶ on the projector or remote control.

The higher the value, the more reddish the flesh tones in the picture become. The lower the value, the more greenish the flesh tones in the picture become.

Selecting a color temperature*

Highlight **Color Temperature** in the **Picture -- Basic** menu or press **COLOR TEMP** on the remote control to select a preferred setting by pressing ◀/ ▶ on the projector or remote control.

There are several color temperature settings available.

1. **Lamp Native:** With the lamp's original color temperature and higher brightness. This setting is suitable for environments where high brightness is required, such as projecting pictures in well lit rooms.
2. **Warm:** Makes pictures appear reddish white.
3. **Normal:** Maintains normal colorings for white.
4. **Cool:** Makes pictures appear bluish white.

*About color temperatures:

There are many different shades that are considered to be "white" for various purposes. One of the common methods of representing white color is known as the "color temperature". A white color with a low color temperature appears to be reddish white. A white color with a high color temperature appears to have more blue in it.

Advanced picture quality controls

There are more advanced functions in the **Picture -- Basic > Advanced...** and **Display** menus to be adjusted to your preference. To save the settings, just press **MENU/EXIT** to leave the OSD menu.

Setting Black Level

Highlight **Black Level** in the **Picture -- Basic > Advanced...** menu and press ◀/▶ on the projector or remote control to select **0 IRE** or **7.5 IRE**.

The grayscale video signal is measured in IRE units. In some areas which use NTSC TV standard, the grayscale is measured from 7.5 IRE (black) to 100 IRE (white); however, in other areas where PAL equipment or Japanese NTSC standards are used, the grayscale is measured from 0 IRE (black) to 100 IRE (white). We suggest that you check the input source to see if it is with 0 IRE or 7.5 IRE, then select accordingly.

Controlling image clarity

You may have static or noisy projected pictures.

To achieve better picture clarity:

1. Highlight **Clarity Control** in the **Picture -- Basic > Advanced...** menu and press **MODE/ENTER** on the projector or remote control to display the **Clarity Control** page.
2. Press ▲/▼ to select the item you want and press ◀/▶ to set the desired value.
 - **Noise Reduction:** Reduces electrical image noise caused by different media players. The higher the setting, the less the noise.
 - **Detail Enhancement:** Sharpens the image. The higher the setting, the more details the image reveals.

Setting a preferred color temperature

To set a preferred color temperature:

1. Highlight **Color Temperature** in the **Picture -- Basic** menu or press **COLOR TEMP** on the remote control to select **Lamp Native**, **Warm**, **Normal**, or **Cool** by pressing ◀/▶ on the projector or remote control.
2. Highlight **Color Temperature Fine Tuning** in the **Picture -- Basic > Advanced...** menu and press **MODE/ENTER** or press **FINE TUNE** on the remote control. The **Color Temperature Fine Tuning** page displays.
3. Press ▲/▼ to highlight the item you want to change and adjust the values by pressing ◀/▶.
 - **Red Gain/Green Gain/Blue Gain:** Adjusts the contrast levels of Red, Green, and Blue.
 - **Red Offset/Green Offset/Blue Offset:** Adjusts the brightness levels of Red, Green, and Blue.
4. To save and leave the settings, press **MENU/EXIT**.

Selecting a Gamma setting

Highlight **Gamma Selection** in the **Picture -- Basic > Advanced...** menu and select a preferred setting by pressing ◀/▶ on the projector or remote control.

Gamma refers to the relationship between input source and picture brightness.

- Gamma 1.6/1.8/2.0/BenQ
Select these values according to your preference.
- Gamma 2.2
Increases the average brightness of the picture. Best for a lit environment, meeting room or family room.
- Gamma 2.4/2.5
Best for viewing movies in a darkened environment.
- Gamma 2.6/2.8
Best for viewing movies which are mostly composed of dark scenes.

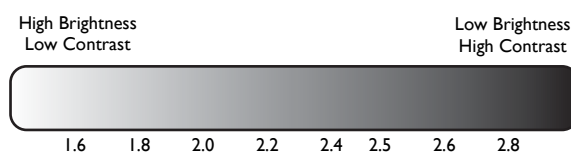

Adjusting Brilliant Color

Highlight **Brilliant Color** in the **Picture > Advanced...** menu and select **On** by pressing ◀/▶ on the projector or remote control.

This feature utilizes a new color-processing algorithm and system level enhancements to enable higher brightness while providing truer, more vibrant colors in picture. When set to "Off", **Brilliant Color** is disabled.

Color Management

In most installation situations, color management will not be necessary, such as in classroom, meeting room, or lounge room situations where lights remain on, or where building external windows allow daylight into the room.

Only in permanent installations with controlled lighting levels such as boardrooms, lecture theaters, or home theaters, should color management be considered. Color management provides fine color control adjustment to allow for more accurate color reproduction, should you require it.

Proper color management can only be achieved under controlled and reproducible viewing conditions. You will need to use a colorimeter (color light meter), and provide a set of suitable source images to measure color reproduction. These tools are not provided with the projector, however, your projector supplier should be able to provide you with suitable guidance, or even an experienced professional installer.

The **Color Management** provides six sets (RGBCMY) of colors to be adjusted to favorite colors. When you select each color, you can independently adjust its color range and saturation according to your preference.

To adjust and store the settings:

1. In the **Picture -- Basic > Advanced...** menu, highlight **Color Management** and press **MODE/ENTER**. The **Color Management** page displays.
2. Highlight **Primary Color** and press **◀/▶** to select a color from among **Red, Green, Blue, Cyan, Magenta** and **Yellow**.
3. Press **▼** to highlight **Hue** and press **◀/▶** to select its range. Increase in the range will include colors consisted of more proportions of its two adjacent colors.

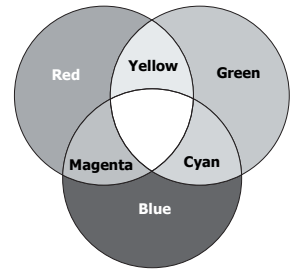

Please refer to the illustration to the right for how the colors relate to each other. For example, if you select **Red** and set its range at **0**, only pure red is selected. Increasing its range will include both the red color close to yellow and red color close to magenta.

4. Press **▼** to highlight **Gain** and adjust its values to your preference by pressing **◀/▶**. The contrast level of the primary color you select will be affected. Every adjustment made will reflect to the image immediately.
5. Press **▼** to highlight **Saturation** and adjust its values to your preference by pressing **◀/▶**. Every adjustment made will reflect to the image immediately.

For example, if you select **Red** and set its value at **0**, only the saturation of pure red will be affected.

☞ Saturation is the amount of that color in a video picture. Lower settings produce less saturated colors; a setting of "0" removes that color from the image entirely. If the saturation is too high, that color will be overpowering and unrealistic.

6. To leave and save the settings, press **MENU/EXIT**.

Setting Film Mode

Highlight **Film Mode** in the **Display** menu and select **On** by pressing **◀/▶** on the projector or remote control.

This feature helps improve picture quality when projecting composite or S-video image from a film-sourced DVD or Blu-ray Disc.

Setting 3D Comb Filter

Highlight **3D Comb Filter** in the **Display** menu and select **On** by pressing **◀/▶** on the projector or remote control.

This feature separates composite signal to Y (brightness) signal and C (color) signal, and can help produce clearer and sharper images with correct colors in place.

☞ This function is only available when a composite signal is selected.

Adjusting the sound

The sound adjustments made as below will have an effect on the projector speaker(s). Be sure you have made a correct connection to the projector audio input. See "[Connecting with video equipment](#)" on [page 21](#) for how the audio input is connected.

Muting the sound

To temporarily turn off the sound:

1. Press **MENU/EXIT** and then press ◀/▶ until the **Audio Setup** menu is highlighted.
2. Press ▼ to highlight **Mute** and press ◀/▶ to select **On**.

 If available, you can also press **MUTE** on the remote control to toggle projector audio between on and off.

Adjusting the sound level

To adjust the sound level, press  /  on the projector or remote control, or:

1. Repeat step 1 above.
2. Press ▼ to highlight **Volume** and press ◀/▶ to select a desired sound level.

Switching the left/right audio channels

1. Repeat step 1 above.
2. Press ▼ to highlight **L/R Switch** and press ◀/▶ to select **On** to swap audio output of the left and right speakers, or select **Auto** to automatically swap the left and right audio channels when the projection direction is changed.

Turning off the Power On/Off Ring Tone

To turn off the ring tone:

1. Repeat step 1 above.
2. Press ▼ to highlight **Power On/Off Ring Tone** and press ◀/▶ to select **Off**.

 The only way to change **Power On/Off Ring Tone** is setting **On** or **Off** here. Setting the sound mute or changing the sound level will not affect the **Power On/Off Ring Tone**.

Selecting the aspect ratio

The "aspect ratio" is the ratio of the image width to the image height. Digital TV is usually in 16:9 ratio, which is the default for this projector, and most analog TV signals and DVDs are in 4:3 ratio.

With the advent of digital signal processing, digital display devices like this projector can dynamically stretch and scale the image output to a different aspect than that of the image input source. Images can be stretched in a linear manner so the whole of the image is stretched equally, or non-linearly, which distorts the image.

To change the projected picture ratio (no matter what aspect the source is):

- Using the remote control
 1. Press **ASPECT** to show the current setting.
 2. Press **ASPECT** repeatedly to select an aspect ratio to suit the format of the video signal and your display requirements.
- Using the OSD menu
 1. Press **MENU/EXIT** and then press ◀/▶ until the **Display** menu is highlighted.
 2. Press ▼ to highlight **Aspect Ratio**.
 3. Press ◀/▶ to select an aspect ratio to suit the format of the video signal and your display requirements.

About the aspect ratio

1. **Auto**: Scales an image proportionally to fit the projector's native resolution in its horizontal or vertical width. This is suitable for the incoming image which is neither in 4:3 nor 16:9 and you want to make most use of the screen without altering the image's aspect ratio.

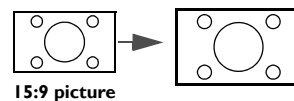

2. **Real**: This setting displays the image in a one-to-one pixel mapping without alteration or resize in the center of the projection. This is most suitable for use with PC source inputs.

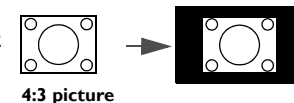

3. **4:3**: Scales a picture so that it is displayed in the center of the screen with a 4:3 aspect ratio. This is most suitable for 4:3 pictures like computer monitors, standard definition TV and 4:3 aspect DVD movies, as it displays them without aspect alteration.

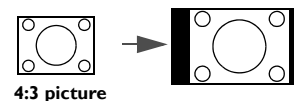

4. **Wide**: Stretches the picture horizontally in a non-linear manner, that is, the edges of the picture are stretched more than the center of the picture to prevent distortion of the central part of the picture. This is suitable for occasions where you want to stretch the width of a 4:3 aspect picture to the width of a 16:9 aspect screen. It does not alter the height. Some widescreen movies have been produced with their width squashed down to the width of a 4:3 aspect, and are best viewed when restretched back to their original width using this setting.

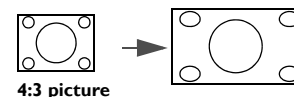

5. **Anamorphic**: Scales an image so that it is displayed in the center of the screen with a 16:9 aspect ratio. This setting stretches and resizes linearly, except that it treats the vertical and horizontal dimensions independently. It stretches the height of the source image until it reaches the full projected height, and stretches the width of the source image until it reaches the full projected width. This may alter the projected aspect, depending upon the original aspect of the source

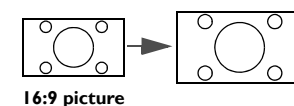
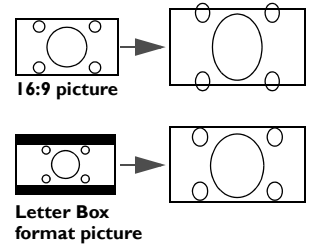

image. Anamorphic is most suitable for images which are already in a 16:9 aspect, like high definition TV, as it displays them without aspect alteration.

6. **Letter Box:** Scales a picture to fit the projector's native resolution in its horizontal width and resize the picture's height to the 3/4 of the projection width. This may produce a picture greater in height than can be displayed, so part of the picture is lost (not displayed) along the top and bottom edges of the projection. This is suitable for the display of movies which are presented in letter box format (with black bars on the top and bottom).



- **The black portions are inactive areas and the white portions are active areas.**
- **OSD menus can be displayed on those unused black areas.**

Freezing the image

Press **FREEZE** on the remote control to freeze the image. The word "FREEZE" will display in the lower right corner of the screen.

Even if an image is frozen on the screen, the pictures played are still running on the device where the pictures are played. If the connected devices have active audio output, you will still hear the audio even though the image is frozen on the screen.

Using the test pattern

The projector is able to display the grid test pattern. It helps you adjust the image size and focus and make certain that the projected image is free from distortion.

To display the test pattern, open the OSD menu and go to the **Advanced Setup > Test Pattern** and press **◀/▶** to select **On**, or press **TEST** on the remote control.

Magnifying and searching for details

If you need to find the details on the projected picture, magnify the picture. Use the direction arrow keys for navigating the picture.

1. Press **MENU/EXIT** and then press **◀/▶** until the **Display** menu is highlighted.
2. Press **▼** to highlight **Digital Zoom** and press **MODE/ENTER**. The Zoom bar displays.
3. Press **▲** repeatedly to magnify the picture to a desired size.
4. To navigate the picture, press **MODE/ENTER** to switch to the panning mode and press the directional arrows (**▲**, **▼**, **◀**, **▶**) on the projector or remote control to navigate the picture.
5. To reduce size of the picture, press **MODE/ENTER** to switch back to the zoom in/out function. You can also press **▼** repeatedly until it is restored to the original size.

- **The picture can only be navigated after it is magnified. You can further magnify the picture while searching for details.**

Operating in a high altitude environment

We recommend that you activate **High Altitude Mode** when your environment is higher than 1500 meters (around 4920 feet) above sea level, or whenever the projector will be used for extended periods of time (>10 hours) without shutdown.

To activate High Altitude Mode:

1. Press **MENU/EXIT** and then press ◀/▶ until the **Advanced Setup** menu is highlighted.
2. Press ▼ to highlight **High Altitude Mode**.
3. Press ◀/▶ to select **On**. A confirmation message displays.
4. Highlight **Yes** and press **MODE/ENTER**.

Operation under **High Altitude Mode** may cause a higher decibel operating noise level because of increased fan speed necessary to improve overall system cooling and performance.

If you use this projector under other extreme conditions excluding the above, it may display auto shutdown symptoms, which is designed to protect your projector from over-heating. In cases like this, you should switch to **High Altitude Mode** to solve these symptoms. However, this is not to state that this projector can operate under any and all harsh or extreme conditions.

Displaying more than one image source simultaneously

Your projector is capable of displaying pictures simultaneously from two input sources, which can be used to enhance your presentation in an interesting way. Ensure the signals you want to display are correctly connected to the projector.

To display the PIP window:

- **Using the remote control**

Press **PIP** to display the **PIP** page and make adjustments by following the steps starting from step 3 in the section "Using the OSD menu" below.

- **Using the OSD menu**

1. Press **MODE/ENTER** and then press **◀/▶** until the **Display** menu is highlighted.
2. Press **▼** to highlight **PIP** and press **MODE/ENTER**. The **PIP** page displays.
3. Highlight **PIP** and press **◀/▶** to select **On**.

The projector will select two currently active signals to display and the last viewed picture will be displayed on the big screen as a main source.

The PIP function is effective at below source combinations.

Source 1/2	HDMI 1/ HDMI 2 / Wireless
PC	✓
Video	✓
S-Video	✓
Component 1/2	✓

4. To change the **Main Source** or **PIP Source**, press **▼** to highlight **Main Source** or **PIP Source** and press **MODE/ENTER**. The source selection bar displays.
5. Use **▲/▼** to highlight the source you want to display for the main (bigger) or second (smaller) window, and press **MODE/ENTER** to save the setting and go back to the **PIP** page.
6. To make OSD settings to one of the two sources (main or second), highlight **Active Window** and press **◀/▶** to select the source you want to make adjustments.

 **The settings made on the OSD menu will only take effect on the active window.**

7. To change the position of the smaller picture, highlight **Position** and press **◀/▶** repeatedly until a suitable position is selected.
8. To resize the small picture, highlight **Size** and press **◀/▶** to set the PIP size among **Small** or **Large**.
9. To save the settings and leave the OSD menu, press **MENU/EXIT**.

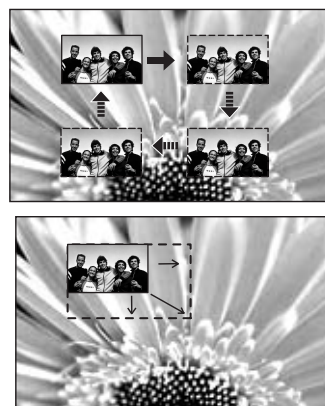

Watching 3D content

Your BenQ projector supports playing three-dimensional (3D) content transferred through D-Sub, Component, HDMI, Video, and S-Video. Yet you need the required compatible hardware accessories and software to play 3D content on BenQ projector.

Connecting 3D video devices

- PlayStation games
 - i. Make sure you have updated your console to the latest software version in PlayStation 3.
 - ii. Insert the 3D game disc. Or you can download games via the PlayStation network.
 - iii. Launch the game and select **Play in 3D** in the in-game menu.
- Blu-ray 3D player
 - i. Make sure your player supports 3D Blu-ray Disc and that 3D output is activated.
 - ii. Play the 3D Blu-ray Disc.
- 3D TV (e.g. SKY 3D, DirecTV)
 - i. Contact your TV service provider to enable 3D channels on your channel package.
 - ii. Switch to the 3D channel.
- 3D Devices (e.g. 3D DV/DC)

Turn on the 3D device and project the 3D content.

 **To view the 3D video correctly, make sure Auto is selected in the Display > 3D > 3D Mode menu. If 3D content still cannot be shown correctly, select the supported format in the Display > 3D > 3D Mode menu.**

After you have connected the 3D video devices to the projector, make sure the power of BenQ 3D glasses is on. Wear the BenQ 3D glasses, and then enjoy your 3D experience!

Using the 3D menus

1. Press the **MENU/EXIT** and go to the **Display > 3D** menu and press **MODE/ENTER**. Or you can press the **3D** button on the remote control. The **3D** page displays.
2. Highlight **3D Mode** and press **MODE/ENTER**. The **3D Mode** page displays.
3. Press **▲/▼** to highlight the 3D format that you need and press **MODE/ENTER**. The projector automatically detects the format of the video when selecting **Auto**. If not, you need to base on the 3D format of the video to make an appropriate setting in the **3D Mode** menu.
4. Press **MENU/EXIT** to go back to the **3D** page.
5. Press **▲/▼** to highlight **3D Depth Adjust** and press **◀/▶** to set your desired value of 3D image depth. The higher the value, the deeper the 3D depth presents.
6. Press **MENU/EXIT** to go back to the **3D** page.
7. Press **▲/▼** to highlight **3D Sync Invert** and press **◀/▶** to select **Invert** to switch between the image for the left eye and the right eye for the more natural viewing. You can also toggle this function between **Invert** and **Disable** by pressing **Invert** on the remote control.

-  • **Use corrective glasses or other such methods to correct your eyesight if you suffer from myopia, hyperopia, astigmatism, or have eyesight differences between the left and right eyes before putting on the 3D Glasses to watch the 3D content.**
- **When the projector starts to project the 3D images, the image may seem misplaced, however, this is not a product malfunction.**
- **Take appropriate breaks when watching 3D content.**
- **Stop watching 3D content if you feel fatigue or discomfort.**
- **Keep a distance from the screen of about three times the effective height of the screen when watching 3D content.**
- **Children and people with a history of oversensitivity to light, heart problems, or have any other existing medical condition should be refrained from watching 3D content.**

Personalizing the projector menu display

The On-Screen Display (OSD) menus can be set according to your preferences. The following settings do not affect the projection settings, operation, or performance.

- **Menu Display Time** in the **System Setup > Menu Settings** menu sets the length of time the OSD will remain active after your last key press. Use ◀/▶ to select a suitable time length.
- **Menu Position** in the **System Setup > Menu Settings** menu sets the OSD position in five locations. Use ◀/▶ to select a preferred position.
- **Blank Reminder Message** in the **System Setup > Menu Settings** menu displays a blank reminder message while the projected image on the screen is hidden.
- **Language** in the **System Setup** menu sets your familiar language for the On-Screen (OSD) Menus. See ["Using the menus" on page 31](#) for details.
- **Splash Screen** in the **System Setup** menu sets a preferred logo screen to be displayed during projector start-up.

Locking control keys



With the control keys on the remote control and projector locked, you can prevent your projector settings from being changed accidentally (by children, for example). When **Key Lock** is on, no control keys on the remote control and projector will operate except **POWER** and ▶.

To lock the keys:

1. Press **MENU/EXIT** and then press ◀/▶ until the **Advanced Setup** menu is highlighted.
2. Press ▼ to highlight **Key Lock**, and press ◀/▶ to select **On**. A warning message appears. Select **Yes** and press **MODE/ENTER**. The control keys lock.

To unlock the keys, press and hold ▶ on the projector or remote control for 3 seconds.

Turning the projector off

To turn the projector off, press **POWER**  on the projector or  on the remote control and a warning message appears. Press the button again.

- The Power indicator light flashes orange and the fans run for about two minutes to cool the lamp. The projector will not respond to any commands until the cooling process is complete. Once the cooling process finishes, a **"Power Off Ring Tone"** will be heard.

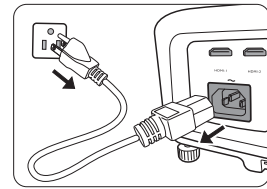

 To turn off the ring tone, see **"Turning off the Power On/Off Ring Tone"** on page 41 for details.

- Then, the Power indicator light is a steady orange once the cooling process has finished and fans stop.
- If the projector will not be used for an extended period, unplug the power cable from the power outlet.
- To protect the lamp, the projector will not respond to any commands during the cooling process.

 **Actual lamp life may vary due to different environmental conditions and usage.**

On-Screen Display (OSD) menus

On-Screen Display (OSD) structure

Please note that the on-screen display (OSD) menus vary according to the signal type selected.

Main menu	Sub-menu	Options	
Picture -- Basic	Preset Mode	Cinema/Dynamic/Standard/User 1/User 2/User 3/3D/ISF Day/ISF Night	
	User Mode Management		
	Brightness	0-100	
	Contrast	0-100	
	Color	0-100	
	Tint	0-100	
	Sharpness	0/1/2	
	Flesh Tone	0-5	
	Color Temperature	Normal/Cool/Lamp Native/Warm	
	Frame Interpolation	Off/Low/Middle/High	
	Lamp Power	Normal/Economic/SmartEco	
	Advanced...	Black Level	0 IRE/7.5 IRE
		Clarity Control	Noise Reduction/Detail Enhancement
		Color Temperature Fine Tuning	Red Gain/Green Gain/Blue Gain/Red Offset/Green Offset/Blue Offset
		Gamma Selection	1.6/1.8/2.0/2.2/2.4/2.5/2.6/2.8/BenQ
		Brilliant Color	On/Off
		Color Management	Primary Color/Hue/Gain/Saturation
Reset Picture Settings			
Audio Setup	SRS	On/Off	
	Mute	On/Off	
	Volume	0-10	
	Treble	0-10	
	Bass	0-10	
	L/R Switch	Auto/On/Off	
	Power On/Off Ring Tone	On/Off	

Display	Aspect Ratio	Auto/Real/4:3/Wide/Anamorphic/Letter Box	
	Keystone		
	Position		
	Overscan Adjustment	0/1/2/3	
	PIP	PIP	On/Off
		Main Source	HDMI 1/HDMI 2/Video/S-Video/Component 1/Component 2/PC/Wireless
		PIP Source	1/Component 2/PC/Wireless
		Active Window	Main/PIP
		Position	Top-Right/Bottom-Left/Bottom-Right/Top-Left
		Size	Large/Small
	PC & Component YPbPr Tuning	H. Size	
		Phase	
		Auto	
	Digital Zoom		
	Film Mode	On/Off	
	3D Comb Filter	On/Off	
	3D	3D Mode	Auto/Off/On/Frame Sequential/Frame Packing/Top-Bottom/Side-by-Side/2D 3D Conversion
		3D Depth Adjust	-10-10
		3D Sync Invert	Disable/Invert
	Language	English / Français / Deutsch Italiano / Español / Русский 繁體中文 / 简体中文 / 日本語 / 한국어 / Svenska / Nederlands / Türkçe / Čeština / Português / हिन्दी / Polski Magyar / Hrvatski / Română / Norsk / Dansk / Български / Suomi / Indonesian / Ελληνικά / العربية / हिन्दी	
Splash Screen	BenQ/Black/Blue		
Projector Position	Front/Front Ceiling/Rear/Rear Ceiling		
Auto Off	Disable/5 min/10 min/15 min/20 min/25 min/30 min		
Sleep Timer	Disable/30 min/60 min/90 min/120 min/150 min/180 min		
Menu Settings	Menu Display Time	5 sec/10 sec/15 sec/20 sec/25 sec/30 sec/ Always On	
	Menu Position	Center/Top-Left/Top-Right/Bottom-Right/Bottom-Left	
	Blank Reminder Message	On/Off	
Input Source	HDMI 1/HDMI 2/Video/S-Video/Component 1/Component 2/PC/Wireless		
Source Rename			
Auto Source Search	On/Off		

Advanced Setup	Lamp Settings	Reset Lamp Timer		
		Equivalent Lamp Hour		
	HDMI Settings	HDMI Format	Auto	
			PC Signal	
			Video Signal	
		CEC	On/Off	
	Baud Rate		2400/4800/9600/19200/38400/57600/115200	
	Test Pattern			
	Closed Caption	Closed Caption Enable	On/Off	
		Caption Version	CC1/CC2/CC3/CC4	
	Quick Cooling		On/Off	
	High Altitude Mode		On/Off	
	Password	Change Password		
		Power On Lock	On/Off (inputs current password)	
	Key Lock		On/Off	
	Reset All Settings			
	ISF		(inputs password)	
Information	Source			
	Preset Mode			
	Resolution			
	Color System			
	Equivalent Lamp Hour			
	3D Format			
	Firmware Version			

Note that the menu items are available when the projector detects at least one valid signal. If there is no equipment connected to the projector or no signal detected, limited menu items are accessible.





Picture -- Basic menu

Function	Description
Preset Mode	Pre-defined picture modes are provided so you can optimize your projector picture set-up to suit your program type. See "Selecting a preset mode" on page 35 for details.
User Mode Management	Selects a preset mode that most suits your need for the picture quality and further fine-tune the picture based on the selections listed below. See "Setting the User 1/User 2/User 3 mode" on page 35 for details.
Brightness	Adjusts the brightness of the picture. See "Adjusting Brightness" on page 36 for details.
Contrast	Adjusts the degree of difference between dark and light in the picture. See "Adjusting Contrast" on page 36 for details.
Color	Adjusts the color saturation level -- the amount of each color in a video picture. See "Adjusting Color" on page 37 for details.
Tint	Adjusts the red and green color tones of the picture. See "Adjusting Tint" on page 37 for details.
Sharpness	Adjusts the picture to make it look sharper or softer. See "Adjusting Sharpness" on page 37 for details.
Flesh Tone	See "Adjusting Flesh Tone" on page 37 for details.
Color Temperature	There are several color temperature settings available. See "Selecting a color temperature*" on page 37 for details.
Frame Interpolation	Enhances picture smoothness and clarity using motion estimation/motion compensation technology. You can also manually press ◀/▶ to decide its degree.
Lamp Power	Sets the projector lamp power mode as Normal , Economic , or SmartEco . See "Setting Lamp Power as Economic or SmartEco" on page 59 for details.
Advanced...	<p>Black Level Sets the picture grayscale as 0 IRE or 7.5 IRE. See "Setting Black Level" on page 38 for details.</p> <p>Clarity Control Adjusts the picture clarity. See "Controlling image clarity" on page 38 for details.</p> <p>Color Temperature Fine Tuning See "To save and leave the settings, press MENU/EXIT." on page 38 for details.</p> <p>Gamma Selection See "To save and leave the settings, press MENU/EXIT." on page 38 for details.</p> <p>Brilliant Color See "Adjusting Brilliant Color" on page 39 for details.</p> <p>Color Management See "Color Management" on page 39 for details.</p>
Reset Picture Settings	Returns all settings in the Picture -- Basic menu to the factory preset values. See "Resetting the picture mode" on page 36 for details.

Audio Setup menu

Function	Description
SRS	Enables or disables the SRS function. Selecting On to enable the surround sound.
Mute	See " Muting the sound " on page 41 for details.
Volume	See " Adjusting the sound " on page 41 for details.
Treble	Adjusts the higher frequencies of your audio source through the projector. The higher the value, the more treble effect you'll receive.
Bass	Adjusts the lower frequencies of your audio source through the projector. The higher the value, the more bass effect you'll receive.
L/R Switch	See " Switching the left/right audio channels " on page 41 for details.
Power On/Off Ring Tone	See " Turning off the Power On/Off Ring Tone " on page 41 for details.

Display menu





Function	Description
Aspect Ratio	There are several options to set the picture's aspect ratio depending on your input source. See "Selecting the aspect ratio" on page 42 for details.
Keystone	Corrects any keystone of the picture. See "Correcting picture distortion" on page 34 for details.
Position	Displays the position adjustment page. To move the projected picture, use the directional arrow keys. The values shown on the lower position of the page change with every key press you made until they reach their maximum or minimum.  This function is only available when the PC signal is selected.
Overscan Adjustment	Conceals the poor picture quality in the four edges. You can also manually press ◀/▶ to decide how much to be concealed. Setting 0 means the picture is 100% displayed. The greater the value, the more portion of the picture is concealed while the screen remains filled and geometrically accurate.
PIP	Turns the PIP window on or off and makes related adjustments. See "Displaying more than one image source simultaneously" on page 45 for details.
PC & Component YPbPr Tuning	<p>H. Size Adjusts the horizontal width of the picture.</p> <p>Phase Adjusts the clock phase to reduce picture distortion.</p> <p>Auto Adjusts the phase, and frequency automatically.</p>  <p> These functions are only available when the Component 1, Component 2, or PC signal is selected.</p>
Digital Zoom	See "Magnifying and searching for details" on page 43 for details.
Film Mode	See "Setting Film Mode" on page 40 for details.
3D Comb Filter	See "Setting 3D Comb Filter" on page 40 for details.
3D	<p>3D Mode This projector features a 3D function which enables you to enjoy the 3D movies, videos, and sporting events in a more realistic way by presenting the depth of the images. You need to wear a pair of 3D glasses to view the 3D images.</p> <p> When the 3D Mode function is enabled:</p> <ul style="list-style-type: none"> • The brightness level of the projected image will decrease. • The Preset Mode cannot be adjusted. • The Keystone can only be adjusted within limited degrees. <p>3D Depth Adjust Adjusts the depth level of 3D images on the screen to let you perceive more natural and comfortable effect of 3D contents.</p> <p>3D Sync Invert When you 3D image is distorted, you can enable this function to switch between the image for the left eye and the right eye for the more comfortable 3D viewing experience.</p> <p>See "Displaying more than one image source simultaneously" on page 45 for details.</p>

System Setup menu

Function	Description
Language	Sets the language for the On-Screen Display (OSD) menus. See "Using the menus" on page 31 for details.
Splash Screen	Allows you to select which logo screen will display during projector start-up. You can choose BenQ logo screen, Blue screen or Black screen.
Projector Position	The projector can be installed on a ceiling or behind a screen, or with one or more mirrors. See "Choosing a location" on page 15 for details.
Auto Off	Prevents unnecessary projection when no signal is detected for a long time. See "Setting Auto Off" on page 59 for details.
Sleep Timer	Sets the auto-shutdown timer. The timer can be set to a value between 30 minutes and 3 hours.
Menu Settings	<p>Menu Display Time Sets the length of time the OSD will remain active after your last key press.</p> <p>Menu Position Sets the On-Screen Display (OSD) menu position.</p> <p>Blank Reminder Message Sets whether the blank reminder message is displayed by the projector while the image is hidden.</p>
Input Source	Selects an input source to be projected. See "Selecting an input source" on page 30 for details.
Source Rename	Renames the source to your desired name. See "Selecting an input source" on page 30 for details.
Auto Source Search	Sets whether the projector searches automatically for input sources. If the source scan is On , the projector will scan for input sources until it acquires a signal. If the function is not activated, the projector selects the last used input source.

Advanced Setup menu

Function	Description
Lamp Settings	<p>Reset Lamp Timer Once the lamp is renewed, select Reset to return the lamp timer to "0". See "Resetting the lamp timer" on page 62 for details.</p> <p>Equivalent Lamp Hour Shows the lamp hour information. See "Getting to know the lamp hour" on page 59 for details.</p>
HDMI Settings	<p>HDMI Format Selects an input source type for the HDMI signal. You can also manually select the source type. The different source types carry different standards for the brightness level.</p> <p> HDMI Format is only available when the HDMI signal is selected.</p> <p>CEC Enables or disables the CEC function. When you connect an HDMI CEC-compatible device to your projector with an HDMI cable, turning on the HDMI CEC compatible device automatically turns on the projector, while turning off the projector automatically turns off the HDMI CEC compatible device.</p>
Baud Rate	Selects a baud rate that is identical with your computer's so that you can connect the projector using a suitable RS-232 cable and update or download the projector's firmware. This function is intended for qualified service personnel.

Test Pattern	<p>Press ENTER to display the grid test pattern. It helps you adjust the image size and focus and check that the projected image is free of distortion.</p> <p> The function is only available when the projector detects no input signal.</p>
Closed Caption	<p>Closed Caption Enable Activates the function by selecting On when the selected input signal carries closed captions.</p> <p> Captions: An on-screen display of the dialogue, narration, and sound effects of TV programs and videos that are closed captioned (usually marked as "CC" in TV listings).</p> <p>Caption Version Selects a preferred closed captioning mode. To view captions, select CC1, CC2, CC3, or CC4 (CC1 displays captions in the primary language in your area).</p>
Quick Cooling	<p>Enables or disables the Quick Cooling function. Selecting On enables the function and projector cooling time will be shortened from a normal 90-second duration to approximately 5 seconds.</p>
High Altitude Mode	<p>A mode for operation in areas like high altitude or high temperature. See "Operating in a high altitude environment" on page 44 for details.</p>
Password	<p>Change Password You will be asked to enter the current password before changing to a new one. See "Utilizing the password function" on page 32 for details.</p> <p>Power On Lock Limits use of the projector to only those who know the correct password. See "Utilizing the password function" on page 32 for details.</p>
Key Lock	<p>See "Locking control keys" on page 47 for details.</p>
Reset All Settings	<p>Returns all settings to the factory preset values.</p> <p> The following settings will still remain: Keystone, Language, Projector Position, High Altitude Mode, Password, Key Lock, and ISF.</p>
ISF	<p>The ISF calibration menu is password protected and only accessible by authorized ISF calibrators. The ISF (Imaging Science Foundation) has developed carefully crafted, industry-recognized standards for optimal video performance and has implemented a training program for technicians and installers to use these standards to obtain optimal picture quality from BenQ video display devices. Accordingly, we recommend that setup and calibration be performed by an ISF certified installation technician.</p> <p> For more information, please go to www.imagingscience.com or contact the place you purchased the projector.</p>

Information menu

This menu shows you the current operating status of the projector.

 Some picture adjustments are available only when certain input sources are in use. Unavailable adjustments are not shown on the screen.

Function	Description
Source	Shows the current signal source.
Preset Mode	Shows the selected mode in the Picture -- Basic > Preset Mode menu.
Resolution	Shows the native resolution of the input source.
Color System	Shows input system format: NTSC, PAL, SECAM, YUV, or RGB.
Equivalent Lamp Hour	Shows the total lamp time used.
3D Format	Shows the current 3D mode.  3D Format is only available when 3D Mode is enabled.
Firmware Version	Shows the firmware version of your projector.

Additional information

Care of the projector

Your projector needs little maintenance. The only thing you have to do on a regular basis is keep the lens clean. Never remove any parts of the projector except the lamp. Contact your dealer or local customer service center if the projector fails to operate as expected.

Cleaning the lens

Clean the lens whenever you notice dirt or dust on the surface. Before you attempt to clean the lens, turn the projector off, unplug the power cable, and leave it several minutes to cool completely.

1. Use a canister of compressed air to remove dust. (Available from building hardware or photographic suppliers.)
2. If there is stubborn dirt or smudge marks, use a proper photographic lens brush or moisten a clean soft lens cloth with lens cleaner to gently wipe the lens surface.
3. Never use any type of abrasive pad, alkaline/acid cleaner, scouring powder, or volatile solvent, such as alcohol, benzene, thinner or insecticide. Using such materials or maintaining prolonged contact with rubber or vinyl materials may result in damage to the projector surface and cabinet material.

 **Never touch the lens with your finger or rub the lens with abrasive materials. Even paper towels can damage the lens coating. Only ever use a proper photographic lens brush, cloth, and cleaning solution. Do not attempt to clean the lens while the projector is switched on or is still hot from previous use.**

Cleaning the projector case

Before you attempt to clean the case, turn the projector off, unplug the power cable, and leave it several minutes to cool completely.

1. To remove dirt or dust, wipe the case with a soft, dry, lint-free cloth.
2. To remove stubborn dirt or stains, moisten a soft cloth with water and a neutral detergent. Then wipe the case.

 **Never use wax, alcohol, benzene, thinner or other chemical detergents. These can damage the case.**

Storing the projector

If you need to store the projector for an extended time, please:

1. Make sure the temperature and humidity of the storage area are within the recommended range for the projector. Please refer to the Spec. page in this manual or consult your dealer about the range.
2. Retract the adjuster feet.
3. Remove the batteries from the remote control.
4. Pack the projector in its original packing or equivalent.

Transporting the projector

It is recommended that you ship the projector with its original packing or equivalent.

Lamp information

Getting to know the lamp hour

When the projector is in operation, the duration (in hours) of lamp usage is automatically calculated by the built-in timer.

☞ See "**Setting Lamp Power as Economic or SmartEco**" below for more information on **Economic mode**.

To obtain the lamp hour information:

1. Press **MENU/EXIT** and then press ◀/▶ until the **Advanced Setup** menu is highlighted.
2. Press ▼ to highlight **Lamp Settings** and press **MODE/ENTER**. The **Lamp Settings** page displays.
3. The lamp hour information is shown in the row of **Equivalent Lamp Hour**.
4. To leave the menu, press **MENU/EXIT**.

Extending lamp life

The projection lamp is a consumable item. To keep the lamp life as long as possible, you can do the following settings via the OSD menu.

- **Setting Lamp Power as Economic or SmartEco**

Using **Economic** mode reduces system noise and power consumption by 30%. Using **SmartEco** mode reduces system noise and lamp power consumption by up to 70%. If the **Economic** or **SmartEco** mode is selected, the light output will be reduced and result in darker projected pictures

Setting the projector in **Economic** or **SmartEco** mode also extends the lamp life. To set **Economic** or **SmartEco** mode, go to the **Picture -- Basic > Lamp Power** menu, and press **MODE/ENTER**. The **Lamp Power** page displays. Then press ▲/▼ repeatedly until your desired mode is selected and press **MODE/ENTER**.

Lamp mode	Description
Normal	100% lamp brightness
Economic	Saves 30% lamp power consumption
SmartEco	Saves up to 70% lamp power consumption depending on the content brightness level

- **Setting Auto Off**

This function allows the projector to turn off automatically if no input source is detected after a set period of time.

To set **Auto Off**, go to the **System Setup > Auto Off** menu and press ◀/▶ to select a time period. The time period can be set from 5 to 30 minutes in 5-minute increments. If the preset time lengths are not suitable for your presentation, select **Disable**. The projector will not automatically shut down in a certain time period.

Timing of replacing the lamp

When the Lamp indicator lights up red or a message appears suggesting it is time to replace the lamp, please install a new lamp or consult your dealer. An old lamp may cause a malfunction in the projector and in some instances the lamp may explode. Go to <http://lamp.BenQ.com> for a replacement lamp.

The Lamp indicator light and Temperature warning light will light up if the lamp becomes too hot. Turn the power off and let the projector cool for 45 minutes. If the Lamp or Temp indicator still lights up after turning the power back on, please contact your dealer. See "Indicators" on page 63 for details.

The following Lamp warning displays will remind you to change the lamp.

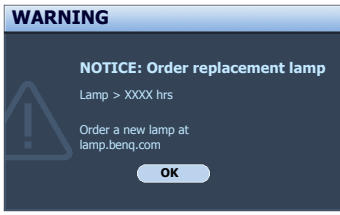
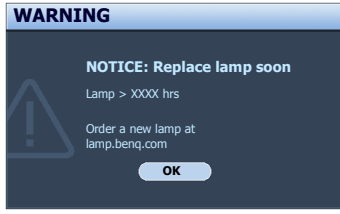
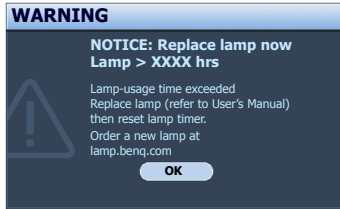
Status	Message
<p>Install a new lamp for optimal performance. If the projector is normally run with Economic selected (see "Getting to know the lamp hour" on page 59), you may continue to operate the projector until the next hour lamp warning appears.</p> <p>Press MODE/ENTER to dismiss the message.</p>	
<p>It is strongly recommended that you replace the lamp at this stage. The lamp is a consumable item. The lamp brightness diminishes with use. This is normal lamp behavior. You can replace the lamp whenever you notice that the brightness level has significantly diminished.</p> <p>Press MODE/ENTER to dismiss the message.</p>	
<p>The lamp MUST be replaced before the projector will operate normally.</p> <p>Press MODE/ENTER to dismiss the message.</p>	

 "XXXX" shown in the above messages are numbers that vary depending on different models.

Replacing the lamp

- ⚠ • To reduce the risk of electrical shock, always turn the projector off and disconnect the power cord before changing the lamp.
- To reduce the risk of severe burns, allow the projector to cool for at least 45 minutes before replacing the lamp.
- To reduce the risk of injuries to fingers and damage to internal components, use caution when removing lamp glass that has shattered into sharp pieces.
- To reduce the risk of injuries to fingers and/or compromising image quality by touching the lens, do not touch the empty lamp compartment when the lamp is removed.
- This lamp contains mercury. Consult your local hazardous waste regulations to dispose of this lamp in a proper manner.
- To assure optimal performance from the projector, it is recommended that you purchase a qualified projector lamp for lamp replacement.
- If lamp replacement is performed while the projector is suspended upside-down from the ceiling, make sure that no one is underneath the lamp socket to avoid any possible injury or damage to the human eyes caused by fractured lamp.
- Ensure good ventilation when handling broken lamps. We recommend that you use respirators, safety glasses, goggles or face shield and wear protective clothing such as gloves.

1. Turn the power off and disconnect the projector from the power outlet. If the lamp is hot, avoid burns by waiting for approximately 45 minutes until the lamp has cooled.
2. Loosen the screw that secures the lamp cover on the side of the projector until lamp cover loosens.

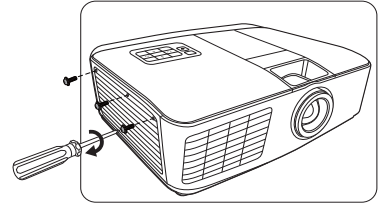

3. Remove lamp cover from the projector.

- ⚠ • Do not turn on the power with lamp cover removed.
- Do not insert your fingers between the lamp and the projector. The sharp edges inside the projector may cause injuries.

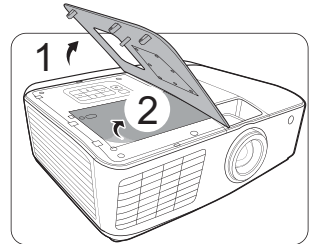

4. Loosen the screw that secures the lamp.
5. Lift the handle upward.
6. Shift lamp housing slightly to the left to allow space for the whole lamp housing, as illustrated.

- ⚠ • Do not pull the whole lamp housing out until instructed to do so.

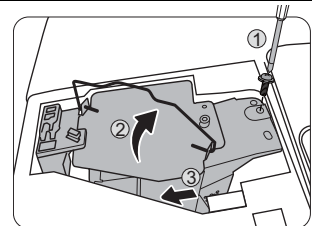

7. Use the handle to slowly pull lamp housing out of the projector.



- **Pulling it too quickly may cause the lamp to break and scatter broken glass in the projector.**
- **Do not place the lamp in locations where water might splash on it, children can reach it, or near flammable materials.**
- **Do not insert your hands into the projector after the lamp is removed. If you touch the optical components inside, it could cause color unevenness and distortion of the projected images.**

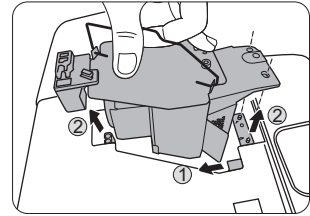

8. Carefully lower the new lamp housing to slide it from left to right into the lamp compartment, as illustrated.



- **Be careful not to damage the sides of the new lamp housing while lowering the whole assembly.**

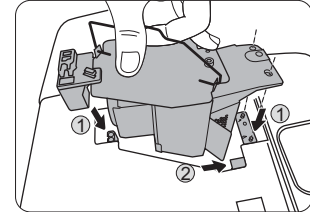

9. Tighten the screw that secures the lamp.

10. Ensure the handle is fully laid flat and locked in place.



- **Loose screw may cause a bad connection, which could result in malfunction.**
- **Do not over tighten the screw.**

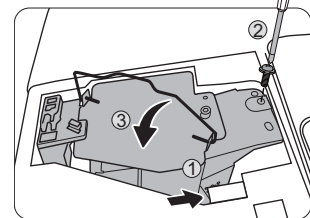

11. Replace the lamp cover on the projector.

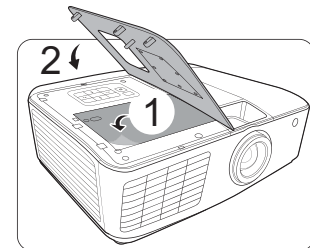

12. Tighten the screw that secures the lamp cover.



- **Loose screw may cause a bad connection, which could result in malfunction.**
- **Do not over tighten the screw.**

13. Connect the power and restart the projector.

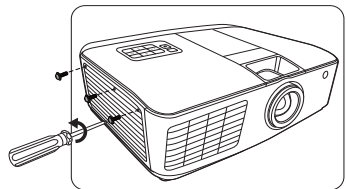

Resetting the lamp timer



Do not reset the lamp timer if the lamp has not been replaced as this could cause damage.

14. After the start-up logo, press **MENU/EXIT** and then press **◀/▶** until the **Advanced Setup** menu is highlighted.
15. Press **▼** to highlight **Lamp Settings** and press **MODE/ENTER**. The **Lamp Settings** page displays.
16. Highlight **Reset Lamp Timer** and press **MODE/ENTER**. A warning message displays asking if you want to reset the lamp timer. Highlight **Reset** and press **MODE/ENTER**. The lamp time will be reset to "0".

Indicators

There are three indicators which show the status of the projector. Check the following for information about the indicator lights. If there is anything wrong, turn the projector off and contact your dealer.

■ When the projector is in a normal state

Power	Temp	Lamp	Status & Description
Orange	Off	Off	Stand-by mode
Green Flashing	Off	Off	Powering up
Green	Off	Off	Normal operation
Orange Flashing	Off	Off	Normal power-down cooling

■ When the projector is in an abnormal state

Power	Temp	Lamp	Status & Description
Off	Off	Red	<ul style="list-style-type: none"> The lamp has been damaged. Please contact your local BenQ customer center for purchasing a new lamp.
Off	Off	Red Flashing	<ul style="list-style-type: none"> The lamp is not properly attached. The lamp has been damaged. Please contact your local BenQ customer center for purchasing a new lamp.
Red	Red	Off	The fans are not working. The projector has shut down automatically. If you try to re-start the projector, it will shut down again. Please contact your dealer for assistance.
Red	Red Flashing	Off	
Red	Green	Off	
Red	Green Flashing	Off	
Green	Red	Off	The internal temperature is too high. <ul style="list-style-type: none"> The intake ventilation or the exhaust ventilation is blocked. The projector may be in a poorly ventilated location. The ambient temperature may be too high.

Troubleshooting

Problem	Cause	Remedy
The projector does not turn on.	There is no power from the power cable.	Plug the power cable into the AC inlet on the rear of the projector, and plug the power cable into to the power outlet. If the power outlet has a switch, make sure that it is switched on. (See page 29.)
	Attempting to turn the projector on again during the cooling process.	Wait until the cooling down process has completed.
	The lamp cover is not securely attached.	Correctly attach the lamp cover. (See page 61.)
No picture.	The video source is not turned on or connected correctly.	Turn the video source on and check that the signal cable is connected correctly. (See page 21.)
	The projector is not correctly connected to the input source device.	Check the connection. (See page 21.)
	The input source has not been correctly selected.	Select the correct input source with the Source keys on the remote control or SOURCE on the projector. (See page 30.)
Image is unstable.	The connection cables are not securely connected to the projector or the signal source.	Correctly connect the cables to the appropriate terminals. (See page 21.)
Picture is blurred.	The projection lens is not correctly focused.	Adjust the focus of the lens using the focus ring. (See page 30.)
	The projector and the screen are not aligned properly.	Adjust the projection angle and direction as well as the height of this projector if necessary. (See page 34.)
Remote control does not work correctly.	The batteries are out of power.	Replace both of the batteries with new ones. (See page 9.)
	There is an obstacle between the remote control and the projector.	Remove the obstacle. (See page 9.)
	You are too far away from the projector.	Stand within 8 meters (26.2 feet) of the projector. (See page 9.)
3D content does not display correctly	The 3D glasses are out of battery.	Recharge the 3D glasses.
	The settings in the 3D menu are not set correctly.	Correctly set the settings in the 3D menu. (See page 45.)
	Your Blu-ray Disc is not in 3D format.	Use a 3D Blu-ray Disc and try again.
	The input source has not been correctly selected.	Select the correct source with the Source keys on the remote control or SOURCE on the projector. (See page 30.)

Specifications

 All specifications are subject to change without notice.

Optical

Resolution

1920 (H) x 1080 (V)

Display system

Single-chip DLP™ system

Lens F/Number

F = 2.45 to 3.07, f = 15.78 to 25.12 mm

Lamp

Osram P-VIP 240W/0.8 E20.9n

Electrical

Power supply

AC100–240V, 3.60 A, 50-60 Hz (Automatic)

Power consumption

422 W (Max); < 0.5 W (Standby)

Mechanical

Weight

4.5 Kg (9.9 lbs)

Output terminals

Speaker

(Stereo) 10 watt x 2

Audio signal output

3.5mm Mono Mini-Jack x 1

Control

RS-232 serial control

9 pin x 1

IR receiver x 2

Mini B type USB x 1 (Used for service)

Input terminals

Computer input

RGB input

D-Sub 15-pin (female) x 1

Video signal input

S-VIDEO

Mini DIN 4-pin port x 1

VIDEO

RCA jack x 1

SD/HDTV signal input

Analog - Component RCA jack x 1
(through RGB input)

Digital - HDMI x 2

Audio signal input

Audio in

RCA audio jack (L/R) x 2

3.5mm Stereo Mini-Jack x 1

Environmental Requirements

Operating temperature

0°C–40°C at sea level

Operating relative humidity

10%–90% (without condensation)

Operating altitude

0–1499 m at 0°C–35°C

1500–3000 m at 0°C–30°C (with

High Altitude Mode on)

■ Dimensions

339mm (W) x 120.2 mm (H) x 284.8 mm (D)

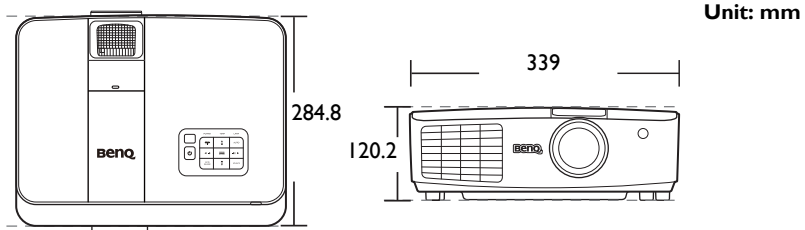

■ Ceiling mount installation

- ⊙ Ceiling Mount screw: M4
(Max L = 8 mm)

Unit: mm

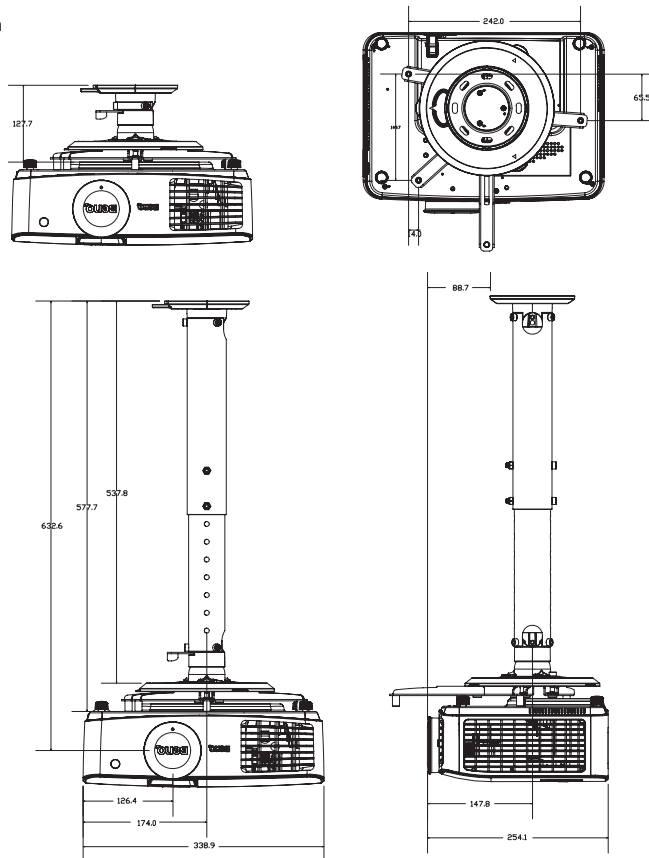

■ Timing chart

Supported timing for PC input

Resolution	Mode	Refresh rate (Hz)	H. Freq. (KHz)	Clock (MHz)
720 x 400	720 x 400	70.087	31.469	28.3221
640 x 480	VGA_60	59.940	31.469	25.175
	VGA_72	72.809	37.861	31.500
	VGA_75	75.000	37.500	31.500
	VGA_85	85.008	43.269	36.000
800 x 600	SVGA_56	56.250	35.156	36.000
	SVGA_60*	60.317	37.879	40.000
	SVGA_72	72.188	48.077	50.000
	SVGA_75	75.000	46.875	49.500
	SVGA_85	85.061	53.674	56.250
1024 x 768	XGA_60	60.004	48.363	65.000
	XGA_70	70.069	56.476	75.000
	XGA_75	75.029	60.023	78.750
	XGA_85	84.997	68.667	94.500
1024 x 576	BenQ Notebook Timing	60.0	35.820	46.966
1024 x 600	BenQ Notebook Timing	64.995	41.467	51.419
1280 x 768	1280 x 768_60	59.870	47.776	79.5
1280 x 800	WXGA_60	59.810	49.702	83.500
	WXGA_75	74.934	62.795	106.500
	WXGA_85	84.880	71.554	122.500
1280 x 1024	SXGA_60	60.020	63.981	108.000
	SXGA_75	75.025	79.976	135.000
	SXGA_85	85.024	91.146	157.500
1280 x 960	1280 x 960_60	60.000	60.000	108
	1280 x 960_85	85.002	85.938	148.500
1360 x 768	1360 x 768_60	60.015	47.712	85.500
1440 x 900	WXGA+_60	59.887	55.935	106.500
1400 x 1050	SXGA+_60	59.978	65.317	121.750
1600 x 1200	UXGA	60.000	75.000	162.000

1920 x 1080	1920 x 1080_60	59.939/60	67.432/67.5	148.35/148.5
640 x 480@67Hz	MAC13	66.667	35.000	30.240
832 x 624@75Hz	MAC16	74.546	49.722	57.280
1024 x 768@75Hz	MAC19	74.93	60.241	80.000
1152 x 870@75Hz	MAC21	75.06	68.68	100.00

Resolution	Mode	Refresh rate (Hz)	H. Freq. (KHz)	Clock (MHz)
720 x 480	480i	59.94	15.73	13.5
720 x 480	480p	59.94	31.47	27
720 x 576	576i	50	15.63	13.5
720 x 576	576p	50	31.25	27
1280 x 720	720/50p	50	37.5	74.25
1280 x 720	720/60p	60	45.00	74.25
1920 x 1080	1080/24P	24	27	74.25
1920 x 1080	1080/25P	25	28.13	74.25
1920 x 1080	1080/30P	30	33.75	74.25
1920 x 1080	1080/50i	50	28.13	74.25
1920 x 1080	1080/60i	60	33.75	74.25
1920 x 1080	1080/50P	50	56.25	148.5
1920 x 1080	1080/60P	60	67.5	148.5

Supported timing for HDMI (HDCP) input

Resolution	Mode	Refresh rate (Hz)	H. Freq. (KHz)	Clock (MHz)
640 x 480	VGA_60	59.940	31.469	25.175
	VGA_72	72.809	37.861	31.500
	VGA_75	75.000	37.500	31.500
	VGA_85	85.008	43.269	36.000
720 x 400	720 x 400	70.087	31.469	28.3221
800 x 600	SVGA_60	60.317	37.879	40.000
	SVGA_72	72.188	48.077	50.000
	SVGA_75	75.000	46.875	49.500
	SVGA_85	85.061	53.674	56.250
1024 x 768	XGA_60	60.004	48.363	65.000
	XGA_70	70.069	56.476	75.000
	XGA_75	75.029	60.023	78.750
	XGA_85	84.997	68.667	94.500
	XGA_120 * (Reduce Blanking)	119.989	97.551	115.500
1024 x 576	BenQ Notebook Timing	60.00	35.820	46.996
1024 x 600	BenQ Notebook Timing	64.995	41.467	51.419
1280 x 720	1280 x 720_60	60	45.000	74.250
	1280 x 720_120 *	120	90.000	148.500
1280 x 768	1280 x 768_60	59.870	47.776	79.5
1280 x 800	WXGA_60	59.810	49.702	83.500
	WXGA_75	74.934	62.795	106.500
	WXGA_85	84.880	71.554	122.500
1280 x 1024	SXGA_60	60.020	63.981	108.000
	SXGA_75	75.025	79.976	135.000
	SXGA_85	85.024	91.146	157.500
1280 x 960	1280 x 960_60	60.000	60.000	108
	1280 x 960_85	85.002	85.938	148.500
1360 x 768	1360 x 768_60	60.015	47.712	85.500
1440 x 900	WXGA+_60	59.887	55.935	106.500

1400 x 1050	SXGA+_60	59.978	65.317	121.750
1600 x 1200	UXGA	60.000	75.000	162.000
1920 x 1080	1920 x 1080_60 (CEA-861)	59.939/60	67.432/67.5	148.35/148.5
640 x 480@67Hz	MAC13	66.667	35.000	30.240
832 x 624@75Hz	MAC16	74.546	49.722	57.280
1024 x 768@75Hz	MAC19	75.020	60.241	80.000
1152 x 870@75Hz	MAC21	75.06	68.68	100.00

- ☞ ***Supported timing for 3D signal with Frame Sequential format.**
- The timings showing above may not be supported due to EDID file and VGA graphic card limitations. It is possible that some timings cannot be chosen.**

Timing	Resolution	V. Freq. (Hz)	H. Freq. (KHz)	Dot Clock Freq. (MHz)
480i	720 (1440) x 480	59.94	15.73	27
480p	720 x 480	59.94	31.47	27
576i	720 (1440) x 576	50	15.63	27
576p	720 x 576	50	31.25	27
720/50p *	1280 x 720	50	37.5	74.25
720/59 *	1280 x 720	59.94	44.955	74.175
720/60p *	1280 x 720	60	45.00	74.25
1080/23P *	1920 x 1080	23.98	26.973	74.176
1080/24P *	1920 x 1080	24	27	74.25
1080/25P	1920 x 1080	25	28.13	74.25
1080/30P	1920 x 1080	30	33.75	74.25
1080/50i ***	1920 x 1080	50	28.13	74.25
1080/59i ***	1920 x 1080	59.94	33.716	74.175
1080/60i ***	1920 x 1080	60	33.75	74.25
1080/50P **	1920 x 1080	50	56.25	148.5
1080/60P **	1920 x 1080	60	67.5	148.5

- ☞ ***Supported timing for 3D signal with Frame Packing and Top-Bottom format.**
- **Supported timing for 3D signal with Side-by-Side and Top-Bottom format.**
- ***Supported timing for 3D signal with Side-by-Side format.**

Supported timing for EDTV and HDTV (via Component 1 and Component 2 inputs)

Resolution	Mode	Refresh rate (Hz)	H. Freq. (KHz)	Clock (MHz)
720 x 480	480i	59.94	15.73	13.5
720 x 480	480p	59.94	31.47	27
720 x 576	576i	50	15.63	13.5
720 x 576	576p	50	31.25	27
1280 x 720	720/50p	50	37.5	74.25
1280 x 720	720/60p	60	45.00	74.25
1920 x 1080	1080/24P	24	27	74.25
1920 x 1080	1080/25P	25	28.13	74.25
1920 x 1080	1080/30P	30	33.75	74.25
1920 x 1080	1080/50i	50	28.13	74.25
1920 x 1080	1080/60i	60	33.75	74.25
1920 x 1080	1080/50P	50	56.25	148.5
1920 x 1080	1080/60P	60	67.5	148.5

Supported timing for Video and S-Video inputs

Video Mode	H. Freq. (KHz)	V. Freq. (Hz)	Sub-carrier Frequency (MHz)
NTSC	15.73	60	3.58
PAL	15.63	50	4.43
SECAM	15.63	50	4.25 or 4.41
PAL-M	15.73	60	3.58
PAL-N	15.63	50	3.58
PAL-60	15.73	60	4.43
NTSC4.43	15.73	60	4.43

Warranty and Copyright information

Warranty

BenQ warrants this product against any defects in material and workmanship, under normal usage and storage.

Proof of purchase date will be required with any warranty claim. In the event this product is found to be defective within the warranty period, BenQ's only obligation and your exclusive remedy shall be replacement of any defective parts (labor included). To obtain warranty service, immediately notify the dealer from which you purchased the product of any defects.

Important: The above warranty shall be void if the customer fails to operate the product in accordance with BenQ's written instructions, especially the ambient humidity must be in-between 10% and 90%, temperature in-between 0°C and 35°C, altitude lower than 3000 meters, and avoiding to operate the projector in a dusty environment. This warranty gives you specific legal rights, and you may have other rights which vary from country to country.

For other information, please visit www.BenQ.com.

Copyright

Copyright © 2013 by BenQ Corporation. All rights reserved. No part of this publication may be reproduced, transmitted, transcribed, stored in a retrieval system or translated into any language or computer language, in any form or by any means, electronic, mechanical, magnetic, optical, chemical, manual or otherwise, without the prior written permission of BenQ Corporation.

All trademarks and registered trademarks are the property of their respective owners.

Disclaimer

BenQ Corporation makes no representations or warranties, either expressed or implied, with respect to the contents hereof and specifically disclaims any warranties, merchantability or fitness for any particular purpose. Further, BenQ Corporation reserves the right to revise this publication and to make changes from time to time in the contents hereof without obligation of BenQ Corporation to notify any person of such revision or changes.

Patents



SRS WOW HD is a trademark of SRS Labs, Inc. WOW HD technology is incorporated under license from SRS Labs, Inc.

WOW HD™ significantly improves the playback quality of audio, delivering a dynamic 3D entertainment experience with deep, rich bass and high frequency clarity for crisp detail.

Free Manuals Download Website

<http://myh66.com>

<http://usermanuals.us>

<http://www.somanuals.com>

<http://www.4manuals.cc>

<http://www.manual-lib.com>

<http://www.404manual.com>

<http://www.luxmanual.com>

<http://aubethermostatmanual.com>

Golf course search by state

<http://golfingnear.com>

Email search by domain

<http://emailbydomain.com>

Auto manuals search

<http://auto.somanuals.com>

TV manuals search

<http://tv.somanuals.com>