



OPERATING INSTRUCTIONS

MCS-D 200

Digital multimedia-based Conference System

Note

This manual is for electro-technically qualified staff. The knowledge and the precise realisation of these instructions are necessary for a smooth installation and security during the operation of the described products.

Due to the danger of fire special installations of power cable may be carried out by electro-technically qualified staff only.

This manual does not include each possible case of installation, operation or maintenance. For more information please contact your beyerdynamic dealer or beyerdynamic GmbH & Co. KG.

beyerdynamic assumes no liability for errors in this documentation and for damages resulting from using this documentation and the products described in it.

Notes for potential reassignments

1. In order to avoid damages, please dispatch the microphone units in a strong packaging, if you need to return them.
2. If you want to return individual microphone units, please make sure that no heavy weights can damage them or the goosenecks through the packaging.

Table of Contents

1. Important Safety Instructions	Page	7
2. Set-up	Page	8
3. MCS-D 200 Control Unit	Page	8
3.1 Controls and indicators.....	Page	8
3.2 Putting into operation	Page	9
3.2.1 Audio connection	Page	9
3.2.2 Mains connection	Page	10
3.2.3 How to switch the control unit on/off.....	Page	10
3.2.4 How to connect a PC or media control system.....	Page	11
3.2.5 Rack mounting	Page	11
3.2.6 How to supply the system.....	Page	11
3.3 How to operate the menu of the MCS-D 200 control unit	Page	12
3.3.1 Menu overview of the MCS-D 200 control unit	Page	12
3.3.2 Main Menu	Page	13
3.3.3 System Set-up Menus	Page	14
3.3.4 Session Menus	Page	16
3.3.4.1 Modes / Limit Menus.....	Page	17
3.3.4.2 Channel List	Page	20
3.3.4.3 President(s).....	Page	22
3.3.4.4 Interpreter	Page	24
3.3.5 Define Channels	Page	26
3.3.6 Options.....	Page	28
3.3.6.1 Time	Page	28
3.3.6.2 Ports	Page	29
3.3.6.3 MCS-D Info.....	Page	29
3.3.7 Delegate IDs.....	Page	30
3.3.7.1 ID List	Page	31
3.3.7.2 Set IDs.....	Page	32
3.3.7.3 Conflicts	Page	32
3.3.8 Interpreter IDs.....	Page	33
3.3.8.1 Interpreter ID List	Page	34
3.3.8.2 Set Interpreter IDs.....	Page	34
3.3.8.3 Conflicts	Page	35
3.3.9 Technician IDs	Page	35
3.3.10 DAI/DDI Management.....	Page	36
3.3.10.1 Ext. DAI ID List.....	Page	37
3.3.10.2 DAI Set-up	Page	37
3.3.10.3 DAI Control	Page	39
4. CA 4115/30/45 Power Supply Unit	Page	41
4.1 Controls and indicators.....	Page	41
4.2 Connection.....	Page	42
4.2.1 Control unit - power supply unit	Page	42
4.2.2 Microphone stations - power supply unit	Page	42
4.3 How to switch on the power supply unit	Page	42
5. CA 4522/44/66 Digital / Analogue Interface (DAI)	Page	43
5.1 Controls and Indicators.....	Page	44
6. CA 4577 Digital / Digital Interface (DDI)	Page	45
6.1 Controls and indicators.....	Page	45
7. Microphone Stations	Page	46
7.1 MCS-D 2073	Page	46
7.1.1 Controls and indicators.....	Page	46
7.1.2 How to turn the microphone on	Page	48
7.1.3 How to set the volume of the headphone	Page	49
7.1.4 How to set the language or channel.....	Page	49
7.1.5 Menu buttons	Page	49
7.1.6 Menu settings	Page	50
7.1.7 How to switch on a microphone while phoning	Page	52
7.1.8 How to operate the navigator buttons.....	Page	52
7.1.9 Display	Page	52
7.1.10 MCS-D 2073 as chairman station	Page	53
7.2 MCS-D 3121 / 3123	Page	54
7.2.1 Controls and indicators.....	Page	54
7.2.2 How to turn on the MCS-D 3121	Page	56
7.2.3 How to operate the MCS-D 3123 chairman station	Page	57



7.3	MCS-D 3171 / 3173	Page	58
7.3.1	Controls and indicators.....	Page	58
7.3.2	How to display the Device ID.....	Page	59
7.3.3	How to display messages	Page	60
7.3.4	How to turn on the MCS-D 3171	Page	60
7.3.5	How to adjust the headphone volume	Page	61
7.3.6	How to select the language or channel	Page	61
7.3.7	How to operate the MCS-D 3173 chairman station	Page	61
7.4	MCS-D 202	Page	62
7.4.1	Controls and indicators.....	Page	62
7.4.2	How to program the relay channel buttons 1-3.....	Page	64
7.4.3	Output channels A and B	Page	65
7.4.3.1	How to program the output channels A and B	Page	65
7.4.4	Call buttons	Page	66
7.4.5	How to assign the interpreter ID.....	Page	68
7.4.6	How to save settings on a chip card	Page	70
7.4.7	How to read the chip card data.....	Page	70
8.	Examples	Page	72
9.	Components	Page	84
10.	Optional Accessories	Page	84
11.	List of Language Codes	Page	85
12.	Technical Specifications	Page	87

Introduction

Thank you for selecting the digital multimedia-based MCS-D 200 conference system from beyerdynamic. Please take some time to read carefully through this manual before setting up the equipment.

This manual describes the installation and operation of the MCS-D 200 system without the control and configuration via PC.

MCS-D 200 is a fully digital multimedia-based conference system in single-cable design. It can be used for small and large events in permanent installations or for mobile use.

The system includes the following components:

- MCS-D 200 Control Unit
- MCS-D 2073 Delegate / Chairman Station
- MCS-D 202 Interpreter Stations
- MCS-D 3121 Delegate Station and MCS-D 3123 Chairman Station
- MCS-D 3171 Delegate Station and MCS-D 3173 Chairman Station
- Cabling via "NetRateBus"

The NetRateBus is a special kind of cabling which allows operating all services such as microphone channels, interpreting channels, control, network, telephone and safety precautions simultaneously on 54 channels without any interferences. The NetRateBus allows different types of cabling such as in a daisy chain, star or tree structure with any branch. The setup is clear and simple.

One conference system can consist of a maximum of 1,400 microphone units.

For the digital interpreter stations there is no additional control unit needed.

Third party devices such as PCs, automatic cameras with pan, tilt, zoom, recording devices, output devices or display screen in the hall can be connected.

With the MultiSession Management several meetings can be controlled simultaneously with one control unit and the software. The individual conference rooms can be combined to one large group or conference room by changing the software settings accordingly.

1. Important Safety Instructions

Control Unit and Power Supply Units

- READ these instructions.
- KEEP these instructions.
- HEED all warnings.
- Follow all instructions.
- Do not use this apparatus near water.
- Clean only with a dry cloth.
- Do not block any ventilation openings. Install in accordance with the manufacturer's instructions.
- Do not install near any heat sources such as radiators, heat registers, stoves or other apparatus (including amplifiers) that produce heat.
- Do not defeat the safety purpose of the polarised or grounding-type plug. A polarised plug has two blades with one wider than the other. A grounding type plug has two blades and a third grounding prong. The wide blade or the third prong are provided for your safety. If the provided plug does not fit into your outlet, consult an electrician for replacement of the obsolete outlet.
- Protect the power cord from being walked on or pinched particularly at plugs, convenience receptacles, and the point where they exit from the apparatus.
- Only use attachments/accessories specified by the manufacturer.
- Use only with the cart, stand, tripod, bracket or table specified by the manufacturer or sold with the apparatus. When a cart is used, use caution when moving the cart/apparatus combination to avoid injury from tip-over.
- Unplug this apparatus during lightning storms or when unused for long periods of time.
- Refer all servicing to qualified service personnel. Servicing is required when the apparatus has been damaged in any way, such as power-supply cord or plug is damaged, liquid has been spilled or objects have fallen into the apparatus, the apparatus has been exposed to rain or moisture, does not operate normally, or has been dropped.
- The equipment must be set up so that the mains switch, mains plug and all connection on the rear of the device are easily accessible.
- The equipment must be connected to a mains socket that has an earth contact.
- Never expose the equipment to rain or a high level of humidity. For this reason do not install it in the immediate vicinity of swimming pools, showers, damp basement rooms or other areas with unusually high atmospheric humidity.
- Do not use the device/s outside. To reduce the risk of fire or electric shock, do not expose this/these device/s to rain or moisture.
- Never place objects containing liquid (e.g. vases or drinking glasses) on the equipment. Liquids in the equipment could cause a short circuit.
- Lay all connection cables so that they do not present a trip hazard.
- Check whether the connection figures comply with the existing mains supply. Serious damage could occur due to connecting the system to the wrong power supply. An incorrect mains voltage could damage the equipment or cause an electric shock.
- This equipment needs adequate ventilation. Do not cover ventilation grilles. If the heat it generates cannot be dissipated, the equipment could be damaged or flammable materials in its immediate vicinity could be ignited. Take care to ensure that the air can circulate freely through the ventilation grilles and keep flammable materials away.
- Never place naked flames near the equipment.
- If the equipment causes a blown fuse or a short circuit, disconnect it from the mains and have it checked and repaired.
- Do not open the equipment without authorisation. You could receive an electric shock. Leave all service work to authorised expert personnel.
- Do not hold the mains cable with wet hands. There must be no water or dust on the contact pins. In both cases you could receive an electric shock.
- The mains cable must be firmly connected. If it is loose there is a fire hazard.
- Always pull out the mains cable from the mains and/or from the equipment by the plug - never by the cable. The cable could be damaged and cause an electric shock or fire.
- If the power cable is connected, avoid contact of the unit with other metallic objects.
- Do not insert objects into the ventilation grilles or other openings. You could damage the equipment and/or injure yourself.
- Do not use the equipment if the mains plug is damaged.
- When installing the device into a 19" rack, make sure that the mains switch, mains plug and all connection on the rear of the device are easily accessible.

Microphone Units

- Conference microphone stations with metal casings are heavy, so always position them on a secure surface.
- If the microphone stations have a gooseneck microphone take care that you do not injure yourself on this e.g. poke it into your eye
- **To align the gooseneck microphone on the microphone station and to avoid twisting it too far and causing premature wear, always grip the microphone by the bottom flexible section never by the microphone head or by the rigid tube. The gooseneck must be bent no further than an angle of 90 ° maximum.**

2. Set-up

The MCS-D 200 system may only be installed by staff acquainted with the appropriate safety instructions. The MCS-D 200 control unit and the power supply units have been developed for installation on tables or 19"-mounting. Do not cover the ventilating grille. When setting up the system please follow the safety instructions mentioned in chapter 1.

Furthermore, please note

- the ambient temperature of the installation site must not exceed 50 °C.
- there must not be exceeding dust and humidity at the installation site.
- that the unit is not exposed to direct sunlight.
- the connections must be protected against direct access during operation.
- that there must be a strain relief of the cables.
- the installation site must be protected against vibrations.

3. MCS-D 200 Control Unit

The MCS-D 200 control unit is the heart of the system. It controls the delegate, chairman and interpreter microphone stations. The MCS-D 200 control unit has a modular power supply unit to power a maximum of 15 microphone stations (optional 30). If more than 30 microphone stations are to be used, additional power supply units are necessary to meet the power requirement.

3.1 Controls and indicators

Front view

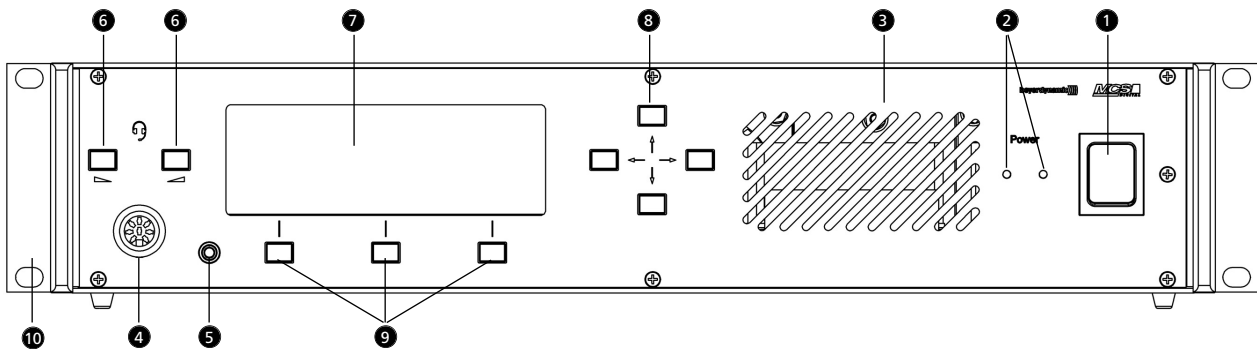

- 1 Power switch
- 2 Power on LEDs (the number of illuminated LEDs indicates the number of power supply units integrated into the control unit)
- 3 Ventilation grille. Do not cover to avoid overheating.
- 4 Socket to connect microphone or headset (8 pin DIN 45326) - inactive
- 5 Headphone socket (3.5 mm) - inactive
- 6 Volume buttons (left, right) - inactive
- 7 Display with 20 characters / 4 lines. Three lines are used for various menu data. The bottom line is used for the description of the Control Keys.
- 8 Navigator buttons (left, right, up, down). Using the navigator bottoms up / down you can scroll through the menu; using the navigator bottoms left / right you can enter data.
- 9 Menu buttons; so-called "hot keys". Depending on the menu, they act as ENTER, EXIT, VOL-, SETUP, VOL +, SET, LIMIT, MODE button. The description is displayed in the lower line.
- 10 Mounting brackets for 19" rack mounting.

Rear view

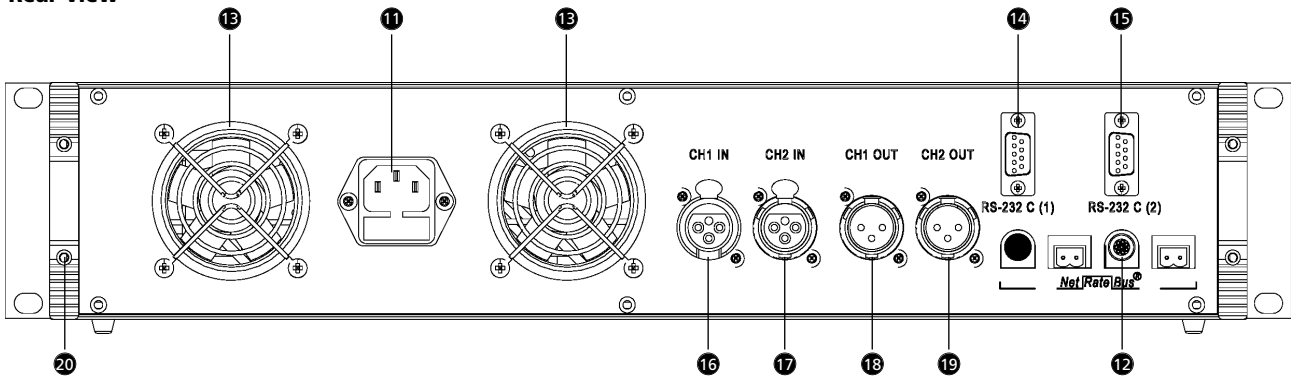

- 11 Mains connection with fuse (6.3 A short-circuit protection)
- 12 NetRateBus conference sockets, MCS-D 200 with 1 Push-Pull socket to connect other power supply units for example.
- 13 Fan outlet (number of fan outlets depends on the number of power supply units integrated into the control unit)
- 14 RS 232 C (1). 9-pin Sub-D connection for PC or media control system.
Note: A PC is connected via a connecting cable (1:1) , **no** null modem cable.
If you use other devices, please observe the pin wiring. The configuration is done via the control unit.
- 15 RS 232 C (2). The connection corresponds to RS 232 C (1).
- 16 CH1 IN: XLR LINE IN input (female), 0 dBm, balanced. The input signal is routed to the loudspeakers of the microphone stations or to any output. Settings are done via the control unit.
- 17 CH2 IN: XLR LINE IN input (female), 0 dBm, balanced. The input signal is routed to the loudspeakers of the microphone units or to any output. Settings are done via the control unit.
- 18 CH1 OUT: XLR LINE OUT output (male), 0 dBm, balanced. Master output of all microphones or any channel; programmable for recording or broadcasting applications.
- 19 CH2 OUT: XLR LINE OUT output (male), 0 dBm, balanced. Master output of all microphones or any channel; programmable for recording or broadcasting applications..
- 20 End profile

Note:

For more inputs and outputs connect a CA 45xx D/A Interface.

3.2 Putting into operation

3.2.1 Audio connection

- Connect the master output 18 or 19 of the MCS-D 200 control unit to the input of a mixing console or mixing amplifier.
- Always route cables running to the unit where they will not be damaged by heavy or sharp objects

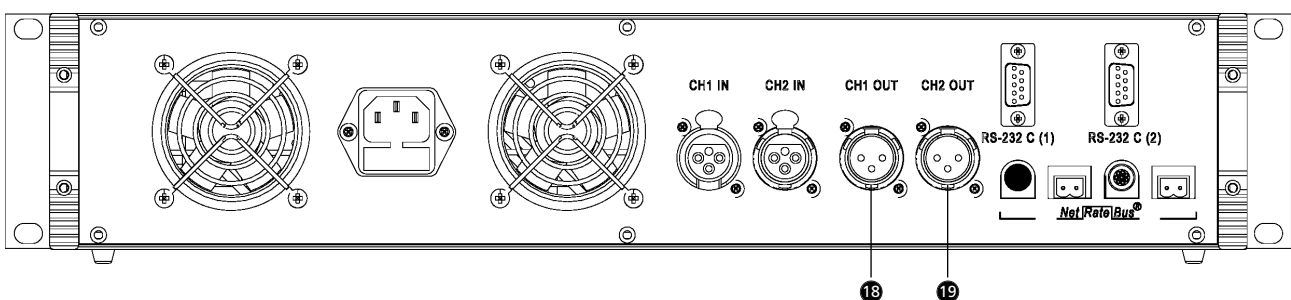

3.2.2 Mains connection

- Verify that the voltage rating of the unit matches that of the AC mains outlet you are to use. If you connect the unit to the wrong voltage, you may seriously damage it.
- Always route cables running to the unit where they will not be damaged by heavy or sharp objects.
- Connect the MCS-D 200 control unit to the mains **1**. The internal power supply unit of the control unit can adjust automatically between 100 V and 240 V at 50 - 60 Hz.

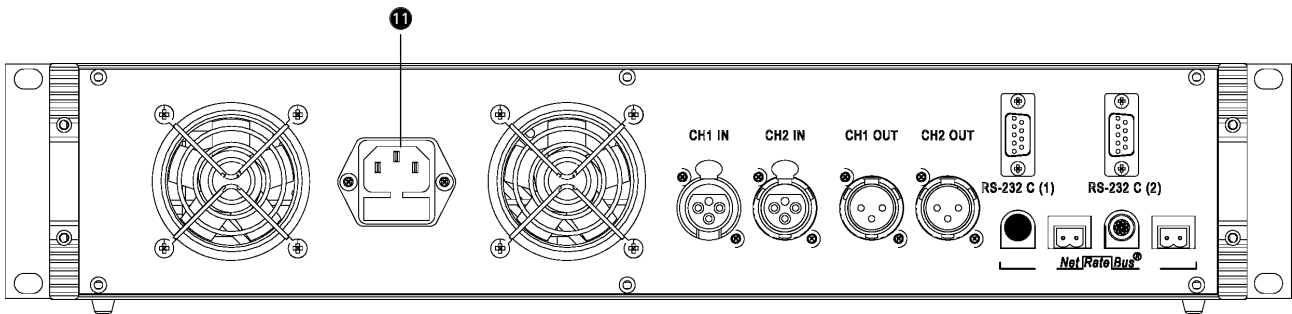

3.2.3 How to switch the control unit on/off

- Before switching the MCS-D 200 control unit on, please check all connections. If there are additional power supply units connected to the control unit, we recommend switching on the devices as described in the following:
 1. Switch on all additional power supply units. The illuminated power switch displays the stand-by mode.
 2. Switch on the MCS-D 200 control unit **1**. The Power LED **2** is illuminated.
- When switching on, the system is booted up. A data communication is not yet possible. As soon as the control unit displays the main menu and the microphone stations the default display (time or ID), the boot process is finished and the data communication can start.
- When switching off, all settings of the MCS-D 200 control unit are stored.



Caution:

- Always turn off the power when making input or output connections. All turned on additional power supply units remain in stand-by mode even if the MCS-D 200 control unit is turned off.
- To boot the system at least 1 device has to be connected to the control unit. Otherwise the display indicates "Initialisation" continuously.

Rear view

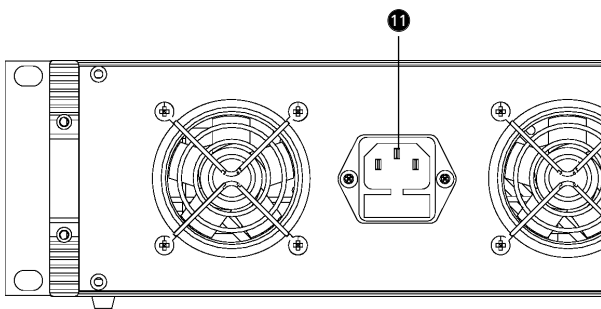

Front view

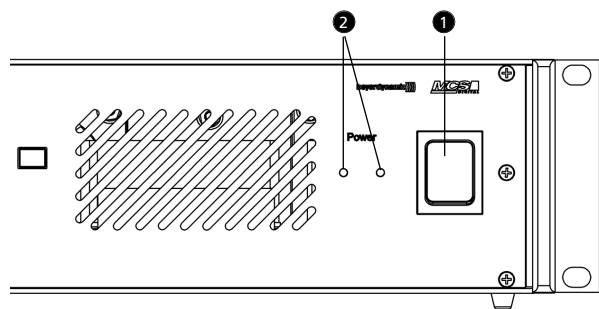

3.3 How to operate the menu of the MCS-D 200 control unit

- You can scroll through the menu by using the navigator buttons ⑧ and menu buttons ⑨.

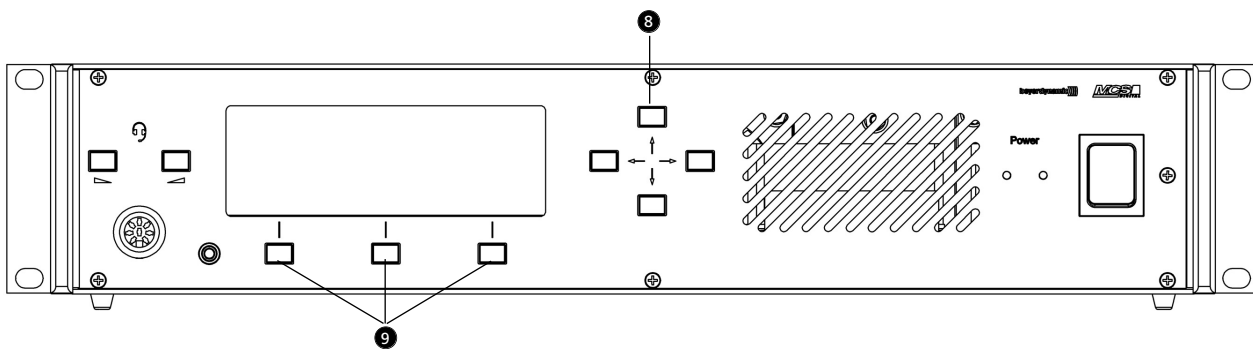

3.3.1 Menu overview of the MCS-D 200 control unit

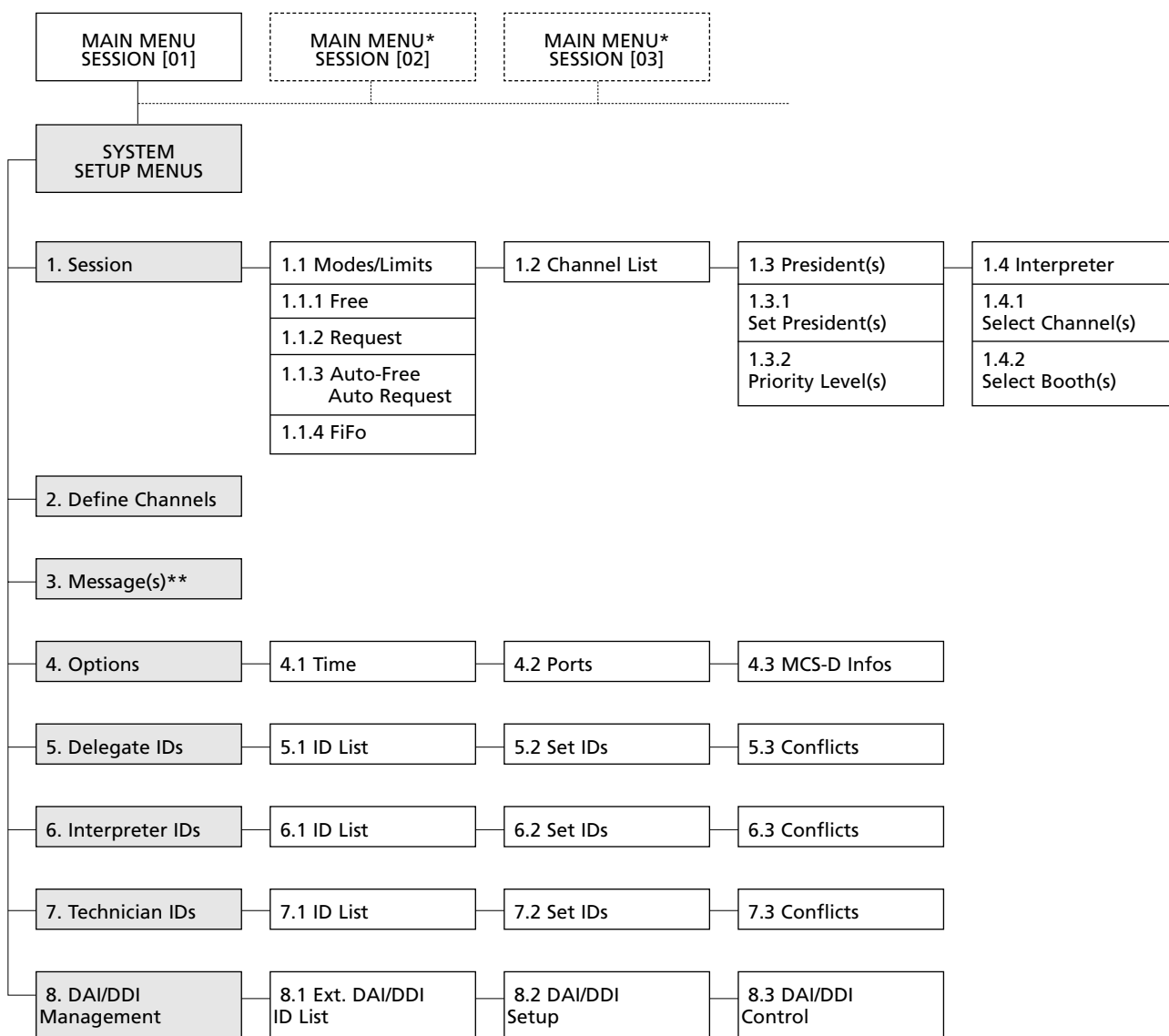

*Only in MultiSession operation via iCNS. It is not possible to adjust settings or only to a certain extent.

**Inactive. This function is only available by using the iCNS software.

3.3.2 Main menu

The main menu displays:
 the session number (here it is session 01),
 the current operating mode (here it is: Free),
 the number of open microphones (here the limit is: 3) and
 the volume of the loudspeakers of the microphone station
 (here it is -1.5 dB)

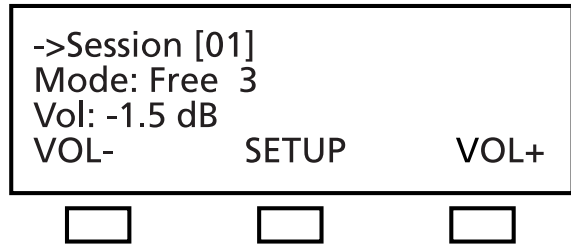

MultiSession: How to change to the next meeting

In the MultiSession operation, i.e. when the same MCS-D 200 control unit is used for several meetings, the right and left hand navigator buttons can be used for selecting the individual meetings.

The main menu indicates the settings such as operating mode, limit and volume of the selected meeting.

The iCNS software is required for the MultiSession operation.

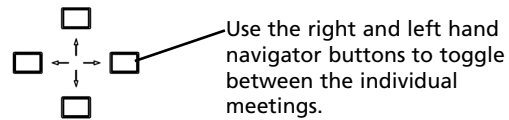
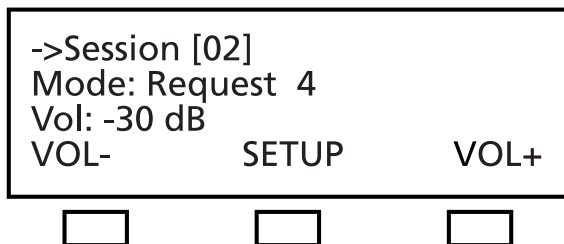

Conference Volume: VOL- and VOL+ buttons

To increase or reduce the volume of the selected meeting (3rd line of the main menu) directly. Press the left hand button (VOL-) to reduce the volume; press the right hand button (VOL+) to increase the volume. The volume is changed in steps of 1.5 dB from -94.5 dB to 0 dB.

SETUP Button

Press the SETUP button to access the SYSTEM SETUP menus and SESSION menus (refer to the illustration of the menu overview of the MCS-D 200 control unit).

Note:

The SYSTEM SETUP menus are for the general system settings = GLOBAL SYSTEM SETTINGS : Define Channels, Message(s), Options, Delegate IDs, Interpreter IDs, Technician IDs and DAI/DDI Management. All devices, channels, messages and options of the whole MCS-D 200 system are defined via these menus.

In the SESSION menus you can prepare settings for individual meetings.

3.3.3 System set-up menus



Warning:

In systems using PC and iCNS software the settings are operated via the iCNS software. The set-up menus of the MCS-D 200 control unit cannot be operated to avoid conflicts.

Press the SETUP buttons to access the SYSTEM menus. The arrow indicates the current line. Scroll through the menus by using the up or down navigator buttons. Press the ENTER button to access the submenus. Change individual values by using the left or right hand navigator buttons.

Note:

The **SYSTEM SETUP menus** are used for the **settings of the system level** = GLOBAL SYSTEM SETTINGS : Define Channels, Message(s), Options, Delegate IDs, Interpreter IDs, Technician IDs and DAI/DDI Management. All devices, channels, messages and options of the whole MCS-D 200 system are defined via these menus.

In the **SESSION** menu you can prepare settings for individual meetings.

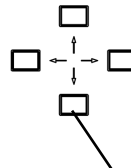

Use the up or down navigator button for scrolling.

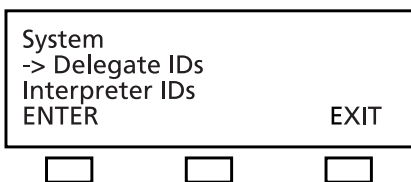
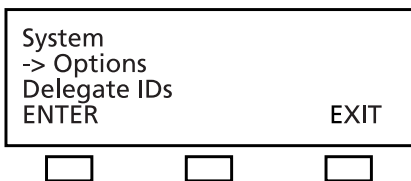
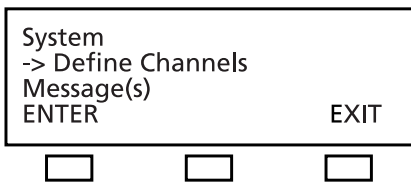

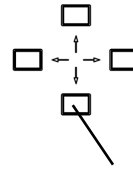
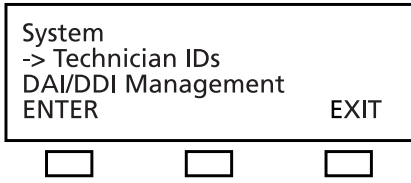
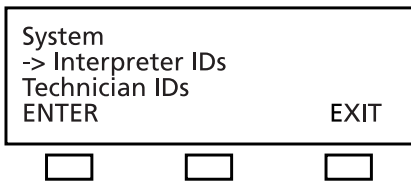

Use the up or down navigator button for scrolling.



Warning:

In systems using PC and iCNS software the settings are operated via the iCNS software. The set-up menus of the MCS-D 200 control unit cannot be operated to avoid conflicts.



NO SESSION:

iCNS is in the offline mode (conference closed), not in the online mode (conference started).

3.3.4 Session menus

In the **SESSION menu** settings for the meeting such as Mode/Limit, Channel List, Presidents, Interpreters are selected for the meeting selected in the main menu.

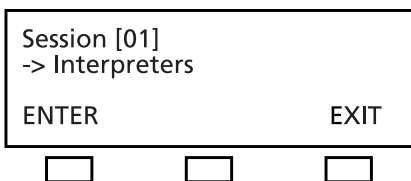
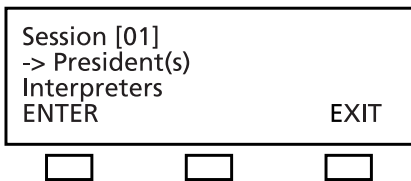
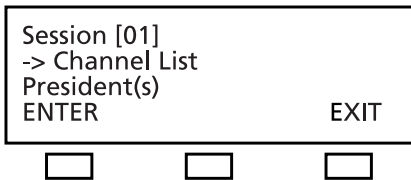
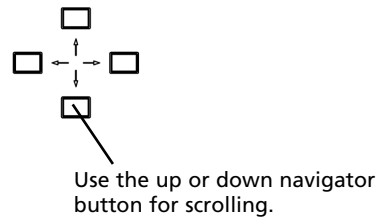
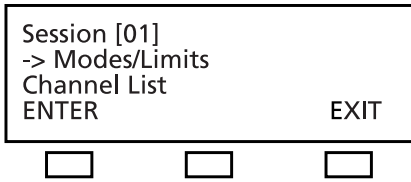
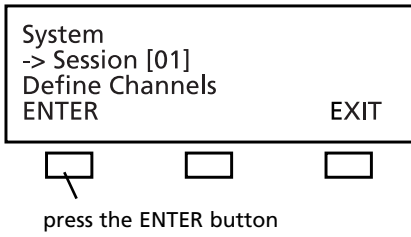

3.3.4.1 Mode / Limit menus

In the MODES/LIMITS menu you can enter the operating mode and number of open microphones (limit) for the selected session (here it is session 01).

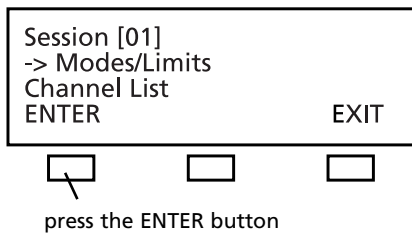

Free Mode

Each delegate can turn on the microphone of the microphone station if the selected number of open microphones (limit) is not exceeded.

Limit - Free

Determine the maximum number of open microphones. The maximum number is 16.

Request Mode

Delegates enter a request-to-speak by pressing the microphone button. The request-to-speak is registered if the number of possible requests to speak (limit) is not exceeded. By pressing the "0" button the chairman can release the registered request-to-speak.

Limit - Request

Determine the maximum number of requests to speak. The maximum number is 16.

If the limit is set to 2 or higher, the microphones of the registered speakers are turned on simultaneously by pressing the "0" button. If only one speaker is to speak, the limit of the Request mode must be set to 1.

Auto Mode

The request-to-speak/turning on of microphones is one after another. Each delegate can turn on his microphone by pressing the microphone button if the selected limit is not exceeded. If the limit is exceeded, the request-to-speak is registered in the MCS-D 200 control unit. The microphone unit is turned on automatically as soon as a current speaker turns off his microphone.

LIMIT - Auto-Free:

Determine the maximum number of open microphones. The maximum number is 16.

LIMIT - Auto-Request:

Determine the maximum number of simultaneous requests to speak. The maximum number is 16.

FIFO Mode (First In - First Out)

The microphones are turned on one after another. Each delegate can turn on the microphone of his microphone station by pressing the microphone button. If the limit is exceeded, the microphone of the delegate speaking the longest is turned off automatically (first in - first out).

LIMIT - FiFo:

Determine the maximum number of open microphones. The maximum number is 16.

Note:

If the rights of a chairman station are assigned to a microphone station via the MCS-D 200 control unit, the chairman can control the meeting actively by using the following function buttons:

CANCEL button to cancel turned on microphones and/or requests to speak.

PRIORITY button to mute turned on microphones.

NEXT button = press the "0" button to select the next request-to-speak.

PREVIOUS button = press the "9" button to select the previous speaker.

MCS-D 200 Control Unit

How to set Modes

To select the mode press the SET button. A star in brackets indicates the selected operating mode.

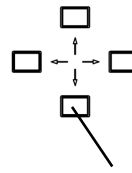
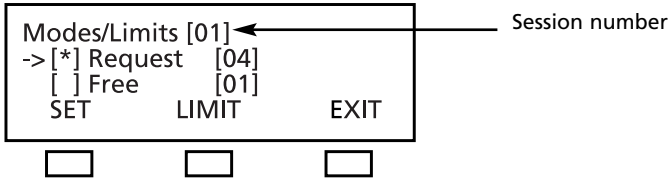

Use the up or down navigator button for scrolling.

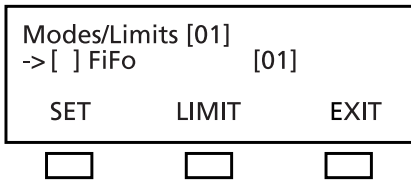
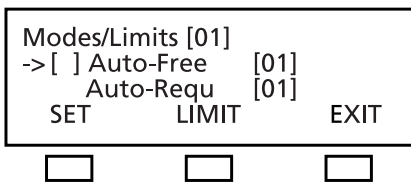
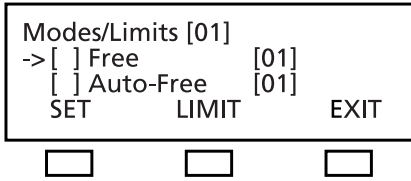

How to set the Limits

Press the LIMIT button to set the limit. Select the limit by using the right or left hand navigator buttons. Press the MODE button to return to the MODE menu.

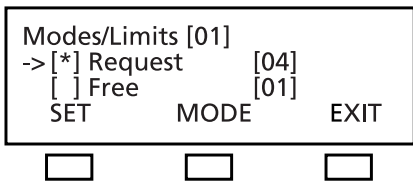

Change LIMIT:
Press the left or right hand
navigator button.

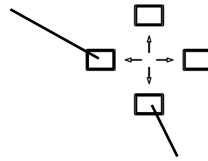

Use the up or down navigator
button for scrolling.

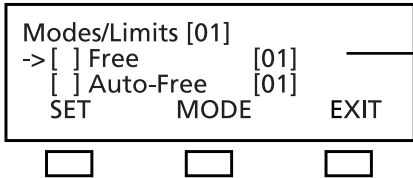

Cursor is flashing

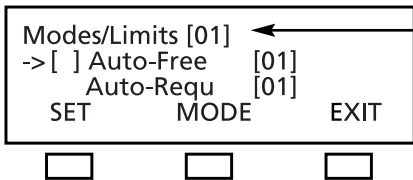

Session number

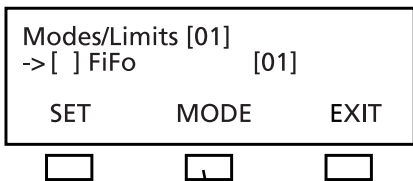

Press MODE button to return
to the MODE menu.

3.3.4.2 Channel List

In the menu **CHANNEL LIST** you can prepare and edit a list of all required channels. All channels have to be defined in the menu DEFINE CHANNELS (refer also to the chapter 3.3.5 "Define Channels"), because the channel list is basing on the predefined channels.

Whenever the delegate presses the language/channel selector button of his microphone station, the list is displayed.

The channel list includes the OR channel, language channels or other channels such as music channels.

For the interpreter stations you can select channels from this channel list.

In the menu CHANNEL LIST you can...

1. ...scroll through the channel list with all predefined channels of the whole system.
2. ...prepare a channel list for the selected session:
 - select required channels (set/reset)
 - name and number channels

Note: Channels are added by pressing the SET button. A channel description consists of a maximum of 3 characters. The language channels are encoded according to the international MARC language code (refer to chapter 11. "List of Language Codes").

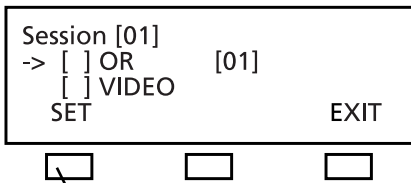
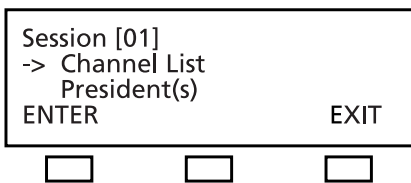

Press the SET button to add OR channel to the channel list

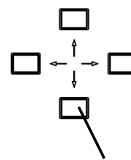

Use the up or down navigator button for scrolling.

Use the up or down navigator buttons to scroll through the list of all predefined channels in the menu DEFINE CHANNEL. Press the SET button to add a selected channel to the channel list. The star * identifies the selected channel.

Adapt the number and description for the MCS-D 2073 display

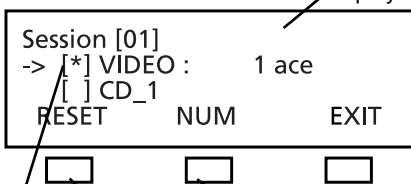

The star * identifies the selected channel

Press the NUM button to change the number

Press the RESET button to remove selected channel from the channel list

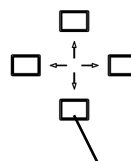

Use the up or down navigator button to change the channel number

When the NUM button is pressed the cursor goes to the channel number. Use the up or down navigator button to change the number.

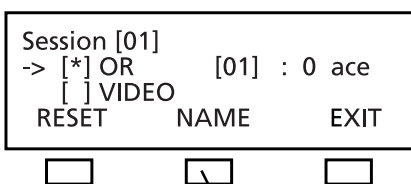

Press the NAME button to change the channel description

When the NAME button is pressed, the cursor goes to the channel description (refer to illustration). The description can be changed as described in the following:

Note:

1. By pressing the right or left hand navigator buttons you can assign a code of the international language list to a language channel (refer to chapter 11. "List of Language Codes").
2. For other channels you can create another description with a maximum of three characters from a predetermined list. Move the cursor to the position with the left or right hand navigator buttons and scroll through the list of characters with the up and down navigator buttons.

A code of the international language list is assigned to a language channel:

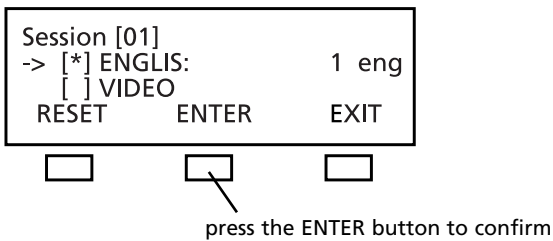
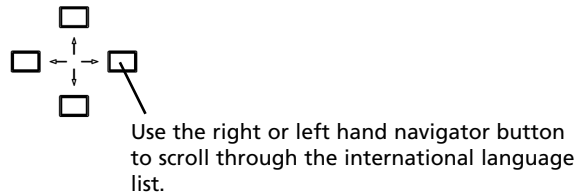
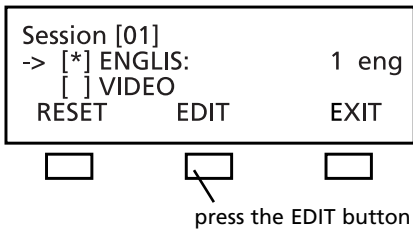

For any other channel you can select a maximum of 3 characters from a list:

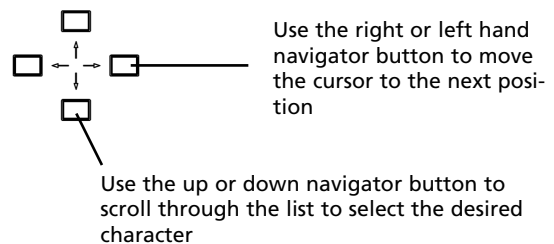
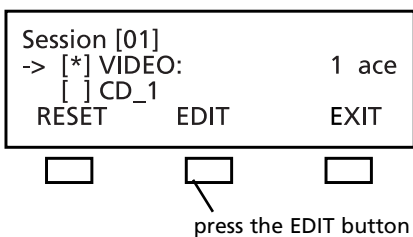

When the EDIT button is pressed, the cursor goes to the first choice. Use the up or down navigator button to select a character from the list. Then use the right or left hand navigator button to move the cursor to the next choice etc.

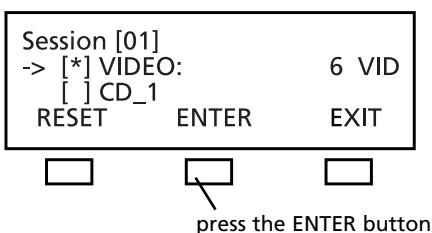

3.3.4.3 President(s)

In the PRESIDENTS menu you can assign the functions of a chairman station such as CANCEL, PRIORITY, PREVIOUS or NEXT to any microphone station in the selected session (here: session 01).

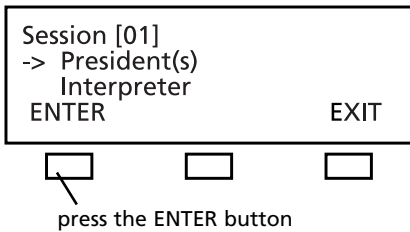

The following items refer to chairman stations:

- Each chairman can turn on his microphone at any time, regardless of the selected limit.
- Any number of microphone stations can be programmed as chairman stations.
- Chairman stations can be assigned to different levels (0-99), each level with any number of chairman stations.
- By using the PRIORITY button the chairmen of a higher level can mute all microphones of the delegate stations and the chairman stations of a lower level.
- Chairman stations of the same level, however, cannot be muted by using the PRIORITY button.
- Depending on the operating mode, all chairmen can turn off the microphones of all delegate stations by using the CANCEL button.
- By using the NEXT button chairman can release requests to speak and by using the PREVIOUS button they can ask previous speakers to speak once again.

How to program Chairman Stations (SET/RESET)

The arrow indicates the active line.

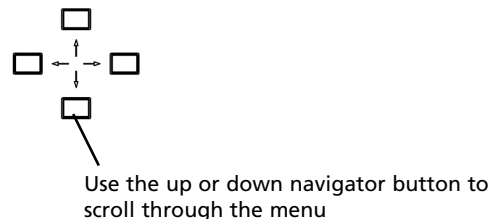
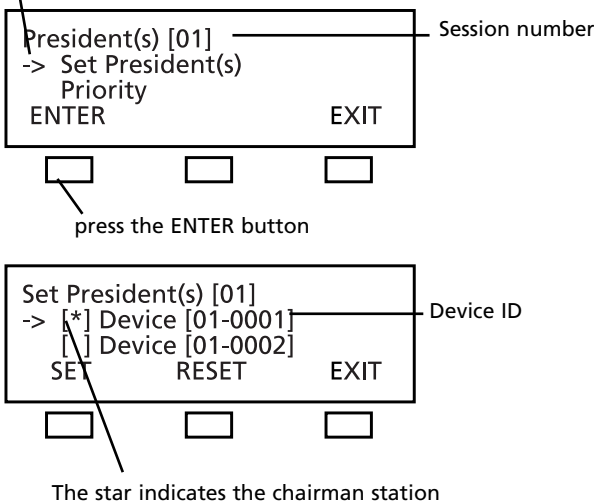

Each delegate station features a device ID number (refer to chapter 3.3.7 "Delegate IDs" and 3.3.7.2 "Set IDs"). Use the up or down navigator button to scroll to the microphone station with the appropriate ID which is to be programmed as a chairman station. The arrow indicates the selected microphone station. Then press the SET button to assign the functions of a chairman station to this microphone station. In this way you can program any number of microphone stations as chairman stations. The star in brackets identifies all chairman stations.

If you would like to cancel the chairman functions of a microphone station, use the up or down navigator button to scroll to the microphone station with the appropriate ID. The arrow indicates the selected microphone station. Press the RESET button to cancel the chairman functions of the selected microphone station. The star is removed.

Press the EXIT button when all chairman stations are determined. In the PRIORITY LEVEL(S) menu you can then assign the chairman stations to different levels.

PRIORITY LEVEL(S) for Chairman Stations

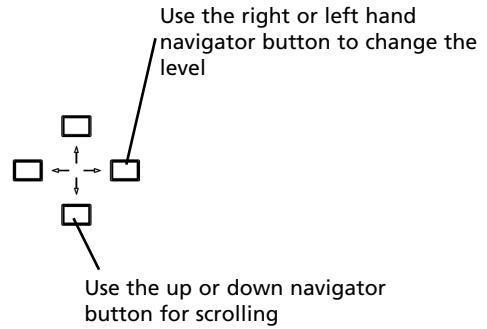
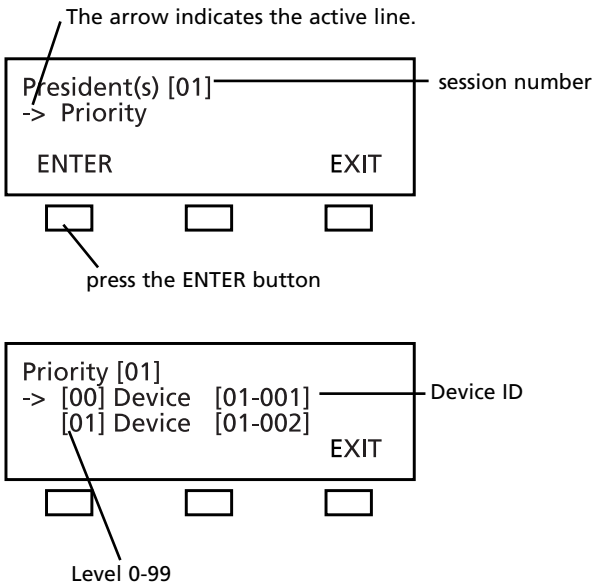

All microphone stations which have been programmed as chairman stations in the SET PRESIDENT(s) menu are listed here. You can assign a level to each chairman station. "0" is the highest level, "99" the lowest. For each level any number of microphone stations is possible. The standard setting is level "0". If you want to select a different level for a microphone station, use the up or down navigator button to choose the microphone station. Then use the right or left hand navigator button to change the level.

In the example above the chairman station 0001 is on a higher level than the chairman station 0002. If the chairman holds down the PRIORITY button of the microphone station 0001, the microphone of the chairman station 0002 is muted along with the delegate stations.

3.3.4.4 Interpreter

In the INTERPRETER menu you can prepare a list of all required interpreter's channels from the list of session channels for the selected session (here: session 01) (refer also to chapter 3.3.4.2 "Channel List"). The list includes only channels required for interpreters, i.e. all channels for the preselection of the relay and output channels.

When the relay channel or PRE SELECT output channel button of the MCS-D 202 interpreter station is pressed, the list of the interpreter channels is displayed.

Then select from the booth list all booths required for the selected session (refer to chapter 3.3.7.1 "ID List").



How to prepare the list of interpreter's channels for the session

In the **INTERPRETER** menu you can prepare a list of all required interpreter's channels from the list of the session channels (refer to chapter 3.3.4.2 "Channel List") for the selected session (here: session 01).

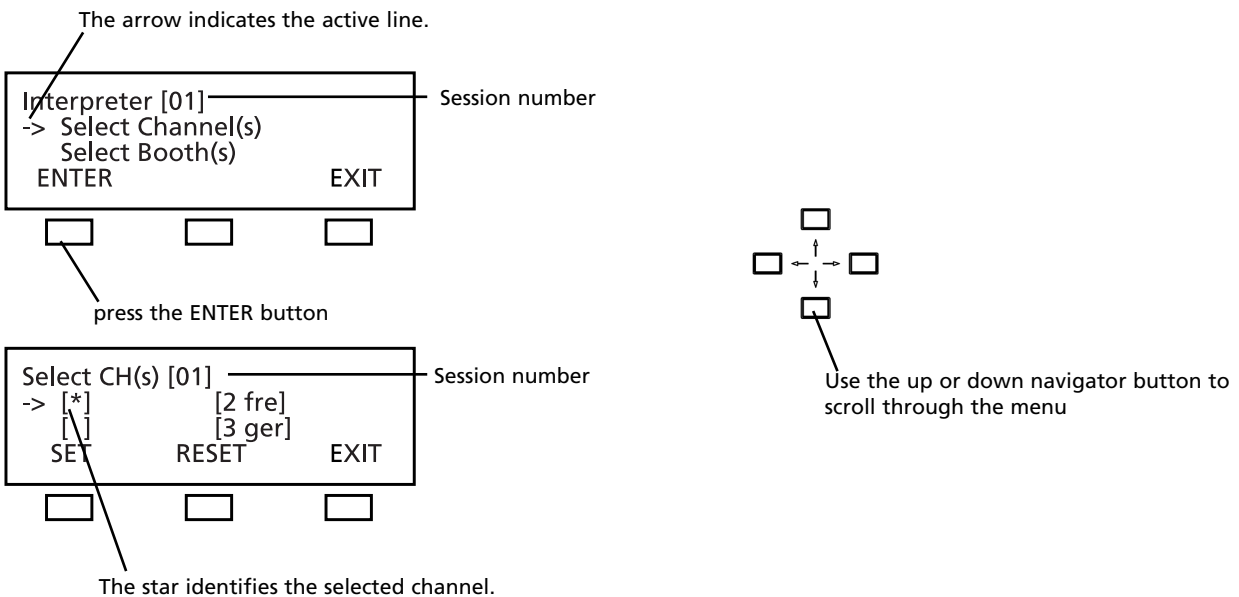

Use the up or down navigator button to select the channel which is to be added to the interpreter's channel list. Then press the **SET** button. The star identifies the selected channel. Repeat these steps to add more channels to the list.

Press the **RESET** button if you want to remove a selected channel from the interpreter's channel list. The star is removed. Repeat these steps if you want to remove more channels from the interpreter's channel list.

Press the **EXIT** button to leave this menu.

How to select the required interpreter's booth(s) for the session

Select all booths required for the selected session from the booth list (refer to chapter 3.3.7.1 "ID List").

The arrow indicates the active line.

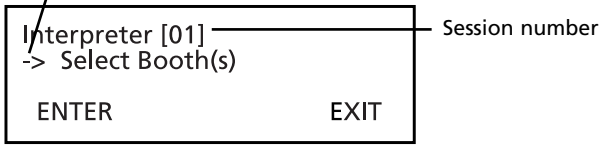

press the ENTER button

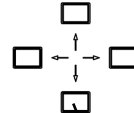

Use the up or down navigator button to scroll through the menu

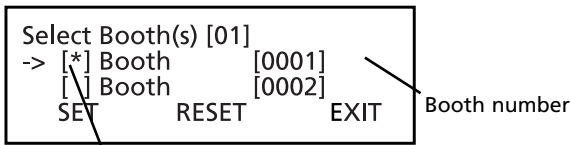

The star identifies the selected booth.

Use the up or down navigator button to select the booth required for the session (here: 01). Then press the **SET** button. The star identifies the selected booth. Repeat these steps to select more booths.

To remove a selected booth from the session press the **RESET** button. The star is removed. Repeat these steps if you want to remove more booths from the session.

Press the EXIT button to leave the menu.

3.3.5 Define Channels

In the **DEFINE CHANNELS** menu all channels required for the whole system are defined, added or removed. By using these defined channels the lists of the session channels are prepared for the individual sessions (refer to chapter 3.3.4.2 "Channel List").

Note:

- The OR channel does always exist in the list and may neither be edited nor deleted.
- A channel currently in use may neither be edited nor deleted.

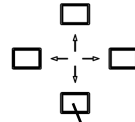

Use the up or down navigator button to scroll through the menu

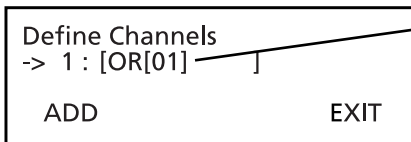

OR channel of session 1

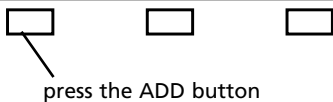

Press the ADD button to add a new channel.

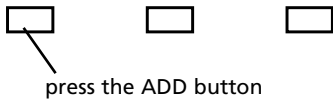
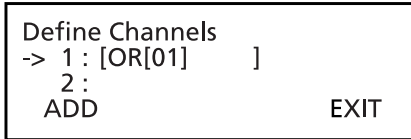

Note:

1. For language channels you may select a name from an international language code list (refer to chapter 11. "List of Language Codes") by using the right or left hand navigator button.
2. For any other channel you may edit the code (up to 3 characters). By using the right or left hand navigator button you can place the cursor at the desired position and by using the up or down navigator button you can scroll through a list of characters.
3. A defined channel may comprise a maximum of 6 characters.

For a language channel select the name from a list of international language codes (refer to chapter 11. "List of Language Codes"):



press the EDIT button to open the channel list

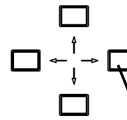

Use the right or left hand navigator button to scroll through the list of language codes



press the ENTER button to confirm



press the ADD button to define a new channel

press the DEL button to delete a channel

For any other channel which does not receive an international language code, you can select individual characters from a list of characters:



press the EDIT button

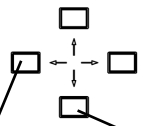

Use the right or left hand navigator button to go with the cursor to the next character position

Use the up or down navigator button to scroll through the list to find the desired character

When the EDIT button is pressed the cursor goes to the first position. Use the up or down navigator button to select a character from the list. Use the right or left hand cursor button to go to the next position etc.

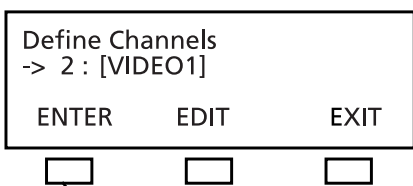

press the ENTER button to confirm

3.3.6 Options

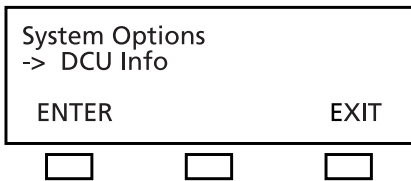
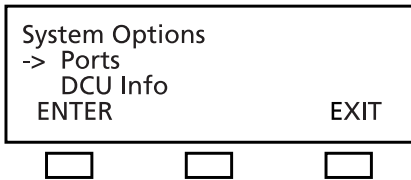
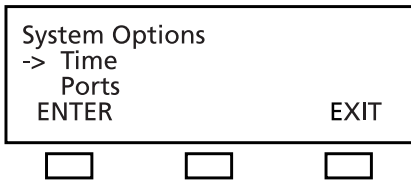
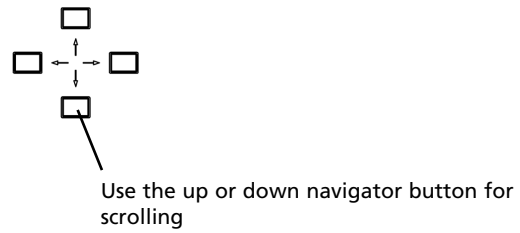
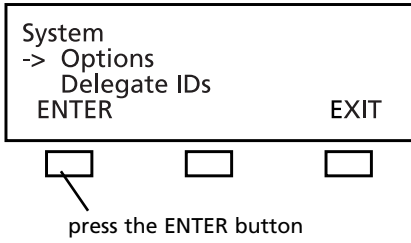

3.3.6.1 Time

In the TIME menu the system time for the MCS-D 200 control unit, MCS-D 202 and MCS-D 2073 microphone stations can be set manually (refer to chapter 7.1.6 "Menu settings") in the format HOURS – MINUTES – SECONDS. When the iCNS software is started, the system time is refreshed automatically.

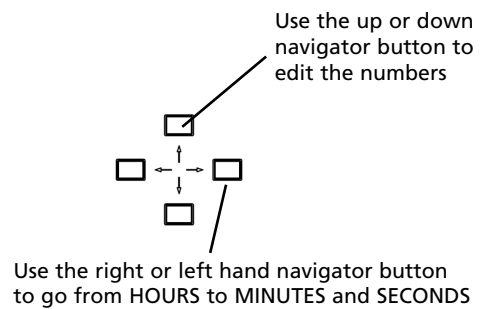
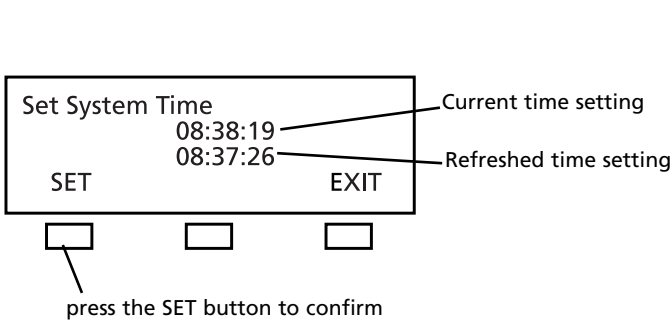

The current system time is displayed in the CURRENT TIME line as:
HOURS : MINUTES : SECONDS.

You can change the time in the line below. Use the **right or left hand navigator button** to go from HOURS to MINUTES and SECONDS. Use the **up or down navigator button** to set the new values and press the SET button to confirm.

3.3.6.2 Ports

The RS-232C(1) Port 14 and RS232C(2) Port 15 are configured to connect to a PC with the iCNS software or to a media control system.

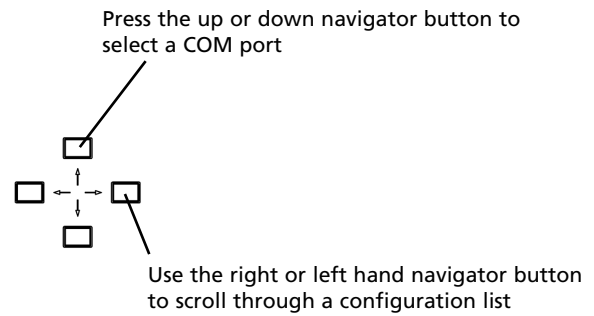
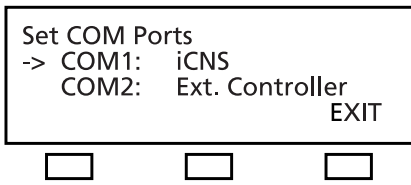

Use the up or down navigator button to go to COM 1 or COM 2. Use the right or left hand navigator button to scroll through the configuration list.

3.3.6.3 MCS-D Info

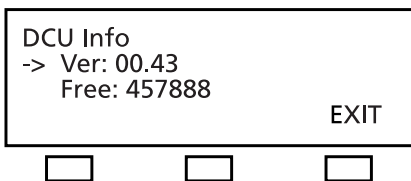
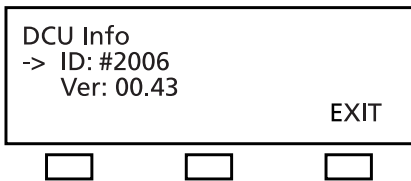

3.3.7 Delegate IDs

For identifying a device identification number (ID) should be assigned to each delegate station. Basically, the system can be operated without the organisation of ID numbers. But for special functions such as functions of a chairman station, phoning and some data bank management functions the organisation of the IDs of the microphone stations is absolutely necessary for a smooth meeting. In order to avoid conflicts each ID number can be assigned only once. For the telephone function, e.g. the ID numbers are used as device telephone numbers which will appear in a telephone list in the menu. Addressing is defined as assigning an individual number to a certain device - for example – delegate station no. 1 shall be ID-no. 0001, delegate station no. 2 shall be ID-no. 0002, and so on.

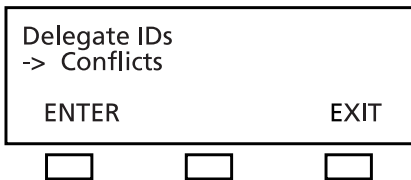
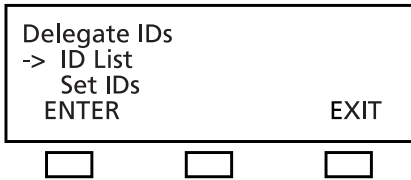
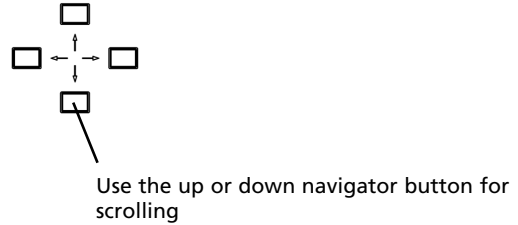
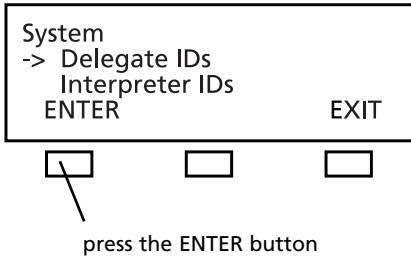

3.3.7.1 ID List

You may assign an ID to individual devices. Also refer to chapter 3.3.7.2 "Set IDs" to find out how you can set IDs for all microphone stations.

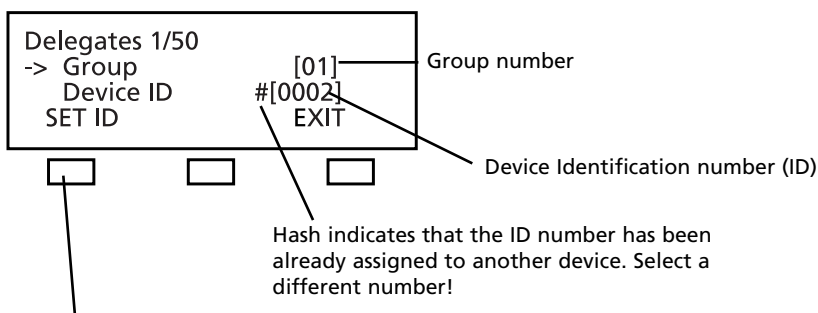
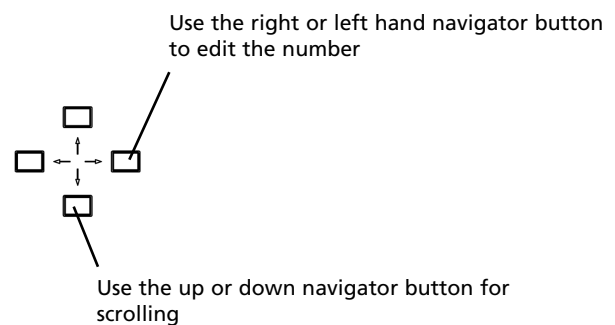
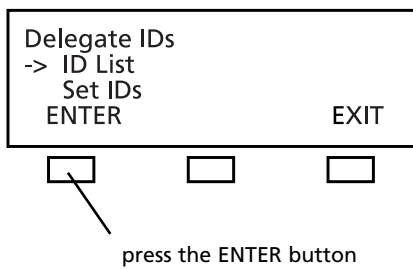

Press the SET ID button if the device has the desired number.

Scroll to the "**GROUP**" line. Use the **right or left hand navigator button** if you want to change the group number.

Note:

In the **stand-alone** mode (if you do not use the iCNS software) all microphone stations are assigned to the same session, no matter to which group they belong. An assignment to groups is only possible in the MultiSession mode when using the iCNS software.

Now use the down navigator button to go to the "DEVICE ID" line. The LED ring of the selected microphone station will illuminate (here: microphone station 1 out of 50).

Use the right or left hand navigator button to assign a DEVICE ID number (1 to 2000). If you select an ID number which has been already assigned, hash will be displayed. In this case select a different number to avoid conflicts. Microphone stations of different groups can have the same ID; for example the microphone stations of group 1 have the IDs 0001 to 0200 and the microphone stations of group 2 have the IDs 0001 to 0150.

Select the next microphone station, and so on.

3.3.7.2 Set IDs

This function allows you to set identification numbers for all microphone stations by pressing the MIC button of all microphone stations one after the other.

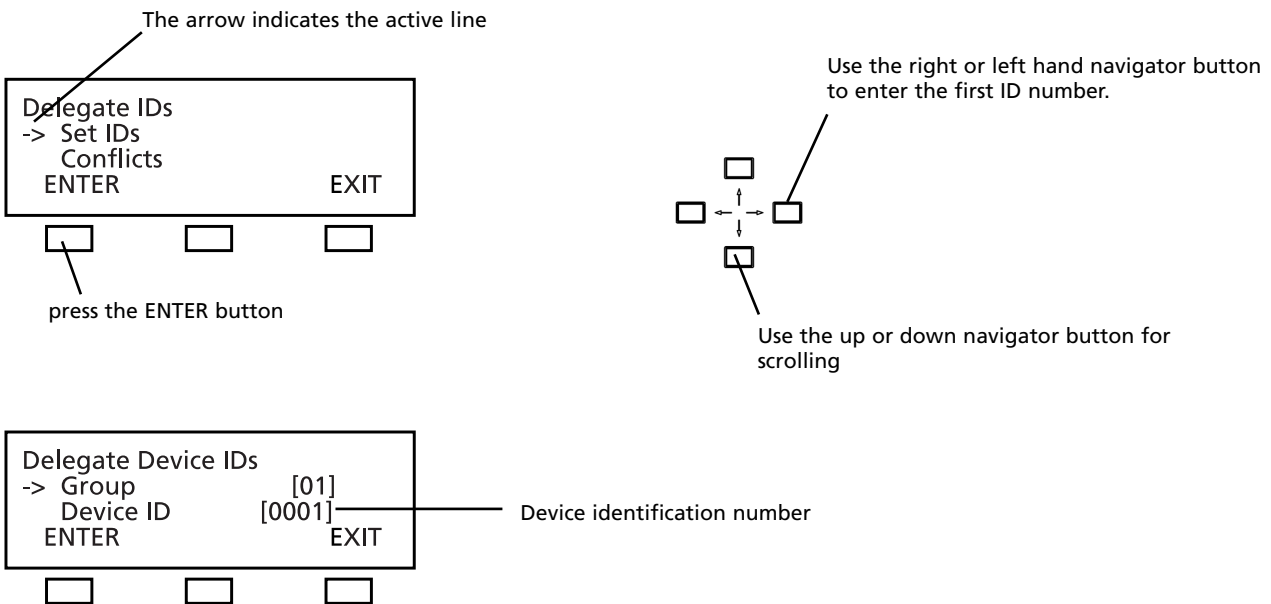

Go to the "Group" line. Use the right or left hand navigator button to change the session number, if necessary.

Note:

In the stand-alone mode (if you do not use the iCNS software) all microphone stations are assigned to the same session, no matter to which group they belong. Microphone stations can be assigned to different groups only when using the iCNS software in the MultiSession mode.

Use the **down navigator button** to go to the "DEVICE ID" line. Use the right or left hand navigator button to enter the first ID number.

Then press the microphone button of the **first** microphone station to assign the first ID number to this microphone station. The LED ring will illuminate and the display of the microphone station will show the ID number. Press the microphone button of the **second** microphone station. The LED ring will illuminate and the next ID number will be shown on the display of the microphone station. Continue like this to assign ID numbers to all microphone stations one after another. Refer to the previous chapter to find out how to assign individual ID numbers.

3.3.7.3 Conflicts

For identifying a device identification number (ID) should be assigned to each delegate station. To avoid conflicts each ID number may be assigned only once.

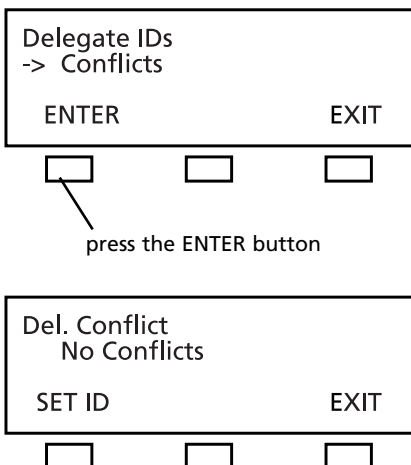

3.3.8 Interpreter IDs

For identifying a device identification number (ID) should be assigned to each interpreter station. Basically, the system can be operated without the organisation of ID numbers. But for special iCNS software and service monitoring functions the organisation of the IDs of the interpreter stations is absolutely necessary for a smooth meeting. The ID number for an interpreter station consists of the booth ID and device ID. In order to avoid conflicts each ID number can be assigned only once. For different booths you may assign the same device IDs.

For example:

Booth 1: MCS-D 202 (1) = 01-0001, MCS-D 202 (2) = 01-0002

Booth 2: MCS-D 202 (1) = 02-0001, MCS-D 202 (2) = 02-0002

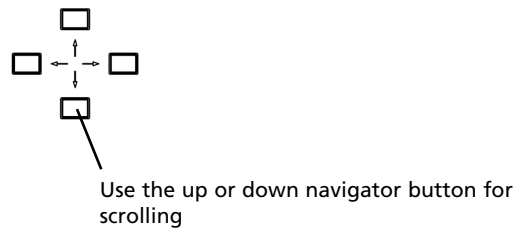
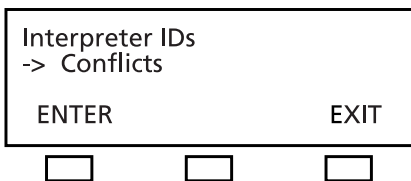
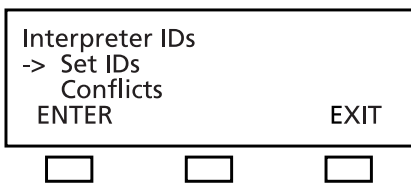
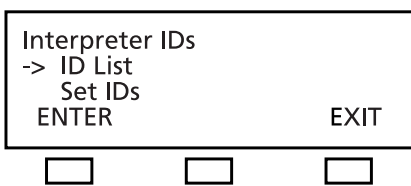
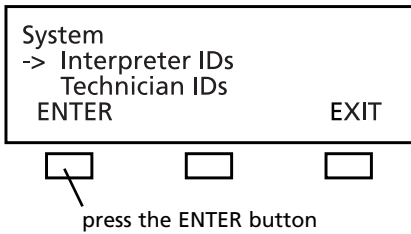

3.3.8.1 Interpreter ID List

You may select an individual device and assign a booth in combination with a device identification number (DEVICE ID). Also refer to chapter 3.3.8.2 "Set Interpreter IDs" to find out how you can assign identification numbers to all interpreter stations.

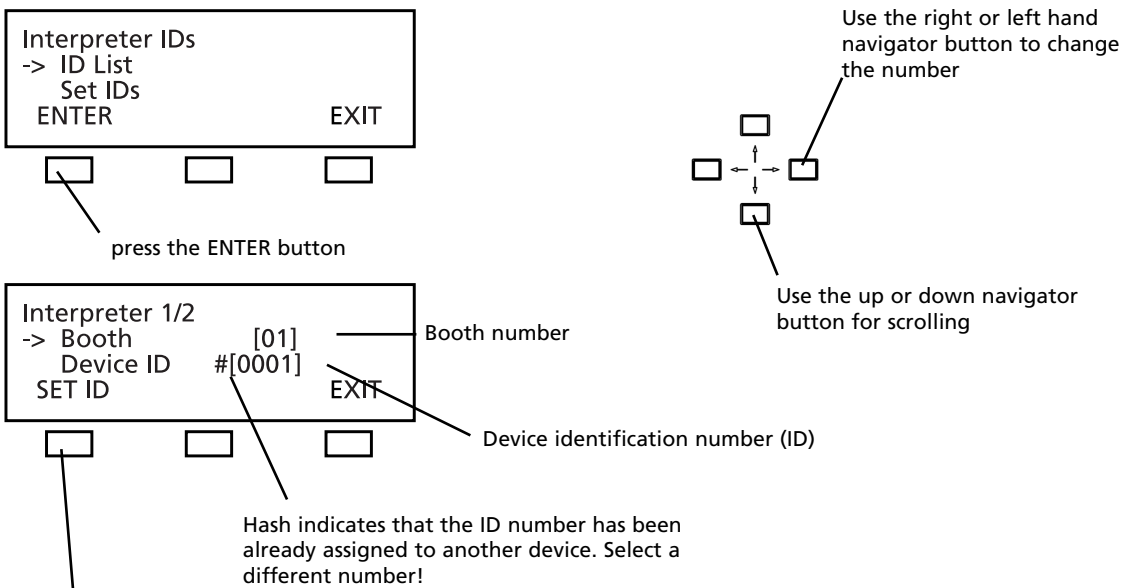

Press the SET ID button if the device has the desired number.

Go to the "Booth" line and enter the booth number. Then use the down navigator button to go to the "Device ID" line. The LED ring of the selected microphone station will illuminate (here: microphone station 1 out of 2). Use the right or left hand navigator button to enter a device ID number (1 to 2000). If you select an ID number which has been already assigned, hash will be displayed. In this case select a different number to avoid conflicts. The same ID number can be assigned to interpreter stations in different booths.

Example:

Booth 0001: Interpreter station no. 0001, 0002;
 Booth 0002: Interpreter station no. 0001, 0002.
 Select the next interpreter station, and so on.

3.3.8.2 Set Interpreter IDs

With this function you can assign device IDs to all microphone stations in one booth by pressing the MIC button of the microphone stations one after another.

Note: You can directly assign IDs to the MCS-D 202 interpreter station. Refer also to chapter 7.2.7 "How to assign an ID to the interpreter station".

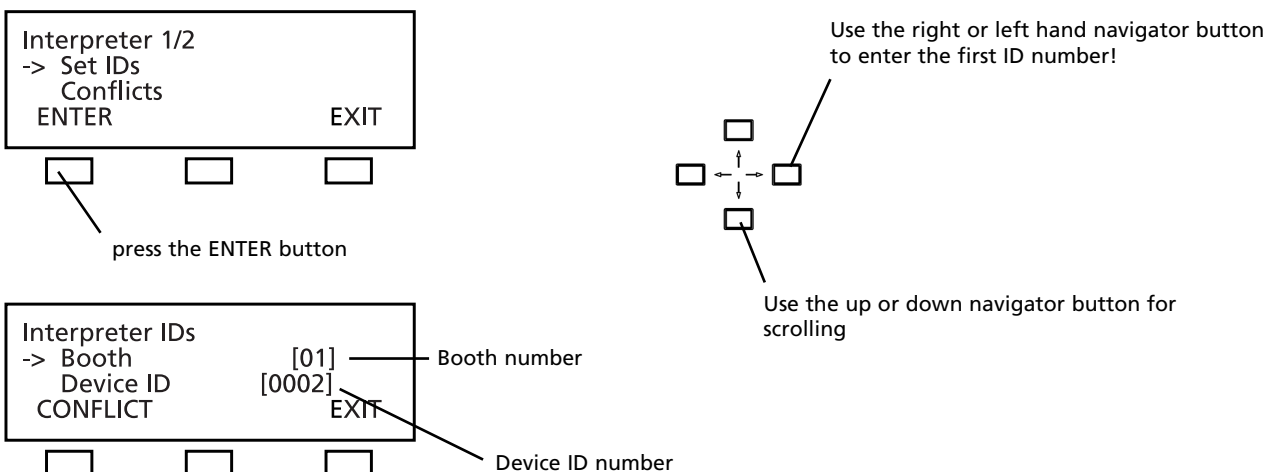

Go to the "Booth" line and enter the booth number. Then use the down navigator button to go to the "Device ID" line. Use the right or left hand navigator button to enter the first interpreter station ID number. Then press the MIC button of the first interpreter station to assign the first ID number to this microphone station. The LED ring will illuminate and the ID number will be shown on the display of the microphone station.

Then press the microphone button of the second interpreter station. Then press the microphone button of the second interpreter station. The LED ring will illuminate and the next ID number is shown on the display of the interpreter station and on the MCS-D 200 control unit. Proceed with the next interpreter station as described above and so on.

Assign the ID numbers to all interpreter stations in the same booth.

To assign the ID numbers to the second booth go to the "Booth" line and enter the second booth number. Assign the ID numbers to the interpreter stations as described above.

You may assign the same device ID numbers if the interpreter stations are in different booths.

For example:

Booth 0001: Interpreter station no. 0001, 0002;

Booth 0002: Interpreter station no. 0001, 0002.

Refer to the previous chapter to find out how individual ID numbers are assigned.

3.3.8.3 Conflicts

A device identification number should be assigned to each interpreter station to identify them easily. Please make sure that each ID number is only assigned once within the same session to avoid conflicts.

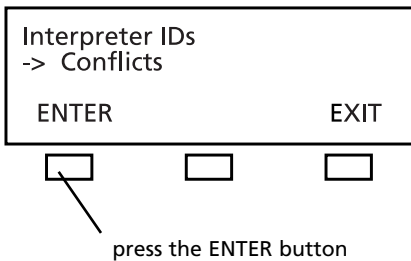

3.3.9 Technician IDs

To enter an ID for the MCS-D 2074 service microphone station proceed as described in chapter 3.3.7 "Delegate IDs".

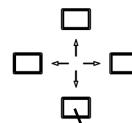
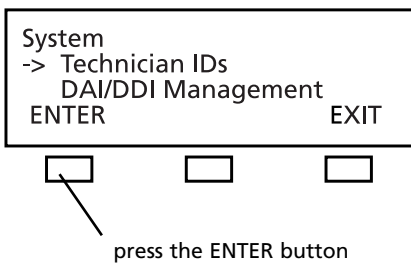

Use the up or down navigator button for scrolling

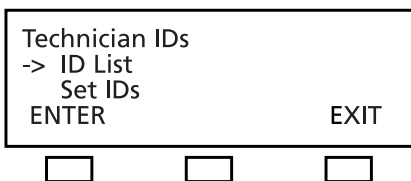

3.3.10 DAI/DDI Management

The **MCS-D 200 control unit** features an **integrated D/A interface (=INTERNAL DAI)** with the connexions CH1 IN, CH2 IN, CH1 OUT and CH2 OUT.

To provide more analogue inputs and output, additional **Digital / Analog Interfaces (DAI)** are connected via the conference bus for the connection of external audio devices such as wireless microphones or tape recorders providing the sound of a video film in different languages. The 19" housing of a Digital / Analog Interface (DAI) may be equipped with a maximum of 3 interface units (=EXTERNAL DAI), each with 2 analogue audio inputs and output. The DAI is powered via the system and is recognised when the system is started.

In the **DAI/DDI MANAGEMENT** menu you can set the following:

DAI Management:

- Set an identification number (logical address) for each external DAI.
- Assign channels to the LINE INPUTS and LINE OUTPUTS of the internal and external DAIs.

DAIs are operated as described in the following:

- Set the level of all LINE IN and LINE OUT channels of the internal and external DAIs.
- Switch on/off all LINE IN and LINE OUT channels of the internal and external DAIs.

Warning:

Unused DAI inputs must be **OFF**, to avoid noise!

DDI Management:

- Assign channels to digital outputs

DDIs are operated as described in the following:

- Switch on/off all outputs.

The DAI/DDI Management menus include the Ext. DEVICE LIST, DAI SETUP and DAI CONTROL menus.

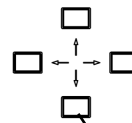
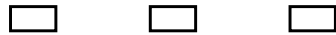
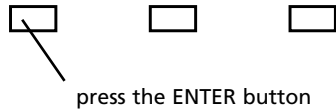
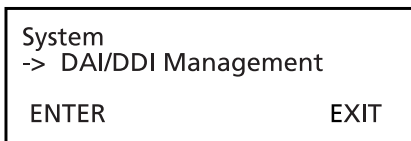

Use the up or down navigator button for scrolling

3.3.10.1 Ext. DAI ID List

In the Ext. DAI ID LIST menu you may enter a device identification number (logical address) for every interface unit (=EXTERNAL DAI), that is an interface unit with 2 CH IN and 2 CH OUT each. Each interface unit is regarded as an independent device, even if there is a maximum of 3 interface units in the same 19" housing of one DAI. The interface units are recognised when the system is started.

The identification number of the **internal D/A interface** of the MCS-D 200 control unit (=INTERNAL DAI) is fixed [=00] and cannot be changed.

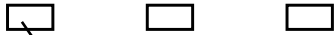

press the ENTER button

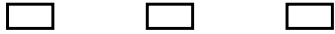
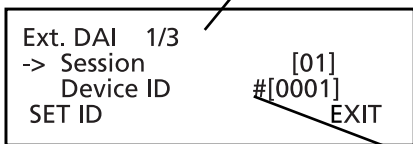

EXTERNAL DAI 1 (of 3 DAIs); the appropriate LED will illuminate on the front of the DAI

Hash indicates that the ID number has been already assigned to another device. Select a different number!

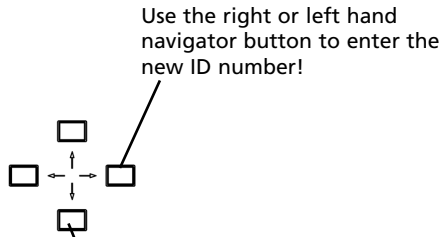

Use the right or left hand navigator button to enter the new ID number!

Use the up or down navigator button for scrolling

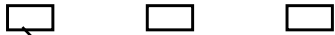
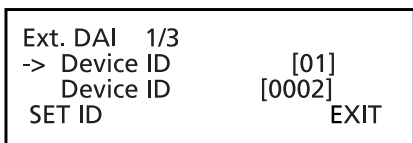

press the SET ID button to confirm

3.3.10.2 DAI Set-up

In the DAI SETUP menu you may assign channels to the LINE INPUTS and LINE OUTPUTS of the internal and external DAIs.

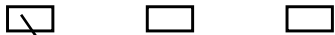

press the ENTER button

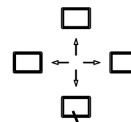

Use the up or down button for scrolling

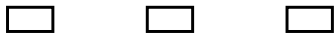
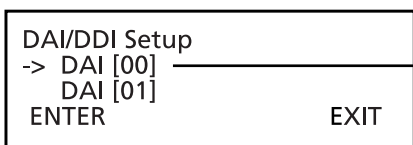

Internal DAI [=00] of the control unit

The DAI SETUP menu includes a list of the internal D/A interfaces of the MCS-D 200 control unit [=00] and all external DAI units; each with its ID number that has been set in the EXT. DAI ID LIST menu.

The identification number of the internal DAI of the MCS-D 200 control unit is fixed and cannot be changed.

Use the up or down navigator button to scroll through the list. Use the ENTER button to select a DAI for assigning channels.

The LED on the front of the DAI interface will illuminate for the selected D/A unit.

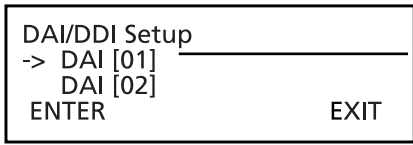

External DAI no. 01



press the ENTER button, to assign channels to DAI no. 01

Each DAI unit features CH1 IN, CH 2 IN; CH 1 OUT, CH 2 OUT

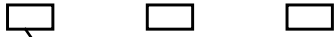
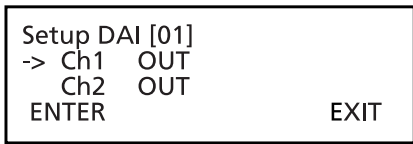
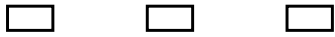
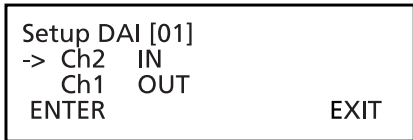

press the ENTER button for CH 1 OUT

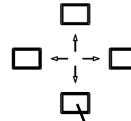

Use the up or down navigator button for scrolling

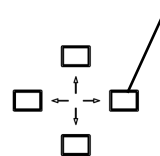
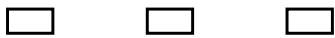
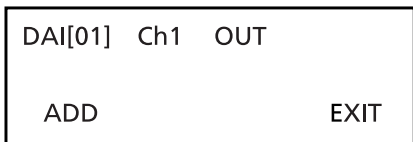

Use the right or left hand navigator to scroll through the list of defined channels!

Scroll through the list of channels which has been defined in the DEFINE CHANNELS menu before.

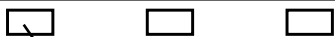
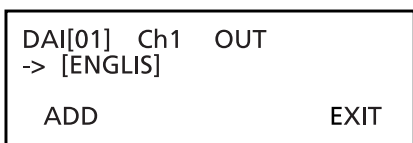

press the ADD button

Press the ADD button to confirm the selected channel. You can select and add another channel or press the EXIT button.

3.3.10.3 DAI Control

The DAI CONTROL is operated as described in the following:

- Switch on/off all LINE INPUTS and LINE OUTPUTS of the internal and external DAIs.

Warning:

Unused DAI inputs must be **OFF**, to avoid noise!

- Adjust the level of all LINE INPUTS and LINE OUTPUTS of the internal and external DAIs

INTERNAL DAI level	EXTERNAL DAI level
IN: -28.5 dB...+18 dB	IN: -9.5 dB...+13 dB
OUT: -78 dB...+16.5 dB	OUT: -24 dB...+22.5 dB

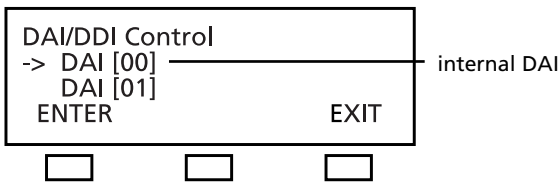
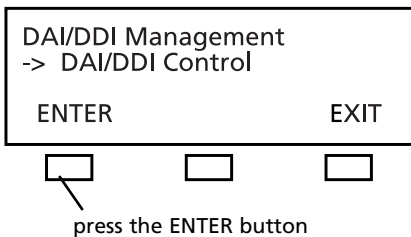

The DAI CONTROL menu includes a list of the internal and external DAIs; each with its ID number that has been set in the EXT DAI ID LIST (refer also to chapter 3.3.10.1 "Ext. DAI ID List").

The identification number [=00] of the internal DAI of the MCS-D 200 control unit is fixed and cannot be changed.

Use the up or down navigator button to scroll through the list. Use the ENTER button to select the DAI. The LED of the selected D/A unit will illuminate on the front panel of the DAI.

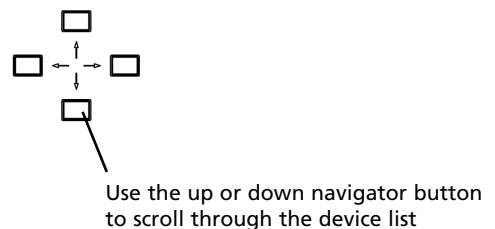
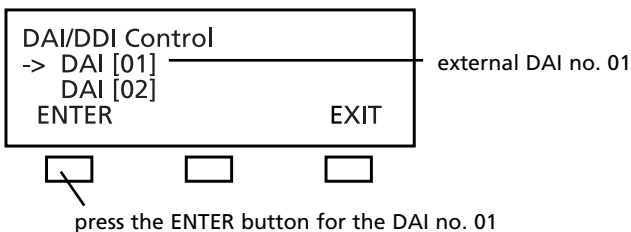

Each DAI unit features CH1 IN, CH 2 IN; CH 1 OUT, CH 2 OUT

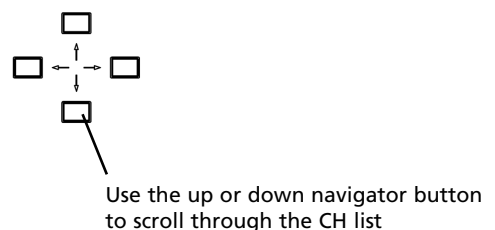
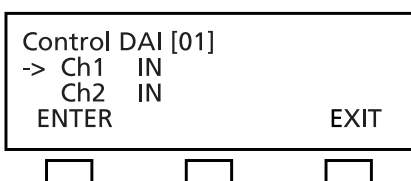

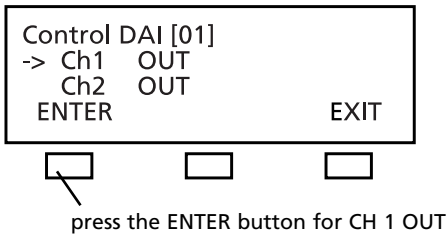
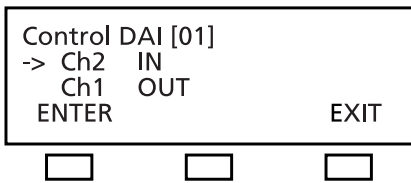

How to switch off a channel:

Warning:
Unused DAI inputs must be **OFF**, to avoid noise!

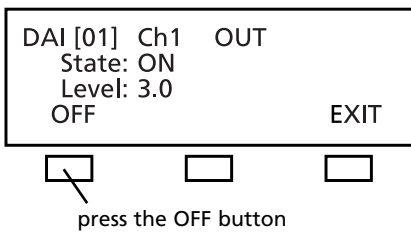

How to switch on a channel:

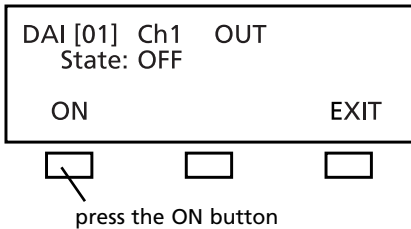

How to set the level:

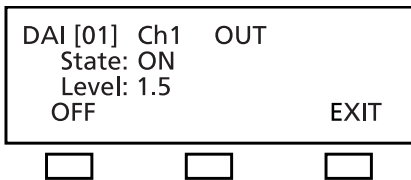

INTERNAL DAI level	EXTERNAL DAI level
IN: -28.5 dB...+18 dB	IN: -9.5 dB...+13 dB
OUT: -78 dB...+16.5 dB	OUT: -24 dB...+22.5 dB

4. CA 4115/30/45 Power Supply Unit

The MCS-D 200 control unit features a modular power converter for approximately 15 microphone stations (MCS-D 202 or MCS-D 2073); optionally two power converters for approximately 30 microphone stations.

If the system is to be extended, you will require additional power supply units.

The following power supply units are supplied for installation into a 19" rack.

CA 4115 power supply unit (1 modular power converter = 2 A) for approx. 15 microphone stations

CA 4130 power supply unit (2 modular power converters = 4 A) for approx. 30 microphone stations

CA 4145 power supply unit (3 modular power converters = 6 A) for approx. 45 microphone stations

Note:

Before connecting any devices, always make sure which type of power supply unit you are using. You will find the designation on the type plate on the back panel of the power supply unit.

4.1 Controls and indicators

Front view

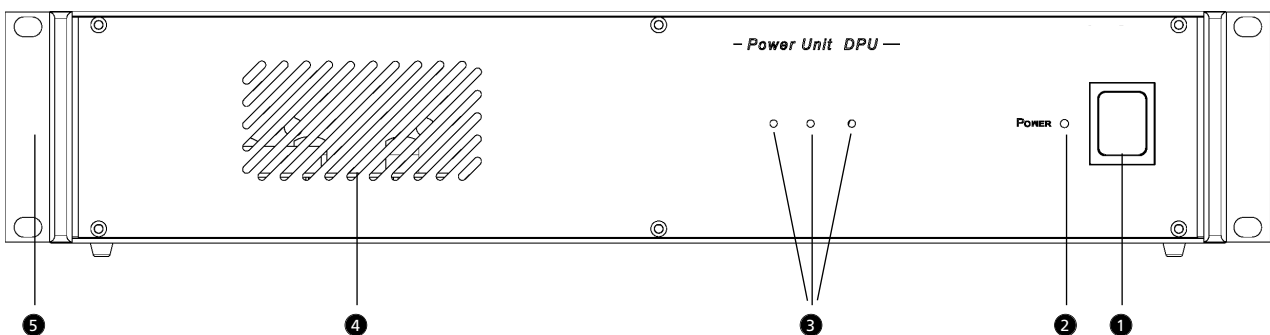

- 1 Power switch
- 2 Power LED illuminates when the MCS-D 200 control unit is switched on and ready to pass signals, no matter if the power switch 1 is on or off.
- 3 Power converter LED 1-3. These LEDs will only illuminate when the MCS-D 200 control unit and the power supply unit are switched on.
- 4 Ventilation slots must not be covered to provide unrestricted circulation.
- 5 Mounting brackets for installation into a 19" rack.

Rear view

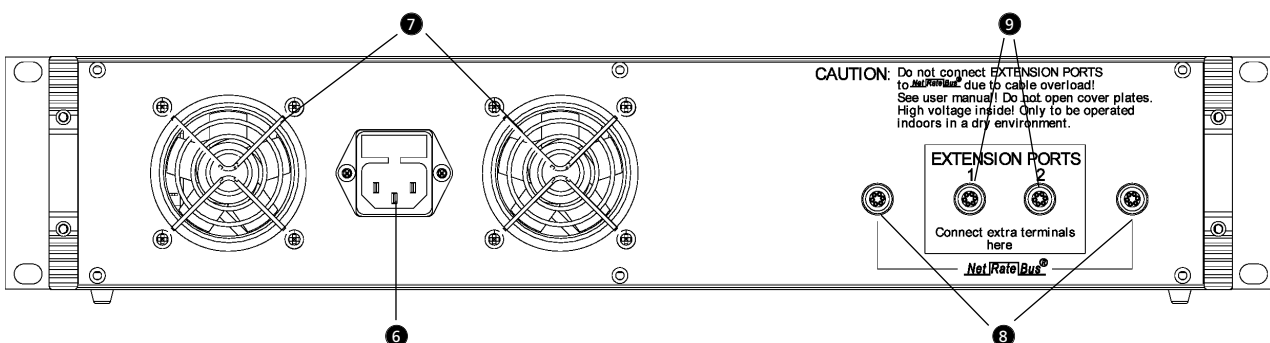

- 6 Mains connector with fuse holder. The fuse holder contains a 6.3 A slow-blow (T) fuse.
- 7 Ventilation outlet. The fan is controlled by the temperature.
- 8 NetRateBus sockets to connect the MCS-D 200 control unit or CA 4115/30/45 power supply unit.
- 9 Extension ports to connect microphone stations such as MCS-D 202, MCS-D 2073 etc.

4.2 Connection

4.2.1 Control unit – power supply unit

- The MCS-D 200 control unit and the power supply unit are connected via the NetRateBus socket ⑧. Refer also to chapter 8. "Set-up examples".
- Warning:** Connected devices (e.g. adapters or Digital/Analog interfaces) are powered by the MCS-D 200 control unit and have to be considered in power calculations.
- Each unit which is connected to a NetRateBus socket is powered by the MCS-D 200 when it is switched on. It is not important if the power supply unit is switched on or off. A Digital/Analog interface or adapter connected to the NetRateBus sockets would be powered by the power converter of the MCS-D 200. These sockets are not the power outputs for the microphone stations, adapter or interfaces.

4.2.2 Microphone stations - power supply unit

- Connect microphone stations, Digital/Analog interfaces and adapters to the EXTENSION PORTS ⑨ angeschlossen.
- Any device which is connected to an EXTENSION PORT, is powered by the power converters 1-3 of the CA 4115/30/45 power supply unit, when the MCS-D 200 control unit and the power supply unit are switched on. This is indicated by the illuminated LEDs 1-3.

4.3 How to switch on the power supply unit

- Check all connections before switching on.
- Stand-by:** A switched-on power supply unit is in stand-by mode when the mains switch is illuminated, but the power converters 1-3 cannot emit power via the EXTENSION PORTS ⑨, because the MCS-D 200 control unit is not yet switched on. In this case neither the "POWER" LED ② nor the power converter LEDs 1-3 ③ will illuminate.
- We recommend switching on the devices as described in the following:
 - Switch on all power supply units first. The mains switch ① will illuminate and indicate the stand-by mode.
 - Switch on the MCS-D 200 control unit. The "POWER" LED ② of the MCS-D 200 will illuminate. Then the "POWER" LED ② of each power supply unit will illuminate.
- Then the power converters 1-3 can emit power via the EXTENSION PORTS ⑨. The illuminated power converter LEDs 1-3 ③ display the appropriate power supply unit:
 - LED 1 CA 4115 (1 power converter for 2 A)
 - LED 1 + 2 CA 4130 (2 power converters for 4 A)
 - LED 1 + 2 + 3 CA 4145 (3 power converters for 6 A).
- The green Power-LED ② of the power supply unit will illuminate when the MCS-D 200 control unit is switched on and a bus signal is produced, no matter if the mains switch ① of the power supply unit is switched on or off.
- The LEDs indicate the following:

GREEN:	OFF:
<ul style="list-style-type: none"> - the MCS-D 200 control unit is switched on - the power supply unit is switched on - the power converter emits power via the EXTENSION PORTS 	<ul style="list-style-type: none"> - the MCS-D 200 control unit is switched off - the power supply unit is switched off - the power converter is not installed or defective

5. CA 4522/44/66 Digital / Analogue Interface (DAI)

You may connect additional Digital / Analogue Interfaces (DAI) via the conference bus for the connection of external audio devices such as wireless microphones or tape recorders providing the sound of a video film in different languages. The 19" housing of a Digital / Analogue Interfaces (DAI) may be equipped with up to 3 interface units (=EXTERNAL DAI), each with 2 analogue audio inputs and outputs. The DAI is powered by the system power supply and is recognised upon system start:

(CA 4522: 1 x (2 IN / 2 OUT); CA 4544: 1 x (4 IN / 4 OUT); CA 4566: 1 x (6 IN / 6 OUT).

In the DAI/DDI MANAGEMENT menu you can adjust the following:

- Set an identification number (logical address) for every external DAI
- You can assign channels to the LINE INPUTS and LINE OUTPUTS of the INTERNAL and EXTERNAL DAIs

DAIs are operated as described in the following:

- Adjust the level of all LINE INPUTS and LINE OUTPUTS of the INTERNAL and EXTERNAL DAIs
- Switch on/off all LINE INPUTS and LINE OUTPUTS of the INTERNAL and EXTERNAL DAIs

Warning: Unused DAI inputs must be OFF, to avoid noise!

5.1 Controls and indicators

Front view

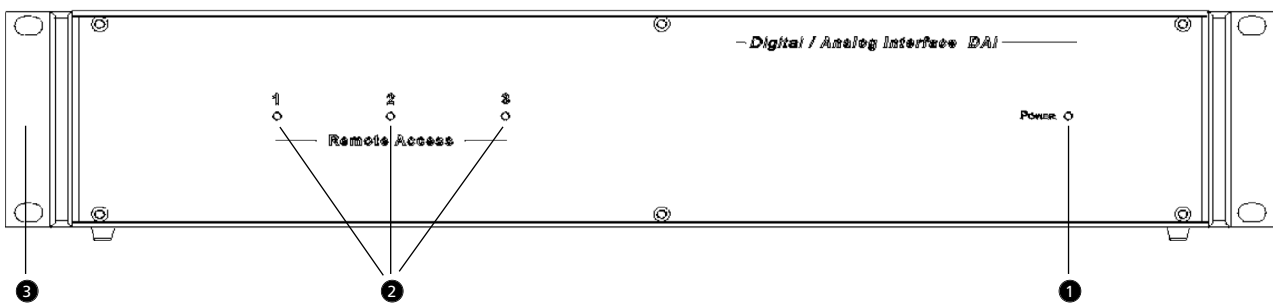

- 1 Power LED will illuminate when the system is switched on
- 2 Identification LED will illuminate during the configuration to indicate which of the 1-3 unit of a Digital / Analogue interface is currently configured
- 3 Mounting bracket for 19" rack. For the tabletop version, you may replace the mounting brackets by corner profiles.

Rear view

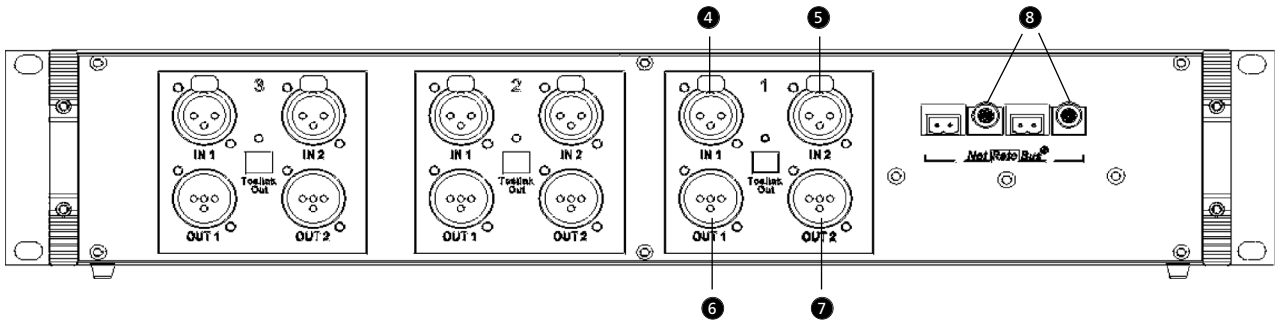

- ④ CH1 IN: XLR LINE IN input (female), ± 0 dBm, balanced. The signal fed in will be transmitted to the loudspeakers of the microphone stations or to any other output which can be selected via the MCS-D 200 control unit.
- ⑤ CH2 IN: XLR LINE IN input (female), ± 0 dBm, balanced. The signal fed in will be transmitted to the loudspeakers of the microphone stations or to any other output which can be selected via the MCS-D 200 control unit.
- ⑥ CH1 OUT: XLR LINE OUT output (male), ± 0 dBm, balanced. Master output of all microphones or any other channel; programmable for recording or broadcasting applications.
- ⑦ CH2 OUT: XLR LINE OUT output (male), ± 0 dBm, balanced. Master output of all microphones or any other channel; programmable for recording or broadcasting applications.
- ⑧ NetRateBus socket for conference bus.

6. CA 4577 Digital / Digital Interface (DDI)

To provide digital AES/EBU outputs you may connect additional CA 4577 Digital / Digital Interfaces via the conference bus. The CA 4577 is powered via the system and will be recognised when the system is started.

Use the DAI/DDI MANAGEMENT menus to adjust the following:

- Assign channels to digital outputs

The DDIs are operated as described in the following:

- Switch on/off channels of all outputs

6.1 Controls and indicators

Front view

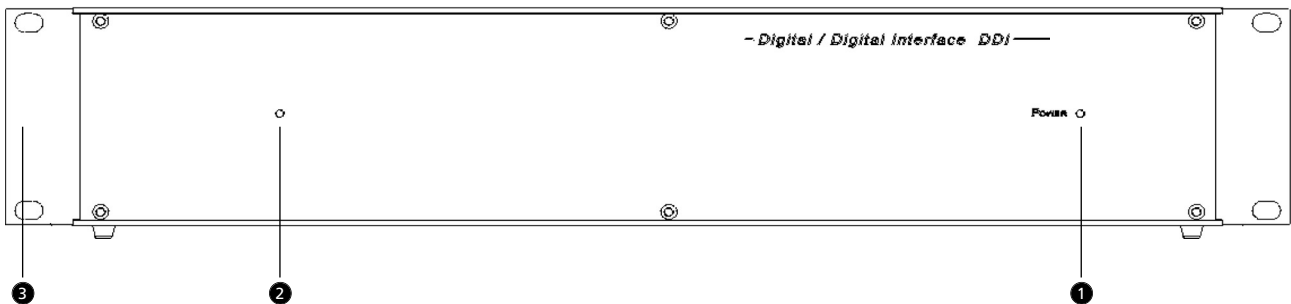

- 1 Power LED will illuminate when the system is switched on.
- 2 Identification LED will illuminate during configuration to indicate which unit 1-3 of the Digital/Digital Interface is currently configured.
- 3 Mounting bracket for 19" rack. For the tabletop version, you may replace the mounting brackets by corner profiles.

Rear view

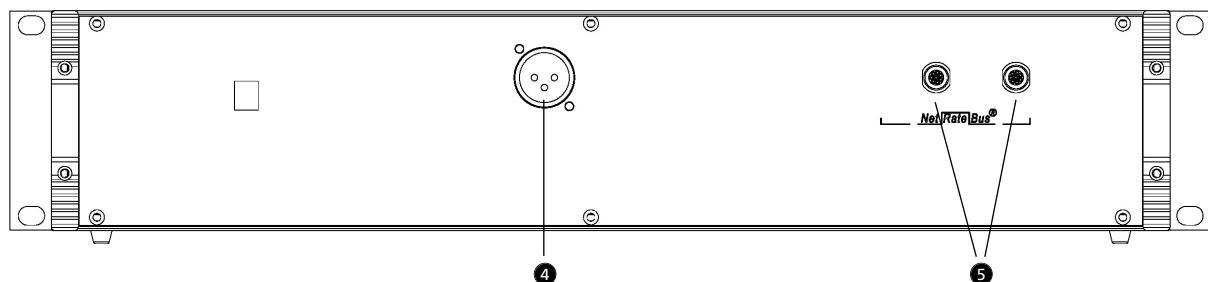

- 4 AES/EBU Output (XLR). Digital master output of all microphones or any other channel; programmable for recording or broadcasting applications.
- 5 NetRateBus conference sockets

7. Microphone Stations

For the MCS-D 200 system there is a variety of microphone stations available. Make sure that the microphone and all cables are tightly and properly connected. If a cable is not properly connected, interferences can occur.

All settings of the microphone stations are stored when the system is turned off. Standard settings can be reloaded via the MCS-D 200 control unit.

7.1 MCS-D 2073

The MCS-D 2073 microphone station can be configured as delegate or chairman station.

7.1.1 Controls and indicators

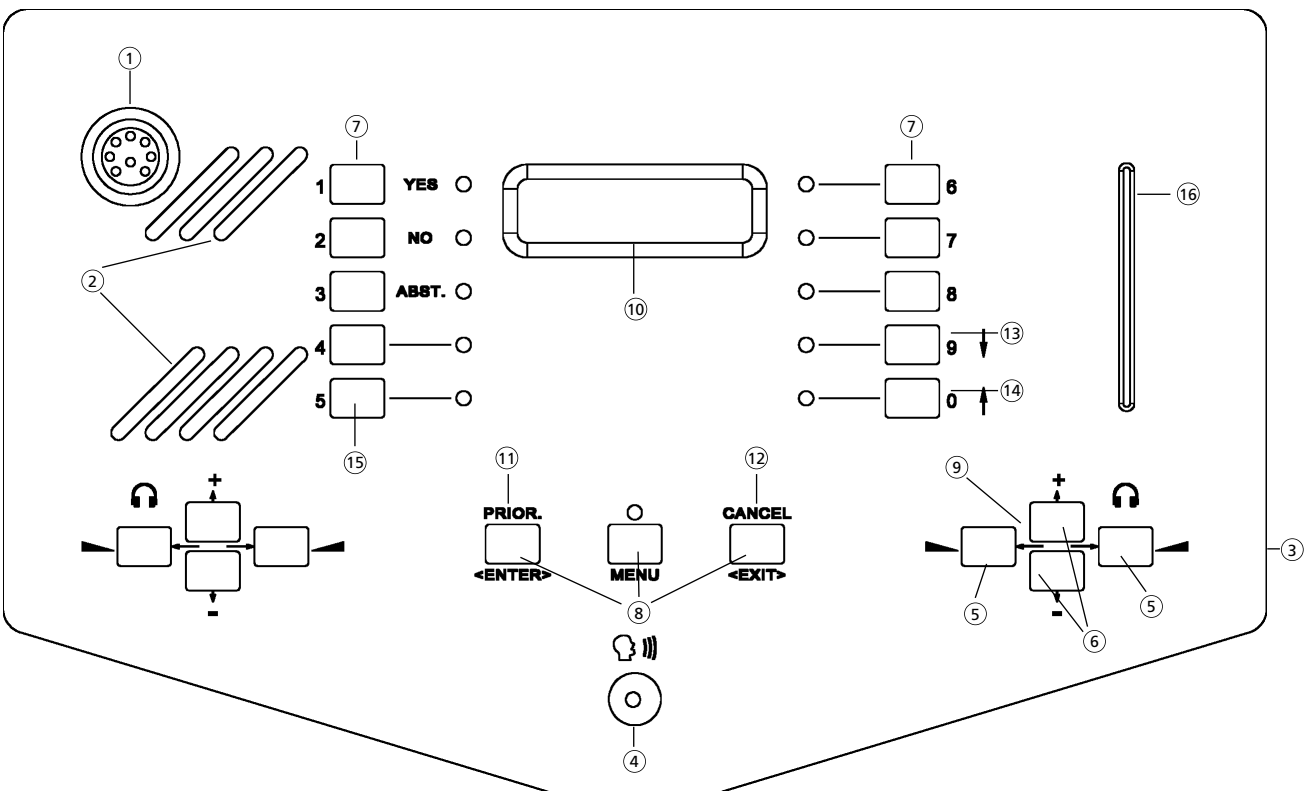

- ① Microphone socket. Make sure that the microphone is connected properly and tightly.
- ② Loudspeaker. The original sound of the conference is transmitted via the two loudspeakers. When the microphone is activated, the loudspeaker of the microphone station is turned off automatically.
- ③ Headphone socket (3.5 mm TRS jack) on the right and left hand side (optional with a 2nd language selector). Connect a headphone to listen to the original sound or an available language channel via headphones. You can also connect a tape recorder to this socket.
- ④ Microphone to turn on the microphone or to register a request-to-speak in the system.
- ⑤ Buttons to set the volume of the headphone, with autorepeat function. The setting (between 0 and 63) is displayed. The settings are still stored when the system is turned off.
Important: Make sure that the MENU button is not activated when you set the volume. If the MENU button is activated these buttons act as navigator buttons.
- ⑥ Language/channel selector buttons (up / down) on the right and left hand side with autorepeat function. Use the Channel Up and Channel Down buttons to select a language channel, the original channel (OR) or any other available information, audio or music channel, which is to be transmitted to the connected headphone.
Important: Make sure that the MENU button is not activated when setting the volume. If the MENU button is activated, these buttons act as navigator buttons.
The list of channels is displayed. The language channels are encoded according to the international MARC language codes.
- ⑦ Voting button for electronic votings (only when using the iCNS software)
- ⑧ Menu buttons (ENTER, MENU, EXIT)
- ⑨ Navigator buttons (left, right, up, down)
- ⑩ Display
- ⑪ Priority button (only when microphone station is configured as chairman station)
- ⑫ Cancel button (only when microphone station is configured as chairman station)
- ⑬ Function button 9 to activate the microphone of the previous speaker again (only when microphone station is configured as chairman station)
- ⑭ Function button 0 to activate the next request-to-speak (only when microphone station is configured as chairman station)
- ⑮ Function button 5 to turn on podium microphone stations with the ID # 1999 or 2000 (only when microphone station is configured as chairman station). LED will illuminate, when the microphone station is activated via the function button 5.
- ⑯ Chip card reader (only possible when using the iCNS software)

7.1.2 How to turn the microphone on

Press the microphone button ④ once to turn on the microphone or to enter a request-to-speak. Press the microphone button once again to turn off or cancel the request-to-speak.

- The LED ring of the microphone will illuminate when the microphone is turned on.
- The LED ring of the microphone will flash when a request-to-speak has been entered. The request-to-speak will be registered and the microphone unit will be released by the chairman.
- If the selected limit of open microphones or requests to speak is exceeded, the LED of the microphone button will flash briefly and the delegate has to either turn on the microphone or enter a request-to-speak later.

Depending on the selected operating mode, the LED ring of the microphone displays the indications described below:

FREE MODE

The microphone is turned on by pressing the microphone button, if the limit is not yet achieved. If the limit is exceeded, the LED ring of the microphone will flash briefly. The delegate has to try later to turn on the microphone.

FREE - limit is not yet achieved:	FREE - limit is exceeded:
LED ring of the microphone will illuminate -> Microphone is turned on	LED ring of the microphone will flash briefly -> Try again later!

REQUEST MODE

The request-to-speak is entered by pressing the microphone button. The request-to-speak is registered and the microphone is activated by the chairman. The request-to-speak can be cancelled by pressing the microphone button once again. If the limit is exceeded, the LED ring of the microphone will flash briefly. The delegate has to try again to enter the request-to-speak later.

REQUEST - limit is not yet achieved:	REQUEST - limit is exceeded:
LED ring of the microphone will flash -> Microphone will be activated by the chairman	LED ring of the microphone will flash briefly; no registration -> Try again later!

AUTO MODE

The delegates activate their microphone or enter a request-to-speak one after another. A delegate can activate his microphone by pressing the microphone button if the selected limit is not yet achieved. If the limit is exceeded, the request-to-speak is registered by the MCS-D 200 control unit and the microphone is activated automatically as soon as another speaker turns off his microphone. The request-to-speak can also be cancelled by pressing the microphone button once again. If the selected limit for requests-to speak is exceeded, the LED ring of the microphone will flash briefly. The delegate has to try again to enter his request-to-speak later.

AUTO - limit for turned on microphones is not yet achieved:	AUTO - limit for turned on microphones is exceeded:	AUTO - limit for requests-to-speak is exceeded:
LED ring of the microphone will illuminate -> Microphone is turned on	LED ring of the microphone will flash -> Microphone is turned on automatically as soon as another speaker turns off his microphone	LED ring of the microphone will flash briefly -> Try again later!

FIFO MODE (FIRST IN - FIRST OUT)

The delegates speak one after another. A delegate can turn on his microphone by pressing the microphone button at any time. If the selected limit is exceeded, the microphone of the speaker who turned on his microphone first, is deactivated automatically (first in-first out). A distance of approx. 30 cm is close enough when speaking.

FIFO - limit is not yet achieved:	FIFO - limit is exceeded:
LED ring of the microphone will illuminate -> Microphone is turned on	LED ring of the microphone of the new speaker will illuminate -> Microphone of the new speaker is turned on -> Microphone of the speaker who has been speaking the longest is turned off, as soon as the new speaker turns on his microphone

Note:

The chairman can control the discussion with the following function buttons: CANCEL ⑫ : clear turned on microphones and/or requests-to-speak. NEXT ⑭ : release the next request-to-speak. PREVIOUS ⑬ : turn on the microphone of the previous speaker.

7.1.3 How to set the volume of the headphone

Press the left or right hand button ⑤ to set the volume of the connected headphone. The buttons feature an autorepeat function. Please make sure that the MENU button is not activated! When the MENU button is activated these buttons act as navigator buttons. When the value is set, the value (0 - 63) is displayed.

The settings remain stored even when the system is turned off.

7.1.4 How to set the language or channel

Use the CHANNEL UP or CHANNEL DOWN buttons ⑥ to select a language channel, the original channel (OR) or any other available information, audio or music channel which is then transmitted via the connected headphone. The buttons feature an autorepeat function. Please make sure that the MENU button is not activated! When the MENU button is activated, these buttons act as navigator buttons! When pressing the buttons the channel list is displayed. The language channels are encoded according to the international MARC language codes.

In the following you will find some examples for channel descriptions. The list has been created via the menu of the MCS-D 200 control unit before.

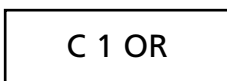

Channel 1 is the conference or original channel (OR).

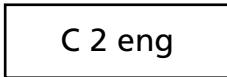

Channel 2 is the English channel.

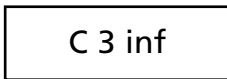

Channel 3 is an information channel.

The settings remain stored even when the system is turned off.

7.1.5 Menu buttons

The functions of the PRIOR and CANCEL buttons are only available when the microphone station has been set as a chairman station via the MCS-D 200 control unit.



- <Enter> = Confirm (function only available when MENU button is activated!)
- Menu = Activate or deactivate the menu functions
- <Exit> = Leave a submenu (function only available when MENU button is activated!)

Note:

The <ENTER> and <EXIT> buttons are only available when the MENU button is activated. The PRIOR and CANCEL button of the chairman station are only available when the chairman has deactivated the menu button.

The following refers to an activated or deactivated menu button:

MENU button ACTIVATED	MENU button NOT ACTIVATED
Blue MENU LED will illuminate	Blue MENU LED will not illuminate
<ENTER> and <EXIT> buttons available, PRIOR and CANCEL buttons not available	PRIOR and CANCEL buttons available, <ENTER> and <EXIT> buttons not available
NAVIGATOR ⑨ available; buttons for headphone volume ⑤ and language selection ⑥ not available	Buttons for headphone volume ⑤ and language selection ⑥ available, NAVIGATOR ⑨ not available
The DISPLAY ⑩ will show the appropriate menus	The DISPLAY ⑩ will show the default display, e.g. time (CLOCK)

7.1.6 Menu settings

Activate the MENU button. The blue LED will illuminate. The time menu (CLOCK) is displayed.

Select a menu with the navigator buttons

Use the UP or DOWN button to select one of the following menus:

CLOCK as default display

The default display is only shown, when the display is not needed to show any other function.

Format: HOUR – MINUTES – SECONDS.

In the TIME menu of the MCS-D 200 control unit, the system time can be set manually. The system time is automatically updated when the system is started.

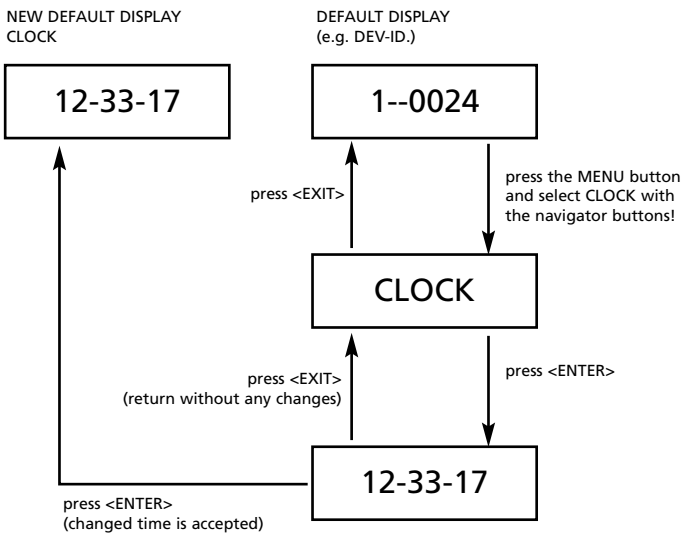

DEVICE ID as default display

The default display is only shown, when the display is not needed to show any other function.

The DEVICE ID is also the telephone number of the microphone station. When the device ID has been selected as default display, the participant can display his telephone number permanently.

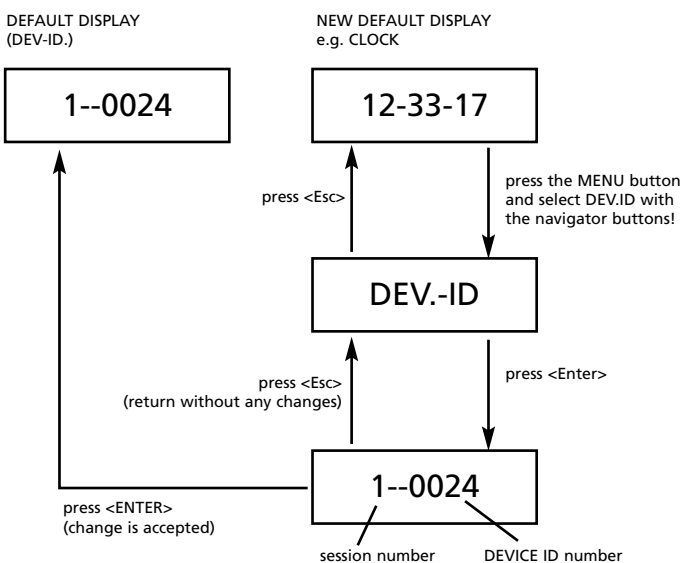

Telephone

Note:

If chip cards are used for the activation of the microphone stations, the participant himself can only dial when the chip card is inserted. When microphone stations are locked, the participants cannot dial, but accept phone calls.

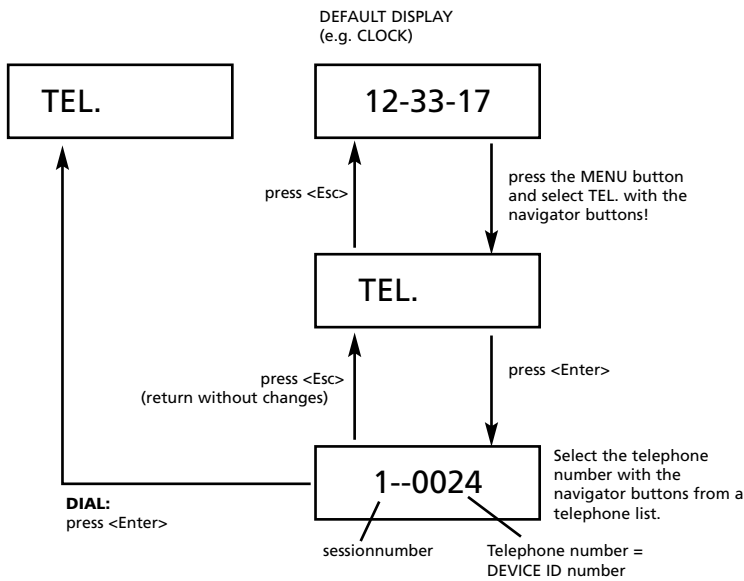

Accept phone calls

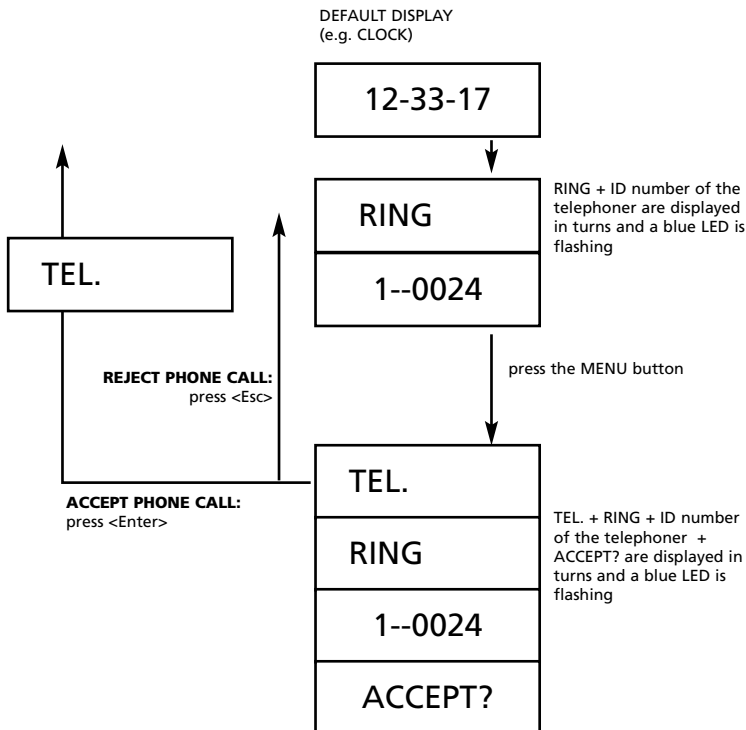

How to complete the phone call

Press the MENU button to interrupt the phone call. The blue LED will go out.

7.1.7 How to switch on a microphone while phoning

While phoning, the microphone of a microphone station can also be switched on or registered by pressing the microphone button.

1. If the microphone of a phoning participant is turned on, the phone call is interrupted immediately. The LED ring of the microphone is illuminated. The other participant will hear an engaged signal which can be turned off by pressing the MENU or ENTER button.
2. When a request-to-speak is entered the phone call is not interrupted immediately. The LED ring of the microphone is flashing. The request-to-speak is registered and the microphone can be released by the chairman - or automatically when the system operates in the AUTO MODE. The phone call is interrupted and the other participant will hear an engaged signal, which can be turned off by pressing the MENU or ENTER button.
3. If the limit is exceeded, the LED ring of the microphone will flash briefly. The delegate has to try to register his request-to-speak later.

Press the microphone button once again to turn off the microphone or to cancel a request-to-speak.

7.1.8 How to operate the navigator buttons

Whenever the MENU button is activated and the blue MENU LED is illuminated, you can scroll with the up and down or left and right hand navigator buttons through the appropriate menus.

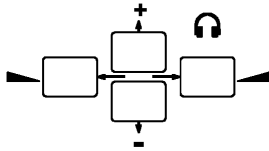

7.1.9 Display

The display shows information and menus (8 characters / 1 line).

MENU button is not activated:

The default display is shown, when the display is not required for other functions. The factory setting is the time display. If you would like to change the default display, please refer to chapter 7.1.6 "Menu settings".

12-33-17

Example of the default display: CLOCK (time display) in the format: HOURS – MINUTES – SECONDS.

101-0002

Booth number and ID number of the interpreter are displayed, who sends a call via the CALL button.

VOL 35

The level of the headphone volume is displayed when pressing the volume buttons.

C 2 eng

Language channels are displayed when pressing the language channel buttons.

RING

A phone call.

7.1.10 MCS-D 2073 as chairman station

Each MCS-D 2073 microphone station can be configured as a chairman station via the MCS-D 200 control unit. Refer also to chapter 3.3.4.3 "President(s)".

Note:

Whenever the MENU button is activated, the PRIOR and CANCEL buttons cannot be enabled. When the MENU button is deactivated, the PRIOR and CANCEL buttons can be enabled once again.

The chairman can control the discussion with the following function buttons:

PRIOR.

 The PRIOR button only works when the microphone station has been configured as a chairman station via the MCS-D 200 control unit. If the MENU button is activated its function is not available.

<ENTER>

Hold down the PRIOR button for a short interruption or announcement. If your microphone was not yet activated it will be turned on by pressing the PRIOR button. All turned on microphones remain muted with a flashing LED ring as long as you hold down the PRIOR button.

Chairmen of a higher level can mute all delegate microphones and chairman microphones of a lower level by holding down the PRIOR button.

CANCEL

 The CANCEL button only works when the microphone station has been configured as a chairman station via the MCS-D 200 control unit. If the MENU button is activated its function is not available.

<EXIT>

Press briefly (< 1s): The microphones of all speakers are turned off simultaneously; registered requests-to-speak are not cleared.

Hold down (> 1s): The microphones of all speakers are turned off simultaneously; registered requests-to-speak are cleared. This applies for all operating modes.

PREVIOUS

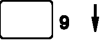
 The PREVIOUS button only works when the microphone station has been configured as a chairman station via the MCS-D 200 control unit. When a speaker turns off his microphone, the chairman can ask him to speak once again by pressing the PREVIOUS button. The speaker does not need to register a request-to-speak and answer a query directly.

The chairman can ask the previous speaker to speak once again as described in the following:

- Press briefly (< 1s): The microphone of the previous speaker is turned on again; the microphone of the current speaker is turned into the request mode.
- Hold down (> 1s): The microphone of the previous speaker is turned on again; the microphone of the current speaker is not turned off.

NEXT

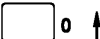
 The NEXT button only works when the microphone station has been configured as a chairman station via the MCS-D 200 control unit.

The chairman can ask the next speaker to speak as described in the following:

- Press briefly (< 1s): The microphone of the next speaker is turned on, the microphone which has been turned on the longest time is turned off (first in-first out).
- Hold down (> 1s): The microphone of the next speaker is turned on, the microphone which has been turned on the longest time is not turned off.

How to turn the podium microphone station on or off

Each chairman can turn on or off a podium microphone station (ID #1999, #2000) with the function button 5  of his chairman station. The LED will illuminate when the microphone is turned on.

1999: The podium microphone station is turned on or off by pressing the function button 5 .

2000: The podium microphone station is turned on or off by pressing the function button 5 , but it can also be turned on when pressing the microphone button of the podium station.

7.2 MCS-D 3121 / 3123

The MCS-D 3121 delegate station provides one microphone button and a two-way loudspeaker with two tweeters. The MCS-D 3123 chairman station features one microphone button, a two-way loudspeaker with two tweeters as well as "Clear" and "Priority" buttons.

7.2.1 Controls and indicators

Front view - MCS-D 3121 delegate station

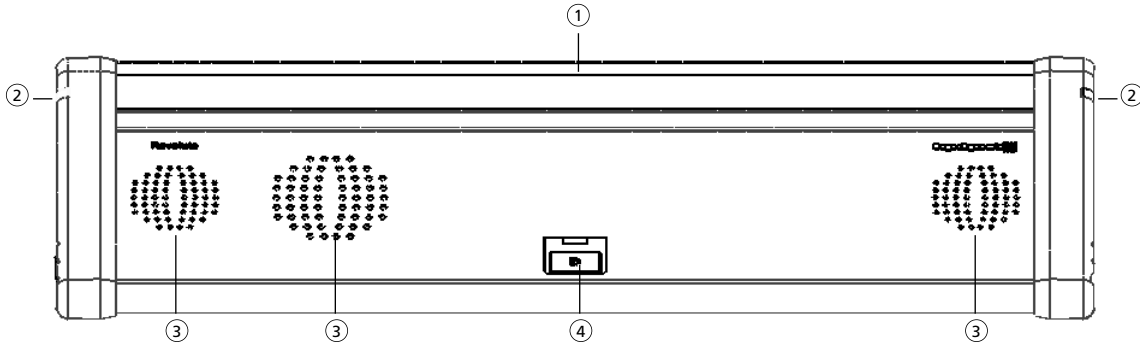

Front view - MCS-D 3123 chairman station

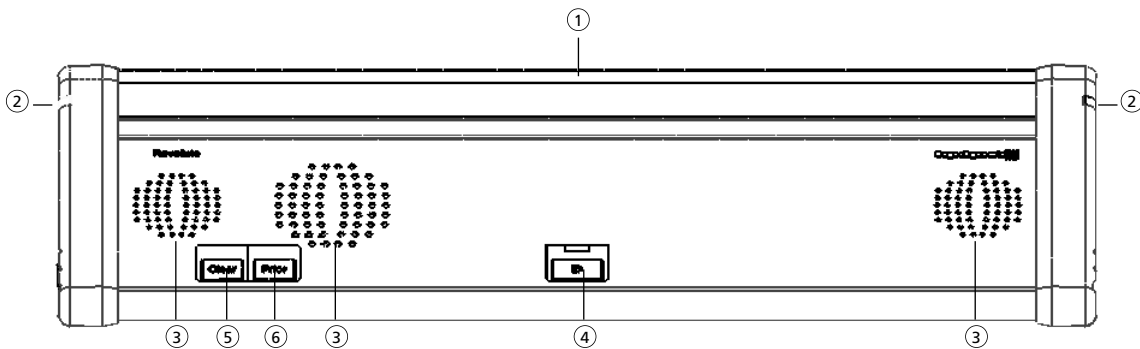

Rear view MCS-D 3121 and MCS-D 3123

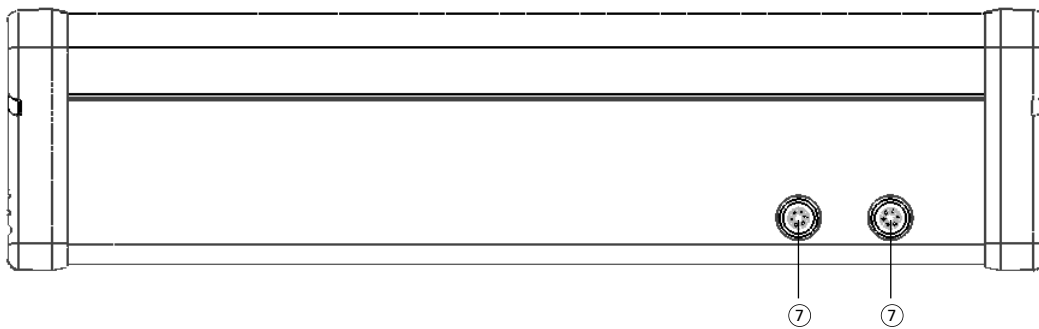

Lateral view MCS-D 3121 and MCS-D 3123

left hand side

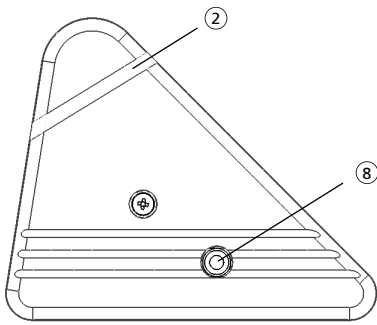

right hand side

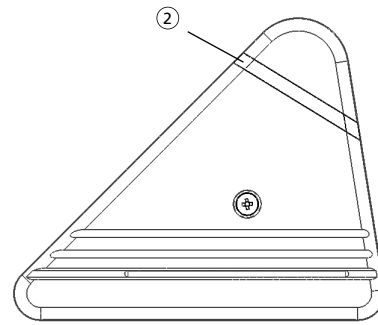

- ① Microphone
- ② LED strip illuminates when the microphone is activated.
- ③ Loudspeaker. The original signal of the conference is transmitted via the loudspeakers. As soon as the microphone is activated the loudspeaker will be deactivated. The volume is set via the control unit.
- ④ Microphone button to activate the microphone.
- ⑤ MCS-D 3123 only: "Clear" button to clear all activated delegate microphones.
- ⑥ MCS-D 3123 only: "Prior" button to mute all activated delegate microphones and to turn on the MCS-D 3123 microphone.
- ⑦ NetRateBus sockets, push-pull. To connect the microphone stations in a daisy chain.
- ⑧ Headphone socket, mini stereo jack (3.5 mm), to connect a headphone or recorder.

7.2.2 How to turn on the MCS-D 3121

Press the microphone button ④ once to turn on the microphone or to enter a request-to-speak. Press the microphone button once again to turn off the microphone or to cancel a request-to-speak.

- The LED of the microphone button and the LED strip ② will **illuminate** when the microphone is activated.
- The LED of the microphone button and the LED strip ② will **flash** when a request-to-speak is entered. The request-to-speak is registered and the microphone is activated via the iCNS software.
- A limit of open microphones can be set via the control unit or iCNS software.
- If the selected limit of open microphones is exceeded, the LED of the microphone button will flash briefly and the delegate has to either turn on the microphone or enter a request-to-speak later.

Depending on the selected operating mode, the LED of the microphone button and the LED strip display the indications described below:

FREE MODE

The microphone is turned on by pressing the microphone button, if the limit is not yet achieved. If the limit is exceeded, the LED of the microphone button and the LED strip will flash briefly. The delegate has to try later to turn on the microphone.

FREE - limit is not yet achieved:	FREE - limit is exceeded:
LED of the microphone button and the LED strip will illuminate -> Microphone is turned on	LED of the microphone button will flash briefly -> Try again later!

REQUEST MODE

The request-to-speak is entered by pressing the microphone button. The request-to-speak is registered and the microphone is activated via the iCNS software. The request-to-speak can be cancelled by pressing the microphone button once again. If the limit is exceeded, the LED of the microphone button and the LED strip will flash briefly. The delegate has to try again to enter the request-to-speak later.

REQUEST - limit is not yet achieved:	REQUEST - limit is exceeded:
LED of the microphone button and the LED strip will illuminate -> Microphone is activated via the iCNS software	LED of the microphone button will flash briefly - no registration! -> Try again later!

AUTO MODE

The delegates activate their microphone or enter a request-to-speak one after another. A delegate can activate his microphone by pressing the microphone button if the selected limit is not yet achieved. If the limit is exceeded, the request-to-speak is registered by the MCS-D 200 control unit and the microphone is activated automatically as soon as another speaker turns off his microphone. The request-to-speak can also be cancelled by pressing the microphone button once again. If the selected limit for requests-to speak is exceeded, the LED of the microphone button and the LED strip will flash briefly. The delegate has to try again to enter his request-to speak later.

AUTO - limit for turned on microphones is not yet achieved:	AUTO - limit for turned on microphones is exceeded:	AUTO - limit for requests-to-speak is exceeded:
LED of the microphone button and the LED strip will illuminate -> Microphone is turned on	LED of the microphone button and the LED strip will flash -> Microphone is turned on automatically as soon as another speaker turns off his microphone	LED of the microphone button will flash briefly -> Try again later!

FIFO MODE (FIRST IN - FIRST OUT)

The delegates speak one after another. A delegate can turn on his microphone by pressing the microphone button at any time. If the selected limit is exceeded, the microphone of the speaker who turned on his microphone first, is deactivated automatically (first in-first out).

FIFO - limit is not yet achieved:	FIFO - limit is exceeded:
LED of the microphone button and the LED strip will illuminate -> Microphone is turned on	LED of the microphone button of the new speaker will illuminate -> Microphone of the new speaker is turned on -> Microphone of the speaker who has been speaking the longest is turned off, as soon as the new speaker turns on his microphone

7.2.3 How to operate the MCS-D 3123 chairman station

By using the following function buttons, the chairman can conduct a meeting actively:

“Prior” button

The “Prior” button ⑥ operates only, if the microphone station has been programmed as a chairman station via the MCS-D 200.

For a brief interruption or announcement the “Prior” button must be held down. If the microphone was turned off, it will be turned on by pressing the “Prior” button. All the other activated microphones remain muted while the LED strip and LED of the microphone button are flashing, until the “Prior” button is released.

By using the “Prior” button, chairmen of a higher level can mute the microphones of all delegate stations as well as the microphones of all chairman stations of a lower level.

“Clear” button

The “Clear” button ⑤ operates only, if the microphone station has been programmed as a chairman station via the MCS-D 200.

Press briefly (< 1s): The microphones of all speakers are deactivated simultaneously; requests to speak are not cleared.

Hold down (> 1s): The microphones of all speakers are deactivated simultaneously; requests to speak are cleared.
This applies for all operating modes.

7.3 MCS-D 3171 / 3173

The MCS-D 3171 delegate station provides an LC display, one microphone button, five voting buttons and a two-way loudspeaker with two tweeters. The up / down navigator buttons allow selecting the desired channel while the headphone volume is set by using the right / left navigator buttons.

In addition to the above mentioned features the MCS-D 3173 chairman station provides a "Clear" and a "Priority" button.

7.3.1 Controls and indicators

Front view - MCS-D 3171 delegate station

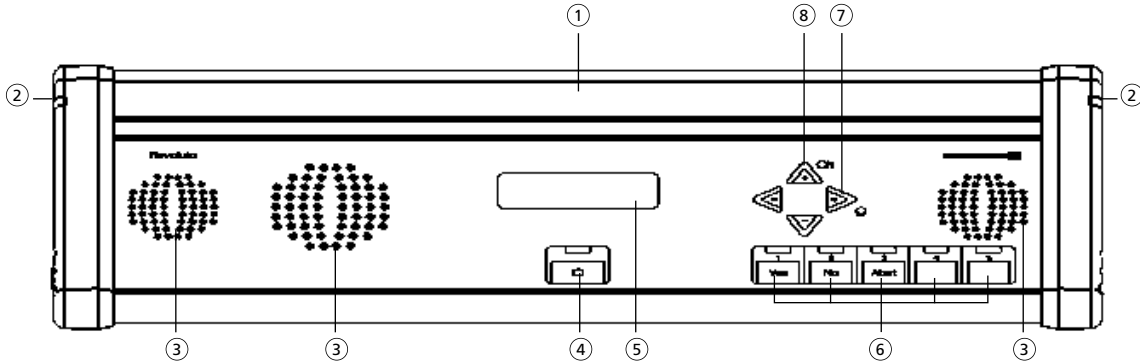

Front view - MCS-D 3173 chairman station

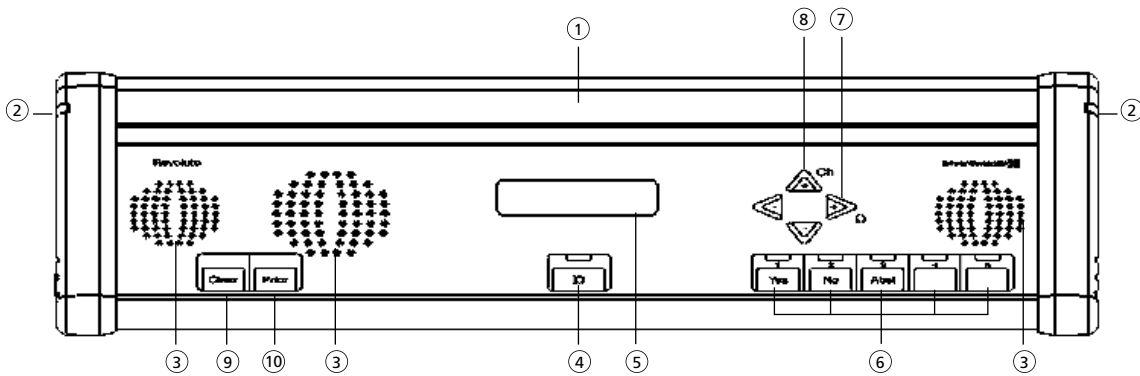

Rear view MCS-D 3171 and MCS-D 3173

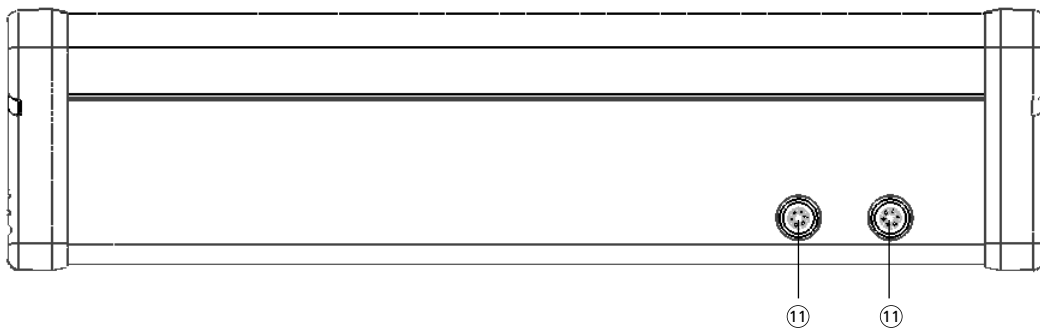

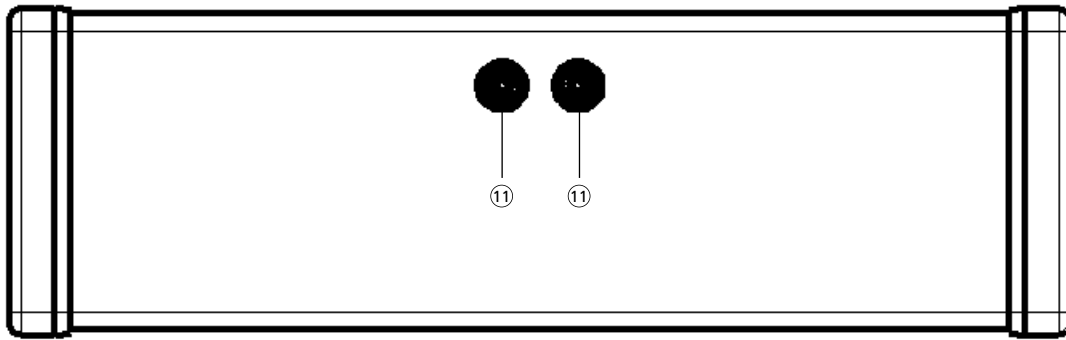
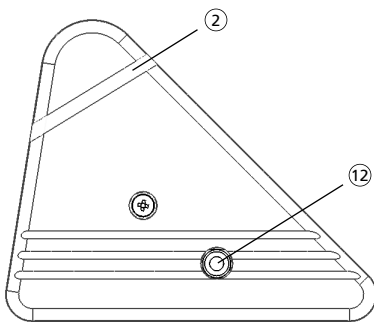
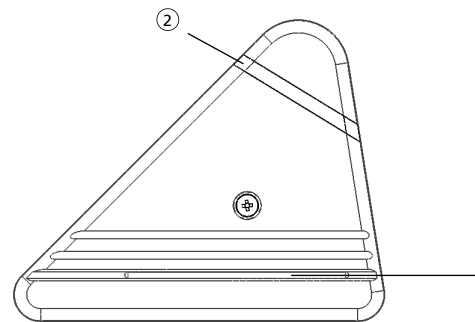
Bottom view MCS-D 3171 H and MCS-D 3173 H**Lateral view MCS-D 3171 and MCS-D 3173****left hand side****right hand side**

- ① Microphone
- ② LED strip illuminates when the microphone is activated.
- ③ Loudspeaker. The original signal of the conference is transmitted via the loudspeakers. As soon as the microphone is activated the loudspeaker will be deactivated. The volume is set via the control unit.
- ④ Microphone button with LED to activate the microphone.
- ⑤ LC display
- ⑥ Voting buttons. Button 1 to 3 for parliamentary votings. Button 1 to 5 for multiple choice.
- ⑦ Navigator buttons right / left to select the headphone volume
- ⑧ Navigator buttons up / down to select a channel
- ⑨ **MCS-D 3173 only:** "Clear" button to clear all activated delegate microphones.
- ⑩ **MCS-D 3173 only:** "Prior" button to mute all activated delegate microphones and to turn on the MCS-D 3173 microphone.
- ⑪ NetRateBus sockets, push-pull. To connect the microphone stations in a daisy chain.
- ⑫ Headphone socket, mini stereo jack (3.5 mm), to connect a headphone or recorder.
- ⑬ Chip card reader (optional)

7.3.2 How to display the Device ID

In order to display the device ID press the 5th button (on the very right) of the voting buttons ⑥ of the appropriate microphone station. During a voting the device ID cannot be displayed.

7.3.3 How to display messages

If a message is sent by using the iCNS software, it will appear in the LC display ⑤ of the appropriate microphone station. In the second line the message "Press Yes" will be displayed. This means the "Yes" button of the five voting buttons ⑥ has to be pressed to delete the message. During a voting pressing the "Yes" button the first time deletes the message; pressing the "Yes" button a second time means voting with "yes".

7.3.4 How to turn on the MCS-D 3171

Press the microphone button ④ once to turn on the microphone or to enter a request-to-speak. Press the microphone button once again to turn off the microphone or to cancel a request-to-speak.

- When the microphone is activated, the LED of the microphone button and the LED strip ② will **illuminate**.
- When a request-to-speak is entered, the LED of the microphone button and the LED strip ② will **flash**. The request-to-speak is registered and the microphone is activated via the iCNS software.
- If the selected limit of open microphones is exceeded, the LED strip ② and the LED of the microphone button will flash **briefly** and the delegate has to either turn on the microphone or enter a request-to-speak later.

Depending on the selected operating mode, the LED strip and the LED of the microphone button display the indications described below:

FREE MODE

The microphone is turned on by pressing the microphone button, if the limit is not yet achieved. If the limit is exceeded, the LED strip and the LED of the microphone button will flash briefly. The delegate has to try later to turn on the microphone.

FREE - limit is not yet achieved:	FREE - limit is exceeded:
LED of the microphone button and LED strip will illuminate -> Microphone is turned on	LED of the microphone button and LED strip will flash briefly -> Try again later!

REQUEST MODE

The request-to-speak is entered by pressing the microphone button. The request-to-speak is registered and the microphone is activated via the iCNS software. The request-to-speak can be cancelled by pressing the microphone button once again. If the limit is exceeded, the LED strip and LED of the microphone button will flash briefly. The delegate has to try again to enter the request-to-speak later.

REQUEST - limit is not yet achieved:	REQUEST - limit is exceeded:
LED of the microphone button and LED strip will flash -> Microphone is activated via the iCNS software	LED of the microphone button and LED strip will flash briefly - no registration! -> Try again later!

AUTO MODE

The delegates activate their microphone or enter a request-to-speak one after another. A delegate can activate his microphone by pressing the microphone button if the selected limit is not yet achieved. If the limit is exceeded, the request-to-speak is registered by the MCS-D 200 control unit and the microphone is activated automatically as soon as another speaker turns off his microphone. The request-to-speak can also be cancelled by pressing the microphone button once again. If the selected limit for requests-to speak is exceeded, the LED of the microphone button and the LED strip will flash briefly. The delegate has to try again to enter his request-to speak later.

AUTO - limit for turned on microphones is not yet achieved:	AUTO - limit for turned on microphones is exceeded:	AUTO - limit for requests-to-speak is exceeded:
LED of the microphone button and the LED strip will illuminate -> Microphone is turned on	LED of the microphone button and the LED strip will flash -> Microphone is turned on automatically as soon as another speaker turns off his microphone	LED of the microphone button will flash briefly -> Try again later!

FIFO MODE (FIRST IN - FIRST OUT)

The delegates speak one after another. A delegate can turn on his microphone by pressing the microphone button at any time. If the selected limit is exceeded, the microphone of the speaker who turned on his microphone first, is deactivated automatically (first in-first out).

FIFO - limit is not yet achieved:	FIFO - limit is exceeded:
LED of the microphone button and the LED strip will illuminate -> Microphone is turned on	LED of the microphone button of the new speaker will illuminate -> Microphone of the new speaker is turned on -> Microphone of the speaker who has been speaking the longest is turned off, as soon as the new speaker turns on his microphone

7.3.5 How to adjust the headphone volume

Press the right or left navigator button (7) to adjust the volume of the headphone connected to the microphone station. When selecting the volume the value (0 - 63) is displayed.

The settings remain stored even when the system is turned off.

7.3.6 How to select the language or channel

Press the up or down navigator button (8) to select the available language channel, original channel (OR) or another information, audio or music channel, which is then transmitted via the headphone connected to the microphone station. The language channels are encoded according to the international MARC language codes.

In the following you will find some examples for channel descriptions. The list has been created via the menu of the MCS-D 200 control unit before.

channel 1
or

Channel 1 is the conference or original channel (OR).

channel 2
eng

Channel 2 is the English channel.

channel 3
inf

Channel 3 is an information channel.

The settings remain stored even when the system is turned off.

7.3.7 How to operate the MCS-D 3173 chairman station

The chairman can turn on his microphone station at any time independent of a selected limit. By using the two function buttons "Prior" or "Clear" the chairman can conduct a meeting actively.

Prior button

The "Prior" button (10) operates only, if the microphone station has been programmed as a chairman station via the MCS-D 200.

For a brief interruption or announcement the "Prior" button must be held down. If the microphone of the MCS-D 3173 was turned off, it will be turned on by pressing the "Prior" button. All the other activated microphones remain muted while the LED strip and LED of the microphone button are flashing, until the "Prior" button is released.

By using the "Prior" button, chairmen of a higher level can mute the microphones of all delegate stations as well as the microphones of all chairman stations of a lower level.

Clear button

The "Clear" button (9) operates only, if the microphone station has been programmed as a chairman station via the MCS-D 200.

Press briefly (< 1s): The microphones of all speakers are deactivated simultaneously; requests to speak are not cleared.

Hold down (> 1s): The microphones of all speakers are deactivated simultaneously; requests to speak are cleared. This applies for all operating modes.

7.4 MCS-D 202

The MCS-D 202 is an interpreter station for one interpreter. It can directly be integrated into the conference network without an additional control unit. The access to the audio channels can be configured according to the application. The interpreter station can be operated with a gooseneck microphone or headset.

7.4.1 Controls and indicators

Top view

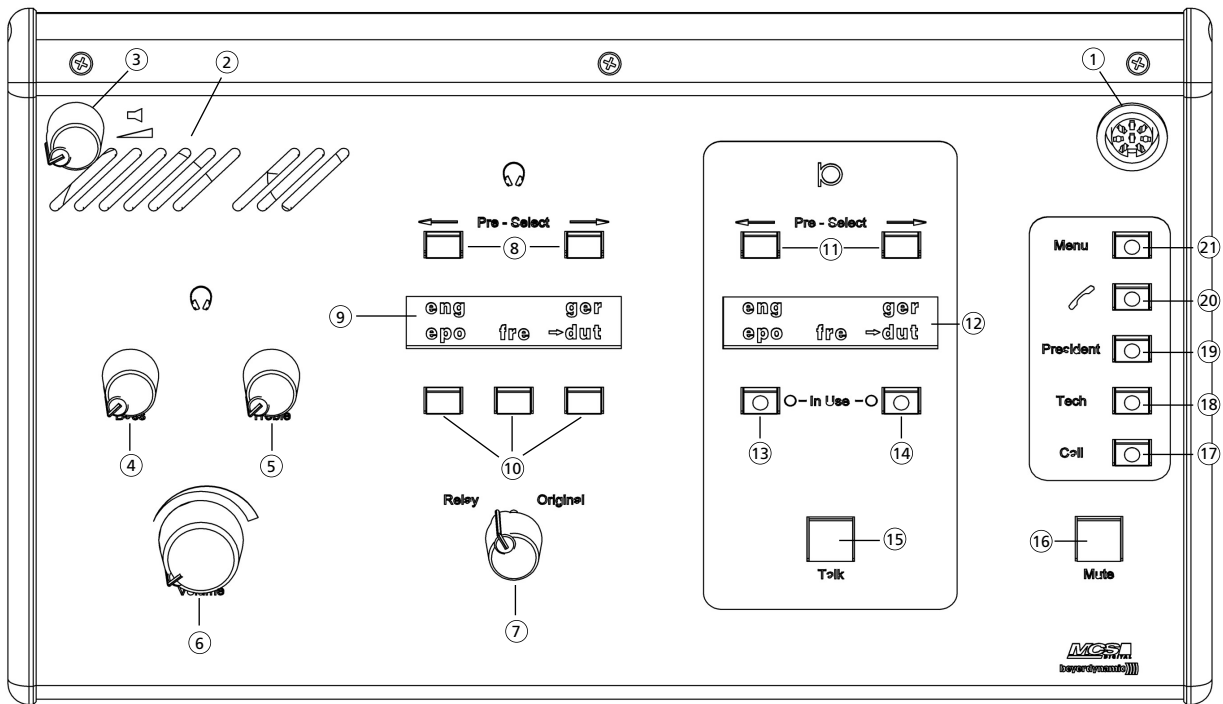

Bottom view

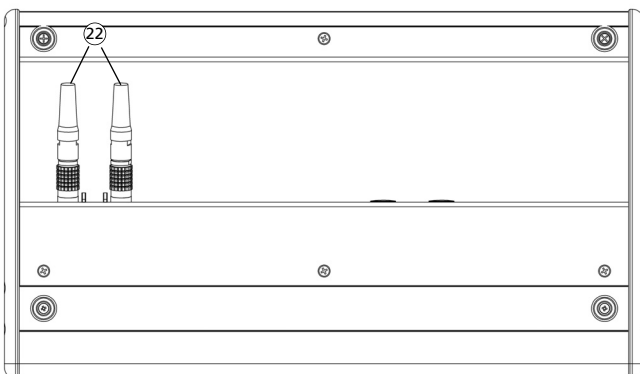

Left hand side

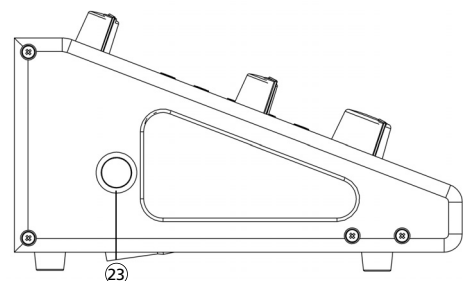

- ① Socket (DIN 45326) to connect a headset or gooseneck microphone.
- ② Monitoring loudspeaker (2-way-loudspeaker system) reproduces the original signal. The loudspeaker is automatically muted as soon as the microphone is activated.
- ③ Volume control for the monitoring loudspeaker
- ④ Bass control to set the low frequencies for the headphones
- ⑤ Treble control to set the high frequencies for the headphones
- ⑥ Volume control for the headphones
- ⑦ Change-over switch RELAY/ORIGINAL. The headphone signal may directly be changed over from the ORIGINAL channel to the RELAY channel.
- ⑧ Relay channel PRE SELECT buttons (left/right)
- ⑨ Display (16 characters / 2 lines)
- ⑩ Relay channel buttons (1-3) to change directly from one selected relay channel to another one.
- ⑪ Output channel PRE SELECT buttons (left/right)
- ⑫ Display (16 characters / 2 lines)
- ⑬ Output channel button A
- ⑭ Output channel button B
- ⑮ Microphone button "TALK". Press the microphone button to turn the microphone on or off.
- ⑯ Cough button "MUTE". Hold down the cough button when you have to interrupt the connection from the interpreter microphone to the output channel briefly. .
- ⑰ CALL button - without any function
- ⑱ TECH button (technician). By pressing the TECH button the interpreter can contact the technician.
- ⑲ PRESIDENT button (chairman). By pressing the PRESIDENT button the interpreter can contact the chairman.
- ⑳ Telephone button - without any function
- ㉑ MENU button to activate special functions
- ㉒ Conference sockets as push-pull version
- ㉓ Headphone socket, 6.35 mm stereo jack, to connect a headphone if you use a microphone connected to the microphone socket instead of a headset. The headphone can also be used in addition to the headset.

Optional: Chip card reader to store individual interpreter settings.

7.4.2 How to program the relay channel buttons 1-3

How to select the relay language channel (PRE-SELECT)

Press the left or right hand PRE SELECT button to scroll through a list of all available relay channels without changing the pre-selected channels! The list is displayed in the top line. The language channels are coded according to the international language codes. When the PRE SELECT button is released, the system time is displayed in the top line of the display.



How to assign a relay channel (1-3)

Press the button and hold it down for assigning the pre-selected relay channel which is displayed in the top line. In this example the Spanish channel (spa) is assigned to the third relay language button.

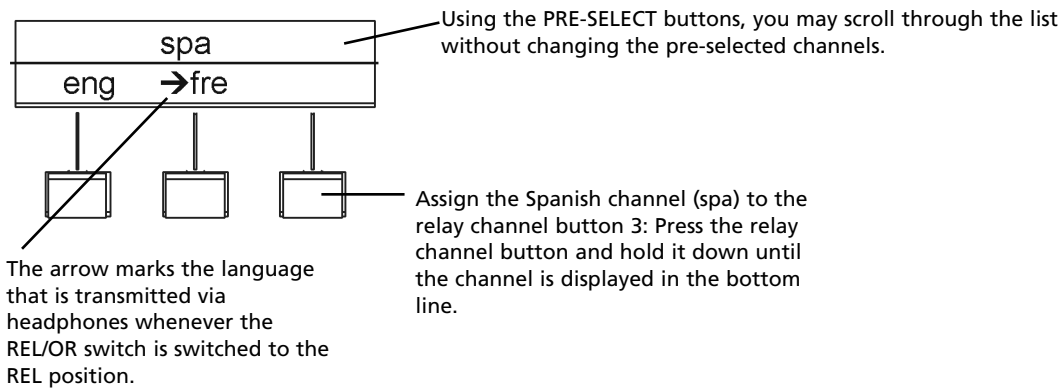

How to switch from relay channel button 2 (fre) to 3 (ger)

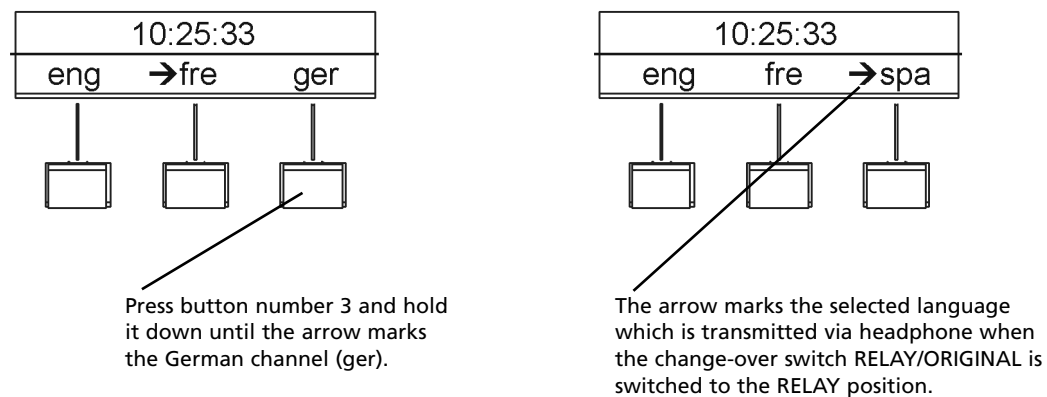

7.4.3 Output channels A and B

Each interpreter station has two buttons for the output channels A and B. The interpreter can directly switch from output A to B, and vice versa. Both channels may be pre-selected. With the PRE SELECT buttons you can select a free output channel. "A" is the default output channel which is automatically defined when the system is started. Press the appropriate output channel button to select channel A or B; the appropriate LED will illuminate. An output channel will be occupied when the microphone is opened!

Whenever a language channel is not occupied, the original signal is automatically transmitted to this channel! If the "LOCK" function has been selected with the iCNS software, occupied output channels of the interpreter stations of different booths are "locked" to avoid double seizure.

7.4.3.1 How to program the output channels A and B

How to select an output channel



Press the left or right PRE SELECT button to scroll through a list of all available output channels. The list is shown in the top line of the display. The language channels are coded according to the international MARC language codes. You may then select and assign a channel out of all available channels.

How to assign an output channel

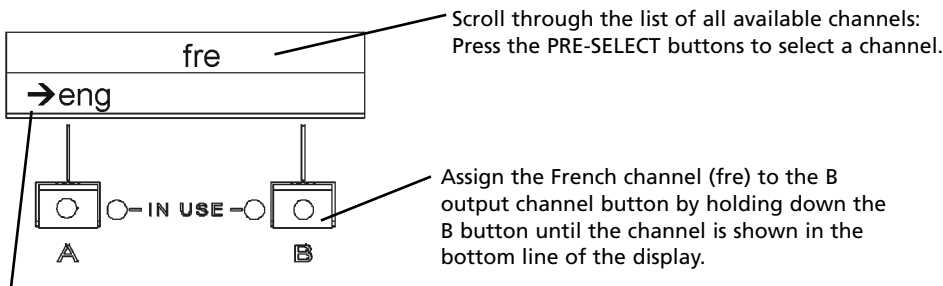

The arrow indicates the selected output channel. A channel is not regarded as "in use" until the microphone is switched on.

Hold down the output channel button for a moment to transmit the pre-selected output channel which will be shown in the top line of the display. In the example above the French channel (fre) is assigned to the output channel button B.

How to change from channel A to B

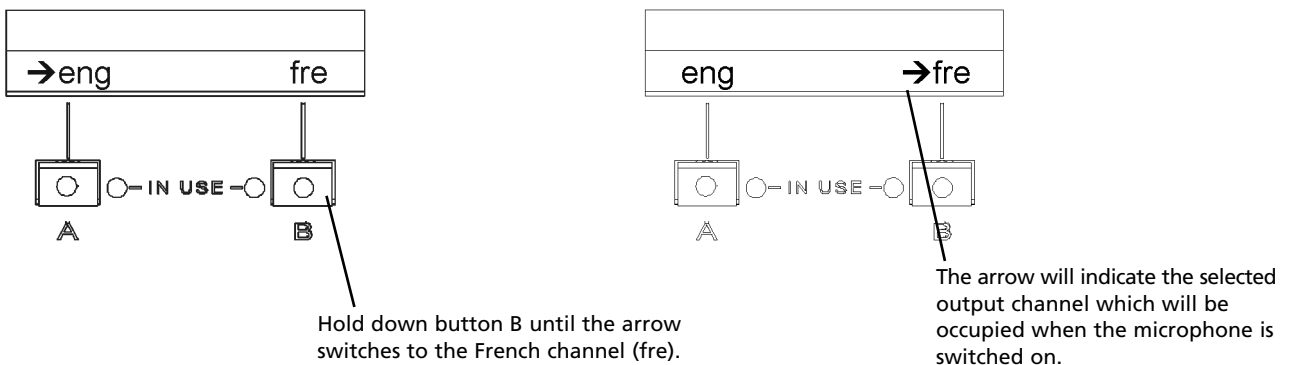

7.4.4 Call buttons

TECH button

Tech  Use the TECH button to contact the technician.

Hold down the button while speaking or listening to the technician.

Note: Only the interpreter can contact the technician, not vice versa.

During the connection the following message will be shown on the right hand side of the display of the MCS-D 202 interpreter station:

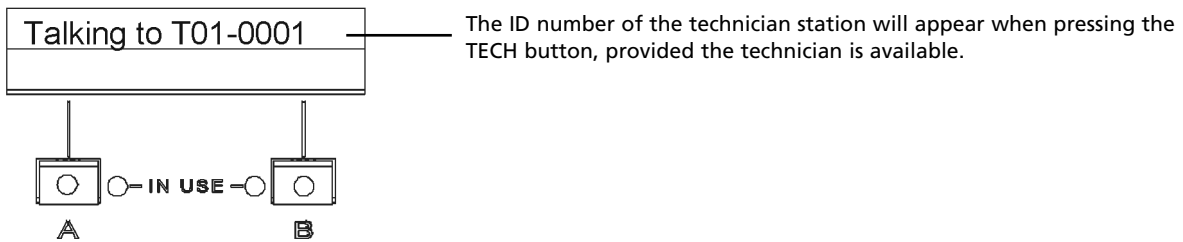

The connection will be interrupted when the TECH button is released.

In the case of no connection when the technician is talking to another interpreter, the following message will be displayed:

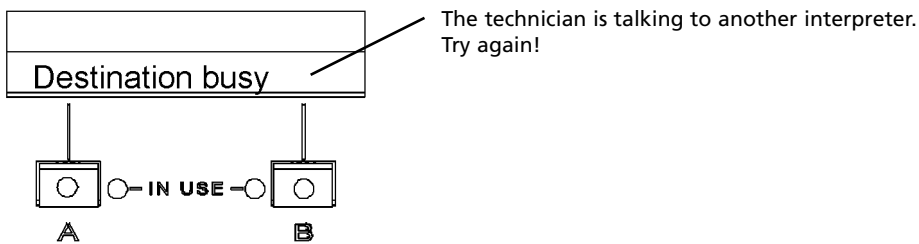

During the connection the technician station will display:

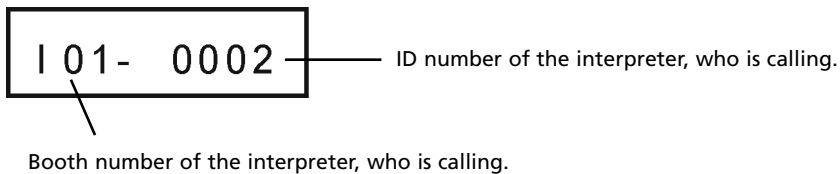

The connection is interrupted when the interpreter releases the TECH button of his MCS-D 202 interpreter station.

Warning:

When the technician turns on his microphone, the connection is terminated.

PRESIDENT button



Use the PRESIDENT button of the MCS-D 202 interpreter station to contact the chairman.

Hold down the button while speaking or listening to the chairman.

Note: Only the interpreter can contact the chairman, not vice versa.

During the connection the following message will be shown on the right hand side of the display of the MCS-D 202 interpreter station:

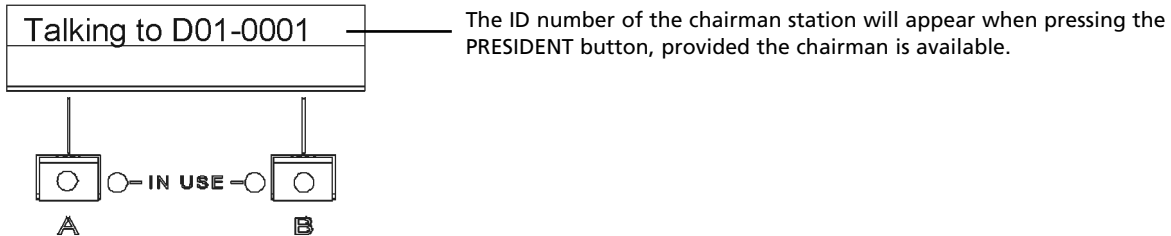

The connection will be interrupted when the PRESIDENT button is released.

In the case of no connection when the chairman is talking to another interpreter, the following message will be displayed:

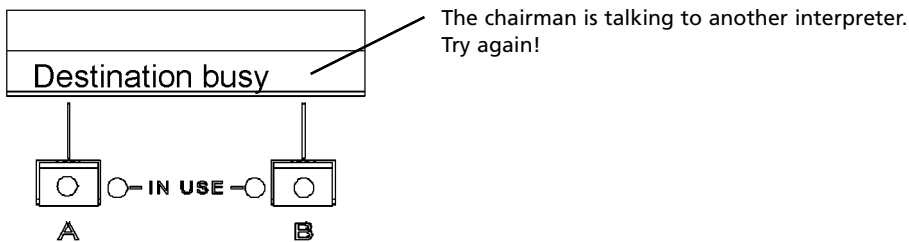

During the connection the chairman station will display:

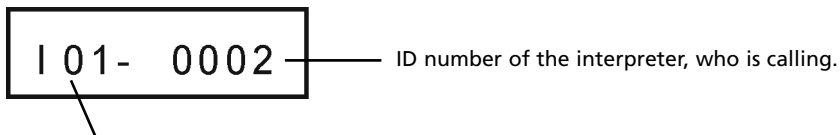

The connection is interrupted when the interpreter releases the PRESIDENT button of his MCS-D 202 interpreter station.

Warning:

When the chairman turns on his microphone, the connection is terminated.

7.4.5 How to assign the interpreter ID

Each interpreter station should be specified with an identification number (ID) in order to render an address. This may be done via the INTERPRETER IDs menu of the MCS-D 200 control unit (refer also to chapter 3.3.8 "Interpreter IDs").

Optional, the identification numbers may directly be assigned at each interpreter station one after the other. This way, you will always have an overview of the system, especially of large systems.

An interpreter station ID (identification number) is composed of the BOOTH ID and the DEVICE ID. Please make sure that every identification number is only assigned once in order to avoid conflicts. Interpreter stations of different booths may have the same DEVICE ID.

For example:

Booth 1: MCS-D 202 microphone station (1): 01-0001

MCS-D 202 microphone station (2): 01-0002

Booth 2: MCS-D 202 microphone station (1): 02-0001

MCS-D 202 microphone station (2): 02-0002

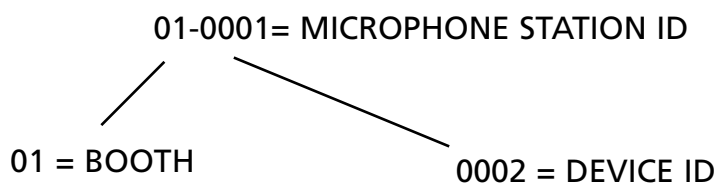

Activate SET ID mode

Press the following three buttons one after the other:

1. Right relay channel PRE-SELECT button
2. Right output channel PRE-SELECT button
3. Press MENU button

1. Press right relay channel PRE-SELECT button

2. Press right output channel PRE-SELECT button

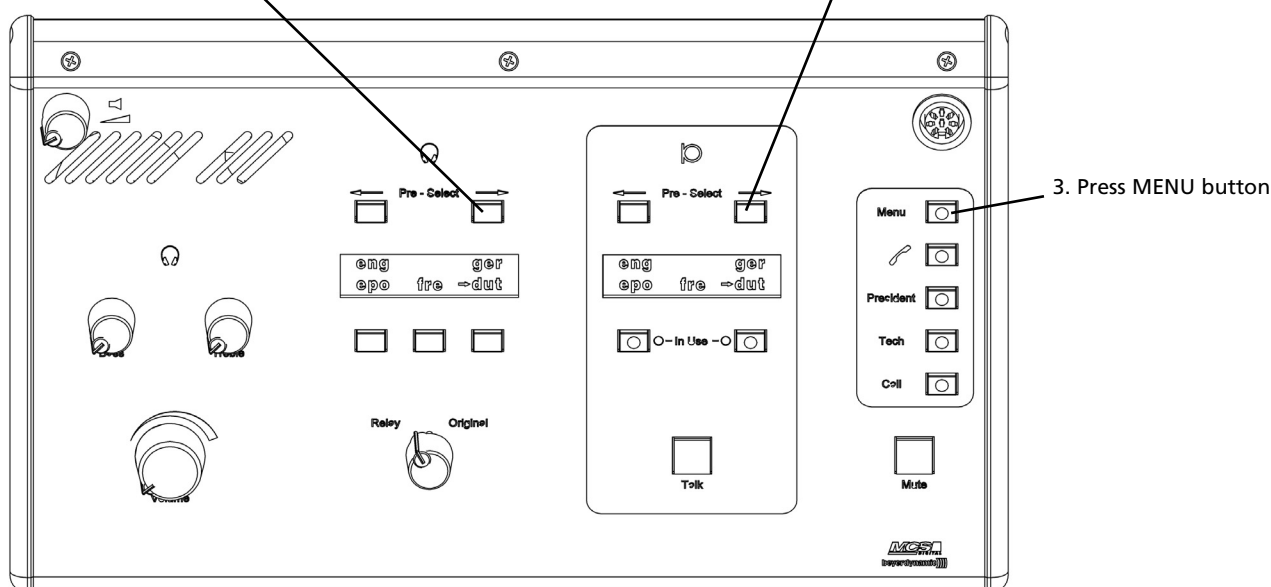

The "SET ID" line appears on the left display.

How to set the ID

The "SET ID" line is displayed.

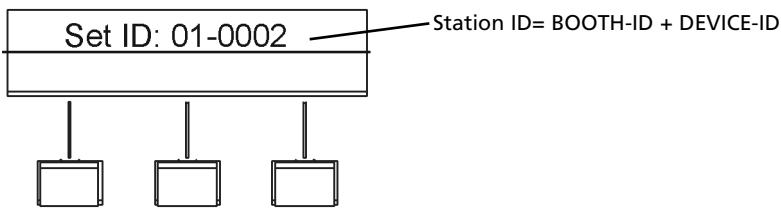

By using the PRE-SELECT buttons you can change the BOOTH ID and the DEVICE ID as described below:

1. BOOTH ID: press left/right relay channel PRE SELECT button
2. DEVICE ID: press left/right output channel PRE SELECT button

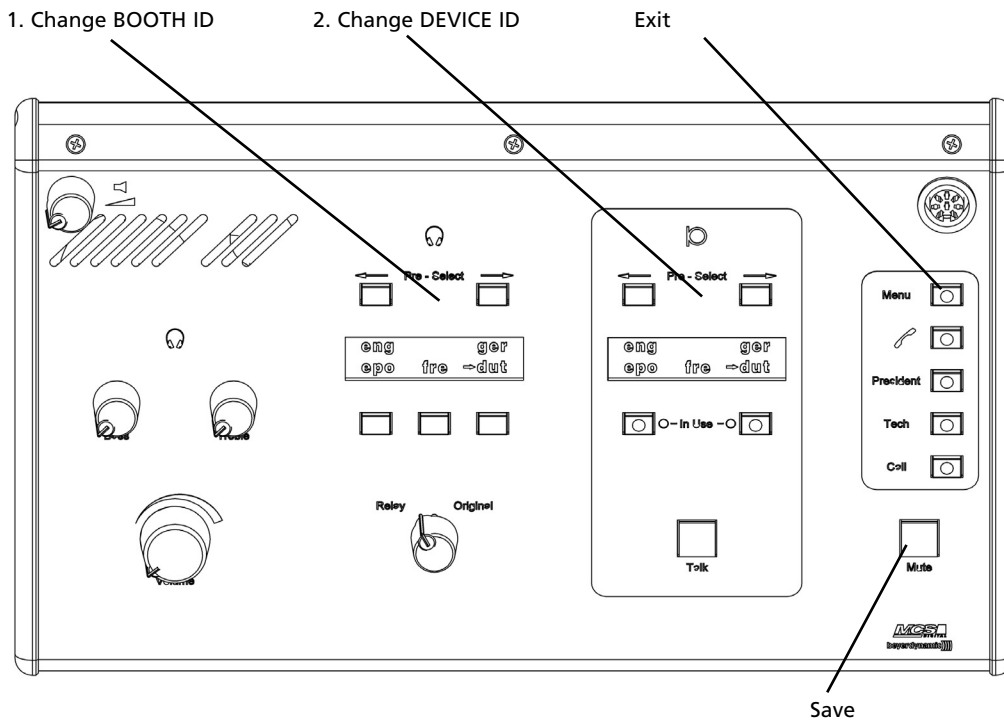

How to save the ID

Press the MUTE button. The interpreter station ID is saved. The ID is shown on the left display.

How to exit the ID mode

Press the MENU button to exit the mode. The ID of the interpreter station is not displayed any more.

7.4.6 How to save settings on a chip card

The following settings can be saved on a chip card after the languages have been programmed (refer to "How to program the relay channel buttons 1-3" and "How to program the output channels A and B").

- Relay channel 1-3 with the channel that is transmitted via headphones whenever the REL/OR switch is switched to REL (arrow marks the channel).
- Output channels A + B with the selected channel that is occupied when the microphone is turned on (arrow marks the channel).

For a later session, simply insert the chip card to retrieve the settings. For this, the following conditions are necessary:

- The MCS-D 202 interpreter station must be configured and the meeting started.
- The language channels must be defined (refer to chapter 3.3.5 "Define Channels") and added to the list of all session channels (refer to chapter 3.3.4.2 "Channel List").
- The system settings always have priority to chip card settings. For example, if channel A or B is locked via iCNS (settings), the channel cannot be de-locked simply by loading the chip card settings.
- **Warning:** The chip card can only be read when the microphone is turned off.

How to put the chip card into the chip card reader

Insert the chip card so that you can read the chip card number.

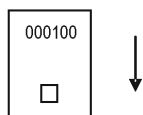

Press the MENU button



How to save the settings

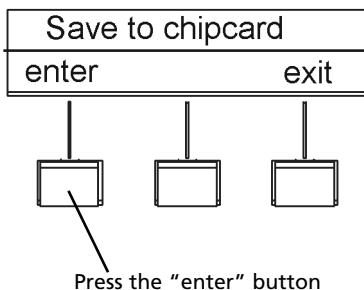

Press the "enter" button to save the settings on the chip card. Overwriting is possible at any time.

7.4.7 How to read the chip card data

Put the chip card into the chip card reader

Insert the chip card so that you can read the chip card number.

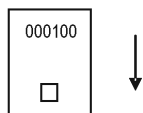

Warning:

The chip card can only be read when the microphone is turned off.

8. Examples

Single-sided powering of the microphone stations which are set up as a branch

Please calculate the maximum cable length. We recommend using our standard cables.



MCS-D 200

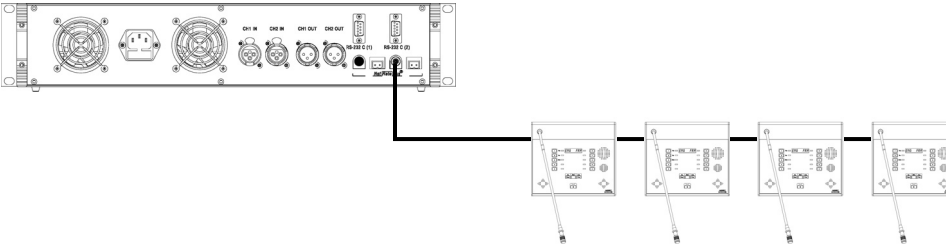

Inserting devices at any location

Devices such as microphone stations, interpreter stations and digital / analogue interfaces are inserted at any location of the system.



MCS-D 200

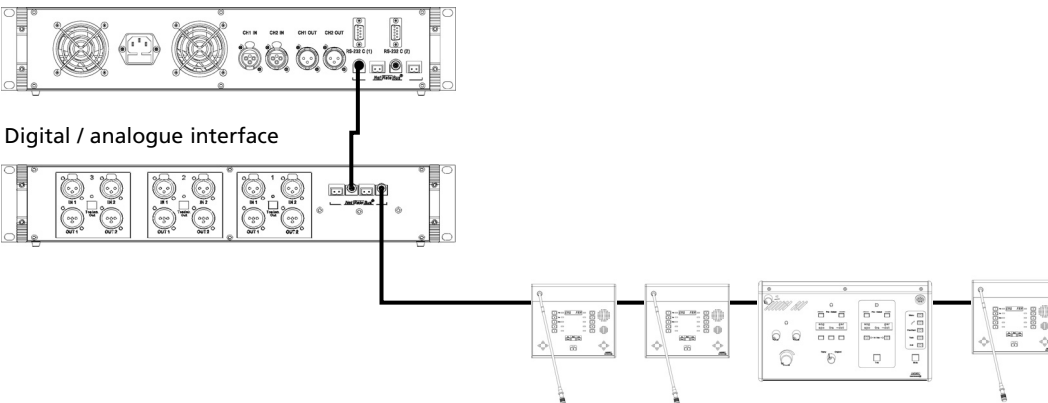

MCS-D 200

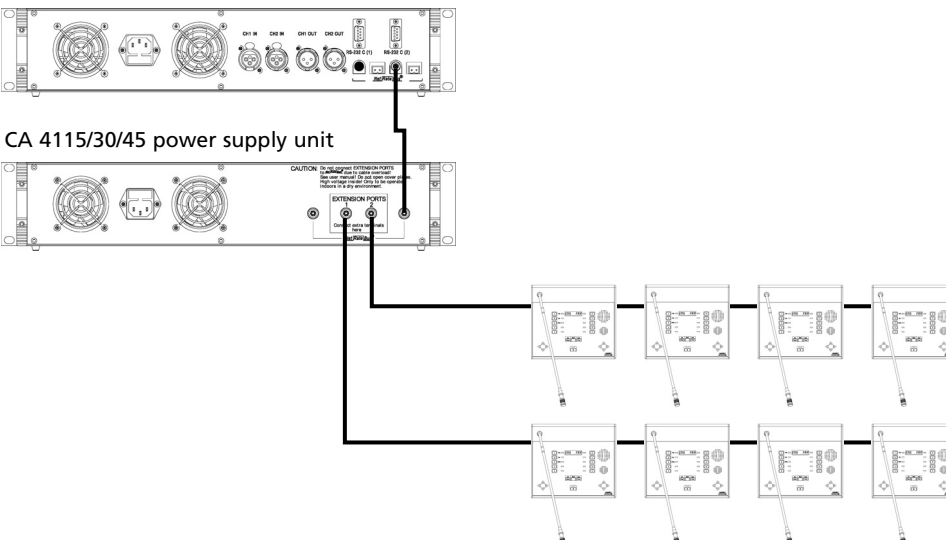

Additional power supply units for branches

MCS-D 200 control unit (1 integrated power supply = 2 A) for approx. 15 devices
 MCS-D 200 control unit option A (2 intergrated power supplies = 4 A). for approx. 30 devices

To expand the system:

CA 4115 power supply unit (1 integrated power supply = 2 A) for approx. 15 devices
 CA 4130 power supply unit (2 integrated power supplies = 4 A) for approx. 30 devices
 CA 4145 power supply unit (3 integrated power supplies = 6 A) for approx. 45 devices

Connect the control unit and the power supply unit with each other via the NetRateBus sockets.
 Connect all devices consuming power (microphone stations, interpreter stations, digital / analogue interfaces and adapters) to the EXTENSION PORTS.

MCS-D 200

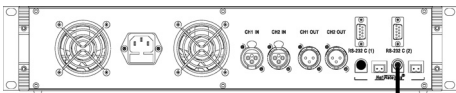

CA 4115/30/45 power supply unit

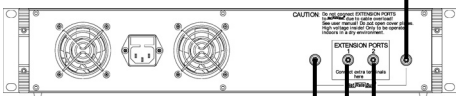

CA 4115/30/45

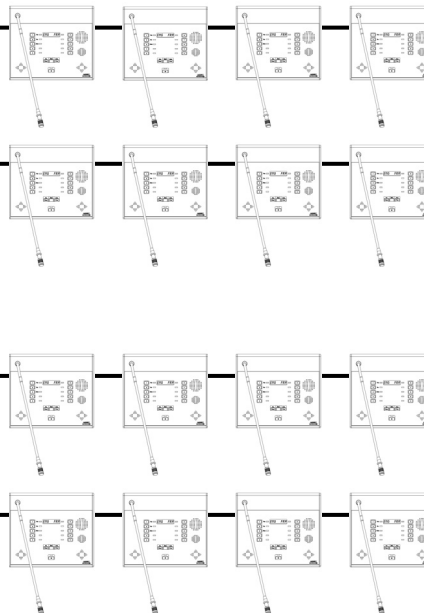
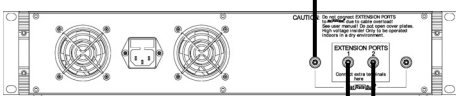

System Setup

Setup of the microphone stations in a circle

With redundancy i.e. powering the microphone stations on both sides, any cable of the circle can be removed during operation without interrupting the meeting. All microphone stations are then powered on one side. In this way a microphone station can be replaced during operation for example.

A condition for redundancy is that all cable lengths had been selected in a way that a single-sided powering could cover the power requirement.

MCS-D 200

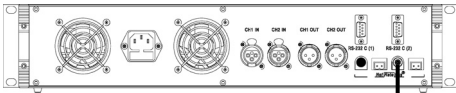

CA 4115/30/45 power supply unit

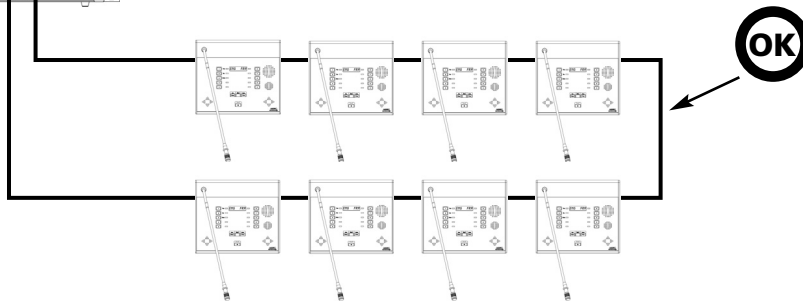
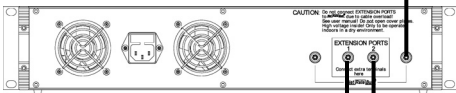

Additional power supply units when the microphone units are set up in a circle

With redundancy i.e. powering the microphone stations on both sides, any cable of the circle can be removed during operation without interrupting the meeting. All microphone stations are then powered on one side. In this way a microphone station can be replaced during operation for example.

A condition for redundancy is that all cable lengths had been selected in a way that a single-sided powering could cover the power requirement.

MCS-D 200

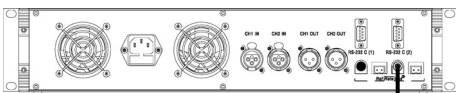

CA 4115/30/45 power supply unit

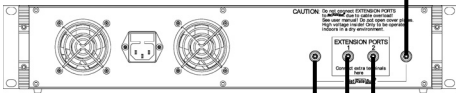

CA 4115/30/45

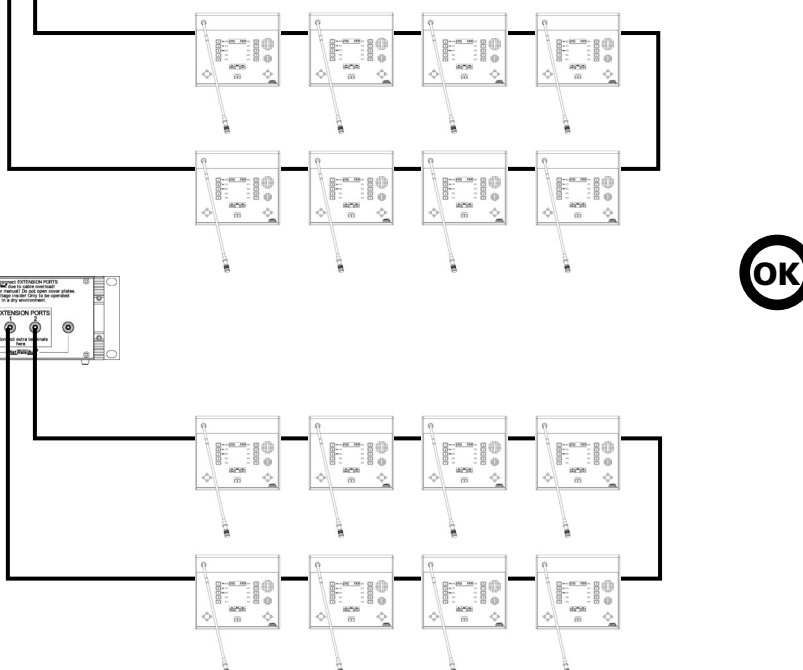
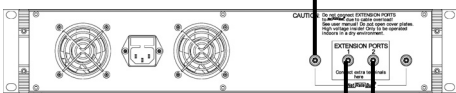

Set up the microphone stations as a branch or in a circle.

The microphone stations are connected to the Extension Ports of the power supply units as a branch or in a circle.

MCS-D 200

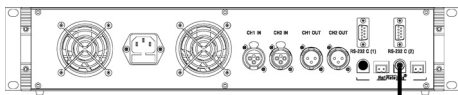

CA 4115/30/45 power supply unit

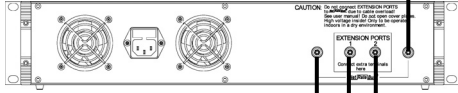

CA 4115/30/45 power supply unit

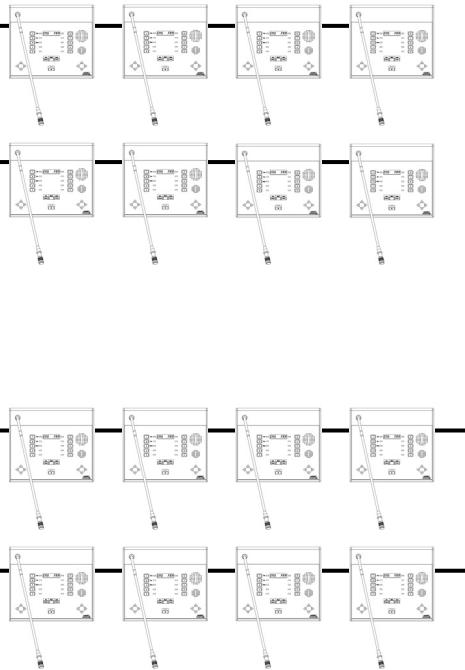
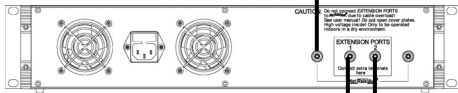

System Setup

Do not link branches, which are powered by different power supply units!

Warning:

Never link branches, which are powered by different power supply units. This could lead to an overload of the cable and cause short circuits and cable fire.

MCS-D 200

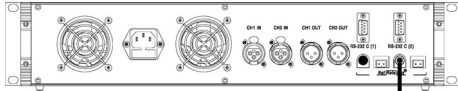

CA 4115/30/45 power supply unit

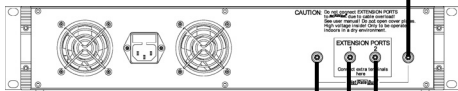

CA 4115/30/45 power supply unit

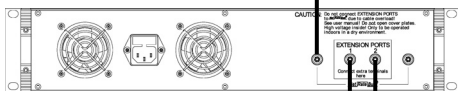

**NOT ALLOWED!
Overload of the cable!**



How to connect a power supply unit to the Extension Port

Note:

In this setup the connected power supply unit no. 3 does only work when the power supply unit no. 2 is also turned on.

MCS-D 200

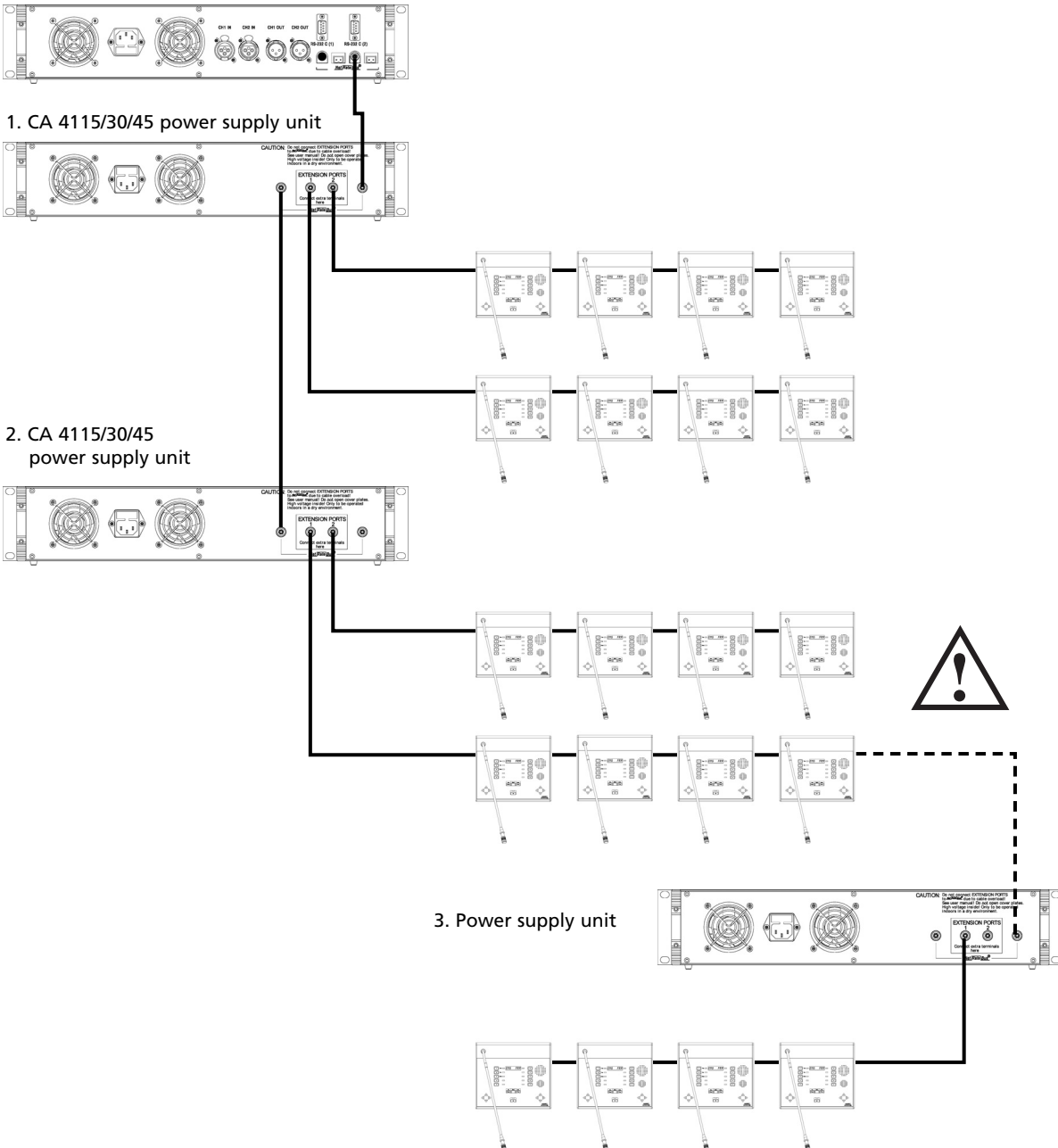

Setup of the system with microphone stations and interpreter stations

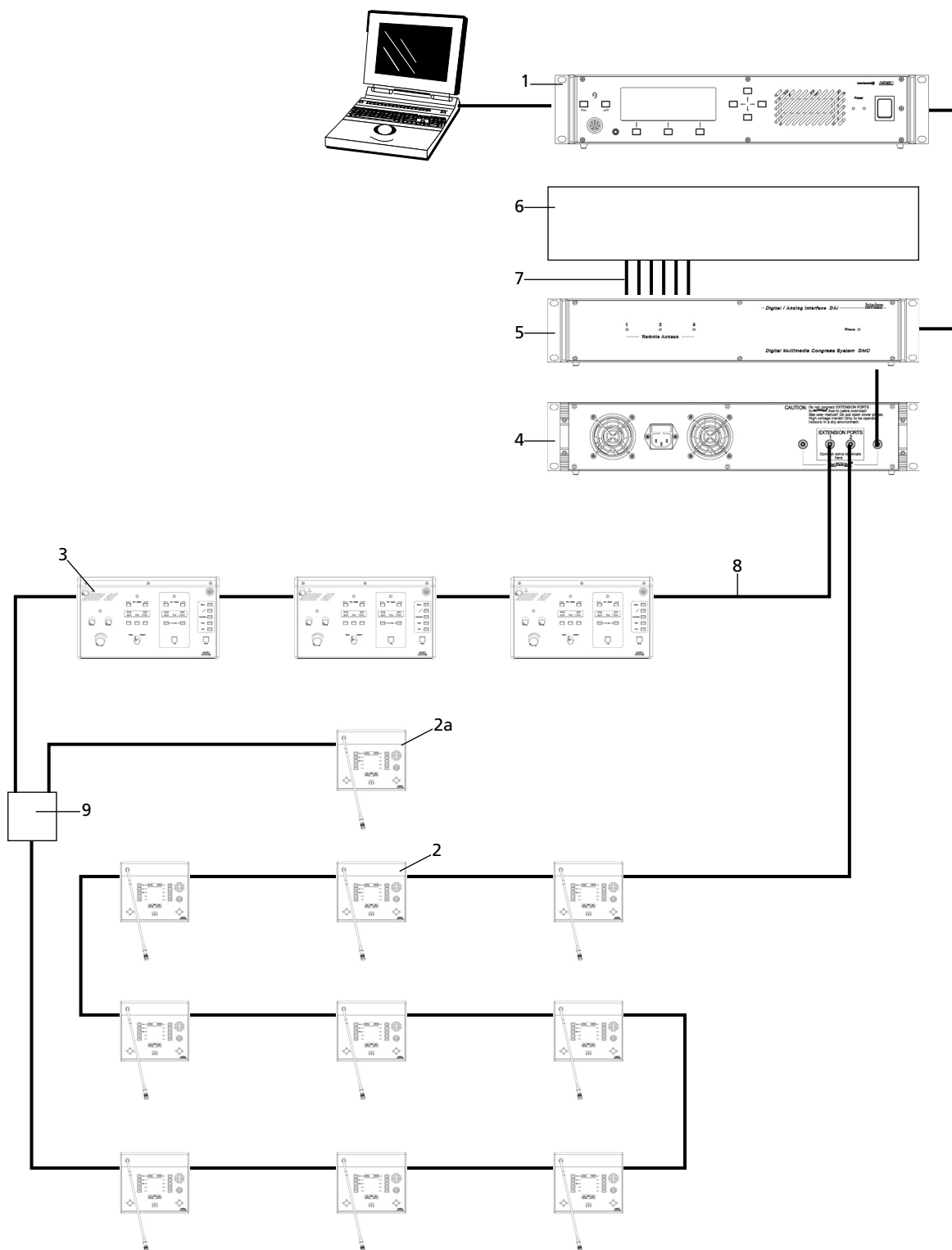

- 1 MCS-D 200 control unit (push-pull socket)
- 2 MCS-D 2073 delegate station (push-pull sockets, 2 language selectors, 1 microphone, 2 headphones)
- 2a MCS-D 2073 delegate station as chairman station with PRIORITY and CANCEL buttons (configuration via MCS-D 200 control unit), 1 language selector, microphone and headphone
- 3 MCS-D 202 interpreter station, headset (or microphone and headphone)
- 4 CA 4145 (6A) power supply unit
- 5 CA 4566 digital / analog interface (6 in / 6 out)
- 6 CT 316 stationary transmitter for additional receivers
- 7 Cable
- 8 CA 4302 conference cable (2 m, push-pull)
- 9 CA 4213 adapter

System components

Version with push-pull connections

1	MCS-D 200 control unit (with modular power supply for approx. 15, optional 30 microphone stations)	1 x for 1,400 delegate and interpreter stations. Division into several meetings, which are simultaneously operated by 1 MCS-D 200 (only with iCNS software)
2	(Extension) CA 4115 power supply unit (1 modular integrated power supply = 2 A) CA 4130 power supply unit (2 modular integrated power supplies = 4 A) CA 4145 power supply unit (3 modular integrated power supplies = 6 A)	for approx. 15 microphone stations for approx. 30 microphone stations for approx. 45 microphone stations
3	Delegate station	up to 1,400 delegate and interpreter stations per MCS-D 200 control unit
4	Microphone	1 x per MCS-D 2073 delegate station
5	MCS-D 202 interpreter station	at least 1 per interpreter
6	Microphone and headphone or headset	1 x per MCS-D 202 interpreter station

MultiSession Management

All microphone stations in Session 1

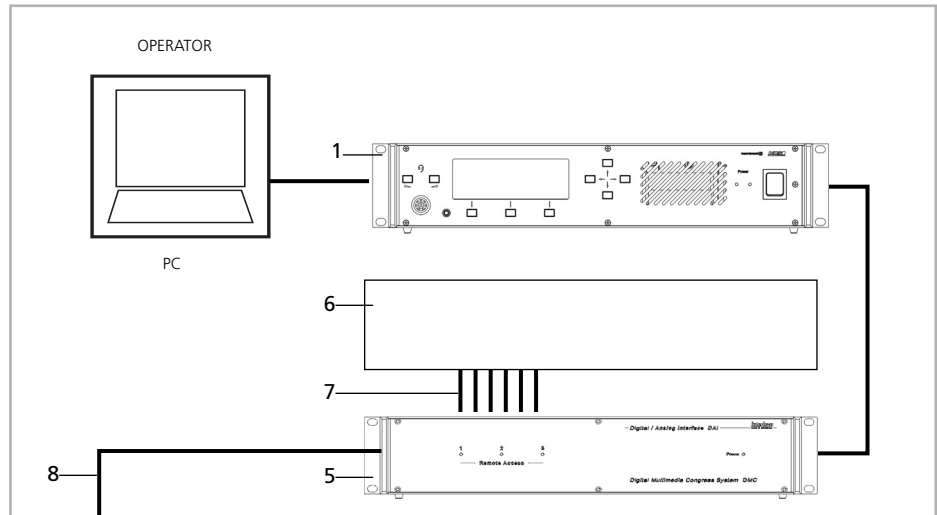

SESSION 1

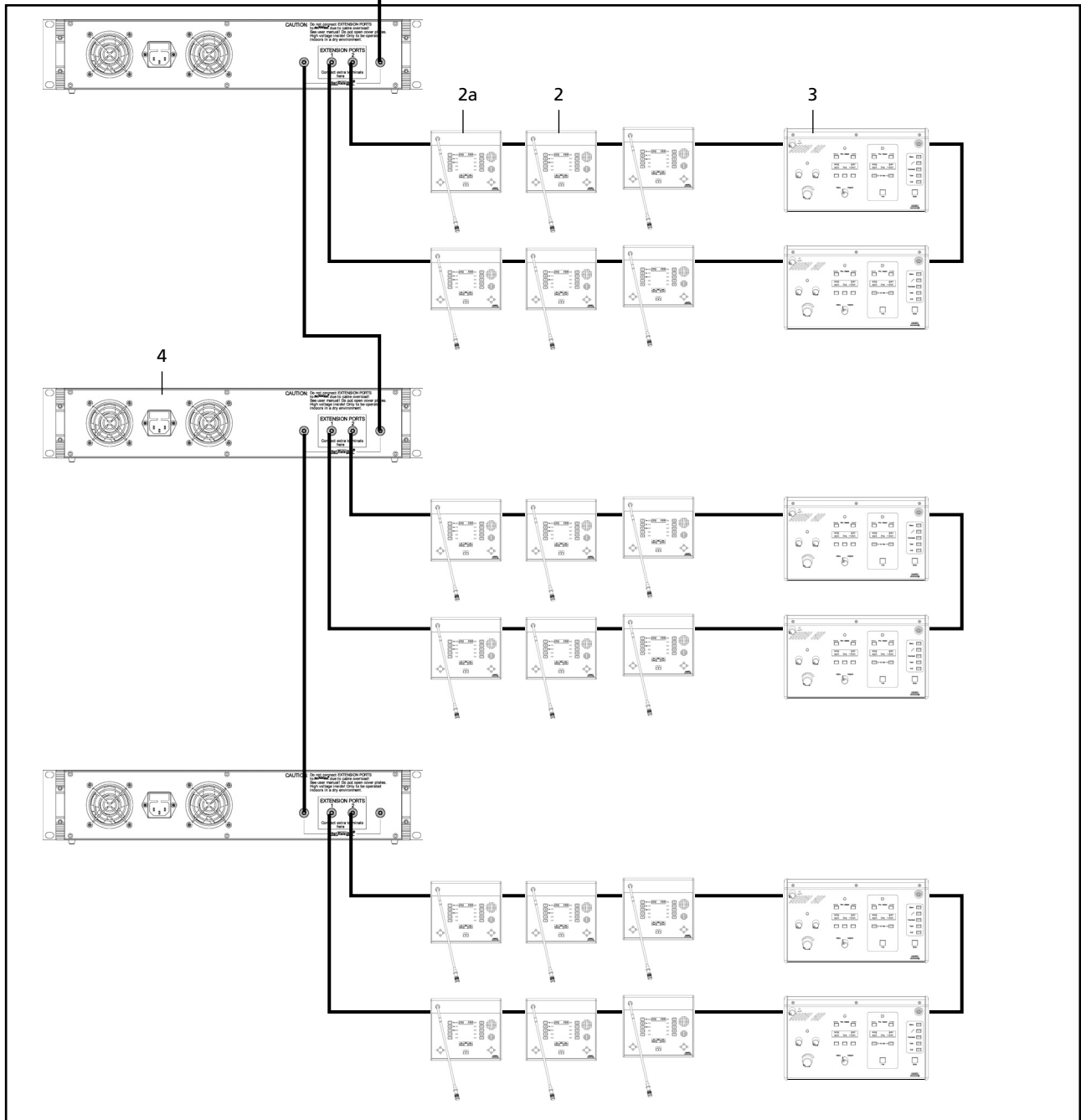

- 1 MCS-D 200 control unit (push-pull sockets)
- 2 MCS-D 2073 delegate station (push-pull sockets, 2 language selectors, 1 microphone, 2 headphones)
- 2a MCS-D 2073 delegate station as chairman station with PRIORITY and CANCEL functions (configuration via the MCS-D 200 control unit), 1 language selector, microphone and headphone
- 3 MCS-D 202 interpreter station, headset (or microphone and headphone)
- 4 CA 4145 power supply unit (6A)
- 5 CA 4566 digital / analogue interface (6 in/ 6 out)
- 6 CT 316 stationary transmitter for additional receivers
- 7 Cable
- 8 CA 4302 conference cable (2 m, push-pull)

MultiSession Management

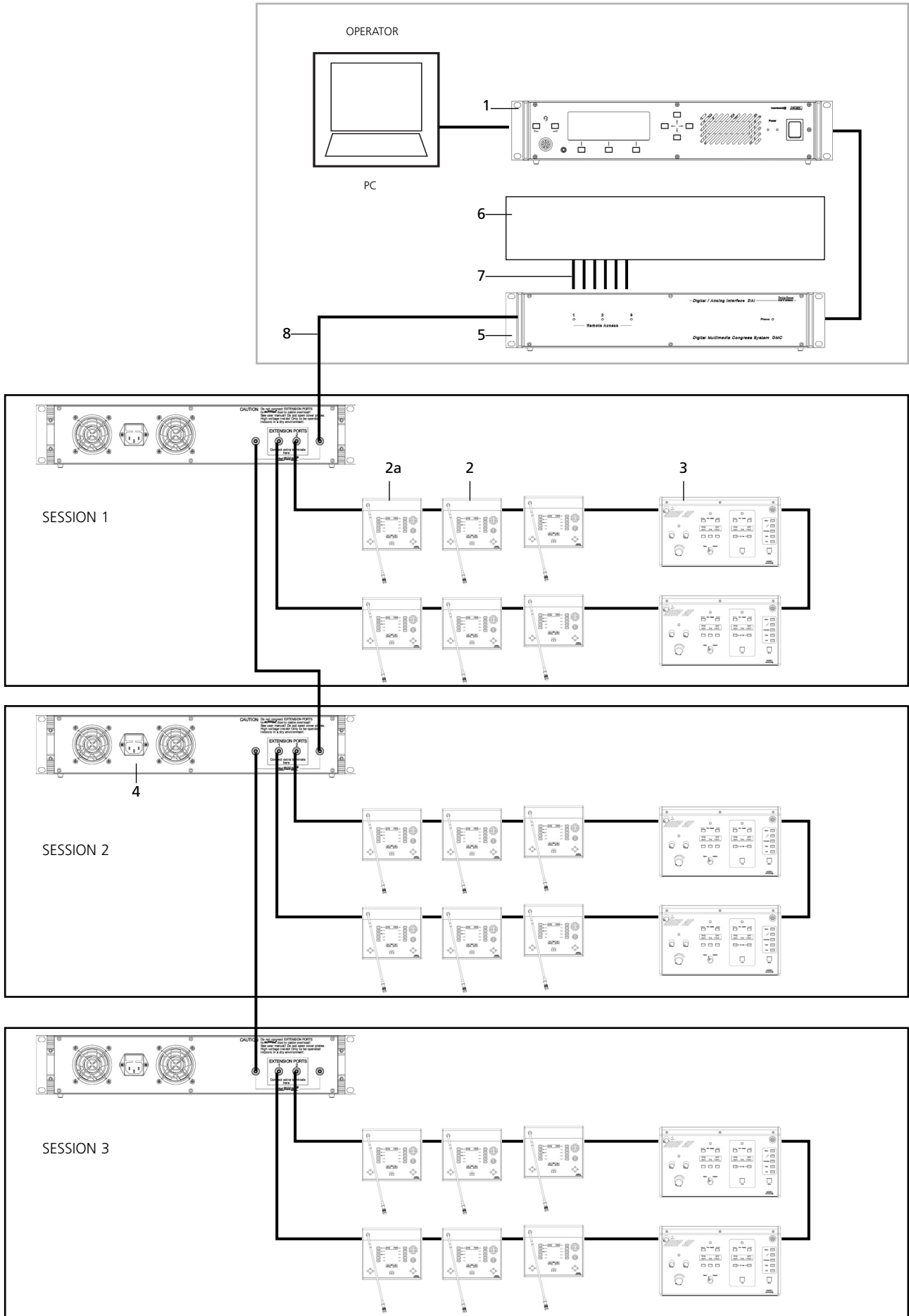

MultiSession Management:

Several meetings can be simultaneously controlled by one MCS-D 200 control unit and the iCNS software. The individual conference rooms are combined to one large group (fig. 3b) or one large conference room (fig. 3a). For this only software settings are changed.

- 1 MCS-D 200 control unit (push-pull socket)
- 2 MCS-D 2073 delegate station (push-pull sockets, 2 language selectors, 1 microphone, 2 headphones)
- 2a MCS-D 2073 delegate station as chairman station with PRIORITY and CANCEL functions (configuration via the MCS-D 200),
1 language selector, microphone and headphone
- 3 MCS-D 202 interpreter stations, headset (or microphone and headphone)
- 4 CA 4145 power supply unit (6A)
- 5 CA 4566 digital / analogue interface (6 in / 6 out)
- 6 CT 316 stationary transmitter for additional receivers
- 7 Cable
- 8 CA 4302 conference cable (2 m, push-pull)

9. Components

MCS-D 200	Digital control unit	Order # 483.060
MCS-D 202	Interpreter station	Order # 482.943
MCS-D 2073	Delegate/chairman station	Order # 483.044
MCS-D 2074	Service station	Order # 483.052
MCS-D 3121	Revoluto delegate station	Order # 484.318
MCS-D 3123	Revoluto chairman station	Order # 483.079
MCS-D 3171	Revoluto delegate station with display, voting buttons and navigator buttons.	Order # 484.695
MCS-D 3171 H	same as above, but with NetRateBus sockets at the bottom side	Order # 484.830
MCS-D 3173	Revoluto chairman station with display, voting buttons and navigator buttons	Order # 483.087
MCS-D 3173 H	same as above, but with NetRateBus sockets at the bottom side	Order # 484.849

10. Optional Accessories

CA 4100	Internal additional power supply unit for the control unit to supply another 15 microphone stations via NetRateBus	Order # 483.583
CA 4115	Power supply unit with an integrated modular power supply, for 15 microphone stations, 4 push-pull connections, 19" housing, 2 U	Order # 483.184
CA 4130	Power supply unit with two integrated modular power supplies, for 30 microphone stations, 4 push-pull connections, 19" housing, 2 U	Order # 483.192
CA 4145	Power supply unit with two integrated modular power supplies, for 45 microphone stations, 4 push-pull connections, 19" housing, 2 U	Order # 483.206
CA 4210	Digital monitor switch, 2 push-pull connections	Order # 483.214
CA 4212	Digital repeater, 2 push-pull connections	Order # 483.222
CA 4213	Digital T-Adapter, 3 push-pull connections	Order # 483.230
CA 4214	Digital X-Adapter, 4 push-pull connections.	Order # 483.249
CA 4222	Digital repeater with DC connection, 2 push-pull connections	Order # 483.265
CA 4223	Digital T-Adapter with DC connection, 3 push-pull connections.	Order # 483.273
CA 4224	Digital X-Adapter with DC connection, 4 push-pull connections	Order # 483.281
CA 4231	Network connection plate with push-pull socket and 0.5 m connecting cable with female push-pull connection	Order # 483.303
CA 4235	6-pin network plug, push-pull	Order # 483.311
CA 4236	6-pin network socket, push-pull.	Order # 483.338
CA 4300	NetRateBus conference network cable per metre for installations	Order # 483.354
CA 4302	NetRateBus conference network cable, push-pull connector, length 2 m	Order # 483.361
CA 4305	NetRateBus conference network cable, push-pull connector, length 5 m	Order # 483.370
CA 4310	NetRateBus conference network cable, push-pull connector, length 10 m	Order # 483.389
CA 4320	NetRateBus conference network cable, push-pull connector, length 20 m	Order # 483.397
CA 4399	NetRateBus conference network cable, push-pull connector, length on customer's request.	Order # 483.400
CA 4522	Digital/analogue audio interface, 2 x XLR IN, 2 x XLR OUT, 2 push-pull connections, 19" housing, 2 U	Order # 483.419
CA 4544	Digital/analogue audio interface, 4 x XLR IN, 4 x XLR OUT, 2 push-pull connections, 19" housing, 2 U	Order # 483.427
CA 4566	Digital/analogue audio interface, 6 x XLR IN, 6 x XLR OUT, 2 push-pull connections, 19" housing, 2 U	Order # 483.435
CA 4710	Chip card for microphone station	Order # 483.451
CA 4715	Telephone for MCS-D microphone stations.	Order # 483.478
CA 4771	Chip card reader for MCS-D 2073	Order # 483.532
CA 4772	Voice control for MCS-D 2073	Order # 483.540
CA 4773	Second language selector for MCS-D 2073 instead of integrated loudspeaker.	Order # 483.559
CA 4775	Transport case for 10 MCS-D 2073 microphone stations incl. accessories (cables and microphones).	Order # 483.036
iCNS	Basic Software Module for MS Windows, incl. Conference and Ressources Manager, Data bank and participants list, conference pre-configuration, conference data display	Order # 483.591
iCNS	Optional module for votings	Order # 483.605
iCNS	Optional module for agenda operation	Order # 483.613
iCNS	Optional module for chip card ID operation	Order # 483.621
iCNS	Optional module for messaging	Order # 483.648

11. List of Language Codes

This is a list of language codes. You will find the web version under: <http://lcweb.loc.gov/marc/languages/>.

Refer also to: <http://www.ethnologue.com/iso639/codes.asp>:

aar	Afar	cau	Caucasian (Other)	fiu	Finno-Ugrian (Other)
abk	Abkhaz	ceb	Cebuano	fon	Fon
ace	Achinese	cel	Celtic (Other)	fre	French
ach	Acoli	cha	Chamorro	-fri	Frisian
ada	Adangme	chb	Chibcha	fry	Frisian
afa	Afroasiatic (Other)	che	Chechen	ful	Fula
afh	Afrihili (Artificial language)	chg	Chagatai	fur	Friulian
afr	Afrikaans	chi	Chinese		
-ajm	Aljamía	chk	Truk	gaa	Gã
aka	Akan	chm	Mari	-gae	Scottish Gaelic
akk	Akkadian	chn	Chinook jargon	-gag	Galician
alb	Albanian	cho	Choctaw	-gal	Oromo
ale	Aleut	chp	Chipewyan	gay	Gayo
alg	Algonquian (Other)	chr	Cherokee	gba	Gbaya
amh	Amharic	chu	Church Slavc	gem	Germanic (Other)
apa	Apache languages	chv	Chuvash	geo	Georgian
ara	Arabic	chy	Cheyenne	ger	German
arc	Aramaic	cmc	Chamic languages	gez	Ethiopic
arm	Armenian	cop	Coptic	gil	Gilbertese
arn	Mapuche	cor	Cornish	gla	Scottish Gaelic
arp	Arapaho	cos	Corsican	gle	Irish
art	Artificial (Other)	cpe	Creoles and Pidgins, English-based (Other)	glg	Galician
arw	Arawak	cpf	Creoles and Pidgins, French-based (Other)	glv	Manx
asm	Assamese	cpp	Creoles and Pidgins, Portuguese-based (Other)	gon	Gondi
ath	Athapascan (Other)			gor	Gorontalo
aus	Australian languages	cre	Cree	got	Gothic
ava	Avaric	crp	Creoles and Pidgins (Other)	grb	Grebo
ave	Avestan			grn	Guarani
awa	Awadhi			-gua	Guarani
aym	Aymara			guj	Gujarati
aze	Azerbaijani			gwi	Gwich'in
		cus	Cushitic (Other)		
		cze	Czech	hai	Haida
bad	Banda			hau	Hausa
bai	Bamileke languages			hav	Hawaiian
bak	Bashkir	dak	Dakota	heb	Hebrew
bal	Baluchi	dan	Danish	her	Herero
bam	Bambara	day	Dayak	hil	Hiligaynon
ban	Balinese	del	Delaware	him	Himachali
baq	Basque	den	Slave	hin	Hindi
bas	Basa	dgr	Dogrib	hit	Hittite
bat	Baltic (Other)	din	Dinka	hmn	Hmong
bej	Beja	div	Divehi	hmo	Hiri Motu
bel	Belarusian	doi	Dogri	hun	Hungarian
bem	Bemba	dra	Dravidian (Other)	hup	Hupa
ben	Bengali	dua	Duala		
ber	Berber (Other)	dut	Dutch	iba	Iban
bho	Bhojpuri	dyu	Dyula	ibo	Igbo
bih	Bihari	dzo	Dzongkha	ice	Icelandic
bik	Bikol			ijo	Ijo
bin	Bini	efi	Efik	iku	Inuktitut
bis	Bislama	egy	Egyptian	ile	Interlingue
bla	Siksika	eka	Ekajuk	ilo	Iloko
bnt	Bantu (Other)	elx	Elamite	inc	Indic (Other)
bos	Bosnian	eng	English	ind	Indonesian
bra	Braj	epo	Esperanto	ine	Indo-European (Other)
bre	Breton	-esk	Eskimo languages	ipk	Inupiaq
btk	Batak	-esp	Esperanto	ira	Iranian (Other)
bua	Buriat	est	Estonian	-iri	Irish
bug	Bugis	-eth	Ethiopic	iro	Iroquoian (Other)
bul	Bulgarian	ewe	Ewe	ita	Italian
bur	Burmese	ewo	Ewondo		
				jav	Javanese
cad	Caddo	fan	Fang	jpn	Japanese
cai	Central American Indian (Other)	fao	Faroese	jpr	Judeo-Persian
		-far	Faroese	jrb	Judeo-Arabic
-cam	Khmer	fat	Fanti		
car	Carib	fij	Fijian		
cat	Catalan	fin	Finnish	kaa	Kara-Kalpak

Language Codes

kab	Kabyle	mlt	Maltese	sah	Yakut
kac	Kachin	mnc	Manchu	sai	South American Indian (Other)
kal	Kalâtdlisut	mni	Manipuri	sal	Salishan languages
kam	Kamba	mno	Manobo languages	sam	Samaritan Aramaic
kan	Kannada	moh	Mohawk	san	Sanskrit
kar	Karen	mol	Moldavian	-sao	Samoa
kas	Kashmiri	mon	Mongolian	sas	Sasak
kau	Kanuri	mos	Mooré	sat	Santali
kaw	Kawi	mul	Multiple languages	scc	Serbian
kaz	Kazakh	mun	Munda (Other)	sco	Scots
kha	Khasi	mus	Creek	scr	Croatian
khi	Khoisan (Other)	mwr	Marwari	sel	Selkup
khm	Khmer	myn	Mayan languages	sem	Semitic (Other)
kho	Khotanese			sgn	Sign languages
kik	Kikuyu	nah	Nahuatl	shn	Shan
kin	Kinyarwanda	nai	North American Indian (Other)	-sho	Shona
kir	Kyrgyz	nau	Nauru	sid	Sidamo
kmb	Kimbundu	nav	Navajo	sin	Sinhalese
kok	Konkani	nbl	Ndebele (South Africa)	sio	Siouan (Other)
kom	Komi	nde	Ndebele (Zimbabwe)	sit	Sino-Tibetan (Other)
kon	Kongo	ndo	Ndonga	sla	Slavic (Other)
kor	orean	nep	Nepali	slo	Slovak
kos	Kusaie	new	Newari	slv	Slovenian
kpe	Kpelle	nia	Nias	sme	Northern Sami
kro	Kru	nic	Niger-Kordofanian (Other)	smi	Sami
kru	Kurukh	niu	Niuean	smo	Samoa
kua	Kuanyama	non	Old Norse	sna	Shona
kum	Kumyk	nor	Norwegian	snd	Sindhi
kur	Kurdish	nso	Northern Sotho	-snh	Sinhalese
-kus	Kusaie	nub	Nubian languages	snk	Soninke
kut	Kutenai	nya	Nyanja	sog	Sogdian
		nym	Nyamwezi	som	Somali
lad	Ladino	nyn	Nyankole	son	Songhai
lah	Lahnda	nyo	Nyoro	sot	Sotho
lam	Lamba	nzi	Nzima	spa	Spanish
lao	Lao			srd	Sardinian
-lap	Sami	oji	Ojibwa	srr	Serer
lat	Latin	ori	Oriya	ssa	Nilo-Saharan (Other)
lav	Latvian	orm	Oromo	-sso	Sotho
lez	Lezgian	osa	Osage	ssw	Swazi
lin	Lingala	oss	Ossetic	suk	Sukuma
lit	Lithuanian	ota	Turkish, Ottoman	sun	Sundanese
lol	Mongo-Nkundu	oto	Otomian languages	sus	Susu
loz	Lozi			sux	Sumerian
ltz	Letzeburgesch	paa	Papuan (Other)	swa	Swahili
lua	Luba-Lulua	pag	Pangasinan	swe	Swedish
lub	Luba-Katanga	pal	Pahlavi	-swz	Swazi
lug	Ganda	pam	Pampang	syr	Syriac
lui	Luiseño	pan	Panjabi		
lun	Lunda	pap	Papiamento	-tag	Tagalog
luo	Luo (Kenya and Tanzania)	pau	Palauan	tah	Tahitian
lus	Lushai	per	Persian	tai	Tai (Other)
		phi	Philippine (Other)	-taj	Tajik
mac	Macedonian	phn	Phoenician	tam	Tamil
mad	Madurese	pli	Pali	-tar	Tatar
mag	Magahi	pol	Polish	tat	Tatar
mah	Marshall	pon	Ponape	tel	Telugu
mai	Maithili	por	Portuguese	tem	Temne
mak	Makasar	pra	Prakrit languages	ter	Terena
mal	Malayalam	pus	Pushto	tet	Tetum
man	Mandingo			tgk	Tajik
mao	Maori	que	Quechua	tgl	Tagalog
map	Austronesian (Other)			tha	Thai
mar	Marathi	raj	Rajasthani	tib	Tibetan
mas	Masai	rap	Rapanui	tig	Tigré
-max	Manx	rar	Rarotongan	tir	Tigrinya
may	Malay	roa	Romance (Other)	tiv	Tiv
mdr	Mandar	roh	Raeto-Romance	tkl	Tokelauan
men	Mende	rom	Romany	tli	Tlingit
mic	Micmac	rum	Romanian	tmh	Tamashek
min	Minangkabau	run	Rundi	tog	Tonga (Nyasa)
mis	Miscellaneous languages	rus	Russian	ton	Tongan
mkh	Mon-Khmer (Other)			tpi	Tok Pisin
-mla	Malagasy	sad	Sandawe	-tru	Truk
mlg	Malagasy	sag	Sango	tsi	Tsimshian

tsn	Tswana	vai	Vai	ypk	Yupik languages
tso	Tsonga	ven	Venda		
-tsw	Tswana	vie	Vietnamese	zap	Zapotec
tuk	Turkmen	vol	Volapük	zen	Zenaga
tum	Tumbuka	vot	Votic	zha	Zhuang
tur	Turkish			znd	Zande
tut	Altaic (Other)	wak	Wakashan languages	zul	Zulu
tvh	Tuvaluan	wal	Walamo		
twi	Twi	war	Waray		
tyv	Tuvinian	was	Washo		
		wel	Welsh		
uga	Ugaritic	wen	Sorbian languages		
uig	Uighur	wol	Wolof		
ukr	Ukrainian	xho	Xhosa		
umb	Umbundu				
und	Undetermined	yao	Yao		
urd	Urdu	yap	Yapese		
uzb	Uzbek	yid	Yiddish		
		yor	Yoruba		

12. Technical Specifications

Power supply

The MCS-D system includes devices which provide power via integrated modular power supplies (MCS-D 200 control unit, CA 4115/30/45 power supply units) and devices which have to be powered (microphone stations, interfaces, adapters).

Power supplies

MCS-D 200 control unit (19") with integrated power supply

- Input power 150 VA, optional 250 VA
- Output power 96 W, optional 192 W
- Input voltage 230/115 V, 50/60 Hz
- Output voltage ± 24 V
- Output current 2A, optional 4 A

CA 4115/30/45 power supply unit (19") for system extension; optional: 1 - 3 power supplies

- Input power 150 VA
- Output power approx. 96 W
- Output voltage ± 24 V
- Output current

CA 4115 (1 modular power supply) 2 A

CA 4130 (2 modular power supplies) 4 A

CA 4145 (3 modular power supplies) 6 A

Current consumer

CA 4522/44/66 digital / analogue interface (19") with 1 to 3 modules

- Current consumption
- CA 4522: 1 x (2 IN / 2 OUT) approx. 100 mA
- CA 4544: 1 x (4 IN / 4 OUT) approx. 200 mA
- CA 4566: 1 x (6 IN / 6 OUT) approx. 300 mA

CA 4212/13/14 adapter

- Current consumption approx. 65 mA

MCS-D 2073 microphone station

- Current consumption approx. 115 mA

MCS-D 202 interpreter station

- Current consumption approx. 115 mA

MCS-D 2074 service (technician) station

- Current consumption approx. 115 mA

Technical Specifications

MCS-D 200 Control Unit

Max. power consumption	1 power supply: 2 A, approx. 137 W 2 power supplies: 4 A, approx. 255 W
Input voltage	100 - 250 V
Supply voltage	±24 V, max. 2 A
Fuse	6.3 A; slow-blow fuse
System connections	Push-pull
Connection for PC or media control	2 x SubD-9 RS 232-C
Connection for headset	DIN 45326 (8-pin) for headphones
Headphone connection	mini stereo jack socket (3.5 mm)
Volume control headphone	does not work
Volume control DMC devices	-94.5 dB - 0 dB
Analogue audio input	2 x XLR IN, balanced (standard level: 0 dBm, range: -28.5 dB - +18 dB)
Analogue audio output	2 x XLR OUT, balanced (standard level: 0 dBm, range: -78 - +16.5 dB)
Number of audio channels	54 channels
Frequency response	-6 dB: 44.25 Hz - 22.0 kHz -3 dB: 72.0 Hz - 15.1 kHz
Maximum cable length between NetRateBus devices	100 m with the following cable type: "NetRateBus" conference network cable CA 4399, Order # 483.400
Temperature range	0 °C to +40 °C
Dimensions	19", 2 U (482.6 x 87 x 300 mm)
Weight	approx. 6.850 kg

MCS-D 2073 Microphone Station

Frequency response	-6 dB: 32 Hz - 23.5 kHz -3 dB: 50 Hz - 22.4 kHz
Current consumption	max. 130 mA
T.H.D.	< 0.1%
Headphone connection	mini mono jack socket (3.5 mm)
Volume control headphone	in 1.5 dB steps -79 dB - +9 dB
Signal-to-Noise ratio headphone connection	-70 dB
System connections	2 x push-pull
Minimum impedance	8 Ω
Temperature range	0 °C to +40 °C
Dimensions	250.00 x 160.51 x 100.67 mm
Weight with MIC 23 microphone	850 g

MCS-D 2074 Service Microphone Station

Frequency response	-6 dB: 32 Hz - 23.5 kHz -3 dB: 50 Hz - 22.4 kHz
Current consumption	max. 130 mA
T.H.D.	< 0.1%
Headphone connection	mini mono jack socket (3.5 mm)
Volume control headphone	in 1.5 dB steps -79 dB - +9 dB
Signal-to-noise ratio headphone connection	-70 dB
System connections	2 x push-pull
Minimum impedance	8 Ω
Temperature range	0 °C to +40 °C
Dimensions	250.00 x 160.51 x 100.67 mm
Weight with MIC 23 microphone	850 g

MCS-D 202 Interpreter Station

Frequency response	-6 dB: 70 Hz - 24 kHz -3 dB: 100 Hz - 22 kHz
Current consumption	max. 130 mA
T.H.D.	< 0.1%
Headphone connection	1/4" mono jack socket (6.35 mm)
Volume control headphone	rotary knob, range: -49 dB - +4.4 dB
Signal-to-noise ratio headphone connection	-60.7 dB
System connections	2 x push-pull
Minimum impedance	8 Ω
Temperature range	0 °C to +40 °C
Dimensions	342.00 x 197.40 x 102.19 mm
Weight with MIC 23 microphone	2.450 kg

MCS-D 3121/MCS-D 3123 Microphone Station

Frequency response	130 Hz - 17,000 Hz
Microphone	Line Array
Pick up pattern	Corridor
Current consumption	67 mA (microphone on)
T.H.D.	< 0.1%
Headphone connection	mini mono jack socket (3.5 mm)
System connection	2 x push-pull
Minimum impedance	8 Ω
Temperature range	0 °C to +40 °C
Dimensions (L x H x D)	300 x 78 x 92 mm
Weight	770 g

MCS-D 3171/MCS-D 3173 Microphone Station

Frequency response	130 Hz - 17,000 Hz
Microphone	Line Array
Pick up pattern	Corridor
Current consumption	max. 80 mA
T.H.D.	< 0.1%
Headphone connection	mini mono jack socket (3.5 mm)
System connection	2 x push-pull
Minimum impedance	8 Ω
Temperature range	0 °C to +40 °C
Dimensions (L x H x D)	300 x 78 x 92 mm
Weight	770 g

CA 4115/30/45 Power Supply Unit

Output power	
CA 4115	2 A
CA 4130	4 A
CA 4145	6 A
Number of integrated modular power supplies	
CA 4115	1
CA 4130	2
CA 4145	3
Fuse	6.3 A, slow-blow fuse
Power consumption	
CA 4115	150 VA
CA 4130	300 VA
CA 4145	450 VA
Output power	
CA 4115	96 W
CA 4130	192 W
CA 4145	288 W
Input voltage	95...265 V ~, 50/60 Hz
Dimensions	2 U x 482.6 mm (19") x 300 mm for rack installation
System connections	2 x push-pull
Extension connections	2 x push-pull
Colour	RAL 7016 (dark-grey, matt)
Inscription	RAL 7004

CA 4522/44/66 Digital/Analogue Interface

Power supply	via bus system
Current consumption	
CA 4522	100 mA
CA 4544	200 mA
CA 4566	300 mA
System connections	
CA 4522	2 x XLR IN, 2 x XLR OUT
CA 4544	4 x XLR IN, 4 x XLR OUT
CA 4566	6 x XLR IN, 6 x XLR OUT
Analogue audio input	balanced (standard level: 0 dBm, range: -9.5 dB ... +13 dB)
Analogue audio output	balanced (standard level: 0 dBm, range: -24 dB ... +22.5 dB)
Dimensions	2 U x 482.6 mm (19") x 300 mm for rack installation

Technical Specifications

CA 4213/14 Adapter

Connections

CA 4213	3 x push-pull
CA 4214	4 x push-pull
Power supply	via bus system
Current consumption	65 mA
Temperature range	0 °C to +40 °C
Dimensions (W x H x L)	57 x 32 x 105 mm
Weight	180 g

beyerdynamic))))

beyerdynamic GmbH & Co. KG
Theresienstr. 8
D-74072 Heilbronn
Tel. +49 (0) 71 31 6 17-0
Fax +49 (0) 71 31 617-224
E-mail: info@beyerdynamic.de
Internet: www.beyerdynamic.de

beyerdynamic U.K. Ltd.
17 Albert Drive
Burgess Hill RH15 9TN
Tel. +44 (0) 1444 258 258
Fax +44 (0) 1444 258 444
E-mail: sales@beyerdynamic.co.uk
Internet: www.beyerdynamic.co.uk

beyerdynamic Inc. USA
56 Central Ave.
Farmingdale, NY 11735
Tel. +1 (631) 293-3200
Fax +1 (631) 293-3288
E-mail: salesUSA@beyerdynamic.com
Internet: www.beyerdynamic.com



EZ/BA MCS-D 200 (04.07)/589.861 • Subject to change without notice.

Free Manuals Download Website

<http://myh66.com>

<http://usermanuals.us>

<http://www.somanuals.com>

<http://www.4manuals.cc>

<http://www.manual-lib.com>

<http://www.404manual.com>

<http://www.luxmanual.com>

<http://aubethermostatmanual.com>

Golf course search by state

<http://golfingnear.com>

Email search by domain

<http://emailbydomain.com>

Auto manuals search

<http://auto.somanuals.com>

TV manuals search

<http://tv.somanuals.com>