



**bifinett**  
KH 1108

**MICROWAVE OVEN WITH GRILL**





# Microwave Oven with Grill KH 1108

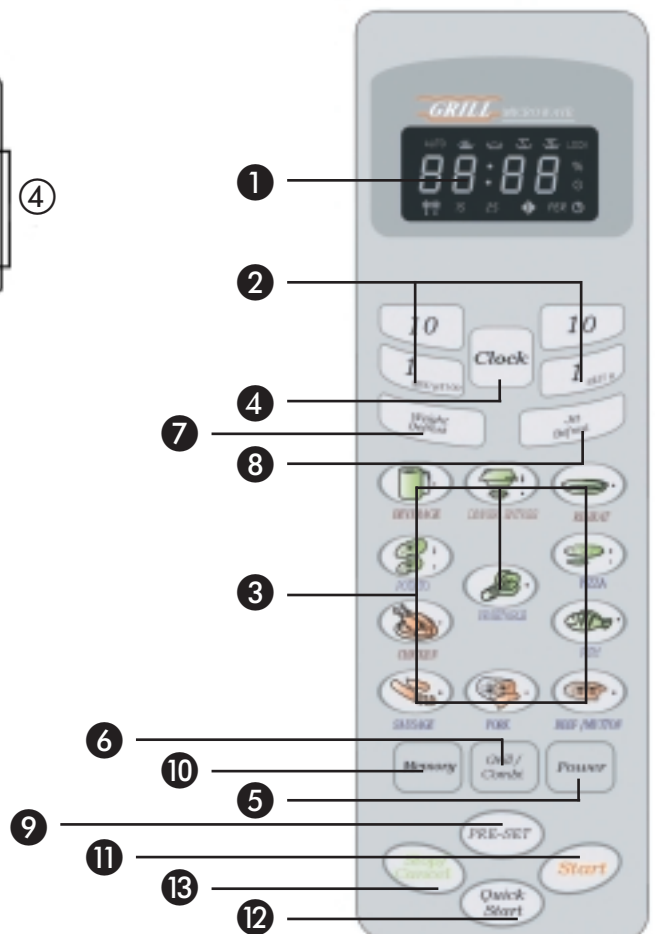
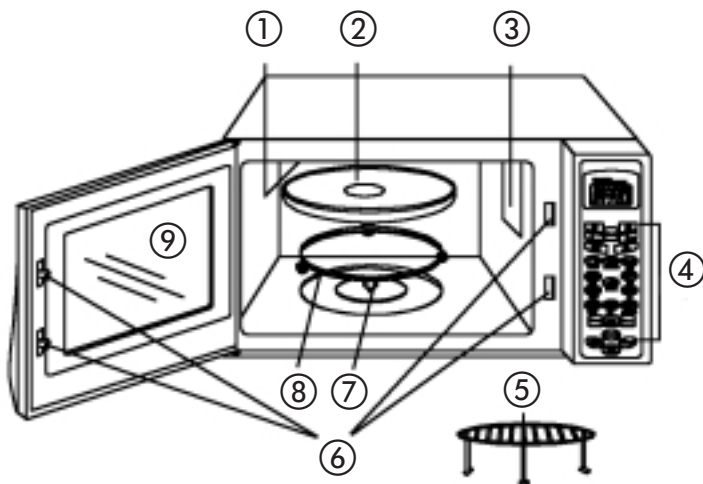
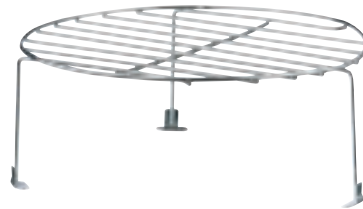

# Introduction / Contents

Please read these instructions carefully before installing and starting your microwave oven. Please note the SERIAL NUMBER which can be found on the type plate of your microwave oven into the adjacent field and store this information for later.

SERIAL NUMBER:

<b>1</b>	<b>Safety Notes</b>		
•	<b>PRECAUTIONARY MEASURES TO PREVENT POSSIBLE EXCESSIVE CONTACT WITH MICROWAVE ENERGY</b>	.....	Page 5
<b>2</b>	<b>IMPORTANT SAFETY NOTES</b>	.....	Page 5
<b>3</b>	<b>Technical Notes</b>		
•	<b>TECHNICAL INFORMATION</b>	.....	Page 6
•	<b>BEFORE CONTACTING CUSTOMER SERVICES</b>	.....	Page 6
•	<b>INSTALLATION</b>	.....	Page 6
•	<b>NOTES ON EARTHING</b>	.....	Page 6
•	<b>RADIO INTERFERENCE</b>	.....	Page 7
•	<b>COOKING WITH YOUR MICROWAVE</b>	.....	Page 7
•	<b>GUIDELINE ON COOKING DISHES</b>	.....	Page 7
<b>4</b>	<b>Parts and Control Panel</b>		
•	<b>DESIGNATION OF PARTS</b>	.....	Page 8
•	<b>CONTROL PANEL</b>	.....	Page 8
<b>5</b>	<b>Operation</b>		
•	<b>SETTING THE CLOCK</b>	.....	Page 9
•	<b>COOKING WITH YOUR MICROWAVE</b>	.....	Page 9
•	<b>GRILLING</b>	.....	Page 9
•	<b>COMBINATION COOKING</b>	.....	Page 9
•	<b>AUTOMATIC COOKING</b>	.....	Page 9
•	<b>DEFROSTING BY WEIGHT</b>	.....	Page 10
•	<b>QUICK / JET DEFROST</b>	.....	Page 10
•	<b>MULTI STAGE COOKING</b>	.....	Page 10
•	<b>TIMED START</b>	.....	Page 10
•	<b>QUICK START</b>	.....	Page 10
•	<b>CHILD-PROOF LOCK</b>	.....	Page 11
•	<b>MEMORY</b>	.....	Page 11
<b>6</b>	<b>Cleaning and Maintenance</b>	.....	Page 11
<b>7</b>	<b>Disposal</b>	.....	Page 12
<b>8</b>	<b>Warranty</b>	.....	Page 12
<b>9</b>	<b>Defrosting</b>	.....	Page 13
<b>10</b>	<b>Cooking</b>	.....	Page 14
<b>11</b>	<b>Grilling</b>	.....	Page 15
<b>12</b>	<b>Tips</b>	.....	Page 16
<b>13</b>	<b>Recipe suggestions</b>	.....	Page 17

# Safety Notes

## 1 PRECAUTIONARY MEASURES TO PREVENT EXCESSIVE CONTACT WITH MICROWAVE ENERGY

- Do not attempt to operate this microwave oven with an opened door since operating the microwave oven with an open door can lead to being exposed to hazardous microwaves. It is important not to break open or manipulate the safety lock.
- Do not tuck anything between the oven front and door and ensure that no impurities or residues from cleaning agents gather on the sealing surfaces.
- Do not operate the microwave oven if damaged. It is of utmost importance that the door of the oven closes properly and that there is no damage to:
  - the door (bent), - hinges and locks (broken or loose),
  - door seals and sealing surfaces.

Have the appliance re-set or repaired by the listed customer service branch or respectively qualified skilled staff only.

## 2 IMPORTANT SAFETY NOTES

When using electrical appliances elementary precautionary measures must be adhered to for your safety, including:

**WARNING:** To reduce the risk of burns, electric shock, fires, injuries or excessive contact with microwaves:

Read all instructions prior to use.

- Use this appliance only according to its intended purpose and as directed in this manual. Do not use any corrosive chemicals or vapours for this equipment. This type of oven is designed especially for heating, cooking or drying foods. It is not designed for industrial use or use in laboratories.
- Do not operate the microwave when empty.
- Do not operate this appliance if damage is visible to the cable or plugs, if it does not operate properly or is damaged or has been dropped. If the power cable is defect it must be replaced by the manufacturer or his maintenance partner or similarly qualified skilled staff so as to avoid any danger.
- **WARNING:** Allow the unsupervised operation of the microwave by children only after carefully instructing them on how to operate the microwave to ensure the risk-free use of the oven and that children understand the risks in the event of improper handling.

- To minimise the risk of fire in the microwave: Keep an eye on the microwave at all times when heating food in plastic or paper containers since the materials may ignite.
- Remove wire closures from paper or plastic bags before placing them in the microwave.
- Should you notice smoke, switch off the appliance or disconnect the plug and keep the door closed so as to suffocate possible flames.
- Do not use the inside of the microwave for storage. Do not leave paper articles, cooking utensils or food in the microwave if it is not being used.
- **WARNING:** Fluids and other food must not be heated in tightly sealed containers as they may explode. When heating beverages in the microwave, spattering may be delayed if the beverage is brought to boil. Please handle the container with particular care.
- Do not deep-fry in the microwave. Hot oil may damage microwave parts and utensils or even lead to skin burns.
- Eggs in their shell and hard boiled eggs should not be heated in the microwave as they may even explode after microwave heating has been terminated.
- Pierce thick-skinned foods such as potatoes, whole pumpkins, apples, and chestnuts before cooking.
- The content of baby bottles and baby jars should be stirred or shaken.

**Caution: Prior to consumption check the temperature in order to avoid life-threatening burns to the baby.**

- Cooking utensils may heat up from the heat exerted by the food and may have to be handled with an oven cloth only. Cooking utensils should be checked as to suitability for use in microwave ovens. **WARNING:** Maintenance and repair work which requires the removal of the cover which serves as protection against microwaves endangers the life of persons other than skilled staff.

# Technical Notes

## 3 TECHNICAL INFORMATION

Power:	230 V~50 Hz, 800 W (microwave) 1000 W (grill)
Actual frequency:	2450 MHz
External dimensions:	295 (H), 458 (W), 380 mm (D)
Inner dimensions:	206 (H), 300 (W), 302 mm (D)
Capacity:	20 ltr
Standard cooking:	Turntable system Ø 270 mm
Net weight:	approx. 15,1 kg

- To function properly the oven requires sufficient air circulation. Allow for 20 cm of space above the oven, and 10 cm behind, and to the sides 5 cm respectively.
- Do not cover or block any openings of the appliance. Do not remove the microwave's feet.
- Do not operate the oven unless the glass turntable, rotating ring, and drive shaft have been correctly positioned.
- Check if the power cable is not damaged and does not lead underneath the oven through or over a hot or sharp surface. The outlet must be freely accessible to be able to remove the plug in the event of an emergency.
- Do not use the oven outdoors.

### BEFORE CONTACTING CUSTOMER SERVICES

If the microwave is not working:

- Verify that the plug is correctly connected to the outlet. If not, completely disconnect the plug from the outlet, wait 10 seconds and then reconnect.
- Check if a fuse has blown and if the voltage safety switch is still on. If both seem to operate correctly, test the outlet with another appliance.
- Check if the control panel programming is correct and if the timer has been set.
- Check if the door has been firmly closed, with the lock of the door engaged, otherwise the generation of microwaves in the oven is blocked.

If none of the above remedies the problem, contact the named customer services branch or a qualified expert. Do not attempt to modify or repair the appliance independently.

### INSTALLATION

Ensure that the packaging materials have been completely removed from the inside of the door. **WARNING:** Inspect the oven for damages such as a distorted or bent door, damaged door seals and seal surfaces, defect or loose door hinges and locks as well as grooves on the inside or on the door. If there is visible damage, do not operate the oven and consult a qualified maintenance expert.

- This microwave must be placed on a level, stable base which can bear the microwave's own weight plus the heaviest food which most likely will be cooked in the microwave.
- Do not position the microwave at a location where heat, dampness or high humidity arise, and do not place it close to inflammable materials.

### EARTHING

The present appliance must be earthed. This oven is equipped with a cable featuring an earth lead with earth plug. This requires a specially installed and earthed wall connection. In the event of a short circuit the earthed connection prevents the risk of an electric shock via the discharge cable. It is recommended to use an independent electric circuit for the oven which supplies the oven only. The use of high voltage is dangerous and can cause fires and other accidents which may damage the oven. **WARNING:** The improper handling of the earth plug can lead to the risk of an electric shock.

#### Note:

If you have any questions regarding earthed connections or the electric instructions ask an electric expert or maintenance specialist. Neither the manufacturer nor the dealer can accept liability for damage to the oven or for personal injury resulting from the non-observance of the procedure for the electrical connections. The wires of this electric main can be identified according to the following colour code:  
Green and yellow = earth; blue = NEUTRAL  
brown = current bearing

# Technical Notes

## RADIO INTERFERENCE

Operating the microwave can lead to interference with your radio, television or similar equipment. In the event of such interference the following measures can help reduce or eliminate such interference:

- Clean the door and sealing surface of the oven.
  - Redirect the receiving antenna of the radio or television.
  - Place microwave at another place than where the receiver is.
  - Remove the microwave from the receiver.
- Plug the microwave into another outlet so that the microwave and receiver are supplied by a different leg of the power circuit.

## COOKING WITH YOUR MICROWAVE

- Arrange your food with consideration.
- The thickest parts should be close to the edge.
- Observe the cooking time. Select the shortest cooking time and extend it if need be. Food cooked excessively long can start smoking and ignite.
- Cover the food while cooking with a lid. The lid will prevent the food from spattering and contributes to the even cooking of the food.
- Turn the food during microwave preparation once so that e.g. chicken or Hamburger dishes are more quickly cooked.
- Large foods such as roast meat must be turned at least five times.
- Rearrange food items like meat balls completely after half of the cooking time has passed by turning them and rotating those which previously were at the centre of the dish, to the edge.

## GUIDELINE ON COOKING DISHES

The ideal material for a microwave oven is microwave permeable, i.e. it allows energy to pass through the container in order to heat the food. Only use a temperature sensor recommended for this oven. Microwaves can not permeate metal. For this reason, do not use metal containers or metal dishes. Do not use any products made of recycled paper when heating in the microwave as they may contain minute metal fragments which may cause sparks and/or fires. It is recommended to use round/oval dishes instead of square/oblong dishes since food caught in the corners may easily boil away.

The bottom table is a general guideline for choosing the correct dishes.

COOKING DISHES	MICRO-WAVE	GRILL	COMBI NATION
Heatproof glass	<b>Yes</b>	<b>Yes</b>	<b>Yes</b>
Non-heatproof glass	<b>No</b>	<b>No</b>	<b>No</b>
Heatproof ceramics	<b>Yes</b>	<b>Yes</b>	<b>Yes</b>
Microwave plastic dishes	<b>Yes</b>	<b>No</b>	<b>No</b>
Kitchen towel	<b>Yes</b>	<b>No</b>	<b>No</b>
Metal tray /plate	<b>No</b>	<b>Yes</b>	<b>No</b>
Metal base	<b>No</b>	<b>Yes</b>	<b>No</b>
Tin foil & tin containers	<b>No</b>	<b>Yes</b>	<b>No</b>

# Parts and Control Panel

## 4 DESIGNATION OF PARTS

- ① Heater
- ② Glass plate
- ③ Vent
- ④ Control panel
- ⑤ Metal base / grill
- ⑥ Safety door lock
- ⑦ Drive shaft
- ⑧ Rotating ring
- ⑨ Oven window

### Safety door lock ⑥:

Pull the handle to open the door. Opening the door while cooking interrupts the operation, the set programme or function is stored. Cooking continues as soon as the door is closed and the START button is activated.

### Glass plate ②:

Leave the glass plate and the rotating ring ⑧ during operation at all times in the appliance. The rotating glass plate ensures the even distribution of energy and microwaves.

### Metal base / grill ⑤:

Use the metal base for roasting and combined cooking.

Place a heatproof plate below the metal base. This catches grease and food spills.

**Caution:** The metal base must be used on the glass plate only. Use an oven glove or similar item to remove the food after grilling. Please observe that the inside of the appliance may be very hot; handle with the appropriate care.

## CONTROL PANEL

### ① MENU MODE DISPLAY

Cooking time, power, mode and time are displayed.

### ② NUMBER FIELDS

Set time, cooking time or weight. Press the respective number fields.

### ③ QUICK SELECT

Prompt pre-set quick programming – for cooking conventional foods.

### ④ CLOCK

Set digital clock.

### ⑤ POWER

Start microwave – press button once or several times to select the power level.

### ⑥ GRILL/COMBI

Select cooking mode – press three times.

### ⑦ WEIGHT DEFROST

Programme defrosting – based on weight of food to be defrosted.

### ⑧ JET DEFROST

Quick defrost function where defrost and rest times alternate rapidly to quickly and effectively thaw out frozen goods.

### ⑨ PRE-SET

This timed starter functions allows you to place food in the microwave and programme it so that the food is cooked at a later moment in time.

### ⑩ MEMORY

To set a multi-stage cooking programme.

### ⑪ START

Press to initiate cooking. Wrong operations are signalled by way of two rapidly following alarm signals.

### ⑫ QUICK START

Press to quickly activate full microwave power

### ⑬ STOP/CANCEL

Press to cancel the setting of a cooking programme. Press once to temporarily halt cooking, and twice to cancel completely. Press and hold to activate child-proof lock.



# Operation

## 5 OPERATION

A signal is heard every time when touching the button which confirms the contact or the choice of programme.

### SETTING THE CLOCK

Press CLOCK **4** once to display the 12-h clock, and twice for a 24-h display. Then press the respective number fields to set the current time.

**Example:** To set the clock to 6:00 am or pm:

- Press CLOCK **4**. The display indicates 12 hr (12-h display), or press CLOCK **4** twice, the display then indicates 24 hr (24-h display).
  - Press the 1-MIN button until 6:00 is displayed (or 18:00 if using the 24-h time display).
  - To confirm, press CLOCK again. If the wrong time has been set, such as 6:70 or 25:40, the display will indicate after confirming this incorrect entry with the CLOCK button the 12:00 H or 24 H display, allowing you to enter the correct time.
- Check the time while cooking by pressing the CLOCK **4** button.

### COOKING IN THE MICROWAVE

To cook in the microwave the time and power should be set. The longest cooking time which can be set by pressing the number fields is 99 min. 99 sec.

**Example:** To cook food for 5 minutes at 60% microwave power rating -

- Press POWER **5** three times.
- Press the 1-MIN button five times.
- Press START **1**.

Note: Press START during cooking for a display of the power rating lasting 3 seconds.

### POWER BUTTON

By pressing POWER **5** repeatedly select one of the following power ratings to operate the microwave:

Press	Power	Description
1 x	100%	High
2 x	80%	Medium-high
3 x	60%	Medium
4 x	40%	Medium-low
5 x	20%	Low

### GRILL

**Caution - you could get burned!**

When the GRILL function is used, the inside of the microwave oven can become very hot.

Always wear oven gloves whenever you touch hot foods or dishes or take them out of the microwave oven.

The grill function is useful mainly for thinly sliced meat, steaks, meat balls, shashlik, sausages or chicken. It is also suitable for baked sandwiches and gratins.

**Example:** To grill food for 12 minutes:

- Press the Grill/Combi button **6** once.
- Press the 10-MIN button once and the 1-MIN button twice.
- Press START **1**.

### COMBINATION COOKING

**Combination 1:** 

The longest possible cooking time for this setting is 99 min., 99 sec.

30 % time for cooking with microwave,  
70 % for grilling.

Recommended for fish, potatoes or gratins.

**Combination 2:** 

55 % time for cooking with microwave,  
45 % for grilling.

For puddings, omelettes, jacket potatoes and poultry.

**Example:** To set the oven for 25 minutes to COMBINATION cooking -

- Touch Grill/Combi button **6** two or three times.
- Press 10-MIN button twice and 1-MIN button 5 times.
- Press START **1**.

### AUTOMATIC COOKING

To prepare food with the following cooking mode it is not necessary to enter the cooking duration and the power level. It is sufficient to enter the type of food to be cooked, as well as its weight.

For this, press the respective button which illustrates the food to be cooked. This then shows a number of pre-set weight parameters. Select the one which corresponds to the weight of the item which you have placed in the microwave. The microwave then starts to cook the food once you press START **1**.

**Example:** To cook 400 g fish, for example, proceed as follows.

- Press STOP/CANCEL **3**.
- Press the FISH button three times.
- Press START **1**.

# Operation

## Enter the food's weight:

The weight parameters are needed to determine the required cooking time. When pressing the symbol buttons once or several times, the display indicates a number of pre-set weight parameters (for beverages and complete main courses the number of portions). As soon as the correct weight of the food which you have placed in the microwave is displayed, press START ⑪.

### Note:

Certain foods may require that the door of the microwave be opened after half of the cooking time has passed, in order to check if they are fully cooked and to turn the food to achieve even cooking. When doing so, please be careful when handling very hot foods in the microwave. To continue cooking, simply close the door. The microwave automatically continues operation for the remaining time.

## DEFROST BY WEIGHT

The appliance can defrost meat, poultry and seafood. Defrosting time and power are set automatically as soon as the weight of the food has been programmed.

The following table shows the maximum permissible weight for every category:

Food	Maximum weight	Display
Meat	2300 g	d1
Poultry	4000 g	d2
Seafood	900 g	d3

**Example:** To defrost 600 g shrimps.

- Place the shrimps to be defrosted in the oven.
- Press WEIGHT DEFROST ⑦ three times.
- Press the 0.1 kg (1g=100) button six times to enter the weight.
- Press START ⑪.

For food whose weight exceeds the permissible defrost limits, please use the Quick Defrost function. If you accidentally enter a weight which exceeds the maximum weight illustrated in the table, the display clears automatically to enable a new input.

## QUICK DEFROST

For the DEFROST function enter the defrost time.

**Example:** To set the oven for a 5 minute DEFROST period.

- Press DEFROST ⑧.
- Press the 1-MIN button five times.
- Press START ⑪.

## MULTI STAGE COOKING

The appliance can be programmed as such that several functions are performed subsequently.

**Example:** To set the following programme:

1. QUICK DEFROST;
2. Cooking in the microwave;
3. Grilling.

### Proceed as follows:

1. Press STOP/CANCEL ⑬ to delete possible previous settings.
2. Press ⑧ to enter the QUICK DEFROST programme.
3. Use the number fields ② to enter the cooking time and then the power level with POWER ⑤.
4. Press MEMORY ⑩.
5. Press ⑥ (enter grill programme).
6. Press START ⑪.

### Note:

DEFROST or WEIGHT DEFROST should only be an element of a programme if these functions are set in the very beginning. The display indicates the programme phase the appliance is in. At the end of the total time 4 audio signals can be heard.

## TIMED START

This function allows starting the appliance at a later point in time.

**Example:** It is 11:10 and you wish to start the appliance at 11:30.

### Proceed as follows:

1. Press PRE-SET ⑨.
2. Use the number fields ② to enter 11:30 hr as the starting time.
3. Set a programme.
4. Press START ⑪. (The display per for PRE-SET flashes)

### Note:

Be sure to place food in the oven prior to starting cooking.

## QUICK START

This mode assists in quick starting the appliance. Press QUICK START ⑫ once or several times to set the cooking time at increments of 30 seconds. The microwave immediately starts operation at full power.

Press 1 x = 0:30 minutes,

Press 2 x = 1:00 minute,

Press 3 x = 1:30 minutes etc.

**Example:** To operate the microwave for two minutes in this mode:

- Press QUICK START ⑫ four times and the appliance starts immediately at full power.

# Operation / Cleaning

Extend the cooking time during running operation by pressing this button.

## CHILD SAFETY LOCK

This setting prevents the unsupervised operation of the oven by small children.

The display shows **lock** and the appliance can not be operated for as long as this child-safety lock is activated.

- Activate child safety lock (LOCK):  
Hold the STOP/CANCEL **15** button for 3 seconds. First an audio signal sounds and then the display indicates **lock**.
- Deactivate child safety lock:  
Again, hold the STOP/CANCEL **15** button for 3 seconds until the display no longer indicates **lock**.

## AUTOMATIC MEMORY FUNCTION

Upon completing every cooking programme three audio signals indicate the end of the programme. This automatic memory function is repeated every two minutes until the door of the appliance is opened or the STOP/CANCEL button has been pressed.

## 6 CLEANING AND MAINTENANCE

Before cleaning, disconnect the microwave and remove the plug from the outlet.

- Keep the inside of the microwave clean at all times.
- If food spatters or spilled fluids line the inside walls of the microwave, remove with a damp cloth.
- If the microwave is more strongly soiled, use mild washing-up liquid.
- Avoid using aerosol cleaners and other harsh cleaning agents as they may cause stains, stripes or dull the surface of the door.
- Clean the outside with a damp cloth.
- To avoid damage to the functional parts inside the microwave do not allow water to seep through the vents.
- Wipe both sides of the door and window as well as the seals of the door and neighbouring parts regularly with a damp cloth to remove food spatters or spills. Do not use abrasive cleaning agents.
- Prevent the control panel from becoming wet. When cleaning the control panel, leave the door open in order to avoid an accidental activation of the microwave.
- If vapours build up inside or to the outside of the microwave door, remove these with a soft cloth. Vapours may build up if the microwave is operated under very humid conditions. This is absolutely normal.
- Clean the glass plate regularly. Rinse the plate with warm soap suds or in the dishwasher.
- The rotating ring and the door of the oven should also be regularly cleaned in order to prevent excessive noise. Simply wipe the ground of the microwave with mild washing-up liquid. The rotating ring can be cleaned with mild soap suds or in the dishwasher. Be sure to correctly replace the rotating ring after having removed it from the inside for cleaning purposes.
- Remove odours by placing a deep microwave dish with a cup of water and the juice and zest of a lemon in the microwave and heating this for 5 minutes. Wipe off thoroughly and dry with a soft cloth.
- When having to replace the lamp inside the oven, ask your dealer to replace it or consult our customer services (see warranty card).

# Disposal / Warranty

## 7 DISPOSAL

The packaging is wholly composed of environmentally-friendly materials that can be disposed of at a local recycling centre.

Please contact your local council office to find out about disposal facilities for your worn-out appliances.

## 8 WARRANTY

This piece of equipment is covered by a **3-year warranty** as of the date of purchase. The equipment was produced with the greatest of care and underwent thorough testing before delivery. In the unlikely event of detecting a functional defect, please return the equipment in its original packaging with the proof of purchase to the closest service address. Damage caused due to improper handling as well as regular wear of the parts are not covered by this warranty.



**Beaver Electronic Services**  
**The Lodge, Premier Business Park**  
**Long Street, Walsall**  
**West Midlands, WS2 9DY**  
**Tel.: 0 87 07/87 61 77**  
**Fax: 0 19 22/72 54 17**  
**e-mail: support.uk@kompernass.com**



**Irish Connection Ltd**  
**41 Harbour View**  
**Howth, Co. Dublin**  
**Tel 087-99 62 077**  
**Fax: 18 39 80 56**  
**e-mail: support.ie@kompernass.com**



# Defrosting

## 9

### Freezing and defrosting – how it's done ...

The microwave is an ideal device for defrosting frozen foods quickly and evenly.

The power output, defrosting and standing time settings must be selected to suit the consistency and quantity of the food to be defrosted.

Microwaves always penetrate food from the outside and move towards the inside. Therefore the middle parts of particularly large pieces of food should not be fully defrosted as in doing this the outside layers may be burned.

Correct defrosting starts with the original freezing. Take this into account and proportion the quantities as small as possible, flat and suited your household requirements. You should also take into account the size of the bowls or dishes in which you will be defrosting later in the microwave.

The following defrosting table gives the defrosting times of some common foods. In addition to defrosting times, the table also gives standing times - all related to the quantity of food. During standing times, heat flows from the defrosted layers into the centre of the food, which may still be frozen, and thus temperature differences are evened out. Leave the frozen food inside or outside of the switched-off microwave during the standing time. The values given in the table are approximate only and variations may occur in practice. This can be caused by several factors to do with the food.

To use the integrated DEFROST function.

- Press the DEFROST button ③.
- Enter the defrosting time using the numerical keys ②.
- Press the START button ①.

### Defrosting table

FOOD	WEIGHT	DEFROSTING TIME	STANDING TIME	ADVICE/TIPS
Bread rolls	150 g / 2 pcs.	approx. 1 min.		
Bread	500 g	8-10 min.	10-20 min.	
Cream cake	400-800 g	8-12 min.	90-120 min.	Defrost the cake only
Butter	250 g	approx. 1 min.	20-30 min.	Remove the packaging and place the butter on a plate
Cheese (piece)	500 g	5-6 min.	60-90 min.	Turn the piece of cheese over once after half the time has elapsed
Cooked meats	200 g	approx. 3 min.	10-15 min.	Turn the piece of cooked meat once after half the time has elapsed. Cut the slices before standing time carefully using a knife.
Strawberries	250 g	approx. 8 min.	5-10 min.	Defrost the strawberries or other fruit in a bowl with a lid. Carefully stir once after half the time has elapsed carefully

Before defrosting meat, poultry or fish please read the section WEIGHT DEFROST in the operating instructions supplied with the microwave.

# Cooking

# 10

## Cooking – how it's done ...

**Cooking instructions  
are important**

**Observe  
the standing times**

A suitable bowl or dish with a lid must always be used to cook foods in a microwave where nothing to the contrary is indicated. The information on cooking relates to food at domestic refrigerator temperature. First of all, defrost the food before cooking. Note: the defrosting time can be between 5 and 15 minutes for frozen vegetables (-18°C, approx. 300-450 g). Observe the instructions on the packaging. Prepare the vegetables by washing and cleaning them.

Always observe the relevant cooking instructions. Some foods require liquid to be added (for vegetables normally 1-2 dessert spoonfuls (DS) per 100 g), whilst others, e.g. cucumbers, onions, fungi and spinach, do not. On the other hand, other foods require to be stirred at least once during cooking.

Once again, as with defrosting, standing time is important. The time for temperature equalisation and the associated post-microwave further cooking period should be between 5 and 10 minutes. Leave the food inside or outside of the switched-off microwave during the standing time.

Herbs, spices and/or, if called for, a little butter can be added to the vegetables after the standing time.

In the case of ready-made or frozen dishes, microwave cooking should follow the times given on the packaging.

The information in the following table is intended as guidance only.

## Cooking table

FOOD	WEIGHT	LIQUID ADDED	POWER SETTING	COOKING TIME MINS	COOKING ADVICE
Boiled potato	250 g	3 DS water	960 watts	approx.5 min.	Cut into pieces roughly all the same size – pour off water immediately after cooking
Noodles	125 g	600ml water	720 watts	approx. 5 min.	First boil the water at 960 watts (approx. 7 min.) Add the noodles and cook without a lid
Rice	100 g	300ml water	960 watts	approx. 3-4 min.	Absorbing time depends on the type of rice. Natural rice requires longer.
Cauliflower	400 g	4 DS water	960 watts	approx. 6-7 min.	Values given also apply to broccoli
Peas	300 g	3 DS water	960 watts	approx. 3-4 min.	
Spinach	500 g	–	960 watts	approx. 6 min.	
Fungi/ mushrooms	400 g	–	960 watts	approx. 5-6 min.	Add a little butter before cooking
Fish fillets	400-600 g	see advice	720 watts	approx. 8-12 min.	Add 1 DS water, lemon, stock or wine per 100 g of fish

# Grilling

## 11

### Grilling – how it's done ...

Always use the metal stand ⑤ where grilling is called for. In addition, a heat resistant plate must be placed under the stand. The plate is there to catch the juices, fat, stock and cooking debris given off by the food.

The grill function is intended for thin slices of meat, fish, rissoles, shashlyks, sausages or chicken pieces. Slices of toast or toasted bread rolls can be made using the grill (please refer to the TIPS section) as well as covered toasts (such as Hawaii toast).

You can select the grill function ⑥ using the menu symbols - directly or with the quick select buttons ③.

For some foods or ways of cooking, you can use a combined process of cooking and grilling. This mode automatically selects the appropriate cooking and grilling times. For further details please read the section about COMBINED GRILLING AND MICROWAVING in the operating instructions supplied with the microwave.

Prepare the food that you wish to grill exactly as normal. For example, descale fish and clean them. Rub poultry with seasoning and always cook chicken legs from the skinned side first.













Turn the food after the first cooking time indicated.

The 1st value given is the cooking time for the first side; the 2nd value is for the second side to be cooked.

Note: enter the times for the first and second sides separately.

The values given in the following table are approximate only and variations may occur in practice. This can be caused by several factors to do with the food, e.g. temperature, shape).

### Grill table

FOOD	FUNCTION (1st side)	COOKING TIME MINS	FUNCTION (2nd side)	COOKING TIME MINS
2 turkey steaks 400g	Grill 	approx. 12	Grill 	approx. 10
2 chicken legs 500g	Grill 	approx. 8	Grill 	approx. 7
2 shashlyks 400g	Grill 	approx. 12	Grill 	approx. 12
2 trout 400g	Combi 1 	approx. 8	Grill 	approx. 7
4 rissoles 600g	Combi 1 	approx. 12	Grill 	approx. 8
2 neck cutlets 600g	Grill 	approx. 15	Grill 	approx. 13

# Tips

## 12

You can also use your microwave as a kitchen clock - accurate to the minute – without having the microwave or grill in operation. The delay function allows you to use the clock like an alarm clock. Take note of the current time and enter the following information to tell the microwave the desired time to switch on. Press PRESET **9**, enter the time to switch on the microwave using the NUMERIC KEYS **2** and press the START button **11**. The digital display flashes "PER". The microwave sounds 4 beeps to let you know that the set period has elapsed.

Always use microwave-suitable bowls or dishes for defrosting, cooking etc. In most cases glass dishes are ideal for cooking. You should purchase some microwave-suitable dishes with lids in a range of sizes.

You can make bread rolls crispy-fresh using the grill function **6** on your microwave. Before crisping up, moisten the bread rolls with a little water. Crisp up the bread rolls for about 2-3 minutes depending on the type and size. So that the bread rolls are also "oven-fresh" inside, we recommend that you cut the rolls after the first grilling and crisp them again for 1-2 minutes.

Place the frozen pizza on to the metal stand **5** without defrosting. Use the pizza function from the quick select buttons **3** and select from the appropriate preset weights. Pressing the pizza button once causes a weight of 150 g to appear; another press gives 320 g. Select the preset weight that is closest to the weight of your pizza and press START **11**. After the automatic cooking period has elapsed, if necessary you can extend the cooking time of the pizza by using the grill function **6**. This can sometimes be required if your pizza is heavier than the preset weight.

The operating instructions indicate the various microwave power settings in percent and their equivalents in watts. You can find this in the section about Power Settings. The short table below gives you a summary.

<b>100 % = 1200 watts</b>
<b>80 % = 960 watts</b>
<b>60 % = 720 watts</b>
<b>40 % = 480 watts</b>
<b>20 % = 240 watts</b>

**Your microwave as a kitchen clock**

**Microwave-suitable cooking dishes**

**Making bread rolls crispy-fresh**

**Pizza**

**Power settings - percentage values and watts**



# Recipe suggestions

## 13

### Onion soup with cheese

**Ingredients for 4 portions:**

300 g onions, 30 g butter, salt, white pepper, 500 ml instant meat stock, 125 ml dry white wine, 2 slices of toast, 2 slices of immature Gouda cheese

**Preparation:**

Peel the onions and slice them into rings. Place them in microwave-suitable dish with the butter and pepper. Add the meat stock, then cover and cook for approx. 10 minutes at 1200 watts. Add white wine to taste. Cut the toast into little cubes. Pour the onion soup into four soup bowls and add some cubed toast to each. Lay a half-slice of cheese on top of the portions. Place the four bowls on the turntable and grill  for approx. 10 minutes to gratinate.

### Lentil soup with bacon

**Ingredients:**

200 g dry lentils, 50 g streaky bacon, 125 g belly pork, some suitable vegetables, e.g. parsley, carrots, celery, or leeks, 500 ml water, 1 bay-leaf, 250 g potatoes, 2 smoked cooked sausages, seasoning: salt, pepper, vinegar, sugar

**Preparation:**

Soak the lentils overnight in plenty of water. Clean and wash the vegetables and cut them into small pieces. Dice the meat and the bacon. Place the soaked lentils with 500 ml water, meat, bacon, vegetables and bay-leaf in a microwave-suitable bowl. Cover and cook at 960 watts for 8 to 10 minutes. In the meantime, peel, wash and dice the potatoes and slice the cooked sausages. Add the diced potato and the sliced cooked sausage to the cooking bowl and mix well. Cover and cook at 720 watts for approx. 15 minutes. Season to taste.

### Cauliflower cheese

**Ingredients:**

500 g washed cauliflower, 250 ml water, salt, 1 DS cornflour, 2 egg whites, 2 egg yolks, 1 carton of cream (200 ml), 2 DS chopped chives, 1 pinch of Cayenne, 150 g uncooked ham (lean), 50 g grated Emmental cheese.

**Preparation:**

Split the cauliflower into flowerets; place them in a microwave-suitable bowl with 250 ml water and some salt. Cover and cook at full power (1200 watts) for approx. 5 minutes. Decant and keep the stock. Stir the cornflour into the cream and add it to the stock. Cook at full power (1200 watts) for between 2 to 3 minutes, stirring several times. Add the egg yolks, chives and the Cayenne pepper. Beat the egg whites and fold in. Now place the cauliflower and the ham (in strips) into a flat dish, pour the sauce over them and sprinkle with cheese. Cook and gratinate using combination 2  at 720 watts for 16 to 18 minutes.

# Recipe suggestions

## Ingredients:

150 g macaroni, 500 ml water, 1 teaspoonful (TS) salt, 1 onion, 1 clove of garlic, 20 g butter, 300 g minced meat (e.g. half pork/half beef), 1 packet tomato puree with herbs (approx. 350 g), 400 g broccoli, 4 DS water, 1 tub soured cream (200 g), 150 g slices semi-mature Gouda, seasoning: salt, pepper

## Preparation:

Place 500 ml water with 1 teaspoonful of salt in a microwave-suitable bowl with a lid and bring it to the boil at full power (1200 watts) in approx. 8 minutes.

Then add the macaroni and cook at 960 watts for 2 to 3 minutes and at 480 watts for approx. 3 further minutes. Then collect in a colander and let it drip off water. Now braise the onions and the clove of garlic with the butter in a microwave-suitable bowl at 960 watts for approx. 3 minutes. Add the minced meat and the tomato puree – then cook the mixture for a further 6 to 7 minutes at 960 watts. Stir in 3/4 tub of soured cream and season to taste with salt and pepper.

Wash and clean the broccoli and place it with 4 dessert spoonfuls of water in a microwave-suitable bowl. Cover and precook at 960 watts for approx. 5 minutes and let it drip off water.

Place the macaroni, vegetables and minced meat sauce into a soufflé dish and mix together. Distribute the remaining 1/4 tub of soured cream over it and cover with the slices of cheese.

Cook and gratinate using combination 1  at 720 watts for approx. 15 minutes.

## Ingredients:

4 pork fillets à approx. 150 g, 350 g pink mushrooms, 150 g diced ham, 2 tubs of cream (400 ml), 2 DS tomato purée, seasoning: salt, pepper, paprika

## Preparation:

Season the pork fillets and place them in a flat soufflé dish. Clean and halve the mushrooms and add them with the ham to the fillets in the soufflé dish.

Stir the cream, tomato purée and paprika in a microwave-suitable bowl and cook for 3 to 4 minutes at 960 watts. Then pour this sauce over the fillets. Cook and gratinate using combination 1  at 480 watts for approx. 20 minutes.

## Ingredients:

1000 g potatoes, fat (to grease the soufflé dish), 2 DS breadcrumbs 1 tub cream (200 ml), 50 g grated Emmental cheese, butter (flaked), seasoning: salt, pepper

## Preparation:

Peel and wash the potatoes, then slice them thinly and season. Grease the soufflé dish. Layer the potatoes in the soufflé dish and pour the cream over them. Then sprinkle with the cheese and breadcrumbs and place the butter flakes on top.

Gratinate using combination 2  at 720 watts for approx. 18 minutes.

## Macaroni minced meat soufflé with broccoli

## Mushroom fillet of pork in piquant pepper sauce

## Gratinated potatoes

# Recipe suggestions

## Chicken fricassee

### Ingredients:

1 chicken (approx. 1000 g), 300 g mushrooms, 500 g asparagus, 250 ml meat stock, 100 ml cream, 2 packets white sauce (instant), 1 DS white wine, seasoning: salt, pepper, nutmeg

### Preparation:

Sprinkle the chicken with salt and place it in a microwave-suitable dish. Cover and cook at 1200 watts for approx. 15 minutes. Clean and halve the mushrooms, peel the asparagus and cut into 2 to 3 cm long pieces. Remove the skin and de-bone the cooked chicken; then cut the flesh into bite-sized pieces. Place the meat stock, chicken pieces, asparagus and the mushrooms into a microwave-suitable bowl. Cover and cook for approx. 12 minutes at 960 watts, stirring occasionally. Now stir in the cream and sauce powder and cook for between 3 and 4 minutes at 960 watts. Season to taste with white wine, salt, pepper and nutmeg.

## Green chicken stew

### Ingredients:

400 g chicken breast fillets, 1 small zucchini, 1 small green pepper, 125 ml instant chicken stock, 200 g leeks, 150 g kohlrabi, 150 g celeriac, 2 DS crème fraîche, 50 g curd cheese with herbs

### Preparation:

Clean and wash the vegetables. Cut the leeks into rings, slice kohlrabi and celeriac thinly. Braise in a microwave-suitable dish with a lid for approx. 5 minutes at 960 watts. Cut the chicken breast fillets into small pieces, slice the zucchini in half and dice the pepper. Place them together with the hot chicken stock and the other ingredients into the dish. Cover and cook for approx. 10 to 12 minutes at 960 watts, stirring occasionally. Then stir in the crème fraîche and the curd cheese with herbs.

## Breadcrumb or bacon dumplings

### Ingredients for 4 dumplings:

4 wheat bread rolls, 1/2 TS salt, 150 ml milk, 40 g butter, 3 eggs, 2-3 DS breadcrumbs, 2-3 DS chopped parsley, 30 g diced bacon (for bacon dumplings)

### Preparation:

Cut the bread into small pieces and sprinkle them with salt. Heat the milk in a microwave-suitable bowl (for 1 to 2 minutes at 1200 watts), then pour it over the bread roll pieces and let them stand for approx. 15 minutes. Beat the butter and eggs into a froth, add the softened bread pieces with the breadcrumbs and the parsley and knead everything into a good dough (Note: for bacon dumplings knead in the diced bacon). Moisten your hands and form 4 equal-sized dumplings and dip them briefly into cold water. Cover and cook for approx. 5 minutes at 720 watts - the dumplings are now ready to serve.

# Recipe suggestions

## Ingredients:

40 g flour, 30 g butter, 250 ml instant stock, 250 ml milk  
seasoning: salt, white pepper, sugar

## Preparation:

Place the flour, butter, the hot stock and milk in a microwave-suitable bowl, mix them well and cook for approx. 3 minutes at full power (1200 watt), stirring briskly from time to time. Then cook for a further 3 minutes at only 480 watts.

Stir again and season to taste.

## Ingredients:

250 ml milk, pith from 1/2 vanilla pod, 1 tub cream (250 ml),  
2 DS cornflour, 3 DS sugar, 1 egg yoke

## Preparation:

Stir the milk, vanilla pith, cream, cornflour and sugar in a microwave-suitable dish. Cook for approx. 3 to 4 minutes at 1200 watts, stirring once during the process. Stir the finished sauce thoroughly and mix in the egg yoke.

## Ingredients:

250 g short grain rice, 1 litre milk, 1 TS butter, 40 g sugar, cinnamon and  
sugar (for sprinkling) or fruit compote  
seasoning: salt

## Preparation:

Place the short grain pudding rice, milk, a pinch of salt, butter and sugar in a large microwave-suitable bowl. Cover and cook, for approx. 10 minutes at full power (1200 watts), bringing to the boil, then stir and let swell for approx 10 minutes at only 240 watts. Afterwards let the rice stand for a few minutes, then stir and sprinkle with cinnamon and sugar to taste or add fruit compote.

## Ingredients:

250 g frozen strawberries, 250 g frozen raspberries, 1 packet vanilla sugar,  
2 DS sugar, 2 DS cornflour

## Preparation:

First stir the cornflour into 3 DS water. Place the fruit in a microwave-suitable dish. Cover and defrost and heat for approx. 6 minutes at full power (1200 watts). Squash the fruit slightly and add the vanilla sugar, sugar and stirred cornflour. Stir well, cover and cook for approx. 5 minutes at 960 watts.

Then pour the red fruit pudding into dessert bowls and let cool. Serve the red fruit pudding with the vanilla sauce ...

## White sauce

## Vanilla sauce

## Rice pudding

## Red fruit pudding (with strawberries and raspberries)

*No responsibility is accepted for the recipes. All ingredients and preparation instructions are indicative only. You should modify the suggested recipes to suit your personal experience. We wish you success with your cooking and hope you enjoy your meals.*











# bifinett

[www.kompernass.com](http://www.kompernass.com)

design, photos and translations by ORFGEN Marketing & Communication · Essen / Germany



## Free Manuals Download Website

<http://myh66.com>

<http://usermanuals.us>

<http://www.somanuals.com>

<http://www.4manuals.cc>

<http://www.manual-lib.com>

<http://www.404manual.com>

<http://www.luxmanual.com>

<http://aubethermostatmanual.com>

Golf course search by state

<http://golfingnear.com>

Email search by domain

<http://emailbydomain.com>

Auto manuals search

<http://auto.somanuals.com>

TV manuals search

<http://tv.somanuals.com>