

BiGuard 50G

802.11g Dual WAN Security Gateway



User's Manual

Version Release 1.03 (FW:1.xx)

BiGuard 50G User's Manual

(Updated September, 2007)

Copyright Information

© 2007 Billion Electric Corporation, Ltd.

The contents of this publication may not be reproduced in whole or in part, transcribed, stored, translated, or transmitted in any form or any means, without the prior written consent of Billion Electric Corporation.

Published by Billion Electric Corporation. All rights reserved.

Disclaimer

Billion does not assume any liability arising out of the application of use of any products or software described herein. Neither does it convey any license under its patent rights nor the patent rights of others. Billion reserves the right to make changes in any products described herein without notice. This publication is subject to change without notice.

Trademarks

Mac OS is a registered trademark of Apple Computer, Inc.

Windows 98, Windows NT, Windows 2000, Windows Me and Windows XP are registered trademarks of Microsoft Corporation.

Safety Warnings



Your BiGuard 50G is built for reliability and long service life. For your safety, be sure to read and follow the following safety warnings.

- Read this installation guide thoroughly before attempting to set up your BiGuard 50G.
- Your BiGuard 50G is a complex electronic device. DO NOT open or attempt to repair it yourself. Opening or removing the covers can expose you to high voltage and other risks. In the case of malfunction, turn off the power immediately and have it repaired at a qualified service center. Contact your vendor for details.
- Connect the power cord to the correct supply voltage.
- Carefully place connecting cables to avoid people from stepping or tripping on them. DO NOT allow anything to rest on the power cord and DO NOT place the power cord in an area where it can be stepped on.
- DO NOT use BiGuard 50G in environments with high humidity or high temperatures.
- DO NOT use the same power source for BiGuard 50G as other equipment.
- DO NOT use your BiGuard 50G and any accessories outdoors.
- If you wall mount your BiGuard 50G, make sure that no electrical, water or gas pipes will be damaged during installation.
- DO NOT install or use your BiGuard 50G during a thunderstorm.
- DO NOT expose your BiGuard 50G to dampness, dust, or corrosive liquids.
- DO NOT use your BiGuard 50G near water.
- Be sure to connect the cables to the correct ports.
- DO NOT obstruct the ventilation slots on your BiGuard 50G or expose it to direct sunlight or other heat sources. Excessive temperatures may damage your device.
- DO NOT store anything on top of your BiGuard 50G.
- Only connect suitable accessories to your BiGuard 50G.
- Keep packaging out of the reach of children.
- If disposing of the device, please follow your local regulations for the safe disposal of electronic products to protect the environment.

Table of Contents

Chapter 1: Introduction

- 1.1 Overview
- 1.2 Product Highlights
 - 1.2.1 Increased Bandwidth, Scalability and Resilience
 - 1.2.2 Virtual Private Network Support
 - 1.2.3 Advanced Firewall Security
 - 1.2.4 Intelligent Bandwidth Management
- 1.3 Package Contents
 - 1.3.1 Front Panel
 - 1.3.2 Rear Panel
 - 1.3.3 Cabling

Chapter 2: Router Applications

- 2.1 Overview
- 2.2 Bandwidth Management with QoS
 - 2.2.1 QoS Technology
 - 2.2.2 QoS Policies for Different Applications
 - 2.2.3 Guaranteed / Maximum Bandwidth
 - 2.2.4 Policy Based Traffic Shaping
 - 2.2.5 Priority Bandwidth Utilization
 - 2.2.6 Management by IP or MAC address
 - 2.2.7 DiffServ (DSCP Marking)
 - 2.2.7 DSCP (Matching)
- 2.3 Outbound Traffic
 - 2.3.1 Outbound Fail Over
 - 2.3.2 Outbound Load Balancing
- 2.4 Inbound Traffic
 - 2.4.1 Inbound Fail Over
 - 2.4.2 Inbound Load Balancing
- 2.5 DNS Inbound
 - 2.5.1 DNS Inbound Fail Over
 - 2.5.2 DNS Inbound Load Balancing
- 2.6 Virtual Private Networking
 - 2.6.1 General VPN Setup

2.6.2 VPN Planning - Fail Over

2.6.3 Concentrator

Chapter 3: Getting Started

3.1 Overview

3.2 Before You Begin

3.3 Connecting Your Router

3.4 Configuring PCs for TCP/IP Networking

3.4.1 Overview

3.4.2 Windows XP

3.4.2.1 Configuring

3.4.2.2 Verifying Settings

3.4.3 Windows 2000

3.4.3.1 Configuring

3.4.3.2 Verifying Settings

3.4.4 Windows 98 / ME

3.4.4.1 Installing Components

3.4.4.2 Configuring

3.4.4.3 Verifying Settings

3.5 Factory Default Settings

3.5.1 Username and Password

3.5.2 LAN and WAN Port Addresses

3.6 Information From Your ISP

3.6.1 Protocols

3.6.2 Configuration Information

3.6.2.1 Windows

3.7 Web Configuration Interface

Chapter 4: Router Configuration

4.1 Overview

4.2 Status

4.2.1 ARP Table

4.2.2 Wireless Association

- 4.2.3 Routing Table
- 4.2.4 Session Table
- 4.2.5 DHCP Table
- 4.2.6 IPsec Status
- 4.2.7 PPTP Status
- 4.2.8 Traffic Statistics
- 4.2.9 CPU Statistics
- 4.2.10 System Log
- 4.3 Quick Start
 - 4.3.1 DHCP
 - 4.3.2 Static IP
 - 4.3.3 PPPoE
 - 4.3.4 PPTP
 - 4.3.5 Big Pond
- 4.4 Configuration
 - 4.4.1 LAN
 - 4.4.1.1 Ethernet
 - 4.4.1.2 Wireless Security
 - 4.4.1.3 WEP
 - 4.4.1.4 DHCP Server
 - 4.4.1.5 LAN Address Mapping
 - 4.4.2 WAN
 - 4.4.2.1 ISP Settings
 - 4.4.2.1.1 DHCP
 - 4.4.2.1.2 Static IP
 - 4.4.2.1.3 PPPoE
 - 4.4.2.1.4 PPTP
 - 4.4.2.1.5 Big Pond
 - 4.4.2.2 Bandwidth Settings
 - 4.4.2.3 WAN IP Alias
 - 4.4.3 Dual WAN
 - 4.4.3.1 General Settings
 - 4.4.3.2 Outbound Load Balance
 - 4.4.3.3 Inbound Load Balance
 - 4.4.3.4 Protocol Binding
 - 4.4.4 System
 - 4.4.4.1 Time Zone
 - 4.4.4.2 Remote Access

- 4.4.4.3 Firmware Upgrade
- 4.4.4.4 Backup / Restore
- 4.4.4.5 Restart
- 4.4.4.6 Password
- 4.4.5 Firewall
 - 4.4.5.1 Packet Filter
 - 4.4.5.2 URL Filter
 - 4.4.5.3 Ethernet MAC Filter
 - 4.4.5.4 Wireless MAC Filter
 - 4.4.5.5 Block WAN Request
 - 4.4.5.6 Intrusion Detection
- 4.4.6 VPN
 - 4.4.6.1 IPSec
 - 4.4.6.1.1 IPSec Wizard
 - 4.4.6.1.2 IPSec Policy
 - 4.4.6.2 PPTP
- 4.4.7 QoS
- 4.4.8 Virtual Server
 - 4.4.8.1 DMZ
 - 4.4.8.2 Port Forwarding Table
- 4.4.9 Advanced
 - 4.4.9.1 Static Route
 - 4.4.9.2 Dynamic DNS
 - 4.4.9.3 Device Management
- 5 Log & Email Alert
 - 5.1 Log Configuration
 - 5.2 System Log Server
 - 5.3 E-Mail Alert
- 6 Language
 - 6.1 English
 - 6.2 Simplified Chinese
 - 6.3 Traditional Chinese
- 7 Save Configuration To Flash
- 8 Logout

Chapter 5: Troubleshooting

5.1 Basic Functionality

- 5.1.1 Router Won't Turn On
- 5.1.2 LEDs Never Turn Off
- 5.1.3 LAN or Internet Port Not On
- 5.1.4 Forgot My Password
- 5.2 LAN Interface
 - 5.2.1 Can't Access Router from the LAN
 - 5.2.2 Can't Ping Any PC on the LAN
 - 5.2.3 Can't Access Web Configuration Interface
 - 5.2.3.1 Pop-up Windows
 - 5.2.3.2 Javascripts
 - 5.2.3.3 Java Permissions
- 5.3 WAN Interface
 - 5.3.1 Can't Get WAN IP Address from the ISP
- 5.4 ISP Connection
- 5.5 Problems with Date and Time
- 5.6 Restoring Factory Defaults

Appendix A: Product Specifications

Appendix B: Customer Support

Appendix C: FCC Interference Statement

Appendix D: Network, Routing, and Firewall Basics

D.1 Network Basics

D.1.1 IP Addresses

D.1.1.1 Netmask

D.1.1.2 Subnet Addressing

D.1.1.3 Private IP Addresses

D.1.2 Network Address Translation (NAT)

D.1.3 Dynamic Host Configuration Protocol (DHCP)

D.2 Router Basics

D.2.1 Why use a Router?

D.2.2 What is a Router?

D.2.3 Routing Information Protocol (RIP)

D.3 Firewall Basics

D.3.1 What is a Firewall?

D.3.2.1 Stateful Packet Inspection

D.3.2.2 Denial of Service (DoS) Attack

D.3.2 Why Use a Firewall?

Appendix E: Virtual Private Networking

E.1 What is a VPN?

E.1.1 VPN Applications

E.2 What is IPSec?

E.2.1 IPSec Security Components

E.2.1.1 Authentication Header (AH)

E.2.1.2 Encapsulating Security Payload (ESP)

E.2.1.3 Security Associations (SA)

- E.2.2 IPsec Mod
- E.2.3 Tunnel Mode AH
- E.2.4 Tunnel Mode ESP
- E.2.5 Internet Key Exchange (IKE)

Appendix F: IPsec Logs and Events

- F.1 IPsec Log Event Categories
- F.2 IPsec Log Event Table

Appendix G: Bandwidth Management with QoS

- G.1 Overview
- G.2 What is Quality of Service?
- G.3 How Does QoS Work?
- G.4 Who Needs QoS?
 - G.4.1 Home Users
 - G.4.2 Office Users

Appendix H: Router Setup Examples

- H.1 Outbound Fail Over
- H.2 Outbound Load Balancing
- H.3 Inbound Fail Over
- H.4 DNS Inbound Fail Over
- H.5 DNS Inbound Load Balancing
- H.6 Dynamic DNS Inbound Load Balancing
- H.7 VPN Configuration
 - H.7.1 LAN to LAN
 - H.7.2 Host to LAN
- H.8 IPsec Fail Over (Gateway to Gateway)
- H.9 VPN Concentrator
- H.10 Protocol Binding
- H.11 Intrusion Detection
- H.12 PPTP Remote Access by Windows XP
- H.13 PPTP Remote Access by BiGuard

Chapter 1: Introduction

1.1 Overview

Congratulations on purchasing BiGuard 50G Router from Billion. Combining a router with an Ethernet network switch, BiGuard 50G is a state-of-the-art device that provides everything you need to get your network connected to the Internet over your Cable or DSL connection quickly and easily. The Quick Start Wizard and DHCP Server will get first-time users up and running with minimal fuss and configuration, while sophisticated Quality of Service (QoS) and Load Balancing features grant advanced users total control over their network and Internet connection.

This manual illustrates the many features and functions of BiGuard 50G, and even takes you through the various ways you can apply this versatile device to your home or office. Take the time now to familiarize yourself with BiGuard 50G.

1.2 Product Highlights

1.2.1 Increased Bandwidth, Scalability and Resilience

With integrated Dual WAN ports, BiGuard 50G combines two broadband lines such as DSL or Cable into one Internet connection, providing optimal bandwidth sharing for multiple PCs on your network, or allowing maximum reliability with network redundancy. Load Balancing enables BiGuard 50G to efficiently balance network traffic across two connections, ideal for small-to-medium businesses that require increased bandwidth, network scalability, and resilience for mission-critical network and Internet applications. Auto failover can also be configured to ensure smooth, continuous service should one connection fail, providing maximum business uptime and productivity, plus uninterrupted service for you and your customers.

1.2.2 Virtual Private Network Support

BiGuard 50G supports comprehensive IPSec & PPTP VPN protocols for businesses to establish private encrypted tunnels over the Internet to ensure data transmission security among multiple sites, such as a branch office or dial-up connection. IPSec VPN is up to 30 simultaneous IPSec VPN connections are possible on BiGuard 50G, with performance of up to 30Mbps. PPTP VPN is up to 4 simultaneous PPTP VPN

connections are possible on BiGuard 50G, with performance of up to 10Mbps.

1.2.3 Advanced Firewall Security

Aside from intelligent broadband sharing, BiGuard 50G offers integrated firewall protection with advanced features to secure your network from outside attacks. Stateful Packet Inspection (SPI) determines if a data packet is permitted to enter the private LAN. Denial of Service (DoS) prevents hackers from interrupting network services via malicious attacks. In addition, BiGuard 50G firewall can be configured to alert you via email should your network come under fire, offering both tight network security and peace of mind.

1.2.4 Intelligent Bandwidth Management

BiGuard 50G utilizes Quality of Service (QoS) to give you full control over the priority of both incoming and outgoing data, ensuring that critical data such as customer information moves through your network, even while under a heavy load. Transmission speeds can be throttled to make sure users are not saturating bandwidth required for mission-critical data transfers. Priority types of upload data can also be changed, allowing BiGuard 50G to automatically sort out actual speeds for unmatched convenience.

1.3 Package Contents

BiGuard 50G iBusiness Security Gateway SMB

Getting Started CD-ROM

Quick Start Guide

AC-DC Power Adapter (12VDC, 1A)

1.3.1 Front Panel



LED	Function
Power	A solid light indicates a steady connection to a power source.
Status	A blinking light indicates the device is writing to flash memory.
LAN 1 – 4	Lit when connected to an Ethernet device. 10/100M : Lit green when connected at 100Mbps. Not lit when connected at 10Mbps. Link/ACT: Lit when device is connected. Blinking when data is transmitting/receiving.
WAN1	Lit when connected to an Ethernet device. 10/100M : Lit green when connected at 100Mbps. Not lit when connected at 10Mbps. Link/ACT: Lit when device is connected. Blinking when data is transmitting/receiving.
WAN2	Lit when connected to an Ethernet device. 10/100M : Lit green when connected at 100Mbps. Not lit when connected at 10Mbps. Link/ACT: Lit when device is connected. Blinking when data is transmitting/receiving.

1.3.2 Rear Panel

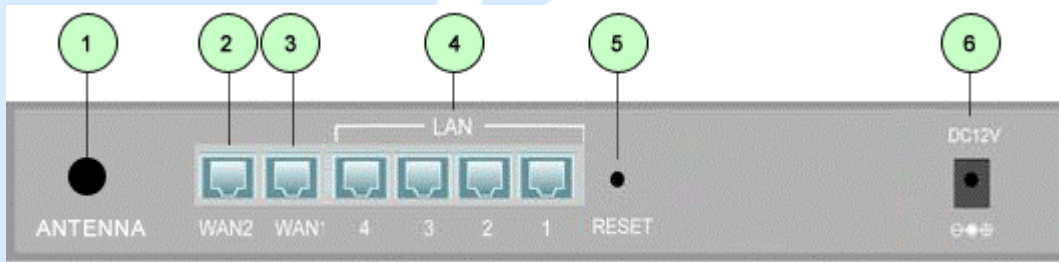

Port		Function
1	Wireless Antenna	One detachable 2.4GHz 5dbi SMA antenna
2	WAN2	WAN2 10/100M Ethernet port (with auto crossover support); connect xDSL/Cable modem here.
3	WAN1	WAN1 10/100M Ethernet port (with auto crossover support); connect xDSL/Cable modem here.
4	LAN 1 – 4	Connect a UTP Ethernet cable (Cat-5 or Cat-5e) to one of the eight LAN ports when connecting a PC to the network.
5	RESET	To reset the device and restore factory default settings, after the device is fully booted, press and hold RESET until the Status LED begins to blink.
6	DC12V	Connect DC Power Adapter here. (12VDC)

1.3.4 Cabling

Most Ethernet networks currently use unshielded twisted pair (UTP) cabling. The UTP cable contains eight conductors, arranged in four twisted pairs, and terminated with an RJ45 type connector.

One of the most common causes of networking problems is bad cabling. Make sure that all connected devices are turned on. On the front panel of BiGuard 50G, verify that the LAN link and WAN line LEDs are lit. If they are not, check to see that you are using the proper cabling.

Chapter 2: Router Applications

2.1 Overview

Your BiGuard 50G router is a versatile device that can be configured to not only protect your network from malicious attackers, but also ensure optimal usage of available bandwidth with Quality of Service (QoS) and both Inbound and Outbound Load Balancing. Alternatively, BiGuard 50G can also be set to redirect incoming and outgoing network traffic with the Fail Over capability, ensuring minimal downtime and increased reliability.

The following chapter describes how BiGuard 50G can work for you.

2.2 Bandwidth Management with QoS

Quality of Service (QoS) gives you full control over which types of outgoing data traffic should be given priority by the router. By doing so, the router can ensure that latency-sensitive applications like voice, bandwidth-consuming data like gaming packets, or even mission critical files efficiently move through the router even under a heavy load. You can throttle the speed at which different types of outgoing data pass through the router. In addition, you can simply change the priority of different types of upload data and let the router sort out the actual speeds.

2.2.1 QoS Technology

QoS generally involves the prioritization of network traffic. QoS is comprised of three major components: Classifier, Meter, and Scheduler. Each of these components has a distinct role in ensuring that incoming and outgoing data is managed according to user specifications.

The Classifier analyses incoming packets and marks each one according to configured parameters. The Meter communicates the drop priority to the Scheduler and measures the temporal priorities of the output stream against configured parameters. Finally, the Scheduler schedules each packet for transmission based on information from both the Classifier and the Meter.

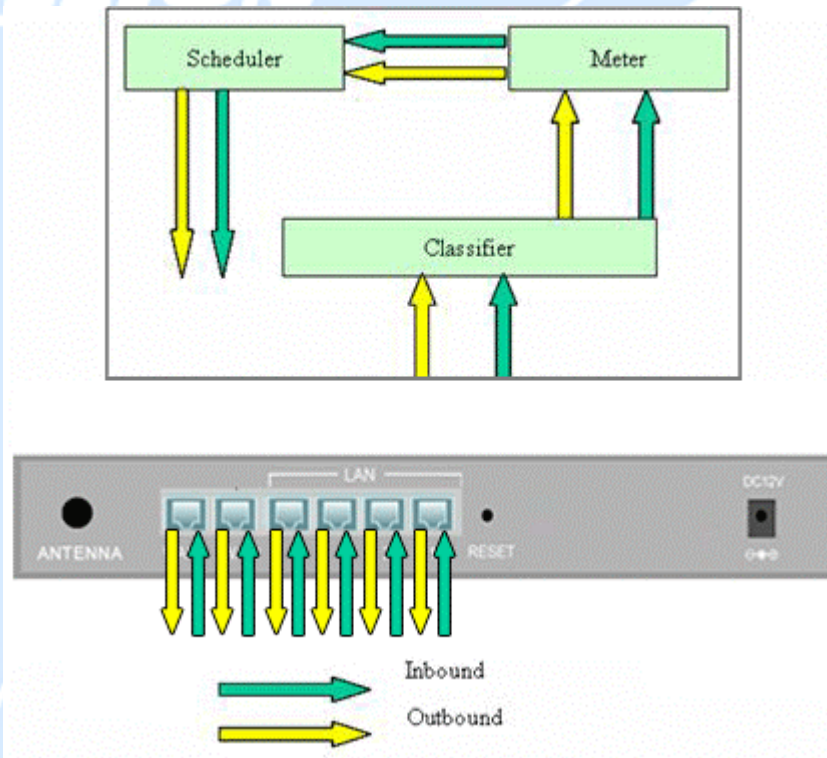

2.2.2 QoS Policies for Different Applications

By setting different QoS policies according to the applications you are running, you can use BiGuard 50G to optimize the bandwidth that is being used on your network.

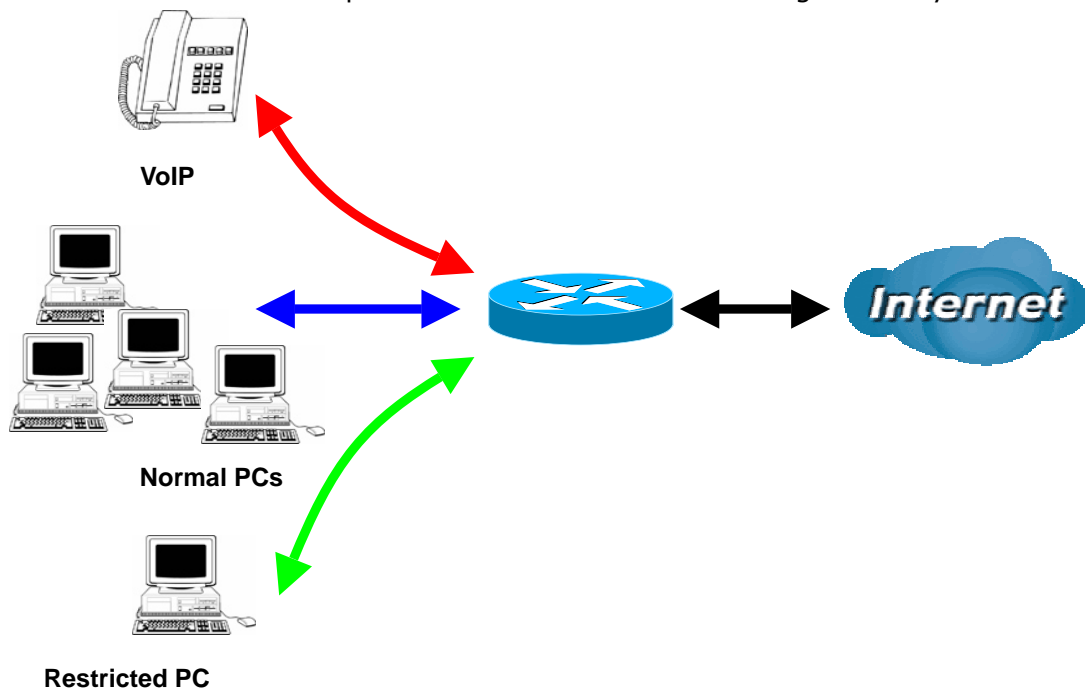

As illustrated in the diagram above, applications such as Voiceover IP (VoIP) require low network latencies to function properly. If bandwidth is being used by other

applications such as an FTP server, users using VoIP will experience network lag and/or service interruptions during use. To avoid this scenario, this network has assigned VoIP with a guaranteed bandwidth and higher priority to ensure smooth communications. The FTP server, on the other hand, has been given a maximum bandwidth cap to make sure that regular service to both VoIP and normal Internet applications is uninterrupted.

2.2.3 Guaranteed / Maximum Bandwidth

Setting a Guaranteed Bandwidth ensures that a particular service receives a minimum percentage of bandwidth. For example, you can configure BiGuard 50G to reserve 10% of the available bandwidth for a particular computer on the network to transfer files.

Alternatively you can set a Maximum Bandwidth to restrict a particular application to a fixed percentage of the total throughput. Setting a Maximum Bandwidth of 20% for a file sharing program will ensure that no more than 20% of the available bandwidth will be used for file sharing.

Quality of Service	
Add QoS Rule	
Interface	WAN1 Outbound
Application	FTP
Guaranteed	10 %
Maximum	20 %
Priority	6 (Lowest)
DSCP Marking	Disable
Address Type	<input checked="" type="radio"/> IP Address <input type="radio"/> MAC Address
Bandwidth Type	<input checked="" type="radio"/> Shared Bandwidth <input type="radio"/> Bandwidth per Source IP Address
Source IP Address Range	From 192.168.100.1 To 192.168.100.100
Destination IP Address Range	From 0.0.0.0 To 255.255.255.255
Protocol	Any
Source Port Range	From 1 To 65535
Destination Port Range	From 1 To 65535
DSCP	Any
Schedule	**Always
<input type="button" value="Apply"/>	

2.2.4 Policy Based Traffic Shaping

Policy Based Traffic Shaping allows you to apply specific traffic policies across a range of IP addresses or ports. This is particularly useful for assigning different policies for different PCs on the network. Policy based traffic shaping lets you better

manage your bandwidth, providing reliable Internet and network service to your organization.

Quality of Service

Add QoS Rule

Interface	WAN1 Outbound	
Application	FTP	
Guaranteed	10	%
Maximum	20	%
Priority	6 (Lowest)	
DSCP Marking	Disable	
Address Type	<input checked="" type="radio"/> IP Address <input type="radio"/> MAC Address	
Bandwidth Type	<input checked="" type="radio"/> Shared Bandwidth <input type="radio"/> Bandwidth per Source IP Address	
Source IP Address Range	From 192.168.100.1	To 192.168.100.100
Destination IP Address Range	From 0.0.0.0	To 255.255.255.255
Protocol	Any	
Source Port Range	From 1	To 65535
Destination Port Range	From 1	To 65535
DSCP	Any	
Schedule	**Always	

2.2.5 Priority Bandwidth Utilization

Assigning priority to a certain service allows BiGuard 50G to give either a higher or lower priority to traffic from this particular service. Assigning a higher priority to an application ensures that it is processed ahead of applications with a lower priority and vice versa.

Quality of Service

Add QoS Rule

Interface	WAN1 Outbound		
Application	FTP		
Guaranteed	10	%	
Maximum	20	%	
Priority	3 (Normal) ▼		
DSCP Marking	0 (Highest) ▼		
Address Type	<input type="radio"/> IP Address <input type="radio"/> MAC Address		
Bandwidth Type	<input checked="" type="radio"/> Shared Bandwidth <input type="radio"/> Bandwidth per Source IP Address		
Source IP Address Range	From 192.168.100.1	To	192.168.100.100
Destination IP Address Range	From 0.0.0.0	To	255.255.255.255
Protocol	Any ▼		
Source Port Range	From 1	To	65535
Destination Port Range	From 1	To	65535
DSCP	Any ▼		
Schedule	**Always		

2.2.6 Management by IP or MAC address

BiGuard 50G can also be configured to apply traffic policies based on a particular IP or MAC address. This allows you to quickly assign different traffic policies to a specific computer on the network.

Quality of Service

Add QoS Rule

Interface	WAN1 Outbound		
Application	FTP		
Guaranteed	10	%	
Maximum	20	%	
Priority	3 (Normal) ▼		
DSCP Marking	Disable ▼		
Address Type	<input checked="" type="radio"/> IP Address <input type="radio"/> MAC Address		
Bandwidth Type	<input checked="" type="radio"/> Shared Bandwidth <input type="radio"/> Bandwidth per Source IP Address		
Source IP Address Range	From 192.168.100.1	To	192.168.100.100
Destination IP Address Range	From 0.0.0.0	To	255.255.255.255
Protocol	Any ▼		
Source Port Range	From 1	To	65535
Destination Port Range	From 1	To	65535
DSCP	Any ▼		
Schedule	**Always		

DiffServ (DSCP Marking)

DiffServ (a.k.a. DSCP Marking) allows you to classify traffic based on IP DSCP values.

Other interfaces can match traffic based on the DSCP markings. DSCP markings are used to decide how packets should be treated, and is a useful tool to give precedence to varying types of data.

Quality of Service	
Add QoS Rule	
Interface	WAN1 Outbound
Application	FTP
Guaranteed	10 %
Maximum	20 %
Priority	3 (Normal)
DSCP Marking	Disable
Address Type	Disable
Bandwidth Type	<input type="radio"/> Best Effort <input type="radio"/> Premium <input type="radio"/> Bandwidth per Source IP Address
Source IP Address Range	<input type="text"/> To 192.168.100.100
Destination IP Address Range	<input type="text"/> To 255.255.255.255
Protocol	
Source Port Range Helper	<input type="text"/> To 65535
Destination Port Range Helper	<input type="text"/> To 65535
DSCP	<input type="text"/>
Schedule Candidates	**Always

2.2.8 DSCP (Matching)

Just like the DSCP Marking, DSCP is used on traffics (Both inbound rules and outbound rules have DSCP matching). DSCP matching is used to identify traffic for the rule. (It is just like what source IP and destination IP do). When this option of the QoS rule is selected, the QoS rule will only be applied to the packets whose DSCP field's IP header matches the criteria selected. These markings can be used to identify traffic within the network.

2.3 Outbound Traffic

This section outlines some of the ways you can use BiGuard 50G to manage outbound traffic.

2.3.1 Outbound Fail Over

Configuring BiGuard 50G for Outbound Fail Over allows you to ensure that outgoing traffic is uninterrupted by having BiGuard 50G default to WAN2 should WAN1 fail.

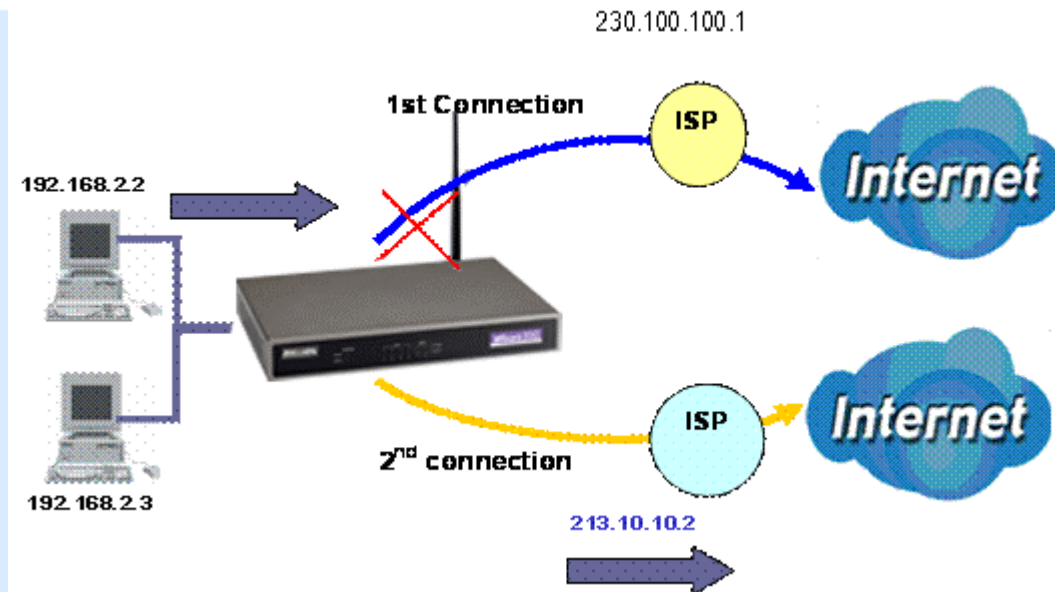

In the above example, PC 1 (IP_192.168.2.2) and PC 2 (IP_192.168.2.3) are connected to the Internet via WAN1 (IP_230.100.100.1) on BiGuard 50G. Should WAN1 fail, Outbound Fail Over tells BiGuard 50G to reroute outgoing traffic to WAN2 (IP_213.10.10.2). Configuring your BiGuard 50G for Outbound Fail Over provides a more reliable connection for your outgoing traffic.

Please refer to appendix H for example settings.

2.3.2 Outbound Load Balancing

Outbound Load Balancing allows BiGuard 50G to intelligently manage outbound traffic based on the amount of load of each WAN connection.

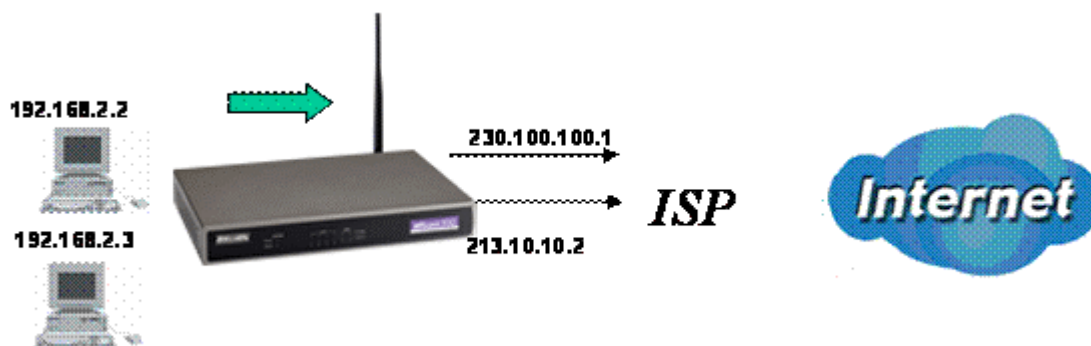

In the above example, PC 1 (IP_192.168.2.2) and PC 2 (IP_192.168.2.3) are

connected to the Internet via WAN1 (IP_230.100.100.1) and WAN2 (IP_213.10.10.2) on BiGuard 50G. You can configure BiGuard 50G to balance the load of each WAN port with one of two mechanisms:

1. Session (by session/by traffic/weight of link capability)
2. IP Hash (by traffic/weight of link capability)

The IP Hash mechanism will ensure that the traffic from the same source IP address and destination IP address will go through the same WAN port. This is useful for some server applications that need to identify the source IP address of the client.

By balancing the load between WAN1 and WAN2, your BiGuard 50G can ensure that outbound traffic is efficiently handled by making sure that both ports are equally sharing the load, preventing situations where one port is completely saturated by outbound traffic.

Please refer to appendix H for example settings.

2.4 Inbound Traffic

Learn how BiGuard 50G can handle inbound traffic in the following section.

2.4.1 Inbound Fail Over

Configuring BiGuard 50G for Inbound Fail Over allows you to ensure that incoming traffic is uninterrupted by having BiGuard 50G default to WAN2 should WAN1 fail.

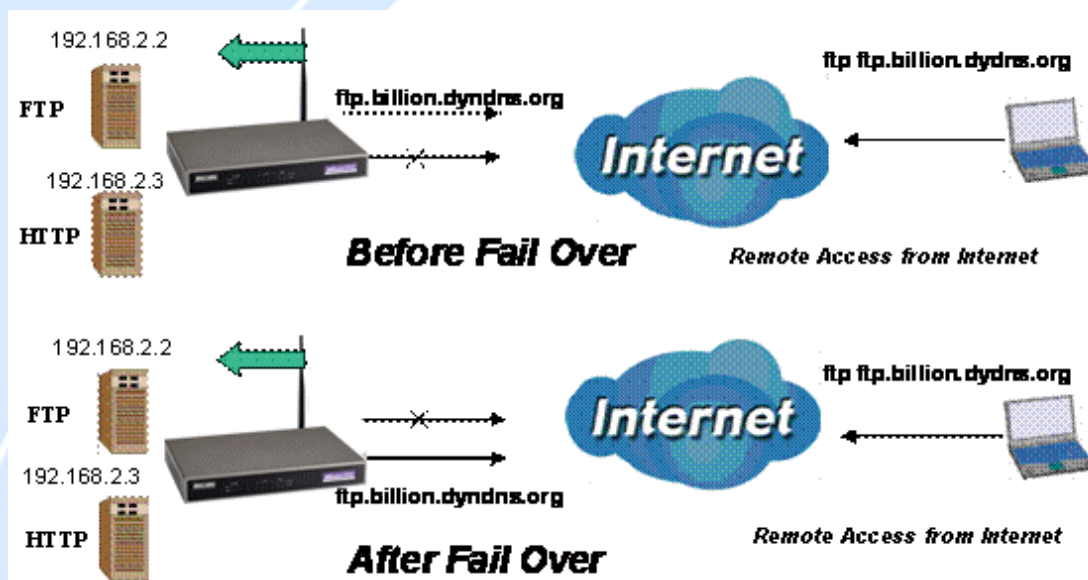

In the above example, an FTP Server (IP_192.168.2.2) and an HTTP Server (IP_192.168.2.3) are connected to the Internet via WAN1 (ftp.billion.dydns.org) on BiGuard 50G. A remote computer is trying to access these servers via the Internet. Under normal circumstances, the remote computer will gain access to the network via WAN1. Should WAN1 fail, Inbound Fail Over tells BiGuard 50G to reroute incoming traffic to WAN2 by using the Dynamic DNS mechanism. Configuring your BiGuard 50G for Inbound Fail Over provides a more reliable connection for your incoming traffic.

Please refer to appendix H for example settings.

2.4.2 Inbound Load Balancing

Inbound Load Balancing allows BiGuard 50G to intelligently manage inbound traffic based on the amount of load of each WAN connection.

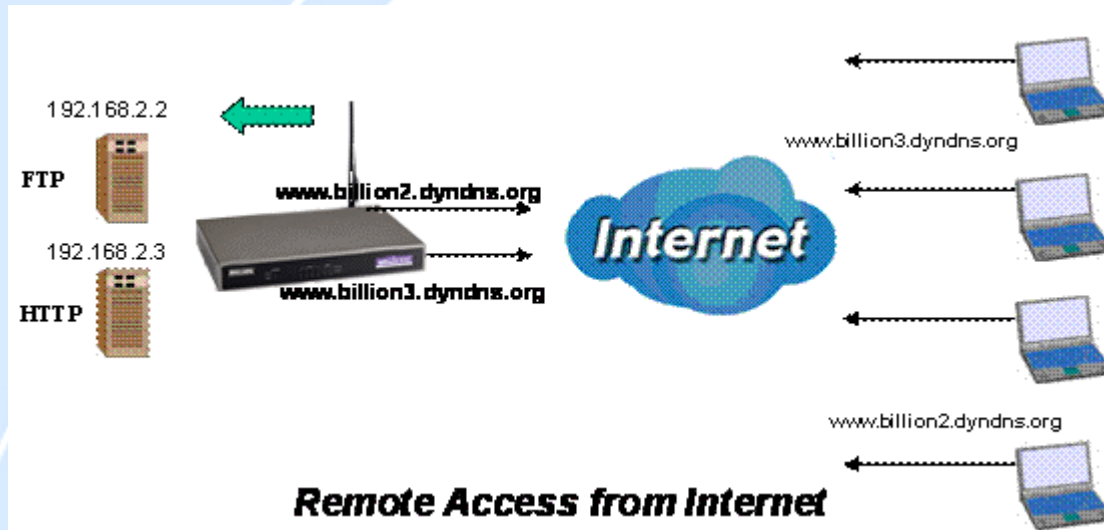

In the above example, an FTP server (IP_192.168.2.2) and an HTTP server (IP_192.168.2.3) are connected to the Internet via WAN1 (www.billion2.dyndns.org) and WAN2 (www.billion3.dyndns.org) on BiGuard 50G. Remote PCs are attempting to access the servers via the Internet. Using Inbound Load Balancing, BiGuard 50G can direct incoming requests to the correct WAN port based on group assignment. For example, a sales force can be directed to www.billion2.dyndns.org, while the R&D group can access www.billion3.dyndns.org. By balancing the load between WAN1 and WAN2, your BiGuard 50G can ensure that inbound traffic is efficiently handled with both ports equally sharing the load, preventing situations where service is slow because one port is completely saturated by inbound traffic.

Please refer to appendix H for example settings.

2.5 DNS Inbound

Using DNS Inbound is a great way to intelligently direct network traffic.

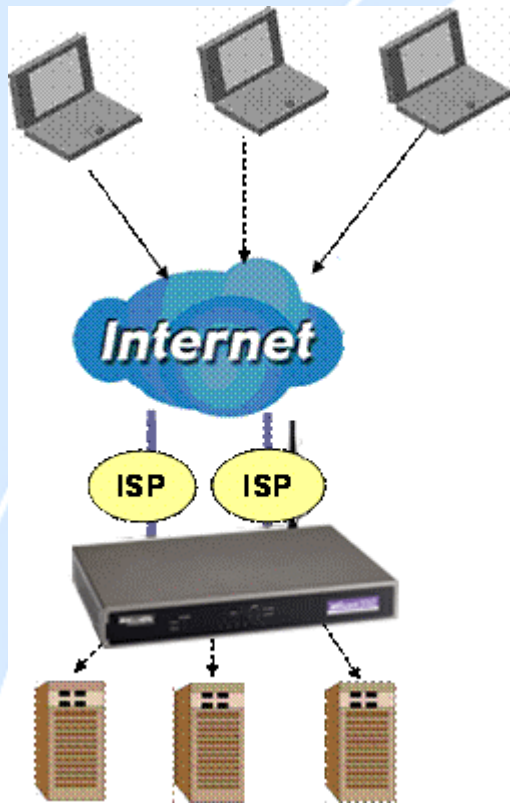

DNS Inbound is a three step process. First, a DNS request is made to the router via a remote PC. BiGuard 50G, based on settings specified by the user, will direct the requesting PC to the correct WAN port by replying the selected WAN IP address through the built-in DNS server. The remote PC then accesses the network via the specified WAN port. How BiGuard 50G directs this traffic through the built-in DNS server depends on whether it is configured for Fail Over or Load Balancing.

Learn how to make DNS Inbound on BiGuard 50G work for you in the following section.

2.5.1 DNS Inbound Fail Over

BiGuard 50G can be configured to reply the WAN2 IP address for the DNS domain name request should WAN1 fail.

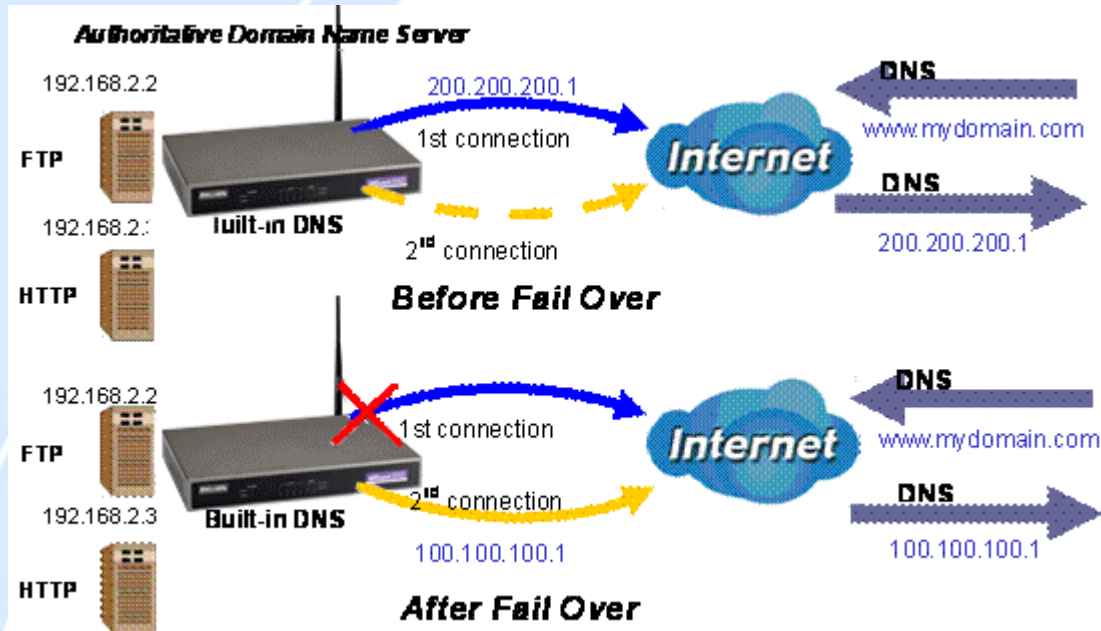

In the above example, an FTP Server (IP_192.168.2.2) and an HTTP Server (IP_192.168.2.3) are connected to the Internet via WAN1 (IP_200.200.200.1) on BiGuard 50G. A remote computer is trying to access these servers via the Internet, and makes a DNS request. The DNS request (www.mydomain.com) will be sent through WAN1 (200.200.200.1) to the built-in DNS server. The DNS server will reply 200.200.200.1 because this is the only active WAN port. Should WAN1 fail, BiGuard 50G will instead reply with WAN2's IP address (100.100.100.1), and the remote PC will gain access to the network via WAN2. By configuring BiGuard 50G for DNS Inbound Fail Over, incoming requests will enjoy increased reliability when accessing your network.

Please refer to appendix H for example settings.

2.5.2 DNS Inbound Load Balancing

DNS Inbound Load Balancing allows BiGuard 50G to intelligently manage inbound traffic based on the amount of load of each WAN connection by assigning the IP address with the lowest traffic load to incoming requests.

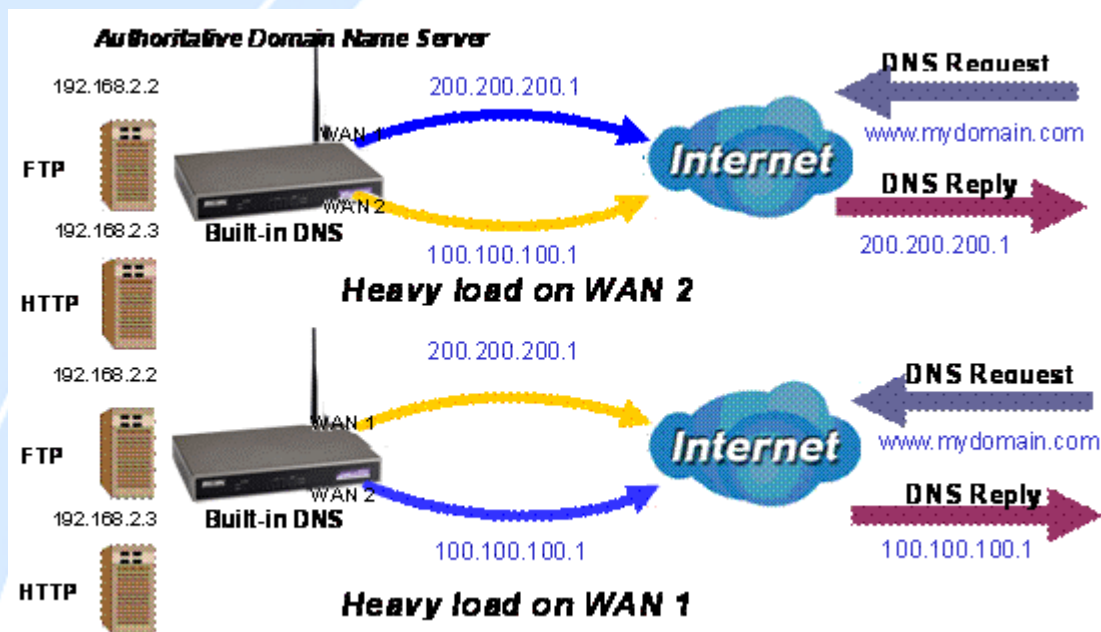

In the above example, an FTP server (IP_192.168.2.2) and an HTTP server (IP_192.168.2.3) are connected to the Internet via WAN1 (IP_200.200.200.1) and WAN2 (IP_100.100.100.1) on BiGuard 50G. Remote PCs are attempting to access the servers via the Internet by making a DNS request, entering a URL (www.mydomain.com). Using a load balancing algorithm, BiGuard 50G can direct incoming requests to either WAN port based on the amount of load each WAN port is currently experiencing. If WAN2 is experiencing a heavy load, BiGuard 50G responds to incoming DNS requests with WAN1. By balancing the load between WAN1 and WAN2, your BiGuard 50G can ensure that inbound traffic is efficiently handled, making sure that both ports are equally sharing the load and preventing situations where service is slow because one port is completely saturated by inbound traffic.

Please refer to appendix H for example settings.

A typical scenario of how traffic is directed with DNS Inbound Load Balancing is illustrated below:

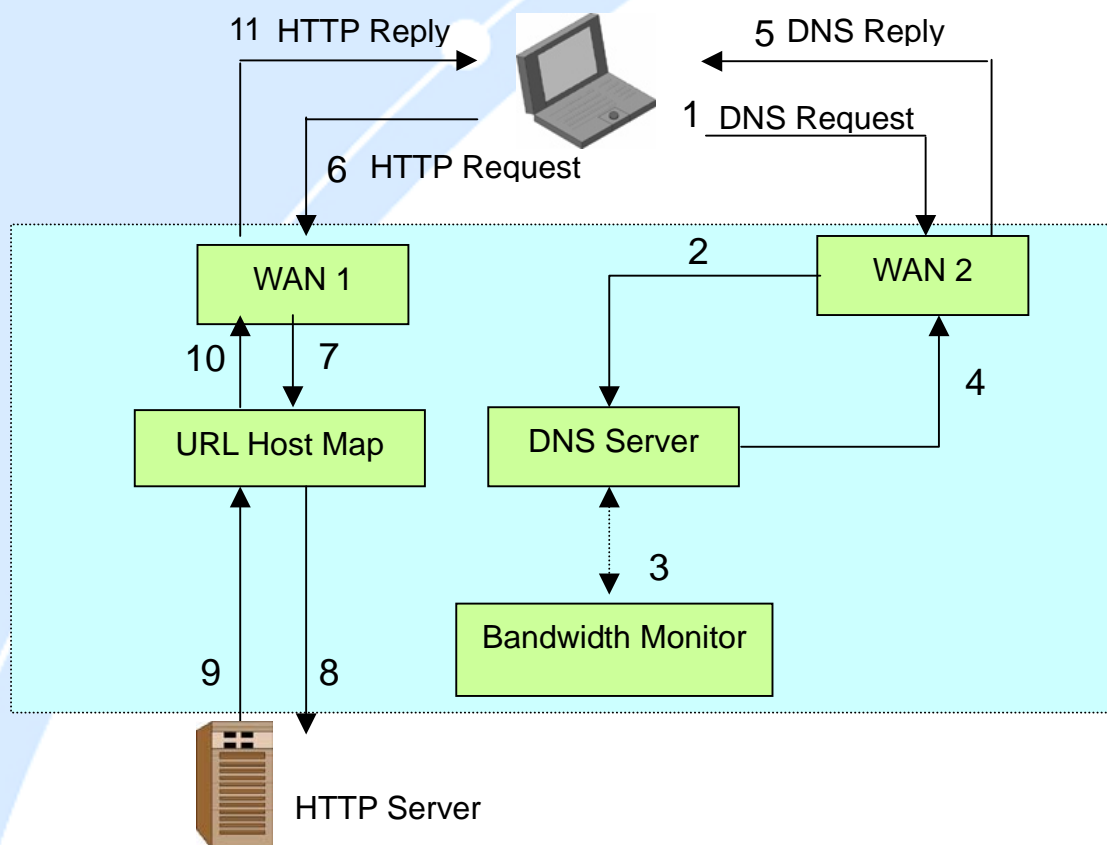

In the example above, the client is making a DNS request. The request is sent to the DNS server of BiGuard 50G through WAN2 (1). WAN2 will route this request to the embedded DNS server of BiGuard 50G (2). BiGuard 50G will analyze the bandwidth of both WAN1 and WAN2 and decide which WAN IP to reply to the request (3). After the decision is made, BiGuard 50G will route the DNS reply to the user through WAN2 (4). The user will receive the DNS reply with the IP address of WAN1 (5). The browser will initiate an HTTP request to the WAN1 IP address (6). The HTTP request will be send to BiGuard 50G's URL Host Map (7). The Host Map will then redirect the HTTP request to the HTTP server (8). The HTTP server will reply (9). The URL Host Map will route the packet through WAN1 to the user (10). Finally, the client will receive an HTTP reply packet (11).

2.6 Virtual Private Networking

A Virtual Private Network (VPN) enables you to send data between two computers across a shared or public network in a manner that emulates the properties of a point-to-point private link. As such, it is perfect for connecting branch offices to headquarters across the Internet in a secure fashion.

The following section discusses Virtual Private Networking with BiGuard 50G.

2.6.1 General VPN Setup

There are typically three different VPN scenarios. The first is a **Gateway to Gateway** setup, where two remote gateways communicate over the Internet via a secure tunnel.

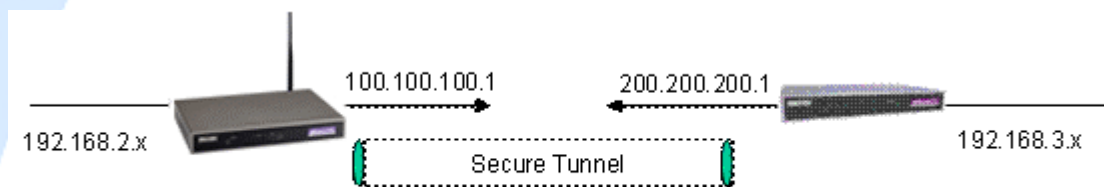

The next type of VPN setup is the **Gateway to Multiple Gateway** setup, where one gateway (Headquarters) is communicating with multiple gateways (Branch Offices) over the Internet. As with all VPNs, data is kept secure with secure tunnels.

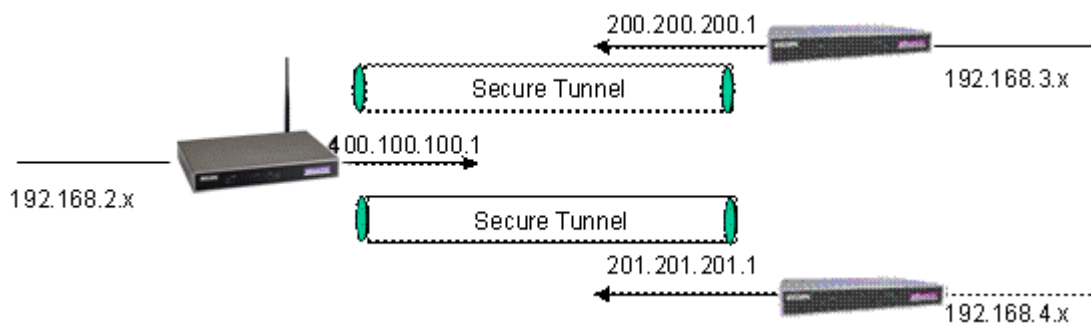

The final type of VPN setup is the **Client to Gateway**. A good example of where this can be applied is when a remote sales person accesses the corporate network over a secure VPN tunnel.

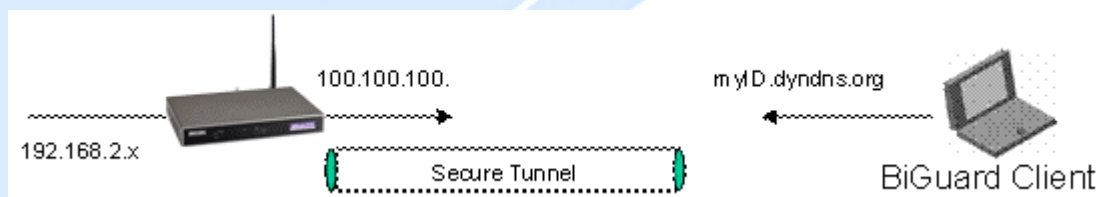

VPN provides a flexible, cost-efficient, and reliable way for companies of all sizes to stay connected. One of the most important steps in setting up a VPN is proper planning. The following sections demonstrate the various ways of using BiGuard 50G to setup your VPN.

2.6.2 VPN Planning - Fail Over

Configuring your VPN with Fail Over allows BiGuard 50G to automatically default to WAN2 should WAN1 fail.

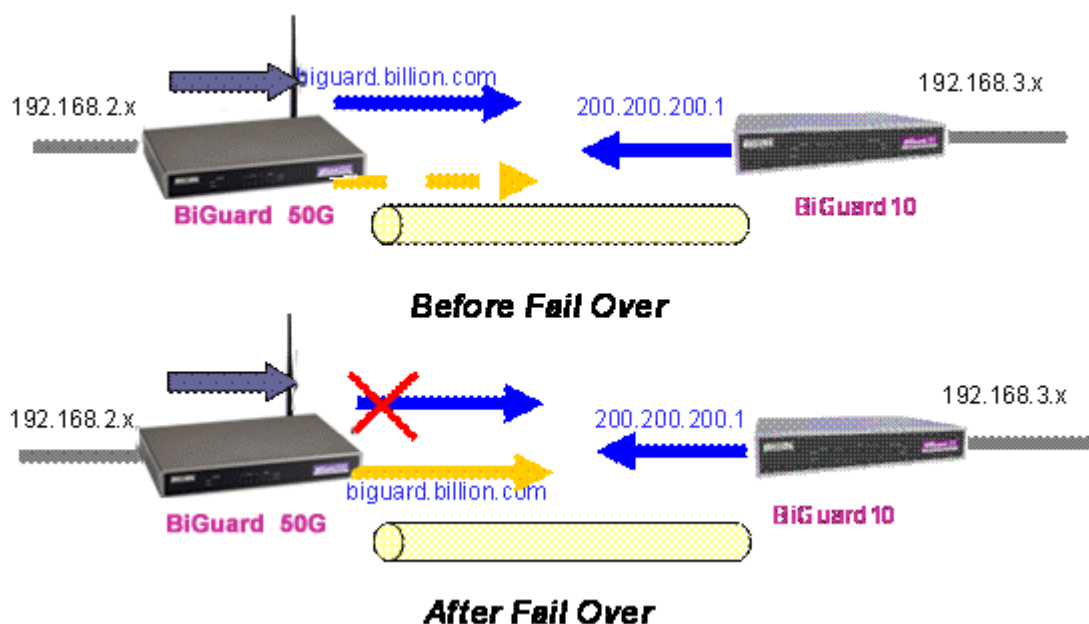

Because the dynamic domain name biguard.billion.com is configured for both WAN1 and WAN2, the active WAN port will announce the domain name through the WAN IP address. The remote gateway will then be able to connect to the VPN through the domain name.

In this Gateway to Gateway example, BiGuard 50G is communicating to a remote

gateway using WAN1 through a secure VPN tunnel. Should WAN1 fail, outbound traffic from BiGuard 50G will automatically be redirected to WAN2. This process is completely transparent to the remote gateway, as BiGuard 50G will automatically update the domain name (biguard.billion.com) with the WAN2 IP address. Configuring a Gateway to Multiple Gateway setup with Fail Over is similar, as shown below:

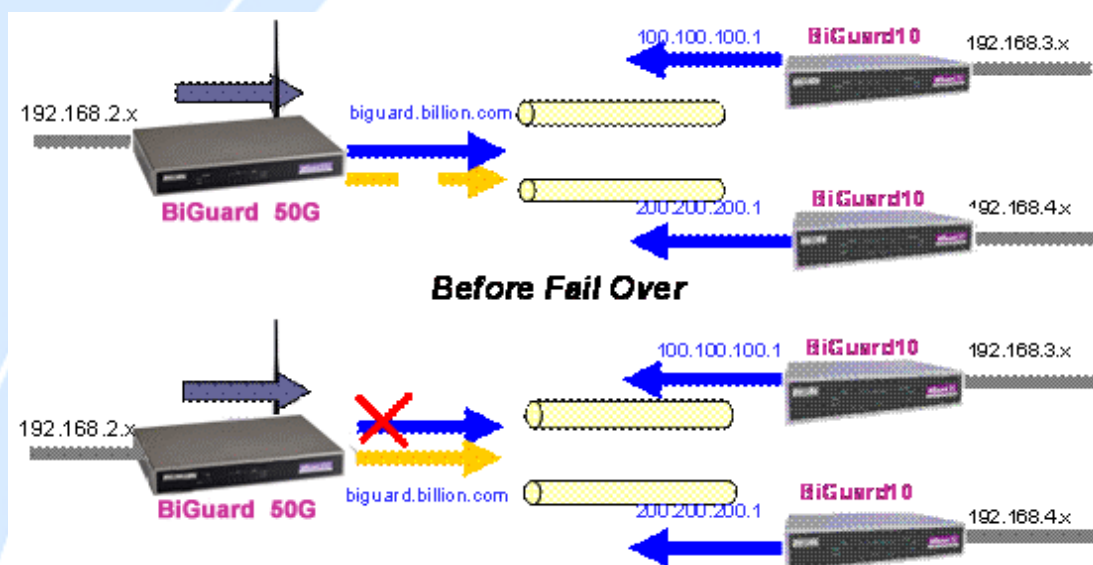

Configuring BiGuard 50G for Fail Over provides added reliability to your VPN.

2.6.3 Concentrator

The VPN Concentrator provides an easy way for branch offices to connect to headquarter through a VPN tunnel. All branch office traffic will be redirected to the VPN tunnel to headquarter with the exception of LAN-side traffic. This way, all branch offices can connect to each other through headquarter via the headquarter's firewall management. You can also configure BiGuard 50G to function as a VPN Concentrator:

Please refer to appendix H for example settings.

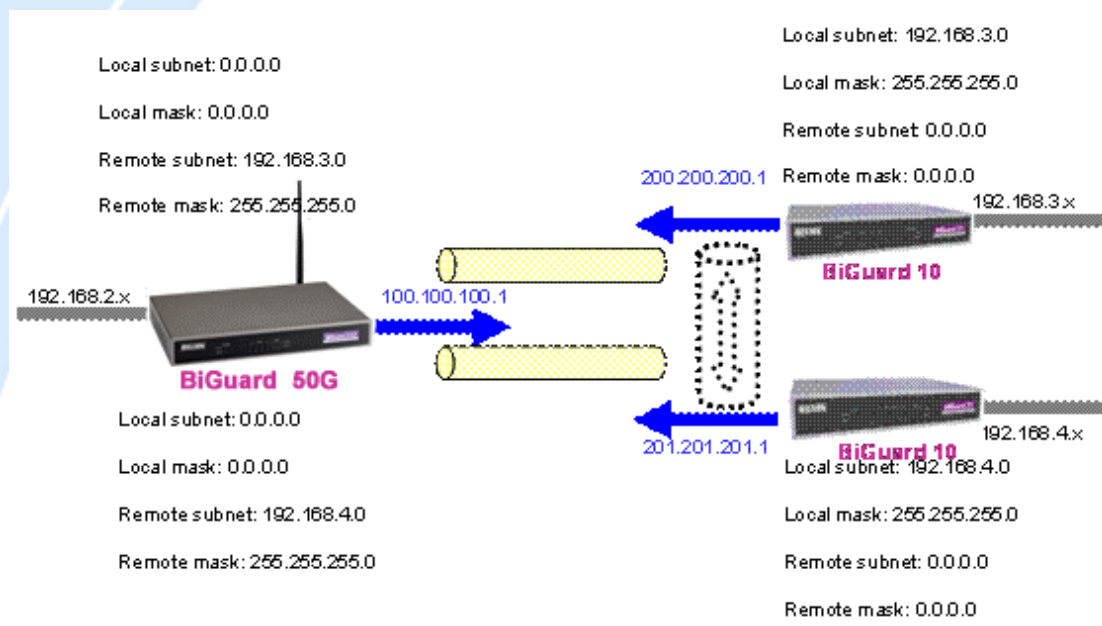

Chapter 3: Getting Started

3.1 Overview

BiGuard 50G is designed to be a powerful and flexible network device that is also easy to use. With an intuitive web-based configuration, BiGuard 50G allows you to administer your network via virtually any Java-enabled web browser and is fully compatible with Linux, Mac OS, and Windows 98/Me/NT/2000/XP operating systems.

The following chapter takes you through the very first steps to configuring your network for BiGuard 50G. Take a look and see how easy it is to get your network up and running.

3.2 Before You Begin

BiGuard 50G is a flexible and powerful networking device. To simplify the configuration process and increase the efficiency of your network, consider the following items before setting up your network for the first time:

1. Plan your network

Decide whether you are going to use one or both WAN ports. For one WAN port, you may need a fully qualified domain name either for convenience or if you have a dynamic IP address. If you are going to use both WAN ports, determine whether you are going to use them in fail over mode for increased network reliability or load balancing mode for maximum bandwidth efficiency. See **Chapter 2: Router Applications** for more information.

2. Set up your accounts

Have access to the Internet and locate the Internet Service Provider (ISP) configuration information. Each BiGuard 50G WAN port must be configured separately, whether you are using a separate ISP for each WAN port or are having the traffic of both WAN ports routed through the same ISP.

3. Determine your network management approach

BiGuard 50G is capable of remote management. However, this feature is not active by default. If you reset the device, remote administration must be enabled again. If you decide to manage your network remotely, be sure to change the default

password for security reason.

4. Prepare to physically connect BiGuard 50G to Cable or DSL modems and a computer.

Be sure to also review the **Safety Warnings** located in the preface of this manual before working with your BiGuard 50G.

3.3 Connecting Your Router

Connecting BiGuard 50G is an easy three-step process:

1. Connect BiGuard 50G to your LAN by connecting Ethernet cables from your networked PCs to the LAN ports on the router. Connect BiGuard 50G to your broadband Internet connection via router's WAN port.



2. Plug BiGuard 50G to an AC outlet with the included AC Power Adapter.



3. Ensure that the Power and WAN LEDs are solidly lit, and that on any LAN port that has an Ethernet cable plugged in the LED is also solidly lit. The Status LED will remain solid as the device boots. Once the boot sequence is complete, the LED will shut off, indicating that BiGuard 50G is ready.

If the router does not power on, please refer to **Chapter 5: Troubleshooting** for possible solutions.

3.4 Configuring PCs for TCP/IP Networking

Now that your BiGuard 50G is connected properly to your network, it's time to configure your networked PCs for TCP/IP networking.

In order for your networked PCs to communicate with your router, they must have the following characteristics:

1. Have a properly installed and functioning Ethernet Network Interface Card (NIC).
2. Be connected to BiGuard 50G, either directly or through an external repeater hub via an Ethernet cable.
3. Have TCP/IP installed and configured with an IP address.

The IP address for each PC may be a fixed IP address or one that is obtained from a DHCP server. If using a fixed IP address, it is important to remember that it must be in the same subnet as the router. The default IP address of BiGuard 50G is 192.168.1.254 with a subnet mask of 255.255.255.0. Using the default configuration, networked PCs must reside in the same subnet, and have an IP address in the range of 192.168.1.1 to 192.168.1.253. However, you'll find that the quickest and easiest way to configure the IP addresses for your PCs is to obtain the IP addresses automatically by using the router as a DHCP server.

If you are unable to access the web configuration interface, check to see if you have any software-based firewalls installed on your PCs, as they can cause problems accessing the 192.168.1.254 IP address of BiGuard 50G.

The following sections outline how to set up your PCs for TCP/IP networking. Refer to the applicable section for your PC's operating system.

3.4.1 Overview

Before you begin, make sure that the TCP/IP protocol and a functioning Ethernet network adapter is installed on each of your PCs.

The following operating systems already include the necessary software components you need to install TCP/IP on your PCs:

BILLION

- Windows 95/98/Me/NT/2000/XP
- Mac OS 7 and later

If you are using Windows 3.1, you must purchase a third-party TCP/IP application package.

Any TCP/IP capable workstation can be used to communicate with or through BiGuard 50G. To configure other types of workstations, please consult the manufacturer's documentation.

3.4.2 Windows XP

3.4.2.1 Configuring

1. Select **Start > Settings > Network Connections**.

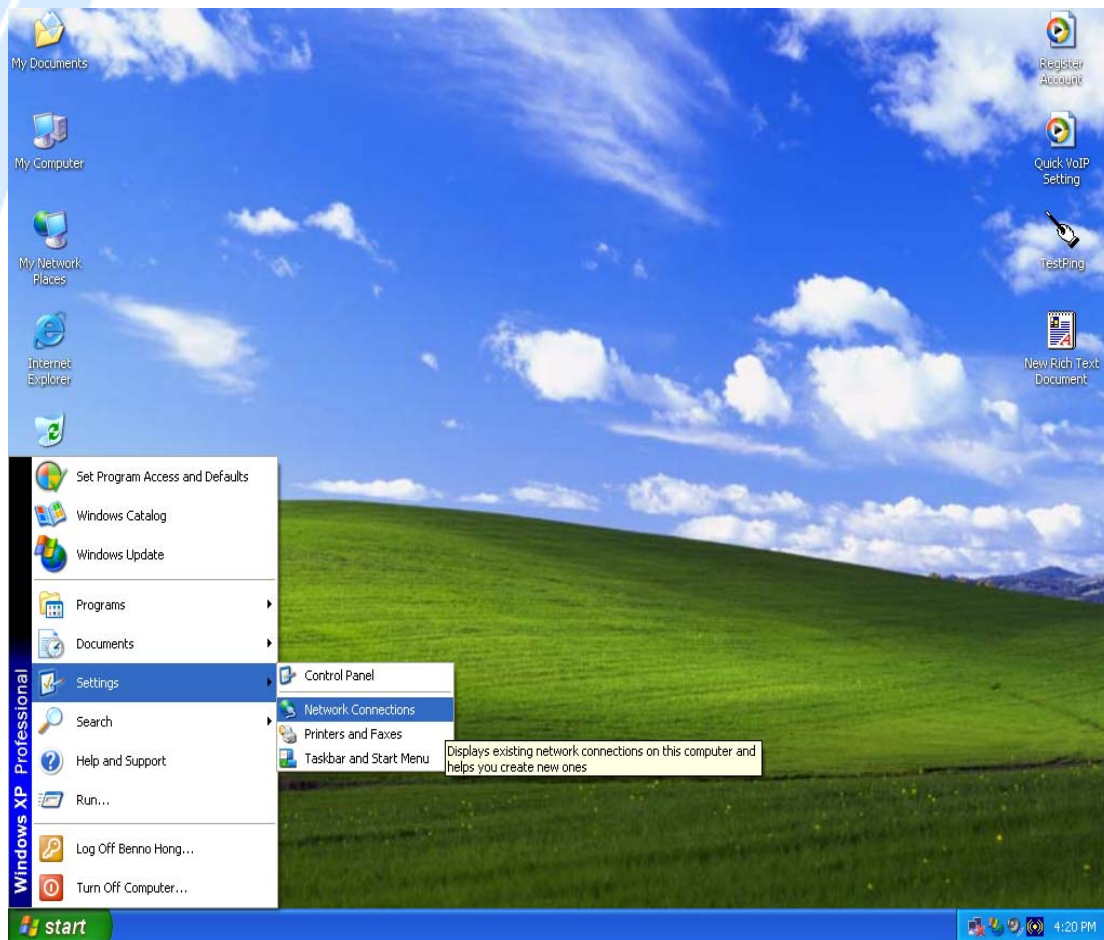

2. In the **Network Connections** window, right-click **Local Area Connection** and select **Properties**.

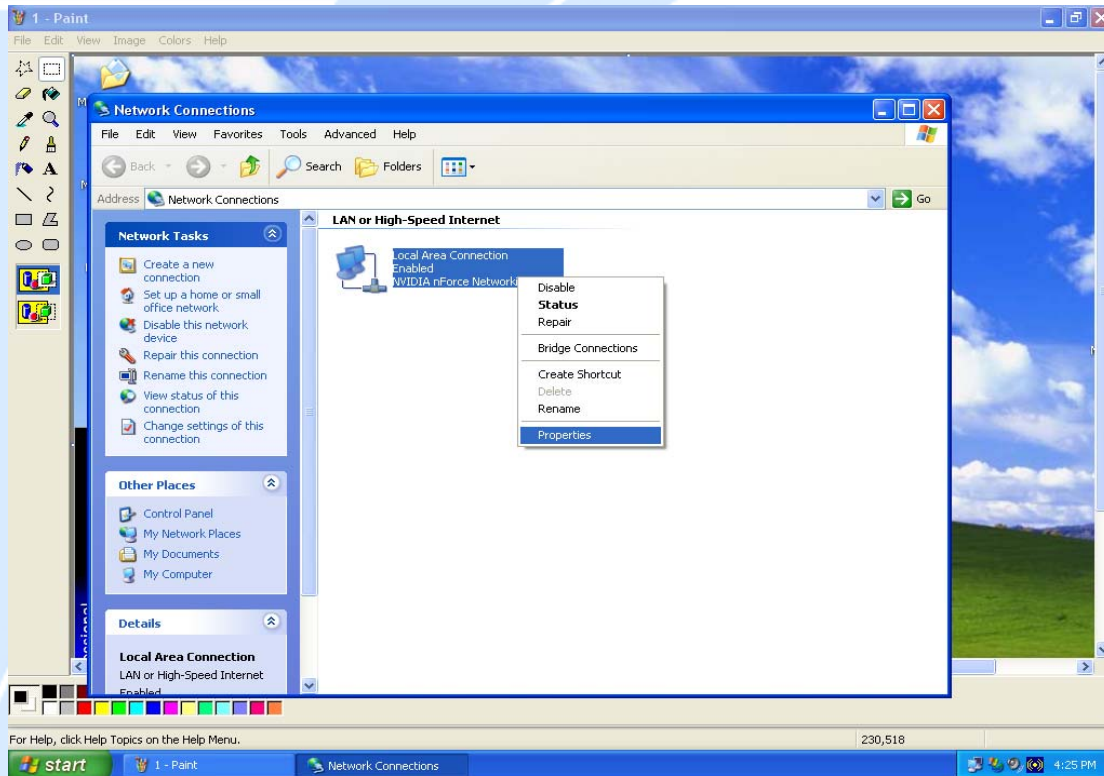

3. Select **Internet Protocol (TCP/IP)** and click **Properties**.

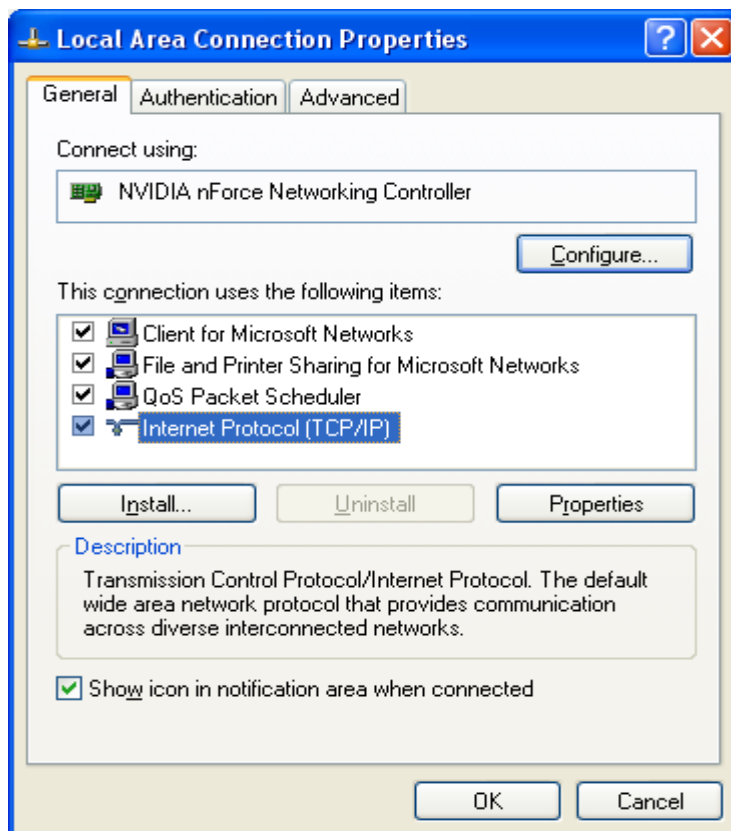

4a. To have your PC obtain an IP address automatically, select the **Obtain an IP**

address automatically and Obtain DNS server address automatically radio buttons.

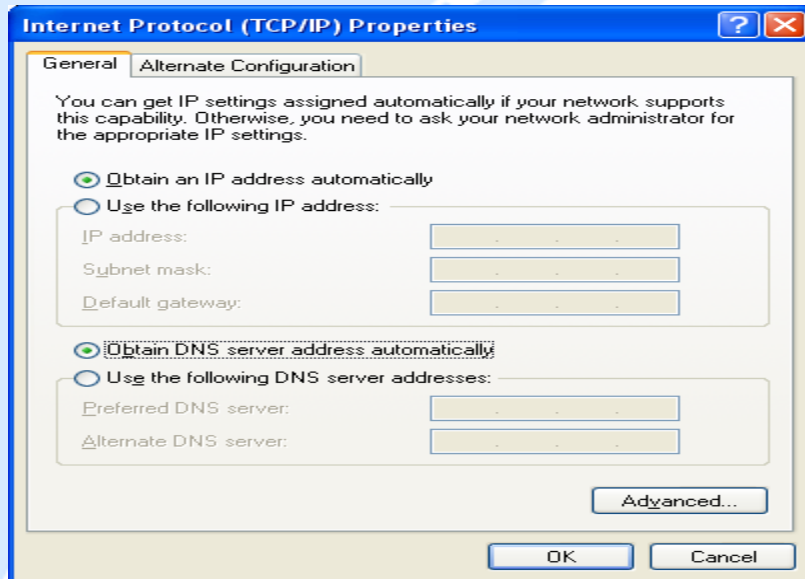

4b. To manually assign your PC a fixed IP address, select the **Use the following IP address** radio button and enter your desired IP address, subnet mask, and default gateway in the blanks provided. Remember that your PC must reside in the same subnet mask as the router. To designate a DNS server, select the **Use the following DNS server** and fill in the preferred DNS address.

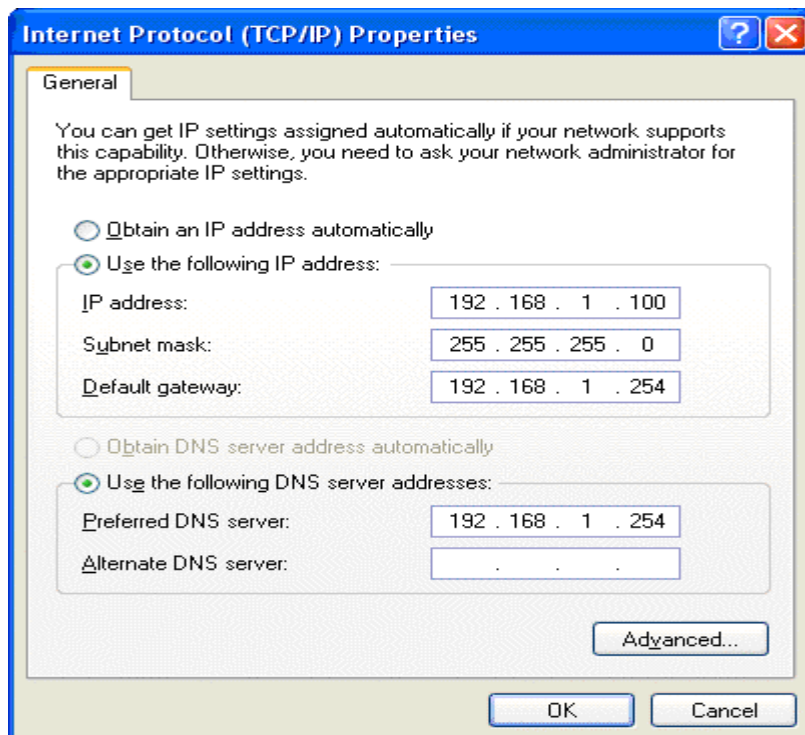

5. Click **OK** to finish the configuration.

3.4.2.2 Verifying Settings

To verify your settings using a command prompt:

1. Click **Start > Programs > Accessories > Command Prompt**.

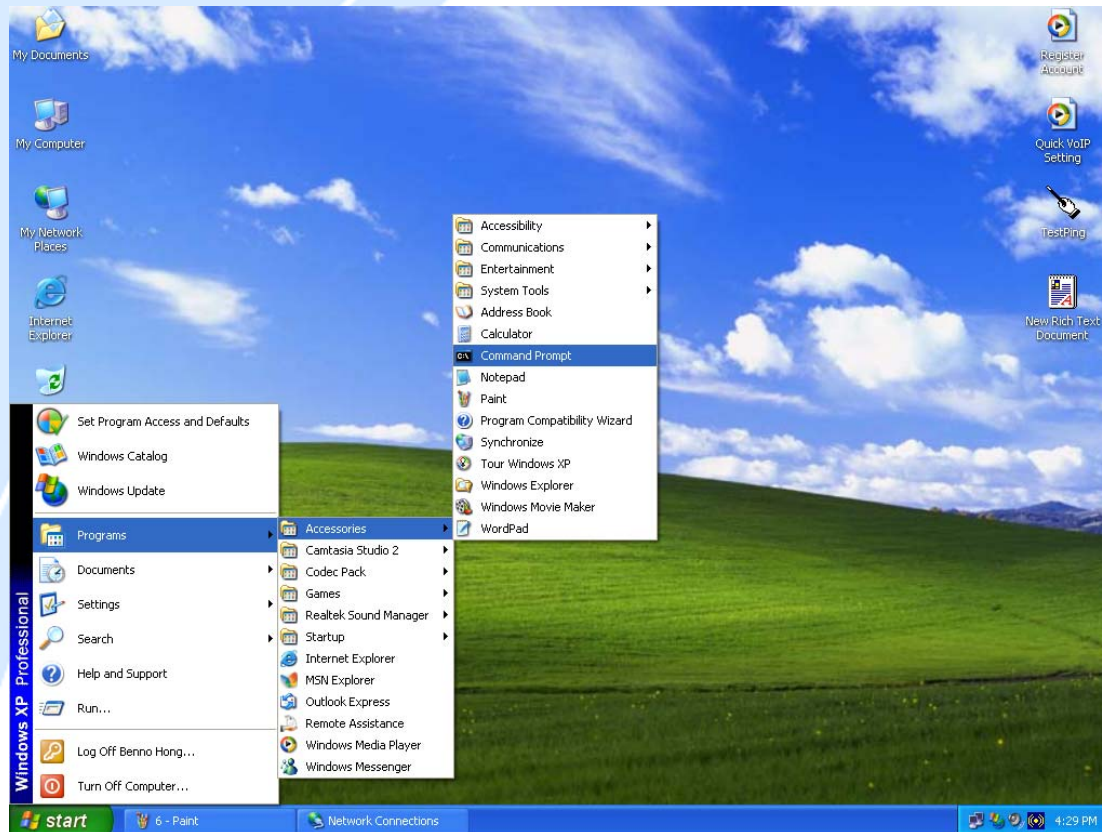

2. In the Command Prompt window, type `ipconfig` and then press **ENTER**.

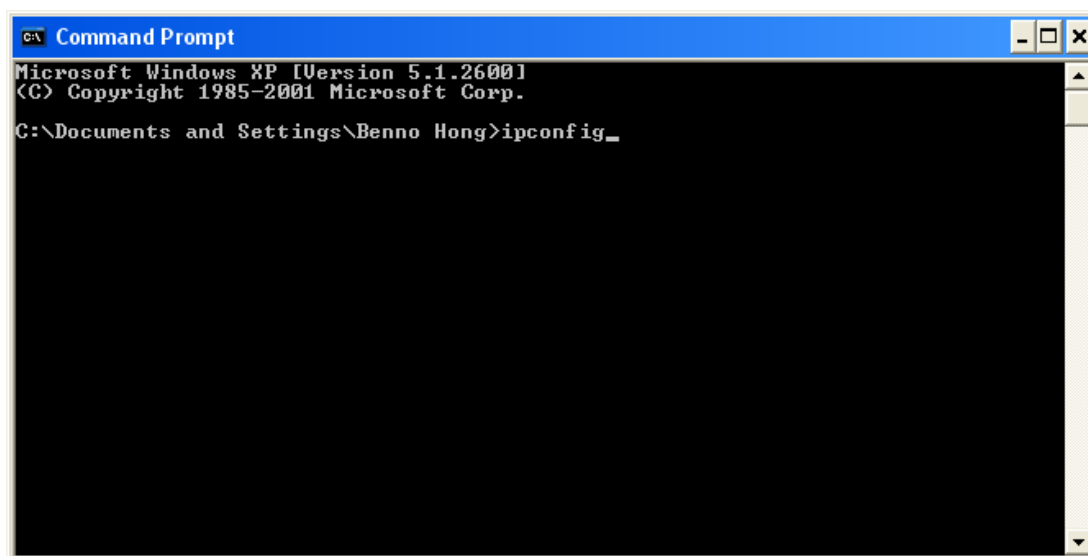

If you are using BiGuard 50G's default settings, your PC should have:

- An IP address between 192.168.1.1 and 192.168.1.253
- A subnet mask of 255.255.255.0

```
C:\> Command Prompt
Microsoft Windows XP [Version 5.1.2600]
(C) Copyright 1985-2001 Microsoft Corp.

C:\Documents and Settings\Benno Hong>ipconfig

Windows IP Configuration

Ethernet adapter Local Area Connection:

    Connection-specific DNS Suffix  . : 
    IP Address . . . . . : 192.168.1.100
    Subnet Mask . . . . . : 255.255.255.0
    Default Gateway . . . . . : 192.168.1.254

C:\Documents and Settings\Benno Hong>
```

To verify your settings using the Windows XP GUI:

1. Click **Start > Settings > Network Connections**.

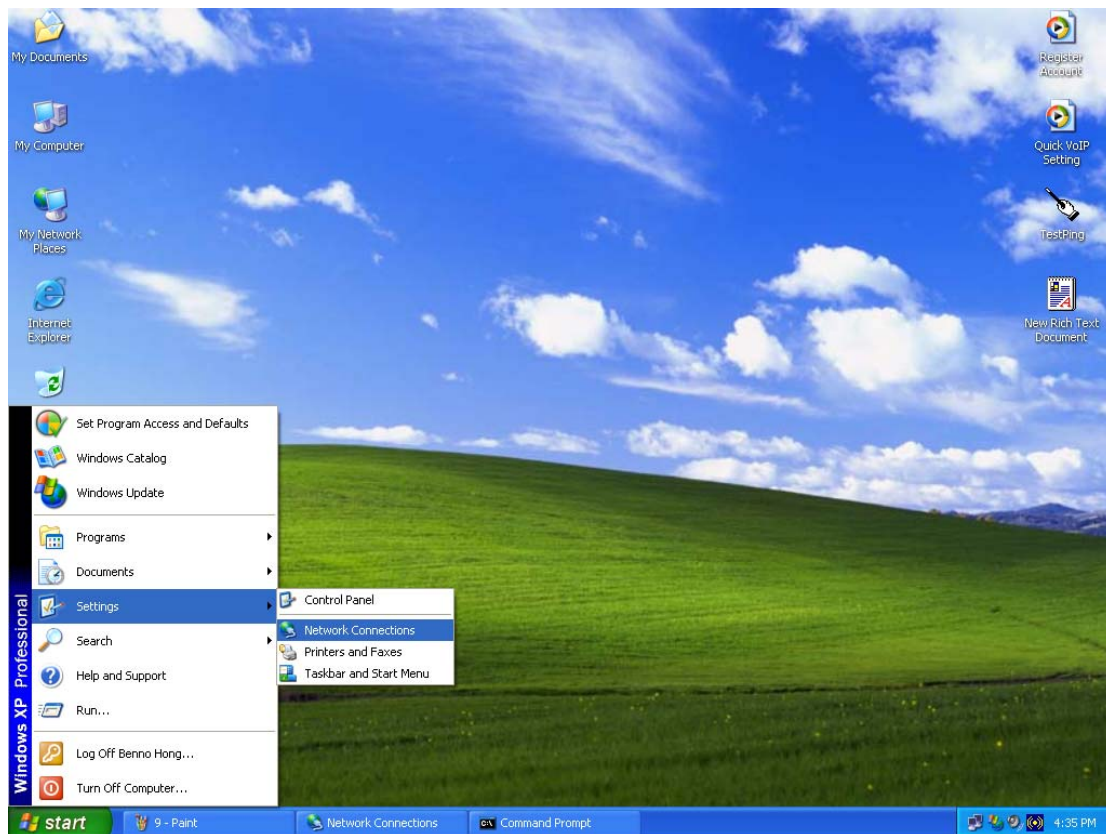

2. Right click one of the network connections listed and select **Status** from the pop-up menu.

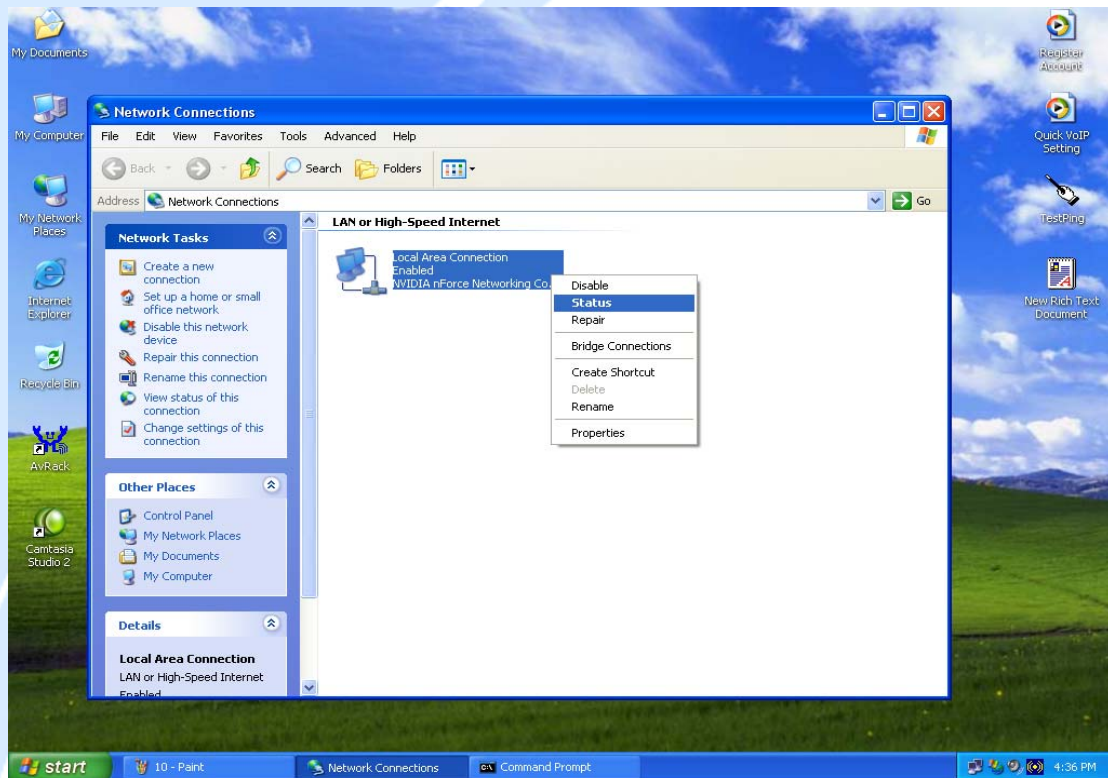

3. Click the **Support** tab.

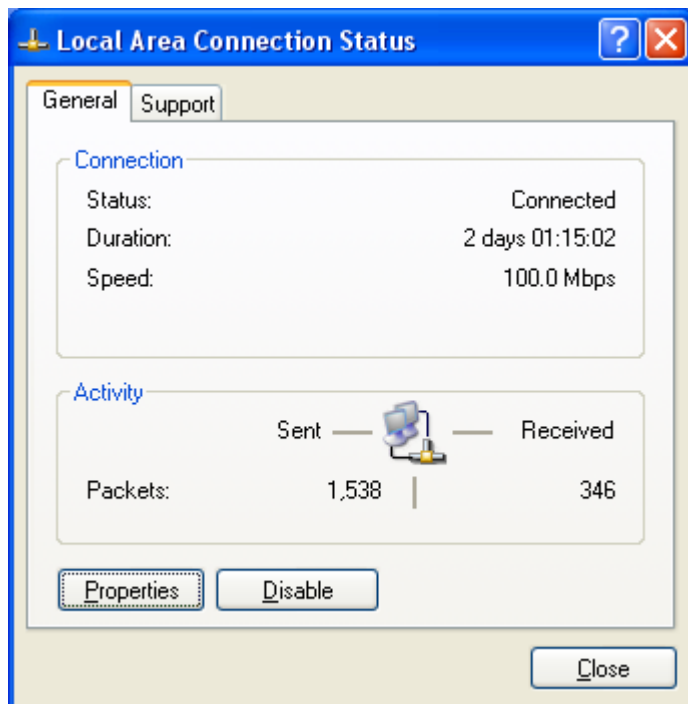

If you are using BiGuard 50G's default settings, your PC should:

- Have an IP address between 192.168.1.1 and 192.168.1.253
- Have a subnet mask of 255.255.255.0

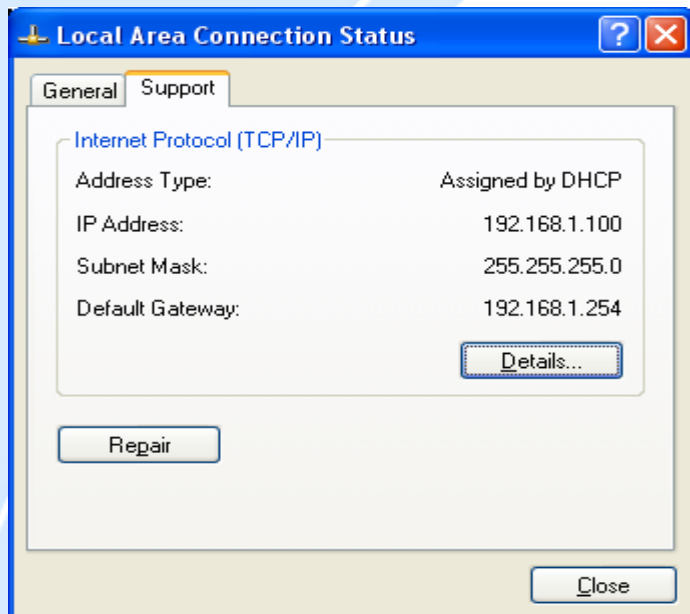

3.4.3 Windows 2000

3.4.3.1 Configuring

1. Select **Start > Settings > Control Panel**.

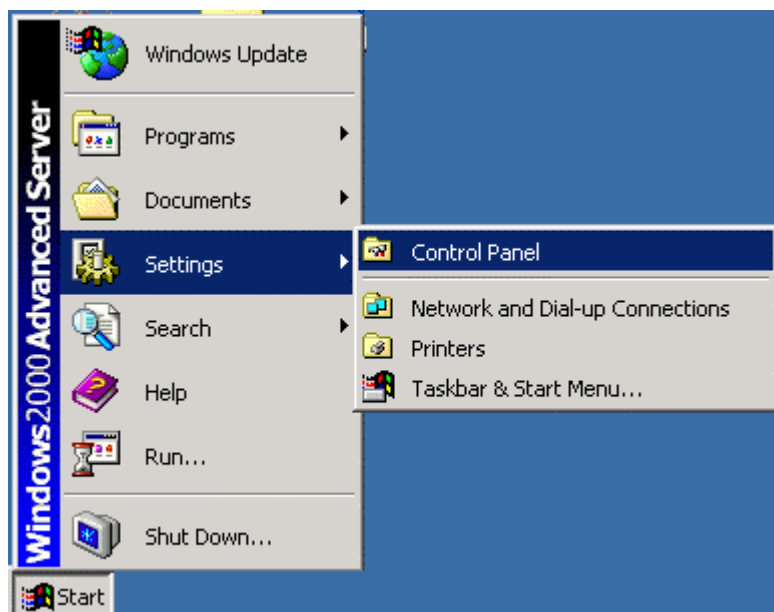

2. In the Control Panel window, double-click **Network and Dial-up Connections**.

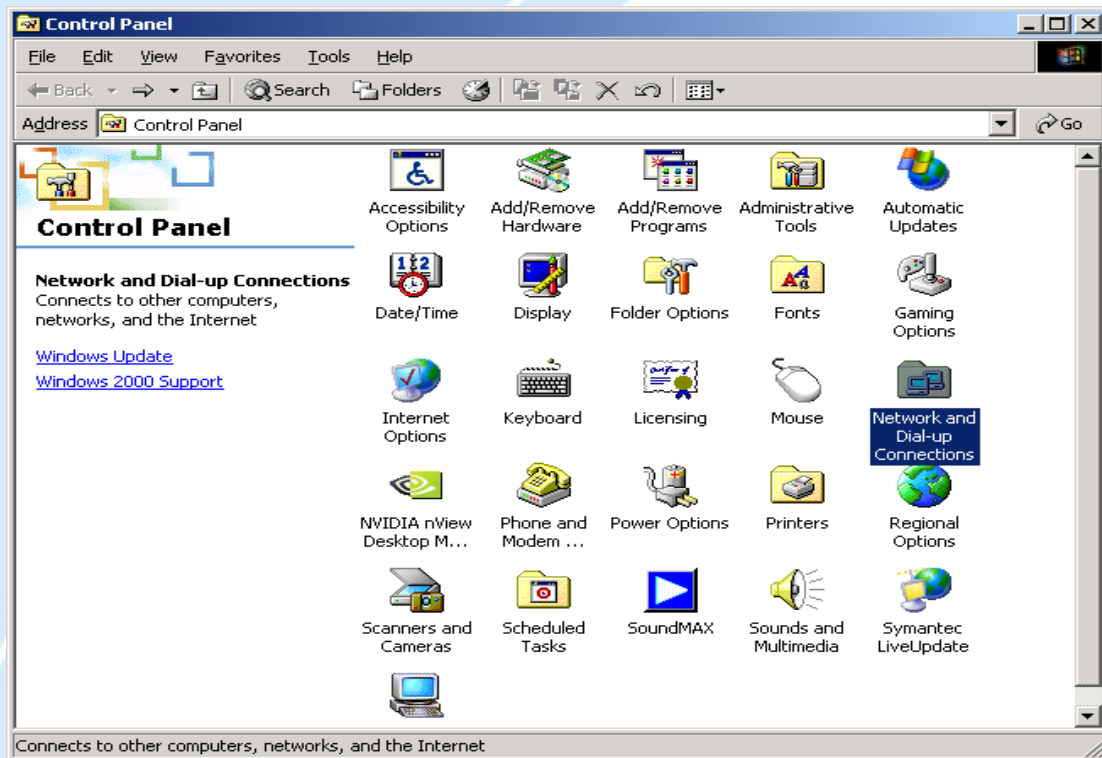

3. In Network and Dial-up Connections, double-click **Local Area Connection**.

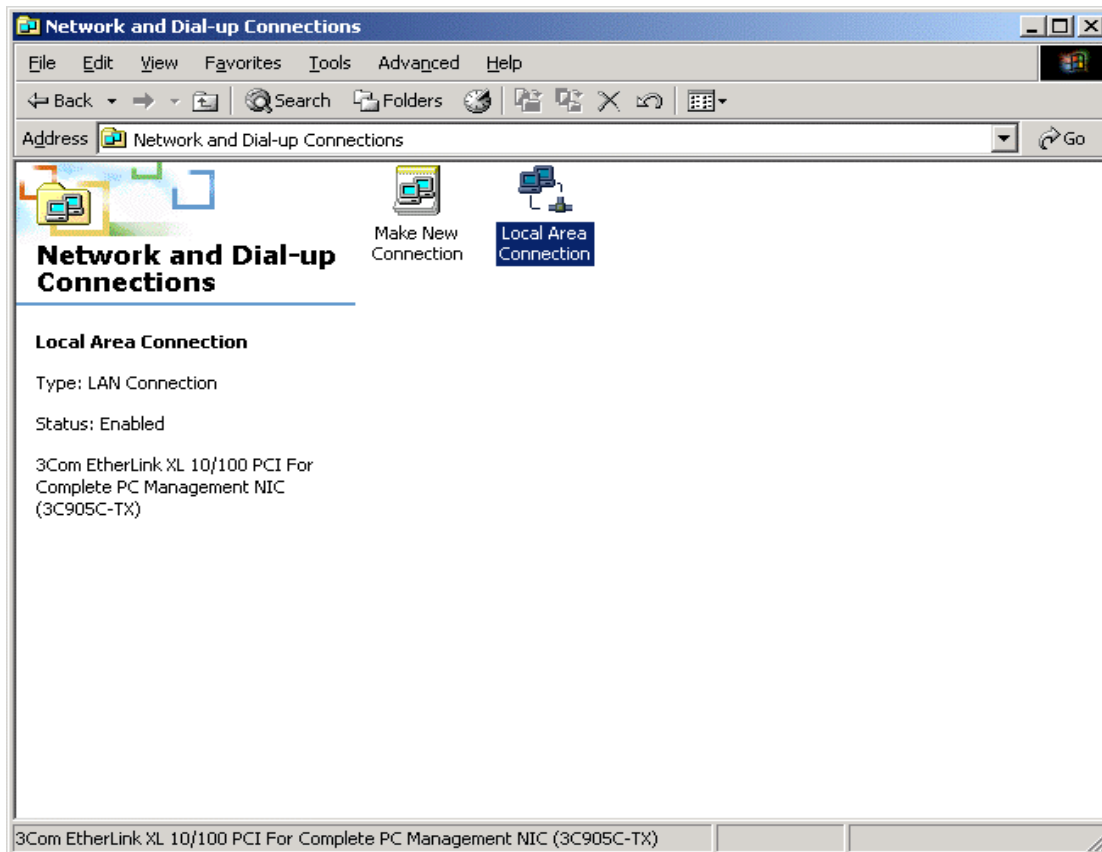

4. In the Local Area Connection window, click **Properties**.

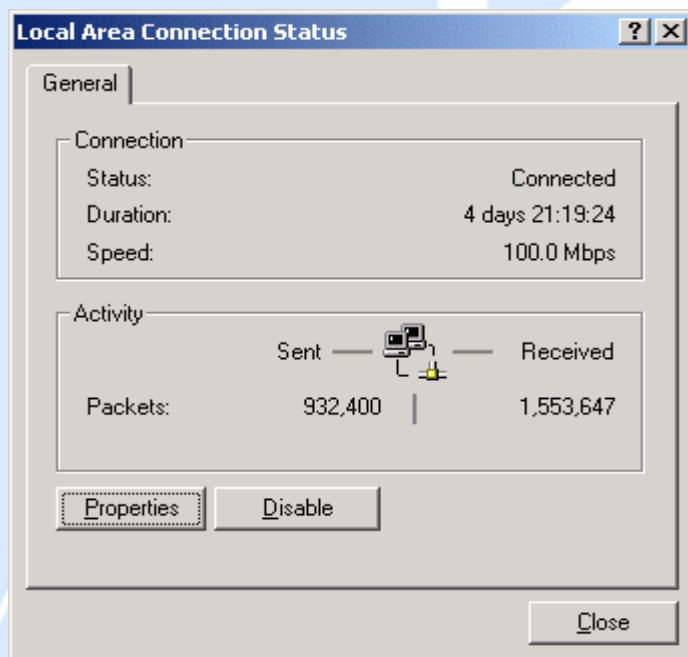

5. Select **Internet Protocol (TCP/IP)** and click **Properties**.

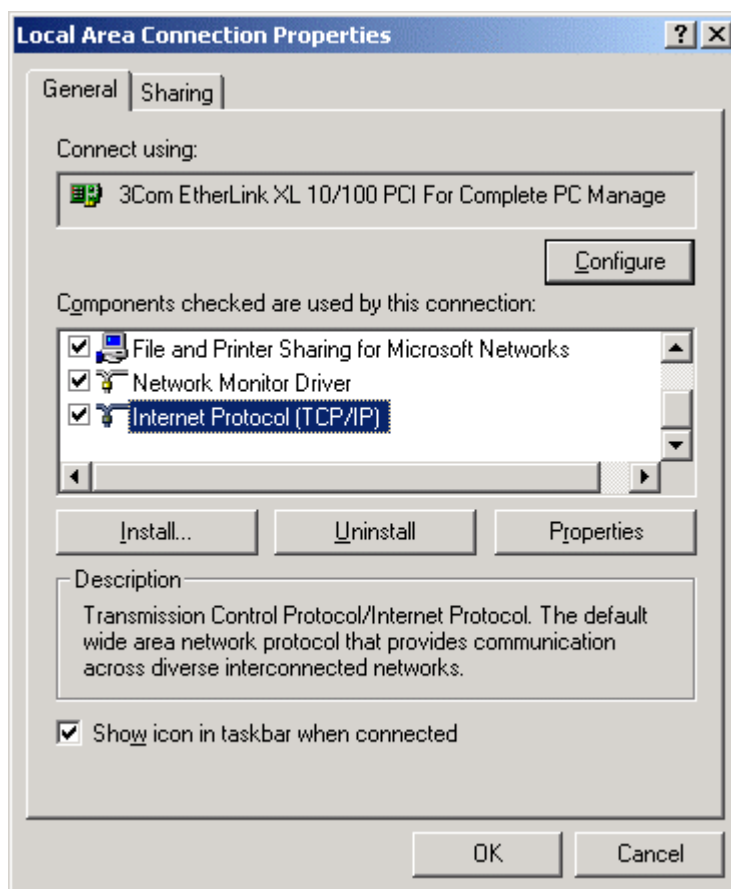

6a. To have your PC obtain an IP address automatically, select the **Obtain an IP address automatically** and **Obtain DNS server address automatically** radio buttons.

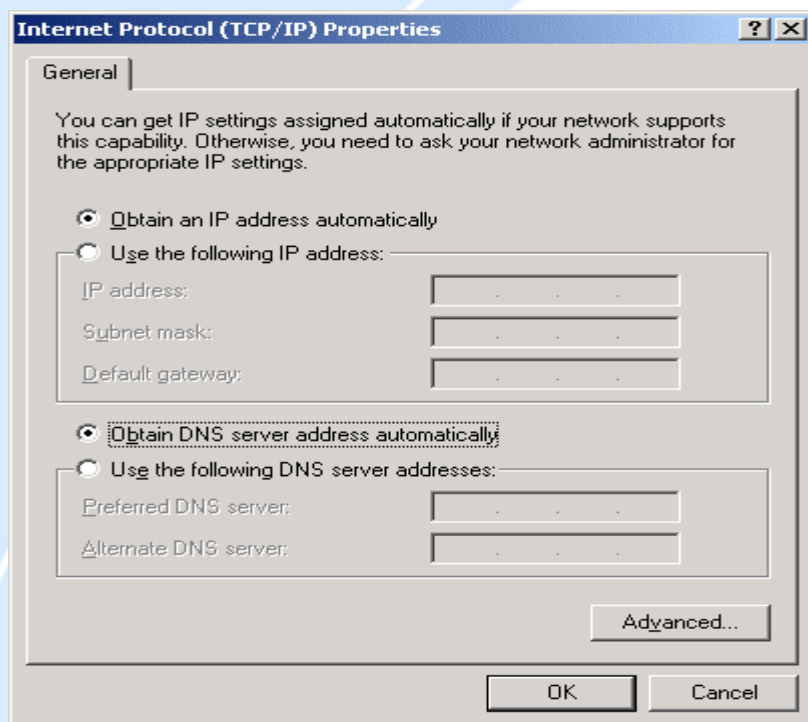

6b. To manually assign your PC a fixed IP address, select the **Use the following IP address** radio button and enter your desired IP address, subnet mask, and default gateway in the blanks provided. Remember that your PC must reside in the same subnet mask as the router. To designate a DNS server, select the **Use the following DNS server** and fill in the preferred DNS address.

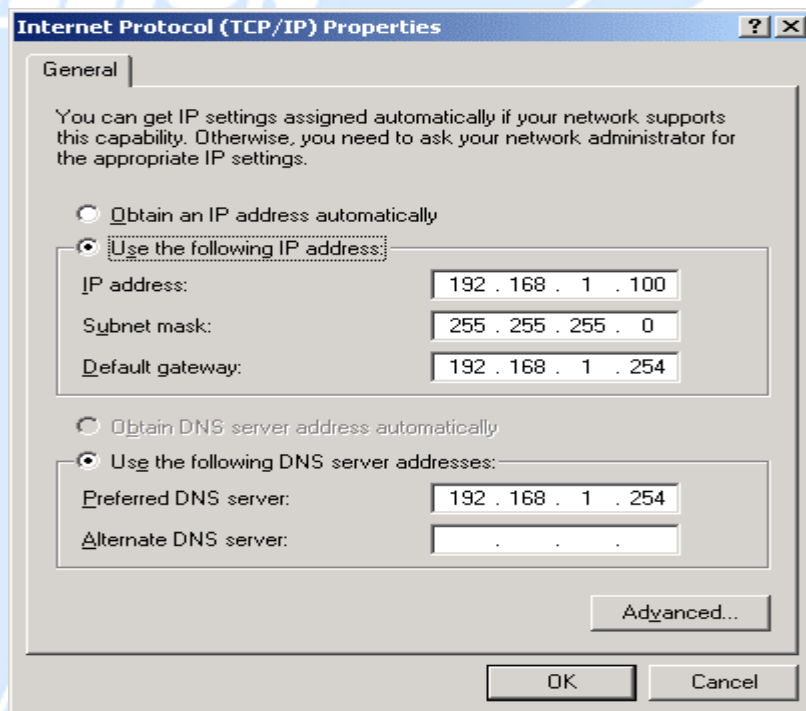

7. Click **OK** to finish the configuration.

3.4.3.2 Verifying Settings

1. Click **Start > Programs > Accessories > Command Prompt**.

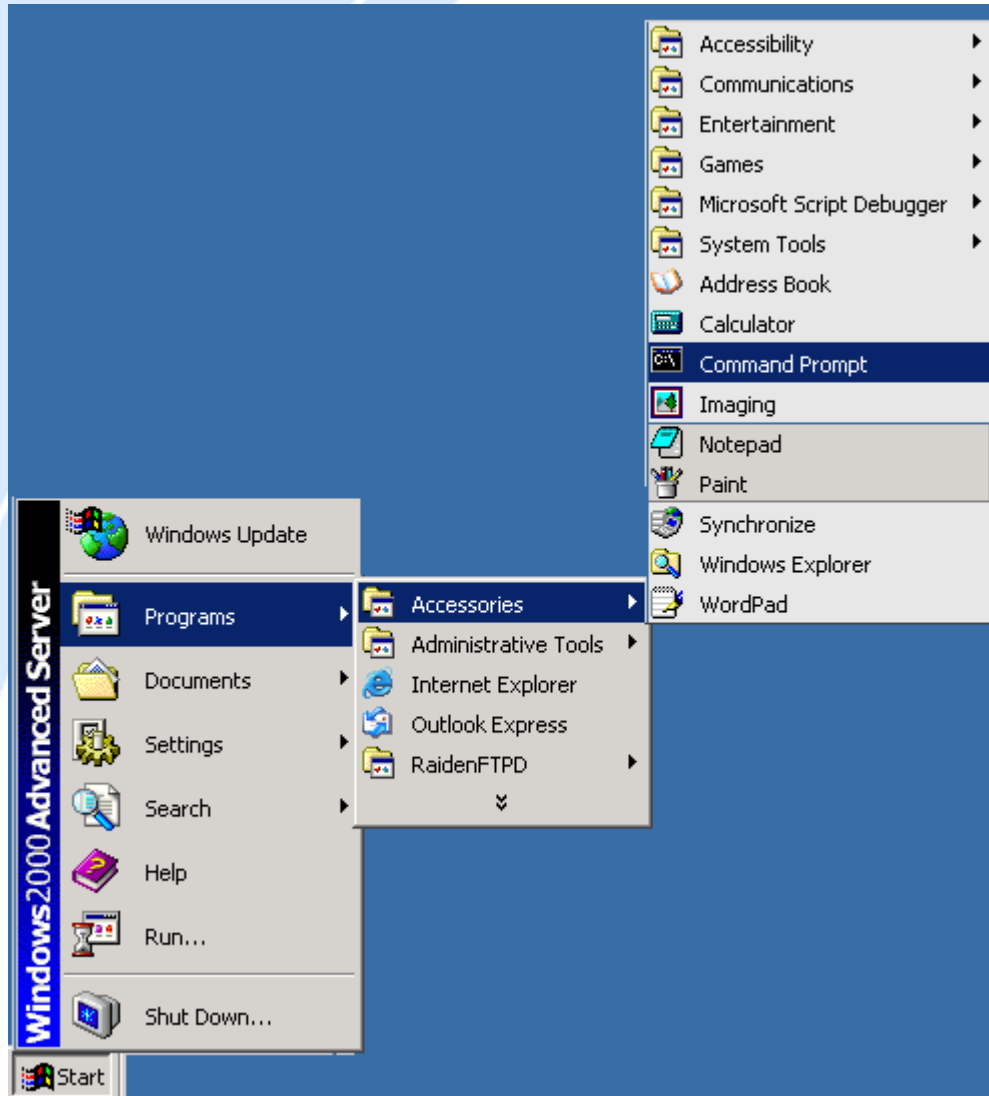

2. In the Command Prompt window, type `ipconfig` and then press **ENTER**.

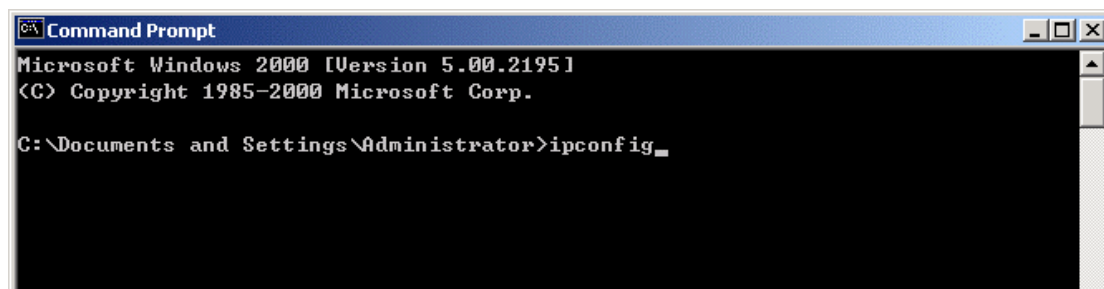

If you are using BiGuard 50G's default settings, your PC should have:

- An IP address between 192.168.1.1 and 192.168.1.253

- A subnet mask of 255.255.255.0

```
Command Prompt
Microsoft Windows 2000 [Version 5.00.2195]
(C) Copyright 1985-2000 Microsoft Corp.

C:\Documents and Settings\Administrator>ipconfig

Windows 2000 IP Configuration

Ethernet adapter Local Area Connection:

    Connection-specific DNS Suffix  . :
    IP Address. . . . .               : 192.168.1.100
    Subnet Mask . . . . .             : 255.255.255.0
    Default Gateway . . . . .         : 192.168.1.254

C:\Documents and Settings\Administrator>
```

3.4.4 Windows 98 / Me

3.4.4.1 Installing Components

To prepare Windows 98/Me PCs for TCP/IP networking, you may need to manually install TCP/IP on each PC. To do this, follow the steps below. Be sure to have your Windows CD handy, as you may need to insert it during the installation process.

1. On the Windows taskbar, select **Start > Settings > Control Panel**.

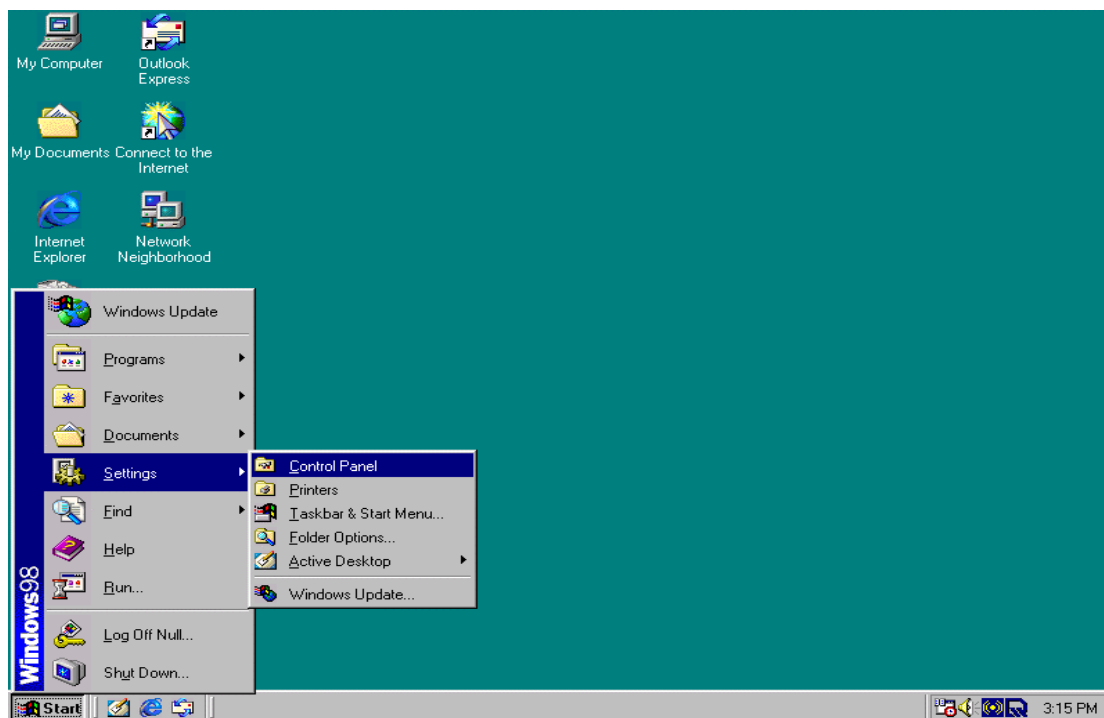

2. Double-click the **Network** icon. The Network window displays a list of installed components.

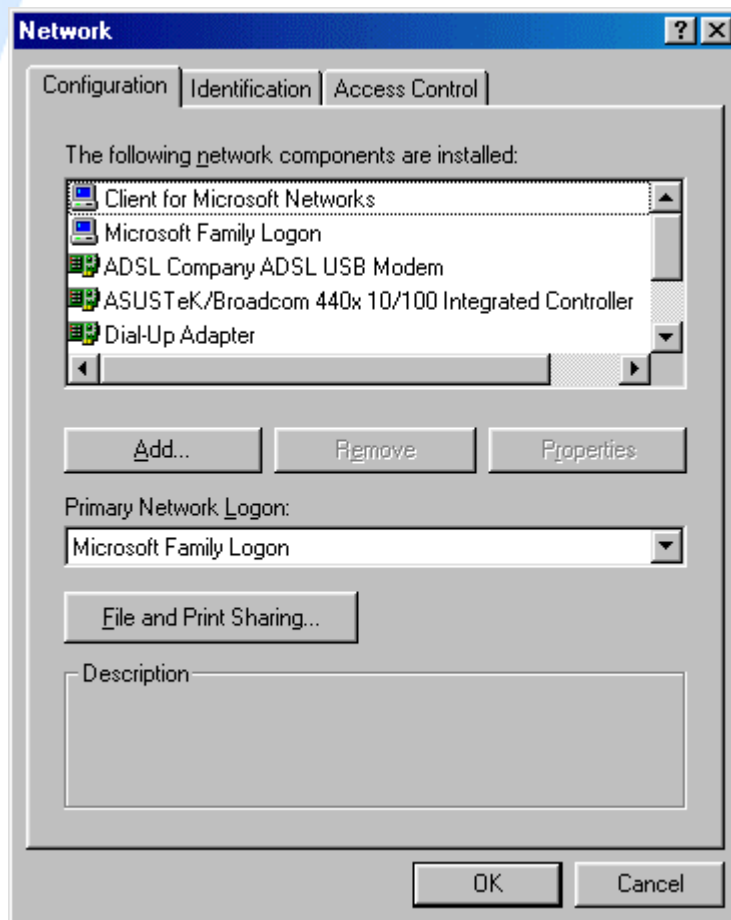
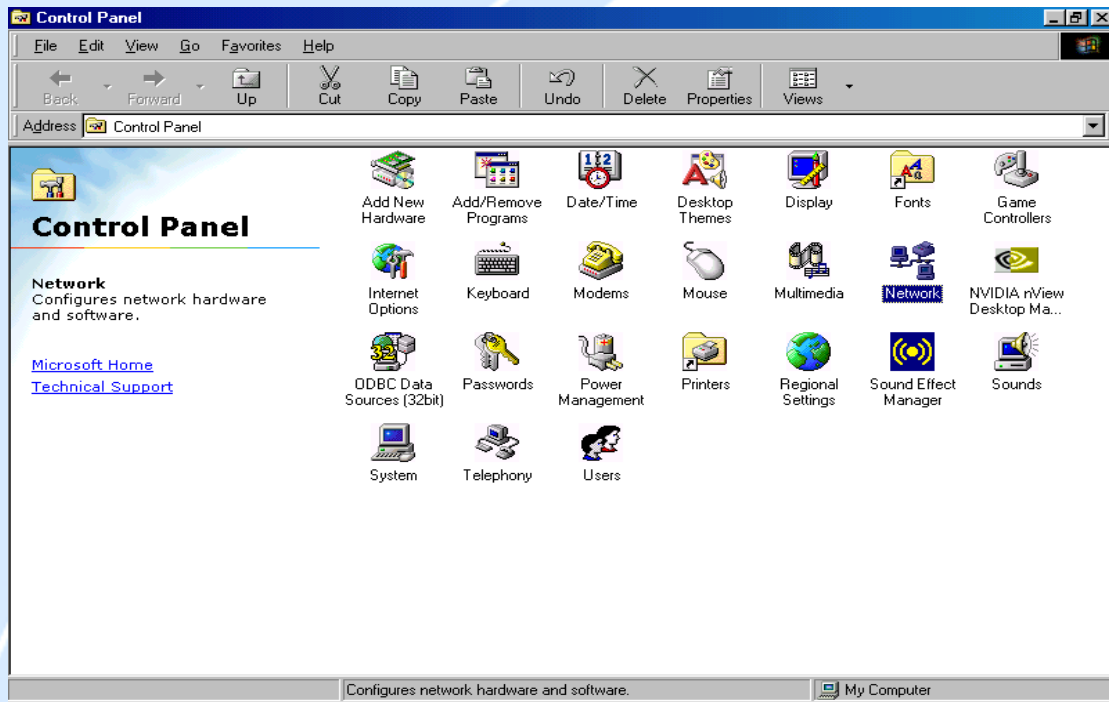

You must have the following installed:

- An Ethernet adapter
- TCP/IP protocol
- Client for Microsoft Networks

If you need to install a new Ethernet adapter, follow these steps:

a. Click **Add**.

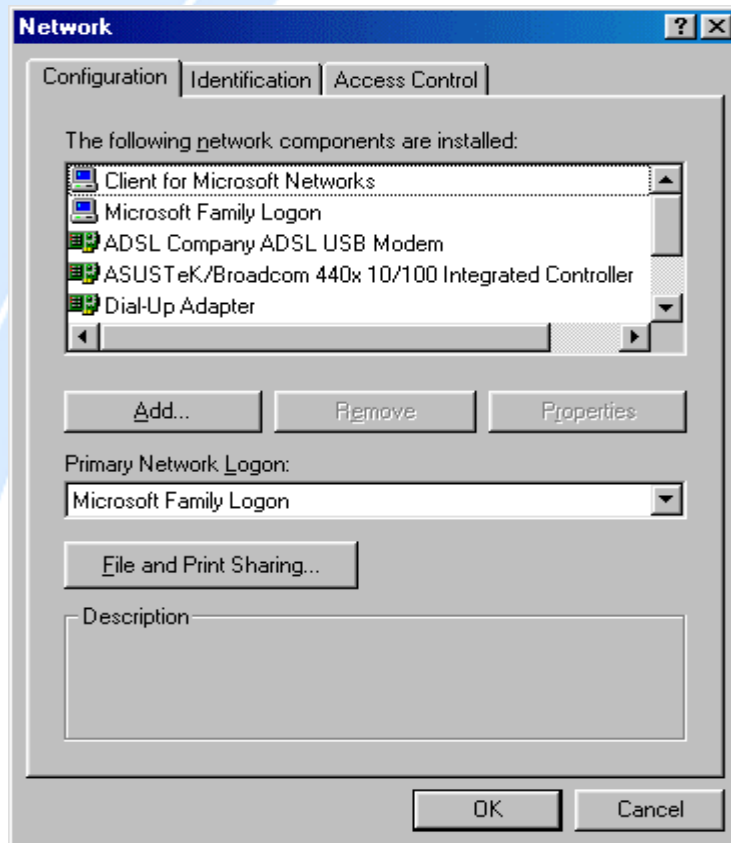

b. Select **Adapter**, then **Add**.

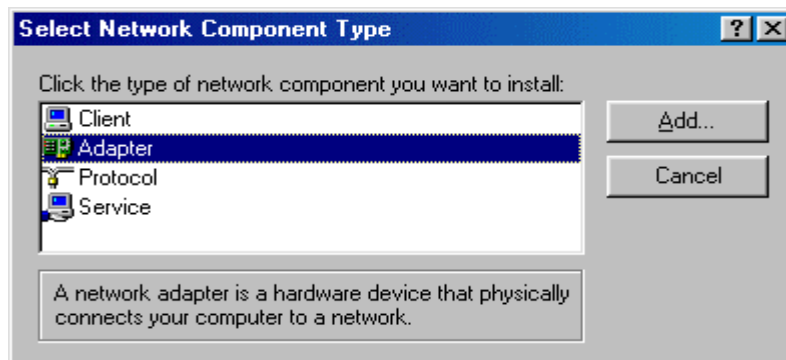

c. Select the manufacturer and model of your Ethernet adapter, then click **OK**.

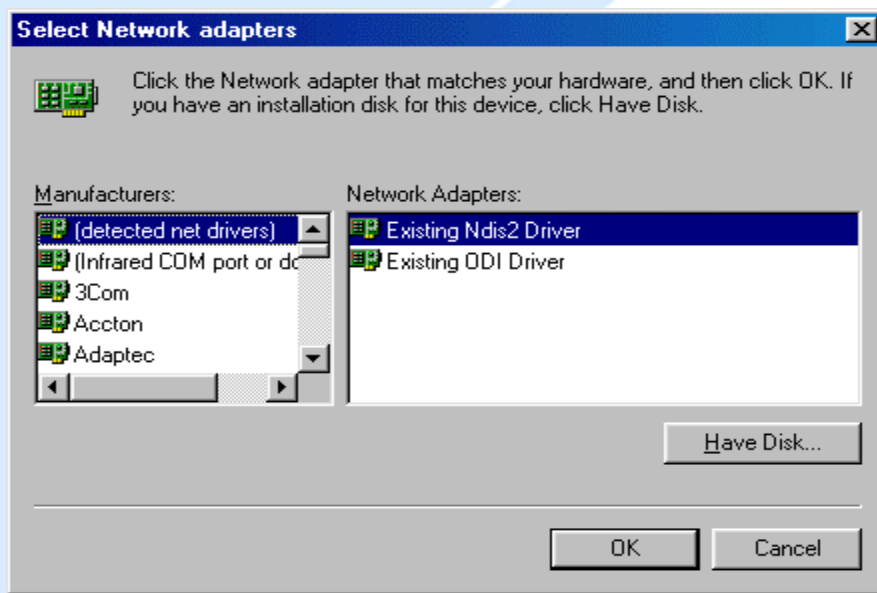

If you need TCP/IP:

- Click **Add**.

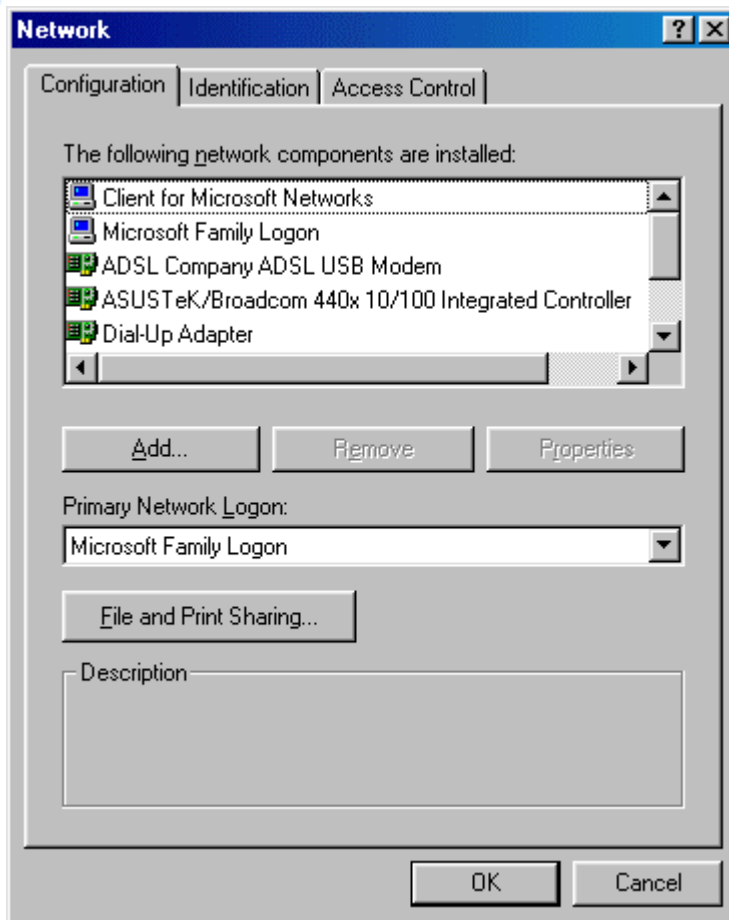

b. Select **Protocol**, then click **Add**.

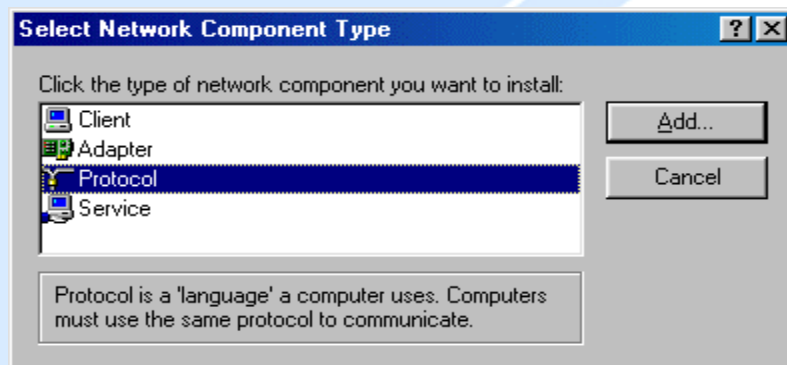

c. Select **Microsoft**. → **TCP/IP**, then **OK**.

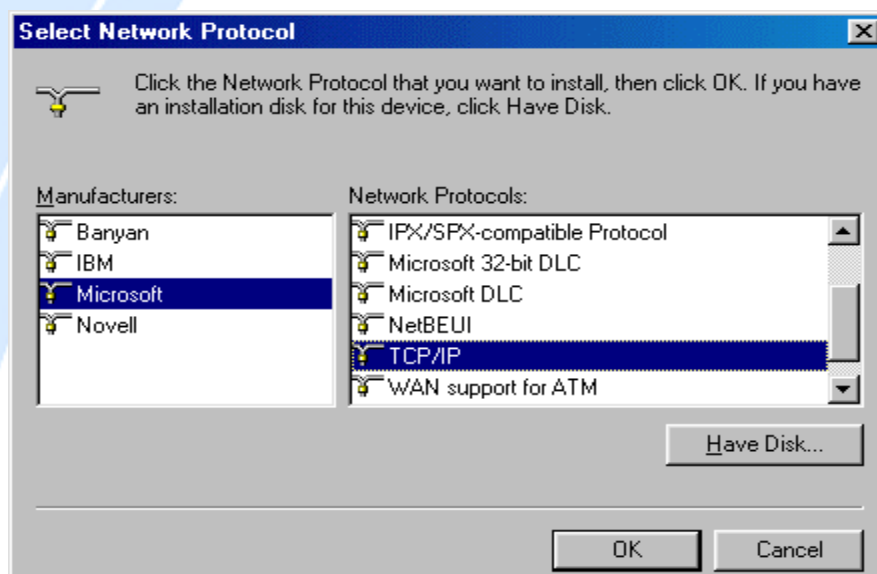

If you need Client for Microsoft Networks:

a. Click **Add**.

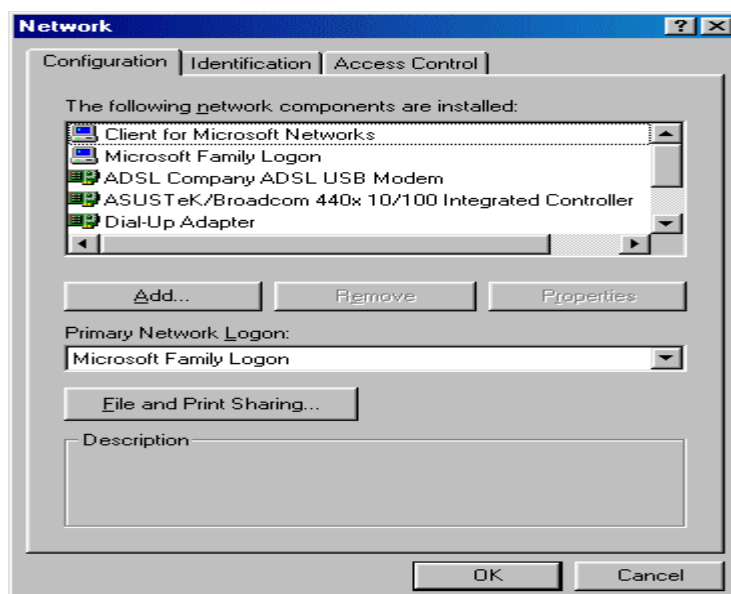

b. Select **Client**, then click **Add**.

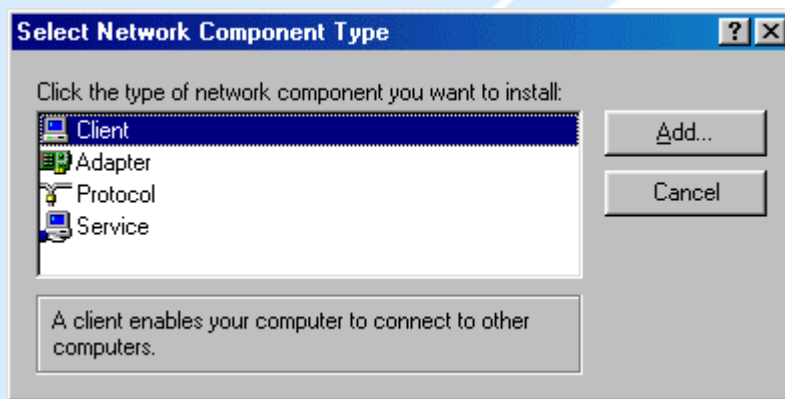

c. Select **Microsoft**. → **Client for Microsoft Networks**, and then click **OK**.

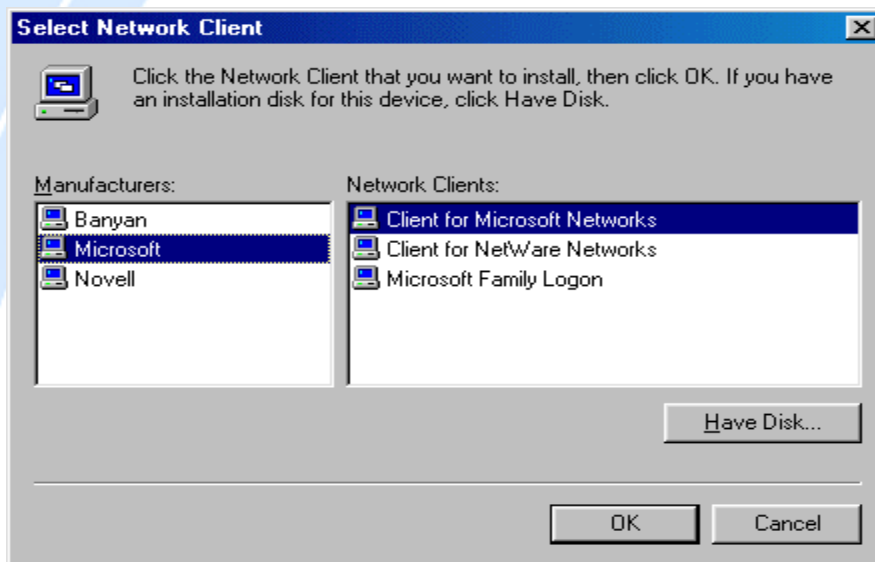

3. Restart your PC to apply your changes.

3.4.4.2 Configuring

1. Select **Start > Settings > Control Panel**.

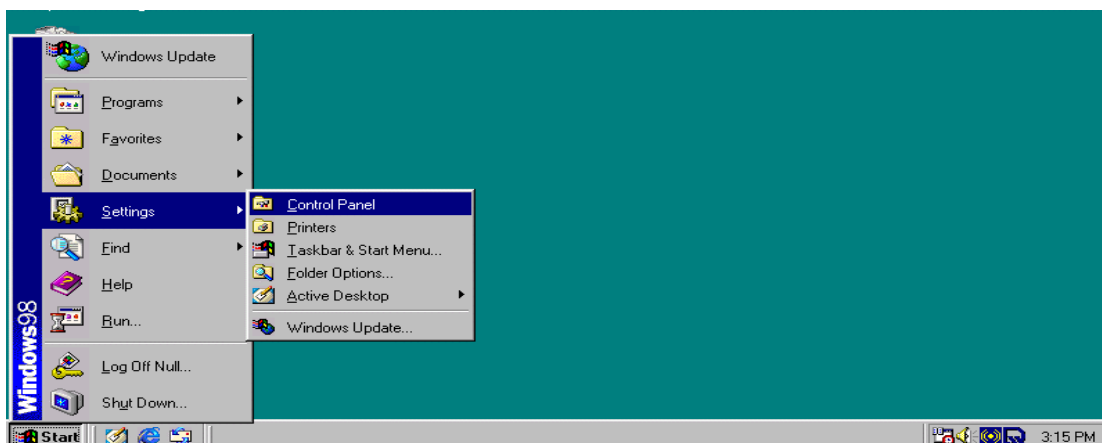

2. In the Control Panel, double-click **Network** and choose the **Configuration** tab.

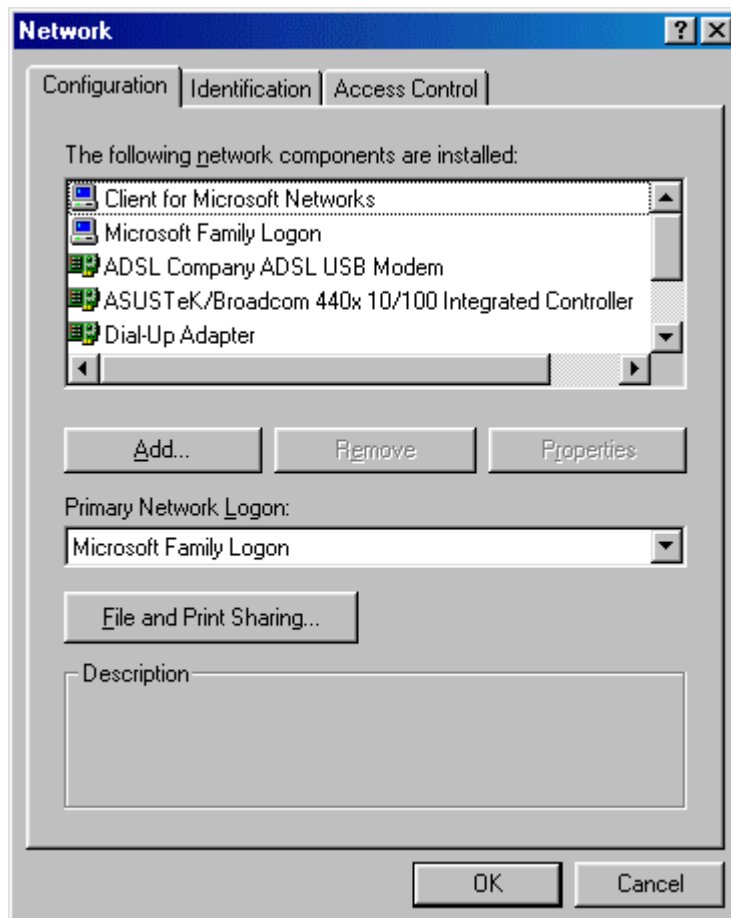
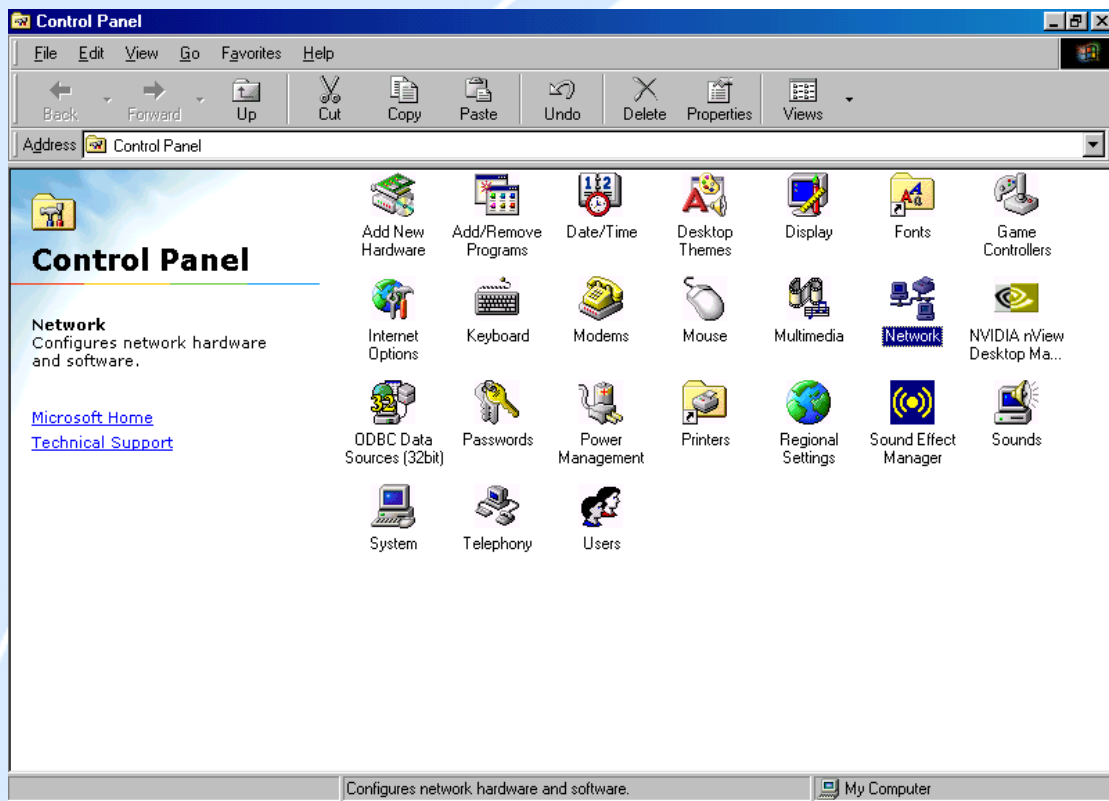

3. Select **TCP / IP > ASUSTek** or the name of any Network Interface Card (NIC) in your PC and click **Properties**.

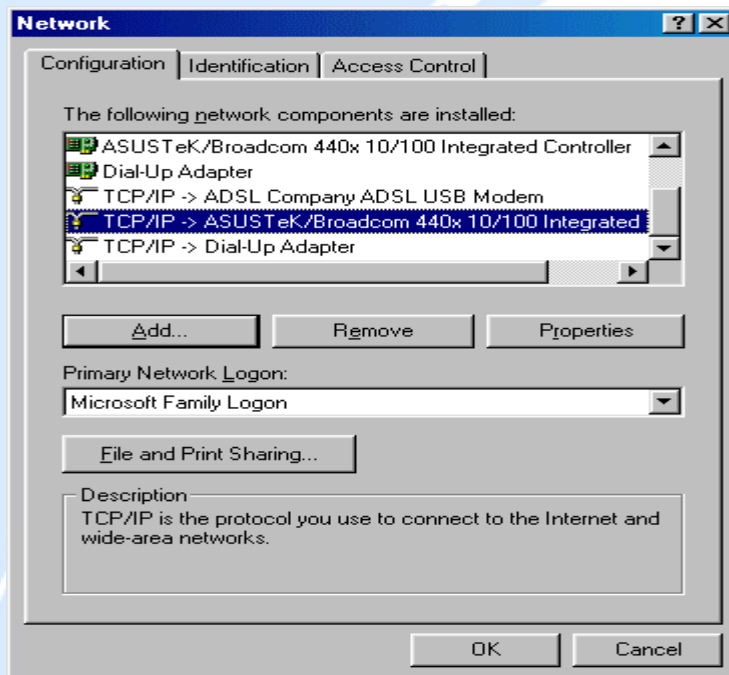

4. Select the **IP Address** tab and click the **Obtain an IP address automatically** radio button.

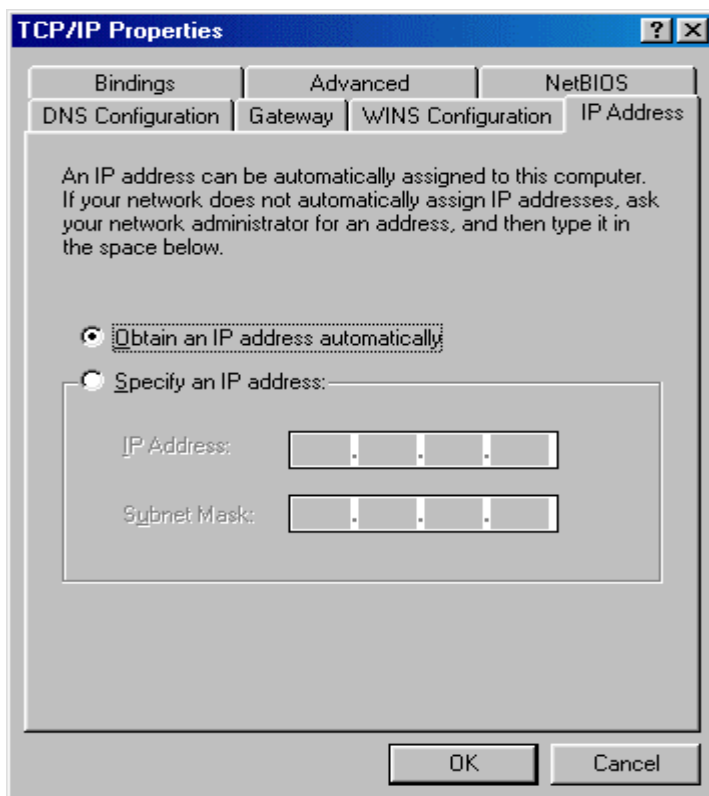

5. Select the **DNS Configuration** tab and select the **Disable DNS** radio button.

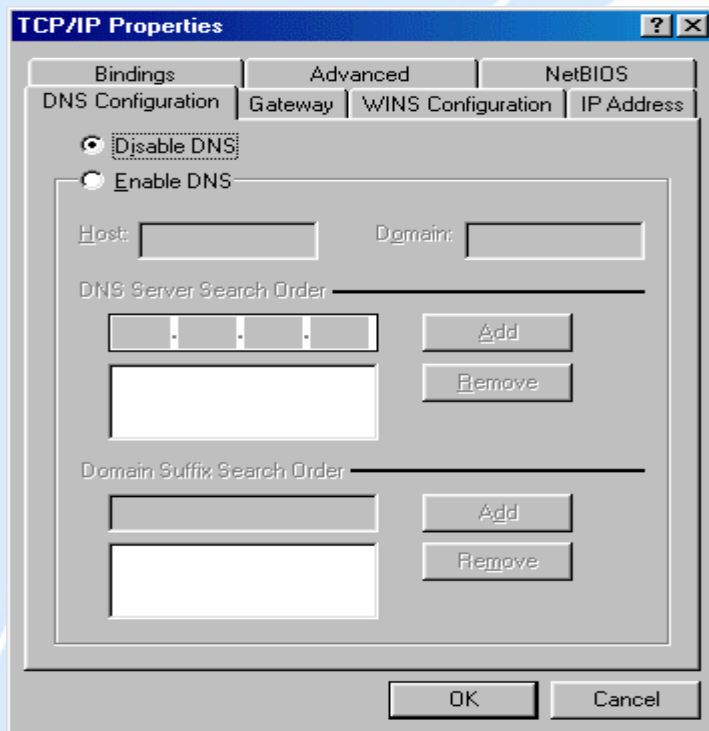

6. Click **OK** to apply the configuration.

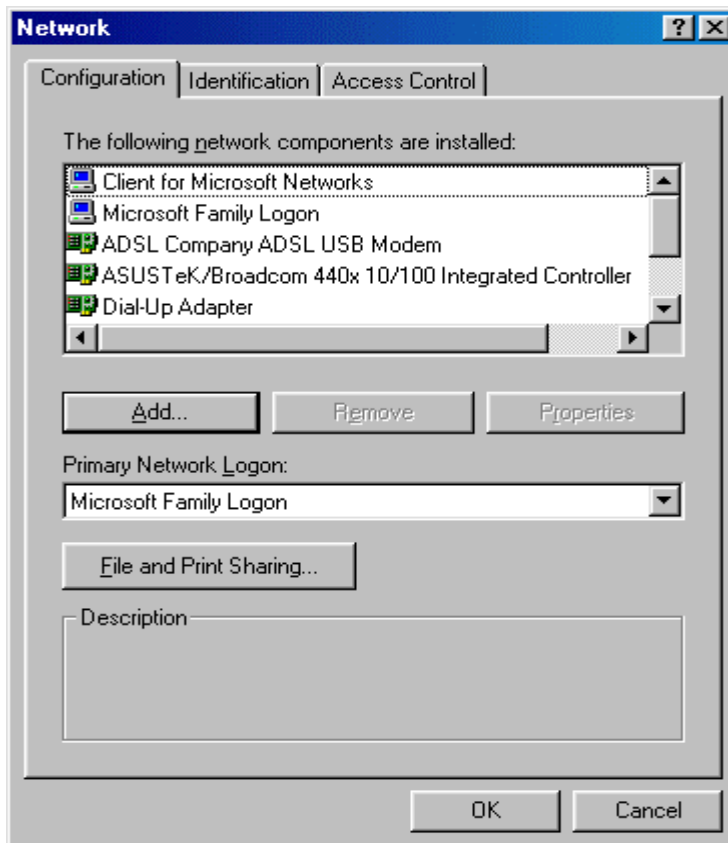

3.4.4.3 Verifying Settings

To check the TCP/IP configuration, use the winipcfg.exe utility:

1. Select **Start > Run**.

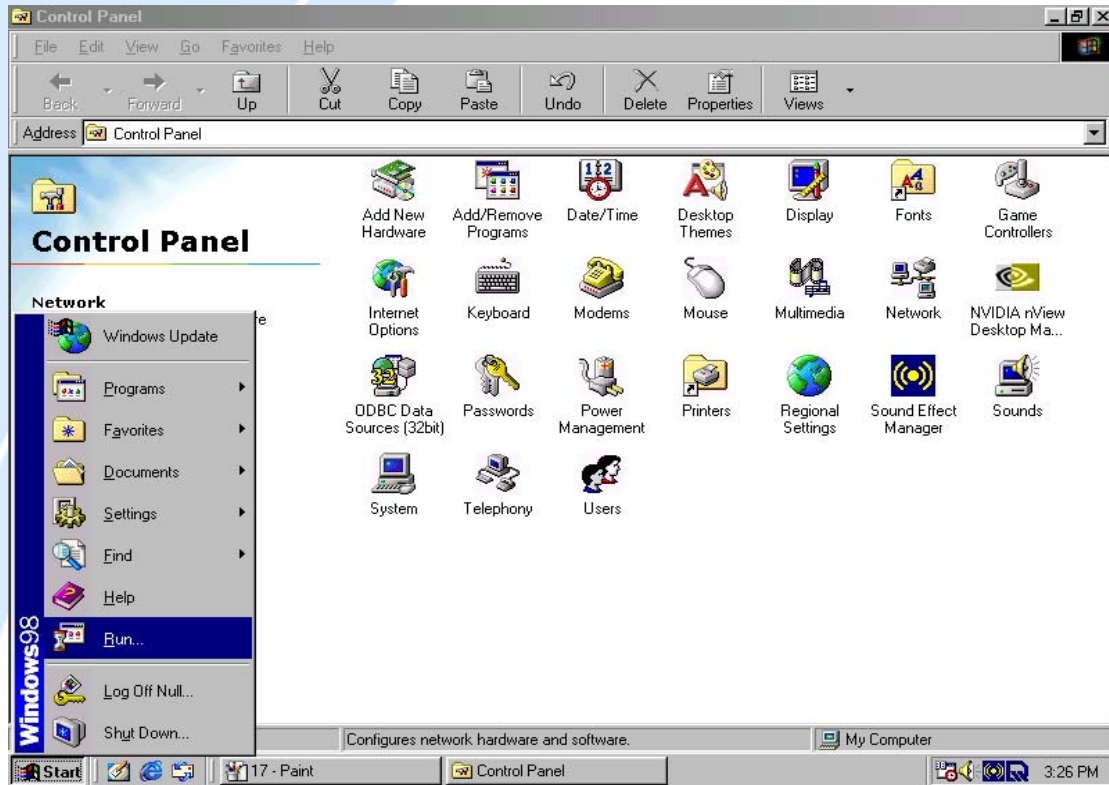

2. Type winipcfg, and then click OK.

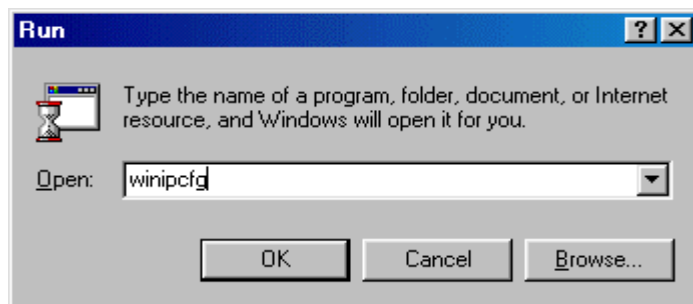

3. From the drop-down box, select your Ethernet adapter.

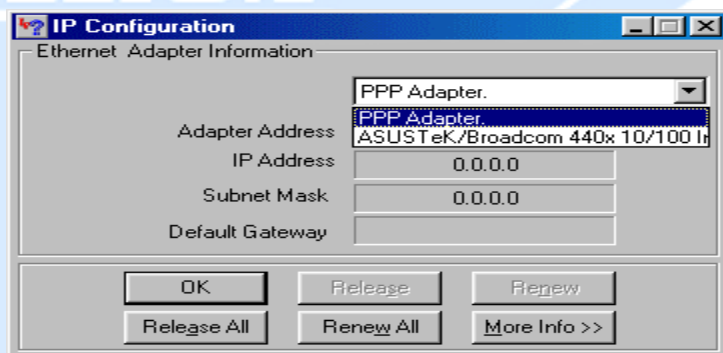

The window is updated to show your settings. Using the default BiGuard 50G settings, your PC should have:

- An IP address between 192.168.1.1 and 192.168.1.253
- A subnet mask of 255.255.255.0
- A default gateway of 192.168.1.254

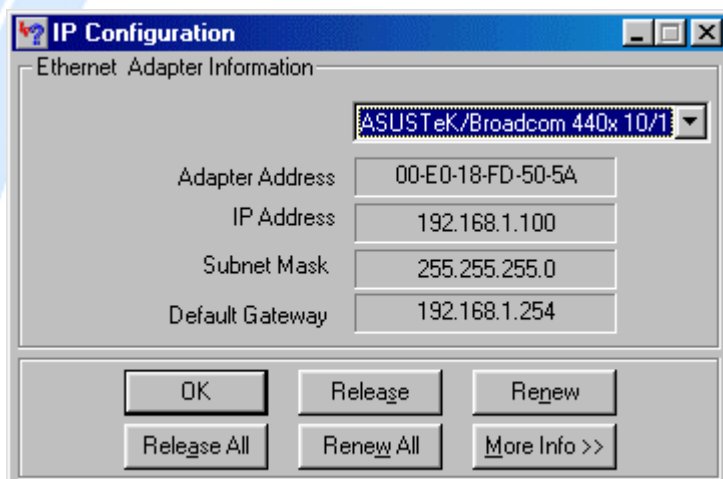

3.5 Factory Default Settings

Before configuring your BiGuard 50G, you need to know the following default settings:

Web Interface:

Username: admin

Password: admin

LAN Device IP Settings:

IP Address: 192.168.1.254

Subnet Mask: 255.255.255.0

ISP setting in WAN site:

Obtain an IP Address automatically (DHCP Client)

DHCP server:

DHCP server is enabled.

Start IP Address: 192.168.1.100

End IP Address: 192.168.1.199

3.5.1 User Name and Password

The default user name and password are "admin" and "admin" respectively.

If you ever forget your user name and/or password, you can restore your BiGuard 50G to its factory settings by holding the Reset button on the back of your router until the Status LED begins to blink. Please note that doing this will also erase any previous router settings that you have made. The Status LED will remain solid as the device boots. Once the boot sequence is complete, the LED will shut off, indicating that BiGuard 50G is ready.

3.5.2 LAN and WAN Port Addresses

The default values for LAN and WAN ports are shown below:

LAN Port		WAN Port
IP address	192.168.1.254	The DHCP Client is <i>enabled</i> to automatically get the WAN port configuration from the ISP.
Subnet Mask	255.255.255.0	
DHCP server function	Enabled	
IP addresses for distribution to PCs	100 IP addresses continuing from 192.168.1.100 through 192.168.1.199	

3.6 Information From Your ISP

3.6.1 Protocols

Before configuring this device, you have to check with your ISP (Internet Service Provider) to find out what kind of service is provided such as DHCP, Static IP, PPPoE, or PPTP. The following table outlines each of these protocols:

DHCP	Configure this WAN interface to use DHCP client protocol to get an IP address from your ISP automatically. Your ISP provides an IP address to the router dynamically when logging in.
Static IP	Configure this WAN interface with a specific IP address. This IP address should be provided by your ISP.
PPPoE	PPPoE (PPP over Ethernet) is known as a dial-up DSL or cable service. It is designed to integrate the broadband services into the current widely deployed, easy-to-use, and low-cost dial-up-access networking infrastructure.
PPTP	If your ISP provides a PPTP connection, you can use the PPTP protocol to establish a connection to your ISP.
Big Pond	The Big Pond login for Telstra cable in Australia.

If your account uses PPP over Ethernet (PPPoE), you will need to enter your login name and password when configuring your BiGuard 50G. After the network and firewall are configured, BiGuard 50G will login automatically, and you will no longer need to run the login program from your PC.

3.6.2 Configuration Information

If your ISP does not dynamically assign configuration information but instead uses fixed configurations, you will need the following basic information from your ISP:

- An IP address and subnet mask
- A gateway IP address
- One or more domain name server (DNS) IP addresses

Depending on your ISP, a host name and domain suffix may also be provided. If any of these items are dynamically supplied by the ISP, your BiGuard 50G will automatically acquire them.

If an ISP technician configured your computer or if you configured it using instructions provided by your ISP, you need to copy the configuration information from your PC's Network TCP/IP Properties window before reconfiguring your computer for use with BiGuard 50G. The following sections describe how you can obtain this information.

3.6.2.1 Windows

This section uses illustrations from Windows XP. However, other versions of Windows will follow a similar procedure. Have your Windows CD handy, as it may be required during the configuration process.

1. Select **Start > Settings > Control Panel**.

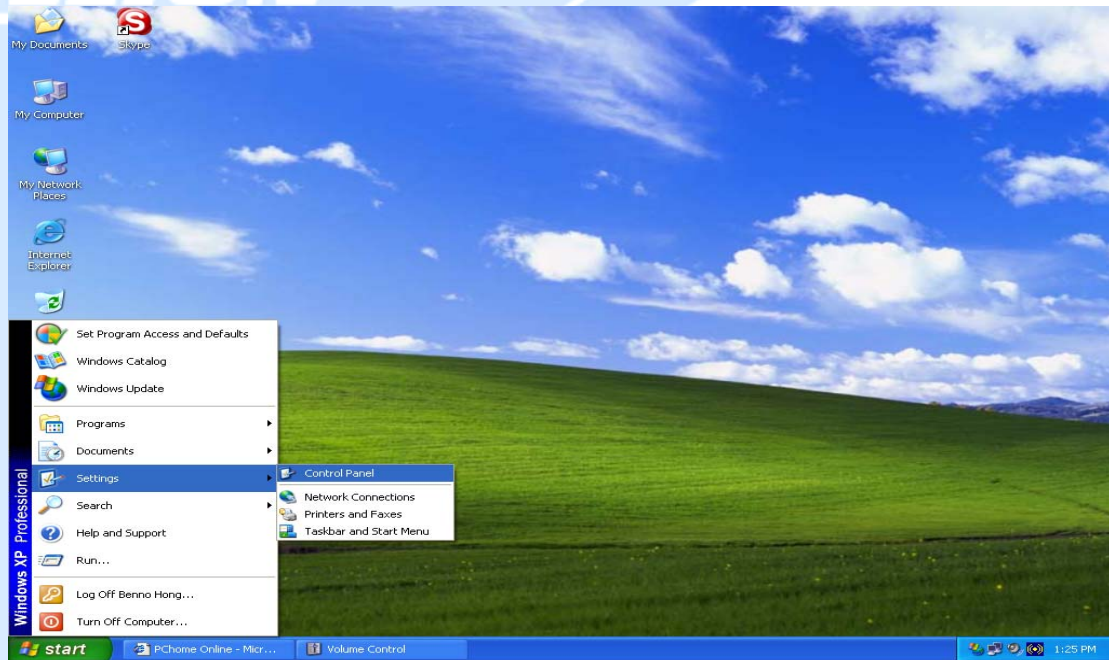

2. Double-click the **Network** icon.

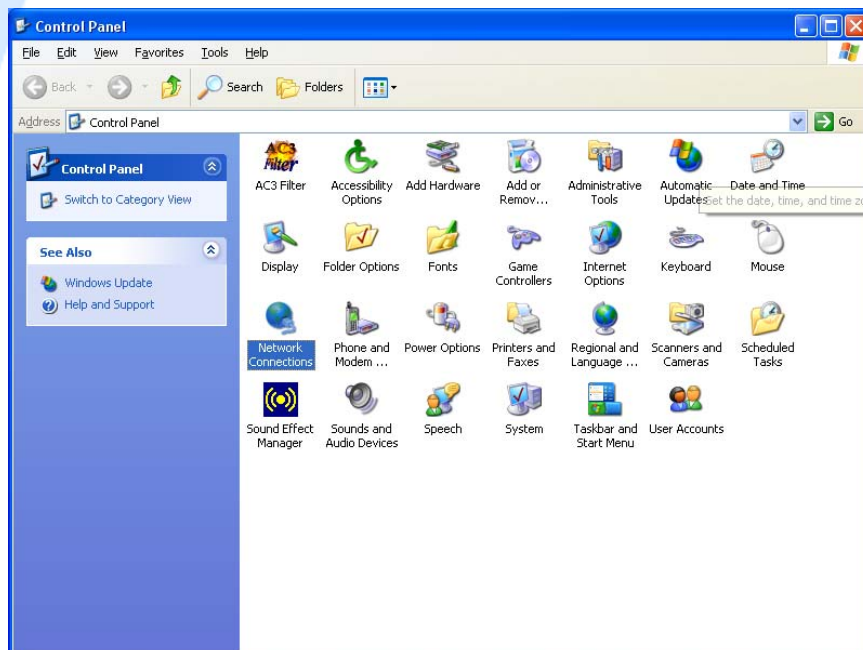

3. In the **Network Connections** window, right-click **Local Area Connection** and select **Properties**.

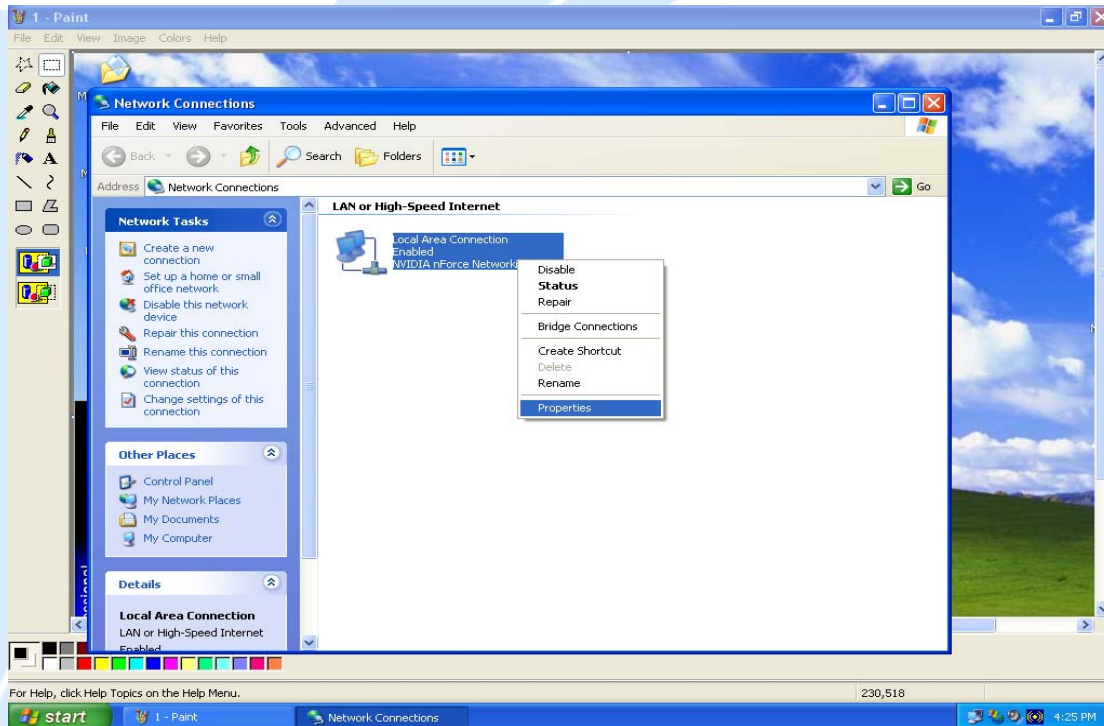

4. Select **Internet Protocol (TCP/IP)** and click **Properties**.

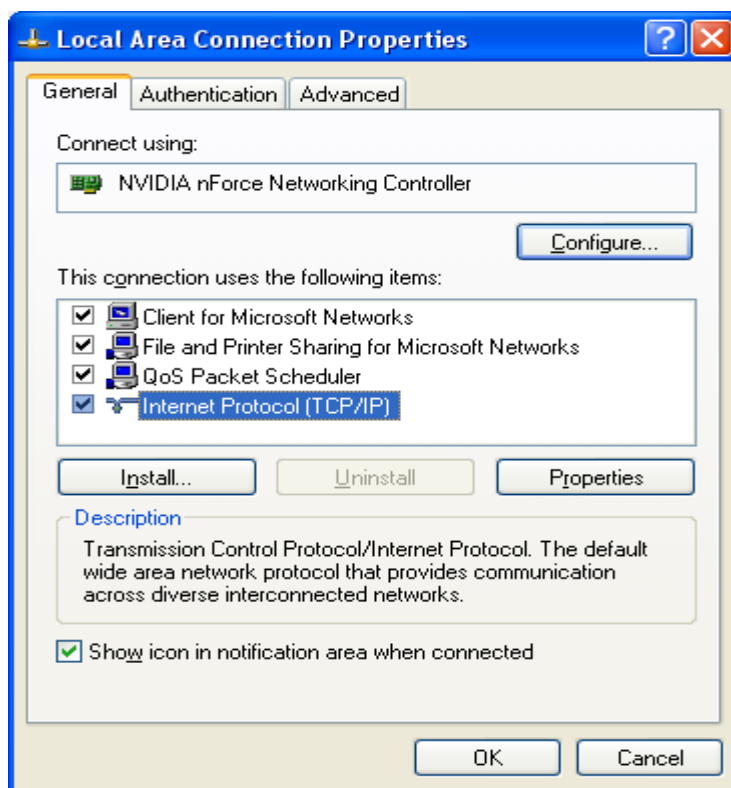

5. If an **IP address**, **subnet mask** and a **Default gateway** are shown, write down the information. If no address is present, your account's IP address is dynamically

assigned. Click the **Obtain an IP address automatically** radio button.

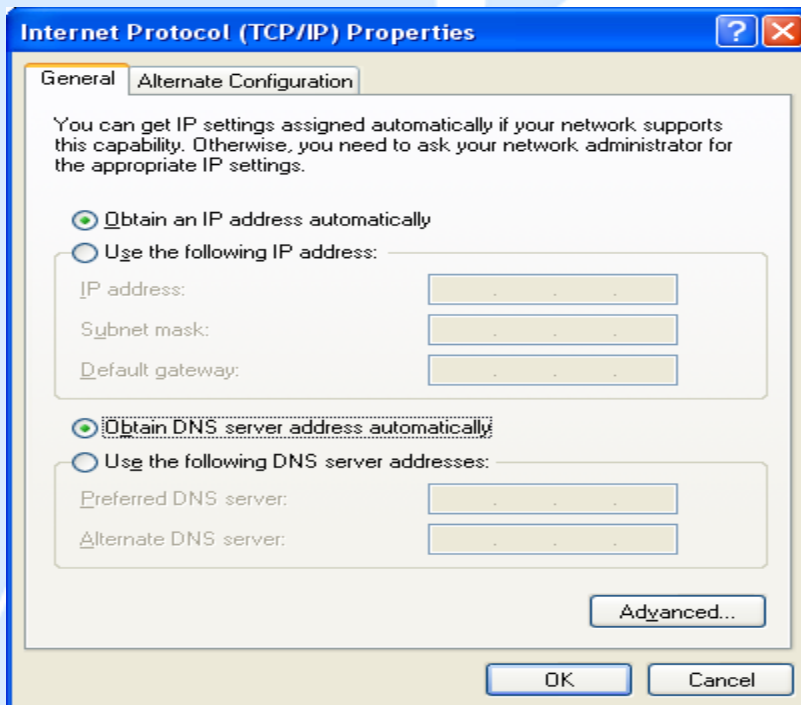

6. If any DNS server addresses are shown, write them down. Click the **Obtain DNS server address automatically** radio button.

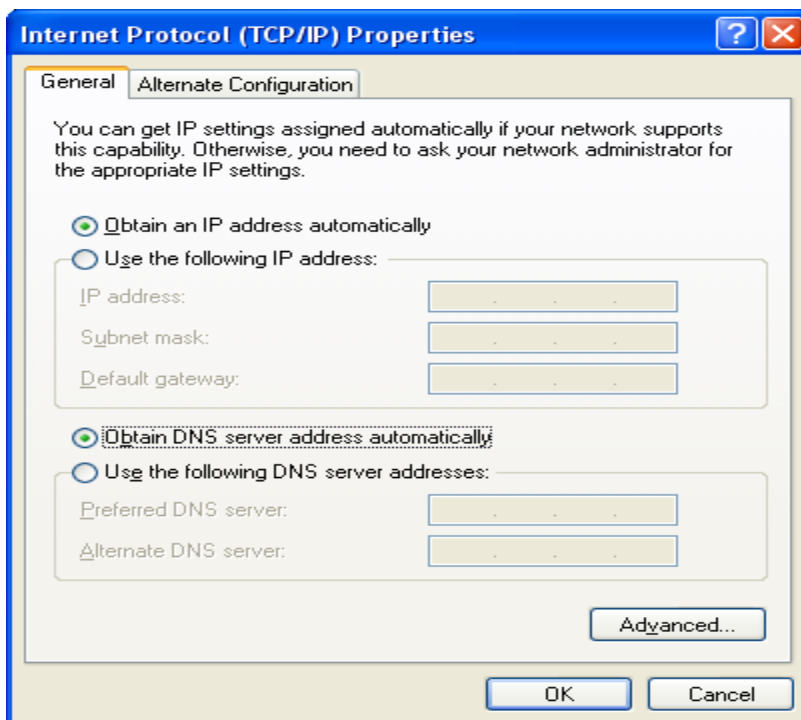

7. Click **OK** to save your changes.

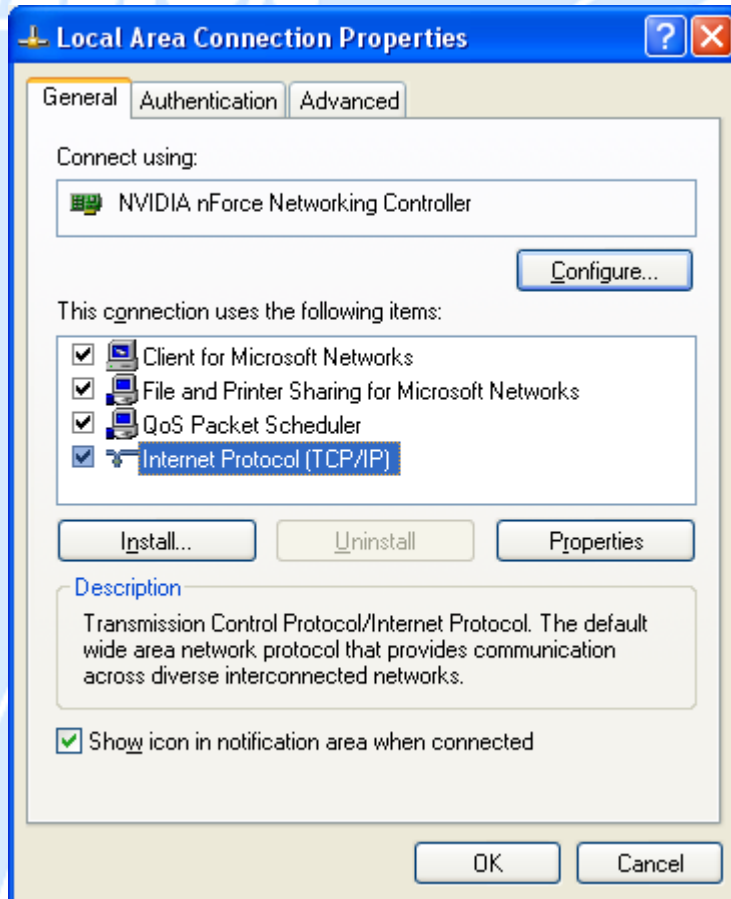

3.7 Web Configuration Interface

BiGuard 50G includes a Web Configuration Interface for easy administration via virtually any browser on your network. To access this interface, open your web browser, enter the IP address of your router, which by default is 192.168.1.254, and click **Go**. A user name and password window prompt will appear. Enter your user name and password (the default user name and password are "admin" and "admin") to access the Web Configuration Interface.



The server 192.168.1.254 at WebAdmin requires a username and password.

Warning: This server is requesting that your username and password be sent in an insecure manner (basic authentication without a secure connection).

User name:

Password:

Remember my password

If the Web Configuration Interface appears, congratulations! You are now ready to configure your BiGuard 50G. If you are having trouble accessing the interface, please refer to **Chapter 5: Troubleshooting** for possible resolutions.

Status		<input type="button" value="Refresh"/>
Device Information		
Device Name	BiGuard50G	
System Up Time	0:22:38:53 (day:hour:min:sec)	
Registration	Not Registered	<input type="button" value="Register"/>
Failover Status	Failover (WAN1 is active)	
Current Time	Tue Aug 2 10:38:40 2005	<input type="button" value="Sync Now"/>
PrivateLAN MAC address	00:11:22:dd:44:55	
PublicWAN1 MAC address	00:11:22:dd:44:56	
PublicWAN2 MAC address	00:11:22:dd:44:57	
Firmware Version	1.08I	
Home URL	Billion Electric Co.,Ltd.	
LAN		
IP address	192.168.1.254	
Netmask	255.255.255.0	
DHCP server	Enabled	
WAN1		
Connection Method	Connect by DHCP	
IP address	connecting	<input type="button" value="Release"/> <input type="button" value="Renew"/>
Netmask		
Gateway		
DNS server		
Up Time		
WAN2		
Connection Method	No Link.	
IP address		
Netmask		
Gateway		
DNS		
Up Time		

Chapter 4: Router Configuration

4.1 Overview

The Web Configuration Interface makes it easy for you to manage your network via any PC connected to it. On the Web Configuration homepage, you will see the navigation pane located on the left hand side. From it, you will be able to select various options used to configure your router.

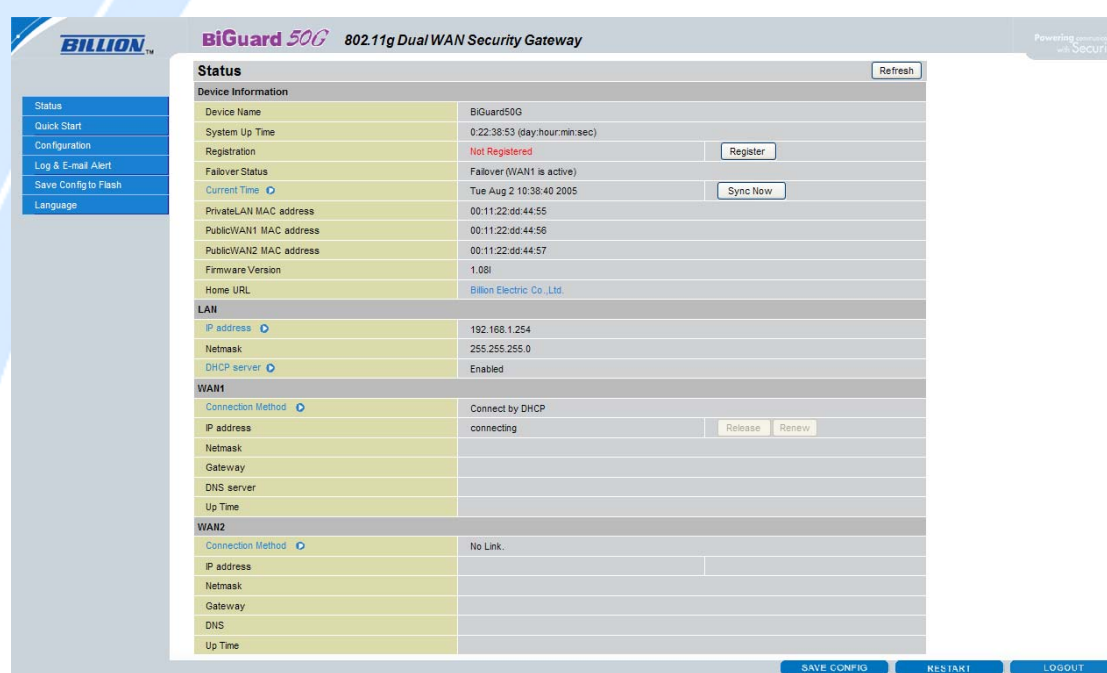

1. Click **Apply** if you would like to apply the settings on the current screen to the device. The settings will be effective immediately, however the configuration is not saved yet and the settings will be erased if you power off or restart the device.
2. Click **SAVE CONFIG** to save the current settings permanently to the device.
3. Click **RESTART** to restart the device. There are two options to restart the device.
 - Select **Current Settings** if you would like to restart using the current configuration.
 - Select **Factory Default Settings** if you would like to restart using the factory default configuration.
4. To exit the router's web interface, click **LOGOUT**. Please ensure that you have saved your configuration settings before you log out. Be aware that the router is

restricted to only one PC accessing the web configuration interface at a time. Once a PC has logged into the web interface, other PCs cannot gain access until the current PC has logged out. If the previous PC forgets to logout, the second PC can access the page after a user-defined period (5 minutes by default).

The following sections will show you how to configure your router using the Web Configuration Interface.

4.2 Status

The Status menu displays the various options that have been selected and a number of statistics about your BiGuard 50G.

Status		Refresh
Device Information		
Device Name	BiGuard50G	
System Up Time	0:22:38:53 (day:hour:min:sec)	
Registration	Not Registered	Register
Failover Status	Failover (WAN1 is active)	
Current Time ▶	Tue Aug 2 10:38:40 2005	Sync Now
PrivateLAN MAC address	00:11:22:dd:44:55	
PublicWAN1 MAC address	00:11:22:dd:44:56	
PublicWAN2 MAC address	00:11:22:dd:44:57	
Firmware Version	1.08l	
Home URL	Billion Electric Co.,Ltd.	
LAN		
IP address ▶	192.168.1.254	
Netmask	255.255.255.0	
DHCP server ▶	Enabled	
WAN1		
Connection Method ▶	Connect by DHCP	
IP address	connecting	Release Renew
Netmask		
Gateway		
DNS server		
Up Time		
WAN2		
Connection Method ▶	No Link.	
IP address		
Netmask		
Gateway		
DNS		
Up Time		

Device Information

Device Name: Displays the device name.

System Up Time: System uptime enables a user to determine how long has the system being online or the time that an unexpected restart or fault occurred. The system up-time is restarted when there is a power failure or upon software or hardware reset.

Registration: Click on the **Register** button to open a web page on Billion's website to register the BiGuard 50G. Registration enables users to access new firmware, a user's manual, latest product news, quick customer support, and FAQ.

Failover Status: Displays the current Failover port and show whether it is active or inactive.

Current Time: Displays the current time.

PrivateLAN MAC address: Displays the LAN MAC address for the LAN ports.

PublicWAN1 MAC address: Displays the WAN MAC address for the WAN1.

PublicWAN2 MAC address: Displays the WAN MAC address for the WAN2.

Firmware Version: Displays the current firmware version for the device.

Home URL: Displays the manufacturers website.

LAN

IP address: Displays the IP address of your device. You can click on the link to edit the IP address and the gateway IP.

Netmask: Displays the subnet mask for the LAN.

DHCP Server: Displays whether DHCP server is enabled or not. You can click on the link to edit the DHCP server.

WAN1

Connection Method: Displays the connection method for WAN1.

IP address: Displays the IP address for WAN1.

Netmask: Displays the subnet mask for WAN1.

Gateway: Displays the gateway for WAN1.

DNS Server: Displays the DNS Server for WAN1.

Up Time: Displays the time that WAN1 has been connected.

WAN2

Connection Method: Displays the connection method for WAN2.

IP address: Displays the IP address for WAN1.

Netmask: Displays the subnet mask for WAN2.

Gateway: Displays the gateway for WAN2.

DNS Server: Displays the DNS Server for WAN2.

Up Time: Displays the time that WAN2 has been connected.

In this menu, you will find the following sections:

- **ARP Table**
- **Wireless Association**
- **Routing Table**
- **Session Table**
- **DHCP Table**
- **IPSec Status**
- **PPTP Status**
- **Traffic Statistics**
- **CPU Status**
- **System Log**

Status
ARP Table
Wireless Association
Routing Table
Session Table
DHCP Table
IPSec Status
PPTP Status
Traffic Statistics
CPU Status
System Log

4.2.1 ARP Table

The Address Resolution Protocol (ARP) Table shows the mapping of Internet (IP) addresses to Ethernet (MAC) addresses. This is a quick way to determine the MAC address of your PC's network interface to use with the router's Firewall – MAC Address Filter function. See the **Firewall** section of this chapter for more information on this feature.

ARP Table				
IP <> MAC List				
No.	IP Address	MAC Address	Interface	Static
1	192.168.1.11	00:10:60:E0:84:F8	LAN	no
2	192.168.1.101	00:0E:35:1B:2C:D5	LAN	no

No.: Number of the list.

IP Address: A list of IP addresses of devices on your LAN.

MAC Address: The Media Access Control (MAC) addresses for each device on your LAN.

Interface: The interface name (on the router) that this IP address connects to.

Static: Static status of the ARP table entry.

NO indicates dynamically-generated ARP table entries.

YES indicates static ARP table entries added by the user.

4.2.2 Wireless Association

The Wireless Association Table displays the wireless client's MAC address with its corresponding IP address.

Wireless Association Table	
Wireless client's MAC address and the corresponding IP address	
IP Address	MAC
192.168.1.101	00:0E:35:1B:2C:D5

IP Address: A list of IP addresses of devices on your WLAN.

MAC Address: The Media Access Control (MAC) addresses for each device on your WLAN.

4.2.3 Routing Table

The Routing Table displays the current path for transmitted packets. Both static and dynamic routes are displayed.

Routing Table				
Routing Table				
No.	Destination	Netmask	Gateway/Interface	Cost
1	192.168.1.0	255.255.255.0	0.0.0.0/ LAN	0

No.: Number of the list.

Destination: The IP address of the destination network.

Netmask: The destination netmask address.

Gateway/Interface: The IP address of the gateway or existing interface that this route will use.

Cost: The number of hops counted as the cost of the route.

4.2.4 Session Table

The NAT Session Table displays a list of current sessions for both incoming and outgoing traffic with protocol type, source IP, source port, destination IP and destination port, each page shows 10 sessions.

Session Table					
Session Table					
No.	Protocol	From IP	From Port	To IP	To Port
1	TCP	192.168.1.11	4178	192.168.1.254	80
2	TCP	192.168.1.11	4179	192.168.1.254	80
3	TCP	192.168.1.11	4180	192.168.1.254	80

Session 1 - 3 of 3, 1/1.

Filter	From IP <input type="text"/>	From Port <input type="text"/>	To IP <input type="text"/>	To Port <input type="text"/>
First	Previous	Next	Last	Jump to session <input type="text"/> GO

No.: Number of the list.

Protocol: Protocol type of the Session.

From IP: Source IP of the session.

From Port: source port of the session.

To IP: Destination IP of the session.

To Port: Destination port of the session.

Sessions:

Filter: when the presented field is filled, please click Filter button.

From IP: please input the source IP you would like to filter.

From Port: please input the source port you would like to filter.

To IP: please input the destination IP you would like to filter.

To Port: please input the destination port you would like to filter.

First: To the first page.

Previous: To the previous page.

Next: To the next page.

Last: To the last page.

Jump to the session: please input the session number you would like to see and press "GO"

4.2.5 DHCP Table

The DHCP Table displays a list of IP addresses that have been assigned to PCs on your network via Dynamic Host Configuration Protocol (DHCP).

DHCP Table				
DHCP IP Assignment Table				
No.	IP Address	Device Name	MAC Address	Lease Time
1	192.168.1.100	Unknown Client	00:19:d2:85:43:21	185718
2	192.168.1.101	Unknown Client	00:0e:35:1b:2c:d5	0

No.: Number of the list.

IP Address: A list of IP addresses of devices on your LAN.

Device Name: The host name (computer name) of the client.

MAC Address: The MAC address of client.

Lease Time: The connection time to the DHCP server.

4.2.6 IPsec Status

The IPsec Status window displays the status of the IPsec Tunnels that are currently configured on your BiGuard 50G.

IPsec Status							
IPsec Tunnels							
Name	Enable	Status	Local Network	Remote Network	Remote Gateway	SA	Action

Name: The name you assigned to the particular IPSec entry.

Enable: Whether the IPSec connection is currently Enable or Disable.

Status: Whether the IPSec is Active, Inactive or Disable.

Local Subnet: The local IP address or subnet used.

Remote Subnet: The subnet of the remote site.

Remote Gateway: The remote gateway IP address.

SA: The Security Association for this IPSec entry.

Action: Manually connect or drop the tunnel.

4.2.7 PPTP Status

The PPTP Status window displays the status of the PPTP Tunnels that are currently configured on your BiGuard 50G.

PPTP Status						
PPTP Accounts						
Name	Enable	Status	Type	Peer Network	Connect By	Action

Name: The name you assigned to the particular PPTP entry.

Enable: Whether the PPTP connection is currently Enable or Disable.

Status: Whether the PPTP is Active, Inactive or Disable.

Type: Whether the Connection type is Remote Access or LAN to LAN

Peer Network: The Remote subnet for LAN to LAN as connection type.

Connect by: The remote address when connected.

Action: Manually drop the tunnel.

4.2.8 Traffic Statistics

The Traffic Statistics window displays both sent and received sent data (in Bytes/sec) over a one hour duration. The line in red represents WAN1, while the line in blue represents WAN2.

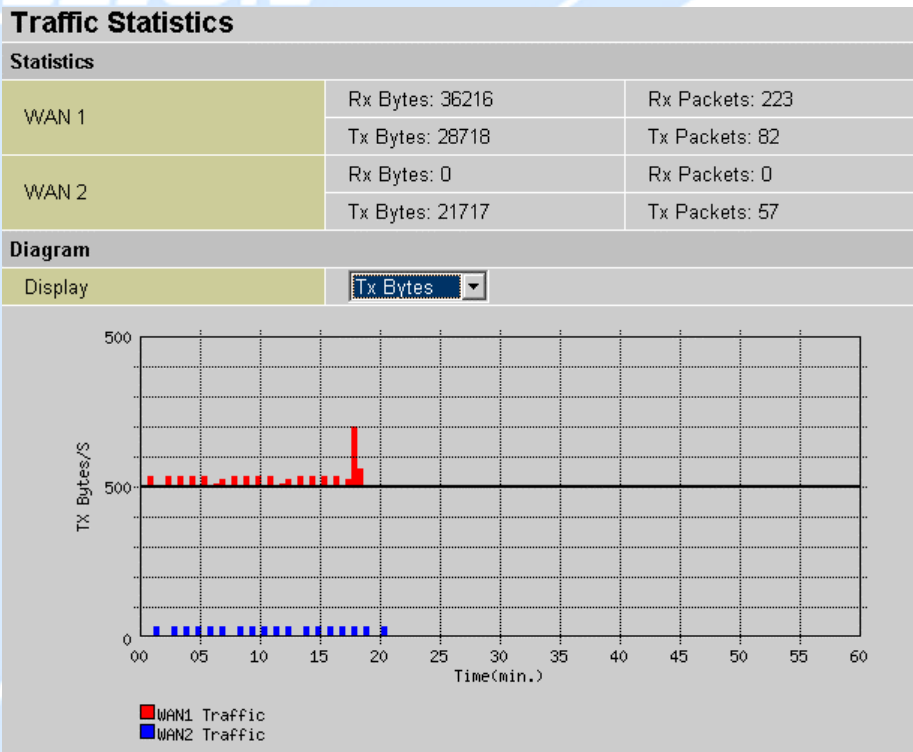

WAN1: Transmitted (Tx) and Received (Rx) bytes and packets for WAN1.

WAN2: Transmitted (Tx) and Received (Rx) bytes and packets for WAN2.

Display: Allows you to change the units of measurement for the traffic graph.

4.2.9 CPU Statistics

This page displays the router's system information.

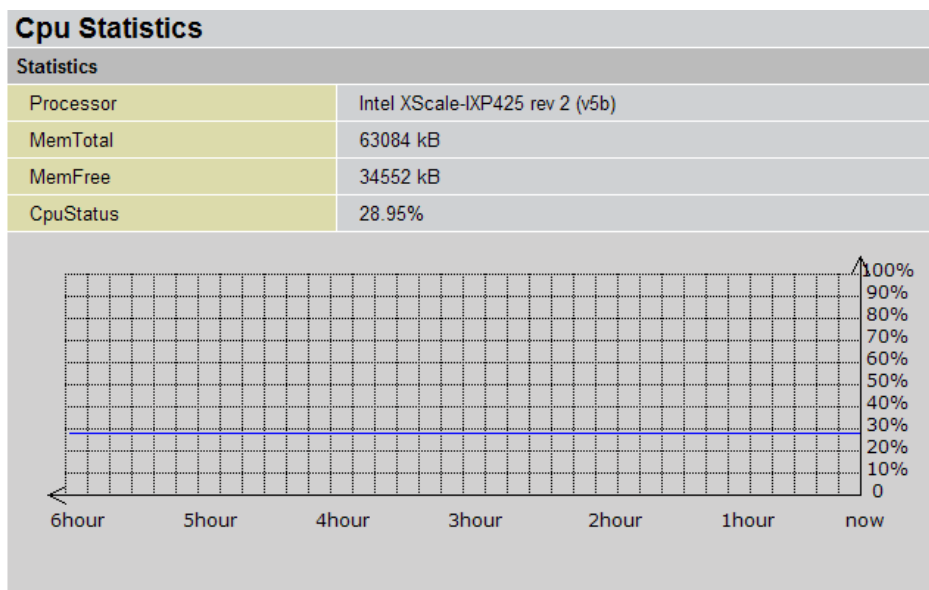

Processor: The router's processor type and model.

MemTotal: The router's physical memory size.

MemFree: The router's current free memory size.

CPU status: The CPU's usage shown in percentage each minute.

When the CPU percentage in use is higher than 80% the line will turn red.

When the CPU percentage in use is lower than 80% the line will turn blue.

4.2.10 System Log

This window displays BiGuard 50G's System Log entries. Major events are logged on this window.

System Log				
Logs				
Display <input type="text" value="All Logs"/> <input type="button" value="Refresh"/> <input type="button" value="Clear Log"/> <input type="button" value="Send Log"/> <input type="button" value="Save Log"/>				
No.	Time	Message	Source	Destination
1	Aug 2 11:14:27	SysMan DHCP fail to obtain lease.		
2	Aug 2 11:15:25	SysMan WAN Connection - DHCP client - send discover		
3	Aug 2 11:15:27	SysMan WAN Connection - DHCP client - send discover		
4	Aug 2 11:15:29	SysMan WAN Connection - DHCP client - send discover		
5	Aug 2 11:15:33	SysMan DHCP fail to obtain lease.		
6	Aug 2 11:16:33	SysMan WAN Connection - DHCP client - send discover		
7	Aug 2 11:16:35	SysMan WAN Connection - DHCP client - send discover		
8	Aug 2 11:16:37	SysMan WAN Connection - DHCP client - send discover		
9	Aug 2 11:16:42	SysMan DHCP fail to obtain lease.		
10	Aug 2 11:17:41	SysMan WAN Connection - DHCP client - send discover		

« First < Previous 1 /61 Next > Last »

Display: There are several options in display, **All logs** allows the system to show all types of system logs, and there are also specific event logs such as; **System Maintenance, System Errors, Access Control, Packet Filter, LAN MAC Filter, URL Filter, Intrusion Detection, Call Data Record, PPP, Remote Access, and IPSEC.**

Refresh: Refresh the System Log.

Clear Log: Clear the System Log.

Send Log: Send the System Log to your email account. You can set the email address in **Configuration > System > Email Alert**. See the **Email Alert** section for more details.

Save Log: Save the System log to a text file.

There are several links at the bottom right of the table indicating '<<First', '<Previous', a **dropdown menu** for the number of pages, 'Next>' and 'Last>>'.</p>
</div>
<div data-bbox="484 938 511 955" data-label="Page-Footer">
<p>78</p>
</div>
<div data-bbox="284 972 709 987" data-label="Page-Footer">
<p>Download from Wwww.Somanuals.com. All Manuals Search And Download.</p>
</div>
<div data-bbox="667 930 998 992" data-label="Page-Footer">
<p>Powering communications with Security</p>
</div>

First directs the page number for the table to the 1st page, **previous** directs the page number for the table to the one page before, the **dropdown menu** allows the user to specifically select the page number to view, **next** directs the page number for the table to the one page after current page, and **last** directs the page number for the table to the last page of the table.

Please refer to **Appendix F: IPSec Log Events** for more information on log events.

4.3 Quick Start

The Quick Start menu allows you to quickly configure your network for Internet access using the most basic settings. The Quick Start can be applied to both WAN1 or WAN2.

Connection Method: Select your router's connection to the Internet. Selections include **Obtain an IP Address Automatically**, **Static IP Settings**, **PPPoE Settings**, **PPTP Settings**, and **Big Pond Settings**.

4.3.1 DHCP

The following is information regarding your ISP that you will need to enter in order to properly configure your Internet connection. If you select to **Obtain an IP Address Automatically**, these will be automatically set for you, provided that your ISP dynamically assigns an IP address.

Quick Start WAN1	
DHCP	
Connection Method	Obtain an IP Address Automatically ▾
Host Name	<input type="text"/>
<input type="button" value="Apply"/> <input type="button" value="Reset"/>	

4.3.2 Static IP

Quick Start WAN1	
Static IP	
Connection Method	Static IP Settings
IP assigned by your ISP	0 . 0 . 0 . 0
IP Subnet Mask	0 . 0 . 0 . 0
ISP Gateway Address	0 . 0 . 0 . 0
Primary DNS	0 . 0 . 0 . 0
Secondary DNS	0 . 0 . 0 . 0
<input type="button" value="Apply"/> <input type="button" value="Reset"/>	

IP assigned by your ISP: Enter the assigned IP address from your IP.

IP Subnet Mask: Enter your IP subnet mask.

ISP Gateway Address: Enter your ISP gateway address.

Primary DNS: Enter your primary DNS.

Secondary DNS: Enter your secondary DNS.

Click **Apply** to save your changes. To reset to defaults, click **Reset**.

4.3.3 PPPoE

Quick Start WAN1	
PPPoE	
Connection Method	PPPoE Settings
Username	<input type="text"/>
Password	<input type="password"/>
Retype Password	<input type="password"/>
Connection	Always Connect
Idle Time	10 minutes
<input type="button" value="Apply"/> <input type="button" value="Reset"/>	

Username: Enter your user name.

Password: Enter your password.

Retype Password: Retype your password.

Connection: Select whether the connection should **Always Connect** or **Trigger on Demand**. If you want the router to establish a PPPoE session when starting up and to automatically re-establish the PPPoE session when disconnected by the ISP, select **Always Connect**. If you want to establish a PPPoE session only when there

is a packet requesting access to the Internet (i.e. when a program on your computer attempts to access the Internet), select **Trigger on Demand**.

Idle Time: Auto-disconnect the router when there is no activity on the line for a predetermined period of time. Select the idle time from the drop down menu. Active if **Trigger on Demand** is selected.

Click **Apply** to save your changes. To reset to defaults, click **Reset**.

4.3.4 PPTP

Quick Start WAN1	
PPTP	
Connection Method	PPTP Settings
Username	<input type="text"/>
Password	<input type="password"/>
Retype Password	<input type="password"/>
PPTP Client IP	<input type="text"/> . <input type="text"/> . <input type="text"/> . <input type="text"/>
PPTP Client IP Netmask	<input type="text"/> . <input type="text"/> . <input type="text"/> . <input type="text"/>
PPTP Client IP Gateway	<input type="text"/> . <input type="text"/> . <input type="text"/> . <input type="text"/>
PPTP Server IP	<input type="text"/> . <input type="text"/> . <input type="text"/> . <input type="text"/>
Connection	Always Connect
Idle Time	10 minutes

Username: Enter your user name.

Password: Enter your password.

Retype Password: Retype your password.

PPTP Client IP: Enter the PPTP Client IP provided by your ISP.

PPTP Client IP Netmask: Enter the PPTP Client IP Netmask provided by your ISP.

PPTP Client IP Gateway: Enter the PPTP Client IP Gateway provided by your ISP.

PPTP Server IP: Enter the PPTP Server IP provided by your ISP.

Connection: Select whether the connection should **Always Connect** or **Trigger on Demand**. If you want the router to establish a PPTP session when starting up and to automatically re-establish the PPTP session when disconnected by the ISP, select **Always Connect**. If you want to establish a PPTP session only when there is a packet requesting access to the Internet (i.e. when a program on your computer attempts to access the Internet), select **Trigger on Demand**.

Idle Time: Auto-disconnect the router when there is no activity on the line for a

predetermined period of time. Select the idle time from the drop down menu. Active if **Trigger on Demand** is selected.

Click **Apply** to save your changes. To reset to defaults, click **Reset**.

4.3.5 Big Pond

Quick Start WAN1	
Big Pond	
Connection Method	Big Pond Settings <input type="button" value="v"/>
Username	<input type="text"/>
Password	<input type="password"/>
Retype Password	<input type="password"/>
Login server	<input type="text" value="0"/> . <input type="text" value="0"/> . <input type="text" value="0"/> . <input type="text" value="0"/>
<input type="button" value="Apply"/> <input type="button" value="Reset"/>	

Username: Enter your user name.

Password: Enter your password.

Retype Password: Retype your password.

Login Server: Enter the IP of the Login server provided by your ISP.

Click **Apply** to save your changes. To reset to defaults, click **Reset**.

For detailed instructions on configuring WAN settings, please refer to the **WAN** section of this chapter.

4.4 Configuration

The **Configuration** menu allows you to set many of the operating parameters of BiGuard 50G. In this menu, you will find the following sections:

- LAN
- WAN
- Dual WAN
- System
- Firewall
- VPN

- QoS
- Virtual Server
- Advanced

These items are described below in the following sections.

Configuration
LAN
WAN
Dual WAN
System
Firewall
VPN
QoS
Virtual Server
Advanced

4.4.1 LAN

There are three items within this section: **Ethernet, Wireless, Wireless Security, DHCP Server and LAN Address Mapping.**

Configuration
LAN
Ethernet
Wireless
Wireless Security
DHCP Server
LAN Address Mapping

4.4.1.1 Ethernet

Ethernet				
Parameters				
IP Address	192	168	1	254
Subnet Mask	255	255	255	0
RIP	Disable <input checked="" type="radio"/> RIP-2B <input type="radio"/> RIP-2M			
Apply Reset				

IP Address: Enter the internal LAN IP address for BiGuard 50G (192.168.1.254 by default).

Subnet Mask: Enter the subnet mask (255.255.255.0 by default).

RIP: RIP v2 Broadcast and RIP v2 Multicast. Check to enable RIP.

Wireless

Wireless	
Parameters	
WLAN service	<input checked="" type="radio"/> Enable <input type="radio"/> Disable
Mode	802.11b+g ▼
ESSID	BG50G
Hide ESSID	<input type="radio"/> Enable <input checked="" type="radio"/> Disable
Regulation Domain	Europe ▼
WMM(QOS)	<input type="radio"/> Enable <input checked="" type="radio"/> Disable
WMM-APSD	<input type="radio"/> Enable <input checked="" type="radio"/> Disable
Channel ID	Channel 1 (2.412 GHz) ▼
MAC Address	00:19:DB:91:DF:2A
AP Version	RT2561T 1.0.9.0
Wireless Distribution System (WDS)	
WDS Service	<input type="radio"/> Enable <input checked="" type="radio"/> Disable
1.Peer WDS MAC Address	<input type="text"/>
2.Peer WDS MAC Address	<input type="text"/>
3.Peer WDS MAC Address	<input type="text"/>
4.Peer WDS MAC Address	<input type="text"/>
** WDS depends on the settings of main security encryption type. **	
<input type="button" value="Apply"/> <input type="button" value="Cancel"/>	

WLAN Service: Default setting is set to **Disable**. If you have any wireless, both 802.11g and 802.11b, device in your network, you can select **Enable**.

Mode: The default setting is **802.11b+g** (Mixed mode). If you do not know or have both 11g and 11b devices in your network, then keep the default in **mixed mode**. From the drop-down manual, you can select **802.11g** if you have only 11g card. If you have only 11b card, then select **802.11b**.

ESSID: The ESSID is the unique name of a wireless access point (AP) to be distinguished from another. For security propose, change to a unique ID name to the AP which is already built-in to the router's wireless interface. It is case sensitive and must not excess 32 characters. Make sure your wireless clients have exactly the ESSID as the device, in order to get connected to your network.

Note: ESSID is case sensitive and must not excess 32 characters.

Hide ESSID: It is function in which transmits its ESSID to the air so that when wireless client searches for a network, router can then be discovered and recognized. Default setting is **Disable**.

Enable: Select **Enable** if you do not want broadcast your ESSID. When select **Enable**, no one will be able to locate the Access Point (AP) of your router.

Disable: When **Disable** is selected, you can allow anybody with a wireless client to be able to locate the Access Point (AP) of your router.

Regulation Domain: There are five Regulation Domains for you to choose from, including **North America (N.America)**, **Europe**, **France**, etc. The Channel ID will be different based on this setting.

WMM(QoS): Wi-Fi Multimedia (WMM) QoS, the specification provides basic prioritization of data packets through the wireless network. When **enabled**, you will be less likely to hear delays during phone conversations, or higher quality live streaming whilst watching videos. The improvement is due to the delay of other network traffics which are not as critical and can be expensed, such as downloading files where a small delay is generally acceptable. For WMM QoS to work properly after it is enabled, both the servers and network cards communicating with each other must support WMM.

WMM-APSD: Enable WMM-APSD if you want to turn on the power saving mode. WMM Automatic Power Save Delivery (APSD) provides efficient power management method to the router. It does so by waking up the wireless module of the router when there is a need to send or receive, then it goes back to sleep mode once the communication has ended. This mechanism will save more power through the router than the traditional 'always on' method.

Channel ID: Select the ID channel that you would like to use.

Tx Power Level: It is function that enhances the wireless transmitting signal strength. User may adjust this power level from minimum 0 up to maximum 255.

Note: The Power Level maybe different in each access network user premises environment and choose the most suitable level for your network.

AP MAC Address: It is a unique hardware address of the Access Point.

AP Firmware Version: The Access Point firmware version.

Wireless Distribution System (WDS)

It is a wireless access point mode that enables wireless link and communication with other access point. It is easy to be installed, simply define the peer's MAC address

of the connected AP. WDS takes advantages of cost saving and flexibility which no extra wireless client device is required to bridge between two access points and extending an existing wired or wireless infrastructure network to create a larger network.

In addition, WDS enhances its link connection security in WEP mode, WEP key encryption must be the same for both access points.

WDS Service: The default setting is **Disable**. Check **Enable** radio button to activate this function.

- 1. Peer WDS MAC Address:** It is the associated AP's MAC Address. It is important that your peer's AP must include your MAC address in order to acknowledge and communicate with each other.
- 2. Peer WDS MAC Address:** It is the second associated AP's MAC Address.
- 3. Peer WDS MAC Address:** It is the third associated AP's MAC Address.
- 4. Peer WDS MAC Address:** It is the fourth associated AP's MAC Address.

Note: For MAC Address, Semicolon (:) or Dash (-) must be included.

4.4.1.2 Wireless Security

You can disable or enable with WPA or WEP for protecting wireless network. The default mode of wireless security is **disabled**.

Wireless Security	
Parameters	
Security Mode	Disable
<input type="button" value="Apply"/> <input type="button" value="Cancel"/>	

WPA Pre-Shared Key

Wireless Security	
Parameters	
Security Mode	WPA Pre-Shared Key
WPA Algorithm	TKIP
WPA Shared Key	0000000000
Group Key Renewal	3600 Seconds
<input type="button" value="Apply"/> <input type="button" value="Cancel"/>	

WPA Algorithms: TKIP (Temporal Key Integrity Protocol) / AES(Advanced

Encryption Standard) utilizes a stronger encryption method and incorporates Message Integrity Code (MIC) to provide protection against hackers.

WPA Shared Key: The key for network authentication. The input format is in character style and key size should be in the range between 8 and 63 characters.

Group Key Renewal: The period of renewal time for changing the security key automatically between wireless client and Access Point (AP).

WPA2 Pre-Shared Key

Wireless Security	
Parameters	
Security Mode	WPA2 Pre-Shared Key ▾
WPA2 Algorithm	TKIP ▾
WPA2 Shared Key	0000000000
Group Key Renewal	3600 Seconds

WPA2 Algorithms: TKIP (Temporal Key Integrity Protocol) / AES(Advanced Encryption Standard) utilizes a stronger encryption method and incorporates Message Integrity Code (MIC) to provide protection against hackers.

WPA2 Shared Key: The key for network authentication. The input format is in character style and key size should be in the range between 8 and 63 characters.

Group Key Renewal: The period of renewal time for changing the security key automatically between wireless client and Access Point (AP).

4.4.1.3 WEP

Wireless Security	
Parameters	
Security Mode	WEP
WEP Authentication	Open System
WEP Encryption	HEX <input type="radio"/> WEP64 <input checked="" type="radio"/> WEP128
Default Used WEP Key	<input checked="" type="radio"/> 1 <input type="radio"/> 2 <input type="radio"/> 3 <input type="radio"/> 4
Key 1	0000000000
Key 2	0000000000
Key 3	0000000000
Key 4	0000000000
Passphrase	<input type="text"/> <input type="button" value="Generate Key"/>
<input type="button" value="Apply"/> <input type="button" value="Cancel"/>	

WEP Encryption: To prevent unauthorized wireless stations from accessing data transmitted over the network, the router offers highly secure data encryption, known as WEP. If you require high security for transmissions, there are two alternatives to select from: **WEP 64** and **WEP 128**. WEP 128 will offer increased security over WEP 64.

Default Used WEP Key: Select the encryption key ID; please refer to **Key (1 ~ 4)** below.

Passphrase: This is used to generate WEP keys automatically based upon the input string and a pre-defined algorithm in WEP64 or WEP128. You can input the same string in both the AP and Client card settings to generate the same WEP keys. Please note that you do not have to enter **Key (1-4)** as below when the **Passphrase** is enabled..

Key (1-4): Enter the key to encrypt wireless data. To allow encrypted data transmission, the WEP Encryption Key values on all wireless stations must be the same as the router. There are four keys for your selection. The input format is in HEX style, 5 and 13 HEX codes are required for WEP64 and WEP128 respectively-no any separator is included.

4.4.1.4 DHCP Server

In this menu, you can disable or enable the Dynamic Host Configuration Protocol (DHCP) server. The DHCP protocol allows your BiGuard 50G to dynamically assign IP addresses to PCs on your network if they are configured to automatically obtain IP addresses.

DHCP Server	
Parameters	
DHCP Server Functions	<input checked="" type="radio"/> Enable <input type="radio"/> Disable
IP Pool Range From	192.168.1.100
IP Pool Range to	192.168.1.199
Primary DNS Server	0 . 0 . 0 . 0
Secondary DNS Server	0 . 0 . 0 . 0
Primary WINS Server	0 . 0 . 0 . 0
Secondary WINS Server	0 . 0 . 0 . 0
Domain Name	

[Fixed Host](#) 

To disable the router's DHCP Server, select the **Disable** radio button, and then click **Apply**. When the DHCP Server is disabled, you will need to manually assign a fixed IP address to each PC on your network, and set the default gateway for each PC to the IP address of the router (192.168.1.254 by default).

To configure the router's DHCP Server, select the **Enable** radio button, and then configure parameters of the DHCP Server including the IP Pool (starting IP address and ending IP address to be allocated to the PCs on your network), DNS Server, WINS Server, and Domain Name. These details are sent to each DHCP client when they request an IP address from the DHCP server. Click **Apply** to enable this function.

Fixed Host allows specific computer/network clients to have a reserved IP address.

Fixed Host

Fixed Host Table

Name	Active	IP Address	MAC Address
<input type="text"/>	<input checked="" type="radio"/> Enable <input type="radio"/> Disable	<input type="text"/>	<input type="text"/>

Name: Enter the name you want to give for the IP+Mac Address Fixed Host account.

Active: Select whether you want to Enable or Disable this particular Fixed Host account.

IP Address: Enter the IP address that you want to reserve for the above MAC address.

MAC Address: Enter the MAC address of the PC or server you wish to be assigned a reserved IP.

Candidates: You can also select the Candidates which are referred from the ARP table for automatic input.

Click the **Apply** button to add the configuration into the Host Table.

4.4.1.5 LAN Address Mapping

LAN Address Mapping is a function that can support multiple subnet and also multiple NAT, you can specify a subnet and LAN Gateway IP Address and select associated WAN IP Address specified in WAN IP Alias in **Configuration -> WAN -> WAN IP Alias**.

LAN Address Mapping						
LAN Address Mapping Table						
NO.	Name	IP Address	Netmask	WAN IP		
Create ▶						

Please click Create to create a LAN Address Mapping rule.

LAN Address Mapping				
Add Subnet				
Name	<input type="text"/>			
IP Address	<input type="text" value="0"/>	<input type="text" value="0"/>	<input type="text" value="0"/>	<input type="text" value="0"/>
Netmask	<input type="text" value="0"/>	<input type="text" value="0"/>	<input type="text" value="0"/>	<input type="text" value="0"/>
WAN IP Address	Candidates ▶	<input type="text" value="0"/>	<input type="text" value="0"/>	<input type="text" value="0"/>
<input type="button" value="Apply"/>				

Name: Please input the name of the rule.

IP Address: Please input the LAN Gateway IP Address you would like to use.

Netmask: Please input the Netmask you would like to use.

WAN IP Address: Please click Candidates to select the WAN IP address you would like to use from WAN Alias list.

Click the **Apply** button to add the configuration into the LAN Address Mapping.

4.4.2 WAN

WAN refers to your Wide Area Network connection. In most cases, this means your router's connection to the Internet through your ISP. BiGuard30 features Dual WAN capability. There are three items within this section:

Configuration
LAN
WAN
ISP Settings
Bandwidth Settings
WAN IP Alias

The WAN menu contains two items: **ISP Settings**, **Bandwidth Settings** and **WAN IP Alias**.

4.4.2.1 ISP Settings

ISP Settings		
WAN Service Table		
Name	Description	
WAN1	DHCP	Edit ▶
WAN2	DHCP	Edit ▶

This ISP Settings Table displays the different WAN connections that are configured on BiGuard 50G. To edit any of these connections, click **Edit**. You will be taken to the following menu.

WAN1	
DHCP	
Connection Method	Obtain an IP Address Automatically ▾
Host Name	<input type="text"/>
MAC Address Candidates ▶	<input type="checkbox"/> Your ISP requires you to input WAN Ethernet MAC MAC Address <input type="text"/> 00 <input type="text"/> 00 <input type="text"/> 00 <input type="text"/> 00 <input type="text"/> 00 <input type="text"/> 00
DNS	<input type="checkbox"/> Your ISP requires you to manually setup DNS settings Primary DNS <input type="text"/> 0 <input type="text"/> 0 <input type="text"/> 0 <input type="text"/> 0 Secondary DNS <input type="text"/> 0 <input type="text"/> 0 <input type="text"/> 0 <input type="text"/> 0
RIP	Disable ▾ <input checked="" type="radio"/> RIP-2B <input type="radio"/> RIP-2M
MTU	<input type="text"/> 1500
Network Address Translation	<input checked="" type="radio"/> Enable <input type="radio"/> Disable
<input type="button" value="Apply"/> <input type="button" value="Reset"/>	

Connection Method: Select how your router will connect to the Internet. Selections include **Obtain an IP Address Automatically**, **Static IP Settings**, **PPPoE Settings**, **PPTP Settings**, and **Big Pond Settings**. For each WAN port, the factory default is DHCP. If your ISP does not use DHCP, select the correct connection method and configure the connection accordingly. Configurable items will vary depending on the connection method selected.

4.4.2.1.1 DHCP

WAN1	
DHCP	
Connection Method	Obtain an IP Address Automatically ▾
Host Name	<input type="text"/>
MAC Address Candidates ▶	<input type="checkbox"/> Your ISP requires you to input WAN Ethernet MAC MAC Address <input type="text"/> 00 <input type="text"/> 00 <input type="text"/> 00 <input type="text"/> 00 <input type="text"/> 00 <input type="text"/> 00
DNS	<input type="checkbox"/> Your ISP requires you to manually setup DNS settings Primary DNS <input type="text"/> 0 <input type="text"/> 0 <input type="text"/> 0 <input type="text"/> 0 Secondary DNS <input type="text"/> 0 <input type="text"/> 0 <input type="text"/> 0 <input type="text"/> 0
RIP	Disable ▾ <input checked="" type="radio"/> RIP-2B <input type="radio"/> RIP-2M
MTU	<input type="text"/> 1500
Network Address Translation	<input checked="" type="radio"/> Enable <input type="radio"/> Disable
<input type="button" value="Apply"/> <input type="button" value="Reset"/>	

Host Name: Some ISPs authenticate logins using this field.

MAC Address: If your ISP requires you to input a WAN Ethernet MAC, check the checkbox and enter your MAC address in the blanks below.

Candidates: You can also select the MAC address from the list in the Candidates.

DNS: If your ISP requires you to manually setup DNS settings, check the checkbox and enter your primary and secondary DNS.

RIP: To activate RIP, select **Send, Receive,** or **Both** from the drop down menu. To disable RIP, select **Disable** from the drop down menu.

MTU: Enter the Maximum Transmission Unit (MTU) for your network.

Network Address Translation: Enables or Disables the NAT function. To apply this interface as router mode please select Disable. Due to default firewall feature, if you would like to use router mode, you have to input the packet filter rules you would like to forward in **Configuration -> Firewall -> Packet filter**

Click **Apply** to save your changes. To reset to defaults, click **Reset**.

4.4.2.1.2 Static IP

WAN1	
Static IP	
Connection Method	Static IP Settings
IP assigned by your ISP	0 . 0 . 0 . 0
IP Subnet Mask	0 . 0 . 0 . 0
ISP Gateway Address	0 . 0 . 0 . 0
MAC Address	<input type="checkbox"/> Your ISP requires you to input Ethernet MAC
Candidates	MAC Address 00 . 00 . 00 . 00 . 00 . 00
Primary DNS	0 . 0 . 0 . 0
Secondary DNS	0 . 0 . 0 . 0
RIP	Disable <input checked="" type="radio"/> RIP-2B <input type="radio"/> RIP-2M
MTU	1500
Network Address Translation	<input checked="" type="radio"/> Enable <input type="radio"/> Disable
<input type="button" value="Apply"/> <input type="button" value="Reset"/>	

IP assigned by your ISP: Enter the static IP assigned by your ISP.

IP Subnet Mask: Enter the IP subnet mask provided by your ISP.

ISP Gateway Address: Enter the ISP gateway address provided by your ISP.

MAC Address: If your ISP requires you to input a WAN Ethernet MAC, check the checkbox and enter your MAC address in the blanks below.

Candidates: You can also select the MAC address from the list in the Candidates.

Primary DNS: Enter the primary DNS provided by your ISP.

Secondary DNS: Enter the secondary DNS provided by your ISP.

RIP: To activate RIP, select **Send**, **Receive**, or **Both** from the drop down menu. To disable RIP, select **Disable** from the drop down menu.

MTU: Enter the Maximum Transmission Unit (MTU) for your network.

Network Address Translation: Enables or Disables the NAT function. To apply this interface as router mode please select Disable. Due to default firewall feature, if you would like to use router mode, you have to input the packet filter rules you would like to forward in **Configuration -> Firewall -> Packet filter**

Click **Apply** to save your changes. To reset to defaults, click **Reset**.

4.4.2.1.3 PPPoE

WAN1	
PPPoE	
Connection Method	PPPoE Settings
Username	<input type="text"/>
Password	<input type="password"/>
Retype Password	<input type="password"/>
Connection	Always Connect
Idle Time	10 minutes
IP assignd by your ISP	<input checked="" type="radio"/> Dynamic (IP automatically assigned by your ISP)
	<input type="radio"/> Fixed (Your ISP requires you to input IP address)
	<input type="text"/> . <input type="text"/> . <input type="text"/> . <input type="text"/>
MAC Address Candidates	<input type="checkbox"/> Your ISP requires you to input WAN Ethernet MAC
	MAC Address <input type="text"/> - <input type="text"/> - <input type="text"/> - <input type="text"/> - <input type="text"/> - <input type="text"/>
DNS	<input type="checkbox"/> Your ISP requires you to manually setup DNS settings
	Primary DNS <input type="text"/> . <input type="text"/> . <input type="text"/> . <input type="text"/>
	Secondary DNS <input type="text"/> . <input type="text"/> . <input type="text"/> . <input type="text"/>
RIP	Disable <input type="radio"/> RIP-2B <input checked="" type="radio"/> RIP-2M
MTU	1492
Network Address Translation	<input checked="" type="radio"/> Enable <input type="radio"/> Disable
<input type="button" value="Apply"/> <input type="button" value="Reset"/>	

Username: Enter your user name.

Password: Enter your password.

Retype Password: Retype your password.

Connection: Select whether the connection should **Always Connect** or **Trigger on Demand**. If you want the router to establish a PPPoE session when starting up and to automatically re-establish the PPPoE session when disconnected by the ISP,

select **Always Connect**. If you want to establish a PPPoE session only when there is a packet requesting access to the Internet (i.e. when a program on your computer attempts to access the Internet), select **Trigger on Demand**.

Idle Time: Auto-disconnect the router when there is no activity on the line for a predetermined period of time. Select the idle time from the drop down menu. Active if **Trigger on Demand** is selected.

IP Assigned by your ISP: If your IP is dynamically assigned by your ISP, select the **Dynamic** radio button. If your IP assigns a static IP address, select the **Static** radio button, and input your IP address in the blank provided.

MAC Address: If your ISP requires you to input a WAN Ethernet MAC, check the **checkbox** and enter your MAC address in the blanks below.

Candidates: You can also select the MAC address from the list in the Candidates.

DNS: If your ISP requires you to manually setup DNS settings, check the checkbox and enter your primary and secondary DNS.

RIP: To activate RIP, select **Send, Receive, or Both** from the drop down menu. To disable RIP, select **Disable** from the drop down menu.

MTU: Enter the Maximum Transmission Unit (MTU) for your network.

Network Address Translation: Enables or Disables the NAT function. To apply this interface as router mode please select Disable. Due to default firewall feature, if you would like to use router mode, you have to input the packet filter rules you would like to forward in **Configuration -> Firewall -> Packet filter**

Click **Apply** to save your changes. To reset to defaults, click **Reset**.

4.4.2.1.4 PPTP Settings

WAN1	
PPTP	
Connection Method	PPTP Settings
Username	<input type="text"/>
Password	<input type="password"/>
Retype Password	<input type="password"/>
PPTP Client IP	<input type="text"/> . <input type="text"/> . <input type="text"/> . <input type="text"/>
PPTP Client IP Netmask	<input type="text"/> . <input type="text"/> . <input type="text"/> . <input type="text"/>
PPTP Client IP Gateway	<input type="text"/> . <input type="text"/> . <input type="text"/> . <input type="text"/>
PPTP Server IP	<input type="text"/> . <input type="text"/> . <input type="text"/> . <input type="text"/>
Connection	Always Connect
Idle Time	10 minutes
IP assigned by your ISP	<input checked="" type="radio"/> Dynamic (IP automatically assigned by your ISP)
	<input type="radio"/> Fixed (Your ISP requires you to input IP address)
	<input type="text"/> . <input type="text"/> . <input type="text"/> . <input type="text"/>
MAC Address Candidates	<input type="checkbox"/> Your ISP requires you to input WAN Ethernet MAC
	MAC Address <input type="text"/> - <input type="text"/> - <input type="text"/> - <input type="text"/> - <input type="text"/> - <input type="text"/>
DNS	<input type="checkbox"/> Your ISP requires you to manually setup DNS settings
	Primary DNS <input type="text"/> . <input type="text"/> . <input type="text"/> . <input type="text"/>
	Secondary DNS <input type="text"/> . <input type="text"/> . <input type="text"/> . <input type="text"/>
RIP	Disable <input type="radio"/> <input checked="" type="radio"/> RIP-2B <input type="radio"/> RIP-2M
MTU	1432
Network Address Translation	<input checked="" type="radio"/> Enable <input type="radio"/> Disable
<input type="button" value="Apply"/> <input type="button" value="Reset"/>	

Username: Enter your user name.

Password: Enter your password.

Retype Password: Retype your password.

PPTP Client IP: Enter the PPTP Client IP provided by your ISP.

PPTP Client IP Netmask: Enter the PPTP Client IP Netmask provided by your ISP.

PPTP Client IP Gateway: Enter the PPTP Client IP Gateway provided by your ISP.

PPTP Server IP: Enter the PPTP Server IP provided by your ISP.

Connection: Select whether the connection should **Always Connect** or **Trigger on Demand**. If you want the router to establish a PPTP session when starting up and to automatically re-establish the PPTP session when disconnected by the ISP, select **Always Connect**. If you want to establish a PPTP session only when there is a packet requesting access to the Internet (i.e. when a program on your computer attempts to access the Internet), select **Trigger on Demand**.

Idle Time: Auto-disconnect the router when there is no activity on the line for a predetermined period of time. Select the idle time from the drop down menu. Active if **Trigger on Demand** is selected.

IP Assigned by your ISP: If your IP is dynamically assigned by your ISP, select the **Dynamic** radio button. If your IP assigns a static IP address, select the **Static** radio

button. This will take you to another page for inputting the IP address information.

MAC Address: If your ISP requires you to input a WAN Ethernet MAC, check the checkbox and enter your MAC address in the blanks below.

Candidates: You can also select the MAC address from the list in the Candidates.

DNS: If your ISP requires you to manually setup DNS settings, check the checkbox and enter your primary and secondary DNS.

RIP: To activate RIP, select **Send, Receive,** or **Both** from the drop down menu. To disable RIP, select **Disable** from the drop down menu.

MTU: Enter the Maximum Transmission Unit (MTU) for your network.

Network Address Translation: Enables or Disables the NAT function. To apply this interface as router mode please select Disable. Due to default firewall feature, if you would like to use router mode, you have to input the packet filter rules you would like to forward in **Configuration -> Firewall -> Packet filter**

Click **Apply** to save your changes. To reset to defaults, click **Reset**.

4.4.2.1.5 Big Pond Settings

WAN1	
Big Pond	
Connection Method	Big Pond Settings
Username	<input type="text"/>
Password	<input type="password"/>
Retype Password	<input type="password"/>
Login server	<input type="text"/> . <input type="text"/> . <input type="text"/> . <input type="text"/>
MAC Address Candidates	<input type="checkbox"/> Your ISP requires you to input WAN Ethernet MAC MAC Address <input type="text"/> - <input type="text"/> - <input type="text"/> - <input type="text"/> - <input type="text"/> - <input type="text"/>
DNS	<input type="checkbox"/> Your ISP requires you to manually setup DNS settings Primary DNS <input type="text"/> . <input type="text"/> . <input type="text"/> . <input type="text"/> Secondary DNS <input type="text"/> . <input type="text"/> . <input type="text"/> . <input type="text"/>
RIP	Disable <input type="checkbox"/> <input checked="" type="radio"/> RIP-2B <input type="radio"/> RIP-2M
MTU	<input type="text"/> 1500
Network Address Translation	<input checked="" type="radio"/> Enable <input type="radio"/> Disable
<input type="button" value="Apply"/> <input type="button" value="Reset"/>	

Username: Enter your user name.

Password: Enter your password.

Retype Password: Retype your password.

Login Server: Enter the IP of the Login server provided by your ISP.

MAC Address: If your ISP requires you to input a WAN Ethernet MAC, check the checkbox and enter your MAC address in the blanks below.

Candidates: You can also select the MAC address from the list in the Candidates.

DNS: If your ISP requires you to manually setup DNS settings, check the checkbox and enter your primary and secondary DNS.

RIP: To activate RIP, select **Send, Receive, or Both** from the drop down menu. To disable RIP, select **Disable** from the drop down menu.

MTU: Enter the Maximum Transmission Unit (MTU) for your network.

Network Address Translation: Enables or Disables the NAT function. To apply this interface as router mode please select Disable. Due to default firewall feature, if you would like to use router mode, you have to input the packet filter rules you would like to forward in **Configuration -> Firewall -> Packet filter**

Click **Apply** to save your changes. To reset to defaults, click **Reset**.

A simpler alternative is to select **Quick Start** from the main menu. Please see the **Quick Start** section of this chapter for more information.

4.4.2.2 Bandwidth Settings

Under Bandwidth Settings, you can easily configure both inbound and outbound bandwidth for each WAN port.

Bandwidth Settings			
Max Bandwidth Provided by ISP			
WAN 1	Outbound Bandwidth	<input type="text" value="102400"/>	kbps
	Inbound Bandwidth	<input type="text" value="102400"/>	kbps
WAN 2	Outbound Bandwidth	<input type="text" value="102400"/>	kbps
	Inbound Bandwidth	<input type="text" value="102400"/>	kbps
 <i>These bandwidth settings will be referenced by QoS and Loadbalance functions.</i>			
<input type="button" value="Apply"/>			

WAN1: Enter your ISP inbound and outbound bandwidth for WAN1.

WAN2: Enter your ISP inbound and outbound bandwidth for WAN2.

NOTE: These values entered here are referenced by both QoS and Load Balancing functions.

WAN IP Alias

WAN IP Alias allows you to input additional WAN IP addresses. WAN IP Alias can be used for Multiple NAT settings, including LAN Address Mapping settings and Virtual Server settings.

WAN IP Alias					
WAN IP Alias Table					
NO.	Name	IP Address	Interface		
Create					

Please click Create to create a LAN Address Mapping rule.

WAN IP Alias	
Add WAN IP	
Name	<input type="text"/>
IP Address	<input type="text" value="0"/> <input type="text" value="0"/> <input type="text" value="0"/> <input type="text" value="0"/>
Interface	<input checked="" type="radio"/> WAN1 <input type="radio"/> WAN2
<input type="button" value="Apply"/>	

Name: Please input the name of the rule.

IP Address: Please input the additional WAN IP address you would like to use.

Interface: Please select the WAN Interface that you would like to add the additional WAN IP to.

Click the **Apply** button to add the configuration into the WAN IP Alias.

4.4.3 Dual WAN

Configuration
LAN
WAN
Dual WAN
General Setting
Outbound Load Balance
Inbound Load Balance
Protocol Binding

In this section, you can setup the fail over or load balance function, outbound load balance or inbound load balance function, or setup specific protocol to bind with

specific WAN port. In this menu are the following sections: General Settings, Outbound Load Balance, Inbound Load Balance, and Protocol Binding.

4.4.3.1 General Settings

General Setting	
Dual WAN Mode	
Mode	<input type="radio"/> Load Balance <input checked="" type="radio"/> Fail Over
WAN Port Service Detection Policy	
Service Detection (for load balance.)	<input checked="" type="radio"/> Enable <input type="radio"/> Disable
Connectivity Decision	Not in service when probing failed after <input type="text" value="3"/> consecutive times.
Probe Cycle	Every <input type="text" value="30"/> seconds.
Probe WAN1	<input checked="" type="radio"/> Gateway
	<input type="radio"/> Host <input type="text" value="0"/> . <input type="text" value="0"/> . <input type="text" value="0"/> . <input type="text" value="0"/>
Probe WAN2	<input checked="" type="radio"/> Gateway
	<input type="radio"/> Host <input type="text" value="0"/> . <input type="text" value="0"/> . <input type="text" value="0"/> . <input type="text" value="0"/>
Failback to WAN1 when possible (for failover.)	<input type="radio"/> Enable
	<input checked="" type="radio"/> Disable
<input type="button" value="Apply"/>	

Mode: You can select Load Balance or Fail Over.

Service Detection: Enables or disables the service detection feature. For fail over, the service detection function is enabled. For load balance, user is able to enable or disable it.

Connectivity Decision: Establishes the number of times probing the connection has to fail before the connection is judged as failed.

Probe Cycle: The number of seconds between each probe.

Probe WAN1: Determines if WAN1 is a gateway or host. If host is selected, please enter the IP address.

Probe WAN2: Determines if WAN2 is a gateway or host. If host is selected, please enter the IP address.

Fail back to WAN1 when possible: Enables or disables fail back to WAN1. This function only applies to fail over.

Click **Apply** to save your changes.

4.4.3.2 Outbound Load Balance

Dual Wan		
Outbound Load Balance		
Load Balance Policy	<input checked="" type="radio"/> Based on session mechanism	<input type="radio"/> Balance by Session (Round Robin)
		<input checked="" type="radio"/> Balance by Session (weight of link capacity)
		<input type="radio"/> Balance by Session weight <input type="text"/> : <input type="text"/>
	<input type="radio"/> Based on IP address hash mechanism	<input type="radio"/> Balance by Traffic (weight of link capacity)
		<input type="radio"/> Balance by Traffic weight <input type="text"/> : <input type="text"/>
		<input checked="" type="radio"/> Balance by weight of link capacity
		<input type="radio"/> Balance by weight <input type="text"/> : <input type="text"/>
<input type="button" value="Apply"/>		

Outbound Load Balancing on BiGuard 50G can be based on one of two methods:

1. By session mechanism
2. By IP address hash mechanism

Choose one by clicking the corresponding radio button.

Based on Session Mechanism: The source IP address and destination IP address can go through WAN1 or WAN2 depending to policies set in this mechanism. You can choose this mechanism if the applications the users use will not tell the difference of the WAN IP addresses. (some applications in the Internet need to identify the source IP address, e.g. Back, Forum, ...)

Balance by Session (Round Robin): Balances session traffic based on a round robin method.

Balance by Session (weight of length capacity): Balances session traffic based on weight of length capacity.

Balance by Session weight: Balances session traffic based on a weight ratio. Enter the desired ratio in the blanks provided.

Balance by Traffic (weight of length capacity): Balances traffic based on weight of link capacity.

Balance by Traffic weight: Balances traffic based on a traffic weight ratio. Enter the desired ratio into the blanks provided.

Based on IP hash mechanism: The source IP address and destination IP address will go through specific WAN port (WAN1 or WAN2) according to policy settings in this mechanism. This will assure that some applications will work when it would like

to authenticate the source IP address.

Balance by weight of link capacity: Uses an IP hash to balance traffic based on weight of link bandwidth capacity.

Balance by weight: Uses an IP hash to balance traffic based on a ratio. Enter the desired ratio into the blanks provided.

Click **Apply** to save your changes.

4.4.3.3 Inbound Load Balance

Dual Wan		
Inbound Load Balance		
Function	<input type="radio"/> Enable <input checked="" type="radio"/> Disable	
DNS Server 1	Server Settings	Edit ▶
	Host URL Mappings	Edit ▶
DNS Server 2	Server Settings	Edit ▶
	Host URL Mappings	Edit ▶
<input type="button" value="Apply"/>		

Function: Used to enable or disable inbound load balancing.

DNS Server 1: DNS Server 1 settings including Host URL mappings.

DNS Server 2: DNS Server 2 settings including Host URL mappings.

To edit server settings, click Edit. The following example illustrates DNS Server 1 settings. DNS Server 2 settings follow a similar procedure.

DNS Server 1	
SOA	
Domain Name	<input type="text"/>
* Primary Name Server	<input type="text"/>
Admin. Mail Box	<input type="text"/>
Serial Number	<input type="text" value="1"/>
Refresh Interval	<input type="text" value="36000"/> Sec.
Retry Interval	<input type="text" value="600"/> Sec.
Expiration Time	<input type="text" value="86400"/> Sec.
Minimum TTL	<input type="text" value="180"/> Sec.
NS Record	
* Name Server	<input type="text"/>
MX Record	
* Mail Exchanger	<input type="text"/>
IP Address	<input checked="" type="radio"/> Private <input type="radio"/> Public <input type="text" value="0"/> <input type="text" value="0"/> <input type="text" value="0"/> <input type="text" value="0"/>
* : Domain will be appended automatically in these fields.	
<input type="button" value="Apply"/>	

SOA:

Domain Name: The domain name of DNS Server 1. It is the name that you register on DNS organization. You have to fill-out the Fully Qualified Domain Name (FQDN) with an ending character (a dot) for this text field.(ex:abc.com.).When you enter the following domain name, you can only input different chars without an ending dot, its name is then added with domain name, and it becomes FQDN.

Primary Name Server: The name assigned to the Primary Name Server.
(e.g:aaa, its FQDN is aaa.abc.com.)

Admin.

Mail Box: The administrator's email account.(e.g:admin@abc.com.)

Serial Number: It is the version number that keeps in the SOA record.

Refresh Interval: The interval refreshes are done. Denoted in seconds.

Retry Interval: The interval retries are done. Denoted in seconds.

Expiration Time: The length of time that can elapse before the zone is no longer authoritative. Denoted in seconds.

Minimum TTL: The minimum time to live. Denoted in seconds.

NS Record

Name Server: The name of the Primary Name Server.

MX Record

Mail Exchanger: The name of the mail server.

IP Address: The mail server IP address.

Click **Apply** to save your changes.

To edit the Host Mapping URL list, click **Edit**. This will open the Host Mapping URL table, which lists the current Host Mapping URLs.

Host URL Mapping List					
List table					
Host URL	Domain Name	Local IP Address	Protocol	Port Range	
Create ▶					

To add a host mapping URL to the list, click **Create**.

Host URL Mappings	
A Record	
Domain Name	asdaad
* Host URL	<input type="text"/>
Private IP Address Candidates ▶	<input type="text"/> 0 <input type="text"/> 0 <input type="text"/> 0 <input type="text"/> 0
Protocol	Any ▼
Port Range Helper ▶	<input type="text"/> 1 ~ <input type="text"/> 65535
CNAME	
* Name1	<input type="text"/>
* Name2	<input type="text"/>
* : Domain will be appended automatically in these fields.	
<input type="button" value="Apply"/>	

Domain Name: The domain name of the local host.

Host URL: The URL address to be mapped.

Private IP Address: The IP address of the local host.

Helper: You could also select the application type you would like to apply for automatic input.

Port Range: The port range of all incoming packets are accepted and processed by a local host with the specified private IP address.

Candidates: You can also select the Candidates which are referred from the ARP table for automatic input.

Name1: The Alias Host URL

Name2: The Alias Host URL

Click **Apply** to save your changes.

4.4.3.4 Protocol Binding

Protocol Binding lets you direct specific traffic to go out from a specific WAN port. Click the **Create** button to create a new policy entry. Policies entered would tell specific types of Internet traffic from a particular range of IPs to go to a particular range of IPs with ONE WAN port, rather than using both of the WAN ports with load balancing.

(NOTE: If any policies are added in the Protocol Binding section, please note that it would take precedence over the settings that are already configured in the Load Balance Setting section.)

Protocol Binding								
Protocol Binding Table								
No.	Interface	Src. IP	Src. Netmask	Dest. IP	Dest. Netmask	Protocol	Port Range	
Create								

The Protocol Binding Table lists any protocol binding that has been configured. To add a new binding, click **Create**.

Protocol Binding	
Add Protocol Binding Rules	
Interface	WAN 1
Source IP Range	<input checked="" type="radio"/> All Source IP <input type="radio"/> Specified Source IP
Source IP Address	0 . 0 . 0 . 0
Source IP Netmask	0 . 0 . 0 . 0
Destination IP Range	<input checked="" type="radio"/> All Destination IP <input type="radio"/> Specified Destination IP
Destination IP Address	0 . 0 . 0 . 0
Destination IP Netmask	0 . 0 . 0 . 0
Protocol	Any
Port Range Helper	1 ~ 65535
Protocol Binding has higher priority than Routing.	
Apply	

Interface: Choose which WAN port to use: WAN1, WAN2

Packet Type: The particular protocol of Internet traffic for the specified policy. Choose from TCP, UDP, or Any.

Source IP Range:

All Source IP: Click it to specify all source IPs.

Specified Source IP: Click to specify a specific source IP address and source IP netmask.

Source IP Address: If Specified Source IP was chosen, here's where the IP can be entered.

Source IP Netmask: If Specified Source IP was chosen, here's where the subnet mask can be entered.

Destination IP Range:

All Destination IP: Click it to specify all source IPs.

Specified Destination IP: Click to specify a specific destination IP address and Destination IP Netmask.

Destination IP Address: If Specified Destination IP was chosen, here's where the IP can be entered.

Destination IP Netmask: If Specified Destination IP was chosen, here's where the subnet mask can be entered.

Port Range: The range of ports for the specified policy (if you only want to use one port, enter the same value in both boxes).

Click **Apply** to save your changes.

4.4.4 System

The System menu allows you to adjust a variety of basic router settings, upgrade firmware, set up remote access, and more. In this menu are the following sections:

Time Zone, Remote Access, Firmware Upgrade, Backup/Restore, Restart, Password, System Log and E-mail Alert.

Configuration
LAN
WAN
Dual WAN
System
Time Zone
Remote Access
Firmware Upgrade
Backup / Restore
Restart
Password

Time Zone

BiGuard does not use an onboard real time clock; instead, it uses the Network Time Protocol (NTP) to acquire the current time from an NTP server outside your network. Simply choose your local time zone, enter NTP Server IP Address, and click **Apply**. After connecting to the Internet, BiGuard 50G will retrieve the correct local time from the NTP server you have specified. Your ISP may provide an NTP server for you to use.

Time Zone	
Parameters	
Time Zone	<input type="radio"/> Enable <input checked="" type="radio"/> Disable
Local Time Zone (+-GMT Time)	(GMT-07:00)Mountain Time (US & Canada) ▾
NTP Server Address	carl.css.gov india.colorado.edu
	time.nist.gov time-b.nist.gov
Daylight Saving	<input type="checkbox"/> Automatic
Resync Period	1440 minutes
v 	
<input type="button" value="Apply"/> <input type="button" value="Cancel"/>	

Time Zone: Select Enable or Disable this function.

Local Time Zone(+ -GMT Time): Please select the time zone that belongs to your area.

NTP Server Address: Please input the NTP server address you would like to use.

Daylight Saving: To have BiGuard 50G automatically adjust for Daylight Savings Time, please check the **Automatic** checkbox.

Resync Period: Please input the resync circle of time zone update.

Click **Apply** to apply the rule, Click Cancel to discard the changes.

Remote Access

To allow remote users to configure and manage BiGuard 50G through the Internet, select the Enable radio button. To deactivate remote access, select the Disable radio button. This function also enables you to grant access from any PC or from a specific IP address. Click Apply to save your settings.

NOTE: When enabling remote access, please make sure to change the default administration password for security reason.

Remote Access	
Remote Access Function	
Action	<input type="radio"/> Enable <input checked="" type="radio"/> Disable
* HTTPS Port	<input type="text" value="443"/>
*: This setting will become effective after you save to flash and restart the router.	
<input type="button" value="Apply"/>	

Remote Access Table			
No.	IP Address		
<input type="button" value="Create"/> 			

Action: Select Enable or Disable remote access function.

HTTPS Port: Please input the remote access HTTPS port you would like to use.(default is 443)

Click **Apply** to apply your settings.

Click **Create** to add a Remote Access Table to specify the allowed remote access addresses.

Remote Access	
You may permit remote administration of this network device (HTTPS).	
Allow Remote Access By	<input checked="" type="radio"/> Everyone (Change default password!)
	<input type="radio"/> Only this PC: <input type="text"/> . <input type="text"/> . <input type="text"/> . <input type="text"/>
	<input type="radio"/> PC from this subnet: <input type="text"/> . <input type="text"/> . <input type="text"/> . <input type="text"/> <input type="text"/> . <input type="text"/> . <input type="text"/> . <input type="text"/>
<input type="button" value="Apply"/>	

Allow Remote Access By:

Everyone: Please check if you allow any IP addresses for the remote user to access.

Only the PC: Please specify the IP Address that is allowed to access.

PC from the subnet: Please specify the subnet that is allowed to access.

4.4.4.3 Firmware Upgrade

Firmware Upgrade

You may upgrade the system software on your network device

New Firmware Image

Browse...

Upgrade

Upgrading your BiGuard 50G's firmware is a quick and easy way to enjoy increased functionality, better reliability, and ensure trouble-free operation. To upgrade your firmware, simply visit Billion's website (<http://www.billion.com>) and download the latest firmware image file for BiGuard 50G. Next, click **Browse** and select the newly downloaded firmware file. Click **Upgrade** to complete the update.

NOTE: DO NOT power down the router or interrupt the firmware upgrade while it is still in process. Interrupting the firmware upgrade process could damage the router.

4.4.4.4 Backup / Restore

Backup/Restore

Allows you to backup the configuration settings to your computer, or restore configuration from your computer.

Backup Configuration

Backup configuration to your computer.

Backup

Restore Configuration

Configuration File

Browse...

"Restore" will overwrite the current configuration and restart the device. If you want to keep the current configuration, please use "Backup" first to save current configuration.

Restore

This feature allows you to save and backup your router's current settings, or restore a previously saved backup. This is useful if you wish to experiment with different settings, knowing that you have a backup handy. It is advisable to backup your router's settings before making any significant changes to your router's configuration.

To backup your router's settings, click **Backup** and select where to save the settings

backup file. You may also change the name of the file when saving if you wish to keep multiple backups. Click **OK** to save the file.

To restore a previously saved backup file, click **Browse**. You will be prompted to select a file from your PC to restore. Be sure to only restore setting files that have been generated by the Backup function, and that were created when using the same firmware version. Settings files saved to your PC should not be manually edited in any way. After selecting the settings file you wish to use, clicking **Restore** will load those settings into the router.

4.4.4.5 Restart

Restart	
After restarting. Please wait for several seconds to let the system restart	
Restart Router with	<input checked="" type="radio"/> Current Settings
	<input type="radio"/> Factory Default Settings
<input type="button" value="Restart"/>	

The Restart feature allows you to easily restart BiGuard 50G. To restart with your last saved configuration, select the Current Settings radio button and click **Restart**.

If you wish to restart the router using the factory default settings, select Factory Default Settings and click Restart to reboot BiGuard 50G with factory default settings.

You may also reset your router to factory default settings by holding the Reset button on the router until the Status LED begins to blink. Once BiGuard 50G completes the boot sequence, the Status LED will stop blinking.

4.4.4.6 Password

Password	
Parameters	
Password
Confirm
 <i>Note: number of maximum characters of password is 32 characters.</i>	
<input type="button" value="Apply"/> <input type="button" value="Reset"/>	

In order to prevent unauthorized access to your router's configuration interface, it requires the administrator to login with a password. You can change your password by entering your new password in both fields. Click **Apply** to save your changes. Click **Reset** to reset to the default administration password (admin).

4.4.5 Firewall

BiGuard 50G includes a full Stateful Packet Inspection (SPI) firewall for controlling Internet access from your LAN, and preventing attacks from hackers. Your router also acts as a "natural" Internet firewall when using Network Address Translation (NAT), as all PCs on your LAN will use private IP addresses that cannot be directly accessed from the Internet. Please see the WAN configuration section for more details.

You can find five items under the Firewall section: **Packet Filter**, **URL Filter**, **Ethernet MAC Filter**, **Wireless MAC Filter**, **Block WAN Request**, and **Intrusion Detection**.

Configuration
LAN
WAN
Dual WAN
System
Firewall
Packet Filter
URL Filter
Ethernet MAC Filter
Wireless MAC Filter
Block WAN Request
Intrusion Detection

4.4.5.1 Packet Filter

Packet Filter										
Packet Filter Table										
ID	Enable	Action	Direction	Src. IP	Dest. IP	Protocol	Src. Port	Dest. Port		
Create										

The Packet Filter function is used to limit user access to certain sites on the Internet or LAN. The Filter Table displays all current filter rules. If there is an entry in the Filter Table, you can click **Edit** to modify the setting of this entry, click **Delete** to remove this entry, or click **Move** to change this entry's priority.

When the entry is upper, the priority is higher.

To create a new filter rule, click **Create**.

Packet Filter		
Add Filtering Rules		
ID	1	
Rule	<input checked="" type="radio"/> Enable <input type="radio"/> Disable	
Action When Matched	Drop	
Direction	Outgoing	
Source IP	Any	
	Start IP Address	0 . 0 . 0 . 0
	End IP Address	0 . 0 . 0 . 0
Destination IP	Any	
	Start IP Address	0 . 0 . 0 . 0
	End IP Address	0 . 0 . 0 . 0
Protocol	Any	
Source Port Range	1 ~ 65535	
Destination Port Range	1 ~ 65535	
Schedule	**Always	
Log	<input type="radio"/> Enable <input checked="" type="radio"/> Disable	
<input type="button" value="Apply"/>		

ID: This is an identify that allows you to move the rule by before or after an ID.

Rule: Enable or Disable this entry.

Action When Matched: Select to **Drop** or **Forward** the packet specified in this filter entry.

Direction: Incoming Packet Filter rules prevent unauthorized computers or applications accessing your local network from the Internet. Outgoing Packet Filter rules prevent unauthorized computers or applications accessing the Internet. Select if the new filter rule is incoming or outgoing.

Source IP: Select **Any**, **Subnet**, **IP Range** or **Single Address**.

Starting IP Address: Enter the source IP or starting source IP address this filter rule is to be applied.

End IP Address: Enter the End source IP Address this filter rule is to be applied. (for IP Range only)

Netmask: Enter the subnet mask of the above IP address.

Destination IP: Select **Any**, **Subnet**, **IP Range** or **Single Address**.

Starting IP Address: Enter the destination IP or starting destination IP address this filter rule is to be applied.

End IP Address: Enter the End destination IP Address this filter rule is to be applied. (for IP Range only)

Netmask: Enter the subnet mask of the above IP address.

Protocol: Select the Transport protocol type (Any, TCP, UDP).

Source Port Range: Enter the source port number range. If you only want to specify one service port, then enter the same port number in both boxes.

Destination Port Range: Enter the destination port number range. If you only want to specify one service port, then enter the same port number in both boxes.

Helper: You could also select the application type you would like to apply for automatic input.

Schedule: Allows you select a time for this QoS policy to be applied to. This option allows Admin to easily control the QoS of a particular user using a particular IP by using several Schedule events for the different parts of the day. (Look for Chapter 4.4.9.4 **Schedule** on how to create a new schedule)

Candidate: Clicking on Candidate will present you with a pop-up window of the available Schedule policies set.

Log: Select Enable for this option if you will like to capture the logs for this packet filter policy.

4.4.5.2 URL Filter

URL Filter			
Configuration			
URL Filtering	<input type="radio"/> Enable <input checked="" type="radio"/> Disable		
Keyword Filtering	<input type="checkbox"/> Enable Details ▶		
Domains Filtering	<input type="checkbox"/> Enable Details ▶		
	<input type="checkbox"/> Disable all WEB traffic except for Trusted Domains		
Restrict URL Features	<input type="checkbox"/> Block Java Applet		
	<input type="checkbox"/> Block ActiveX		
	<input type="checkbox"/> Block Web proxy		
	<input type="checkbox"/> Block Cookie		
	<input type="checkbox"/> Block Surfing by IP Address		
Log	<input type="checkbox"/> Enable		
<input type="button" value="Apply"/>			
Exception List			
Name	IP Address		
Create ▶			

The URL Filter is a powerful tool that can be used to limit access to certain URLs on the Internet. You can block web sites based on keywords or even block out an entire domain. Certain web features can also be blocked to grant added security to your network.

URL Filtering: You can choose to Enable or Disable this feature.

Keyword Filtering: Click the checkbox to enable this feature. To edit the list of filtered keywords, click Details.

Domain Filtering: Click the "enable" checkbox to enable filtering by Domain Name. Click the "Disable all WEB traffic except for trusted domains" check box to allow web access only for trusted domains.

Restrict URL Features: Click "Block Java Applet" to filter web access with Java Applet components. Click "Block ActiveX" to filter web access with ActiveX components. Click "Block Web proxy" to filter web proxy access. Click "Block Cookie" to filter web access with Cookie components. Click "Block Surfing by IP Address" to filter web access with an IP address as the domain name.

Log: Select Enable for this option if you will like to capture the logs for this URL filter policy.

Exception List: You can input a list of IP addresses as the exception list for URL filtering.

Keywords Filtering	
Create	
Keyword	<input type="text"/>
<input type="button" value="Apply"/>	
Block WEB URLs which contain these keywords	
No.	Keyword

Enter a keyword to be filtered and click **Apply**. Your new keyword will be added to the filtered keyword listing.

Domains Filtering: Click the top checkbox to enable this feature. You can also choose to disable all web traffic except for trusted sites by clicking the bottom checkbox. To edit the list of filtered domains, click Details.

Domains Filtering

Create

Domain Name	<input type="text"/>
Type	Forbidden Domain ▾
<input type="button" value="Apply"/>	

Trusted Domain Table

No.	Domain	
-----	--------	--

Forbidden Domain Table

No.	Domain	
-----	--------	--

Enter a domain and select whether this domain is trusted or forbidden with the pull-down menu. Next, click **Apply**. Your new domain will be added to either the Trusted Domain or Forbidden Domain listing, depending on which you selected previously.

You may also designate which IP addresses are to be excluded from these filters by adding them to the **Exception List**. To do so, click **Add**.

Exception

Create

Name	<input type="text"/>
IP Address Candidates ▶	<input type="text" value="0"/> . <input type="text" value="0"/> . <input type="text" value="0"/> . <input type="text" value="0"/>
<input type="button" value="Apply"/>	

Enter a name for the IP Address and then enter the IP address itself. Click **Apply** to save your changes. The IP address will be entered into the Exception List, and excluded from the URL filtering rules in effect.

4.4.5.3 Ethernet MAC Filter

Ethernet MAC Filter					
Default Rule					
Action	<input checked="" type="radio"/> Forward <input type="radio"/> Drop				
<input type="button" value="Apply"/>					
Rule Lists					
No.	Enable	Action	MAC Address		
<input type="button" value="Create"/>					

Ethernet Mac Filter can decide if BiGuard will filter those devices at LAN side by MAC Address and determine if they can connect to the internet or not.

Default Rule: Forward or Drop all LAN request. (Forward by default)

Create: You can also input a specified MAC Address to be dropped or Forward without depending on the default rule.

Ethernet MAC Filter	
Create Rule	
Rule	<input checked="" type="radio"/> Enable <input type="radio"/> Disable
Action When Matched	Drop
Mac Address Candidates	<input type="text"/>
Log	<input type="radio"/> Enable <input checked="" type="radio"/> Disable
<input type="button" value="Apply"/>	

Rule: Enable or disable this entry.

Action When Matched: Select to **Drop** or **Forward** the packet specified in this filter entry.

MAC Address: The MAC Address you would like to apply.

Candidates: You can also select the **Candidates** which are referred from the ARP table for automatic input.

4.4.5.4 Wireless MAC Filter

Prevents unauthorized computers access from using the Internet through the router. Wireless MAC Filter can

Wireless MAC Filter

Default Rule

Action Forward Drop

[Apply](#)

Rule Lists

No.	Enable	Action	MAC Address		
-----	--------	--------	-------------	--	--

[Create](#)

Default Rule: Forward or Drop all wireless request. (Forward by default)

Click on **Create** to create a new rule. You can input a specified MAC Address to be dropped or Forward. This new rule will be prioritized before the Default Rule.

Wireless MAC Filter

Create Rule

Rule Enable Disable

Action When Matched

Mac Address [Candidates](#)

Log Enable Disable

[Apply](#)

Rule: Enable or disable this entry.

Action When Matched: Select to **Drop** or **Forward** the packet specified in this filter entry.

MAC Address: The MAC Address you would like to apply.

Candidates: You can also select the **Candidates** which are referred from the ARP table for a selection of MAC addresses that you can click and choose.

Log: Enable or disable log capture for this entry.

4.4.5.5 Block WAN Request

Block WAN Request	
Enable for preventing any ping test from Internet, such as hacker attack.	
Block WAN Request	<input checked="" type="radio"/> Enable <input type="radio"/> Disable
<input type="button" value="Apply"/>	

Blocking WAN requests is one way to prevent DDOS attacks by preventing ping requests from the Internet. Use this menu to enable or disable function.

4.4.5.6 Intrusion Detection

Intrusion Detection	
Enable for preventing hacker attack from Internet.	
Intrusion Detection	<input type="radio"/> Enable <input checked="" type="radio"/> Disable
Intrusion Log	<input type="radio"/> Enable <input checked="" type="radio"/> Disable
ARP Protection	<input checked="" type="radio"/> Disable <input type="radio"/> Enable
Session Limit	<input checked="" type="radio"/> No Limit <input type="radio"/> Limit maximum sessions per IP to <input type="text" value="200"/> <input type="radio"/> Limit maximum sessions per IP to <input type="text" value="200"/> <input checked="" type="radio"/> , reject new session from this IP in <input type="text" value="5"/> minutes. <input type="radio"/> , drop all packets from this IP in <input type="text" value="5"/> minutes.
<input type="button" value="Apply"/>	

Intrusion Detection can prevent most common DoS attacks from the Internet or from LAN users.

Intrusion Detection: Enable or disable this function.

Intrusion Log: All the detected and dropped attacks will be shown in the system log.

ARP Protection: ARP protection is used to protect users on the LAN against ARP virus. When enabled, ARP Protection will only protect computers that were set in **Fixed Host** so that the ARP table of the hosts can be updated. Periodically BiGuard30 will send ARP packets to these computers to refresh their ARP tables. Enabling ARP Protection can prevent potential viruses infecting computers within the local network. Enabling this option will mitigate the effect of ARP virus attack on LAN.

Session Limit: Allows administrators to self-define the amount of sessions that currently allowed to connect to BiGuard30. This function limits the number of

connections on per-user basis. This is useful when controlling users who will use the applications which create a large number of connections (such as P2P software).

No Limit: No restrictions on the amount of sessions allowed to connect to BiGuard30.

Limit Maximum sessions per IP to: Restricts an upper limit of sessions allowed to connect to BiGuard30, additional sessions beyond the maximum limit will not be allowed to connect.

Limit Maximum sessions per IP to (with reject and drop options): Just like the previous option, this option expands on what to do with additional sessions above the maximum limit. You can either reject the additional sessions for a period of time or just drop all packets from those sessions for a period of time.

4.4.6 VPN

VPN is a way to establish secured communication tunnels to an organization's network via the Internet.

You can find two items under the VPN section: **IPSec** and **PPTP**.

Configuration
LAN
WAN
Dual WAN
System
Firewall
VPN
IPSec
PPTP

4.4.6.1 IPSec

IPSec is a set of protocols that enable Virtual Private Networks (VPN).

You can find two items under the IPSec section: **IPSec Wizard** and **IPSec Policy**.

VPN
IPSec
IPSec Wizard
IPSec Policy
PPTP

4.4.6.1.1 IPSec Wizard

IPSec Wizard	
Step 1 of 3: Connection Information	
Connection Name	<input type="text"/>
Interface	<input checked="" type="radio"/> WAN1 <input type="radio"/> WAN2 <input type="radio"/> Auto
PreShared Key	<input type="text"/>
Connection Type	<input checked="" type="radio"/> LAN to LAN
	<input type="radio"/> LAN to LAN (Mobile LAN)
	<input type="radio"/> LAN to Host
	<input type="radio"/> LAN to Host (Mobile Client)
	<input type="radio"/> LAN to Host (For BiGuard VPN Client)
<input type="button" value="Next"/>	

Connection Name: A user-defined name for the connection.

Interface: Select the interface the IPSec tunnel will apply to.

WAN1: Select interface WAN1

WAN2: Select interface WAN2

Auto: The device will automatically apply the tunnel to WAN1 or WAN2 depending on which WAN interface is active when the IPSec tunnel is being established. Note. Auto only applies to Fail Over mode. For Load Balance mode, please do not select "Auto". In Load Balance mode, Auto will be forced to WAN1 interface if Auto is selected.

Pre-shared Key: This is for the Internet Key Exchange (IKE) protocol. IKE is used to establish a shared security policy and authenticated keys for services (such as IPSec) that require a key. Before any IPSec traffic can be passed, each router must be able to verify the identity of its peer. This can be done by manually entering the

pre-shared key into both sides (router or hosts).

Connection Type:

There are 5 connection types:

(1) LAN to LAN: BiGuard would like to establish an IPSec VPN tunnel with remote router using Fixed Internet IP or domain name by using main mode.

IPSec Wizard				
Step 2 of 3: Remote Information				
Remote Secure Gateway Address (or Hostname)		<input type="text"/>		
Remote Network	IP Address	<input type="text" value="0"/>	<input type="text" value="0"/>	<input type="text" value="0"/>
	Netmask	<input type="text" value="0"/>	<input type="text" value="0"/>	<input type="text" value="0"/>
<input type="button" value="Back"/>		<input type="button" value="Next"/>		

Secure Gateway Address (or Domain Name): The IP address or hostname of the remote VPN gateway.

Remote Network: The subnet of the remote network. Allows you to enter an IP address and netmask.

Back: Back to the Previous page.

Next: Go to the next page.

(2) LAN to Mobile LAN: BiGuard would like to establish an IPSec VPN tunnel with remote router using Dynamic Internet IP by using aggressive mode.

IPSec Wizard				
Step 2 of 3: Remote Information				
Remote Identifier		<input type="text"/>		
Remote Network	IP Address	<input type="text" value="0"/>	<input type="text" value="0"/>	<input type="text" value="0"/>
	Netmask	<input type="text" value="0"/>	<input type="text" value="0"/>	<input type="text" value="0"/>
<input type="button" value="Back"/>		<input type="button" value="Next"/>		

Remote Identifier: The Identifier of the remote gateway. According to the input value, the ID type will be auto-defined as IP Address, FQDN(DNS) or FQUN(E-mail).

Remote Network: The subnet of the remote network. Allows you to enter an IP address and netmask.

Back: Back to the Previous page.

Next: Go to the next page.

(3) LAN to Host: BiGuard would like to establish an IPSec VPN tunnel with remote client software using Fixed Internet IP or domain name by using main mode.

Status	IPSec Wizard Step 2 of 3: Remote Information Remote Secure Gateway Address (or Hostname) <input type="text"/> <input type="button" value="Back"/> <input type="button" value="Next"/>
Quick Start	
Configuration	
LAN	
WAN	
Dual WAN	
System	
Firewall	
VPN	
IPSec	
IPSec Wizard	
IPSec Policy	
PPTP	
QoS	
Virtual Server	
Advanced	
Save Config to Flash	

Secure Gateway Address (or Domain Name): The IP address or hostname of the remote VPN device that is connected and establishes a VPN tunnel.

Back: Back to the Previous page.

Next: Go to the next page.

(4) LAN to Mobile Host: BiGuard would like to establish an IPSec VPN tunnel with remote client software using Dynamic Internet IP by using aggressive mode.

Status	IPSec Wizard Step 2 of 3: Remote Information Remote Identifier <input type="text"/> <input type="button" value="Back"/> <input type="button" value="Next"/>
Quick Start	
Configuration	
LAN	
WAN	
Dual WAN	
System	
Firewall	
VPN	
IPSec	
IPSec Wizard	
IPSec Policy	
PPTP	
QoS	
Virtual Server	
Advanced	
Save Config to Flash	

Remote Identifier: The Identifier of the remote gateway. According to the input value, the ID type will be auto-defined as IP Address, FQDN(DNS) or FQUN(E-mail).

Back: Back to the Previous page.

Next: Go to the next page.

(5)LAN to Host (for BiGuard VPN Client only): BiGuard would like to establish an IPSec VPN tunnel with BiGuard VPN Client software C01 by using aggressive mode.

Status	IPSec Wizard
Quick Start	Step 2 of 3: Remote Information
Configuration	VPN Client IP Address <input type="text" value="192"/> <input type="text" value="168"/> <input type="text" value="100"/> <input type="text" value="1"/>
LAN	 1. Please note that this field must be consistent with the setting of VPN Client. 2. Be sure that each client must use different VPN Client IP Address.
WAN	<input type="button" value="Back"/> <input type="button" value="Next"/>
Dual WAN	
System	
Firewall	
VPN	
IPSec	
IPSec Wizard	
IPSec Policy	
PPTP	
QoS	
Virtual Server	
Advanced	
Save Config to Flash	

VPN Client IP Address: The VPN Client Address for BiGuard VPN Client, this value will be applied on both **remote ID** and **Remote Network** as single address.

Back: Back to the Previous page.

Next: Go to the next page.

		IPSec Wizard			
		Configuration Summary			
Status	Connection Name		1		
Quick Start	Tunnel		Enabled		
Configuration	Interface		WAN1		
LAN	Local	ID	WAN IP Address	Type	IP Address
WAN		Network	192.168.1.254/255.255.255.0	Type	Subnet
Dual WAN	Remote	Secure Gateway	ANY	Type	Dynamic IP
System		ID	100.100.100.1	Type	IP Address
Firewall	Proposal	Network	Remote Secure Gateway IP Address	Type	Remote Secure Gateway
VPN		Secure Association	Aggressive Mode		
IPSec		Method	ESP		
IPSec Wizard		Encryption Protocol	3DES		
IPSec Policy		Authentication Protocol	MD5		
PPTP		Perfect Forward Secure	Enabled		
QoS		Key Group	Group 2		
Virtual Server		PreShared Key	1		
Advanced		IKE Life Time	3600 seconds		
Save Config to Flash		Key Life Time	28800 seconds		
		<input type="button" value="Back"/> <input type="button" value="Done"/>			

After your configuration is done, you will see a **Configuration Summary**.

Back: Back to the Previous page.

Done: Click **Done** to apply the rule.

4.4.6.1.2 IPSec Policy

		IPSec					
		IPSec Tunnels					
Status	Name	Enable	Local Network	Remote Network	Remote Gateway	IPSec Proposal	
Quick Start	<input type="button" value="Create"/>						
Configuration							
LAN							
WAN							
Dual WAN							
System							
Firewall							
VPN							
IPSec							
IPSec Wizard							
IPSec Policy							
PPTP							
QoS							
Virtual Server							
Advanced							
Save Config to Flash							

Click **Create** to create a new IPSec VPN connection account.

Configuring a New VPN Connection

IPSec			
Create			
Connection Name	<input type="text"/>		
Tunnel	<input checked="" type="radio"/> Enabled <input type="radio"/> Disabled		
Interface	<input checked="" type="radio"/> WAN1 <input type="radio"/> WAN2 <input type="radio"/> Auto		
Local			
ID	IP Address <input type="text"/>	Data	<input type="text"/>
Network	Any Local Address <input type="text"/>	IP Address	<input type="text"/> . <input type="text"/> . <input type="text"/> . <input type="text"/>
		End IP Address	<input type="text"/> . <input type="text"/> . <input type="text"/> . <input type="text"/>
		Netmask	<input type="text"/> . <input type="text"/> . <input type="text"/> . <input type="text"/>
Remote			
Secure Gateway	IP Address/ Hostname <input type="text"/>	Data	<input type="text"/>
ID	IP Address <input type="text"/>	Data	<input type="text"/>
Network	Subnet <input type="text"/>	IP Address	<input type="text"/> . <input type="text"/> . <input type="text"/> . <input type="text"/>
		End IP Address	<input type="text"/> . <input type="text"/> . <input type="text"/> . <input type="text"/>
		Netmask	<input type="text"/> . <input type="text"/> . <input type="text"/> . <input type="text"/>
Proposal			
Secure Association	<input checked="" type="radio"/> Main Mode <input type="radio"/> Aggressive Mode <input type="radio"/> Manual Key		
Method	<input checked="" type="radio"/> ESP <input type="radio"/> AH		
Encryption Protocol	3DES <input type="text"/>		
Authentication Protocol	MD5 <input type="text"/>		
Perfect Forward Secure	<input checked="" type="radio"/> Enabled <input type="radio"/> Disabled		
PreShared Key	<input type="text"/>		
IKE Life Time	<input type="text"/> 28800	Seconds	
Key Life Time	<input type="text"/> 3600	Seconds	
Netbios Broadcast	<input type="radio"/> Enabled <input checked="" type="radio"/> Disabled		
DPD Setting			
DPD Function	<input type="radio"/> Enabled <input checked="" type="radio"/> Disabled		
Detection Interval	<input type="text"/> 30	seconds	
Idle Timeout	<input type="text"/> 4	consecutive times	
<input type="button" value="Apply"/>			

Connection Name: A user-defined name for the connection.

Tunnel: Select **Enable** to activate this tunnel. Select **Disable** to deactivate this tunnel.

Interface: Select the interface the IPSec tunnel will apply to.

WAN1: Select interface WAN1

WAN2: Select interface WAN2

Auto: The device will automatically apply the tunnel to WAN1 or WAN2 depending on which WAN interface is active when the IPSec tunnel is being established. Note. Auto only applies to Fail Over mode. For Load Balance mode, please do not select "Auto". In Load Balance mode, Auto will be forced to WAN1

interface if Auto is selected.

Local: This section configures the local host.

ID: This is the identity type of the local router or host. Choose from the following four options:

WAN IP Address: Automatically use the current WAN Address as ID.

IP Address: Use an IP address format.

FQDN DNS(Fully Qualified Domain Name): Consists of a hostname and domain name. For example, WWW.VPN.COM is a FQDN. WWW is the host name, VPN.COM is the domain name. When you enter the FQDN of the local host, the router will automatically seek the IP address of the FQDN.

FQUN E-Mail(Fully Qualified User Name): Consists of a username and its domain name. For example, user@vpn.com is a FQUN. "user" is the username and "vpn.com" is the domain name.

Data: Enter the ID data using the specific ID type.

Network: Set the IP address, IP range, subnet, or address range of the local network.

Any Local Address: Will enable any local address on the network.

Subnet: The subnet of the local network. Selecting this option enables you to enter an IP address and netmask.

IP Range: The IP Range of the local network.

Single Address: The IP address of the local host.

Remote: This section configures the remote host.

Secure Gateway Address (or Domain Name): The IP address or hostname of the remote VPN device that is connected and establishes a VPN tunnel.

ID: The identity type of the local host. Choose from the following three options:

Remote IP Address: Automatically use the remote gateway Address as ID with ID type – IP Address.

IP Address: Use an IP address format.

FQDN DNS(Fully Qualified Domain Name): Consists of a hostname and domain name. For example, WWW.VPN.COM is a FQDN. WWW is the host name, VPN.COM is the domain name. When you enter the FQDN of the local host, the router will automatically seek the IP address of the FQDN.

FQUN E-Mail(Fully Qualified User Name): Consists of a username and its domain name. For example, user@vpn.com is a FQUN. "user" is the username and "vpn.com" is the domain name.

Data: Enter the ID data using the specific ID type.

Network: Set the subnet, IP Range, single address, or gateway address of the remote network.

Any Local Address: Will enable any local address on the network.

Subnet: The subnet of the remote network. Selecting this option allows you to enter an IP address and netmask.

IP Range: The IP Range of the remote network.

Single Address: The IP address of the remote host.

Gateway Address: The gateway address of the remote host.

Proposal:

Secure Association (SA): SA is a method of establishing a security policy between two points. There are three methods of creating SA, each varying in degrees of security and speed of negotiation:

Main Mode: Uses the automated Internet Key Exchange (IKE) setup; most secure method with the highest level of security.

Aggressive Mode: Uses the automated Internet Key Exchange (IKE) setup; mid-level security. Speed is faster than Main mode.

Manual Key: Standard level of security. It is the fastest of the three methods.

Method: There are two methods of checking the authentication information, AH (Authentication Header) and ESP (Encapsulating Security Payload). Use ESP for greater security so that data will be encrypted and authenticated. AH data will be authenticated but not encrypted.

Encryption Protocol: Select the encryption method from the pull-down menu. There are several options: DES, 3DES, and AES (128, 192 and 256). 3DES and AES are more powerful but increase latency.

DES: Stands for Data Encryption Standard. It uses a 56-bit encryption method.

3DES: Stands for Triple Data Encryption Standard. It uses a 168-bit encryption method.

AES: Stands for Advanced Encryption Standard. You can use 128, 192 or 256 bits as encryption method.

Authentication Protocol: Authentication establishes data integrity and ensures it is not tampered with while in transit. There are two options: Message Digest 5 (MD5), and Secure Hash Algorithm (SHA1). While slower, SHA1 is more resistant to brute-force attacks than MD5.

MD5: A one-way hashing algorithm that produces a 128-bit hash.

SHA1: A one-way hashing algorithm that produces a 160-bit hash.

Perfect Forward Secure: Choose whether to enable PFS using Diffie-Hellman public-key cryptography to change encryption keys during the second phase of VPN negotiation. This function will provide better security, but extends the VPN

negotiation time. Diffie-Hellman is a public-key cryptography protocol that allows two parties to establish a shared secret over the Internet.

Pre-shared Key: This is for the Internet Key Exchange (IKE) protocol. IKE is used to establish a shared security policy and authenticated keys for services (such as IPSec) that require a key. Before any IPSec traffic can be passed, each router must be able to verify the identity of its peer. This can be done by manually entering the pre-shared key into both sides (router or hosts).

IKE Life Time: Allows you to specify the timer interval for renegotiation of the IKE security association. The value is in seconds, eg. 28800 seconds = 8 hours.

Key Life Time: Allows you to specify the timer interval for renegotiation of another key. The value is in seconds eg. 3600 seconds = 1 hour.

Netbios Broadcast: Allows BiGuard to send local Netbios Broadcast packet through the IPSec Tunnel, please select **Enable** or **Disable**.

DPD Setting: DPD, Dead Peer Detection.

DPD Function: Select Enable or Disable DPD function.

Detection Interval: please input the interval time to send out DPD packet.

Idle Timeout: Please input the consecutive no response time to disconnect this tunnel.

Click the **Apply** button to save your changes.

After you have created the IPSec connection, the account information will be displayed.

IPSec	
Status	
Quick Start	
Configuration	
LAN	
WAN	
Dual WAN	
System	
Firewall	
VPN	
IPSec	
IPSec Wizard	
IPSec Policy	
PPTP	
QoS	
Virtual Server	
Advanced	
Save Config to Flash	

IPSec Tunnels							
Name	Enable	Local Network	Remote Network	Remote Gateway	IPSec Proposal		
Tunnel1	✓	Any	192.168.2.0/24	2.2.2.2	MAIN Mode ESP [3DES: MD5]	Edit ▶	Delete ▶
Create ▶							

Name: This is the user-defined name of the connection.

Enable: This function activates or deactivates the IPSec connection.

Local Subnet: Displays IP address and subnet of the local network.

Remote Subnet: Displays IP address and subnet of the remote network.

Remote Gateway: This is the IP address or Domain Name of the remote VPN device that is connected and has an established IPSec tunnel.

IPSec Proposal: This is the selected IPSec security method.

4.4.6.2 PPTP

PPTP is a set of protocols that enable Virtual Private Networks (VPN). VPN is a way to establish secured communication tunnels to an organization's network via the Internet.

Status	PPTP			
Quick Start	General Setting			
Configuration	PPTP function	<input type="radio"/> Enable <input checked="" type="radio"/> Disable		
LAN	Auth. Type	Pap or Chap		
WAN	Data Encryption	Enable		
Dual WAN	Encryption Key Length	Auto		
System	Peer Encryption Mode	Only Stateless		
Firewall	IP Addresses Assigned to Peer	Start from: 192.168.1.200		
VPN	Idle Timeout	0 Min.		
IPSec	<small>(! Enable data encryption will use MS-CHAPv2 to authenticate the peer.)</small>			
PPTP	<input type="button" value="Apply"/>			
QoS	Account Setting			
Virtual Server	Name	Enable	Type	Peer Network
Advanced	<input type="button" value="Create"/>			
Save Config to Flash				

PPTP function: Select **Enable** to activate PPTP Server. **Disable** to deactivate PPTP Server function.

Auth. Type: The authentication type, **Pap or Chap, PaP, Chap**.

Data Encryption: Select **Enable** or **Disable** the Data Encryption.

Encryption Key Length: **Auto, 40 bits** or **128 bits**.

Peer Encryption Mode: **Only Stateless** or **Allow Stateless and Stateful**.

IP Addresses Assigned to Peer Start from: 192.168.1.x: please input the IP assigned range from **1 ~ 254** (except BiGuard 50G's LAN IP address with **192.168.1.254** as BiGuard 50G's default LAN IP address and IP pool range of DHCP server settings with **100~199** as BiGuard 50G's default DHCP IP pool range.)

Idle Timeout " " Min: Specify the time for remote peer to be disconnected without any activities, from **0~120**.

Click **Create** to create a new PPTP VPN connection account.

Status	PPTP
Quick Start	Add PPTP Account
Configuration	Connection Name <input type="text"/>
LAN	Tunnel <input checked="" type="radio"/> Enable <input type="radio"/> Disable
WAN	Username <input type="text"/>
Dual WAN	Password <input type="text"/>
System	Retype Password <input type="text"/>
Firewall	Connection Type <input checked="" type="radio"/> Remote Access <input type="radio"/> LAN to LAN
VPN	Peer Network IP <input type="text"/> . <input type="text"/> . <input type="text"/> . <input type="text"/>
IPSec	Peer Netmask <input type="text"/> . <input type="text"/> . <input type="text"/> . <input type="text"/>
PPTP	Netbios Broadcast <input type="radio"/> Enable <input checked="" type="radio"/> Disable
QoS	<input type="button" value="Apply"/>
Virtual Server	
Advanced	
Save Config to Flash	

Connection Name: A user-defined name for the connection.

Tunnel: Select **Enable** to activate this tunnel. Select **Disable** to deactivate this tunnel.

Username: Please input the username for this account.

Password: Please input the password for this account.

Retype Password: Please repeat the same password as previous field.

Connection Type: Select **Remote Access** for single user, Select **LAN to LAN** for remote gateway.

Peer Network IP: Please input the IP for remote network.

Peer Netmask: Please input the Netmask for remote network.

Netbios Broadcast: Allows BiGuard to send local Netbios Broadcast packets through the PPTP Tunnel, please select **Enable** or **Disable**.

4.4.7 QoS

BiGuard 50G can optimize your bandwidth by assigning priority to both inbound and outbound data with QoS. This menu allows you to configure QoS for both inbound and outbound traffic.

Status	Quality of Service		
Quick Start	WAN 1 Outbound		
Configuration	QoS function	<input type="radio"/> Enable <input checked="" type="radio"/> Disable	Rule Table ▶
LAN	Max ISP Bandwidth	0 kbps	Bandwidth Settings ▶
WAN	WAN 1 Inbound		
Dual WAN	QoS function	<input type="radio"/> Enable <input checked="" type="radio"/> Disable	Rule Table ▶
System	Max ISP Bandwidth	0 kbps	Bandwidth Settings ▶
Firewall	WAN 2 Outbound		
VPN	QoS function	<input type="radio"/> Enable <input checked="" type="radio"/> Disable	Rule Table ▶
QoS	Max ISP Bandwidth	0 kbps	Bandwidth Settings ▶
Virtual Server	WAN 2 Inbound		
Advanced	QoS function	<input type="radio"/> Enable <input checked="" type="radio"/> Disable	Rule Table ▶
Save Config to Flash	Max ISP Bandwidth	0 kbps	Bandwidth Settings ▶
	<input type="button" value="Apply"/>		

The first menu screen gives you an overview of which WAN ports currently have QoS active, and the bandwidth settings for each.

WAN1 Outbound:

QoS Function: QoS status for WAN1 outbound. Select **Enable** to activate QoS for WAN1's outgoing traffic. Select **Disable** to deactivate.

Max ISP Bandwidth: The maximum bandwidth afforded by the ISP for WAN1's outbound traffic.

WAN1 Inbound:

QoS Function: QoS status for WAN1 inbound. Select **Enable** to activate QoS for WAN1's incoming traffic. Select **Disable** to deactivate.

Max ISP Bandwidth: The maximum bandwidth afforded by the ISP for WAN1's inbound traffic.

WAN2 Outbound:

QoS Function: QoS Status for WAN2 outbound. Select **Enable** to activate QoS for WAN2's outgoing traffic. Select **Disable** to deactivate.

Max ISP Bandwidth: The maximum bandwidth afforded by the ISP for WAN2's outbound traffic.

WAN2 Inbound:

QoS Function: QoS Status for WAN2 inbound. Select **Enable** to activate QoS for WAN2's incoming traffic. Select **Disable** to deactivate.

Max ISP Bandwidth: The maximum bandwidth afforded by the ISP for WAN2's inbound traffic.

Creating a New QoS Rule

To get started using QoS, you will need to establish QoS rules. These rules tell BiGuard 50G how to handle both incoming and outgoing traffic. The following example shows you how to configure WAN1 Outbound QoS. Configuring the other traffic types follows the same process.

To make a new rule, click Rule Table. This will bring you to the Rule Table which displays the rules currently in effect.

Quality of Service					
WAN1 Outbound QoS Rule Table (total 0 rules used / maximum 150 rules.)					
Application	Guaranteed	Maximum	Priority		
Non-Assigned Bandwidth		102400 kbps (100%)			
Create					

Next, click **Create** to open the QoS Rule Configuration window.

Quality of Service			
Add QoS Rule			
Interface	WAN1 Outbound		
Application	<input type="text"/>		
Guaranteed	<input type="text" value="1"/>	kbps	
Maximum	<input type="text" value="102400"/>	kbps	
Priority	<input type="text" value="3 (Normal)"/>		
DSCP Marking	<input type="text" value="Gold service(L)"/>		
Address Type	<input checked="" type="radio"/> IP Address <input type="radio"/> MAC Address		
Bandwidth Type	<input checked="" type="radio"/> Shared Bandwidth <input type="radio"/> Bandwidth per Source IP Address		
Source IP Address Range	From <input type="text" value="0.0.0.0"/>	To <input type="text" value="255.255.255.255"/>	
Destination IP Address Range	From <input type="text" value="0.0.0.0"/>	To <input type="text" value="255.255.255.255"/>	
Protocol	<input type="text" value="Any"/>		
Source Port Range Helper	From <input type="text" value="1"/>	To <input type="text" value="65535"/>	
Destination Port Range Helper	From <input type="text" value="1"/>	To <input type="text" value="65535"/>	
DSCP	<input type="text" value="Any"/>		
Schedule Candidates	<input type="text" value="**Always"/>		
<input type="button" value="Apply"/>			

Interface: The current traffic type. This can be WAN1 (outbound, inbound) and WAN2 (outbound, inbound).

Application: User defined application name for the current rule.

Guaranteed: The guaranteed amount of bandwidth for this rule as a percentage.

Maximum: The maximum amount of bandwidth for this rule as a percentage.

Priority: The priority assigned to this service. Select a value from 0 to 6, 0 being highest.

DSCP Marking: Used to classify traffic. Select from **Best Effort**, **Premium**, **Gold Service (High Medium, Low)**, **Silver (H,M,L)**, and **Bronze (H,M,L)**.

Address Type: The type of address this rule applies to. Select **IP Address** or **MAC Address**.

Bandwidth Type:

Shared Bandwidth: Please select **Shared Bandwidth** if you would like the specified bandwidth to be shared for all IP address in specified IP range.

Bandwidth per source IP Address: Please select **Bandwidth per source IP Address** if you would like the specified bandwidth to be applied individually per source IP address in specified IP range.

For IP Address:

Source IP Address Range: The range of source IP Addresses this rule applies to.

Destination IP Address Range: The range of destination IP Addresses this rule applies to.

Source Port Range: The range of source ports this rule applies to.

Destination Port Range: The range of destination ports this rule applies to.

Helper: You could also select the application type you would like to apply for automatic input.

DSCP: DSCP matching is used to identify traffic for the rule. This option will only be applied to the packets whose DSCP field's IP header matches the criteria selected from the drop-down menu.

Schedule: Allows you select a time for this QoS policy to be applied to. This option allows Admin to easily control the QoS of a particular user using a particular IP by using several Schedule events for the different parts of the day. (Look for Chapter 4.4.9.4 **Schedule** on how to create a new schedule)

Candidate: Clicking on Candidate will present you with a pop-up window of the available Schedule policies set.

Click **Apply** to save your changes.

For MAC Address:

Quality of Service	
Add QoS Rule	
Interface	WAN2 Inbound
Application	<input type="text"/>
Guaranteed	<input type="text" value="1"/> kbps
Maximum	<input type="text" value="102400"/> kbps
Priority	<input type="text" value="3 (Normal)"/>
DSCP Marking	
Address Type	<input type="radio"/> IP Address <input checked="" type="radio"/> MAC Address
Source MAC Address Candidates	<input type="text" value="00:00:00:00:00:00"/> (ex. xx:xx:xx:xx:xx:xx)
Protocol	<input type="text" value="Any"/>
Source Port Range Helper	From <input type="text" value="1"/> To <input type="text" value="65535"/>
Destination Port Range Helper	From <input type="text" value="1"/> To <input type="text" value="65535"/>
DSCP	<input type="text" value="Any"/>
Schedule Candidates	<input type="text" value="**Always"/>
<input type="button" value="Apply"/>	

Source MAC Address: The source MAC Address of the device this rule applies to.

Candidates: You can also select the Candidates which are referred from the ARP table for automatic input.

Source Port Range: The range of source ports this rule applies to.

Destination Port Range: The range of destination ports this rule applies to.

Helper: You could also select the application type you would like to apply for automatic input.

4.4.8 Virtual Server

In TCP/IP and UDP networks, a port is a 16-bit number used to identify which application program (usually a server) incoming connections should be delivered to. Some ports have numbers that are pre-assigned to them by the Internet Assigned Numbers Authority (IANA), and these are referred to as "well-known ports". Servers follow the well-known port assignments so clients can locate them.

If you wish to run a server on your network that can be accessed from the WAN (i.e. from other machines on the Internet that are outside your local network), or any application that can accept incoming connections (e.g. peer-to-peer applications) and are using NAT (Network Address Translation), then you will usually need to

configure your router to forward these incoming connection attempts using specific ports to the PC on your network running the application. You will also need to use port forwarding if you want to host an online game server. The reason for this is that when using NAT, your publicly accessible IP address will be used by and point to your router, which then needs to deliver all traffic to the private IP addresses used by your PCs. Please see the **WAN Configuration** section of this manual for more information on NAT.

BiGuard 50G can also be configured as a virtual server so that remote users accessing services such as Web or FTP services via the public (WAN) IP address can be automatically redirected to local servers in the LAN network. Depending on the requested service (TCP/UDP port number), the device redirects the external service request to the appropriate server within the LAN network.

4.4.8.1 DMZ

The DMZ Host is a local computer exposed to the Internet. When setting a particular internal IP address as the DMZ Host, all incoming packets will be checked by the Firewall and NAT algorithms then passed to the DMZ host, when a packet received does not use a port number used by any other Virtual Server entries.

Caution: Such Local computer exposure to the Internet may face a variety of security risks.

Virtual Server (Port Forwarding)

DMZ

Enable DMZ Function	<input type="radio"/> Enable <input checked="" type="radio"/> Disable
DMZ IP Address Candidates	<input type="text" value="0"/> . <input type="text" value="0"/> . <input type="text" value="0"/> . <input type="text" value="0"/>

Port Forwarding Table

Application	Protocol	External IP	External Port	Internal IP	Internal Port		
Create							

Enable DMZ function:

Enable: Activates your router's DMZ function.

Disable: Default setting. Disables the DMZ function.

DMZ IP Address: Give a static IP address to the DMZ Host when the **Enable** radio button is selected. Be aware this IP will be exposed to the WAN/Internet.

Candidates: You can also select the Candidates which are referred from the ARP table for automatic input.

Select the **Apply** button to apply your changes.

4.4.8.2 Port Forwarding Table

Because NAT can act as a "natural" Internet firewall, your router protects your network from being accessed by outside users, as all incoming connection attempts will point to your router unless you specifically create Virtual Server entries to forward those ports to a PC on your network.

When your router needs to allow outside users to access internal servers, e.g. a web server, FTP server, Email server or game server, the router can act as a "virtual server". You can set up a local server with a specific port number for the service to use, e.g. web/HTTP (port 80), FTP (port 21), Telnet (port 23), SMTP (port 25), or POP3 (port 110). When an incoming access request is received, it will be forwarded to the corresponding internal server.

Virtual Server (Port Forwarding)

DMZ

Enable DMZ Function Enable Disable

DMZ IP Address [Candidates](#) ▶ . . .

Port Forwarding Table						
Application	Protocol	External IP	External Port	Internal IP	Internal Port	
Create ▶						

Click **Create** to add a new port forwarding rule.

This function allows any incoming data addressed to a range of service port numbers (from the Internet/WAN Port) to be re-directed to a particular LAN private/internal IP address. This option gives you the ability to handle applications that use more than one port such as games and audio/video conferencing.

Virtual Server				
Add Forwarding Rule				
Application	Helper ▶	<input type="text"/>		
Protocol		Any ▼		
External Port		1	~	65535
Redirect Port		1	~	65535
External IP Address	Candidates ▶	0	.	0
		0	.	0
Internal IP Address	Candidates ▶	0	.	0
		0	.	0

Application: User defined application name for the current rule.

Helper: You could also select the application type you would like to apply for automatic input.

Protocol type: please select protocol type

External Port: Enter the port number of the service that will be sent to the Internal IP address.

Redirect Port: Enter a new port number for the service that will be sent to the Internal IP address.

External IP Address: Please click candidate to select the WAN interface or the WAN IP address.

Internal IP Address: Enter the LAN server/host IP address that the service request from the Internet will be sent to.

Candidates: You can also select the Candidates which are referred from the ARP table for automatic input.

NOTE: You need to give your LAN server/host a static IP address for the Virtual Server to work properly.

Click **Apply** to save your changes.

Using port forwarding does have security implications, as outside users will be able to connect to PCs on your network. For this reason, using specific Virtual Server entries just for the ports your application requires, instead of using DMZ is recommended.

4.4.9 Advanced

Configuration options within the Advanced section are for users who wish to take advantage of the more advanced features of BiGuard 50G. Users who do not understand the features should not attempt to reconfigure their router, unless advised to do so by support staff.

Advanced
Static Route
Dynamic DNS
Device Management
Schedule

There are five items within the Advanced section: **Static Route**, **Dynamic DNS**, and **Device Management**.

4.4.9.1 Static Route

The static route settings enable the router to route IP packets to another network (subnet). The routing table stores the routing information so the router knows where to redirect the IP packets.

Static Route						
Static Route Table						
No.	Enable	Destination	Netmask	Gateway/Interface		
Create ▶						

Click on **Static Route** and then click **Create** to add a routing table.

Static Route						
Create Rule						
Rule	<input type="radio"/> Enable <input checked="" type="radio"/> Disable					
Destination	<input type="text" value="0"/>	<input type="text" value="0"/>	<input type="text" value="0"/>	<input type="text" value="0"/>		
Netmask	<input type="text" value="0"/>	<input type="text" value="0"/>	<input type="text" value="0"/>	<input type="text" value="0"/>		
Gateway	<input type="text" value="0"/>	<input type="text" value="0"/>	<input type="text" value="0"/>	<input type="text" value="0"/>	Interface	<input type="text" value="LAN"/>
Cost	<input type="text" value="0"/>					
<input type="button" value="Apply"/>						

Rule: Select Enable to activate this rule, Disable to deactivate this rule.

Destination: This is the destination subnet IP address.

Netmask: This is the subnet mask of the destination IP addresses based on above destination subnet IP.

Gateway: This is the gateway IP address to which packets are to be forwarded.

Interface: Select the interface through which packets are to be forwarded.

Cost: This is the same meaning as Hop.

Click **Apply** to save your changes.

4.4.9.2 Dynamic DNS

The Dynamic DNS function allows you to alias a dynamic IP address to a static hostname, allowing users whose ISP does not assign them a static IP address to use a domain name. This is especially useful when hosting servers via your WAN connection, so that anyone wishing to connect to you may use your domain name, rather than having to use a dynamic IP address that changes periodically. This dynamic IP address is the WAN1/WAN2 IP address of the router, which is assigned to you by your ISP. Click **Edit** in the Dynamic DNS Settings Table to set related parameters for a specific interface.

Dynamic DNS			
Dynamic DNS Table			
Interface	Enable	Dynamic DNS Server	
WAN1	×	NONE	Edit ▶
WAN2	×	NONE	Edit ▶

You will first need to register and establish an account with the Dynamic DNS provider using their website,

Example: DYNDNS

<http://www.dyndns.org/>

(BiGuard 50G supports several Dynamic DNS providers , such as www.dyndns.org , www.orgdns.org , www.dhs.org, www.dyns.cx, www.3domain.hk, www.dyndns.org , www.3322.org).

Click **Edit** on either WAN1 or WAN2 to edit the Dynamic DNS Server.

After receiving the information, on the **Domain Name**, **Username** and **Password**,

please fill it in the blank space below.

Dynamic DNS Settings	
Parameters	
Dynamic DNS	<input type="radio"/> Enable <input checked="" type="radio"/> Disable
Dynamic DNS Server	NONE
Wildcard	<input type="radio"/> Enable <input checked="" type="radio"/> Disable
Domain Name	<input type="text"/>
Username	<input type="text"/>
Password	<input type="text"/>
<input type="button" value="Apply"/>	

Dynamic DNS:

Disable: Check to disable the Dynamic DNS function.

Enable: Check to enable the Dynamic DNS function. The following fields will be activated and required:

Dynamic DNS Server: Select the DDNS service you have established an account with.

Wildcard: Select this check box to enable the DYNDNS Wildcard.

Domain Name: Enter your registered domain name for this service.

Username: Enter your registered user name for this service.

Password: Enter your registered password for this service.

Click **Apply** to save your changes.

4.4.9.3 Device Management

The Device Management Advanced Configuration settings allow you to control your router's security options and device monitoring features.

Device Management			
Device Name			
Name	<input type="text" value="BiGuard50G"/>		
Web Server Settings			
* HTTP Port	<input type="text" value="80"/>	(80 is default HTTP port)	
Management IP Address	<input type="text" value="0"/>	<input type="text" value="0"/>	<input type="text" value="0"/>
	<input type="text" value="0"/>	('0.0.0.0' means Any)	
Expire to auto-logout	<input type="text" value="300"/>	seconds	
SNMP Access Control			
SNMP Function	<input type="radio"/> Enable <input checked="" type="radio"/> Disable		
SNMP V1 and V2			
Read Community	<input type="text" value="public"/>	IP Address	<input type="text" value="0.0.0.0"/>
Write Community	<input type="text" value="password"/>	IP Address	<input type="text" value="0.0.0.0"/>
Trap Community	<input type="text"/>	IP Address	<input type="text"/>
SNMP V3			
Username	<input type="text"/>	Password	<input type="text"/>
Access Right	<input checked="" type="radio"/> Read <input type="radio"/> Read/Write		
* : This setting will become effective after you save to flash and restart the router.			
<input type="button" value="Apply"/>			

Device Name

Name: Enter a name for this device.

Web Server Settings

HTTP Port: This is the port number the router's embedded web server (for web-based configuration) will use. The default value is the standard HTTP port, 80. Users may specify an alternative if, for example, they are running a web server on a PC within their LAN.

Management IP Address: You may specify an IP address allowed to logon and access the router's web server. Setting the IP address to 0.0.0.0 will disable IP address restrictions, allowing users to login from any IP address.

Expire to auto-logout: Specify a time frame for the system to auto-logout the user's configuration session.

Example: User A changes HTTP port number to 100, specifies their own IP address of 192.168.1.100 and sets the logout time to be 100 seconds. The router will only allow User A access from the IP address 192.168.1.100 to logon to the Web GUI by typing: `http://192.168.1.254:100` in their web browser. After 100 seconds, the device will automatically logout User A.

SNMP Access Control

SNMP Function: Select **Enable** to activate this function, **Disable** to deactivate this function.

SNMP V1 and V2

Read Community: Input the string for Read community to match your SNMP software.

Write Community: Input the string for Write community to match your SNMP software.

Trap Community: Input the string for Trap community to match your SNMP software.

IP Address: Input the device IP address with SNMP software installed.

SNMP V3

Username: Input the Username for your SNMP software.

Password: Input the Password for your SNMP software.

Access Right: Select Read to allow your SNMP software to read the information. Select Read/Write to allow your SNMP software to read and write the information.

4.4.9.4 Schedule

The Time Schedule helps you to manage your Internet connection. In each time profile, you may schedule specific day(s) i.e. Monday through Sunday to restrict or allowing the usage of the Internet by users or applications (QoS and Packet Filter).

This Time Schedule correlates closely with router's time, since router does not have a real time clock on board; it uses the Simple Network Time Protocol (SNTP) to get the current time from an SNTP server from the Internet. Refer to **Time Zone** for details. You router time should correspond with your local time. If the time is not set correctly, your Time Schedule will not function properly.

Schedule				
Schedule Table				
Name	Day in a week	Time		
**Always	Sun. Mon. Tue. Wed. Thu. Fri. Sat.	From 00:00 To 24:00		

[Create](#) ▶

The Schedule Table lists the Scheduled events you have set. You can only **Edit** or **Delete** new schedules that you have created. **Edit** is very similar to **Create**, except you do not create a new schedule but instead change the settings for the old one.

Click **Create** to create a new schedule.

Schedule	
Create	
Name	<input type="text"/>
Day	<input checked="" type="checkbox"/> Sun. <input checked="" type="checkbox"/> Mon. <input checked="" type="checkbox"/> Tue. <input checked="" type="checkbox"/> Wed. <input checked="" type="checkbox"/> Thu. <input checked="" type="checkbox"/> Fri. <input checked="" type="checkbox"/> Sat.
Start Time	08 : 00
End Time	18 : 00
<input type="button" value="Apply"/> <input type="button" value="Cancel"/>	

Name: A user-define description to identify this time portfolio.

Day: The default is set from Monday through Friday. You may specify the days for the schedule to be applied.

Start Time: The default is set at 8:00 AM. You may specify the start time of the schedule.

End Time: The default is set at 18:00 (6:00PM). You may specify the end time of the schedule. Select the **Apply** button to apply your changes.

5. Log & Email Alert

Log & Email Alert allows you to configure the router to determine what events should be logged or not. You can also set it so that you can receive an Email Alert periodically so you can monitor the status of your router even when away from office or work.

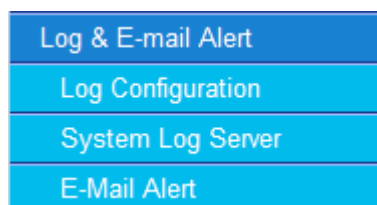

There are three items within the Log & E-mail Alert section: **Log Configuration**, **System Log Server**, and **E-Mail Alert**.

5.1 Log Configuration

The BiGuard 50G incorporates industry-standard alert protocols for capturing network activity information. The information can then be written to a log, sent to an external server, or to a selected E-mail address.

Log Configuration

Parameters			
Categories	System Log	Syslog Server ▶	E-mail Alert ▶
System Maintenance	<input type="checkbox"/>	<input type="checkbox"/>	<input type="checkbox"/>
System Errors	<input type="checkbox"/>	<input type="checkbox"/>	<input type="checkbox"/>
Access Control	<input type="checkbox"/>	<input type="checkbox"/>	<input type="checkbox"/>
Packet Filter	<input type="checkbox"/>	<input type="checkbox"/>	<input type="checkbox"/>
LAN MAC Filter	<input type="checkbox"/>	<input type="checkbox"/>	<input type="checkbox"/>
URL Filter	<input type="checkbox"/>	<input type="checkbox"/>	<input type="checkbox"/>
Intrusion Detection	<input type="checkbox"/>	<input type="checkbox"/>	<input type="checkbox"/>
Call Data Record	<input type="checkbox"/>	<input type="checkbox"/>	<input type="checkbox"/>
PPP	<input type="checkbox"/>	<input type="checkbox"/>	<input type="checkbox"/>
Remote Access	<input type="checkbox"/>	<input type="checkbox"/>	<input type="checkbox"/>
IPSEC	<input type="checkbox"/>	<input type="checkbox"/>	<input type="checkbox"/>

Select **System Log** to capture to a log.

Select **Syslog Server** to capture and send to a specified external server.

Select **Email Alert** to send information log to a pre-specified E-mail account.

5.2 System Log Server

System Log Server	
Parameters	
Send Log To Remote Server	<input type="radio"/> Enable <input checked="" type="radio"/> Disable
Log Server IP Address	192 . 168 . 1 . 1

This function allows BiGuard 50G to send system logs to an external Syslog Server. Syslog is an industry-standard protocol used to capture information about network activity. To enable this function, select the **Enable** radio button and enter your Syslog server IP address in the **Log Server IP Address** field. Click **Apply** to save your changes.

To disable this feature, simply select the **Disable** radio button and click **Apply**.

E-Mail Alert	
Parameters	
E-Mail Alert	<input type="radio"/> Enable <input checked="" type="radio"/> Disable
Recipient's E-Mail Address	<input type="text"/>
Sender's E-Mail Address	<input type="text"/>
SMTP Mail Server	<input type="text"/>
Mail Server Login	<input type="radio"/> Enable <input checked="" type="radio"/> Disable
Username	<input type="text"/>
Password	<input type="password"/>
Alert via E-Mail when	<input type="radio"/> Immediately
	<input type="radio"/> Hourly
	<input type="radio"/> Daily <input type="text" value="12:00"/> <input checked="" type="radio"/> A.M. <input type="radio"/> P.M.
	<input type="radio"/> Weekly <input type="text" value="Sunday"/>
	<input checked="" type="radio"/> When log is full
<input type="button" value="Apply"/>	

The Email Alert function allows a log of security-related events (such as System Log and IPsec Log) to be sent to a specified email address.

Email Alert: You may enable or disable this function by selecting the appropriate radio button.

Recipient's Email Address: Enter the email address where you wish the alert logs to be sent.

SMTP Mail Server: Enter your email account's outgoing mail server. It may be an IP address or a domain name.

Sender's Email Address: Enter the email address where you wish the alert logs to be sent by which address.

Mail Server Login: some SMTP servers may request users to login before serving. Select **Enable** to activate SMTP server login function, **disable** to deactivate.

Username: Input the SMTP server's username.

Password: Input the SMTP server's password.

Alert via Email when: Select the frequency of each email update. Choose one of the five options:

Immediately: The router will send an alert immediately.

Hourly: The router will send an alert once every hour.

Daily: The router will send an alert once a day. The exact time can be specified using the pull down menu.

Weekly: The router will send an alert once a week.

When log is full: The router will send an alert only when the log is full.

6 Language

Language provides 3 different type of language to be displayed on the interface (currently supporting English, Simplified Chinese and Traditional Chinese).

Note: If you accidentally mistakenly clicked on the Chinese language, don't panic. Just locate where "language" link should be and click on the 1st item under Language which will always be English.

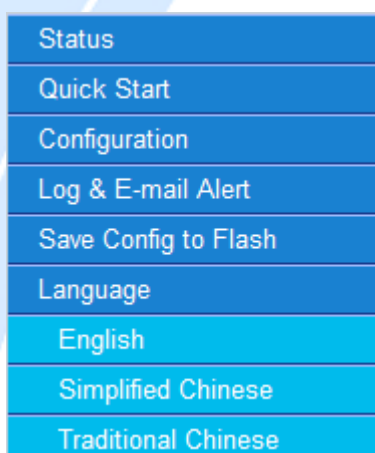

There are three items within the Language section: **English**, **Simplified Chinese**, and **Traditional Chinese**.

6.1 English

Clicking on the English link will change all the text into English.

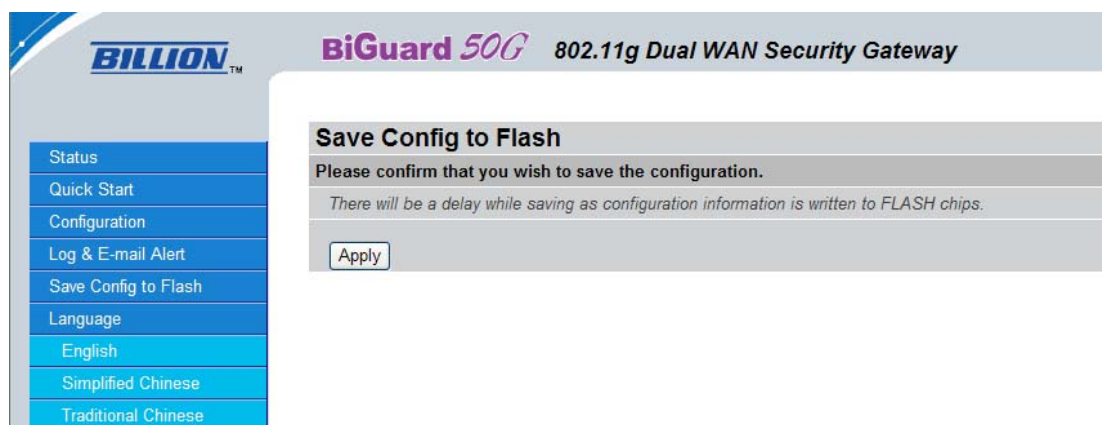

6.2 Simplified Chinese

Clicking on the Simplified Chinese link will change all the text into Simplified Chinese.



6.3 Traditional Chinese

Clicking on the Traditional Chinese link will change all the text into Traditional Chinese.



7 Save Configuration To Flash

After changing the router's configuration settings, you must save all of the configuration parameters to flash memory to avoid them being lost after turning off or resetting your router. Click **Apply** to write your new configuration to flash memory.

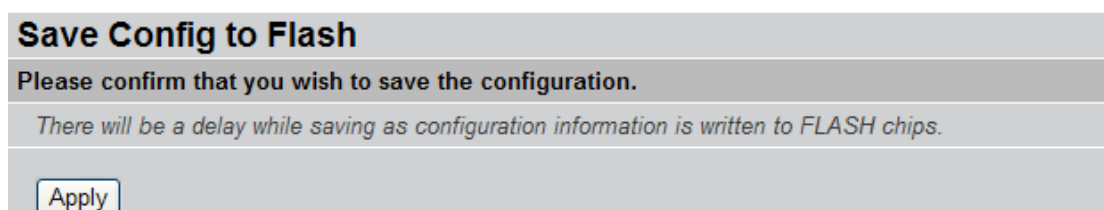

8 Logout

To exit the router's web interface, click **Logout**. Please ensure that you have saved your configuration settings before you logout.



Be aware that the router is restricted to only one PC accessing the web configuration interface at a time. Once a PC has logged into the web interface, other PCs cannot gain access until the current PC has logged out. If the previous PC forgets to logout, the second PC can access the page after a user-defined period (5 minutes by default). You can modify this value using the **Advanced > Device Management** section of the Web Configuration Interface. Please see the **Advanced** section of this manual for more information.

Chapter 5: Troubleshooting

5.1 Basic Functionality

This section deals with issues regarding your BiGuard 50G's basic functions.

5.1.1 Router Won't Turn On

If the Power and other LEDs fail to light when your BiGuard 50G is turned on:

- Make sure that the power cord is properly connected to your firewall and that the power supply adapter is properly connected to a functioning power outlet.
- Check that you are using the 12VDC power adapter supplied by Billion for this product.

If the error persists, you may have a hardware problem, and should contact technical support.

5.1.2 LEDs Never Turn Off

When your BiGuard 50G is turned on, the LEDs turn on for about 10 seconds and then turn off. If all the LEDs stay on, there may be a hardware problem.

If all LEDs are still on one minute after powering up:

- Cycle the power to see if the router recovers.
- Clear the configuration to factory defaults.

If the error persists, you may have a hardware problem, and should contact technical support.

5.1.3 LAN or Internet Port Not On

If either the LAN LEDs or Internet LED do not light when the Ethernet connection is made, check the following:

- Make sure each Ethernet cable connection is secure at the firewall and at the hub

or workstation.

- Make sure that power is turned on to the connected hub or workstation.
- Be sure you are using the correct cable. When connecting the firewall's Internet port to a cable or DSL modem, use the cable that was supplied with the cable or DSL modem. This cable could be a standard straight-through Ethernet cable or an Ethernet crossover cable.

5.1.4 Forgot My Password

Try entering the default User Name and Password:

User Name: admin

Password: admin

Please note that both the User Name and Password are case-sensitive.

If this fails, you can restore your BiGuard 50G to its factory default settings by holding the Reset button on the back of your router until the Status LED begins to blink. Then enter the default User Name and Password to access your router.

5.2 LAN Interface

Refer to this section for issues relating to BiGuard 50G's LAN Interface.

5.2.1 Can't Access BiGuard 50G from the LAN

If there is no response from BiGuard 50G from the LAN:

- Check your Ethernet cable types and each connection.
- Make sure the computer's Ethernet adapter is installed and functioning properly.

If the error persists, you may have a hardware problem, and should contact technical support.

5.2.2 Can't Ping Any PC on the LAN

If PCs connected to the LAN cannot be pinged:

- Check the 10/100 LAN LEDs on BiGuard 50G's front panel. One of these LEDs should be on. If they are both off, check the cables between BiGuard 50G and the hub or PC.
- Check the corresponding LAN LEDs on your PC's Ethernet device are on.
- Make sure that driver software for your PC's Ethernet adapter and TCP/IP software is correctly installed and configured on your PC.
- Verify the IP address and the subnet mask of BiGuard 50G and the computers are on the same subnet.

5.2.3 Can't Access Web Configuration Interface

If you are having trouble accessing BiGuard 50G's Web Configuration Interface from a PC connected to the network:

- Check the connection between the PC and the router.
- Make sure your PC's IP address is on the same subnet as the router.
- If your BiGuard 50G's IP address has changed and you don't know the current IP address, reset the router to factory defaults by holding the Reset button on the back of your router for 6 seconds. This will reset the router's IP address to 192.168.1.254.
- Check to see if your browser had Java, JavaScript, or ActiveX enabled. If you are using Internet Explorer, click **Refresh** to ensure that the Java applet is loaded.
- Try closing the browser and re-launching it.
- Make sure you are using the correct User Name and Password. User Names and Passwords are case-sensitive, so make sure that **CAPS LOCK** is not on when entering this information.
- Try clearing your browser's cache.
 1. With Internet Explorer, click **Tools > Internet Options**.
 2. Under the **General** tab, click **Delete Files**.

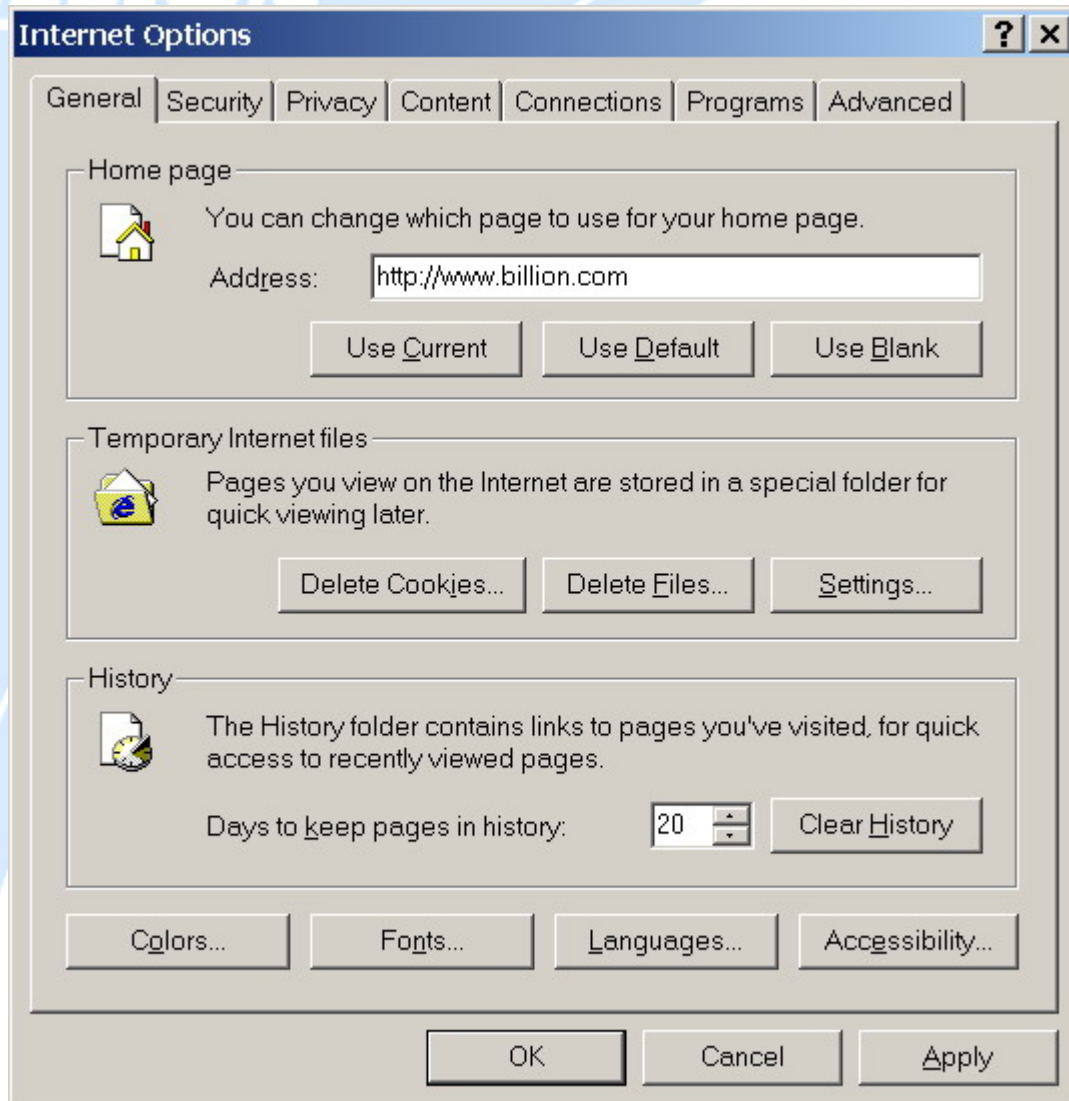

3. Make sure that the **Delete All Offline Content** checkbox is checked, and click **OK**.

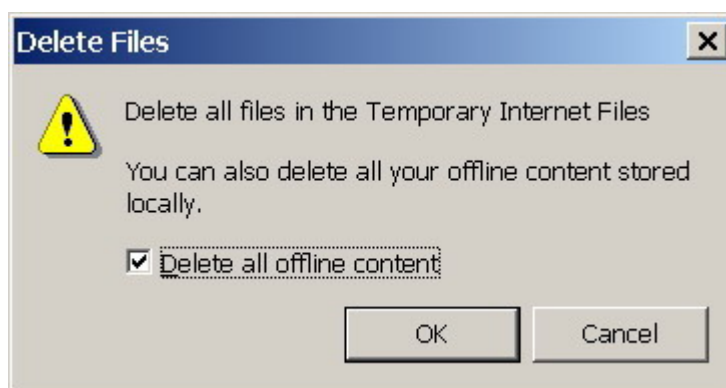

4. Click **OK** under **Internet Options** to close the dialogue.

- In Windows, type **arp -d** at the command prompt to clear you computer's ARP table.

5.2.3.1 Pop-up Windows

To use the Web Configuration Interface, you need to disable pop-up blocking. You can either disable pop-up blocking, which is enabled by default in Windows XP Service Pack 2, or create an exception for your BiGuard 50G's IP address.

Disabling All Pop-ups

In Internet Explorer, select **Tools > Pop-up Blocker** and select **Turn Off Pop-up Blocker**.

You can also check if pop-up blocking is disabled in the **Pop-up Blocker** section in the **Privacy** tab of the **Internet Options** dialogue.

1. In Internet Explorer, select **Tools > Internet Options**.
2. Under the **Privacy** tab, clear the **Block pop-ups** checkbox and click **Apply** to save your changes.

Enabling Pop-up Blockers with Exceptions

If you only want to allow pop-up windows with your BiGuard 50G:

1. In Internet Explorer, select **Tools > Internet Options**.
2. Under the **Privacy** tab, click **Settings** to open the **Pop-up Blocker Settings** dialogue.
3. Enter the IP address of your router.
4. Click **Add** to add the IP address to the list of **Allowed sites**.
5. Click **Close** to return to the **Privacy** tab of the **Internet Options** dialogue.
6. Click **Apply** to save your changes.

5.2.3.2 Javascripts

If the Web Configuration Interface is not displaying properly in your browser, check to make sure that JavaScripts are allowed.

1. In Internet Explorer, click **Tools > Internet Options**.
2. Under the **Security** tab, click **Custom Level**.

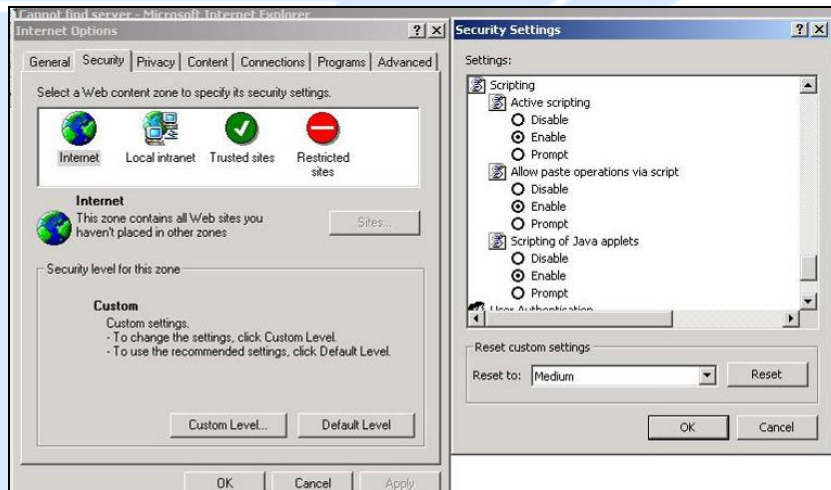

3. Under **Scripting**, check to see if **Active scripting** is set to **Enable**.
4. Ensure that **Scripting of Java applets** is set to **Enabled**.
5. Click **OK** to close the dialogue.

5.2.3.3 Java Permissions

The following Java Permissions should also be given for the Web Configuration Interface to display properly:

1. In Internet Explorer, click **Tools > Internet Options**.
2. Under the **Security** tab, click **Custom Level**.

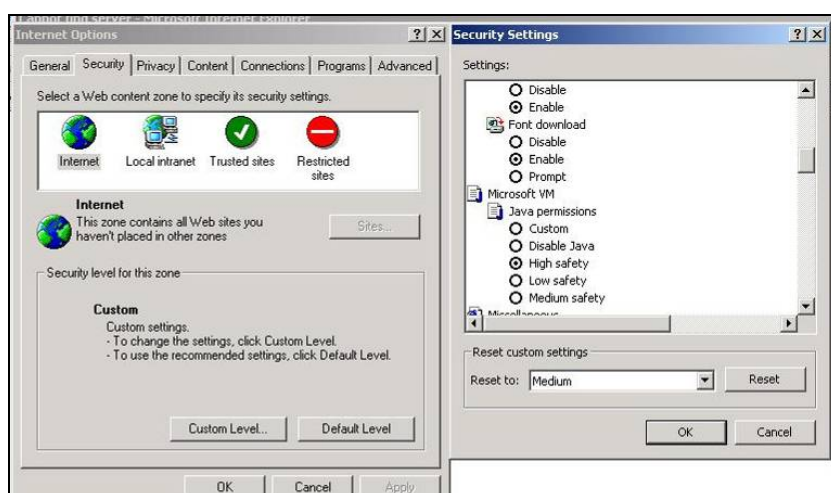

3. Under **Microsoft VM***, make sure that a safety level for **Java permissions** is selected.

4. Click **OK** to close the dialogue.

NOTE: If Java from Sun Microsystems is installed, scroll down to **Java (Sun)** and ensure that the checkbox is filled.

5.3 WAN Interface

If you are having problems with the WAN Interface, refer to the tips below.

5.3.1 Can't Get WAN IP Address from the ISP

If the WAN IP address cannot be obtained from the ISP:

- If you are using PPPoE or PPTP encapsulation, you will need a user name and password. Ensure that you have entered the correct **Service Type**, **User Name**, and **Password**. Note that user names and passwords are case-sensitive.
- If your ISP requires MAC address authentication, clone the MAC address from your PC on the LAN as BiGuard 50G's WAN MAC address.
- If your ISP requires host name authentication, configure your PC's name as BiGuard 50G's system name.

5.4 ISP Connection

Unless you have been assigned a static IP address by your ISP, your BiGuard 50G will need to request an IP address from the ISP in order to access the Internet. If your BiGuard 50G is unable to access the Internet, first determine if your router is able to obtain a WAN IP address from the ISP.

To check the WAN IP address:

1. Open your browser and choose an external site (i.e. www.billion.com).
2. Access the Web Configuration Interface by entering your router's IP address (default is 192.168.1.254).
3. The WAN IP Status is displayed on the first page.

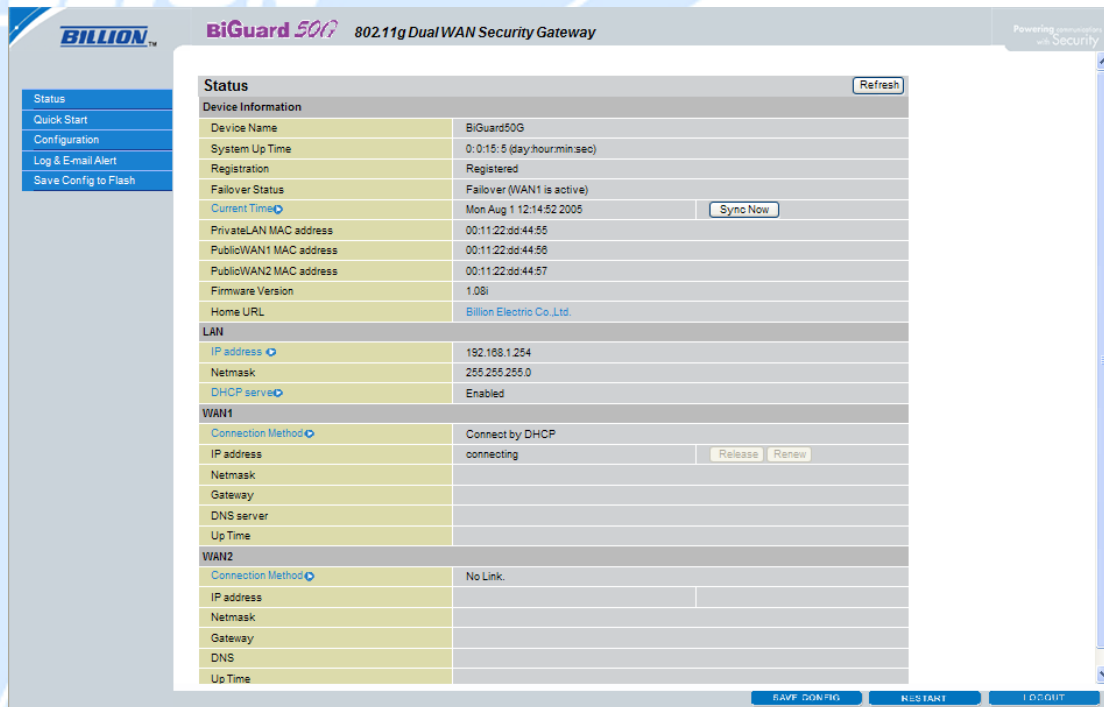

4. Check to see that the WAN port is properly connected to the ISP. If a **Connected by (x)** where **(x)** is your connection method is not shown, your router has not successfully obtained an IP address from your ISP.

If an IP address cannot be obtained:

1. Turn off the power to your cable or DSL modem.
2. Turn off the power to your BiGuard 50G.
3. Wait five minutes and power on your cable or DSL modem.
4. When the modem has finished synchronizing with the ISP (generally shown by LEDs on the modem), turn on the power to your router.

If an IP address still cannot be obtained:

- Your ISP may require a login program. Consult your ISP whether they require PPPoE or some other type of login.
- If your ISP requires a login, check to see that your User Name and Password are entered correctly.
- Your ISP may check for your PC's host name. Assign the PC Host Name of your ISP account as your PC's host name on the router.
- Your ISP may check for your PC's MAC address. Either inform your ISP that you have purchased a new network device or ask them to use your router's MAC address, or configure your router to spoof your PC's MAC address.

If an IP address can be obtained, but your PC cannot load any web pages from the Internet:

- Your PC may not recognize DNS server addresses. Configure your PC manually with DNS addresses.
- Your PC may not have the router correctly configured as its TCP/IP gateway.

5.5 Problems with Date and Time

If the date and time is not being displayed correctly, be sure to set it for your BiGuard 50G via the Web Configuration Interface. Both date and time can be found under **Configuration > System > Time Zone**.

5.6 Restoring Factory Defaults

You can restore your BiGuard 50G to its factory settings by holding the Reset button on the back of your router until the Status LED begins to blink. This will reset your router to its default settings.



Appendix A: Product Specifications



Availability and Resilience

- Dual-WAN ports
- Load balancing for increased bandwidth of inbound and outbound traffic
- Automatic failover to redirect the packet when one broadband connection is broken. It will keep your Internet connection always online whenever one connection should fail.

Virtual Private Network

- IPSec VPN, supports up to 30 IPSec tunnels
- IPSec VPN performance is up to 30 Mbps
- PPTP VPN, support up to 4 PPTP tunnels
- PPTP VPN performance is up to 10 Mbps
- Manual key, Internet Key Exchange (IKE) authentication and Key Management
- Authentication (MD5 / SHA-1)
- DES/3DES encryption
- AES 128/192/256 encryption
- IP Authentication Header (AH)
- IP Encapsulating Security Payload (ESP)
- IPSec VPN concentrator
- Dynamic IPSec VPN (FQDN) support
- IPSec NAT Traversal (IPSec NAT-T)
- IPSec DPD (Dead Peer Detection)
- Supports remote access and office-to-office IPSec Connections
- PPTP Server

- Netbios over VPN

Firewall

- Stateful Packet Inspection (SPI) and Denial of Service (DoS) prevention
- Packet filter un-permitted inbound (WAN)/Inbound (LAN) Internet access by IP address, port number and packet type
- Email alert and logs of attack
- MAC Address Filtering
- Intrusion detection

Content Filtering

- URL Filter settings prevent user access to certain sites on the Internet
- Java Applet/Active X/Cookie Blocking

Quality of Service Control

- Supports DiffServ approach
- Traffic prioritization and bandwidth management based-on IP protocol, port number and IP or MAC address

Web-Based Management

- Easy-to-use WEB interface
- Firmware upgradeable via WEB interface
- Local and remote management via HTTP & HTTPS

Network Protocols and Features

- Web Diagnostics
- System Logs
- PPPoE, PPTP, Big Pond and DHCP client connections to the ISP
- NAT, static routing and RIP-2
- Dynamic Domain Name System (DDNS)
- Virtual Server and DMZ
- DHCP Server
- NTP
- SMTP Client
- SNMP
- SIP Pass-through
- Multiple NAT (Multiple LAN & Multiple WAN)

Physical Interface

Ethernet WAN 2 ports (10/100 Base-T), support Auto- Crossover (MDI/MDIX)

Ethernet LAN 8 ports (10/100 Base-T) switch support Auto- Crossover (MDI/MDIX)

Physical Specifications

Dimensions: 18.98" x 6.54" x 1.77" (482mm x 166 mm x 45mm, with Bracket)

9.84" x 6.54" x 1.38" (250mm x 166 mm x 35mm, non Bracket)

Power Requirement

Input: 12VDC, 1A

Operating Environment

- Operating temperature: 0 ~ 40 degrees Celsius
- Storage temperature: -20 ~ 70 degrees Celsius
- Humidity: 20 ~ 95% non-condensing

Appendix B: Customer Support

Most problems can be solved by referring to the Troubleshooting section in the User's Manual. If you cannot resolve the problem with the Troubleshooting chapter, please contact the dealer where you purchased this product.

Contact Billion

The screenshot shows the Billion website homepage. At the top, there is a navigation bar with links for Home, About Billion, Products, Education, Support, Partners, and Contact Us. A search bar and a website selector are also present. The main banner features the text "High Mobility & Business Productivity" and "A Hybrid IPSec / SSL VPN Security Gateway", accompanied by an image of a woman holding a laptop and a smartphone. Below the banner, there are tabs for 3G, IPTV, VoIP, SSL VPN, and Central Mgmt. The main content area is divided into several sections: "News and Event" with award information, "Products and Upgrades" with a list of networking solutions, "Office & SMBs Networking Solutions" with a list of products, "Home User Networking Solutions", "Partners" with a "Wanted!!" message, "Event" for GITEX 2007, and "BiGuard User Club" with a "Register Now!!" message. The footer contains the same navigation links as the top bar.

Worldwide

<http://www.billion.com/>

Appendix C: FCC Interference Statement

This device complies with Part 15 of FCC rules. Operation is subject to the following two conditions:

- This device may not cause harmful interference.
- This device must accept any interference received, including interference that may cause undesired operations.

This equipment has been tested and found to comply with the limits for a Class B digital device pursuant to Part 15 of the FCC Rules. These limits are designed to provide reasonable protection against harmful interference in a commercial environment.

If this equipment does cause harmful interference to radio/television reception, which can be determined by turning the equipment off and on, the user is encouraged to try to correct the interference by one or more of the following measures:

- Reorient or relocate the receiving antenna.
- Increase the separation between the equipment and the receiver.
- Connect the equipment into an outlet on a circuit different from that to which the receiver is connected.
- Consult the dealer or an experienced radio/TV technician for help.

Notice:

Changes or modifications not expressly approved by the party responsible for compliance could void the user's authority to operate the equipment.

Appendix D: Network, Routing, and Firewall Basics

D.1 Network Basics

D.1.1 IP Addresses

With the number of TCP/IP networks interconnected across the globe, ensuring that transmitted data reaches the correct destination requires each computer on the Internet has a unique identifier. This identifier is known as the IP address. The Internet Protocol (IP) uses a 32-bit address structure, and the address is usually written in dot notation.

A typical IP address looks like this:

198.25.12.8

The 32 bits of the address are subdivided into two parts. The first part of the address identifies the network, while the second part identifies the host node or station on the network. How the address is divided depends on the address range and the application.

The five standard IP address classes each have different methods to determine the network and host sections of the address, which makes multiple hosts on a network possible. TCP/IP software identifies each address class by reading a unique bit pattern that precedes each address type. Once the address class has been recognized, the software can then correctly determine the addresses' host section. With this structure, IP addresses can uniquely identify each network and node.

D.1.1.1 Net mask

With each address class, the size of the two subdivided parts (network address and host address) is implied by the class. A net mask associated with an IP address can also express this partitioning. A net mask 32-bit quantity yields the network address when combined with an IP address. As an example, the net masks for Class A, B, and C are 255.0.0.0, 255.255.0.0, and 255.255.255.0 respectively.

Instead of dotted-decimal notation, the net mask can also be written in terms of the number of ones from the left. This number is added to the IP address, following a

back slash (/). For example, a typical Class C address could be written as 192.168.234.245/24, which means that the net mask is 24 ones followed by 8 zeros. (11111111 11111111 11111111 00000000).

D.1.1.2 Subnet Addressing

Subnet addressing enables the split of one IP network address into multiple physical networks. These smaller networks are called subnetworks, and these subnetworks can make efficient use of each address when compared to needing a different network number at each end of a routed link. This technique is especially useful in smaller network environments, such as small office LANs.

A Class B address provides 16 bits of node numbers, which enable 65,536 nodes. Since most organizations don't require such a large number of nodes, the free bits can be reassigned with subnet addressing.

Multiple Class C addresses can be made from a Class B address. For example, the IP address of 172.20.0.0 allows eight extra bits to use as a subnet address, since node addresses are limited to a maximum of 255. The IP address of 172.20.52.212 would be read as IP network address 172.20, subnet number 52, and node number 212.

Besides extending the number of available addresses, this technique also allows a network manager to design an address scheme for the network by using different subnets. This can be useful when trying to distinguish other geographical locations in the network or other departments in the organization.

D.1.1.3 Private IP Addresses

When isolated from the Internet, the hosts on your local network may be assigned IP addresses with no conflicts. However, the Internet Assigned Numbers Authority (IANA) has reserved several blocks of IP addresses for private networks. These include:

10.0.0.0 - 10.255.255.255

172.16.0.0 - 172.16.255.255

192.168.0.0 - 192.168.255.255

When assigning IP addresses to your private network, be sure to use IP addresses

from these ranges.

D.1.2 Network Address Translation (NAT)

Traditionally, multiple PCs that needed simultaneous Internet access also required a range of IP addresses from the Internet Service Provider (ISP). Not only was this method very costly, but the number of available IP addresses for PCs is limited. Instead, BiGuard 50G uses a type of address sharing called Network Address Translation to grant Internet access to several PCs on the same network through the same Internet account. This method translates internal IP addresses to a single address that is unique on the Internet. This unique address can either be fixed or dynamic, depending on the type of Internet account, and the internal LAN IP addresses may also be either private or registered addresses.

NAT also offers firewall-like protection to your network, since internal LAN addresses are shielded from the public Internet. All incoming traffic to the public IP address is handled by the router, which means added security for your network from intruders. If a particular PC on your LAN requires access from outside PCs, you can use port forwarding to accomplish this. For information on how to configure port forwarding on BiGuard 50G, refer to the **Virtual Server** section of *Chapter 4: Router Configuration*.

D.1.3 Dynamic Host Configuration Protocol (DHCP)

If the PCs on a LAN require access to the Internet, each PC must be configured with an IP address, a gateway address, and one or more DNS server addresses. Rather than configuring each PC manually, you can instead configure a network device to act as a Dynamic Host Configuration Protocol (DHCP) server. PCs on the network can automatically obtain IP addresses from a list of addresses stored on the DHCP server. In addition, other information such as gateway and DNS address can also be assigned with a DHCP server. When connecting to the ISP, BiGuard 50G also functions as a DHCP client. BiGuard 50G can automatically obtain an IP address, subnet mask, gateway address, and DNS server addresses if the ISP assigns this information via DHCP.

D.2 Router Basics

D.2.1 What is a Router?

A router is a device that forwards data packets along networks. A router is connected to at least two networks. Usually, this is a LAN and a WAN that is connected to an ISP network. Routers are located at gateways, the places where two or more networks connect. Routers use headers and forwarding tables to determine the best path for forwarding the packets, and they use protocols to communicate with each other and configure the best route between any two hosts.

Routers can vary in performance and scale, the types of physical WAN connection they support, and the number of routing protocols supported. BiGuard 50G offers a convenient and powerful way for small-to-medium businesses to connect their networks.

D.2.2 Why use a Router?

While large bandwidth can easily and inexpensively be provided in a LAN, having high bandwidth between a LAN and the Internet can be prohibitively expensive. Because of this, Internet access is usually done through a slower WAN link, such as a cable or DSL modem. To efficiently use this slower connection, a router acts as a mechanism for selecting and transmitting data meant for the Internet. By using a router, organizations can enjoy relatively inexpensive Internet access, while maintaining a high-speed local area network.

D.2.3 Routing Information Protocol (RIP)

Routing Information Protocol (RIP) is an interior gateway protocol that specifies how routers exchange routing table information. Routers periodically update each other with RIP, changing their routing tables when necessary.

BiGuard 50G supports the RIP protocol. RIP also supports subnet and multicast protocols. RIP is not required for most home applications.

D.3 Firewall Basics

D.3.1 What is a Firewall?

Firewalls prevent unauthorized Internet users from accessing private networks connected to the Internet. All messages entering or leaving the intranet pass through the firewall, which examines each message and blocks those that do not meet the specified security criteria. With the functionality of a NAT router, the firewall adds features that deal with outside Internet intrusion and attacks. When an attack or intrusion is detected, the firewall can be configured to log the intrusion attempt, and can also notify the administrator of the incident. With this information, the administrator can work with the ISP to take action against the hacker. Against some types of attacks, the firewall can discard intruder packets, thereby fending off the hacker from the private network.

D.3.1.1 Stateful Packet Inspection

BiGuard 50G uses Stateful Packet Inspection (SPI) to protect your network from intrusions and attacks. Unlike less sophisticated Internet sharing routers, SPI ensures secure firewall filtering by intercepting incoming packets at the network layer, and analyzing them for state-related information that is associated with all network connections. User-level applications such as Web browsers and FTP can make complex network traffic patterns, which BiGuard 50G analyzes by looking at groups of connection states.

All state information is stored in a central cache. Traffic passing through the firewall is analyzed against these states, and then is either allowed to pass through or rejected.

D.3.1.2 Denial of Service (DoS) Attack

A hacker may be able to prevent your network from operating or communicating by launching a Denial of Service (DoS) attack. The method used for such an attack can be as simple as merely flooding your site with more requests than it can handle. A more sophisticated attack may attempt to exploit some weakness in the operating system used by your router or gateway. Some operating systems can be disrupted by simply sending a packet with incorrect length information.

D.3.2 Why Use a Firewall?

With a LAN connected to the Internet through a router, there is a chance for hackers to access or disrupt your network. A simple NAT router provides a basic level of protection by shielding your network from the outside Internet. Still, there are ways for more dedicated hackers to either obtain information about your network or disrupt your network's Internet access. Your BiGuard 50G provides an extra level of protection from such attacks with its built-in firewall.

Appendix E: Virtual Private Networking

E.1 What is a VPN?

A Virtual Private Network (VPN) is a shared network where private data is segmented from other traffic so that only the intended recipient has access. It allows organizations to securely transmit data over a public medium like the Internet. VPNs utilize tunnels, which allow data to be safely delivered to the intended recipient.

Because private networks lack data security, IPSec-based VPNs employ encryption technologies that protect a private network from data theft or tampering. These private networks can be implemented over any type of IP network, which allows for excellent flexibility.

E.1.1 VPN Applications

VPNs are traditionally used three ways:

- Extranets: Extranets are secure connections between two or more organizations. IPSec-based VPNs are ideal for extranet connections, as they can be quickly and inexpensively installed. Extranets are often used to securely share a company's information with suppliers, vendors, customers, or other businesses.
- Intranets: Intranets are private networks that connect an organization's locations together. These locations range from a headquarters, to branch offices, to a remote employee's home. Intranets are often used for email and for sharing applications and files. A firewall protects Intranets from unauthorized access.
- Remote Access: Remote access enables mobile workers to access email and business applications. Remote access VPNs greatly reduce expenses by enabling mobile workers to dial a local Internet connection and then set up a secure IPSec-based VPN communications to their organization.

E.2 What is IPSec?

Internet Protocol Security (IPSec) is a set of protocols and algorithms that provide

data authentication, integrity, and confidentiality as data is transferred across IP networks. IPSec provides data security at the IP packet level, and protects against possible security risks by protecting data. IPSec is widely used to establish VPNs.

There are three major functions of IPSec:

- Confidentiality: Conceals data through encryption.
- Integrity: Ensures that contents did not change in transit.
- Authentication: Verifies that packets received are actually from the claimed sender.

E.2.1 IPSec Security Components

IPSec contains three major components:

- Authentication Header (AH): Provides authentication and integrity.
- Encapsulating Security Payload (ESP): Provides confidentiality, authentication, and integrity.
- Internet Key Exchange (IKE): Provides key management and Security Association (SA) management.

These components are discussed below.

E.2.1.1 Authentication Header (AH)

The Authentication Header (AH) is a protocol that provides authentication and integrity, protecting data from tampering. It provides authentication of either all or part of the contents of a datagram through the addition of a header that is calculated based on the values in the datagram.

The AH can also protect packets from unauthorized re-transmission with anti-replay functionality. The presence of the AH header allows us to verify the integrity of the message, but doesn't encrypt it. Thus, AH provides authentication but not privacy. ESP protects data confidentiality. Both AH and ESP can be used together for added protection.

A typical AH packet looks like this:

Next Header	Payload Length	Reserved
SPI		
Sequence Number		
Authentication Data		

E.2.1.2 Encapsulating Security Payload (ESP)

Encapsulating Security Payload (ESP) provides privacy for data through encryption. An encryption algorithm combines the data with a key to encrypt it. It then repackages the data using a special format, and transmits it to the destination. The receiver then decrypts the data using the same algorithm. ESP is usually used with AH to provide added data security.

ESP divides its fields into three components...

ESP Header: Placed before encrypted data, the ESP Header contains the SPI and Sequence Number. Its placement depends on whether ESP is used in transport mode or tunnel mode.

ESP Trailer: Placed after the encrypted data, the ESP Trailer contains padding that is used to align the encrypted data.

ESP Authentication Data: This contains an Integrity Check Value (ICV) for when ESP's optional authentication feature is used.

ESP provides authentication, integrity, and confidentiality, which provides data content protection, and protects against data tampering. A typical ESP packet looks like this:

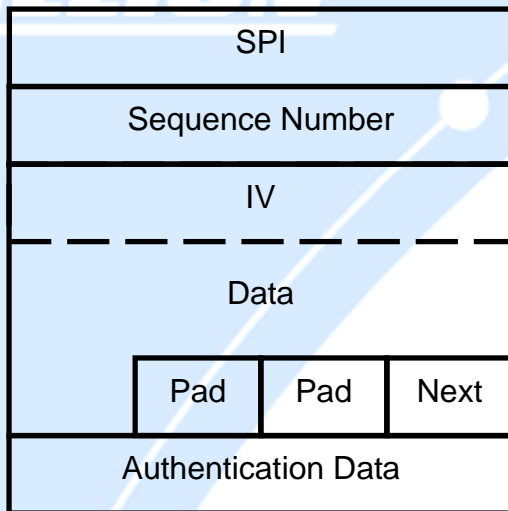

E.2.1.3 Security Associations (SA)

Security Associations are a one-way relationships between sender and receiver that specify IPSec-related parameters. They provide data protection by using the defined IPSec protocols, and allow organizations to control according to the security policy in effect, which resources may communicate securely.

SA is identified by 3 parameters:

- Security Parameters Index (SPI), a locally unique value
- Destination IP Address
- Security Protocol: (AH or ESP, but not both)

There are several other parameters associated with an SA that are stored in a Security Association database.

E.2.2 IPSec Modes

To exchange data between different types of VPNs, IPSec provides two major modes:

- Tunnel Mode

This mode is used for host-to-host security. Protection extends to the payload of IP data, and the IP addresses of the hosts must be public IP addresses.

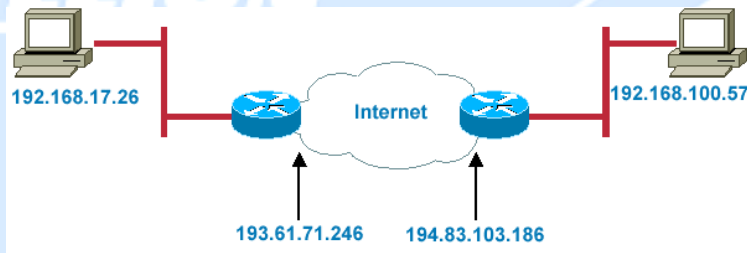

Transport Mode

- This mode is used to provide data security between two networks. It provides protection for the entire IP packet and is sent by adding an outer IP header corresponding to the two tunnel end-points. Since tunnel mode hides the original IP header, it provides security of the networks with private IP address space.



E.2.3 Tunnel Mode AH

AH is typically applied to a data packet in the following manner:

Original Packet

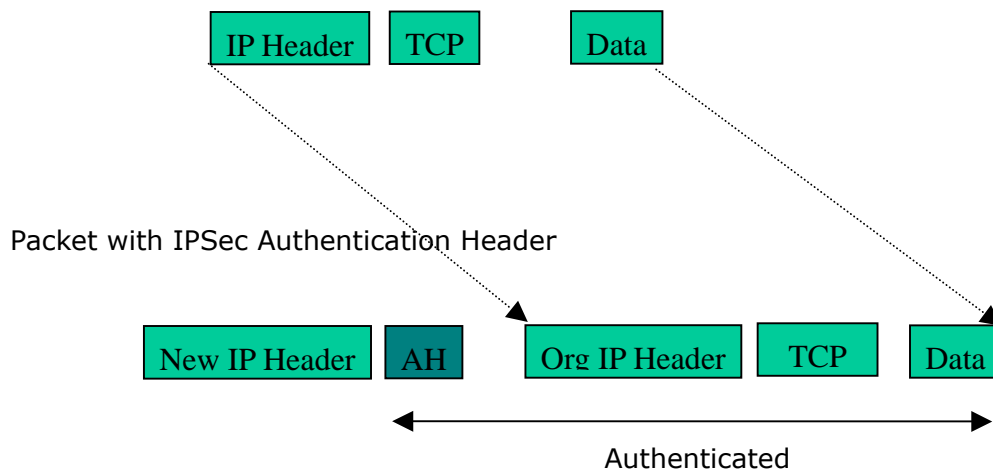

E.2.4 Tunnel Mode ESP

Here is an example of a packet with ESP applied:

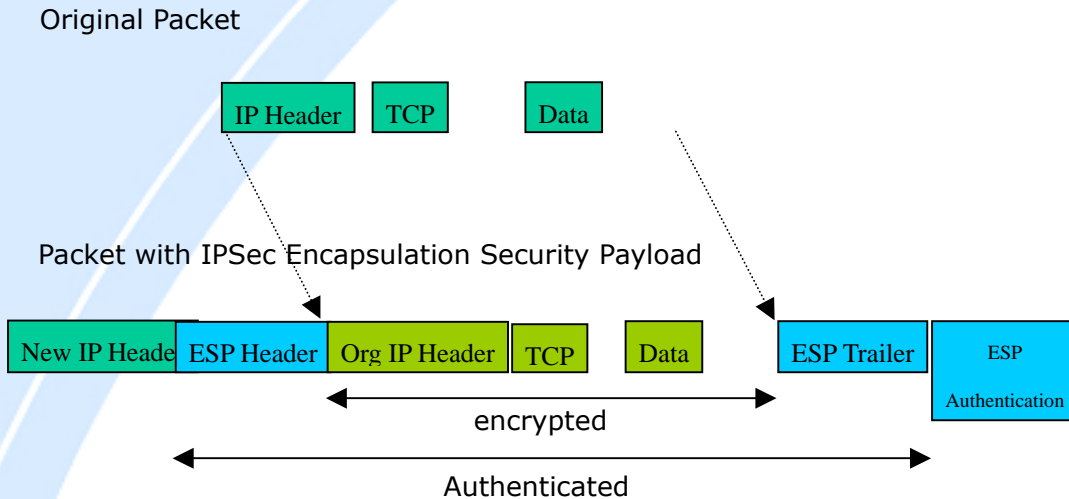

E.2.5 Internet Key Exchange (IKE)

Before either AH or ESP can be used, it is necessary for the two communication devices to exchange a secret key that the security protocols themselves will use. To do this, IPsec uses Internet Key Exchange (IKE) as a primary support protocol. IKE facilitates and automates the SA setup, and exchanges keys between parties transferring data. Using keys ensures that only the sender and receiver of a message can access it. These keys need to be re-created or refreshed frequently so that the parties can communicate securely with each other. Refreshing keys on a regular basis ensures data confidentiality.

There are two phases to this process. Phase I deals with the negotiation and management of IKE and IPsec parameters. This phase can be carried out in either one of two modes: Main Mode or Aggressive Mode. Main mode utilizes three message pairs that negotiate IKE parameters, establish a shared secret and derive session keys, and exchange and provide identities, retroactively authenticating the information sent. This method is very secure, but when using the pre-shared key method for authentication, it is possible to use IDs other than the packets's IP

addresses. Aggressive mode reduces this process to three messages, but parameter negotiation is limited, identity protection is lacking except when using public key encryption, and is more vulnerable to Denial of Service attacks.

Phase II, known as Quick Mode, establishes symmetrical IPSec Security Associations for both AH and ESP. It does this by negotiating IPSec parameters, exchange nonces to derive session keys from the IKE shared secret, exchange DH values to generate a new key, and identify which traffic this SA bundle will protect using selectors (IDi and IDr payloads).

The following is an illustration on how data is handled with IKE:

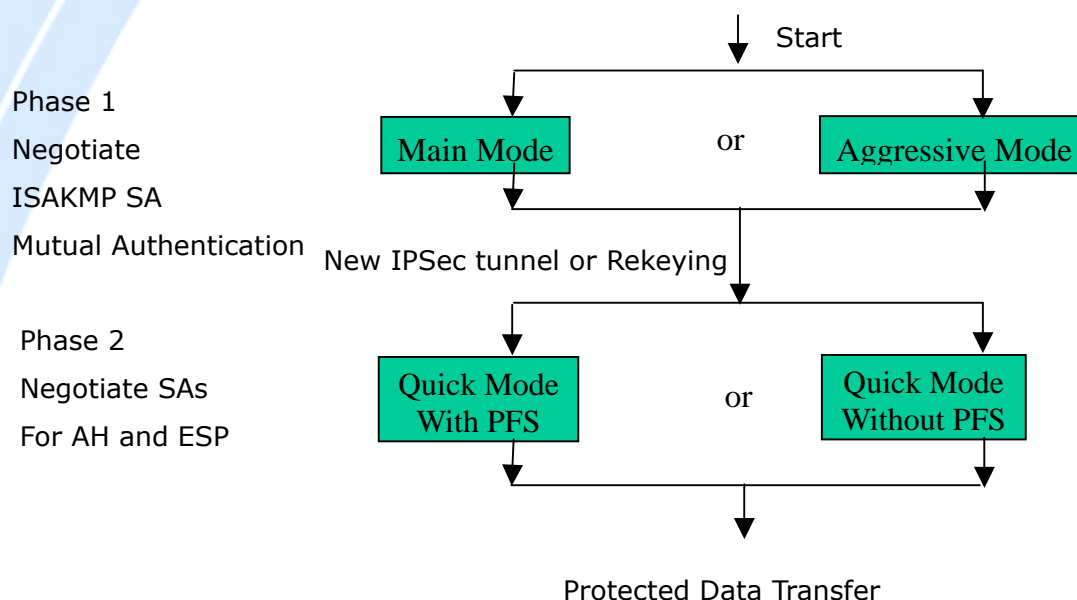

Appendix F: IPSec Logs and Events

F.1 IPSec Log Event Categories

There are three major categories of IPSec Log Events for your BiGuard 50G. These include:

1. IKE Negotiate Packet Messages
2. Rejected IKE Messages
3. IKE Negotiated Status Messages

The table in the following section lists the different events of each category, and provides a detailed explanation of each.

F.2 IPSec Log Event Table

IKE Negotiate Packet Messages	
Log Event	Explanation
Send Main mode initial message of ISAKMP	Sending the first initial message of main mode (phase I). Done to exchange encryption algorithm, hash algorithm, and authentication method.
Send Aggressive mode initial message of ISAKMP	Sending the first message of aggressive mode (phase I).
Received Main mode initial message of ISAKMP	Received the first message of main mode.
Send Main mode first response message of ISAKMP	Sending the first response message of main mode. Done to exchange encryption algorithm, hash algorithm, and authentication method.
Received Main mode first response message of ISAKMP	Received the first response message of main mode. Done to exchange encryption algorithm, hash algorithm, and authentication method.
Send Main mode second message of ISAKMP	Sending the second message of main mode. Done to exchange key values.

Received Main mode second message of ISAKMP	Received the second message of main mode. Done to exchange key values.
Send Main mode second response message of ISAKMP	Sending the main mode second response message. Done to exchange key values.
Received Main mode second response message of ISAKMP	Received the main mode second response message. Done to exchange key values.
Send Main mode third message of ISAKMP	Sending the third message of main mode. Done for authentication.
Received Main mode third message of ISAKMP	Received the third message of main mode. Done for authentication.
Send Main mode third response message of ISAKMP	Sending the third response message of main mode. Done for authentication.
Received Main mode third response message of ISAKMP	Received the third response message of main mode. Done for authentication.
Received Aggressive mode initial ISAKMP Message	Received the first message of aggressive mode.
Send Aggressive mode first response message of ISAKMP	Sending the first response message of aggressive mode. Done to exchange proposal and key values.
Received Aggressive mode first response message of ISAKMP	Received the first response message of aggressive mode. Done to exchange proposal and key values.
Send Aggressive mode second message of ISAKMP	Sending the second message of aggressive mode. Done to exchange proposal and key values.

Received Aggressive mode second ISAKP Message	Received the second message of aggressive mode. Done to exchange proposal and key values.
Send Quick mode initial message	Sending the first message of quick mode (Phase II). Done to exchange proposal and key values (IPSec).
Received Quick mode initial message	Received the first message of quick mode (Phase II). Done to exchange proposal and key values (IPSec).
Send Quick mode first response message	Sending the first response message of quick mode (Phase II). Done to exchange proposal and key values (IPSec).
Received Quick mode first response message	Received the first response message of quick mode (Phase II). Done to exchange proposal and key values (IPSec).
Send Quick mode second message	Sending the second message of quick mode (Phase II).
Received Quick mode second message	Received the second message of quick mode (Phase II).
ISAKMP IKE Packet	Indicates IKE packet.
ISAKMP Information	Indicates Information packet.
ISAKMP Quick Mode	Indicates quick mode packet.

Rejected IKE Messages

NO PROPOSAL CHOSEN: No acceptable Oakley Transform

NO PROPOSAL CHOSEN: No acceptable Proposal in IPsec SA

NO PROPOSAL CHOSEN: PFS is required in Quick Initial SA.

NO PROPOSAL CHOSEN: PFS is not required in Quick Initial SA.

NO PROPOSAL CHOSEN: Initial Aggressive Mode message from [IP Address] but no connection has been configured

NO PROPOSAL CHOSEN: Initial Main Mode message received on [IP:Port #] but no connection has been authorized

INVALID ID: Require peer to have ID [ID], but peer declares [ID]

INVALID ID INFORMATION: Initial Aggressive Mode packet claiming to be from [ID] on [IP] but no connection has been authorized

INVALID ID: Require peer to have ID [ID], but peer declares [ID]

INVALID ID INFORMATION: Initial Aggressive Mode packet claiming to be from [ID] on [IP] but no connection has been authorized

IKE Negotiated Status Messages

Received Delete SA payload and deleting IPSEC State (*integer*)

Received Delete SA payload: Deleting ISAKMP State (*integer*)

(Main/Aggressive) mode peer ID is (identifier string)

ISAKMP SA Established

IPsec SA Established

Appendix G: Bandwidth Management with QoS

G.1 Overview

In a home or office environment, users constantly have to transmit data to and from the Internet. When too many are accessing the Internet at the same time, service can slow to a crawl, causing service interruptions and general frustration. Quality of Service (QoS) is one of the ways BiGuard 50G can optimize the use of bandwidth, ensuring a smooth and responsive Internet connection for all users.

G.2 What is Quality of Service?

QoS is a feature that prioritizes and guarantees bandwidth to achieve optimal service performance. QoS can maximize the use of available network bandwidth by prioritizing time-sensitive traffic to avoid latencies and delays. By ensuring that time-sensitive applications such as VoIP and streaming video get priority access to bandwidth, users in both home and office environments can enjoy smooth and responsive data transmission no matter which applications they are running.

If you've ever experienced slow Internet speeds due to other network users using bandwidth-consuming applications like P2P, you'll understand why QoS is such a breakthrough for home users and office users. Billion makes itself unique by integrating QoS in its routers for both inbound and outbound traffic.

QoS helps users manage bandwidth and effectively prioritize data traffic. It gives you full control over the traffic of any type of data. Employed on DiffServ (Differentiated Services) architecture, data traffic is given priority by the router; ensuring latency-sensitive applications like voice and mission-critical data such as VPN move through the router at lightning speeds, even under heavy load. You can throttle the speed of different types of data passing through the router, limit the speed of unimportant or bandwidth-consuming applications, and even distribute the bandwidth for different groups of users at home or in the office. QoS keeps your Internet connection smooth and responsive.

G.3 How Does QoS Work?

QoS employs three different methods for optimizing bandwidth:

- Prioritization: Assigns different priority levels for different applications, prioritizing traffic. High, Normal and Low priority settings.
- Outbound and Inbound IP Throttling: Controls network traffic and allows you to limit the speed of each application.
- DiffServ Technology: Manages priority queues and DSCP tagging through the Internet backbone. Manages traffic among Ethernet, wireless, and ADSL interfaces.

G.4 Who Needs QoS?

QoS is ideal for home and office users who need to use a variety of real-time applications like VoIP, on-line games, P2P, video streaming, and FTP simultaneously. With QoS, you can optimize your bandwidth to accommodate several of these applications without experiencing latency or service interruptions.

G.4.1 Home Users

Low latency is everything for gamers. Most home users feel frustrated when trying to play an online game over a shared ADSL connection. Unfortunately, most routers have no way of determining the importance of the packet at any given time. All the traffic is treated equally, so a packet containing an "urgent" command may be delayed. QoS gives you the ability to control the bandwidth. Using IP Throttling, bandwidth limits can be enforced on a particular application or any system within the LAN. Prioritization specifies which packets have priority and should not be delayed, and which packets have lower priority and should be moved to the end of the upload queue.

Suppose there are four students sharing a three-floor house with one single broadband connection. Tom, a college freshman, is playing the online game with his group members, while Mary, a sophomore student, is talking to her net pal via Skype. Meanwhile, Jacky is downloading a movie file by using the P2P application program. Sophia, however, is just trying to log on to the website to send her photos to her family. As a result, the net speed slows to a crawl and affects everyone sharing the Internet connection. QoS is designed for managing traffic flow and bandwidth to solve this problem. You can first classify different applications (online games, FTP, Skype, email) as shown in the table below. Then, you can manage and prioritize the flow of bandwidth at different levels (e.g. 30% for games, 20% for downloads, 10% for email, 20% for FTP, and 35% for others). QoS can be used to identify different applications and assign priority to enable a smooth and responsive broadband connection.

Application	Data Ratio (%)	Priority
On-line games	30%	High
Skype	5%	High
Email	10%	High
FTP	20%	Upload (High), Download (Normal)
Other	35%	

G.4.2 Office Users

QoS is also ideal for small businesses using an office server as a web server. With QoS control, web pages served to your customers can be given top priority and delivered first so that it will not be impeded by email and office web browsing.

Here is a good example of how QoS can work in an office environment. A CEO is holding a videoconference with international clients in the meeting room. However, the streaming video and voice frequently lag. Sales people are talking to international agencies via VoIP phone, while sending orders via email to vendors for production. However, some staff are downloading MP3 music files, large-size photos and watching video streaming online. Consequently, the Internet connection slows down. This is why business users need QoS to manage data traffic. With QoS, the network administrator can define and classify important packets; specify a minimum guaranteed rate for each application, and ensure that important packets have priority to ensure a good quality of broadband connection for the entire organization.

Application	Data Ratio (%)	Priority
Videoconferencing	30%	High
VoIP	20%	High
Email	10%	High
FTP	10%	Upload (High), Download (Normal)
Other	30%	MP3 (Low), MSN (Normal)

Appendix H: Router Setup Examples

H.1 Outbound Fail Over

Step 1: Go to **Configuration > WAN > ISP Settings**. Select **WAN1** and **WAN2** and click **Edit**.

Name	Description	
WAN1	DHCP	Edit
WAN2	DHCP	Edit

Step 2: Configure WAN1 and WAN2 according to the information given by your ISP.

Connection Method	Static IPSetting
IP assigned by your ISP	230 . 100 . 100 . 1
IP Subnet Mask	255 . 255 . 255 . 0
ISP Gateway address	230 . 100 . 100 . 254
MAC address	<input type="checkbox"/> Your ISP requires you to input WAN Ethernet MAC
Candidates	MAC address 00 . 00 . 00 . 00 . 00 . 00
Primary DNS	168 . 95 . 192 . 1
Secondary DNS	168 . 95 . 1 . 1
RIP	disable <input checked="" type="radio"/> RIP-2B <input type="radio"/> RIP-2M
MTU	1500
Network address Translation	<input checked="" type="radio"/> enable <input type="radio"/> disable

BILLION™ **BiGuard 50G** 802.11g Dual WAN Security Gateway Powering communications with Security

- Status
- Quick Start
- Configuration
- LAN
- WAN
- ISP Settings
- Bandwidth Settings
- WAN IP Alias
- Dual WAN
- System
- Firewall
- VPN
- QoS
- Virtual Server
- Advanced
- Log & E-mail Alert
- Save Config to Flash

WAN2

Static IP

Connection Method	Static IPSetting			
IP assigned by your ISP	213	100	100	2
IP Subnet Mask	255	255	255	0
ISP Gateway address	213	100	100	254
MAC address	<input type="checkbox"/> Your ISP requires you to input WAN Ethernet MAC			
Candidates	MAC address <input type="text" value="00"/> <input type="text" value="00"/> <input type="text" value="00"/> <input type="text" value="00"/> <input type="text" value="00"/> <input type="text" value="00"/>			
Primary DNS	168	95	192	1
Secondary DNS	168	95	1	1
RIP	<input type="checkbox"/> disable <input checked="" type="radio"/> RIP-2B <input type="radio"/> RIP-2M			
MTU	1500			
Networkaddress Translation	<input checked="" type="radio"/> enable <input type="radio"/> disable			

Step 3: Go to Configuration > Dual WAN > General Settings. Select the **Fail Over** radio button. Under Connectivity Decision, input the number of times BiGuard 50G should probe the WAN before deciding that the ISP is in service or not (3 by default). Next, input the duration of the probe cycle (30 sec. by default) and choose the way WAN ports are probed.

BILLION™ **BiGuard 50G** 802.11g Dual WAN Security Gateway Powering communications with Security

- Status
- Quick Start
- Configuration
- LAN
- WAN
- Dual WAN
- General Setting
- Outbound Load Balance
- Inbound Load Balance
- Protocol Binding
- System
- Firewall
- VPN
- QoS
- Virtual Server
- Advanced
- Log & E-mail Alert
- Save Config to Flash

General Setting

Dual WAN Mode

Mode Load Balance Fail Over

WAN Port Service Detection Policy

Service Detection (for load balance.) Enable Disable

Connectivity Decision Not in service when probing failed after consecutive times.

Probe Cycle Every seconds.

Probe WAN1 Gateway Host

Probe WAN2 Gateway Host

Failback to WAN1 when possible (for failover.) Enable Disable

Please ensure the WAN ports are functioning by performing a ping operation on each before proceeding. Finally, choose whether or not BiGuard 50G should fail back to

Step 4: Click **Save Config** to save all changes to flash memory.

H.2 Outbound Load Balancing

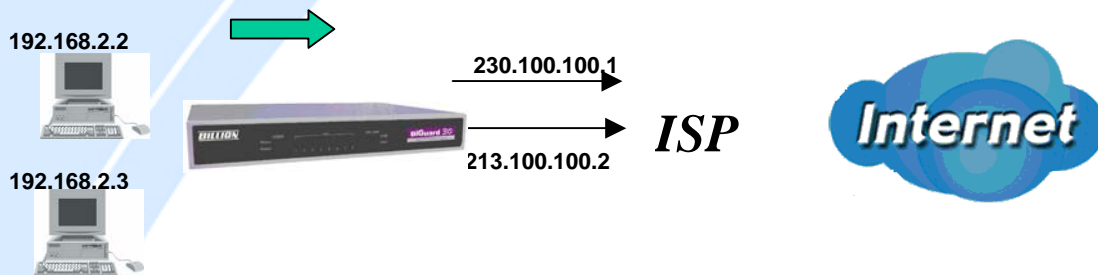

With Outbound Load Balancing, you can improve upload performance by optimizing your connection via Dual WAN. To do this, follow these steps:

Step 1: Go to **Configuration > WAN > ISP Settings**. Configure your WAN1 ISP settings and click **Apply**.

The screenshot shows the configuration interface for the Billion BiGuard 50G 802.11g Dual WAN Security Gateway. The left sidebar contains a navigation menu with options: Status, Quick Start, Configuration, LAN, WAN, ISP Settings, Bandwidth Settings, WAN IP Alias, Dual WAN, System, Firewall, VPN, QoS, Virtual Server, Advanced, Log & E-mail Alert, and Save Config to Flash. The main content area is titled 'WAN1' and 'Static IP'. It contains the following settings:

Connection Method	Static IP Setting			
IP assigned by your ISP	230	100	100	1
IP Subnet Mask	255	255	255	0
ISP Gateway address	230	100	100	254
MAC address	<input type="checkbox"/> Your ISP requires you to input WAN Ethernet MAC			
Candidates	MAC address 00 - 00 - 00 - 00 - 00 - 00			
Primary DNS	168	95	192	1
Secondary DNS	168	95	1	1
RIP	disable <input checked="" type="radio"/> RIP-2B <input type="radio"/> RIP-2M			
MTU	1500			
Network address Translation	<input checked="" type="radio"/> enable <input type="radio"/> disable			

At the bottom of the form are 'Apply' and 'Reset' buttons. Below the main content area are three large buttons: 'SAVE CONFIG', 'RESTART', and 'LOGOUT'.

Step 2: Configure your WAN2 ISP settings and click **Apply**.

BILLION™ **BiGuard 50G** 802.11g Dual WAN Security Gateway Powering communications with Security

Status	<h3>WAN2</h3> <p>Static IP</p> <p>Connection Method: Static IPSetting</p> <p>IP assigned by your ISP: 213 . 100 . 100 . 2</p> <p>IP Subnet Mask: 255 . 255 . 255 . 0</p> <p>ISP Gateway address: 213 . 100 . 100 . 254</p> <p>MAC address Candidates: <input type="checkbox"/> Your ISP requires you to input WAN Ethernet MAC <input type="text" value="00"/> <input type="text" value="00"/> <input type="text" value="00"/> <input type="text" value="00"/> <input type="text" value="00"/> <input type="text" value="00"/> <input type="text" value="00"/></p> <p>Primary DNS: 168 . 95 . 192 . 1</p> <p>Secondary DNS: 168 . 95 . 1 . 1</p> <p>RIP: disable <input checked="" type="radio"/> RIP-2B <input type="radio"/> RIP-2M</p> <p>MTU: 1500</p> <p>Network address Translation: <input checked="" type="radio"/> enable <input type="radio"/> disable</p> <p><input type="button" value="Apply"/> <input type="button" value="Reset"/></p>
Quick Start	
Configuration	
LAN	
WAN	
ISP Settings	
Bandwidth Settings	
WAN IP Alias	
Dual WAN	
System	
Firewall	
VPN	
QoS	
Virtual Server	
Advanced	
Log & E-mail Alert	
Save Config to Flash	

Step 3: Go to **Configuration > Dual WAN > General Settings**. Select the **Load Balance** radio button.

BILLION™ **BiGuard 50G** 802.11g Dual WAN Security Gateway Powering communications with Security

Status	<h3>General Setting</h3> <p>Dual WAN Mode</p> <p>Mode: <input type="radio"/> Load Balance <input checked="" type="radio"/> Fail Over</p> <p>WAN Port Service Detection Policy</p> <p>Service Detection (for load balance.): <input type="radio"/> Enable <input type="radio"/> Disable</p> <p>Connectivity Decision: Not in service when probing failed after <input type="text" value="3"/> consecutive times.</p> <p>Probe Cycle: Every <input type="text" value="30"/> seconds.</p> <p>Probe WAN1: <input checked="" type="radio"/> Gateway <input type="radio"/> Host <input type="text" value="0"/> <input type="text" value="0"/> <input type="text" value="0"/> <input type="text" value="0"/></p> <p>Probe WAN2: <input checked="" type="radio"/> Gateway <input type="radio"/> Host <input type="text" value="0"/> <input type="text" value="0"/> <input type="text" value="0"/> <input type="text" value="0"/></p> <p>Failback to WAN1 when possible (for failover.): <input type="radio"/> Enable <input checked="" type="radio"/> Disable</p> <p><input type="button" value="Apply"/></p>
Quick Start	
Configuration	
LAN	
WAN	
Dual WAN	
General Setting	
Outbound Load Balance	
Inbound Load Balance	
Protocol Binding	
System	
Firewall	
VPN	
QoS	
Virtual Server	
Advanced	
Log & E-mail Alert	
Save Config to Flash	

Step 4: Go to **Configuration > Dual WAN > Outbound Load Balance**. Choose the Load Balance mechanism you want and click **Apply**.

Dual Wan

Outbound Load Balance

Load Balance Policy	<input checked="" type="radio"/> Based on session mechanism	<input type="radio"/> Balance by Session (Round Robin)
	<input type="radio"/> Based on IP address hash mechanism	<input checked="" type="radio"/> Balance by Session (weight of link capacity)
		<input type="radio"/> Balance by Session weight [] : []
		<input type="radio"/> Balance by Traffic (weight of link capacity)
		<input type="radio"/> Balance by Traffic weight [] : []
		<input checked="" type="radio"/> Balance by weight of link capacity
		<input type="radio"/> Balance by weight [] : []

Apply

Step 5: Complete. To check traffic statistics, go to **Status > Traffic Statistics**.

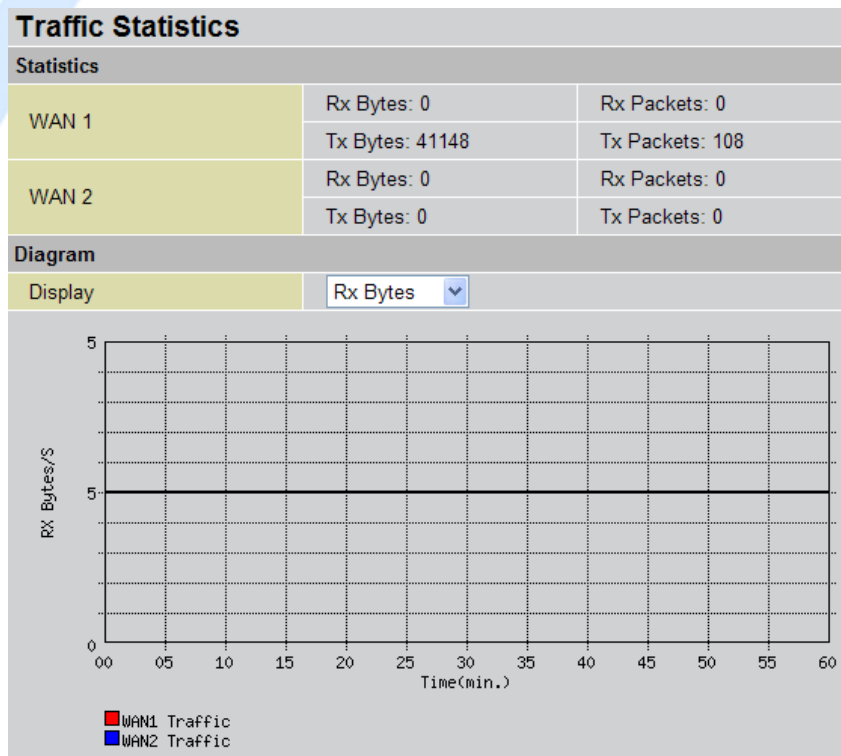

Step 6: Click **Save Config** to save all changes to flash memory.

H.3 Inbound Fail Over

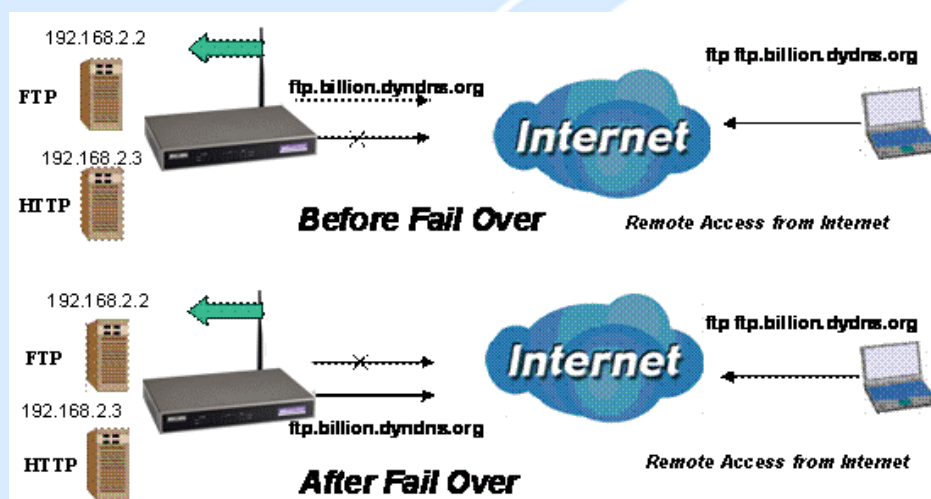

Configuring your BiGuard 50G for Inbound Fail Over is a great way to ensure a more reliable connection for incoming requests. To do so, follow these steps:

NOTE: Before you begin, ensure that both WAN1 and WAN2 have been properly configured. See *Chapter 4: Router Configuration* for more details.

Step 1: From the Web Configuration Interface, go to **Configuration > Dual WAN > General Settings**. Select the **Fail Over** radio button.

General Setting	
Dual WAN Mode	
Mode	<input type="radio"/> Load Balance <input checked="" type="radio"/> Fail Over
WAN Port Service Detection Policy	
Service Detection (for load balance.)	<input type="radio"/> Enable <input type="radio"/> Disable
Connectivity Decision	Not in service when probing failed after <input type="text" value="3"/> consecutive times.
Probe Cycle	Every <input type="text" value="30"/> seconds.
Probe WAN1	<input checked="" type="radio"/> Gateway <input type="radio"/> Host <input type="text" value="0"/> <input type="text" value="0"/> <input type="text" value="0"/> <input type="text" value="0"/>
Probe WAN2	<input checked="" type="radio"/> Gateway <input type="radio"/> Host <input type="text" value="0"/> <input type="text" value="0"/> <input type="text" value="0"/> <input type="text" value="0"/>
Failback to WAN1 when possible (for failover.)	<input type="radio"/> Enable <input checked="" type="radio"/> Disable
<input type="button" value="Apply"/>	

Step 2: Configure Fail Over options if necessary.

General Setting	
Dual WAN Mode	
Mode	<input type="radio"/> Load Balance <input checked="" type="radio"/> Fail Over
WAN Port Service Detection Policy	
Service Detection (for load balance.)	<input type="radio"/> Enable <input type="radio"/> Disable
Connectivity Decision	Not in service when probing failed after <input type="text" value="3"/> consecutive times.
Probe Cycle	Every <input type="text" value="30"/> seconds.
Probe WAN1	<input checked="" type="radio"/> Gateway <input type="radio"/> Host <input type="text" value="0"/> <input type="text" value="0"/> <input type="text" value="0"/> <input type="text" value="0"/>
Probe WAN2	<input checked="" type="radio"/> Gateway <input type="radio"/> Host <input type="text" value="0"/> <input type="text" value="0"/> <input type="text" value="0"/> <input type="text" value="0"/>
Failback to WAN1 when possible (for failover.)	<input type="radio"/> Enable <input checked="" type="radio"/> Disable
<input type="button" value="Apply"/>	

Step 3: Go to **Configuration > Advanced > Dynamic DNS**. Set the **WAN1 DDNS** settings.

Dynamic DNS Settings	
Parameters	
Dynamic DNS	<input type="radio"/> Enable <input checked="" type="radio"/> Disable
Dynamic DNS Server	<input type="text" value="NONE"/>
Wildcard	<input type="radio"/> Enable <input checked="" type="radio"/> Disable
Domain Name	<input type="text"/>
Username	<input type="text"/>
Password	<input type="text"/>
<input type="button" value="Apply"/>	

Step 4: From the same menu, set the **WAN2 DDNS** settings.

Dynamic DNS Settings	
Parameters	
Dynamic DNS	<input checked="" type="radio"/> Enable <input type="radio"/> Disable
Dynamic DNS Server	<input type="text" value="www.dyndns.org (dynamic)"/>
Wildcard	<input type="radio"/> Enable <input checked="" type="radio"/> Disable
Domain Name	<input type="text" value="ftp.billion.dyndns.org"/>
Username	<input type="text" value="username"/>
Password	<input type="text" value="*****"/>
<input type="button" value="Apply"/>	

Step 5: Click **Save Config** to save all changes to flash memory.

Dynamic DNS			
Dynamic DNS Table			
Interface	Enable	Dynamic DNS Server	
WAN1	✓	www.dyndns.org (dynamic)	Edit ▶
WAN2	✓	www.dyndns.org (dynamic)	Edit ▶

H.4 DNS Inbound Fail Over

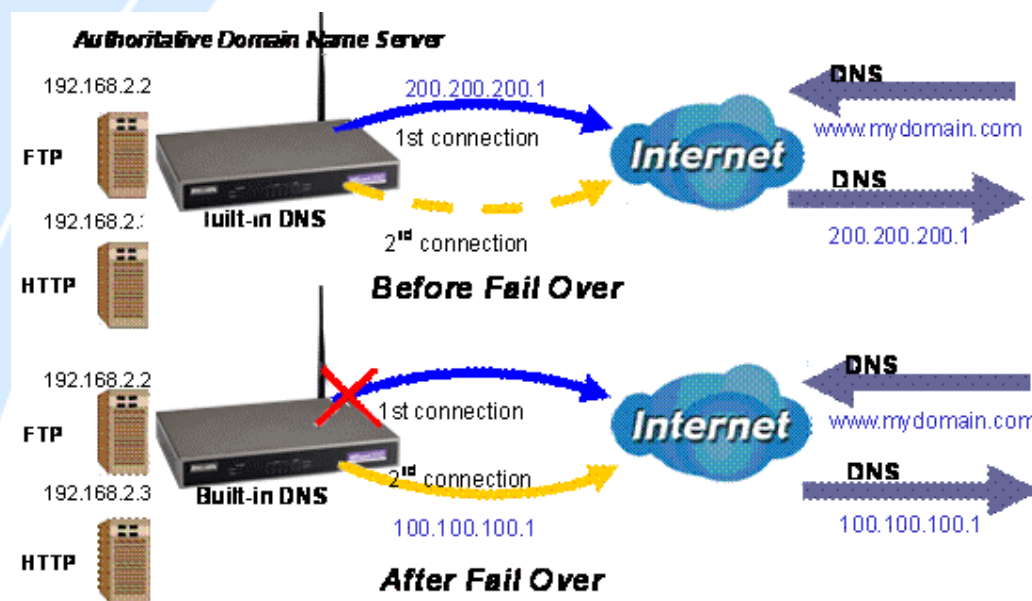

NOTE: Before proceeding, please ensure that both WAN1 and WAN2 are properly configured according to the settings provided by your ISP. If not, please refer to Chapter 4.2.2.1 ISP Settings for details on how to configure your WAN ports.

Step 1: Go to **Configuration > Dual WAN > General Settings**. Select the **Fail Over** radio button and configure your fail over policy.

General Setting

Dual WAN Mode	
Mode	<input type="radio"/> Load Balance <input checked="" type="radio"/> Fail Over
WAN Port Service Detection Policy	
Service Detection (for load balance.)	<input type="radio"/> Enable <input checked="" type="radio"/> Disable
Connectivity Decision	Not in service when probing failed after <input type="text" value="3"/> consecutive times.
Probe Cycle	Every <input type="text" value="30"/> seconds.
Probe WAN1	<input type="radio"/> Gateway <input checked="" type="radio"/> Host <input type="text" value="168"/> . <input type="text" value="95"/> . <input type="text" value="192"/> . <input type="text" value="1"/>
Probe WAN2	<input type="radio"/> Gateway <input checked="" type="radio"/> Host <input type="text" value="168"/> . <input type="text" value="95"/> . <input type="text" value="1"/> . <input type="text" value="1"/>
Failback to WAN1 when possible (for failover.)	<input type="radio"/> Enable <input checked="" type="radio"/> Disable
<input type="button" value="Apply"/>	

Step 2: Go to **Configuration > Dual WAN > Inbound Load Balance**. Select the **Enable** radio button and configure DNS Server 1 by clicking **Edit**.

Dual Wan

Inbound Load Balance		
Function	<input checked="" type="radio"/> Enable <input type="radio"/> Disable	
DNS Server 1	Server Settings	Edit
	Host URL Mappings	Edit
DNS Server 2	Server Settings	Edit
	Host URL Mappings	Edit
<input type="button" value="Apply"/>		

Step 3: Input DNS Server 1 settings and click **Apply**.

DNS Server 1

SOA

Domain Name	<input type="text" value="mydomain.com"/>
* Primary Name Server	<input type="text" value="dns"/>
Admin. Mail Box	<input type="text" value="admin@mydomain.co"/>
Serial Number	<input type="text" value="1"/>
Refresh Interval	<input type="text" value="36000"/> Sec.
Retry Interval	<input type="text" value="600"/> Sec.
Expiration Time	<input type="text" value="86400"/> Sec.
Minimum TTL	<input type="text" value="180"/> Sec.

NS Record

* Name Server	<input type="text"/>
---------------	----------------------

MX Record

* Mail Exchanger	<input type="text"/>
IP Address	<input checked="" type="radio"/> Private <input type="radio"/> Public <input type="text" value="0"/> <input type="text" value="0"/> <input type="text" value="0"/> <input type="text" value="0"/>

** : Domain will be appended automatically in these fields.*

Step 4: Configure your Host URL Mapping for DNS Server 1 by clicking **Edit** to enter the Host URL Mappings List. Click **Create** and input the settings for Host URL Mappings and click **New**.

Host URL Mappings

A Record

Domain Name	mydomain.com
* Host URL	<input type="text" value="ftp"/>
Private IP Address Candidates ▶	<input type="text" value="192"/> <input type="text" value="168"/> <input type="text" value="2"/> <input type="text" value="2"/>
Protocol	TCP ▼
Port Range Helper ▶	<input type="text" value="20"/> ~ <input type="text" value="21"/>

CNAME

* Name1	<input type="text"/>
* Name2	<input type="text"/>

** : Domain will be appended automatically in these fields.*

Step 5: Click **Save Config** to save all changes to flash memory.

H.5 DNS Inbound Load Balancing

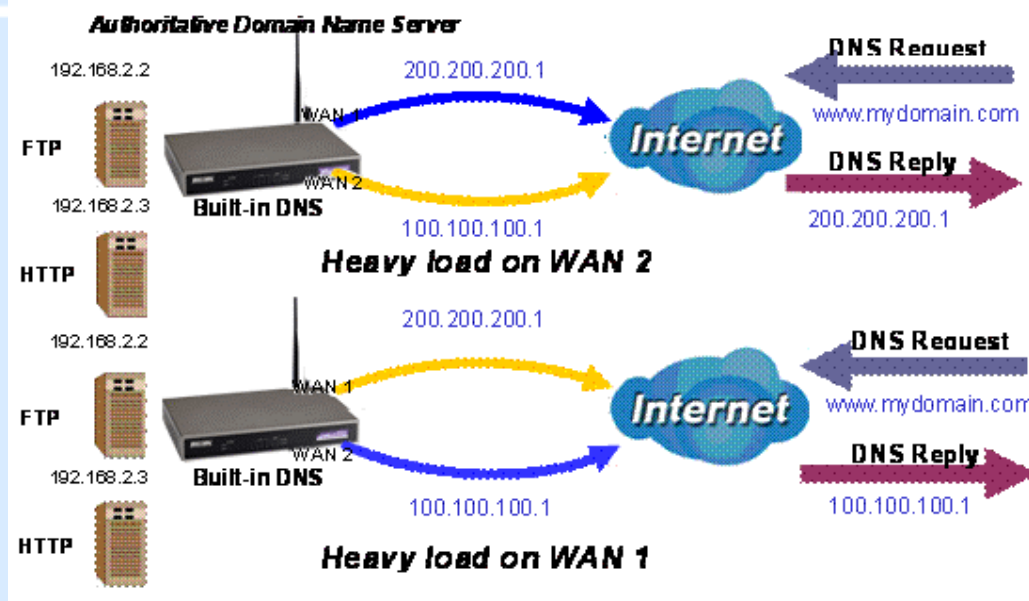

Step 1: Go to **Configuration > Dual WAN > General Settings**. Select the **Load Balance** radio button.

General Setting	
Dual WAN Mode	
Mode	<input type="radio"/> Load Balance <input checked="" type="radio"/> Fail Over
WAN Port Service Detection Policy	
Service Detection (for load balance.)	<input checked="" type="radio"/> Enable <input type="radio"/> Disable
Connectivity Decision	Not in service when probing failed after <input type="text" value="3"/> consecutive times.
Probe Cycle	Every <input type="text" value="30"/> seconds.
Probe WAN1	<input checked="" type="radio"/> Gateway <input type="radio"/> Host <input type="text" value="0"/> <input type="text" value="0"/> <input type="text" value="0"/> <input type="text" value="0"/>
Probe WAN2	<input checked="" type="radio"/> Gateway <input type="radio"/> Host <input type="text" value="0"/> <input type="text" value="0"/> <input type="text" value="0"/> <input type="text" value="0"/>
Failback to WAN1 when possible (for failover.)	<input type="radio"/> Enable <input checked="" type="radio"/> Disable
<input type="button" value="Apply"/>	

Step 2: Go to **Configuration > Dual WAN > Inbound Load Balance > Server Settings** and configure DNS Server 1.

DNS Server 1

SOA

Domain Name	<input type="text" value="mydomain.com"/>
* Primary Name Server	<input type="text" value="dns"/>
Admin. Mail Box	<input type="text" value="admin@mydomain.co"/>
Serial Number	<input type="text" value="1"/>
Refresh Interval	<input type="text" value="36000"/> Sec.
Retry Interval	<input type="text" value="600"/> Sec.
Expiration Time	<input type="text" value="86400"/> Sec.
Minimum TTL	<input type="text" value="180"/> Sec.

NS Record

* Name Server	<input type="text"/>
---------------	----------------------

MX Record

* Mail Exchanger	<input type="text"/>
IP Address	<input checked="" type="radio"/> Private <input type="radio"/> Public <input type="text" value="0"/> <input type="text" value="0"/> <input type="text" value="0"/> <input type="text" value="0"/>

* : Domain will be appended automatically in these fields.

Step 3: Go to **Configuration > Dual WAN > Inbound Load Balance > Host URL Mapping** and configure your FTP mapping.

Host URL Mappings

A Record

Domain Name	<input type="text" value="mydomain.com"/>
* Host URL	<input type="text" value="ftp"/>
Private IP Address Candidates ▶	<input type="text" value="192"/> <input type="text" value="168"/> <input type="text" value="2"/> <input type="text" value="2"/>
Protocol	<input type="text" value="TCP"/>
Port Range Helper ▶	<input type="text" value="20"/> ~ <input type="text" value="21"/>

CNAME

* Name1	<input type="text"/>
* Name2	<input type="text"/>

* : Domain will be appended automatically in these fields.

Step 4: Next configure your HTTP mapping.

Host URL Mappings	
A Record	
Domain Name	mydomain.com
* Host URL	www
Private IP Address Candidates ▶	192 . 168 . 2 . 3
Protocol	TCP ▼
Port Range Helper ▶	80 ~ 80
CNAME	
* Name1	<input type="text"/>
* Name2	<input type="text"/>
* : Domain will be appended automatically in these fields.	
<input type="button" value="Apply"/>	

Step 5: Click **Save Config** to save all changes to flash memory.

H.6 Dynamic DNS Inbound Load Balancing



Step 1: Go to **Configuration > WAN > Bandwidth Settings**. Configure your WAN inbound and outbound bandwidth.

Bandwidth Settings

Max Bandwidth Provided by ISP

WAN 1	Outbound Bandwidth	<input type="text" value="102400"/>	kbps
	Inbound Bandwidth	<input type="text" value="102400"/>	kbps
WAN 2	Outbound Bandwidth	<input type="text" value="5120"/>	kbps
	Inbound Bandwidth	<input type="text" value="5120"/>	kbps

( These bandwidth settings will be referenced by QoS and Loadbalance functions.)

Step 2: Go to **Configuration > Dual WAN > General Settings** and enable **Load Balance** mode. You may then decide whether to enable Service Detection or not.

General Setting

Dual WAN Mode

Mode Load Balance Fail Over

WAN Port Service Detection Policy

Service Detection (for load balance.) Enable Disable

Connectivity Decision Not in service when probing failed after consecutive times.

Probe Cycle Every seconds.

Probe WAN1 Gateway
 Host

Probe WAN2 Gateway
 Host

Failback to WAN1 when possible (for failover.) Enable Disable

Step 3: Go to **Configuration > Dual WAN > Outbound Load Balance**. Choose your load balance policy and click **Apply** to apply your changes. If you selected Based on session mechanism as your policy, the source IP address and destination IP address may go through WAN1 or WAN2 depending on policy settings. If you selected Based on IP hash mechanism as your policy, the source IP address and destination IP address will go through a specific WAN port according to the IP hash algorithm.

Dual Wan

Outbound Load Balance

Load Balance Policy	<input checked="" type="radio"/> Based on session mechanism	<input type="radio"/> Balance by Session (Round Robin) <input checked="" type="radio"/> Balance by Session (weight of link capacity) <input type="radio"/> Balance by Session weight [] : [] <input type="radio"/> Balance by Traffic (weight of link capacity) <input type="radio"/> Balance by Traffic weight [] : []
	<input type="radio"/> Based on IP address hash mechanism	<input checked="" type="radio"/> Balance by weight of link capacity <input type="radio"/> Balance by weight [] : []

Step 4: Go to **Configuration > Advanced > Dynamic DNS** and input the dynamic DNS settings for WAN1 and WAN2.

Dynamic DNS

Dynamic DNS Table

Interface	Enable	Dynamic DNS Server	
WAN1	✓	www.dyndns.org (dynamic)	Edit ▶
WAN2	✓	www.dyndns.org (dynamic)	Edit ▶

WAN1:

Dynamic DNS Settings

Parameters

Dynamic DNS	<input checked="" type="radio"/> Enable <input type="radio"/> Disable
Dynamic DNS Server	www.dyndns.org (dynamic) ▼
Wildcard	<input type="radio"/> Enable <input checked="" type="radio"/> Disable
Domain Name	www.billion2.dyndns.org
Username	username
Password	••••

WAN 2:

Dynamic DNS Settings

Parameters

Dynamic DNS	<input checked="" type="radio"/> Enable <input type="radio"/> Disable
Dynamic DNS Server	www.dyndns.org (dynamic) ▼
Wildcard	<input type="radio"/> Enable <input checked="" type="radio"/> Disable
Domain Name	www.billion3.dyndns.org
Username	username
Password	••••

Step 5: Go to **Configuration > Virtual Server** and set up a virtual server for both FTP and HTTP.

Virtual Server				
Add Forwarding Rule				
Application Helper ▶	FTP			
Protocol	TCP ▼			
External Port	20	~	21	
Redirect Port	20	~	21	
Internal IP Address Candidates ▶	192	.	168	.1 .2
<input type="button" value="Apply"/>				

Virtual Server				
Add Forwarding Rule				
Application Helper ▶	HTTP			
Protocol	TCP ▼			
External Port	80	~	80	
Redirect Port	80	~	80	
Internal IP Address Candidates ▶	192	.	168	.1 .3
<input type="button" value="Apply"/>				

Step 6: Click **Save Config** to save all changes to flash memory.

H.7 VPN Configuration

This section outlines some concrete examples on how you can configure BiGuard 50G for your VPN.

H.7.1 LAN to LAN

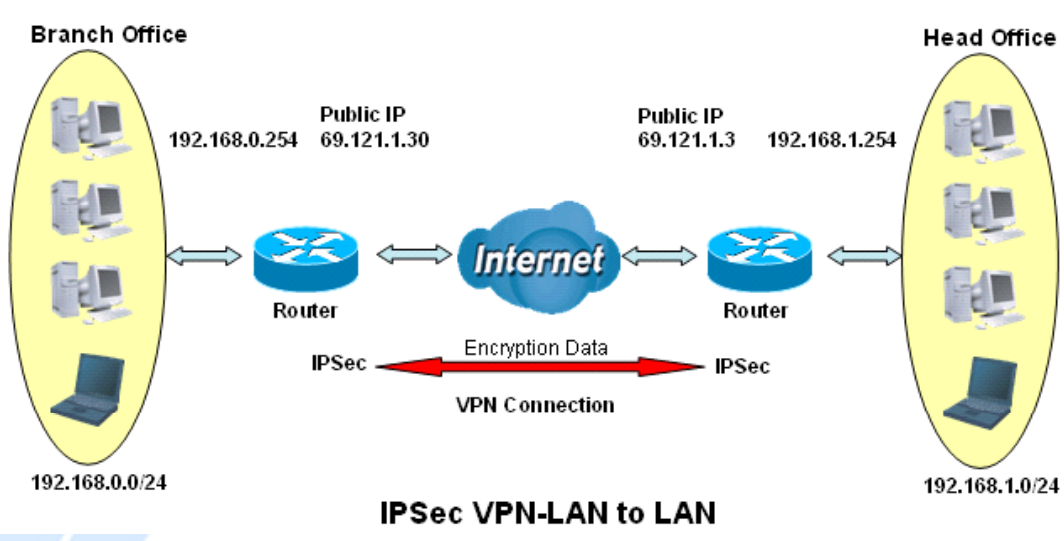

	Branch Office	Head Office
Local		
ID	IP Address	IP Address
Data	69.121.1.30	69.121.1.3
Network	Any Local Address	Any Local Address
IP Address	192.168.0.0	192.168.1.0
Netmask	255.255.255.0	255.255.255.0
Remote		
Secure Gateway Address(or Hostname)	69.121.1.3	69.121.1.30
ID	IP Address	IP Address
Data	69.121.1.3	69.121.1.30
Network	Subnet	Subnet
IP Address	192.168.1.0	192.168.0.0
Netmask	255.255.255.0	255.255.255.0

Proposal		
IKE Pre-shared Key	12345678	12345678
Security Algorithm	Main Mode; ESP: MD5 3DES PFS	Main ESP MD5 3DES PFS

H.7.2 Host to LAN

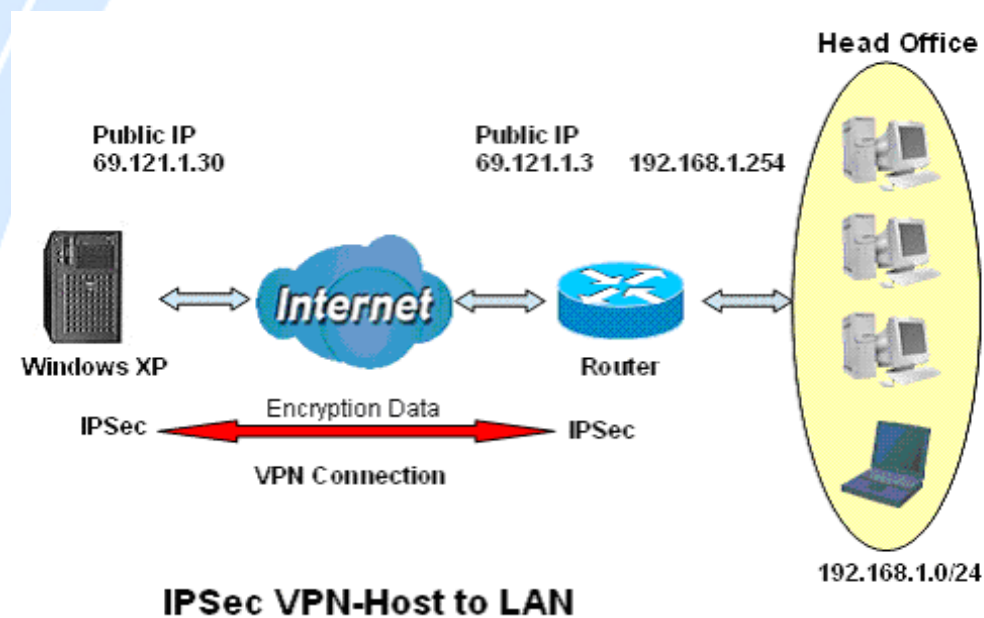

	Single client	Head Office
Local		
ID	IP Address	IP Address
Data	69.121.1.30	69.121.1.3
Network	Any Local Address	Any Local Address

IP Address	0.0.0.0	192.168.1.0
Netmask	0.0.0.0	255.255.255.0
Remote		
Secure Gateway Address(or Hostname)	69.121.1.3	69.121.1.30
ID	IP Address	IP Address
Data	69.121.1.3	69.121.1.30
Network	Subnet	Single Address
IP Address	192.168.1.0	69.121.1.30
Netmask	255.255.255.0	255.255.255.255
Proposal		
IKE Pre-shared Key	12345678	12345678
Security Algorithm	Main Mode; ESP: MD5 3DES PFS	Main ESP MD5 3DES PFS

H.8 IP Sec Fail Over (Gateway to Gateway)

biguard.billion.com

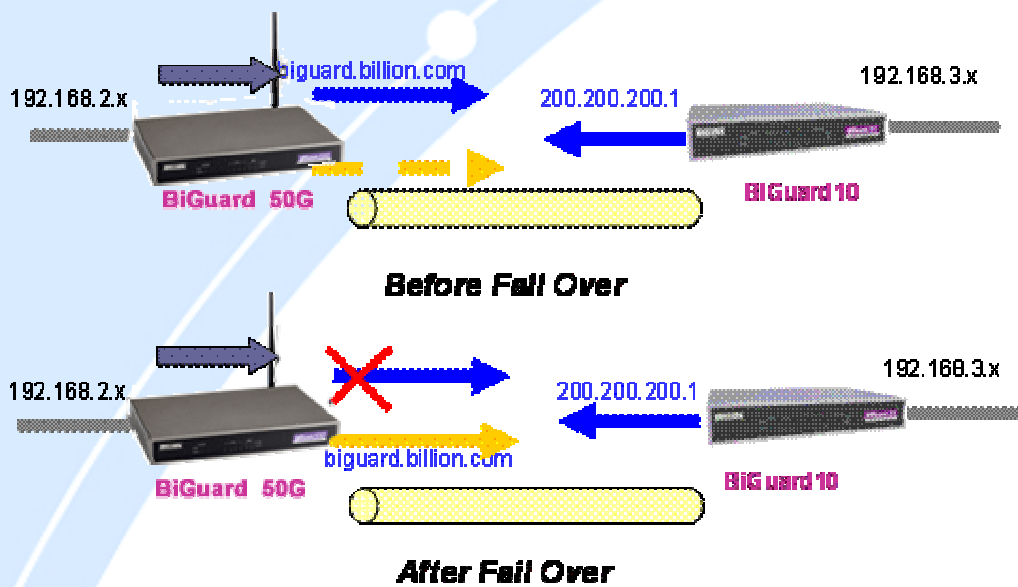

Step 1: Go to **Configuration > Dual WAN > General Settings**. Enable Fail Over by selecting the **Fail Over** radio button. Then, configure your Fail Over policy.

General Setting	
Dual WAN Mode	
Mode	<input type="radio"/> Load Balance <input checked="" type="radio"/> Fail Over
WAN Port Service Detection Policy	
Service Detection (for load balance.)	<input checked="" type="radio"/> Enable <input type="radio"/> Disable
Connectivity Decision	Not in service when probing failed after <input type="text" value="3"/> consecutive times.
Probe Cycle	Every <input type="text" value="30"/> seconds.
Probe WAN1	<input type="radio"/> Gateway <input checked="" type="radio"/> Host <input type="text" value="168"/> <input type="text" value="95"/> <input type="text" value="192"/> <input type="text" value="1"/>
Probe WAN2	<input type="radio"/> Gateway <input checked="" type="radio"/> Host <input type="text" value="168"/> <input type="text" value="95"/> <input type="text" value="1"/> <input type="text" value="1"/>
Failback to WAN1 when possible (for failover.)	<input type="radio"/> Enable <input checked="" type="radio"/> Disable
<input type="button" value="Apply"/>	

Step 2: Go to **Configuration > Advanced > Dynamic DNS** and configure your dynamic DNS settings (Both WAN1 and WAN2).

Dynamic DNS Settings

Parameters

Dynamic DNS	<input checked="" type="radio"/> Enable <input type="radio"/> Disable
Dynamic DNS Server	www.dyndns.org (dynamic) ▾
Wildcard	<input type="radio"/> Enable <input checked="" type="radio"/> Disable
Domain Name	biguard.billion.com
Username	username
Password	••••••••
<input type="button" value="Apply"/>	

Step 3: Go to **Configuration > VPN > IPSec > IPSec Policy**. Click **Create** to configure VPN settings.

Connection Name	biguard		
Tunnel	<input checked="" type="radio"/> Enabled <input type="radio"/> Disabled		
Interface	<input type="radio"/> WAN1 <input type="radio"/> WAN2 <input checked="" type="radio"/> Auto		
Local			
ID	FQDN (DNS) ▾	Data	biguard.billion.com
Network	Subnet ▾	IP Address	192 . 168 . 2 . 0
		End IP Address	0 . 0 . 0 . 0
		Netmask	255 . 255 . 255 . 0
Remote			
Secure Gateway	IP Address/ Hostname ▾	Data	200.200.200.1
ID	Remote WAN IP ▾	Data	200.200.200.1
Network	Subnet ▾	IP Address	192 . 168 . 3 . 0
		End IP Address	0 . 0 . 0 . 0
		Netmask	255 . 255 . 255 . 0
Proposal			
Secure Association	<input checked="" type="radio"/> Main Mode <input type="radio"/> Aggressive Mode <input type="radio"/> Manual Key		
Method	<input checked="" type="radio"/> ESP <input type="radio"/> AH		
Encryption Protocol	3DES ▾		
Authentication Protocol	MD5 ▾		
Perfect Forward Secure	<input checked="" type="radio"/> Enabled <input type="radio"/> Disabled		
PreShared Key	12345678		
IKE Life Time	28800	Seconds	
Key Life Time	3600	Seconds	
Netbios Broadcast	<input type="radio"/> Enabled <input checked="" type="radio"/> Disabled		

Step 4: Click **Save Config** to save all changes to flash memory.
To configure BiGuard 10 gateway, refer to the screenshot below.

Connection Name	biguard		
Tunnel	<input checked="" type="radio"/> Enabled <input type="radio"/> Disabled		
Local			
ID	IP Address	Data	200.200.200.1
Network	Subnet	IP Address	192 . 168 . 3 . 0
		End IP Address	0 . 0 . 0 . 0
		Netmask	255 . 255 . 255 . 0
Remote			
Secure Gateway	IP Address/ Hostname	Data	biguard.billion.com
ID	FQDN (DNS)	Data	biguard.billion.com
Network	Subnet	IP Address	192 . 168 . 2 . 0
		End IP Address	0 . 0 . 0 . 0
		Netmask	255 . 255 . 255 . 0
Proposal			
Secure Association	<input checked="" type="radio"/> Main Mode <input type="radio"/> Aggressive Mode <input type="radio"/> Manual Key		
Method	<input checked="" type="radio"/> ESP <input type="radio"/> AH		
Encryption Protocol	3DES		
Authentication Protocol	MD5		
Perfect Forward Secure	<input checked="" type="radio"/> Enabled <input type="radio"/> Disabled		
PreShared Key	12345678		
IKE Life Time	28800	Seconds	
Key Life Time	3600	Seconds	
Netbios Broadcast	<input type="radio"/> Enabled <input checked="" type="radio"/> Disabled		
Apply			

H.9 VPN Concentrator

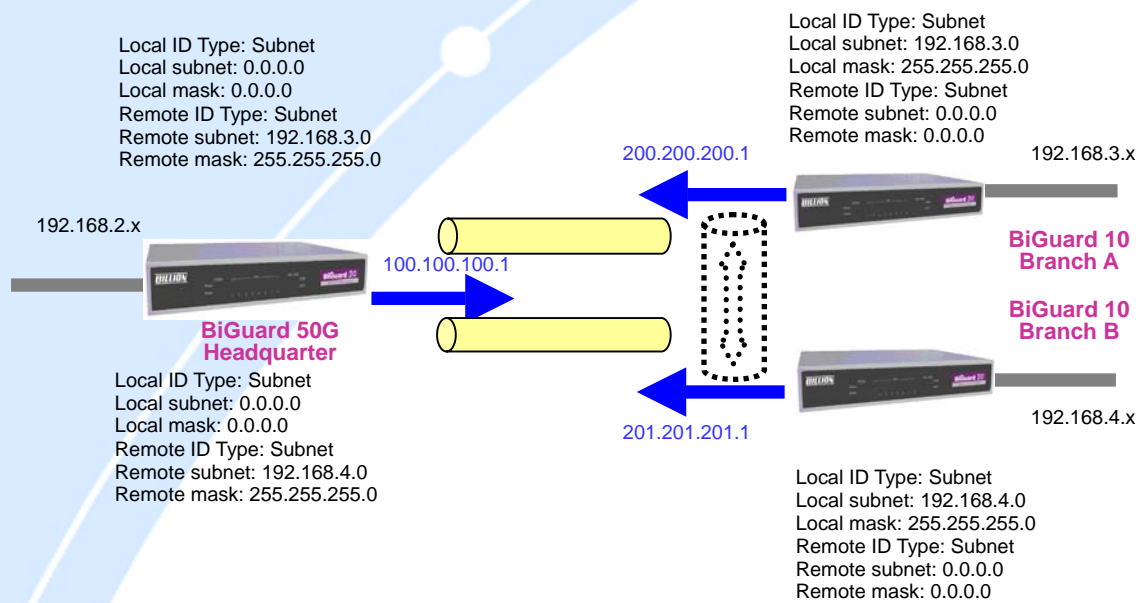

Step 1: Go to **Configuration > VPN > IPSec > IPSec Policy** and configure the link from BiGuard 50G to BiGuard 10 Branch A.

Connection Name	<input type="text" value="test1"/>		
Tunnel	<input checked="" type="radio"/> Enabled <input type="radio"/> Disabled		
Interface	<input checked="" type="radio"/> WAN1 <input type="radio"/> WAN2 <input type="radio"/> Auto		
Local			
ID	<input type="text" value="IP Address"/>	Data	<input type="text" value="100.100.100.1"/>
Network	<input type="text" value="Subnet"/>	IP Address	<input type="text" value="0"/> <input type="text" value="0"/> <input type="text" value="0"/> <input type="text" value="0"/>
		End IP Address	<input type="text" value="0"/> <input type="text" value="0"/> <input type="text" value="0"/> <input type="text" value="0"/>
		Netmask	<input type="text" value="0"/> <input type="text" value="0"/> <input type="text" value="0"/> <input type="text" value="0"/>
Remote			
Secure Gateway	<input type="text" value="IP Address/ Hostname"/>	Data	<input type="text" value="200.200.200.1"/>
ID	<input type="text" value="Remote WAN IP"/>	Data	<input type="text" value="200.200.200.1"/>
Network	<input type="text" value="Subnet"/>	IP Address	<input type="text" value="192"/> <input type="text" value="168"/> <input type="text" value="3"/> <input type="text" value="0"/>
		End IP Address	<input type="text" value="0"/> <input type="text" value="0"/> <input type="text" value="0"/> <input type="text" value="0"/>
		Netmask	<input type="text" value="255"/> <input type="text" value="255"/> <input type="text" value="255"/> <input type="text" value="0"/>
Proposal			
Secure Association	<input checked="" type="radio"/> Main Mode <input type="radio"/> Aggressive Mode <input type="radio"/> Manual Key		
Method	<input checked="" type="radio"/> ESP <input type="radio"/> AH		
Encryption Protocol	<input type="text" value="3DES"/>		
Authentication Protocol	<input type="text" value="MD5"/>		
Perfect Forward Secure	<input checked="" type="radio"/> Enabled <input type="radio"/> Disabled		
PreShared Key	<input type="text" value="12345678"/>		
IKE Life Time	<input type="text" value="28800"/>	Seconds	
Key Life Time	<input type="text" value="3600"/>	Seconds	
Netbios Broadcast	<input type="radio"/> Enabled <input checked="" type="radio"/> Disabled		

Step 2: Go to **Configuration > VPN > IPSec > IPSec Policy** and configure the link from BiGuard 50G to BiGuard 10 Branch B.

Connection Name	test2		
Tunnel	<input checked="" type="radio"/> Enabled <input type="radio"/> Disabled		
Interface	<input checked="" type="radio"/> WAN1 <input type="radio"/> WAN2 <input type="radio"/> Auto		
Local			
ID	IP Address	Data	100.100.100.1
Network	Subnet	IP Address	0 . 0 . 0 . 0
		End IP Address	0 . 0 . 0 . 0
		Netmask	0 . 0 . 0 . 0
Remote			
Secure Gateway	IP Address/ Hostname	Data	201.201.201.1
ID	Remote WAN IP	Data	201.201.201.1
Network	Subnet	IP Address	192 . 168 . 4 . 0
		End IP Address	0 . 0 . 0 . 0
		Netmask	255 . 255 . 255 . 0
Proposal			
Secure Association	<input checked="" type="radio"/> Main Mode <input type="radio"/> Aggressive Mode <input type="radio"/> Manual Key		
Method	<input checked="" type="radio"/> ESP <input type="radio"/> AH		
Encryption Protocol	3DES		
Authentication Protocol	MD5		
Perfect Forward Secure	<input checked="" type="radio"/> Enabled <input type="radio"/> Disabled		
PreShared Key	12345678		
IKE Life Time	28800	Seconds	
Key Life Time	3600	Seconds	
Netbios Broadcast	<input type="radio"/> Enabled <input checked="" type="radio"/> Disabled		

Step 3: Go to **Configuration > VPN > IPSec > IPSec Policy** and configure the connection from BiGuard 10 Branch A to BiGuard 50G.

Connection Name	test1		
Tunnel	<input checked="" type="radio"/> Enabled <input type="radio"/> Disabled		
Local			
ID	IP Address	Data	200.200.200.1
Network	Subnet	IP Address	192 . 168 . 3 . 0
		End IP Address	0 . 0 . 0 . 0
		Netmask	255 . 255 . 255 . 0
Remote			
Secure Gateway	IP Address/ Hostname	Data	100.100.100.1
ID	Remote WAN IP	Data	100.100.100.1
Network	Subnet	IP Address	0 . 0 . 0 . 0
		End IP Address	0 . 0 . 0 . 0
		Netmask	0 . 0 . 0 . 0
Proposal			
Secure Association	<input checked="" type="radio"/> Main Mode <input type="radio"/> Aggressive Mode <input type="radio"/> Manual Key		
Method	<input checked="" type="radio"/> ESP <input type="radio"/> AH		
Encryption Protocol	3DES		
Authentication Protocol	MD5		
Perfect Forward Secure	<input checked="" type="radio"/> Enabled <input type="radio"/> Disabled		
PreShared Key	12345678		
IKE Life Time	28800	Seconds	
Key Life Time	3600	Seconds	
Netbios Broadcast	<input type="radio"/> Enabled <input checked="" type="radio"/> Disabled		
Apply			

Step 4: Go to **Configuration > VPN > IPSec > IPSec Policy** and configure the connection from BiGuard 10 Branch B to BiGuard 50G.

Connection Name	test2		
Tunnel	<input checked="" type="radio"/> Enabled <input type="radio"/> Disabled		
Interface	<input checked="" type="radio"/> WAN1 <input type="radio"/> WAN2 <input type="radio"/> Auto		
Local			
ID	IP Address	Data	100.100.100.1
Network	Subnet	IP Address	0 . 0 . 0 . 0
		End IP Address	0 . 0 . 0 . 0
		Netmask	0 . 0 . 0 . 0
Remote			
Secure Gateway	IP Address/ Hostname	Data	201.201.201.1
ID	Remote WAN IP	Data	201.201.201.1
Network	Subnet	IP Address	192 . 168 . 4 . 0
		End IP Address	0 . 0 . 0 . 0
		Netmask	255 . 255 . 255 . 0
Proposal			
Secure Association	<input checked="" type="radio"/> Main Mode <input type="radio"/> Aggressive Mode <input type="radio"/> Manual Key		
Method	<input checked="" type="radio"/> ESP <input type="radio"/> AH		
Encryption Protocol	3DES		
Authentication Protocol	MD5		
Perfect Forward Secure	<input checked="" type="radio"/> Enabled <input type="radio"/> Disabled		
PreShared Key	12345678		
IKE Life Time	28800	Seconds	
Key Life Time	3600	Seconds	
Netbios Broadcast	<input type="radio"/> Enabled <input checked="" type="radio"/> Disabled		

Step 5: Click **Save Config** to save all changes to flash memory.

H.10 Protocol Binding

Step 1: Go to **Configuration > Dual WAN > General Settings**. Select the **Load Balancing** radio button.

General Setting

Dual WAN Mode

Mode Load Balance Fail Over

WAN Port Service Detection Policy

Service Detection (for load balance.) Enable Disable

Connectivity Decision Not in service when probing failed after consecutive times.

Probe Cycle Every seconds.

Probe WAN1 Gateway

Host

Probe WAN2 Gateway

Host

Failback to WAN1 when possible (for failover.) Enable Disable

Apply

Step 2: Go to **Configuration > Dual WAN > Protocol Binding** and configure settings for WAN1.

Protocol Binding

Add Protocol Binding Rules

Interface

Source IP Range All Source IP Specified Source IP

Source IP Address

Source IP Netmask

Destination IP Range All Destination IP Specified Destination IP

Destination IP Address

Destination IP Netmask

Protocol

Port Range [Helper](#) ~

( Protocol Binding has higher priority than Routing.)

Apply

Step 3: Go to **Configuration > Dual WAN > Protocol Binding** and configure settings for WAN2.

Protocol Binding	
Add Protocol Binding Rules	
Interface	WAN 2
Source IP Range	<input type="radio"/> All Source IP <input checked="" type="radio"/> Specified Source IP
Source IP Address	192 . 168 . 2 . 3
Source IP Netmask	255 . 255 . 255 . 255
Destination IP Range	<input checked="" type="radio"/> All Destination IP <input type="radio"/> Specified Destination IP
Destination IP Address	0 . 0 . 0 . 0
Destination IP Netmask	0 . 0 . 0 . 0
Protocol	TCP
Port Range Helper	20 ~ 21
(Protocol Binding has higher priority than Routing.)	
<input type="button" value="Apply"/>	

Step 4: Click **Save Config** to save all changes to flash memory.

H.11 Intrusion Detection

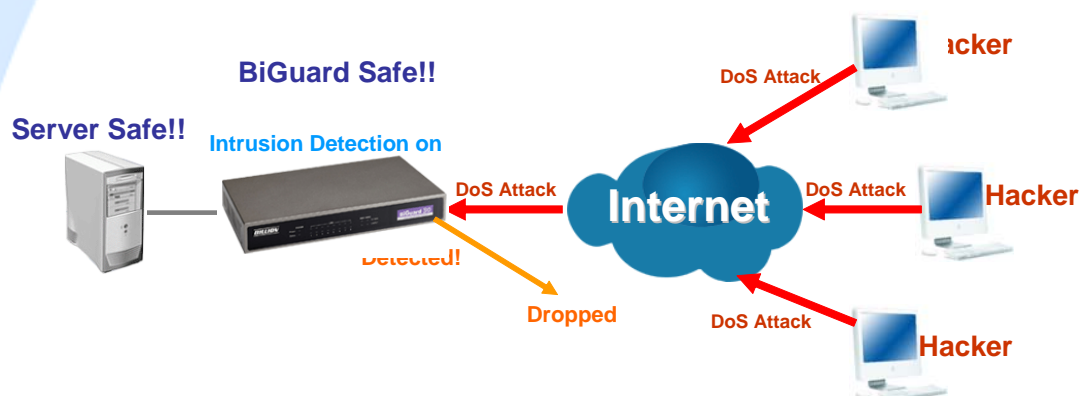

Step 1: Go to **Configuration > Firewall > Intrusion Detection** and Enable the settings.

Intrusion Detection	
Enable for preventing hacker attack from Internet.	
Intrusion Detection	<input type="radio"/> Enable <input checked="" type="radio"/> Disable
Intrusion Log	<input type="radio"/> Enable <input checked="" type="radio"/> Disable
ARP Protection	<input checked="" type="radio"/> Disable <input type="radio"/> Enable
Session Limit	<input checked="" type="radio"/> No Limit
	<input type="radio"/> Limit maximum sessions per IP to <input type="text" value="200"/>
	<input type="radio"/> Limit maximum sessions per IP to <input type="text" value="200"/>
	<input checked="" type="radio"/> , reject new session from this IP in <input type="text" value="5"/> minutes. <input type="radio"/> , drop all packets from this IP in <input type="text" value="5"/> minutes.
<input type="button" value="Apply"/>	

Step 2: Click **Apply** and then **Save Config** to save all changes to flash memory.

H.12 PPTP Remote Access by Windows XP

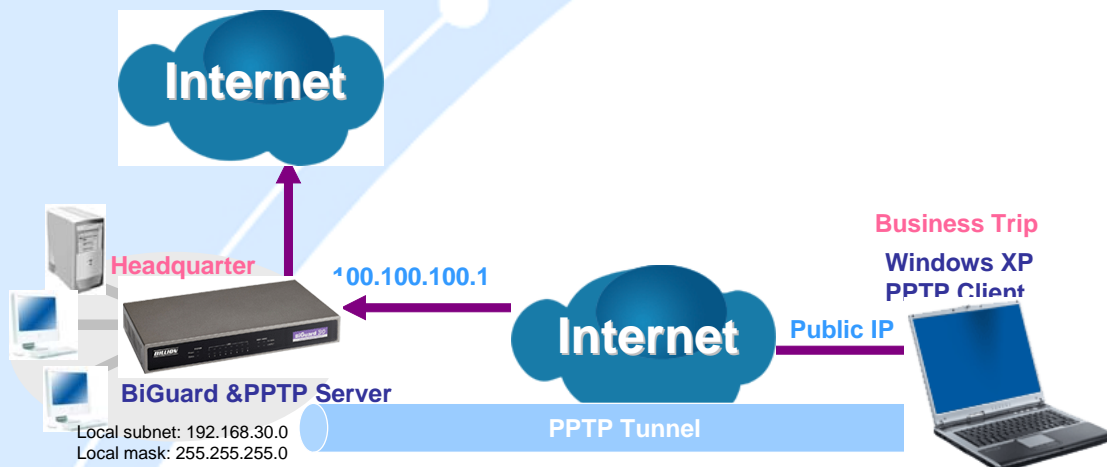

Step1: Go to **Configuration > VPN > PPTP** and Enable the PPTP function, Click **Apply**.

PPTP			
General Setting			
PPTP function	<input type="radio"/> Enable <input checked="" type="radio"/> Disable		
Auth. Type	Pap or Chap ▾		
Data Encryption	Enable ▾		
Encryption Key Length	Auto ▾		
Peer Encryption Mode	Only Stateless ▾		
IP Addresses Assigned to Peer	start from: 192.168.1.200		
Idle Timeout	0 Min.		
(⚠ Enable data encryption will use MS-CHAPv2 to authenticate the peer.)			
<input type="button" value="Apply"/>			
Account Setting			
Name	Enable	Type	Peer Network
<input type="button" value="Create"/>			

Step2: Click **Create** to create a PPTP Account.

PPTP

Add PPTP Account

Connection Name	<input type="text" value="WinXP"/>
Tunnel	<input checked="" type="radio"/> Enable <input type="radio"/> Disable
Username	<input type="text" value="test"/>
Password	<input type="password" value="••••"/>
Retype Password	<input type="password"/>
Connection Type	<input checked="" type="radio"/> Remote Access <input type="radio"/> LAN to LAN
Peer Network IP	<input type="text"/> . <input type="text"/> . <input type="text"/> . <input type="text"/>
Peer Netmask	<input type="text"/> . <input type="text"/> . <input type="text"/> . <input type="text"/>
Netbios Broadcast	<input checked="" type="radio"/> Enable <input type="radio"/> Disable

Step3: Click **Apply**, you can see the account is successfully created.

PPTP

General Setting

PPTP function	<input type="radio"/> Enable <input checked="" type="radio"/> Disable
Auth. Type	<input type="text" value="Pap or Chap"/>
Data Encryption	<input type="text" value="Enable"/>
Encryption Key Length	<input type="text" value="Auto"/>
Peer Encryption Mode	<input type="text" value="Only Stateless"/>
IP Addresses Assigned to Peer	start from: <input type="text" value="192.168.1.200"/>
Idle Timeout	<input type="text" value="0"/> Min.

( Enable data encryption will use MS-CHAPv2 to authenticate the peer.)

Account Setting

Name	Enable	Type	Peer Network		
WinXP	<input checked="" type="checkbox"/>	Remote Access	-----	Edit	Delete

[Create](#)

Step4: Click **Save Config** to save all changes to flash memory.

Step5: In Windows XP, go **Start > Settings > Network Connections**.

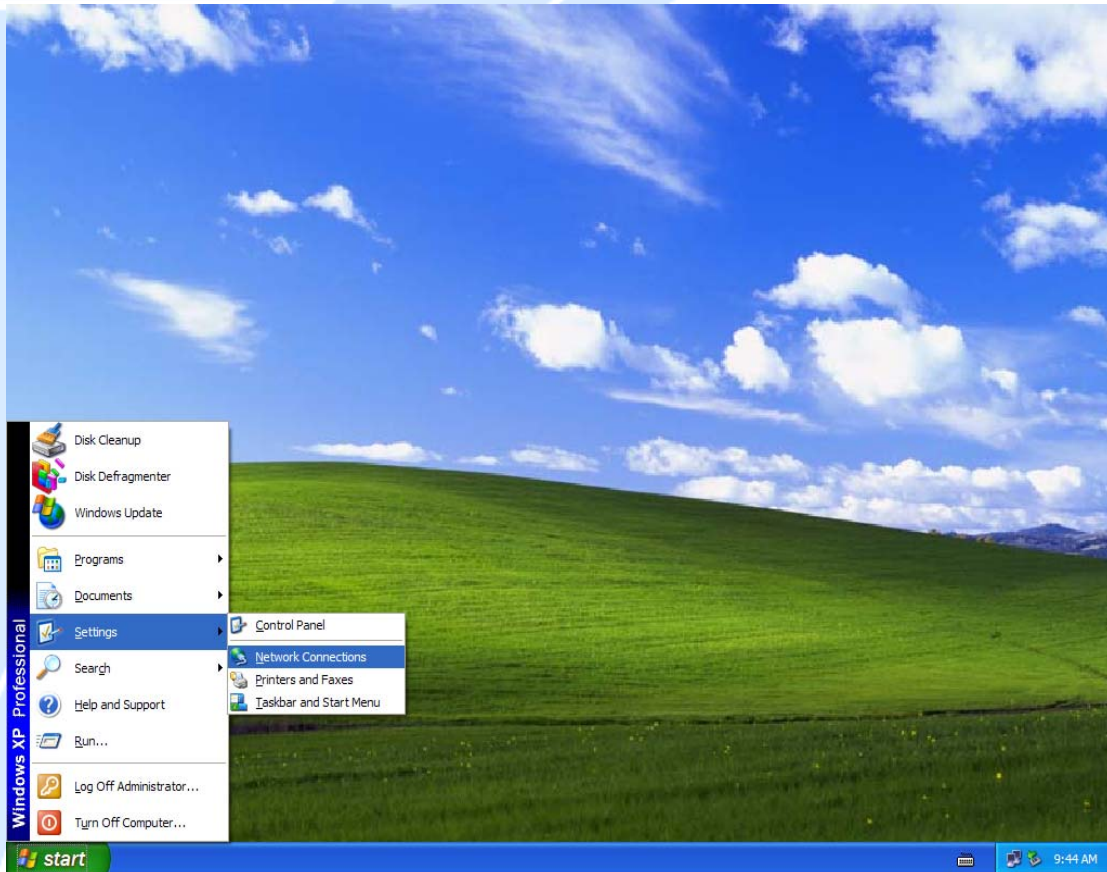

Step6: In **Network Tasks**, Click **Create a new connection**, and press **Next**.

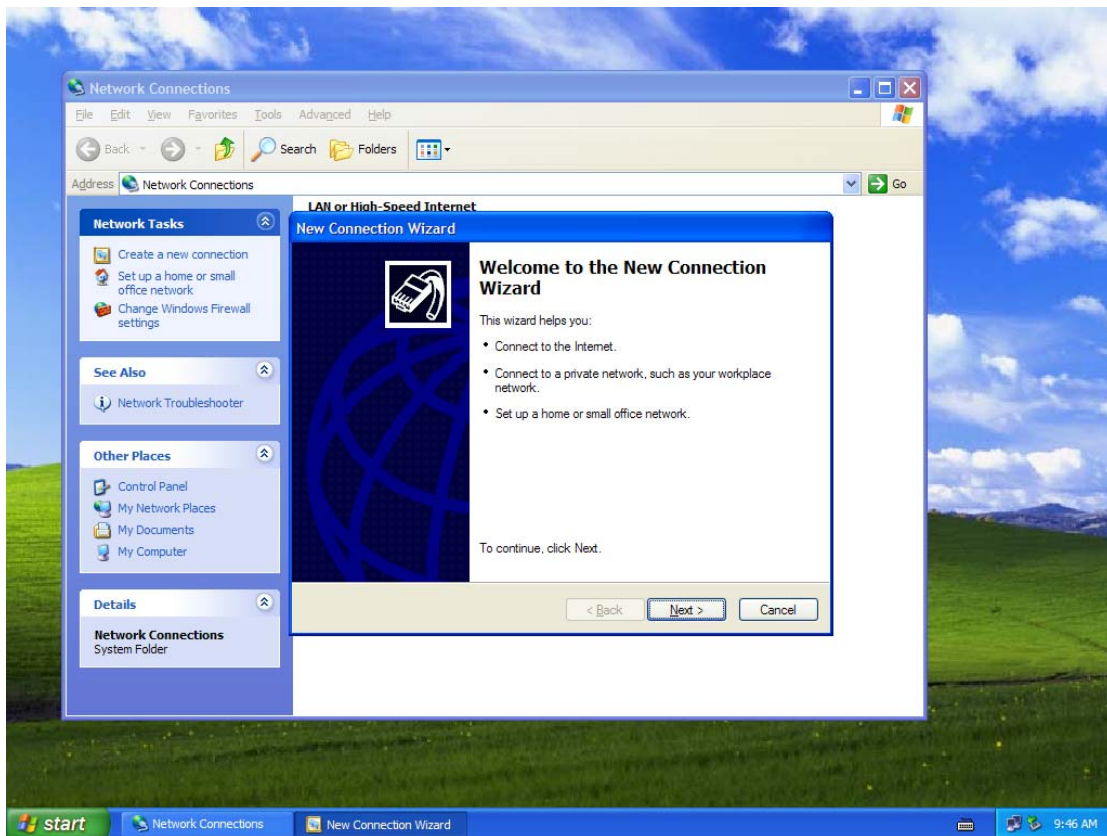

Step7: Select **Connect to the network at my workplace** and press **Next**.

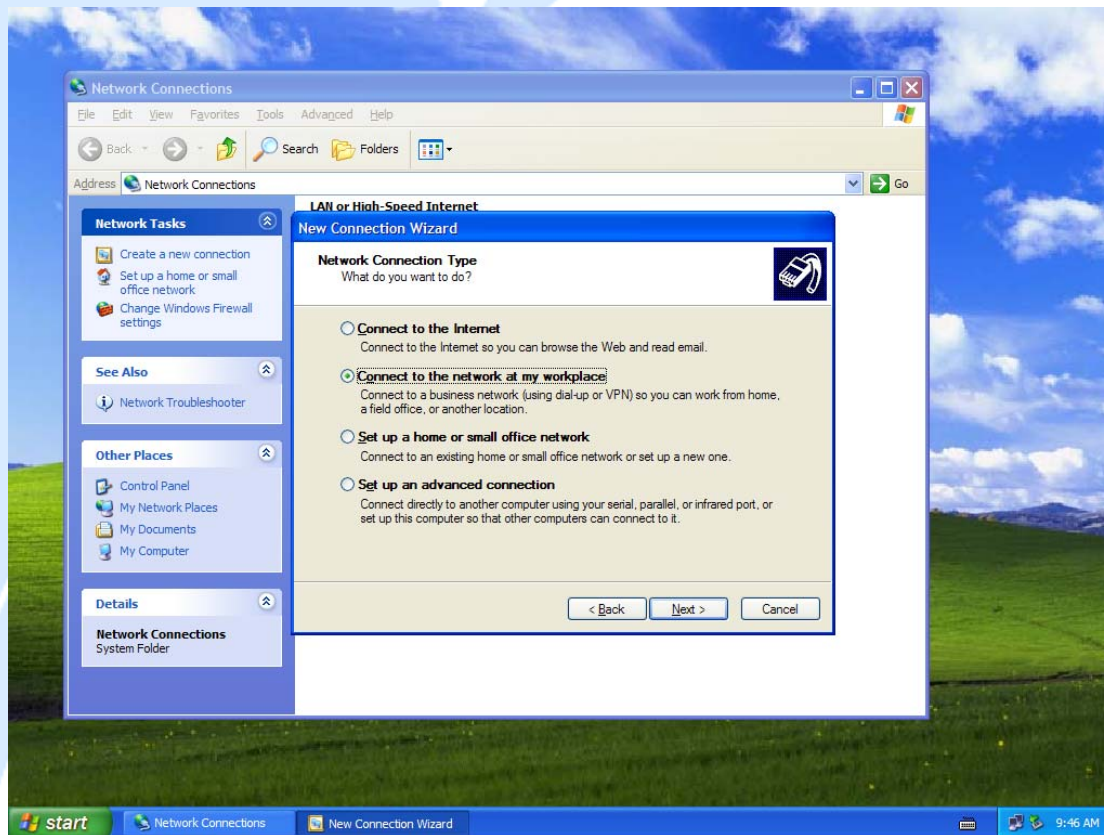

Step8: Select **Virtual Private Network connection** and press **Next**.

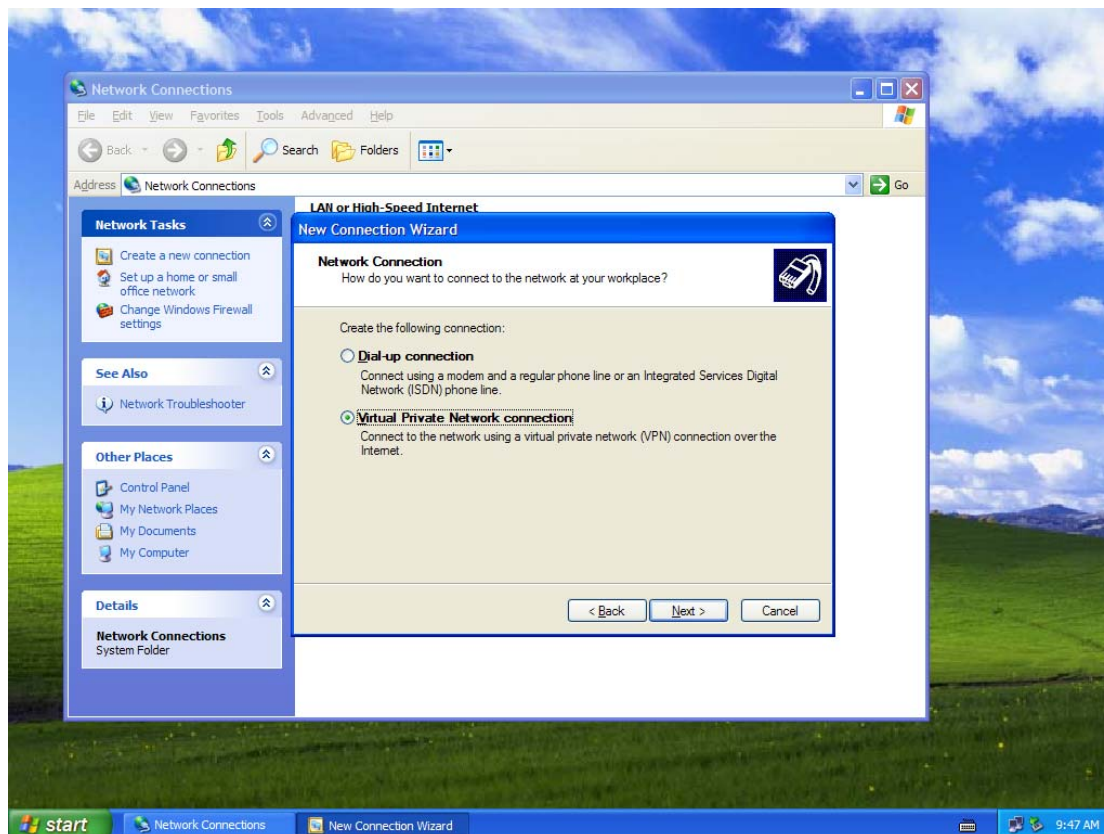

Step9: Input the user-defined name for this connection and press **Next**.

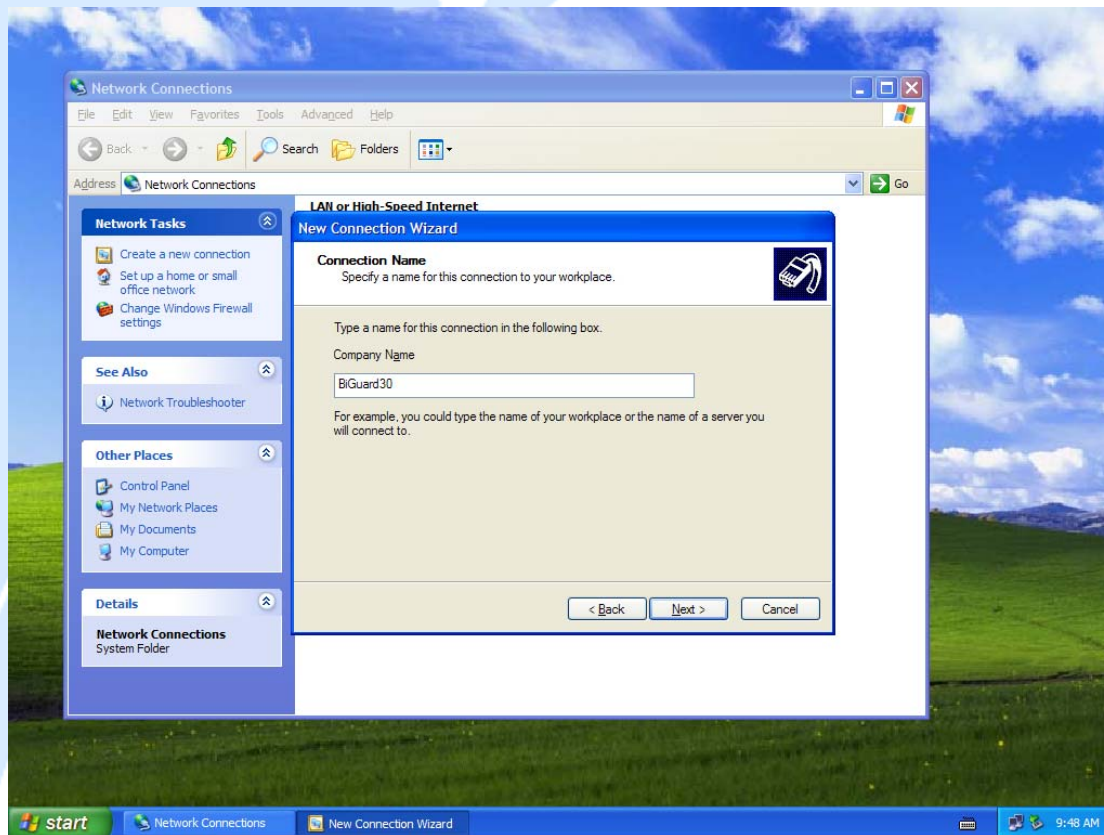

Step10: Input PPTP Server Address and press **Next**.

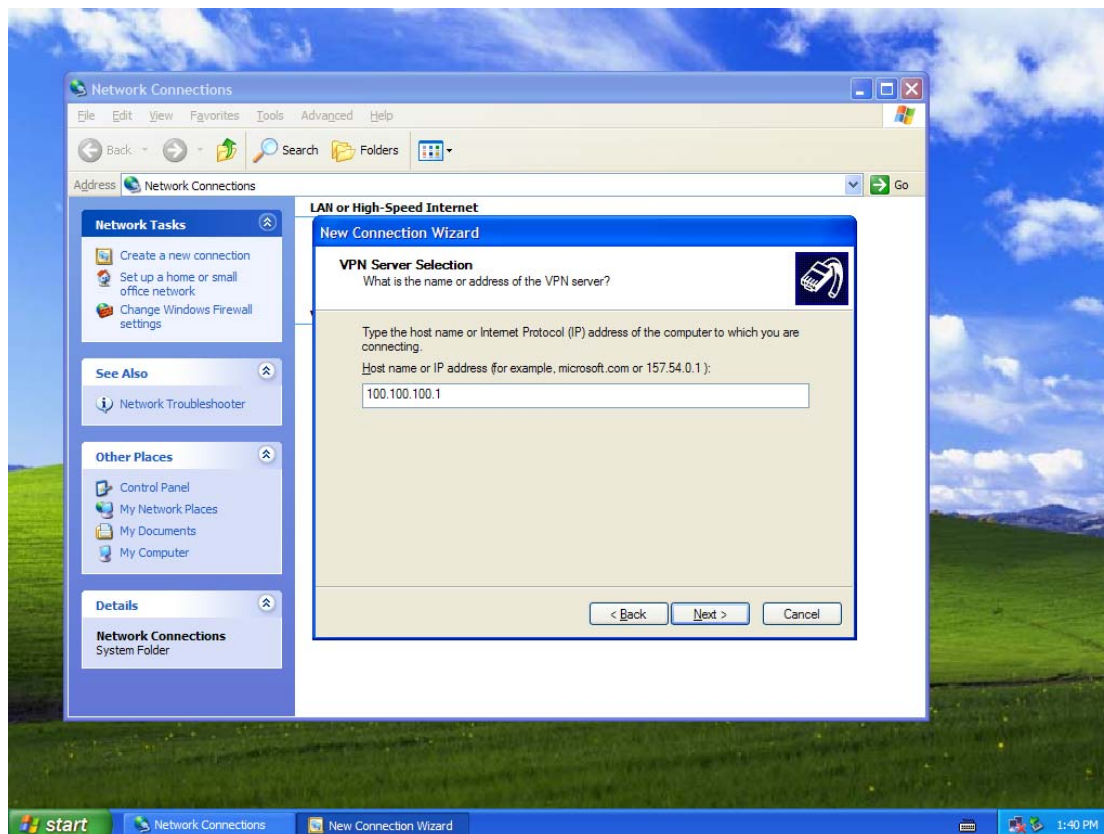

Step11: Please press **Finish**.

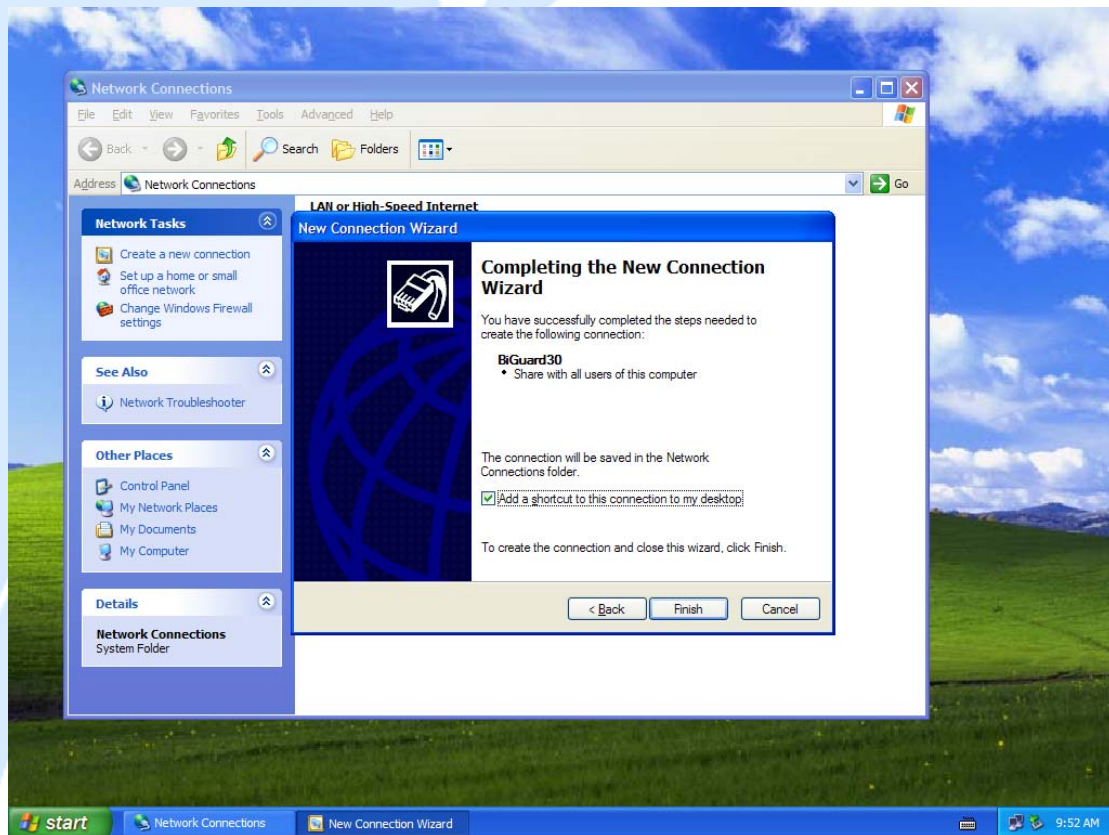

Step12: Double click the connection, and input **Username** and **Password** that defined in BiGuard PPTP **Account Settings**.

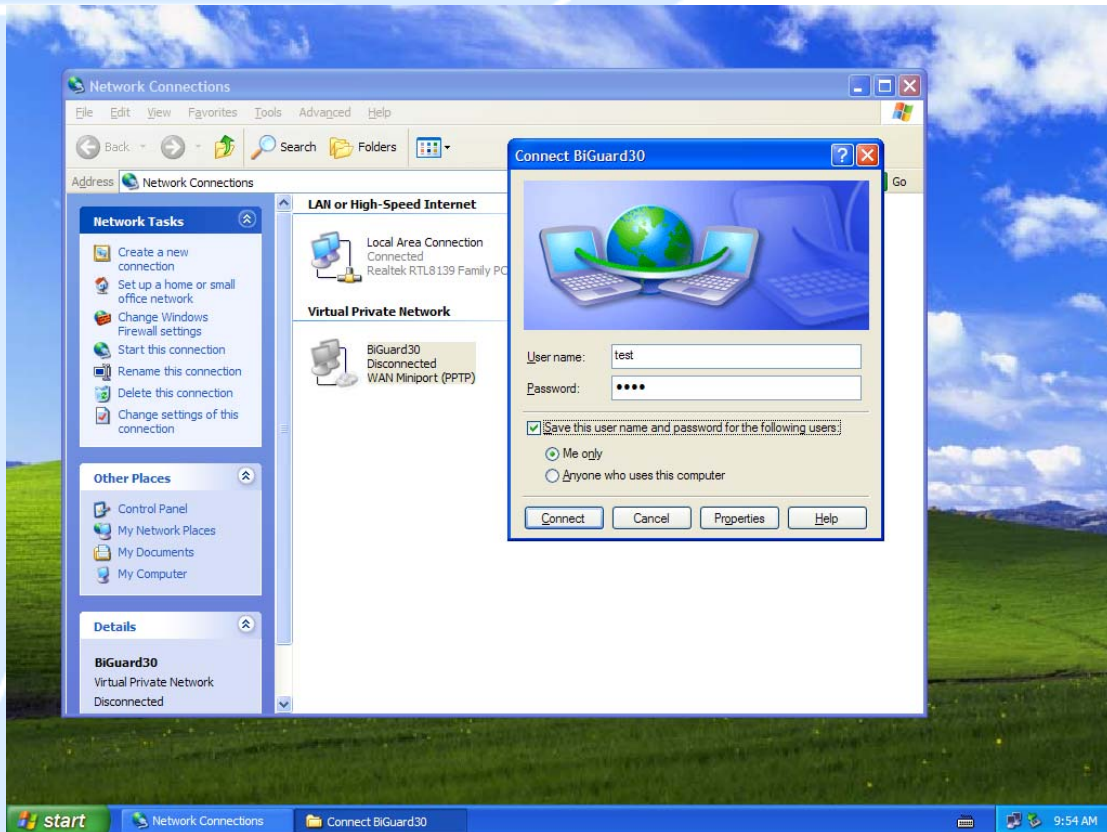

PS. You can also refer the **Properties > Security** page as below, by default.

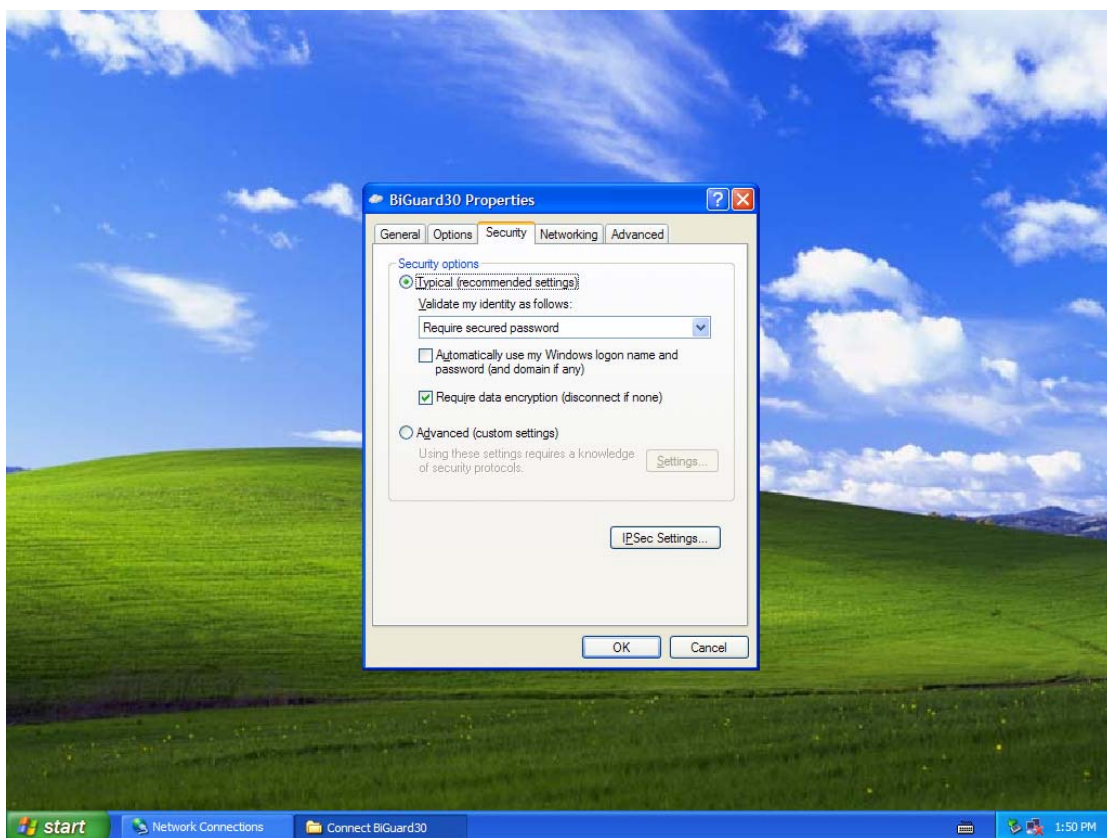

H.13 PPTP Remote Access by BiGuard

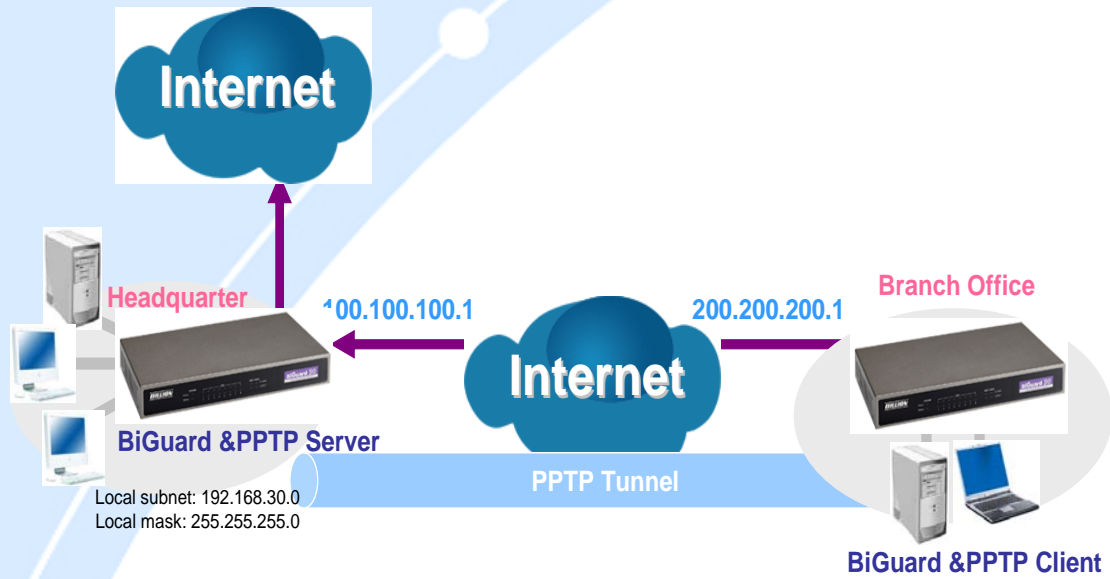

Step1: Go to **Configuration > VPN > PPTP** and Enable the PPTP function, **Disable** the **Encryption**, then Click **Apply**.

PPTP			
General Setting			
PPTP function	<input checked="" type="radio"/> Enable <input type="radio"/> Disable		
Auth. Type	Pap or Chap <input type="button" value="v"/>		
Data Encryption	Enable <input type="button" value="v"/>		
Encryption Key Length	Auto <input type="button" value="v"/>		
Peer Encryption Mode	Only Stateless <input type="button" value="v"/>		
IP Addresses Assigned to Peer	start from: 192.168.1.200		
Idle Timeout	0 Min.		
<i>(! Enable data encryption will use MS-CHAPv2 to authenticate the peer.)</i>			
<input type="button" value="Apply"/>			
Account Setting			
Name	Enable	Type	Peer Network
<input type="button" value="Create"/> <input type="button" value="▶"/>			

Step2: Click **Create** to create a PPTP Account.

PPTP

Add PPTP Account

Connection Name	<input type="text" value="BiGuard10"/>
Tunnel	<input checked="" type="radio"/> Enable <input type="radio"/> Disable
Username	<input type="text" value="test"/>
Password	<input type="password" value="••••"/>
Retype Password	<input type="password" value="••••"/>
Connection Type	<input type="radio"/> Remote Access <input checked="" type="radio"/> LAN to LAN
Peer Network IP	<input type="text" value="192"/> . <input type="text" value="168"/> . <input type="text" value="30"/> . <input type="text" value="100"/>
Peer Netmask	<input type="text" value="255"/> . <input type="text" value="255"/> . <input type="text" value="255"/> . <input type="text" value="0"/>
Netbios Broadcast	<input checked="" type="radio"/> Enable <input type="radio"/> Disable

Step3: Click **Apply**, you can see the account is successfully created.

PPTP

General Setting

PPTP function	<input type="radio"/> Enable <input checked="" type="radio"/> Disable
Auth. Type	<input type="text" value="Pap or Chap"/>
Data Encryption	<input type="text" value="Enable"/>
Encryption Key Length	<input type="text" value="Auto"/>
Peer Encryption Mode	<input type="text" value="Only Stateless"/>
IP Addresses Assigned to Peer	start from: <input type="text" value="192.168.1.200"/>
Idle Timeout	<input type="text" value="0"/> Min.

( Enable data encryption will use MS-CHAPv2 to authenticate the peer.)

Account Setting

Name	Enable	Type	Peer Network		
BiGuard10	✓	LAN to LAN	192.168.30.100/24	Edit	Delete

[Create](#)

Step4: Click **Save Config** to save all changes to flash memory.

Step5: In another BiGuard as Client, Go to **Configuration > WAN > ISP Settings**.

BILLIONTM
BiGuard 2 *iBusiness Security Gateway Home-Office*
Powering communications with Security

- Status
- Quick Start
- Configuration
- LAN
- WAN
- Bandwidth Settings
- System
- Firewall
- VPN
- QoS
- Virtual Server
- Advanced
- Save Config to Flash

WAN

PPTP

Connection Method	PPTP Settings			
Username	test			
Password	****			
Retype Password	****			
PPTP Client IP	200	200	200	1
PPTP Client IP Netmask	255	255	255	0
PPTP Client IP Gateway	200	200	200	254
PPTP Server IP	100	100	100	1
Connection	Always Connect			
Idle Time	10 minutes			
IP assign by your ISP	<input checked="" type="radio"/> Dynamic (IP automatically assigned by your ISP) <input type="radio"/> Fixed (Your ISP requires you to input IP address)			
MAC Address	<input type="checkbox"/> Your ISP requires you to input WAN Ethernet MAC MAC Address: 00 . 00 . 00 . 00 . 00 . 00			
DNS	<input checked="" type="checkbox"/> Your ISP requires you to manually setup DNS settings Primary DNS: 168 . 95 . 192 . 1 Secondary DNS: 168 . 95 . 1 . 1			
RIP	Disable <input checked="" type="radio"/> RIP-2B <input type="radio"/> RIP-2M			
MTU	1432			

Step6: Click **Apply**, and **Save CONFIG**.

Free Manuals Download Website

<http://myh66.com>

<http://usermanuals.us>

<http://www.somanuals.com>

<http://www.4manuals.cc>

<http://www.manual-lib.com>

<http://www.404manual.com>

<http://www.luxmanual.com>

<http://aubethermostatmanual.com>

Golf course search by state

<http://golfingnear.com>

Email search by domain

<http://emailbydomain.com>

Auto manuals search

<http://auto.somanuals.com>

TV manuals search

<http://tv.somanuals.com>