



BiPAC 7401V(G)PX

**3G/ VoIP/ (802.11g) ADSL2+
Firewall Router**

Quick Start Guide



PLEASE READ THE QUICK START GUIDE AND FOLLOW THE STEPS CAREFULLY. THIS QUICK START GUIDE WILL HELP YOU INSTALL THE DEVICE PROPERLY AND AVOID IMPROPER USAGE. IF YOU NEED MORE INFORMATION ON THIS SOFTWARE CONFIGURATION, PLEASE REFER TO THE USER'S MANUAL ON CD-ROM.

Package Contents

- BiPAC 7401V(G)PX ADSL2+ Router
- CD containing the on-line manual
- RJ-11 ADSL/telephone cable
- Ethernet (RJ-45) cable
- One 2dBi detachable antenna (Wireless model only)
- Power adapter
- RJ-45 to RS-232 Console Kit
- This Quick Start Guide
- Splitter/ Micro-filter (Option)

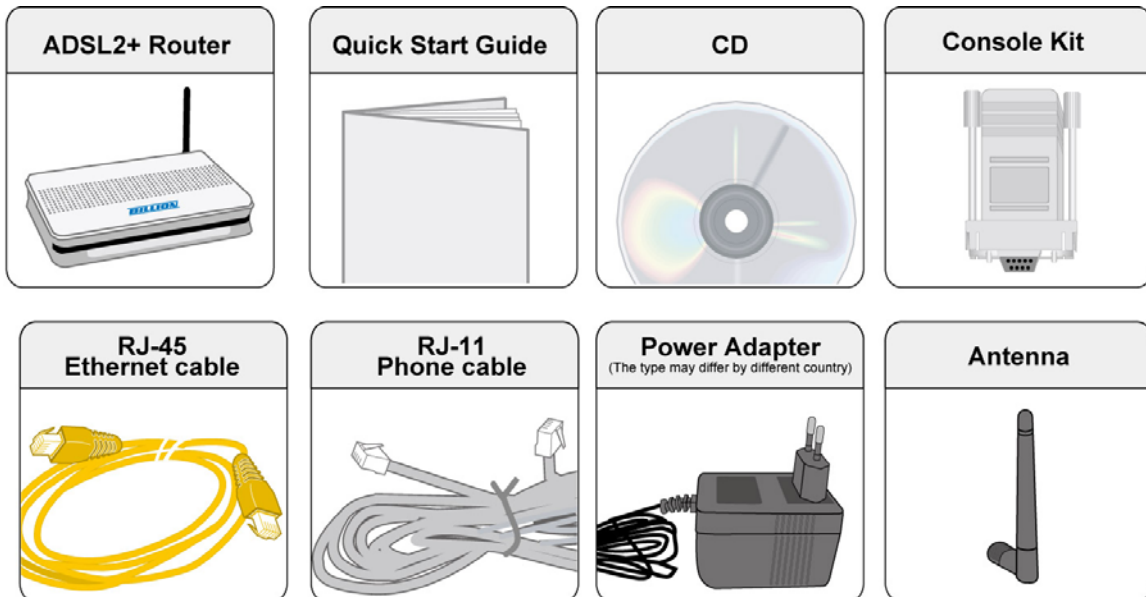

Warning

- Do not use the router in high humidity or high temperatures.
- Do not use the same power source for the router as other equipment.
- Do not open or repair the case yourself. If the router is too hot, turn off the power immediately and have it repaired at a qualified service center.
- Avoid using this product and all accessories outdoors.



Attention

- Place the router on a stable surface.
- Only use the power adapter that comes with the package. Using a different voltage rating power adaptor may damage the router.

Hardware Overview

The Front LEDs

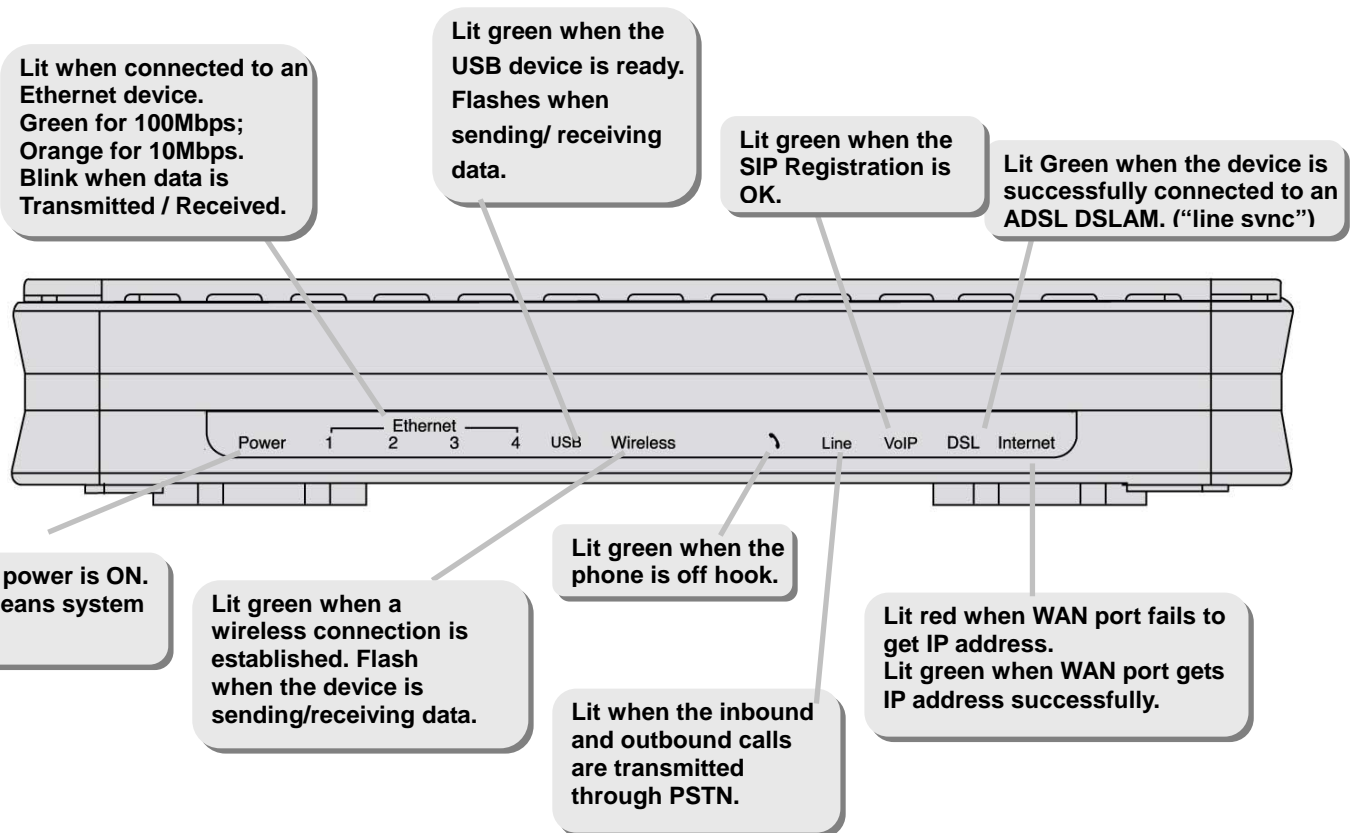

The Rear Ports

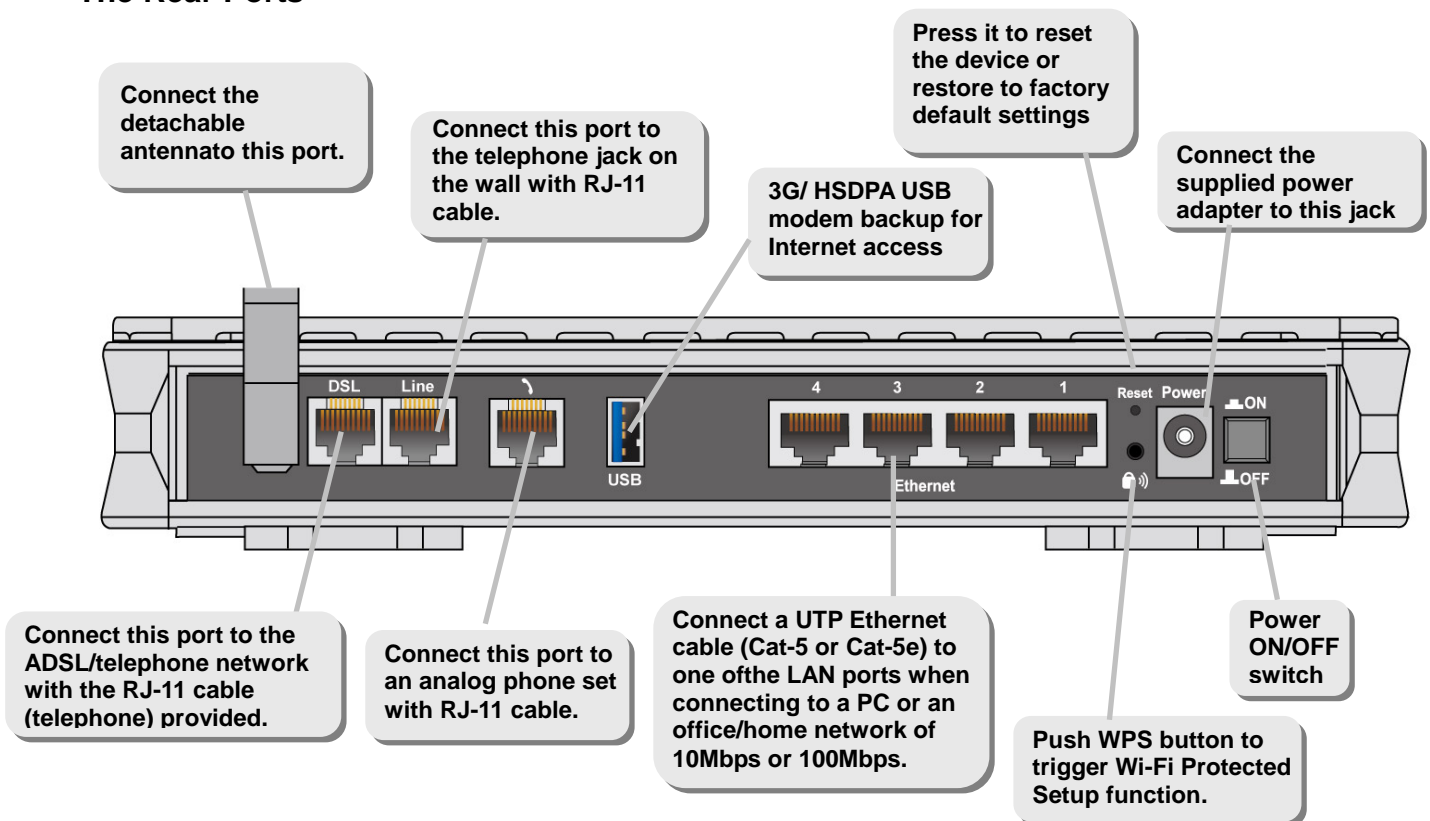

Hardware Connection

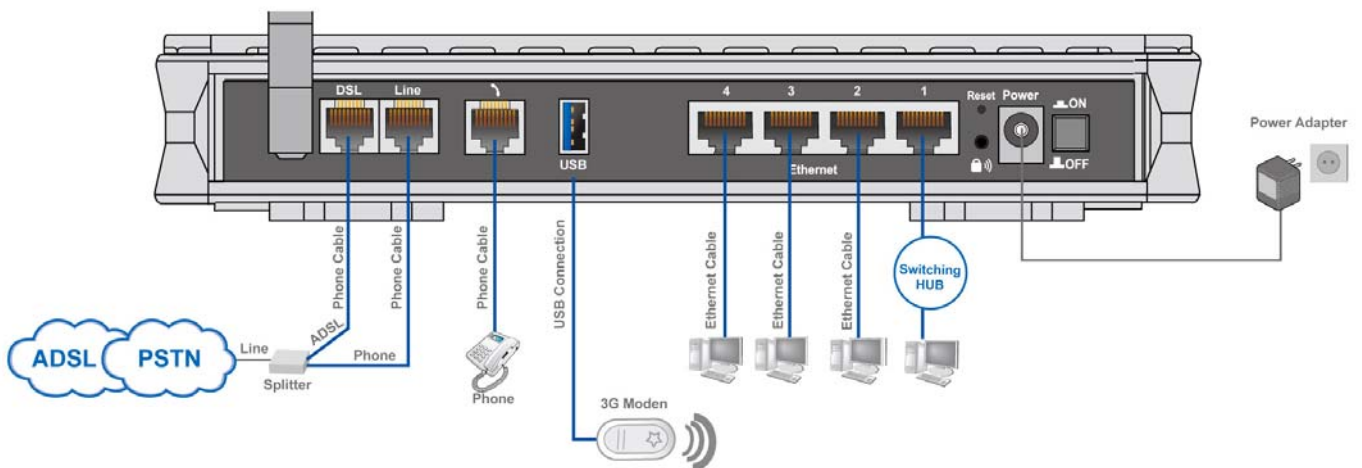

Hardware Installation

1. Power Connection

Plug the supplied power adapter to the wall jack and the other side to the router. Please note that the plug type may differ according to different countries.

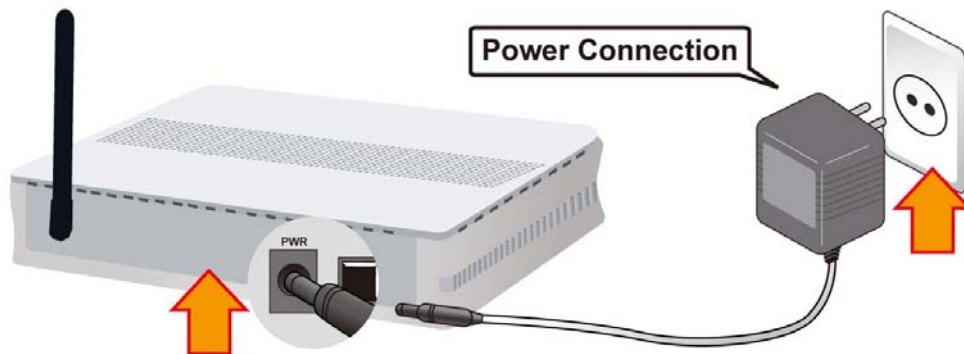

2. LAN Connection

Connect the supplied RJ-45 Ethernet cable to one of the Ethernet ports, and the other side to the PC's Ethernet interface.

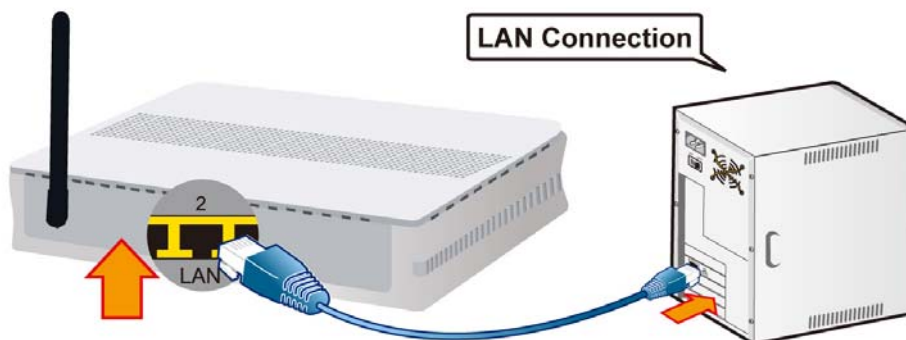

3. USB Connection

The USB 2.0 port supports 3G/HSDPA modem connectivity: users can conveniently access Internet via 3G, eliminating the limitations of the wired network. This solution also employs an auto fail-over feature to ensure always-on connectivity for SOHO users.

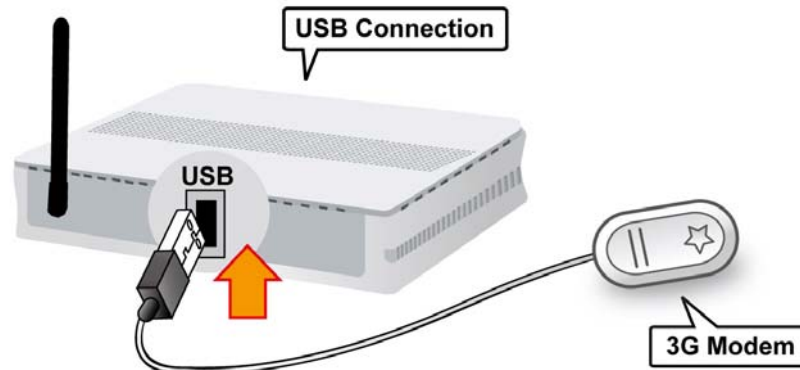

4. Phone Connection

Connect RJ-11 cable to the router's phone port and the analog phone set.

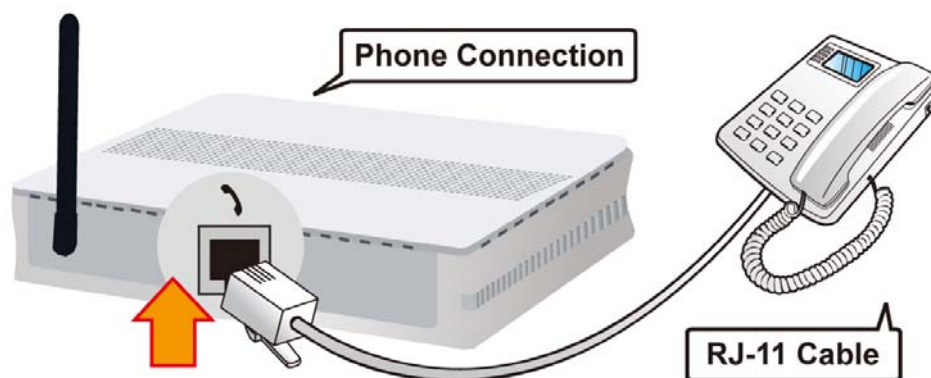

5. Line Connection

- Connect RJ-11 cable to the router DSL port and the splitter ADSL port.
- Connect RJ-11 cable to the router Line port and the splitter phone port.
- Connect RJ-11 cable to the splitter Line port and the phone jack on the wall.

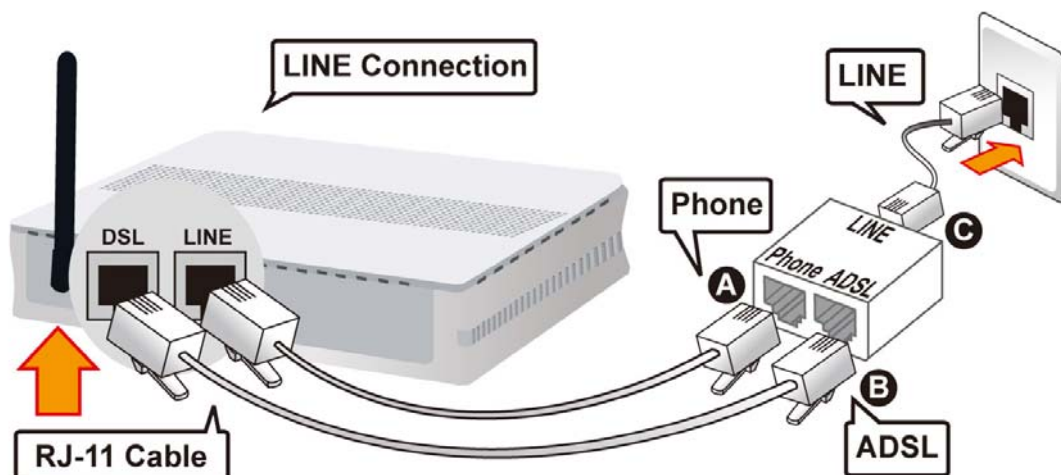

6. Splitter/ Micro-filter Connection

Splitter / Micro-filter are important for ADSL installation. It helps high-frequency signals are directed to the ADSL modem, and low-frequency signals are directed to the telephone or other analog voice-channel device to prevent inter-modulation distortion and get good speed and stable ADSL sync rate.

a) Splitter connection

If the installation has only a single telephone and a single ADSL modem, then a splitter can be employed.

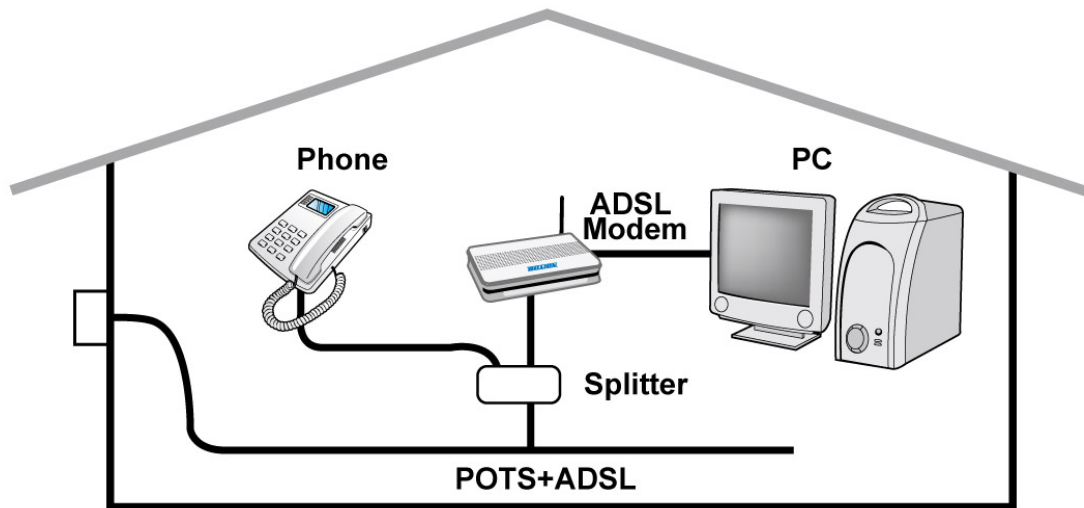

b) Micro-filter connection

If the installation has several telephones or other analog devices, then an internal micro-filter can be employed at each analog device.

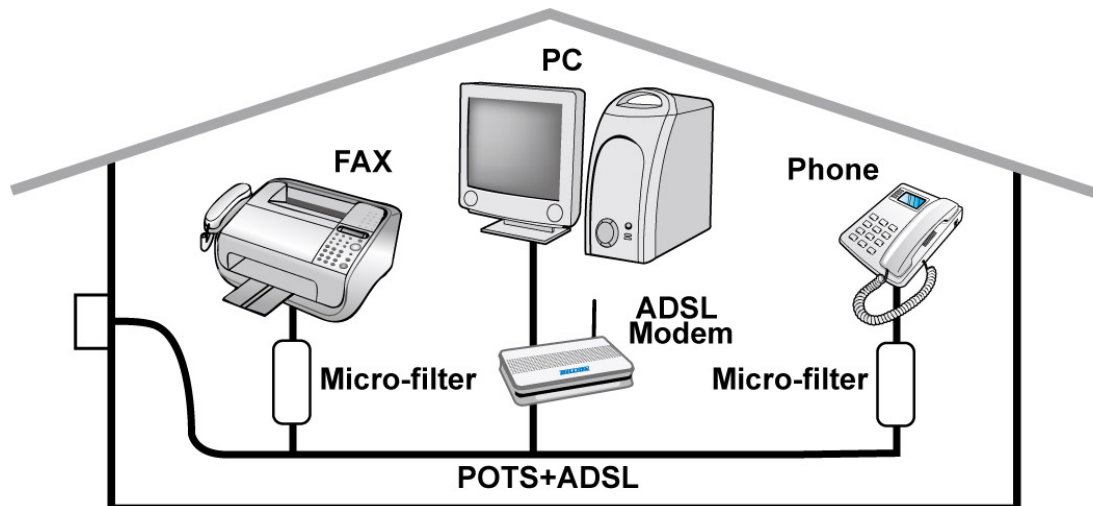

Setup Utility

After you complete the hardware installation, insert the CD-ROM to the CD-ROM drive to perform Setup Utility for network configuration. The Setup Utility will auto-run. Follow the step-by-step configuration wizard, the utility will guide you complete the basic network configuration.

Troubleshooting

1. **None of the LEDs are on when you turn on the router.**

Check the connection between the adapter and the router. If the error persists, you may have a hardware problem. In this case you should contact technical support.

2. **You have forgotten your router login and/or password.**

Try the default login and password, please refer to the user manual. If this fails, you can restore your router to its factory settings by holding the Reset button on the back of your router for 6 seconds or more.

3. **Can't ping any PCs on the LAN.**

Check the Ethernet LEDs on the front panel. The LED should be on for a port that has a PC connected. If it is off, check the cables between your router and the PC. Make sure you have uninstalled any software firewall for troubleshooting. Verify that the IP address and the subnet mask are consistent between the router and the workstations.

4. **Frequent loss of ADSL linesync (disconnections).**

Ensure that all other devices connected to the same telephone line as your router (e.g. telephones, fax machines, analogue modems) have a line filter connected between them and the wall socket (unless you are using a Central Splitter or Central Filter installed by a qualified and licensed electrician), and ensure that all line filters are correctly installed and the right way around. Missing line filters or line filters installed the wrong way around can cause problems with your ADSL connection, including causing frequent disconnections. If you have a back-to-base alarm system you should contact your security provider for a technician to make any necessary changes.

Product Support and Contact Information

Most problems can be solved by referring to the **Troubleshooting** section in the User's Manual. If you cannot resolve the problem with the **Troubleshooting** chapter, please contact the dealer where you purchased this product.

Contact Billion

WORLDWIDE

<http://www.billion.com>

Billion Product Registration

Billion is committed to before and after sales customer services. You will get the most out of your Billion's products after registration. Please register online at www.billion.com/register to receive valuable services and support from us.

Free Manuals Download Website

<http://myh66.com>

<http://usermanuals.us>

<http://www.somanuals.com>

<http://www.4manuals.cc>

<http://www.manual-lib.com>

<http://www.404manual.com>

<http://www.luxmanual.com>

<http://aubethermostatmanual.com>

Golf course search by state

<http://golfingnear.com>

Email search by domain

<http://emailbydomain.com>

Auto manuals search

<http://auto.somanuals.com>

TV manuals search

<http://tv.somanuals.com>