

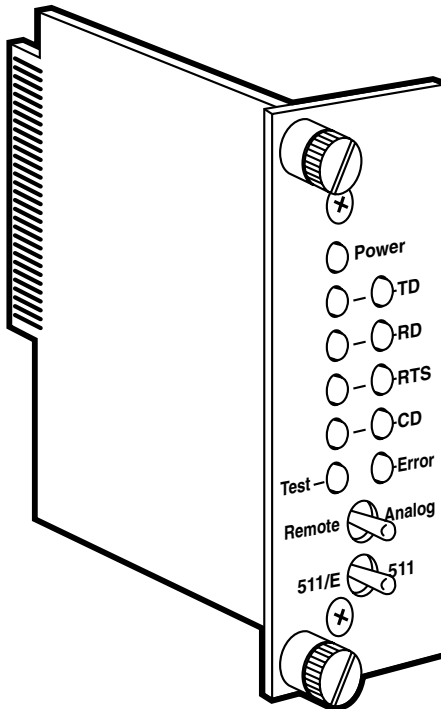

Multi-Function LD Cards



CUSTOMER
SUPPORT
INFORMATION

Order toll-free in the U.S.: Call 877-877-BBOX (outside U.S. call 724-746-5500)
FREE technical support 24 hours a day, 7 days a week: Call 724-746-5500 or fax 724-746-0746
Mailing address: **Black Box Corporation**, 1000 Park Drive, Lawrence, PA 15055-1018
Web site: www.blackbox.com • E-mail: info@blackbox.com

**FEDERAL COMMUNICATIONS COMMISSION
AND
INDUSTRY CANADA
RADIO FREQUENCY INTERFERENCE STATEMENTS**

This equipment generates, uses, and can radiate radio-frequency energy, and if not installed and used properly, that is, in strict accordance with the manufacturer's instructions, may cause interference to radio communication. It has been tested and found to comply with the limits for a Class A computing device in accordance with the specifications in Subpart B of Part 15 of FCC rules, which are designed to provide reasonable protection against such interference when the equipment is operated in a commercial environment. Operation of this equipment in a residential area is likely to cause interference, in which case the user at his own expense will be required to take whatever measures may be necessary to correct the interference.

Changes or modifications not expressly approved by the party responsible for compliance could void the user's authority to operate the equipment.

This digital apparatus does not exceed the Class A limits for radio noise emission from digital apparatus set out in the Radio Interference Regulation of Industry Canada.

Le présent appareil numérique n'émet pas de bruits radioélectriques dépassant les limites applicables aux appareils numériques de la classe A prescrites dans le Règlement sur le brouillage radioélectrique publié par Industrie Canada.

TRADEMARKS USED IN THIS MANUAL

AT&T is a registered trademark of American Telephone and Telegraph Company.

Littelfuse is a registered trademark of Littelfuse, Inc.

Any other trademarks mentioned in this manual are acknowledged to be the property of the trademark owners.

**NORMAS OFICIALES MEXICANAS (NOM)
ELECTRICAL SAFETY STATEMENT**

INSTRUCCIONES DE SEGURIDAD

1. Todas las instrucciones de seguridad y operación deberán ser leídas antes de que el aparato eléctrico sea operado.
2. Las instrucciones de seguridad y operación deberán ser guardadas para referencia futura.
3. Todas las advertencias en el aparato eléctrico y en sus instrucciones de operación deben ser respetadas.
4. Todas las instrucciones de operación y uso deben ser seguidas.
5. El aparato eléctrico no deberá ser usado cerca del agua—por ejemplo, cerca de la tina de baño, lavabo, sótano mojado o cerca de una alberca, etc..
6. El aparato eléctrico debe ser usado únicamente con carritos o pedestales que sean recomendados por el fabricante.
7. El aparato eléctrico debe ser montado a la pared o al techo sólo como sea recomendado por el fabricante.
8. Servicio—El usuario no debe intentar dar servicio al equipo eléctrico más allá a lo descrito en las instrucciones de operación. Todo otro servicio deberá ser referido a personal de servicio calificado.
9. El aparato eléctrico debe ser situado de tal manera que su posición no interfiera su uso. La colocación del aparato eléctrico sobre una cama, sofá, alfombra o superficie similar puede bloquea la ventilación, no se debe colocar en libreros o gabinetes que impidan el flujo de aire por los orificios de ventilación.
10. El equipo eléctrico deber ser situado fuera del alcance de fuentes de calor como radiadores, registros de calor, estufas u otros aparatos (incluyendo amplificadores) que producen calor.
11. El aparato eléctrico deberá ser conectado a una fuente de poder sólo del tipo descrito en el instructivo de operación, o como se indique en el aparato.

12. Precaución debe ser tomada de tal manera que la tierra física y la polarización del equipo no sea eliminada.
13. Los cables de la fuente de poder deben ser guiados de tal manera que no sean pisados ni pellizcados por objetos colocados sobre o contra ellos, poniendo particular atención a los contactos y receptáculos donde salen del aparato.
14. El equipo eléctrico debe ser limpiado únicamente de acuerdo a las recomendaciones del fabricante.
15. En caso de existir, una antena externa deberá ser localizada lejos de las líneas de energía.
16. El cable de corriente deberá ser desconectado del cuando el equipo no sea usado por un largo periodo de tiempo.
17. Cuidado debe ser tomado de tal manera que objetos líquidos no sean derramados sobre la cubierta u orificios de ventilación.
18. Servicio por personal calificado deberá ser provisto cuando:
 - A: El cable de poder o el contacto ha sido dañado; u
 - B: Objetos han caído o líquido ha sido derramado dentro del aparato; o
 - C: El aparato ha sido expuesto a la lluvia; o
 - D: El aparato parece no operar normalmente o muestra un cambio en su desempeño; o
 - E: El aparato ha sido tirado o su cubierta ha sido dañada.

Contents

Chapter	Page
1. Specifications	5
2. Introduction	8
2.1 Overview	8
2.2 Features	8
3. Configuration	10
3.1 Setting the Switches on the Main Module	10
3.2 Setting the Jumpers on the Interface Module	17
4. Installation	22
4.1 The MicroRacks: An Overview	22
4.2 The MicroRacks' Power Supply	23
4.3 Installing the Multi-Function LD Card in the MicroRack	24
4.4 The RS-232 Serial Cables and Connectors	25
4.5 The Modem-to-Modem Line Cables and Connectors	26
4.6 Multipoint Applications	28
5. Operation and Diagnostics	29
5.1 Status LEDs	29
5.2 Diagnostic Testing Using the Error LED	31
5.3 Power-Up	32
5.4 V.54 and V.52 Diagnostic Tests	33
6. Troubleshooting	36
6.1 Calling Your Supplier	36
6.2 Shipping and Packaging	36
Appendix: Cable Recommendations	37

1. Specifications

Hardware Required —	Cards can be installed only in MicroRacks (see Section 4.1)
Cable Required —	For modem-to-modem line: Two- or four-wire unconditioned twisted-pair, 19 to 26 AWG (see the Appendix), pinned as shown in Section 4.5
Compliance —	FCC Part 15 Class A, DOC Class/MDC classe A
Interfaces —	Serial: ME758C models: EIA/TIA-561 (compatible with EIA RS-232 and ITU-TSS [CCITT] V.24); ME759C models: EIA RS-232/ITU-TSS V.24 Line: Two- or four-wire telco; Internal: Card-edge for module↔MicroRack interconnection
Protocol —	Synchronous or asynchronous
Clock Source —	Internal, external (from DTE) or received (from other Card) (user-selectable)
Data Format —	Word length (including start bit, data bits, stop bits, and parity bit) must equal 8, 9, 10, or 11 bits (user-selectable)
Flow Control —	Transparent to all types of software (X-ON/X-OFF, robust X-ON/X-OFF, etc.) flow control; can be set to support hardware flow control
Operating Mode —	Two-wire half-duplex or four-wire full- or half-duplex (user-selectable)

MULTI-FUNCTION LD CARD

Data Rates —	57.6, 38.4, 28.8, 19.2, 14.4, 9.6, 7.2, 4.8, 3.6, 2.4, or 1.2 kbps (user-selectable)
Maximum Distance —	See the maximum distance chart in the Appendix
Isolation —	1500 volts RMS minimum using custom transformers
Surge-Protection Method —	Silicon Avalanche Diodes
Surge-Response Time —	1 ps
Maximum Surge Protection —	600 watts dissipated after 1 ms
User Controls —	(2) Front-panel toggle switches: Remote or (local) Analog loopback; 511 or 511/E V.52 diagnostics; (3) 8-position DIP switches on main module: (1) for data rate, clock source, protocol, and carrier control; (1) for 2- or 4-wire operation, diagnostics, RTS/CTS delay, signaling-rate range, and word length; (1) for input impedance, point-to-point or multipoint operation, remote loopback-test initiation, and antistream control; (3) Frame-ground-connection jumpers on interface module: To Line Shield, DTE Shield (Protective Ground), and Signal Ground
Indicators —	(11) Front-panel LEDs: (1) each for Power, Test, Error; (2) each for TD, RD, RTS, and CD
Diagnostics —	ITU-TSS V.54 remote digital and local analog loopbacks; ITU-TSS V.52 BERT testing
Connectors —	On main module: All models:

	(1) 50-position card-edge male (to MicroRack); On interface module: All models: (1) 50-position card-edge male (to MicroRack); ME758C-RJ11: (1) 6-pin RJ-11 female for modem-to-modem line, (1) DB25 female for modem-to-DTE line; ME758C-RJ45: (1) RJ-45 female for modem-to-modem line, (1) DB25 female for modem-to-DTE line; ME759C-RJ11: (1) 6-pin RJ-11 female for modem-to-modem line, (1) 10-pin RJ female for modem-to-DTE line; ME759C-RJ45: (1) RJ-45 female for modem-to-modem line, (1) 10-pin RJ female for modem-to-DTE line
Power —	From MicroRack's power supply (see Section 4.2): Input 120 VAC or 240 VAC (user-selectable); Output: 10 VAC; Consumption: 1.8 watts typical
Fuse —	On MicroRack (see Section 4.2.2): 400 mA when power supply is set to 120-VAC input; 200 mA when power supply is set to 240-VAC input
Temperature —	32 to 122°F (0 to 50°C)
Humidity —	Up to 95% noncondensing
Maximum Altitude —	15,000 ft. (4572 m)
Size —	Main (front) module: 3.1"H x 1"W x 5.4"D (7.9 x 2.5 x 13.7 cm); Interface (rear) module: 3.5"H x 1"W x 2.9"D (8.9 x 2.5 x 7.4 cm)
Weight —	Total for main and interface modules: 0.2 lb. (0.1 kg)

2. Introduction

2.1 Overview

The Multi-Function LD Card is a short-range modem on a dual rack card (it has a main [front] module and an interface [rear] module). The Card operates across two wires (half-duplex) or four wires (full- or half-duplex), communicating synchronously or asynchronously, up to a maximum range of 20 miles (32.2 km). You can set the Card to any of twelve data rates from 1.2 to 57.6 kbps. Local and remote modems on Multi-Function LD Cards always communicate with each other synchronously. When connected to an asynchronous RS-232 device, the Card performs synchronous↔asynchronous conversion.

The Card has several features that enhance its overall performance, including automatic equalization, automatic gain control, an antistreaming timer, transformer isolation, and Silicon Avalanche Diode surge protection. The Card also has strong diagnostics: It features V.52-compliant bit-error-rate (BERT) pattern tests and two V.54 test modes. With the Card's 11 easy-to-read front-panel LEDs, you can easily monitor the status of data transmission and diagnostic testing.

The Multi-Function LD Card is fabricated using the latest surface-mount technology, so you get high-quality short-range-modem performance on a convenient rack card. The Card is available with either DB25 or 10-pin RJ-style serial-interface connectors, and either RJ-11 or RJ-45 line-interface connectors, on its interface (rear) module. It fills one function-card slot in our MicroRacks (RM202, RM204, RM208, or RM216).

2.2 Features

- Convenient rack-card design
- Synchronous or asynchronous communication
- Data rates up to 57.6 kbps, distances up to 20 miles (32.2 km)
- 2-wire/half-duplex or 4-wire/full- or half-duplex operation
- Point-to-point or multipoint operation

- Internal, external, or received loopback clocking
- Hardware or software flow control
- Automatic equalization and gain control
- Anti-streaming timer
- Built-in transformer isolation and high-speed surge protection
- V.52 and V.54 test modes
- Eleven LED indicators show you status at a glance
- Error LED lights when Card detects broken or inferior cable

This chapter describes the locations and possible settings of the Multi-Function LD Card's configuration controls, and provides detailed instructions for setting them. **Section 3.1** tells you about the three 8-position DIP switches on the Card's main (front) module. **Section 3.2** tells you about the three jumpers ("straps") on the Card's interface (rear) module. Once you've configured the Multi-Function LD Card, it is designed to operate transparently, without needing to be frequently reconfigured. Just set it and forget it!

3.1 Setting the Switches on the Main Module

3.1.1 WHERE THE SWITCHES ARE

The Multi-Function LD Card has three 8-position DIP switches—S1, S2, and S3—mounted on the circuit board of its main (front) module, as shown in Figure 3-1 below. These configuration switches allow you to select data rates, clocking methods, V.52 and V.54 tests, word lengths, extended signaling rates, sync or async protocol, 2- or 4-wire operation, antistream control, and input impedance. As shown in Figure 3-2 on the next page, the "ON" and "OFF" points are the same for all of the switch positions.

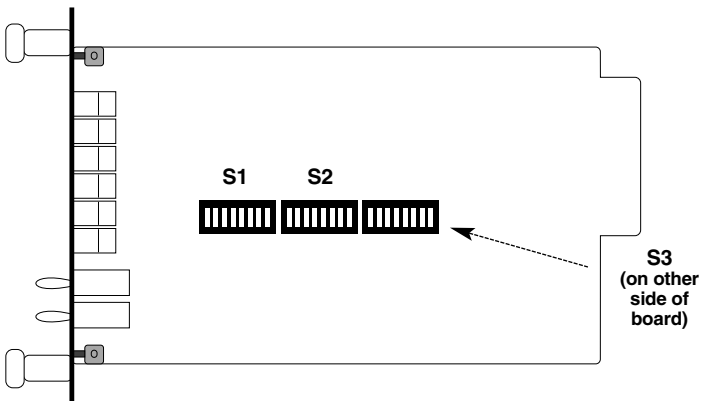

Figure 3-1. The main-module switches.

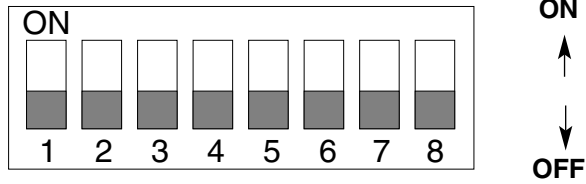

Figure 3-2. The ON and OFF settings of the DIP switches.

3.1.2 CONFIGURATION SWITCH “S1”

Use the individual positions on DIP switch S1 to set data rate, clock source, sync vs. async protocol, and carrier-control method. The factory-default settings are summarized in Table 3-1 below.

Table 3-1. Switch S1 Summary

Position	Function	Default Setting
S1-1	Data Rate	On
S1-2	Data Rate	Off
S1-3	Data Rate	Off
S1-4	Data Rate	On
		} 9600 bps
S1-5	Clock Source	On
S1-6	Clock Source	On
		} Internal
S1-7	Protocol	On
		Asynchronous
S1-8	Carrier Control	Off
		Constantly ON

MULTI-FUNCTION LD CARD

S1 Positions 1 through 4: Data-Rate Setting

Set positions 1 through 4 of switch S1 to determine the data rate (valid for both synchronous and asynchronous protocols) of the Multi-Function LD Card.

<u>S1-1</u>	<u>S1-2</u>	<u>S1-3</u>	<u>S1-4</u>	<u>Data Rate</u>
On	On	On	On	1.2 kbps
Off	On	On	On	1.8 kbps
On	Off	On	On	2.4 kbps
Off	Off	On	On	3.6 kbps
On	On	Off	On	4.8 kbps
Off	On	Off	On	7.2 kbps
On	Off	Off	On	9.6 kbps (default)
Off	Off	Off	On	14.4 kbps
On	On	On	Off	19.2 kbps
Off	On	On	Off	28.8 kbps
On	On	Off	Off	38.4 kbps
Off	On	Off	Off	57.6 kbps

S1 Positions 5 and 6: Clock Source

Set positions 5 and 6 of switch S1 to determine which transmit-clock source the Multi-Function LD Card uses.

<u>S1-5</u>	<u>S1-6</u>	<u>Clock Source</u>
On	On	Internal transmit clock (default)
Off	On	Receive-recover clock
On	Off	External transmit clock

S1 Position 7: Protocol

Set position 7 of switch S1 to determine whether the Multi-Function LD Card operates synchronously or asynchronously.

<u>S1-7</u>	<u>Protocol</u>
On	Asynchronous (default)
Off	Synchronous

S1 Position 8: Carrier-Control Method

Set position 8 of switch S1 to determine whether the carrier is “constantly on” or “controlled by RTS.” In the “controlled by RTS” setting, the Switch can support switched-carrier, multipoint, or hardware flow-control applications.

- S1-8 Carrier
- Off Constantly ON (default)
- On Controlled by RTS

3.1.3 CONFIGURATION SWITCH “S2”

Use the individual positions on DIP switch S2 to set word length, signaling-rate range, RTS/CTS delay, or 2- or 4-wire operation, as well as to control diagnostic testing. The factory-default settings are summarized in Table 3-2 below.

Table 3-2. Switch S2 Summary

Position	Function	Default Setting
S2-1	Not Used	N/A
S2-2	2-Wire/4-Wire	Off 4-Wire
S2-3	V.52, V.54 Tests	Off Normal Operation
S2-4	RTS/CTS Delay	On > 7 ms
S2-5	RTS/CTS Delay	On > 7 ms
S2-6	Signaling-Rate Range	On -2.5 to +1%
S2-7	Word Length	Off > 10 bits
S2-8	Word Length	Off > 10 bits

S2 Position 2: 2-Wire vs. 4-Wire Operation

Set position 2 of switch S2 to determine whether the Multi-Function LD Card operates in 2-wire or 4-wire mode.

- S2-2 Operation
- Off 4-wire (full- or half-duplex) (default)
- On 2-wire (half-duplex only)

S2 Position 3: V.52 and V.54 Diagnostic Testing

To reset the V.54 circuit, turn switch S2 position 3 ON, then back OFF.

<u>S2-3</u>	<u>Test Mode</u>
Off	Normal Operation (default)
On	Test Disabled

S2 Positions 4 and 5: RTS/CTS Delay

Set positions 4 and 5 of switch S2 to determine the amount of time the Multi-Function LD Card waits after it “sees” RTS before it sends CTS. Possible settings are no delay, 7 ms, or 53 ms.

<u>S2-4</u>	<u>S2-5</u>	<u>RTS/CTS Delay</u>
On	On	7 ms (default)
On	Off	53 ms
Off	On	No delay
Off	Off	No delay

S2-6: Signaling-Rate Range

Set position 6 of switch S2 to determine the degree of asynchronous data-rate fluctuation that the Multi-Function LD Card will accept (that is, how much variance from a given frequency level the Card will tolerate).

<u>S2-6</u>	<u>Signaling-Rate Range</u>
Off	-2.5% to +1% (default)
On	-2.5% to +2.3%

S2-7 and S2-8: Word Length

Set positions 7 and 8 of switch S2 to determine the word length that the Multi-Function LD Card will expect for synchronous or asynchronous data. For example, if you are using the most common data format (1 start bit, 8 data bits, 1 stop bit, and no parity), you would use the factory-default word-length setting (10 bits).

<u>S2-7</u>	<u>S2-8</u>	<u>Word Length</u>
On	Off	8 bits
On	On	9 bits
Off	Off	10 bits (default)
Off	On	11 bits

3.1.4 CONFIGURATION SWITCH “S3”

Use the individual positions on DIP switch S3 to set antistream control, receive (input) impedance, and point-to-point/multipoint, as well as to enable or disable local and remote loopbacks. The factory-default settings are summarized in Table 3-3 below.

Table 3-3. Switch S3 Summary

Position	Function	Default Setting
S2-1 S2-2	Input Impedance Input Impedance	On > 200 ohms Off
S2-3	Reserved	N/A
S2-4	Pt.-to-Pt./Multipoint	On Point-to-Point
S2-5	DTE Local Loopback	Off Disabled
S2-6	DTE Remote Loopback	Off Disabled
S2-7 S2-8	Antistream Control Antistream Control	Off > Disabled Off

S3-1 and S3-2: Input Impedance

Set positions 1 and 2 of switch S3 to determine the Multi-Function LD Card’s input impedance.

Choose the optimum impedance setting for your application. In long-distance applications, the impedance of the cable must match the impedance of the load (or resistor) of the Multi-Function LD Card: Thicker-gauge cables require a lower ohm setting, while thinner-gauge cables require a higher ohm setting. Also, higher data rates call for a lower ohm setting, and lower data rates dictate a higher ohm setting. Table 3-4 below lists our recommendations for setting this switch.

<u>S3-1</u>	<u>S3-2</u>	<u>Input Impedance</u>
On	On	130 ohms
On	Off	200 ohms (default)
Off	On	320 ohms
Off	Off	High (minimum 2000 ohms)

Table 3-4. Recommended Impedance Settings

Cable Gauge	Data Rates in kbps											
	1.2	1.8	2.4	3.6	4.8	7.2	9.6	14.4	19.2	28.8	38.4	57.6
19	320	320	200	200	200	200	200	130	130	130	130	130
22	320	320	320	200	200	200	200	200	130	130	130	130
24	320	320	320	320	200	200	200	200	200	130	130	130
26	320	320	320	320	320	200	200	200	200	200	130	130

S3-4: Mode Selection

Set position 4 of switch S3 to determine whether the Multi-Function LD Card operates in point-to-point or multipoint mode.

S3-4 Operation

- On Point-to-point (also multipoint as the “master”) (default)
- Off Multipoint (as a “slave”)

S3-5: DTE RS-232 Initiation of Local Loopback Test

Set position 5 of switch S3 to determine whether or not the attached DTE can initiate the Multi-Function LD Card’s local analog loopback test by raising the Local Loopback (LL) signal on Pin 18 of the RS-232 interface.

S3-5 DTE Initiation of Local Loopback

- On Enabled
- Off Disabled (default)

S3-6: DTE RS-232 Initiation of Remote Loopback Test

Set position 6 of switch S3 to determine whether or not the Multi-Function LD Card’s remote analog loopback test can be initiated by raising the Remote Loopback (RL) signal on Pin 21 of the RS-232 interface.

S3-6 DTE Initiation of Remote Loopback

- On Enabled
- Off Disabled (default)

S3-7 and S3-8: Antistream Control

Set positions 7 and 8 of switch S3 to determine the timeout period for the Multi-Function LD Card's antistream-control timer, or to disable the timer entirely.

<u>S3-7</u>	<u>S3-8</u>	<u>Setting</u>
Off	Off	Disabled (default)
Off	On	12.5 seconds
On	Off	50 seconds
On	On	12.5 seconds

3.2 Setting the Jumpers on the Interface Module**3.2.1 THE INTERFACE-MODULE OPTIONS**

The Multi-Function LD Card has four interface-module options:

- The ME758C-RJ11 has a DB25 connector for an RS-232 serial port and an RJ-11 modem-to-modem port.
- The ME758C-RJ45 has a DB25 connector for an RS-232 serial port and an RJ-45 modem-to-modem port.
- The ME759C-RJ11 has a 10-pin RJ-style connector for an RS-232 compatible serial port and an RJ-11 modem-to-modem port.
- The ME759C-RJ45 has a 10-pin RJ-style connector for an RS-232 compatible serial port and an RJ-45 modem-to-modem port.

Figure 3-3, below, shows the rear panels of each of these interface modules.

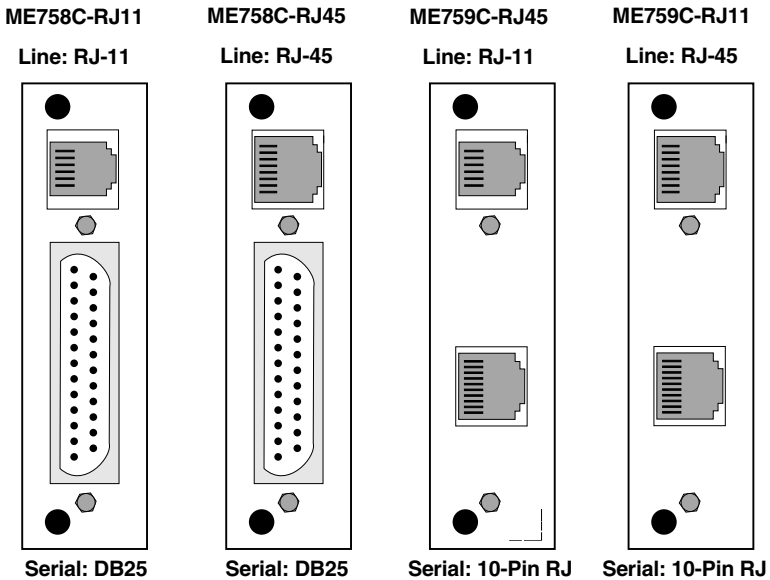

Figure 3-3. The four interface modules.

Before you install the Card, you should examine the interface module you have selected and make sure that it is configured for your application. Each interface module has three jumpers on its circuit board, as described in the following sections.

3.2.2 THE CONFIGURATION JUMPERS ILLUSTRATED

Figure 3-4, below, shows the possible settings of the Multi-Function LD Card's jumpers. Each jumper can be either on pegs 1 and 2, as shown at left, or on pegs 2 and 3, as shown at right.

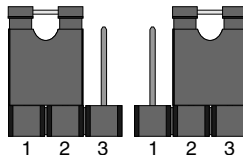

Figure 3-4. The possible jumper settings.

3.2.3 WHERE THE JUMPERS ARE

Figure 3-5, below, shows the locations of the jumpers on the interface modules (the locations are the same for both the -RJ11 and -RJ45 models). These jumpers determine various grounding and signal characteristics for the serial and modem-to-modem lines.

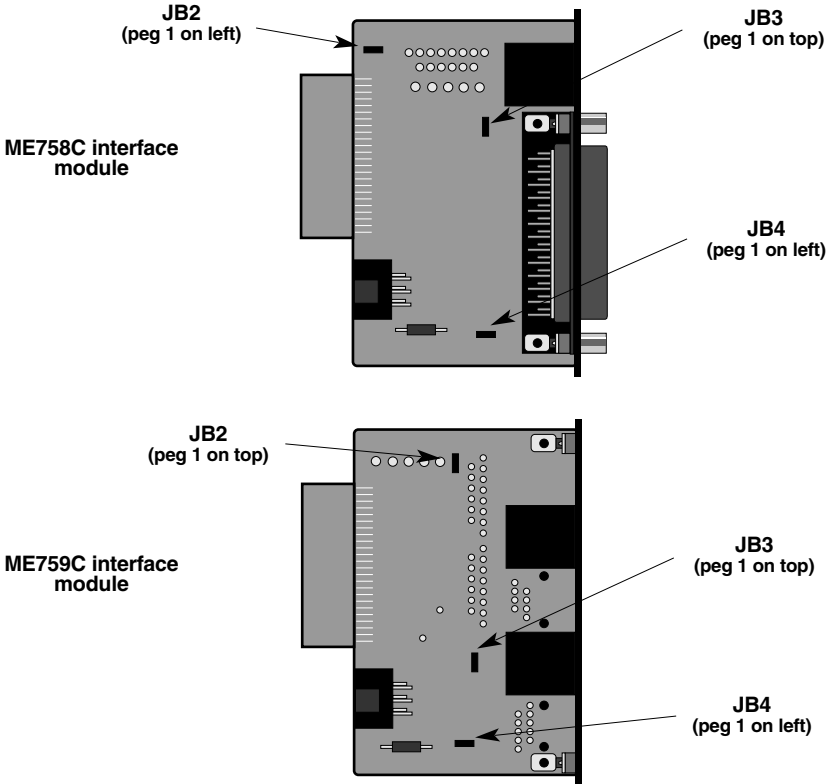

Figure 3-5. The jumper locations.

Table 3-5, below, provides a summary of the functions of these jumpers. The functions are described in more detail afterward.

Table 3-5. Summary of Interface-Module Jumper Functions

Jumper	Function	Pos. 1 & 2	Pos. 2 & 3
JB2	Line Shield and FGND	Connected	N/C*
JB3	PGND (DTE Pin 1) and FGND	Connected	N/C*
JB4	SGND and FGND	Connected	N/C*
*factory-default settings			

Line Interface: Line Shield Connection to Frame Ground (JB2)

This jumper applies to the line interface. When this jumper is in positions 1 and 2, it links RJ-11 Pins 1 and 6 or RJ-45 Pins 2 and 7 on the corresponding line to the interface module’s frame ground. (If you are using shielded twisted-pair cable, the shield can be connected to these pins.) In positions 2 and 3, RJ-11 Pins 1 and 6 or RJ-45 Pins 2 and 7 remain connected to each other, but are disconnected (“lifted”) from frame ground.

JB2

Positions 1 and 2 = Line Shield and FGND Connected

Positions 2 and 3 = Line Shield and FGND Not Connected (default)

CAUTION!

If you connect shield to frame ground, make sure that RJ-11 Pins 1 and 6 or RJ-45 Pins 2 and 7, as well as the cable shield, are connected to ground at one end of the cable only. Connecting them at both ends of the cable will defeat the transformer isolation and will leave your system open to damage from ground loops.

Serial Interface: DTE Shield (Pin 1) Connection to Frame Ground (JB3)

This jumper applies to the serial interface. In position 1 and 2, this jumper links the Protective Ground (PGND) or “DTE Shield” lead (DB25 Pin 1 or 10-pin RJ Pins 1 and 10) of the RS-232 line to the interface module’s frame ground (FGND). When this jumper is in positions 2 and 3, the RS-232 Protective Ground on DB25 Pin 1 or RJ-45 Pins 1 and 10 is disconnected (“lifted”) from frame ground.

JB5

Positions 1 and 2 = PGND and FGND Connected

Positions 2 and 3 = PGND and FGND Not Connected (default)

Serial Interface: Signal Ground and Frame Ground (JB4)

This jumper also applies to the serial interface. In position 1 and 2, this jumper links the Signal Ground (SGND) lead (DB25 Pin 7 or 10-pin RJ Pin 5) of the RS-232 line to the interface module’s frame ground (FGND). When this jumper is in positions 2 and 3, RS-232 Signal Ground on DB25 Pin 7 or 10-pin RJ Pin 5 is disconnected (“lifted”) from frame ground.

JB5

Positions 1 and 2 = SGND and FGND Connected

Positions 2 and 3 = SGND and FGND Not Connected (default)

4. Installation

This chapter describes the functions of the MicroRacks, tells how to install the front and rear modules of the Multi-Function LD Cards in them, and provides diagrams for wiring the interface connections correctly.

4.1 The MicroRacks: An Overview

Multi-Function LD Cards are designed to be installed in our MicroRacks (product codes RM202 for the 2-card models, RM204 for the 4-card models, RM208 for the 8-card models, and RM216 for the 16-card models). You will install Multi-Function LD Cards in any MicroRack the same way.

As an example of these products, the MicroRack 16, shown in Figure 4-1 below, features sixteen slots for short-range modem cards, plus its own power supply. Measuring only 3.5" (8.9 cm) high, the MicroRack 16 is designed to occupy only 2U in a 19" rack. Sturdy front handles allow the MicroRack 16 to be extracted and transported conveniently.

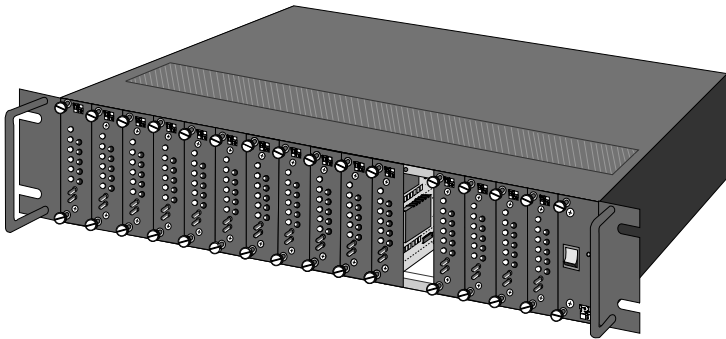

Figure 4-1. The MicroRack 16 (shown with fifteen Multi-Function LD Cards installed).

4.2 The MicroRacks' Power Supply

The power supply included with the MicroRacks uses the same mid-plane architecture as the line-driver cards. Slide the front module of the power supply into the MicroRack from the front, and slide the rear module in from the rear. The two modules plug into one another in the middle of the rack. Secure the front module with thumbscrews and the rear module with conventional metal screws; these screws and thumbscrews come with the rack.

4.2.1 SWITCHING THE POWER SUPPLY ON AND OFF

The MicroRack's power switch is located on the power supply's front panel. When the MicroRack is plugged in and switched on, the power supply will light the red LED on its front panel. Since the MicroRack is a "hot-swappable" rack, *you don't have to install any cards before switching on the power supply.* Also, the power supply may be switched off at any time without harming the installed cards, and you can install or remove cards without turning off the power supply. However, you should always unplug the power cord before removing, replacing, or switching the power supply or its fuses.

4.2.2 REPLACING THE POWER SUPPLY'S FUSE

The MicroRack's power supply uses a 400-mA fuse for 120-VAC circuits, and a 200-mA fuse for 240-VAC circuits. The fuse compartment is located just below the AC socket on the power supply's rear module. To replace the fuse, follow these steps:

1. Making sure the rack is turned off and unplugged, use a small screwdriver to pop the compartment open: It will slide open like a drawer.
2. Notice that there are two fuses in the compartment: The rear fuse is "active," and the front fuse is the "spare."
3. If the active fuse appears to be blown, remove it from the clips and replace it with the spare from the front of the compartment. Note the size and rating of the blown fuse before discarding it.
4. Order a new replacement fuse. Both the 400-mA fuses (Littelfuse® 239.400 or equivalent) and the 200-mA fuses (Littelfuse 239.200 or equivalent) measure 5 x 20 mm.

CAUTION!

For continued protection against the risk of fire, replace blown fuses only with fuses of the same type and rating.

4.2.3 SWITCHING THE POWER SUPPLY BETWEEN 120 AND 240 VOLTS

Although the MicroRack is shipped from the factory with a customer-specified power-supply configuration, you may change the configuration yourself. Follow these steps to switch the configuration of the power supply between 120 VAC and 240 VAC:

1. Making sure the rack is turned off and unplugged, remove the power supply's front module and locate the two-position switch (labeled either "110/220" or "115/230") near the back of the card. Slide the switch to the setting corresponding to your desired voltage.
2. Replace the existing fuses with fuses of the correct type (see step 4 of **Section 4.2.2**).
3. If necessary, replace the power-supply cord with a country-specific cord. (For certain countries, your supplier might be able to give you a special quote on country-specific cords.) Plug the cord back in.

4.3 Installing the Multi-Function LD Card in the MicroRack

The Multi-Function LD Card is made up of a main (front) module and an interface (rear) module. The two cards meet inside the rack chassis; their mating 50-pin card-edge connectors plug into each other. Use these steps to install each Multi-Function LD Card into a MicroRack:

1. Slide the rear module into the back of the MicroRack on the metal rails.
2. Secure the rear module using the included metal screws.
3. Slide the front module into the front of the chassis. It should meet the rear module when it is almost completely in the chassis.
4. Push the front module gently into the card-edge receptacle of the rear module. It should "click" into place.
5. Secure the front module using the thumbscrews.

NOTE

Since the MicroRacks allow "hot swapping" of cards, it is not necessary to power down the rack when you install or remove a Multi-Function LD Card.

4.4 The RS-232 Serial Cables and Connectors

The Multi-Function LD Card's RS-232 port is always the *lower* port on its interface module. On ME758C models it is a standard DB25 connector (pinout shown in Table 4-1 below, top). On ME759C models it is a 10-pin female RJ-style connector (compatible with regular male RJ-45 cable connectors), pinned according to a modified version of the EIA/TIA-561 standard, as shown in Table 4-2 below (bottom).

Table 4-1. Pinout of the RS-232 Interface

DIRECTION	STANDARD RS-232/V.24 DCE PINNING	DIRECTION
From Card	Transmit Clock DCE (TCC) 15	To Card
From Card	Receive Clock DCE (RCC) 17	From Card
To Card	Local Loopback (LL) 18	To Card
To Card	Data Terminal Ready (DTR) 20	From Card
To Card	Remote Loopback (RL) 21	From Card
To Card	Transmit Clock DTE (TCT) 24	
From Card	Test Mode (TM) 25	

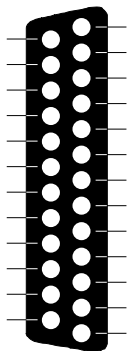
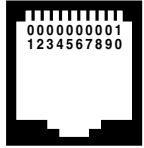

Table 4-2. Pinout of the 10-Pin RJ Interface

Pin Number	ITU-TSS V.24 Circuit	Signal Name/Description
1	N/A	Not Used
2	107	DCE Ready (DCR [DSRJ])
3	109	Received Line Signal Detector (RLSD [CD])
4	108/2	DTE Ready (DTR)
5	102	Signal Common (SCOM [SGND])
6	104	Receive Data (RD)
7	103	Transmitted Data (TD)
8	106	Clear to Send (CTS)
9	105 or 133	Request to Send (RTS) or Ready for Receiving (RR)
10	N/A	Not Used



Pin 3 through 9 correspond to Pins 2 through 8 of the EIA/TIA-561 non-synchronous interface standard. Pin 2 corresponds to Pin 1 of the EIA/TIA TSB-25 preliminary interface standard.

The Multi-Function LD Card is wired as a DCE (Data Communications Equipment) device. Therefore, it would normally be connected to a DTE (Data Terminal Equipment) RS-232 device. You might need to run a special cable or use a special adapter if the serial port of the RS-232 device you want to attach is not the same type of connector as the one on your Card. Even if the serial ports on the Card and the DTE are both RJ-45 connectors, you might still need to use a specially pinned cable. Call your supplier for technical support with these issues, or if you want to attach a DCE device to the Card.

4.5 The Modem-to-Modem Line Cables and Connectors

The Multi-Function LD Card's line port is always the *upper* port on its interface module. It is a 6-pin RJ-11 connector on the -RJ11 models or an 8-pin RJ-45 connector on the -RJ45 models, pinned for a standard telco-wiring environment, as shown in Table 4-3 and Figure 4-2 on the next page.

The Multi-Function LD Card operates half-duplex over two wires (one twisted pair) or full- or half-duplex over four wires (two twisted pairs). In all applications, the twisted-pair wire must be 26 AWG or thicker, unconditioned, dry, and metallic. Both shielded and unshielded cable yield favorable results.

NOTE

The Multi-Function LD Card can only communicate in a closed data circuit with another Multi-Function LD Card. It will not work with dialup analog circuits, such as those used with standard modems. For further information about acceptable wire grades, refer to the recommendations in the Appendix.

The modem-to-modem cable connection must be specially cross-pinned, as shown in Table 4-3 and Figure 4-2 on the next page. If your cabling includes punchdown blocks, you can easily do the cross-pinning at a punchdown block. If you will be running cable directly between two Multi-Function LD Cards, you can get a custom cable from your supplier as a special quote, or you can use regular straight-through-pinned cable and repin one of the RJ connectors (that is, rearrange the wiring connections between the terminal block and the actual contacts). You might need special crimping tools or new connectors; call your supplier for these items, or for technical support if you have difficulty.

Table 4-3. Line-Cable Pinouts

<u>RJ-11 (Four-Wire)</u>					
SIGNAL	PIN#	COLOR*	COLOR*	PIN#	SIGNAL
GND**	1	Blue.....	White	6	GND**
RCV-†	2	Yellow	Red	4	XMT-
XMT+	3	Green.....	Black	5	RCV+
XMT-	4	Red	Yellow	2	RCV-
RCV+	5	Black.....	Green	3	XMT+
GND**	6	White.....	Blue	1	GND**

<u>RJ-45 (Four-Wire)</u>					
SIGNAL	PIN#	COLOR*	COLOR*	PIN#	SIGNAL
GND**	2	Orange.....	Brown	7	GND**
RCV-†	3	Black.....	Green	5	XMT-
XMT+	4	Red	Yellow	6	RCV+
XMT-	5	Green.....	Black	3	RCV-
RCV+	6	Yellow	Red	4	XMT+
GND**	7	Brown.....	Orange	2	GND**

<u>RJ-11 (Two-Wire)</u>					
SIGNAL	PIN#	COLOR*	COLOR*	PIN#	SIGNAL
XMT+†	3	Green.....	Green	3	XMT+
XMT-	4	Red	Red	4	XMT-

<u>RJ-45 (Two-Wire)</u>					
SIGNAL	PIN#	COLOR*	COLOR*	PIN#	SIGNAL
XMT+†	4	Red	Red	4	XMT+
XMT-	5	Green.....	Green	5	XMT-

*Standard color codes—wire colors in your cable might be different

**Connection to ground is optional

†The Multi-Function LD Card is not sensitive to polarity

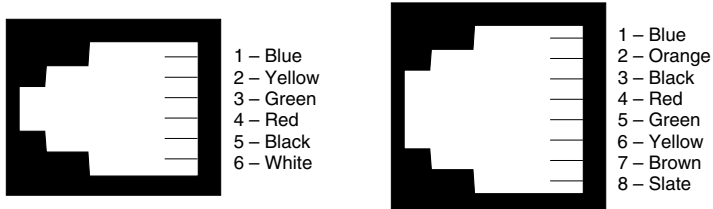

Figure 4-2. AT&T® standard modular color codes.

4.6 Multipoint Applications

The Multi-Function LD Card supports multipoint applications using equipment arranged in a star topology. Maximum distance between the units will vary based on the number of drops, data rate, wire gauge, etc. Call your supplier's technical support for distance estimates more specific to your application. Figures 4-3 and 4-4 below show how to wire two-pair and one-pair cables respectively for a Multi-Function LD Card star network.

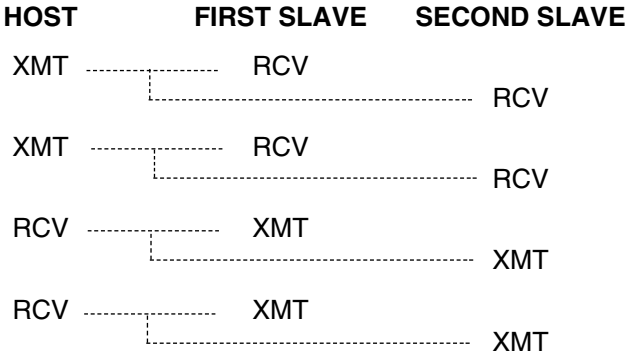

Figure 4-3. Two-pair star wiring for host and slave Cards.



Figure 4-4. Single-pair star wiring for host and slave Cards.

5. Operation and Diagnostics

Once you have configured each Multi-Function LD Card and connected the cables, you are ready to operate the units. This chapter describes the Card's LEDs, the power-up procedure, and diagnostic testing.

5.1 Status LEDs

The Multi-Function LD Card features 11 front-panel status LEDs (shown in Figure 5-1 below) that indicate the condition of the modem and the communication link.

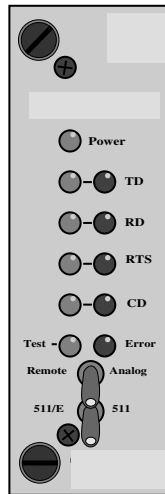

Figure 5-1. The Card's front panel.

5.1.1 THE TD AND RD INDICATORS

The TD and RD indicators (one red and one green LED for each signal) blink when data activity occurs: The red LEDs indicate a low RS-232 logic level, while the green LEDs indicate a high RS-232 logic level. Also, since RS-232 devices idle in a low state, the red LED will be steadily lit if the connections are correct and the RS-232 device is in an idle state.

5.1.2 THE RTS AND CD INDICATORS

The RTS and CD indicators (again, one red and one green LED for each signal) function much like the TD and RD LEDs: The red LEDs light for a “low” signal, while the green LEDs light for a “high” signal. The RTS LEDs light for an incoming RTS signal on the RS-232 side (DB25 Pin 4 or 10-pin RJ Pin 9). The CD LEDs light for an incoming signal on the line side and the resulting output signal on the RS-232 side (DB25 Pin 8 or 10-pin RJ Pin 3).

5.1.3 THE POWER INDICATOR

The green Power LED lights to indicate that the Card is receiving power.

5.1.4 THE TEST INDICATOR

The green Test LED lights to indicate that V.52 or V.54 tests are running.

5.1.5 THE ERROR INDICATOR

The red Error LED has three functions:

- A. When the Card is in test mode (green Test LED is lit), the Error LED glows red when bit errors occur.
- B. When the Card is not in test mode (green Test LED is dark), the Error LED is used to indicate an RTS streaming condition (see **Section 5.2.2**).
- C. The Error LED can also indicate line-quality problems (see **Section 5.2.1**) such as:
 1. The improper use of “flat satin” (non-twisted-pair) cable, or low-quality twisted-pair cable, to connect the modems.
 2. One or more broken wires in the 4-wire twisted-pair cable.
 4. Broken or corroded connectors.

5.2 Diagnostic Testing Using the Error LED

5.2.1 TESTING CABLE QUALITY

NOTE

The Error LED's circuitry is designed to detect line quality across 4-wire twisted-pair cable only, and might not function properly with 2-wire cable.

If there is any question as to the quality of your line, we recommend the following test:

1. Disconnect both local and remote modems from their attached RS-232 DTE devices. Make sure the red TD, RD, and RTS LEDs are all lit.
2. Set the input impedance of both modems to 200 ohms by setting switch S3 position 1 "On" and S3 position 2 "Off."
3. Set the data rate on both modems to 9.6 kbps by setting switch S1 position 1 "On," S1 position 2 "Off," S1 position 3 "Off," and S1 position 4 "On."
4. On the local modem, set carrier control for "Constantly on" by setting switch S1 position 8 "Off."
5. On the remote modem, set carrier control to "Controlled by RTS" by setting switch S1 position 8 to "On."
6. Move both front-panel toggle switches to the center (neutral) position. (The Test LED should not light.)
7. Connect both modems to the 4-wire twisted-pair cable to be tested. (See **Section 4.5** for pinouts and guidelines for this type of cable.)
8. Here's how to interpret the results:
 - A. If the quality of the line is good, neither modem's Error LED will light. The local modem's red CD LED will light, and the remote modem's green CD LED will light.
 - B. If there is flat satin cable in the line somewhere between the modems, the local modem's Error LED and green CD LED will both light. On the remote modem, the remote modem's green CD LED will light, but the Error LED will stay dark.

NOTE

We cannot guarantee that the Card will accurately detect small pieces of flat satin cable in the line if they are farther than 1500 ft. (457.2 m) from the local modem.

- C. If one wire among the four twisted-pair wires is broken, the Error LED and the green CD LED will both light on at least one of the modems.

5.2.2 DETECTING STREAMING ERRORS

When the Multi-Function LD Card is not in test mode (its green Test LED is dark), the front-panel Error LED can also indicate streaming errors. When the Card's antistreaming circuitry is enabled (one or both of switch S3 positions 7 and 8 set to "On"), the RTS signal from the attached DTE is timer-controlled. The timer begins to count down when the DTE raises RTS. If RTS remains high for longer than the preset timeout period, the antistream circuit will force RTS low. The Error LED will light, indicating a streaming condition (RTS continually on). This feature prevents a malfunctioning terminal from tying up a computer port in a multidrop or polling environment.

When the DTE drops RTS, the antistreaming timer is automatically reset and the Error LED goes dark. The timeout period is user-selectable for 12.5 or 50 seconds. See **Section 3.1.4**.

5.3 Power-Up

There is no power switch on the Multi-Function LD Card: Power is automatically applied to the Card whenever—and for as long as—its card-edge connector is plugged into the MicroRack's mid-plane socket and the MicroRack's power supply is turned on.

NOTE

The Multi-Function LD Card is a "hot-swappable" card—it will not be damaged by plugging it in or removing it while the rack is powered up.

When the local and remote Multi-Function LD Cards are *both* powered up and are passing data *normally*, the LEDs on the Cards will look like this:

- Power: Steadily lit
- TD and RD: Flashing red and green
- RTS and CD: Green steadily lit, red dark
- Test and Error: Dark

5.4 V.54 and V.52 Diagnostic Tests

The Multi-Function LD Card offers two V.54 test modes and two V.52 test modes to evaluate the condition of the modems and the communication link. Both sets of tests can be activated physically from the front panel. The V.54 test can also be activated from the RS-232 interface.

NOTE

V.54 and V.52 test modes on the Multi-Function LD Card are available for point-to-point applications only.

5.4.1 LOCAL ANALOG LOOPBACK (LAL)

The Local Analog Loopback (LAL) test checks the operation of the local Multi-Function LD Card, and is performed separately on each unit. Any data sent to the local Multi-Function LD Card in this test mode will be echoed (returned) back to the user device. For example, characters typed on the keyboard of a terminal will appear on the terminal's screen. To perform a LAL test, follow these steps:

1. Activate LAL. You can do this in either of two ways. One is to move the upper front-panel toggle switch labeled "Remote—Analog" to the "Analog" (right-hand) position. The other is to raise the signal on Pin 18 of the RS-232 interface (switch S3 position 5 must be "On"—see **Section 3.1.4**). Once LAL is activated, the Card's transmit output is connected to its own receiver. The Test LED should light.
2. Verify that the attached DTE is operating properly and can be used for a test.
3. Move the lower front-panel toggle switch labeled "511/E—511" to the "511" (right-hand) position. This will activate the V.52 BERT test mode and inject a 511 test pattern into the local loop. If any errors are present in the loop, the Error LED will blink *sporadically*.

4. If the BERT test indicates *no errors* are present, move the “511/E—511” toggle switch to the left-hand position to activate the “511/E” test with periodic errors. If this test is working properly, the Error LED will blink *regularly*. A successful 511/E test will confirm that the loop is in place, and that the Multi-Function LD Card’s built-in 511 generator and detector are working properly.
5. If the BERT test indicates that errors *are* present, make sure that the RS-232 cable connecting the DTE to the Multi-Function LD Card is wired straight-through, and is plugged in properly. Also, make sure that the Card is configured properly. Then recheck your DTE equipment. If you still get errors and can’t find the cause, call your supplier for technical support (see **Section 6.1**).

5.4.2 REMOTE DIGITAL LOOPBACK (RDL)

The Remote Digital Loopback (RDL) test checks the performance of both the local and remote Multi-Function LD Cards, and the communication link between them. Any characters sent to the remote Card in this test mode will be echoed (returned) back to the originating device. For example, characters typed on the keyboard of the local terminal will appear on the local terminal’s screen after having been passed to the remote Multi-Function LD Card and looped back. To perform an RDL test, follow these steps:

1. Activate RDL. You can do this in either of two ways. One is to move the upper front-panel toggle switch labeled “Remote—Analog” to the “Remote” (left-hand) position. The other is to raise the signal on Pin 21 of the RS-232 interface (switch S3 position 6 must be “On”—see **Section 3.1.4**). Once RDL is activated, the remote Card’s receive input is connected to its own transmitter. The Test LED should light on both Cards.
2. Verify that the DTE attached to the local Card is operating properly and can be used for a test.
3. Move the lower front-panel toggle switch labeled “511/E—511” to the “511” (right-hand) position. This will activate the V.52 BERT test mode and inject a 511 test pattern into the remote loop. If any errors are present in the loop, the Error LED will blink *sporadically*.

4. If the BERT test indicates *no errors* are present, move the “511/E—511” toggle switch to the left-hand position to activate the “511/E” test with periodic errors. If this test is working properly, the Error LED will blink *regularly*. A successful 511/E test will confirm that the loop is in place, and that the Multi-Function LD Card’s built-in 511 generator and detector are working properly.
5. If the remote BERT test indicates that errors *are* present, but the local analog loopback BERT tests showed that both Multi-Function LD Cards were functioning properly, there is probably a problem with the twisted-pair communication line connecting the two modems. A common problem is improper crossing of the pairs. Also, check the cable’s pinning (see **Section 4.5**) and continuity. If you still get errors and can’t find the cause, call your supplier for technical support (see **Section 6.1**).

5.4.3 USING THE V.52 BERT TEST INDEPENDENTLY

The Multi-Function LD Card can perform its V.52 BERT test independently of the V.54 loopback tests. This requires two operators: one to initiate and monitor the test at the local Card, and one to do the same at the remote Card. To use the V.52 BERT test by itself, both operators should simultaneously follow these steps:

1. Move the lower front-panel toggle switch labeled “511/E—511” to the “511” (right-hand) position. This will activate the V.52 BERT test mode and transmit a 511 test pattern to the other unit. If any errors are present, the receiving modem’s Error LED will blink *sporadically*.

NOTE

For this independent test to work properly, the “511/E—511” switch on both Multi-Function LD Cards must be set the same way (that is, moved to the “511” position for this step and to the “511/E” position for the next step).

2. If the BERT test indicates *no errors* are present, move the “511/E—511” toggle switch to the left-hand position to activate the “511/E” test with periodic errors. If this test is working properly, the receiving modem’s Error LED will blink *regularly*. A successful 511/E test will confirm that the link is in place, and that the Multi-Function LD Cards’ built-in 511 generators and detectors are working properly.

6. Troubleshooting

6.1 Calling Your Supplier

If you determine that your Multi-Function LD Card is malfunctioning, *do not attempt to alter or repair it*. Contact your supplier. The problem might be solvable over the phone.

Before you do, make a record of the history of the problem. Your supplier will be able to provide more efficient and accurate assistance if you have a complete description, including:

- The nature and duration of the problem.
- When the problem occurs.
- The components involved in the problem.
- Any particular application that, when used, appears to create the problem or make it worse.

6.2 Shipping and Packaging

If you need to transport or ship your Multi-Function LD Card:

- Package it carefully. We recommend that you use the original container.
- Before you ship a unit for repair or return, contact your supplier to get a Return Authorization (RA) number, and make sure you include everything you received with the unit when you ship it.

Appendix: Cable Recommendations

The Multi-Function LD Card has been performance-tested using twisted-pair cable with these characteristics:

Wire Gauge	Capacitance	Resistance
19 AWG	83 nf/mi. or 15.72 pf/ft.*	16.3 Ω/1000 ft. (53.5 Ω/km)
22 AWG	83 nf/mi. or 15.72 pf/ft.*	32.6 Ω/1000 ft. (107 Ω/km)
24 AWG	83 nf/mi. or 15.72 pf/ft.*	51.65 Ω/1000 ft. (169.5 Ω/km)
26 AWG	83 nf/mi. or 15.72 pf/ft.*	82.35 Ω/1000 ft. (270.2 Ω/km)

*Alternatively, 51.6 nf/km or 51.6 pf/m

If you use the Multi-Function LD Card with a different type of twisted-pair cable, make sure that the cable has characteristics similar to, or better than, those listed above (for example, lower capacitance or lower resistance).

Bench tests yield the following data-rate/maximum-distance results:

Data Rate in bps	Maximum Distance in miles (km)			
	19 AWG	22 AWG	24 AWG	26 AWG
57,600	12 (19.3)	7 (11.3)	5.3 (8.5)	4 (6.4)
38,400	13 (20.9)	7.5 (12.1)	6.2 (10)	4.2 (6.8)
28,800	14 (22.5)	8 (12.9)	6.6 (10.6)	4.6 (7.4)
19,200	16 (25.7)	8.5 (13.7)	7 (11.3)	5.1 (8.2)
14,400	17 (27.4)	11 (17.7)	9.2 (14.8)	6.5 (10.5)
9600	18.5 (29.8)	13 (20.9)	10.4 (16.7)	7.5 (12.1)
7200	19 (30.6)	13.5 (21.7)	10.9 (17.5)	8 (12.9)
4800	19.5 (31.4)	14 (22.5)	11.3 (18.2)	8.8 (14.2)
3600	20 (32.2)	14.5 (23.3)	11.5 (18.5)	8.8 (14.2)
2400	20.5 (33)	15 (24.1)	11.6 (18.7)	9 (14.5)
1800	20.5 (33)	15 (24.1)	11.5 (18.5)	8.9 (14.3)
1200	20 (32.2)	15 (24.1)	11.4 (18.3)	8.9 (14.3)

Many environmental factors can affect the maximum distances obtainable at a particular site. Use this table as a general guideline only.

MULTI-FUNCTION LD CARD

To gain optimum performance from the Multi-Function LD Card, please keep these guidelines in mind:

- Always use twisted-pair cable—this is *not* an option.
- Use twisted-pair cable with a capacitance of 20 pf/ft. (65.6 pf/m) or less.
- Avoid twisted-pair cable thinner than 26 AWG (that is, avoid higher AWG numbers than 26).
- Using twisted-pair cable with a resistance greater than that listed at the top of this page might reduce the maximum distance you can run the cable, but should not otherwise affect your system.



© Copyright 1995. Black Box Corporation. All rights reserved.

1000 Park Drive • Lawrence, PA 15055-1018 • 724-746-5500 • Fax 724-746-0746

Free Manuals Download Website

<http://myh66.com>

<http://usermanuals.us>

<http://www.somanuals.com>

<http://www.4manuals.cc>

<http://www.manual-lib.com>

<http://www.404manual.com>

<http://www.luxmanual.com>

<http://aubethermostatmanual.com>

Golf course search by state

<http://golfingnear.com>

Email search by domain

<http://emailbydomain.com>

Auto manuals search

<http://auto.somanuals.com>

TV manuals search

<http://tv.somanuals.com>