

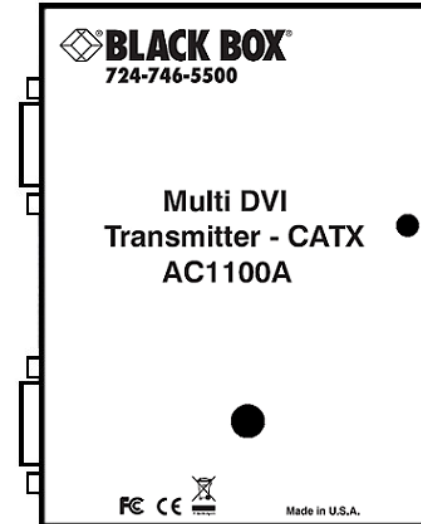

## Multi DVI System CATX Series



FEDERAL COMMUNICATIONS COMMISSION AND INDUSTRY CANADA RADIO FREQUENCY INTERFERENCE STATEMENTS

This equipment generates, uses, and can radiate radio-frequency energy, and if not installed and used properly, that is, in strict accordance with the manufacturer's instructions, may cause interference to radio communication. It has been tested and found to comply with the limits for a Class A computing device in accordance with the specifications in Subpart B of Part 15 of FCC rules, which are designed to provide reasonable protection against such interference when the equipment is operated in a commercial environment. Operation of this equipment in a residential area is likely to cause interference, in which case the user at his own expense will be required to take whatever measures may be necessary to correct the interference.

Changes or modifications not expressly approved by the party responsible for compliance could void the user's authority to operate the equipment.

*This digital apparatus does not exceed the Class A limits for radio noise emission from digital apparatus set out in the Radio Interference Regulation of Industry Canada.*

*Le présent appareil numérique n'émet pas de bruits radioélectriques dépassant les limites applicables aux appareils numériques de la classe A prescrites dans le*

*Règlement sur le brouillage radioélectrique publié par Industrie Canada.*



EUROPEAN UNION DECLARATION OF CONFORMITY

The manufacturer declares that this product meets the requirements of EU Directive 89/336/EEC.

NORMAS OFICIALES MEXICANAS (NOM) ELECTRICAL SAFETY STATEMENT INSTRUCCIONES DE SEGURIDAD

1. Todas las instrucciones de seguridad y operación deberán ser leídas antes de que el aparato eléctrico sea operado.
2. Las instrucciones de seguridad y operación deberán ser guardadas para referencia futura.
3. Todas las advertencias en el aparato eléctrico y en sus instrucciones de operación deben ser respetadas.
4. Todas las instrucciones de operación y uso deben ser seguidas.
5. El aparato eléctrico no deberá ser usado cerca del agua—por ejemplo, cerca de la tina de baño, lavabo, sótano mojado o cerca de una alberca, etc..
6. El aparato eléctrico debe ser usado únicamente con carritos o pedestales que sean recomendados por el fabricante.
7. El aparato eléctrico debe ser montado a la pared o al techo sólo como sea recomendado por el fabricante.
8. Servicio—El usuario no debe intentar dar servicio al equipo eléctrico más allá a lo descrito en las instrucciones de operación. Todo otro servicio deberá ser referido a personal de servicio calificado.
9. El aparato eléctrico debe ser situado de tal manera que su posición no interfiera su uso. La colocación del aparato eléctrico sobre una cama, sofá, alfombra o superficie similar puede bloquear la ventilación, no se debe colocar en libreros o gabinetes que impidan el flujo de aire por los orificios de ventilación.
10. El equipo eléctrico debe ser situado fuera del alcance de fuentes de calor como radiadores, registros de calor, estufas u otros aparatos (incluyendo amplificadores) que producen calor.
11. El aparato eléctrico deberá ser conectado a una fuente de poder sólo del tipo descrito en el instructivo de operación, o como se indique en el aparato.
12. Precaución debe ser tomada de tal manera que la tierra física y la polarización del equipo no sea eliminada.
13. Los cables de la fuente de poder deben ser guiados de tal manera que no sean pisados ni pellizcados por objetos colocados sobre o contra ellos, poniendo particular atención a los contactos y receptáculos donde salen del aparato.
14. El equipo eléctrico debe ser limpiado únicamente de acuerdo a las recomendaciones del fabricante.
15. En caso de existir, una antena externa deberá ser localizada lejos de las líneas de energía.
16. El cable de corriente deberá ser desconectado del cuando el equipo no sea usado por un largo periodo de tiempo.
17. Cuidado debe ser tomado de tal manera que objetos líquidos no sean derramados sobre la cubierta u orificios de ventilación.
18. Servicio por personal calificado deberá ser provisto cuando:
  - A: El cable de poder o el contacto ha sido dañado; u
  - B: Objetos han caído o líquido ha sido derramado dentro del aparato; o
  - C: El aparato ha sido expuesto a la lluvia; o
  - D: El aparato parece no operar normalmente o muestra un cambio en su desempeño; o
  - E: El aparato ha sido tirado o su cubierta ha sido dañada.

Contents

Chapter	Page
1. Specifications.....	3
2. Introduction .....	4
2.1 Overview.....	4
2.2 Package Contents .....	4
2.3 Equipment You May Also Need.....	4
2.4 Compatible Cabling .....	4
3. Setup and Installation.....	5
3.1 Cabling Considerations.....	5
3.2 Making the Connections.....	5
3.2.1 Connections and Setup in General .....	5
3.2.2 Connections on the Single-Port Multi DVI (AC1100A–AC1101A).....	6
3.2.3 Connections on the Dual Daisychainable Receiver (AC1102A) .....	7
4. Troubleshooting.....	8
4.1 Common Problems .....	8
4.2 Calling Black Box .....	8
4.3 Shipping and Packaging .....	8
Appendix A. Cabling Pinouts.....	9
Appendix B. Status LED's.....	10
Appendix C. Compression Mode.....	11
Appendix D. DDC Mode.....	12
Appendix E. Rackmounting Units .....	14

TRADEMARKS USED IN THIS MANUAL

Any trademarks mentioned in this manual are acknowledged to be the property of the trademark owners.

# 1. Specifications

<b>Cable Required:</b>	Between transmitter and receiver: Cat5/Cat6
<b>Compliance:</b>	CE; FCC Class A, IC Class A
<b>Video Support:</b>	DVI Single Link
<b>Resolution:</b>	1600x1200 , 1080P (if graphics card supports reduced clock rate)
<b>Transmission:</b>	Transparent to users
<b>Bandwidth:</b>	1.65 Gbps
<b>Maximum Distance:</b>	Total end to end over CAT5/CAT6: 600 ft (183m).
<b>Connectors:</b>	AC1100A: (1) RJ45, (2) DVI F; AC1101A: (1) RJ-45, (1) DVI F; AC1102A: (2) RJ-45, (1) DVI F; All: (1) power inlet
<b>Temperature Tolerance:</b>	Operating: 32 to 104°F (0 to 40°C); Storage: -4 to +140°F (-20 to +60°C)
<b>Humidity Tolerance:</b>	Up to 80% noncondensing
<b>Enclosure:</b>	Steel
<b>Power:</b>	From utility-power (mains) outlet to power inlet, through detachable external power supply: Input: 100 to 250 VAC @ 50 or 60 Hz (autosensing); Output: +5 VDC; Consumption: 5 watts maximum
<b>Size:</b>	1.2"H x 4.1"W x 5.5"D (3.1 x 10.4 x 14.0 cm)
<b>Weight:</b>	1.0 lb. (0.45 kg) (all units)

# 2. Introduction

## 2.1 Overview

The Multi DVI System extends DVI video signals over Cat5/6 cable. All models support single link DVI video modes.

This manual covers Multi DVI System units for video (AC1100A, AC1101A, AC1102A).

Multi DVI System receivers are available with single or dual daisychainable connections. The dual daisychainable receiver is used when the same signal is distributed to multiple display devices across a single cable in a daisychain or loop-through fashion. Setup and cabling are the same as the single-port receiver.

### WARNING

**This equipment is not intended for, nor does it support, distribution through an Ethernet fiber network. Do not connect these devices to any sort of networking or telecommunications equipment!**

## 2.2 Package Contents

You should have received the following when ordering a Multi DVI System receiver:

- The transmitter or receiver. unit
- External power supply (100–250 VAC, 50–60 Hz, autosensing) with cord.
- This manual.

## 2.3 Equipment You May Also Need

- Rackmount Brackets:  
For or single-port/dual daisychainable receivers:  
AC1011 for 3 units; AC1012 for 6 units;
- Stereo Audio cable.
- DVI Video cable.
- Serial cable.

## 2.4 Compatible Cabling

Cabling for the Multi DVI System must be Cat5/Cat6 cable pinned to the EIA T568B specification (see Appendix A).

## 3. Setup and Installation

### 3.1 Cabling Considerations

- We recommend mounting and connecting all cabling to the Multi DVI System components before applying power. Please note recommended power sequence below.

### 3.2 Making the Connections

#### 3.2.1 Connections and Setup in General

This section contains figures showing connections with the specific Multi DVI System models. In general, however, the connection and setup procedure at both transmitter and receiver ends is as follows:

*At the transmitter end:*

1. Connect the source video to the Multi DVI System transmitter video input port, which is a DVI connector labeled DVI IN.
2. If desired, attach a local monitor via the local monitor port to DVI OUT.
3. Connect the CAT5 cable to the transmitter.
4. Do not apply power to the transmitter at this time.

*At the receiver end:*

1. Connect the DVI OUT connector to the display unit,.
2. Make sure that the Cat5 cable connection from the transmitter or receiver are secure.
3. Apply power to the display, then to the receiver.
4. Next, the transmitter should be powered on and finally the video source signal. Reference Appendix B for Link status and LED indicator explanations.

If there are any problems at either end, see **Chapter 4**.

#### 3.2.2 CONNECTIONS ON THE SINGLE-PORT MULTI DVI

The AC1100A, AC1101A, AC1112A units support DVI video over CAT5 cable .

Figure 3-1 shows the video only Multi DVI System Transmitter connections, and Figure 3-2 shows the receiver connections.

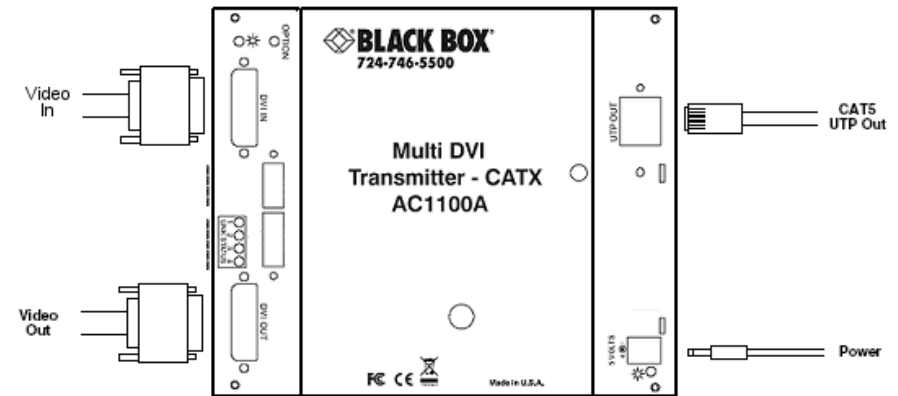

Figure 3-1. Transmitter connections on the AC1100A.

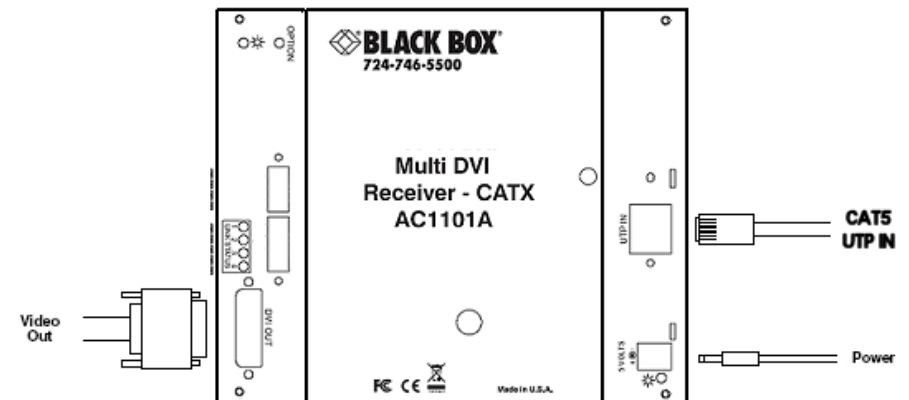

Figure 3-2. Receiver connections on the AC1101A.

### 3.2.3 CONNECTIONS ON THE DUAL DAISYCHAINABLE RECEIVER

The dual daisychainable receiver is used when the same signal is distributed to multiple display devices on a single cable in a daisychain or loop-through fashion. CAT5 Cable lengths must not exceed 600 ft between units.

Setup and cabling are the same as the single-port receiver, but the dual daisychainable model has an additional RJ-45 connector for linking to another dual daisychainable receiver or single-port receiver.

Figure 3-3 shows how connections are made on the dual daisychainable receiver.

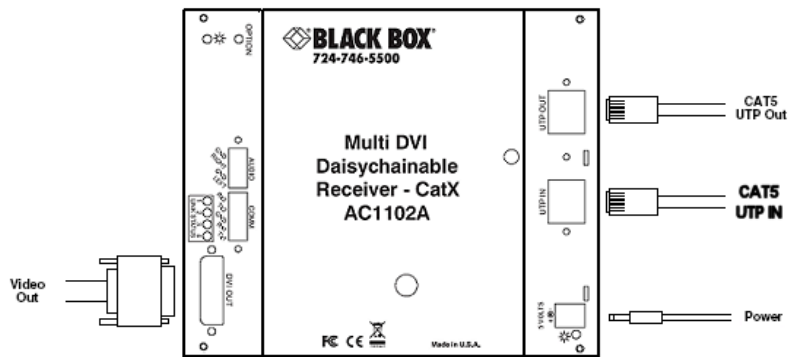

Figure 3-3. Dual daisychainable receiver connections on the AC1102A.

## 4. Troubleshooting

### 4.1. Common Problems

In most cases, nearly every issue with the Multi DVI System can be resolved by checking the Fiber optic or CAT5 cable and making sure that it's properly terminated and in the case of CAT5 cable, pinned to the TIA/EIA 568B wiring specification. However, there may be other problems that cause the system to not perform as it's designed. Below are solutions to the most common installation errors.

- |                  |   |
|------------------|---|
| <b>Problem:</b>  | No video signal at the transmitter local port or at the receiver.   |
| <b>Solution:</b> | <ul style="list-style-type: none"> <li>• Check that both units are powered.</li> <li>• Make sure the cable is terminated correctly.</li> <li>• Is the display device powered on and functioning?</li> <li>• Power on units in sequence (display, receiver, transmitter, video source).</li> <li>• Display may not be correctly identified by source device. See Appendix E for DDC communication issues.</li> </ul> |
| <b>Problem:</b>  | Video signal is poor.   |
| <b>Solution:</b> | <ul style="list-style-type: none"> <li>• See Appendix C for changing compression mode.</li> <li>• Check all cable connections.</li> <li>• The video signal's refresh rate may be set too high. Reset to a lower refresh rate in your monitor-configuration menu.</li> <li>• In 1080P mode, the PC graphics card needs to be set to reduced clock rate mode. Contact the graphics card manufacturer.</li> </ul>      |

### 4.2 Calling Black Box

If you determine that your Multi DVI System is malfunctioning, do not attempt to alter or repair it. It contains no user-serviceable parts. Contact Black Box at 724-746-5500.

Before you do, make a record of the history of the problem. We will be able to provide more efficient and accurate assistance if you have a complete description, including:

- the nature and duration of the problem.
- when the problem occurs.
- the components involved in the problem.
- any particular application that, when used, appears to create the problem or make it worse.

### 4.3 Shipping and Packaging

If you need to transport or ship your Multi DVI System:

- Package it carefully. We recommend that you use the original container.
- If you are shipping the Multi DVI System for repair, make sure you include everything that came in the original package. Before you ship, contact Black Box to get a Return Authorization (RA) number.

# Appendix A. Cabling Pinouts

# Appendix B. Status LED's

Table A-3. T568B CAT5 pinout

### T568B CAT5 Specification

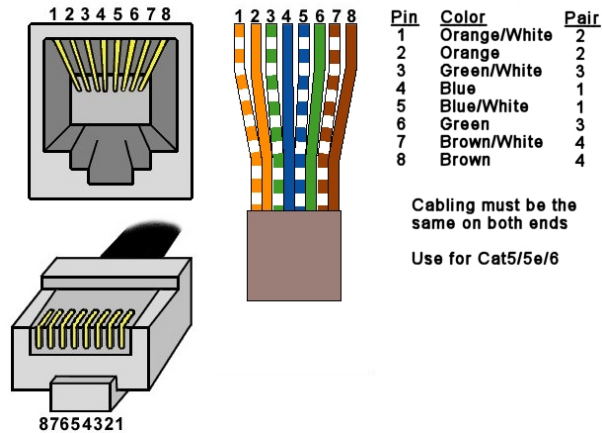

The Multi DVI System feature “status-at-a-glance” LED’s to ensure the units are functioning properly and to isolate problems with input signals, units, and/or cabling thus saving time during installation and troubleshooting. Reference the following tables for information on these indicators. The UTP connector also contains LED indicators on either side to provide visual cues on connection and traffic status.



Link Status LED's	
LED	Meaning
1	Normal Operation == OFF ON == EXCEPTION—a serious problem has occurred with the unit. Contact Technical Support.
2	Normal Operation == ON ON == Active DVI signal detected from source for transmitter side OR Active DVI display detected if receiver side
3	Normal Operation == ON Indicates active link between transmitter and receiver
4	Normal Operation == ON Indicates video packet transmission between transmitter and receiver

### Multi DVI RJ45 UTP status Indicators:

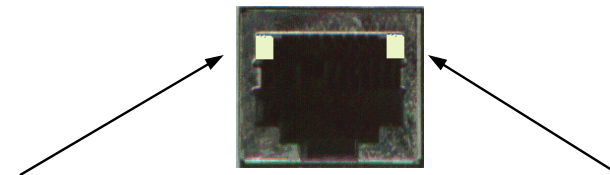

Left Side LED should blink when data is sent between transmitter and receiver. If no blinking occurs, check DVI signal input from the video source.

Right Side LED should be ON when communication is established between a transmitter and receiver. If it is off, check cabling between the units.

## Appendix C. Compression Mode

The Multi DVI System features two video compression modes to enable high resolution video extension over long distances. Compression modes may be changed with a simple jumper setting accessible through the front cover. **All units must be set to the same compression mode for proper operation.**

The two modes are:

Pixel Compression mode. Suitable for static non motion content. **DEFAULT**  
Jumper J10 IN

Color Compression mode. Suitable for moving content such as DVD movies.  
Jumper J10 OUT

To change the compression mode, remove the compression mode jumper access cover on the front of the Multi DVI unit and remove or install a jumper on J10 underneath

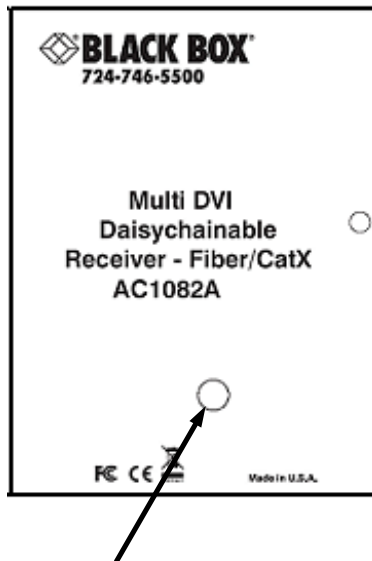

Figure C-1. Compression Mode Jumper Access

## APPENDIX D. DDC Modes

The Multi DVI System features the ability to send DDC display identifiers to the video source in order to determine display capabilities. The DDC is a data communication channel used in plug and play devices to accurately report a displays capabilities and identify the manufacturer. If this data is not available, the video source may revert to a low resolution or not display at all.

The Multi DVI features the ability to report a Universal Display (MRI Magic Display) that supports most popular VESA standards in standard or widescreen formats as well as the ability to clone an actual displays DDC information that is attached to either the local DVI output of the transmitter or a receivers DVI output.

The various modes are detailed below:

Mode 1: Universal Display (MRI Magic Display) (DEFAULT)

This mode reports a generic display supporting popular screen formats and is suitable for most if not all display types.

Mode 2: Clone DDC from DVI Output of transmitter

This mode copies the DDC from a display attached to the local output of the transmitter.

Mode 3: Clone DDC from receiver (first one if using daisychain options)

This mode copies the DDC data from a display attached to the receiver (first receiver if a daisychain mode is in use).

To change modes requires internal jumpers to be changed. See Figure E-1 for jumper locations (settings are stored in non-volatile RAM and are not lost when power is removed):

Mode 1: To restore, install jumper J20 while transmitter is power on. No other cable connections need to made.

Mode 2: To clone DDC from a display connected to the local DVI output of the transmitter, Install a jumper on J9 and J20 while transmitter is powered off, then connect the display to the transmitter and power it on. Remove J20 while transmitter is powered on and leave J9 in. The video source does not need to be connected.

Mode 3: To clone DDC from a display connected to the DVI output of the receiver, remove jumper on J9 , ensure J20 is in while transmitter is powered off, then connect the display to the receiver and the receiver to the transmitter and power everything on. Remove J20 while transmitter is powered on and leave J9 off. The video source does not need to be connected.

## APPENDIX D. DDC Modes

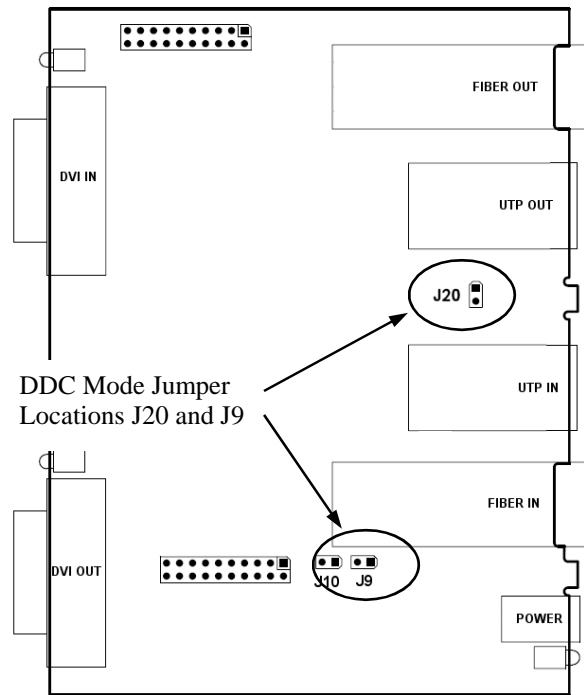

Figure D-1. Jumper locations to change DDC Mode.

## Appendix E. Rackmounting Units

The Rackmount Kits include brackets for mounting a transmitter, receiver, or a dual daisychainable receivers in a 19 rack. Figure F-1 shows the 2-Unit Rackmount Bracket (AC1011), which holds three units in a 19" x 1U rack.

Not shown are brackets for 6 units . The 6-Unit Transmitter/Receiver Bracket (AC1012) is like the AC1011 but occupies 2U of space instead of 1U in a 19" rack, stacking 3 units atop 3 units.

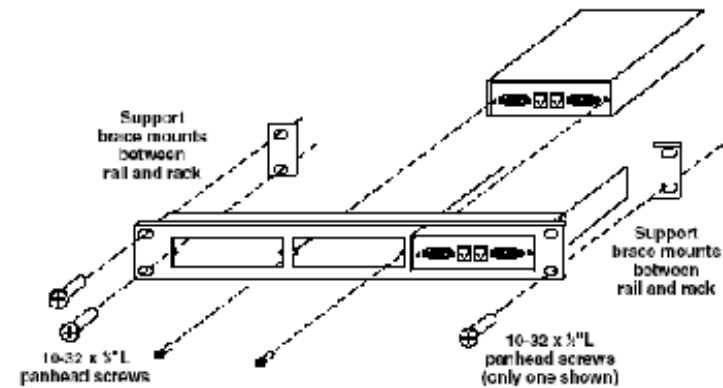

Figure E-1. Mounting with the AC1011 kit.



NOTES

NOTES

## Free Manuals Download Website

<http://myh66.com>

<http://usermanuals.us>

<http://www.somanuals.com>

<http://www.4manuals.cc>

<http://www.manual-lib.com>

<http://www.404manual.com>

<http://www.luxmanual.com>

<http://aubethermostatmanual.com>

Golf course search by state

<http://golfingnear.com>

Email search by domain

<http://emailbydomain.com>

Auto manuals search

<http://auto.somanuals.com>

TV manuals search

<http://tv.somanuals.com>