



MAY 2007
MC200A
Version 3

FaxReceiver MC200A ®



1000 Park Drive • Lawrence, PA 15055-1018 • 724-746-5500 • Fax 724-746-0746
© Copyright 2006. Black Box Corporation. All rights reserved.

Table of Contents

Table of Contents	2
Introduction	4
Easy Configuration	4
Features	4
System Architecture	4
Menu Map	5
The Process	6
Important Information	6
Connections	7
Reset Button	11
FAX CONFIGURATION UTILITY	12
General Settings	13
TCP/IP Settings	14
e-mail Settings	16
FAX Settings	17
TelNet Settings	19
Configuration	12
Benefits of using Telnet:	20
UNIT IP SETTINGS	23
UNIT EMAIL SETTINGS	25
UNIT FAX SETTINGS	28
TELNET	20
The FaxViewer	32
Troubleshooting	35
Glossary	39
Technical Specifications	41
Trademark Recognition	41
Legal Notices	42
Technical Support	48

COPYRIGHT

© Copyright 2006 Black Box. All rights reserved. No part of this publication may be reproduced, transmitted, transcribed, stored in a retrieval system, or translated into any language or any computer language, in any form or by any third party, without prior permission of Black Box.

DISCLAIMER

Black Box reserves the right to revise this publication and to make changes from time to time to the contents hereof without obligation to notify any person or organization of such revision or changes. Black Box has endeavored to ensure that the information in this publication is correct, but will not accept liability for any error or omission.

TRADEMARKS

All trademarks are hereby acknowledged.

VERSIONS

This manual is for FaxReceivers with code version A9.50 and higher, with FaxConfig up to version 1.08 or higher. The FaxViewer is version 1.05 or higher.

CODE CHANGES

Version a9.50 Uses DNS to determine the SMTP IP Address from it's URL.

Version b9.50 Adds a final confirmation message in the body of the email.

Version c9.50 allows you to set whether to notify the sending fax of an error (so that it will resend). Also states at the end of the email that the remote fax was or was not notified in the event of an error in transmission.

d9.50 Increased the ring delay timeout. It was 5 seconds, increased it to 15 seconds.

Introduction

The Black Box FaxReceiver MC200A is designed to receive a fax and convert it into an email to allow distribution that is more convenient and unwanted faxes can be electronically deleted. The Black Box Fax-Receiver receives the fax and puts it into a mail-server mailbox. From there, you or an administrator can read and re-distribute the fax to the appropriate email recipient on the network or print it if necessary. This reduces paper waste, speeds up the communication and distribution of information, allows automatic backup of received faxes and eliminates the need to maintain a fax machine solely for the purpose of receiving faxes.

Easy Configuration

The setup is done using Telnet, which allows configuration in any network environment like Windows, Unix or Apple. Any Workstation or PC with Telnet capabilities and access to the network can be used to configure the unit.

Features

- External all voltage power supply (100-240 Volts, 50-60 Hz)

- Extremely low power consumption of less than 5 watts.

- Remote management from any PC

- Retains its setup in Flash memory.

- Powers up in less than 10 seconds.

- Three login types, CRAM-MD5, LOGIN (AUTH=LOGIN) and non-authenticated.

System Architecture

The FaxReceiver MC200A uses a PCMCIA card to connect to the Fax Line; this allows the FaxReceiver MC200A to be used in any country in the world for which there is a PCMCIA fax/modem card available that fulfills the local standards.

The FaxReceiver MC200A connects directly to an Ethernet 10/100baseTx network via fixed IP or DHCP. Before operating the device a number of parameters have to be set up in the FaxReceiver MC200A to allow log on to your company or Internet provider's mail server.

3 different login types, CRAM-MD5, LOGIN (AUTH=LOGIN) and non-authenticated. It will try CRAM-MD5, first. If that fails, it falls back to insecure authentication (same as Outlook Express uses), and it will fall back further to non-authenticated login if that fails.

Setting up is achieved using the Telnet protocol and a telnet application is available for any operating system. Check your PC, Apple or Unix operator manual.

Since the device only relies on TCP/IP and SMTP it will work in any common network environment.

Menu Map

The menu driven setup allows the following parameters to be set up:

MENU ITEM	# CHARS	DEFAULT	FORMAT	REQD?
1) Setup IP			1	
2) Setup SMTP Mailserver			2	
3) Setup Fax			3	
4) Reboot after quitting		(Disabled)	toggle	
5) Change Telnet port	4	23	23	Y
6) Change Telnet session time-out	2	2	(0 to 50 minutes)	N
P) Change Telnet password	253			N
!) Redirect debug to this screen			toggle	
Unit IP settings				
1) Unit IP address	16	11.22.33.44	xxx.xxx.xxx.xxx	Y
2) Subnet Mask	16	255.255.255.0	xxx.xxx.xxx.xxx	Y
3) DNS Address 1	16	0.0.0.0	xxx.xxx.xxx.xxx	N
4) DNS Address 2	16	0.0.0.0	xxx.xxx.xxx.xxx	N
5) Unit Gateway address	16	0.0.0.0	xxx.xxx.xxx.xxx	Y
6) DHCP/RARP		Disabled	toggle	N
7) Timeserver 1 address	16	192.043.244.018	xxx.xxx.xxx.xxx	Y
8) Timeserver 2 address	16	000.000.000.000	xxx.xxx.xxx.xxx	N
9) Timeserver 3 address	16	000.000.000.000	xxx.xxx.xxx.xxx	N
Unit Email settings				
1) Mailserver SMTP address	58	0.0.0.0	xxx.xxx.xxx.xxx or URL.	Y
2) Mailserver SMTP IP port	4	25	###	Y
3) Mailserver login name	58		name@company.com	Y
4) Mailserver login password	58		password99	Y
5) Destination Email address	80 *1	fax@null	name2@company.com	Y
6) Reply email address	58	fax@null	name@company.com	
7) Reply Name	58	Fax	Any text up to 58 char	
6) Check Mailserver connection				
Unit Fax settings				
1) Fax reply I.D.	20	Black Box (R) Fax	Black Box (R) Fax	N
2) Fax number	20	<phone number>	724-746-0746	N
3) Fax location	28	<location>	Lawrence, PA	N
4) Company Name	28	<company>	Black Box	N
5) Scaling Percentage	3	100	(10-150 in incs of 5)	Y
6) Number of rings before answer	2	1	1-30	Y
7) Signal Transmission Errors		Yes	Toggle	N
8) Time Zone Offset	3	+0	(+/-0 to 13 hours)	Y
9) Daylight Saving		(Off)	toggle	N

*1 For FaxConfig enter each address on a separate line. For Telnet, separate with commas or semicolons.

Requirements

- ✓ AC power outlet within 10 feet.
- ✓ Telephone wall jack and cable to reach the FaxReceiver
- ✓ An Ethernet cable for the connection from the FaxReceiver to an Ethernet hub or switch connection that will connect to the mail server.

Important Information

NOTE: *The device is designed to operate in a typical office environment. Choose a location that is:*

- ✓ ***Well-ventilated and away from sources of heat including direct sunlight.***
- ✓ ***Away from sources of vibration or physical shock.***
- ✓ ***Isolated from strong electromagnetic fields produced by electrical devices.***
- ✓ ***Provided with a properly grounded wall outlet.***
- ✓ ***The modem/card can be installed in either the top or bottom slot.***

WARNING NOTES:

- ✓ ***Do not attempt to modify or use the supplied AC power cord if it is not the exact type required.***
- ✓ ***Whenever the chassis cover is to be removed, ensure that the system is disconnected from its power source and from all telecommunications links, networks, or modem lines.***
- ✓ ***Do not operate the system with the cover removed.***

THE PROCESS

A fax is received, a connection with the mail server is established, the fax is decoded and sent to the mail server as a GIF file for each page embedded in the email.

If you are private individual use your email account and password as you use for your existing mail client on your computer, this is all you need.

If you are a corporate user we recommend to set up a dedicated email account for the FaxReceiver i.e. fax1@mydomain.com and then copy the people to be informed of incoming faxes from this account. This allows you to keep a copy of every received fax in this account for recording purposes. It is up to you if you want to give each FaxReceiver its own mail account or if you want to use the Location Name to distinguish which device actually received the fax.

Installation

The illustration shows the setup of the ports and the diagnostic LEDs.

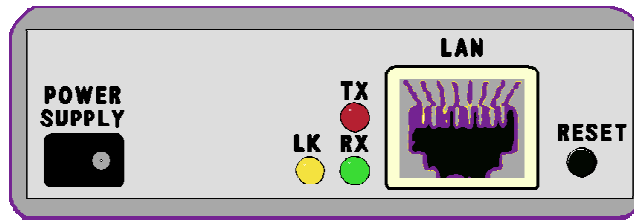

Connections

See the drawings on page 7 for installation examples.

Plug the PCMCIA modem card into the top **or** bottom slot.

Insert your Ethernet RJ45 connection into the **LAN** jack on the front.

NOTE: If you do not have your Ethernet connection plugged in, there will be no lights on power up.

The Modem's RJ11 phone line cable and adapter will plug into the modem card at the rear of the unit, with the other end into the RJ11 phone jack on the wall. **Alternatively** you may plug the FaxReceiver into a phone splitter.

NOTE: If you daisy chain from an outgoing fax machine, it should be set to either don't answer or answer after 4 rings or more so that the FaxReceiver will pickup first.

Connect the power cord to the Switch Mode Power Supply unit socket.

Plug the AC cord from the Switch Mode Power Supply into the 110V wall socket. There is a green light on the power brick that will come on.



Plug the DC wires from the Switch Mode Power Supply unit into the FaxReceiver.

NOTE: It will take about 10 seconds for the FaxReceiver to be ready to accept a fax or telnet connection.

When your Ethernet cable is connected to a network, the link light will be on.



NOTE: There is a green light inside the unit that can be seen. See the picture below.

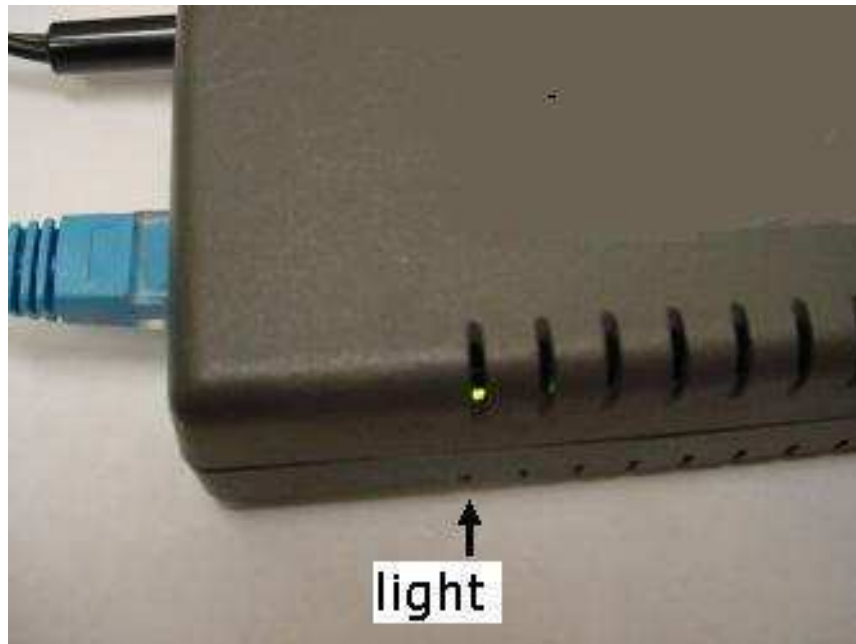

Typical installation replacing an incoming fax machine:

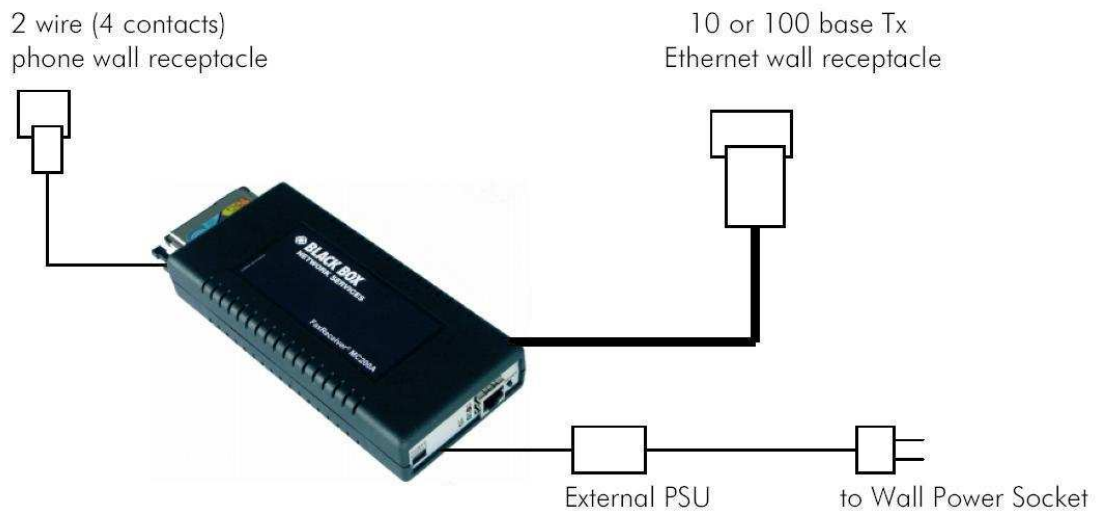

Installation where an outgoing fax machine is required on incoming line:

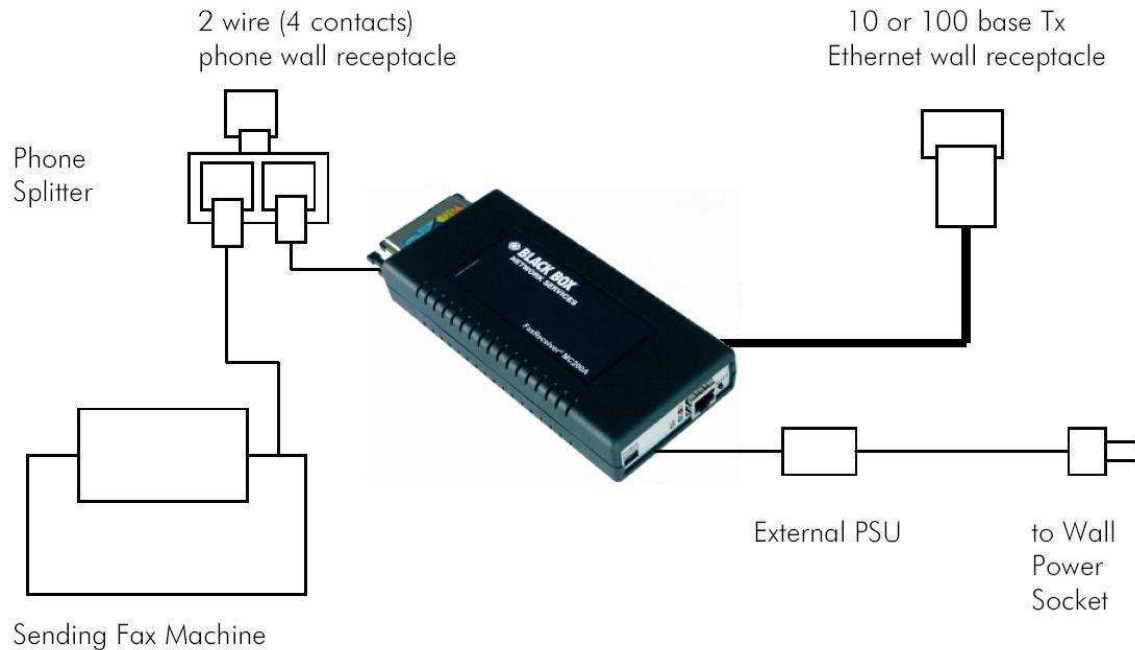

NOTE: If you daisy chain from an outgoing fax machine, it should be set to either not auto answer or answer after 4 rings or more so that the FaxReceiver will pickup first.

NOTE: You should also set the fax machine to tone dialing and not pulse dialing. Pulse dialing causes voltage spikes on the line that can be mistaken for an incoming ring, and the FaxReceiver will attempt to answer.

LEDs

The LEDs are itemized as follows:

LK (Yellow) LED

The Link LED indicates that the port is functionally connected to an external port. It lights up solid when the connected hub is turned on and connected to the LAN. If the LED does not light up, there may be a problem with the cabling or the Ethernet hub.

These last two LEDs enable monitoring of the traffic passing through the device.

TX (Red) LED

The Transmit LED blinks when a data packet is being *sent* from the FaxReceiver. This would indicate that a fax has been received.

RX (Green) LED

The Receive LED blinks when a LAN data packet is received. It is normal for this LED to blink all of the time as long as there is any LAN activity.

NOTE: The LED's are driven directly by the Ethernet chip. *If you do not have the Ethernet cable plugged in, the lights will not light, at power-up.*

Reset Button

When this button is pressed and held for ten seconds on power-up, the FaxReceiver will clear any surplus information it is holding and revert to the default settings.

NOTE: *If you reset the defaults, it will be necessary to telnet into 11.22.33.44 and reconfigure all of the parameters*

Configuration

The complete configuration can be done with any Telnet client, like HyperTerminal or simply using the Windows Command prompt "telnet". This will work on any FaxReceiver that is on the same virtual network.

Black Box has provided a FaxConfig utility that allows you to perform the basic IP configuration of any FaxReceiver that is on the same physical network.

These are the steps necessary to configure the FaxReceiver using the Windows command prompt telnet client.

FAX CONFIGURATION UTILITY

There is a FaxConfig utility on the CDROM in the **Fax Configure Tool** directory of the CDROM. You can run this utility from the CDROM or drag it to your PC.

NOTE: The FaxConfig utility will only communicate properly with devices on its local network or on 11.22.33.44.

- 1) Double-click on the FaxConfig utility to start it. It will bring up the following screen:

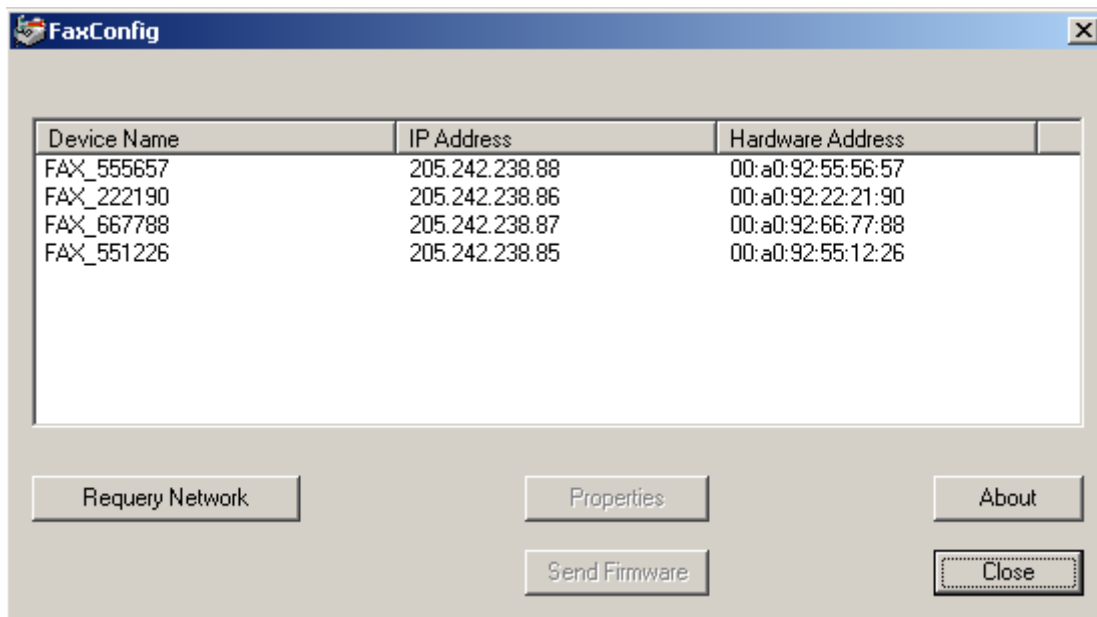

- 2) If it does not see the FaxReceiver, check the connections and power, and then click on the **Requery Network** button. If changes were made using Telnet, you should click on the **Requery Network** button. If you have connected the FaxReceiver since starting FaxConfig utility, use the **Requery Network** button to discover it.

General Settings

Using your mouse, double-click on the **IP Address** of the FaxReceiver to view or configure the properties of, or click once to select it and then click the **Properties** button and it will bring up the following screen:

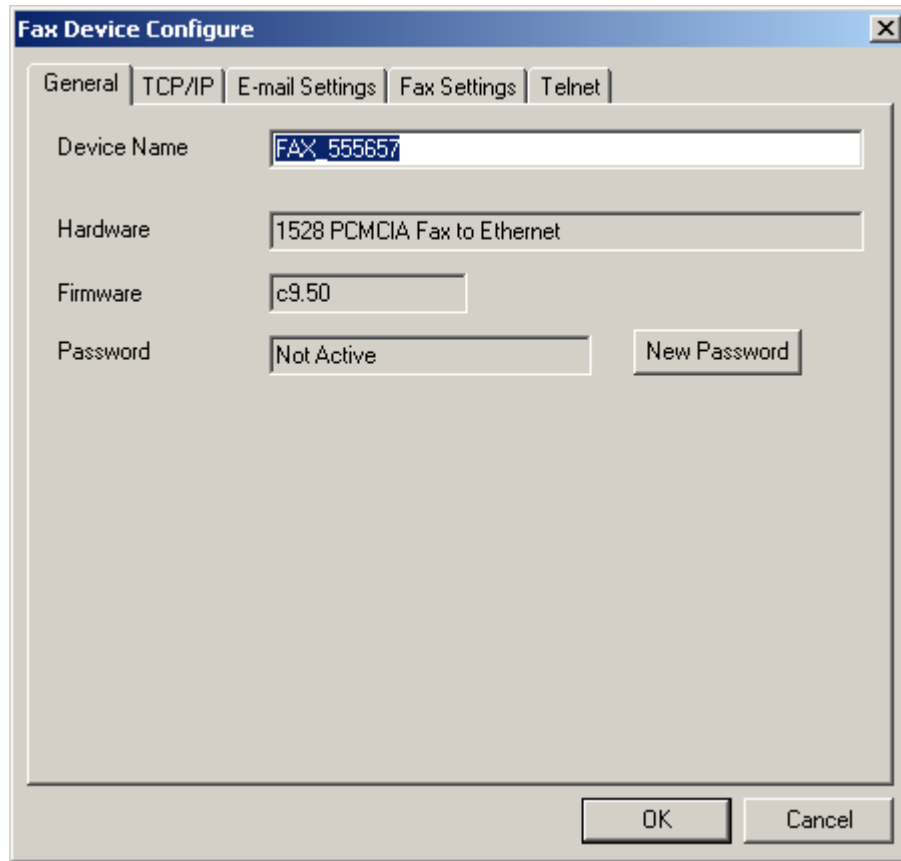

- 1) The default Device Name is derived from the FaxReceiver's Hardware Address. You can change it to something that will better identify it for you if you have multiple FaxReceivers.
- 2) The Hardware description and Firmware revision is provided for technical support.
- 3) If you click on the **OK** button it will save the parameters and exit the Properties window for that IP Address. Click on the **TCP/IP** tab.

TCP/IP SETTINGS

The screenshot shows the 'Fax Device Configure' dialog box with the 'TCP/IP' tab selected. The 'Device Name' is 'FAX_555657'. The 'IP Address' is '11.22.33.44', 'Subnet Mask' is '255.255.255.0', 'Default Gateway' is '0.0.0.0', 'DNS Server 1' is '0.0.0.0', 'DNS Server 2' is '0.0.0.0', 'Mail Server SMTP Address' is '0.0.0.0', 'Time Server IP 1' is '192.43.244.18', 'Time Server IP 2' is '0.0.0.0', and 'Time Server IP 3' is '0.0.0.0'. The 'DHCP/RARP Enable' checkbox is unchecked. 'OK' and 'Cancel' buttons are at the bottom right.

- 1) Enter an unused IP Address from your network, or click on the DHCP/RARP Enable.

NOTE: If you change to an address that is NOT in the same network range that your PC is, you will still be able to see the FaxReceiver with the FaxConfig utility, but you will not be able to change any parameters until you are on the same subnet.

- 2) If you are not using DHCP or RARP, make certain that the Subnet Mask is correct.
- 3) If you are not using DHCP or RARP, set the Default Gateway.
- 4) The Mail Server SMTP Address can be entered either as a URL (for example smtp-server.austin.rr.com) or an IP Address. Using the URL is recommended if you may be changing ISP's, and have your own mail server that will retain the same name.
- 5) DNS Server 1 and 2 are the Domain Name Servers provided by your ISP. It is used to convert the Mail Server SMTP Address's URL to an IP Address.

- 6) Time Server IP 1,2, & 3. The 192.043.244.018 address is the time server at NCAR. You can change this to a preferred timeserver and add two more timeservers. Without a timeserver the timestamp will be incorrect and your spam filter may trap the email.

NOTE: All timeservers send the time UT. In order to set the time stamps correctly you must adjust your **Time Zone Offset** under the **Fax Settings** tab. There is a list of public timeservers at this URL:

<http://tf.nist.gov/service/time-servers.html>

Click on the **E-mail Settings** tab.

E-MAIL SETTINGS

The screenshot shows a dialog box titled "Fax Device Configure" with a close button (X) in the top right corner. It has five tabs: "General", "TCP/IP", "E-mail Settings" (which is selected), "Fax Settings", and "Telnet". The "E-mail Settings" tab contains the following fields:

- Device Name: FAX_555657
- Mail Server SMTP Address: wpm-uk-mail-1.cryohost.net
- Mailserv SMTP IP Port: 25 (with a note "(1 - 9999) Default 25")
- Mailserv Login Name: (empty)
- Mailserv Login Password: (empty)
- Reply e-mail Address: fax@null
- Reply Name: Fax
- Destination e-mail Address(es): fax@null

At the bottom of the dialog box are "OK" and "Cancel" buttons.

- 1) **Mail Server SMTP Address** – Use the TCP/IP tab to change this.
- 2) **Mailserv SMTP IP Port** – The default is 25. This is most common. Other common ports used are 26, and 2525.
- 3) **Mailserv Login Name** – Often this is an email address. When a fax is received in the email box, it will come from this user. Max 58 characters.
- 4) **Mailserv Login Password** – This is the password for the above email account. There is a maximum of 58 characters. **NOTE:** case-sensitive.
- 5) **Reply e-mail Address** – If the person who receives the fax does a reply, it will go to this address.
- 6) **Reply Name** – This is the name that shows in the email header when you receive a fax.
- 7) **Destination e-mail Address(es)** - This is where the email will be sent. This can be the same as item 2) or it may be an alias set up to forward to multiple users. Simply enter the addresses you wish to send to as one entry, each address separated by either a semi-colon (;) or a comma (,). There is a limitation of a maximum of 80 characters for all addresses. Max 80 characters. No spaces are allowed. Enter each address on a new line.

Select the **Fax Settings** tab.

FAX SETTINGS

The screenshot shows a dialog box titled "Fax Device Configure" with a close button (X) in the top right corner. The "Fax Settings" tab is selected, and the following fields are visible:

- Device Name: FAX_555657
- Fax Reply ID: BlackBox (R) Fax
- Fax Number: 101
- Fax Location: Technical Support office
- Company Name: BlackBox
- Scaling Percentage: 100 (dropdown menu)
- Answer Delay (0 - 30): 1
- Time Zone Offset: -6:00 (dropdown menu)
- Signal Transmission Errors:
- Daylight Savings Enable:

At the bottom right, there are "OK" and "Cancel" buttons.

- 1) **Fax reply I.D.** is sent to the Sending Fax. 20 characters. This is usually displayed on the display of the sending fax after establishing contact, or recorded in its log/print-out. It is not mandatory to have an ID. If it is not set, the FaxReceiver will send an ID of 20 spaces to the distant fax.
- 2) **Fax number** – This is the telephone number of the FaxReceiver. Not required. Max 20 characters.
- 3) **Company Name** – This is the company that is the proud owner of the FaxReceiver. Not required. Max 28 characters.
- 4) **Fax Location** – This can identify the specific location of the phone line in the building or the city that the FaxReceiver is located in. Not required. Max 28 characters.
- 5) **Scaling Percentage** – This allows you to reduce or increase the size of the graphical image by a percentage (10-150 in increments of 5). The quality will be best if left at 100%. The FaxViewer software will automatically size the GIF at an easy to view size.

- 6) **Answer Delay** – This specifies the number of rings before the FaxReceiver answers the call. This would be used if you have the FaxReceiver daisy-chained with a regular phone that you answer first. Maximum is 30 rings.
- 7) **Time Zone Offset** – This is the offset from UT. If you are in Greenwich, England, this number will be 0. If your time zone is east of Greenwich, England), the number is positive. If your time zone is west of GMT, the number is negative. For EST, use -5, CST -6, MST -7, PST -8, AKST -9, and HAST -10.
- 8) **Signal Transmission Errors** – This is a diagnostic tool that will let you know if you are experiencing phone line problems. Many of these errors will not occur to a degree that will result in a complete failure.
- 9) **Daylight Savings Enable** – From Spring to Fall when Daylight Savings is observer, this should be enabled.

Click on the **Telnet** tab

TELNET SETTINGS

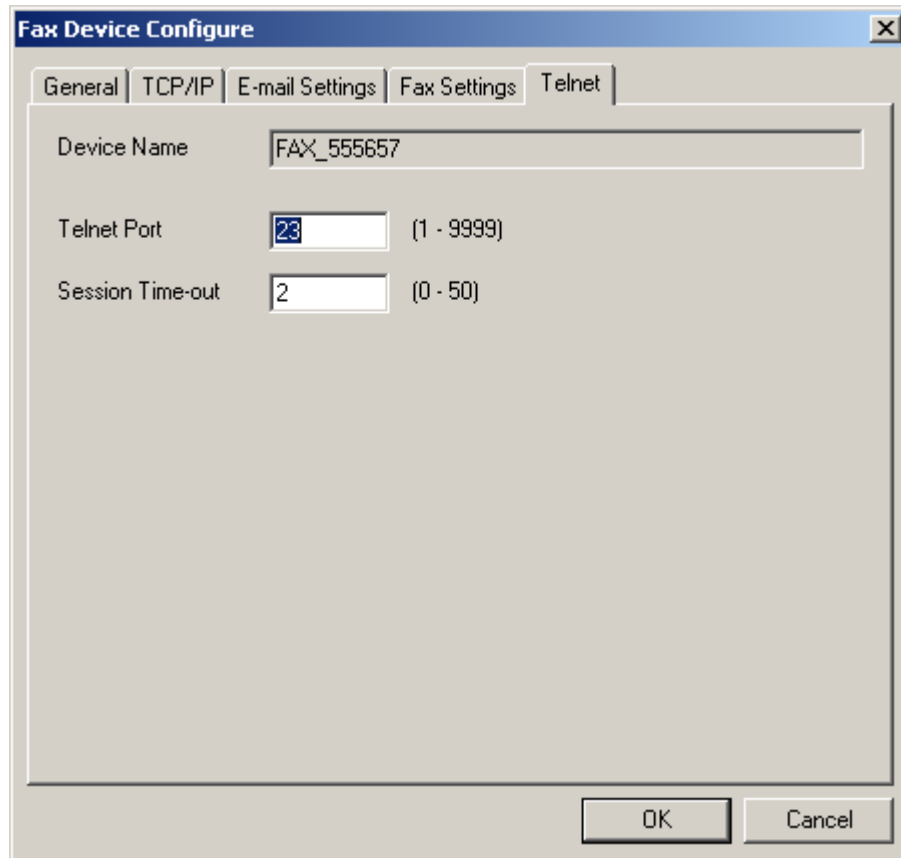

Select the **TelNet** tab.

- 1) **Telnet port** – This will enable the end user to set up a port that the company does not block (e.g. port 80 or even port 25). That means that you will be able to telnet into the FaxReceiver from your desk, enable debug, send a fax to the unit (also from your desk), and figure out what is going wrong. If you change the TELNET port number and don't reboot, the new number takes effect on the *second* new telnet session. i.e. open telnet on default port 23. Change to port 1234 and do a quit/save. Open another telnet session, still on port 23, and quit. All following telnet sessions must be on port 1234.

Session Time-out – This option allows you to keep your telnet session active longer if you have a lot of interruptions while configuring the FaxReceiver. If you specify zero as the Telnet session time-out, the session will never time-out.

- 2) Click the **OK** button to exit the **FaxDevice Configure** for this device.
- 3) Click the **Close** button to exit FaxConfig utility.

TELNET

Once you have configured the initial IP address or set your PC to the same network as the FaxReceiver, you can use Telnet to configure the parameters.

BENEFITS OF USING TELNET:

- 1) You can use HyperTerminal or any other telnet utility to perform the setup procedures.
- 2) The FaxReceiver does not have to be on the same physical network as long as you have a virtual connection to the network that it is attached to.
- 3) There are additional debug features available in Telnet that are not available in the NPMP client.

This guide covers using the telnet utility that comes with Windows.



- a. Click on the Windows  button in the lower left, and select **Run...**

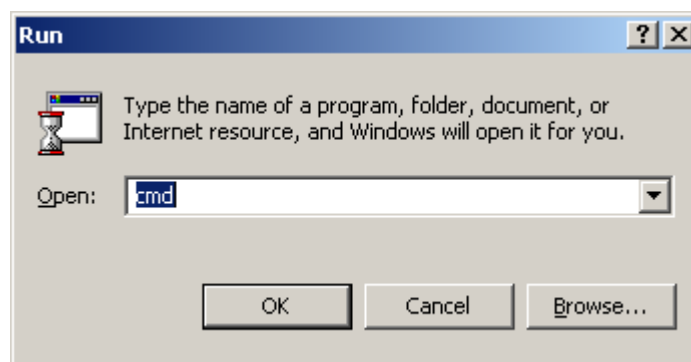

- b. Type in **CMD** and press the **Enter** key. This will take you to the command prompt shown below.

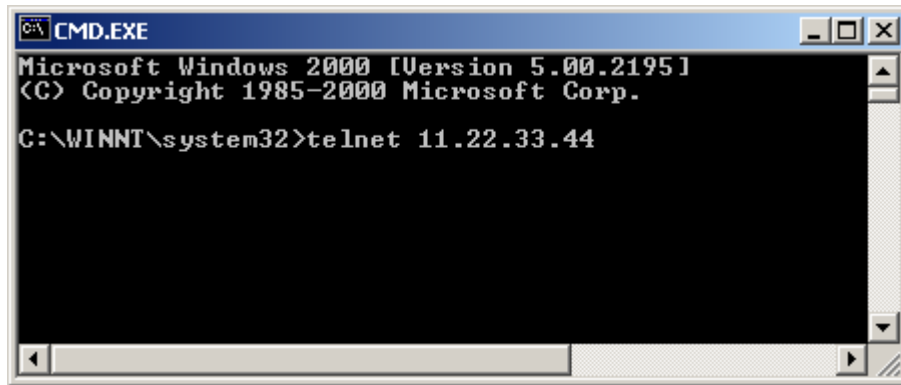

- c. Type in "telnet xx.xx.xx.xx" (where xx.xx.xx.xx is the IP address that you configured for the FaxReceiver) and press Enter.

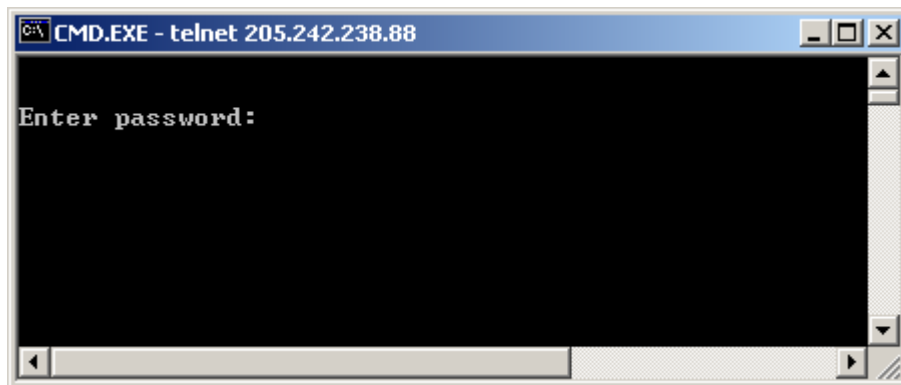

- d. If a password was set will respond "Enter Password". If a password has not been set, you will *not* be prompted for a password when you telnet into the device.

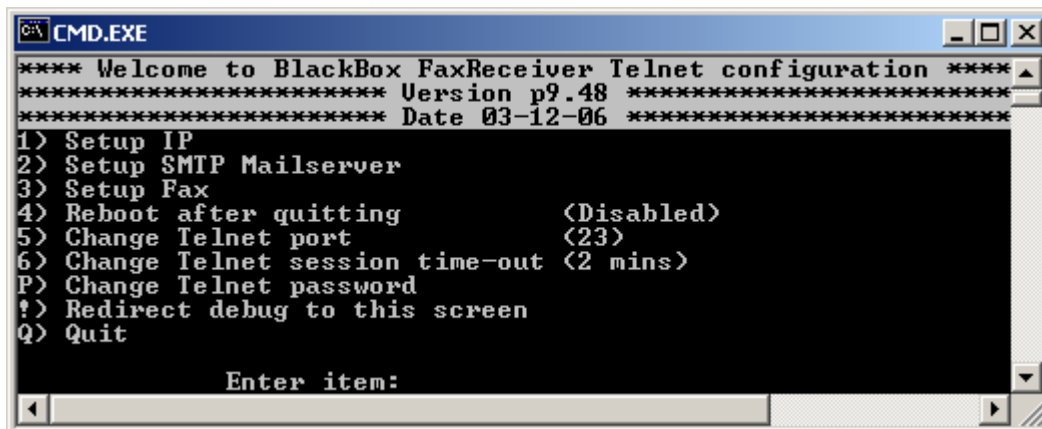

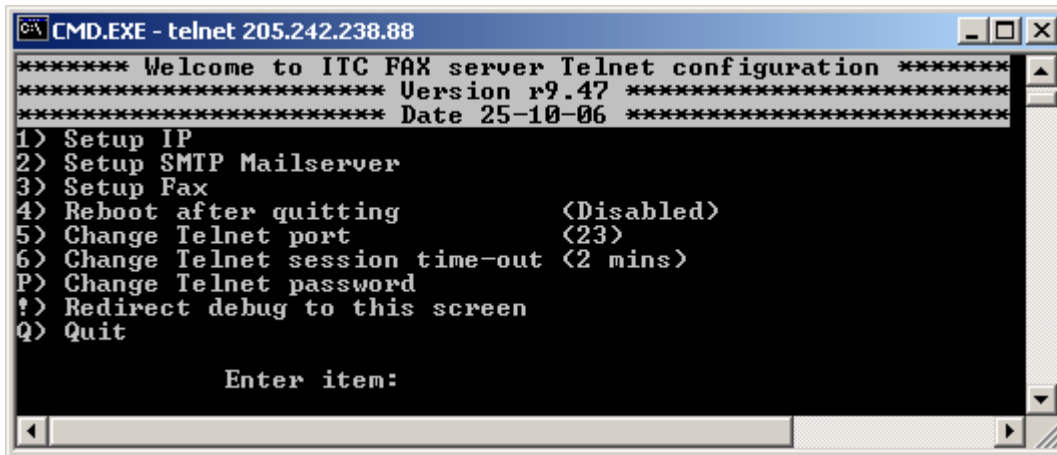
A screenshot of a Windows command prompt window titled "CMD.EXE - telnet 205.242.238.88". The window displays a text-based menu for "ITC FAX server Telnet configuration". The menu items are: 1) Setup IP, 2) Setup SMTP Mailserver, 3) Setup Fax, 4) Reboot after quitting (Disabled), 5) Change Telnet port (23), 6) Change Telnet session time-out (2 mins), P) Change Telnet password, !) Redirect debug to this screen, and Q) Quit. Below the menu, it says "Enter item:". The window has standard Windows window controls (minimize, maximize, close) in the top right corner.

```
***** Welcome to ITC FAX server Telnet configuration *****
***** Version r9.47 *****
***** Date 25-10-06 *****
1) Setup IP
2) Setup SMTP Mailserver
3) Setup Fax
4) Reboot after quitting      (Disabled)
5) Change Telnet port        (23)
6) Change Telnet session time-out (2 mins)
P) Change Telnet password
!) Redirect debug to this screen
Q) Quit

Enter item:
```

For each line item to be altered, type the option or menu number and press the Enter key, then enter the information and press the Enter key.

NOTE: If you leave the telnet session inactive for over two minutes, it will time out, disconnect, and report: "Inactivity Timeout (2 minutes) – disconnecting". You can change this timeout, with option number 6. If you set it to 0, it will not timeout. This parameter resets to 2 after each time you quit.

NOTE: After each entry that you make, you will get a confirmation message: "Are you sure you want to make this change (Y/N) Y". If you do not wish to change it, you can select N.

NOTE: Most setup changes take effect immediately you select Y and press Enter. The only exceptions are the IP parameters for the unit itself. These parameters cannot take effect immediately, because a change to those would cut off the telnet session. For these parameters, you must quit the setup and save the parameters. You must also either reset the power to the unit or set **4) Reboot after quitting** to Enabled, before you quit the setup.

NOTE: If you quit *without* saving, the unit re-reads all the parameters from Flash, and so will overwrite all the new settings with the previously saved settings. If you do a Quit and Save, the new parameters are all written to Flash so they will be retained through a power cycle.

NOTE: If you do a Quit and Save, the new parameters are all written to Flash so they will be retained through a power cycle. To test parameter changes you can quit *without* saving. A quit without saving also takes place if telnet times out. The parameters are still active, unless power is removed. Therefore if the changes work, then you would telnet back in, then Quit and Save. If they did not work, unplug power to restore the original parameters.

UNIT IP SETTINGS

Enter a **1** to configure the IP addresses of the FaxReceiver ModuLAN 200.

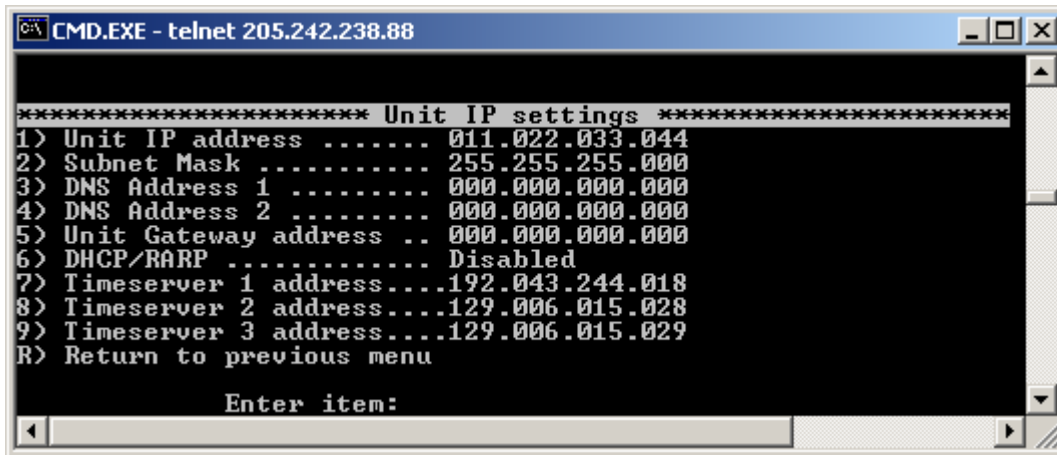

Your Network Administrator should provide the Unit IP and Unit Gateway address.

- 1) **Unit IP address** 011.022.033.044 – should be changed to an unused IP address on your network.

NOTE: If you use static IP addressing, and you have a DHCP server, this IP address should be added to your DHCP Server's static IP address list.

NOTE: If you enter an invalid IP address format, you will get a ">>>>> **Not a valid IP address Format**" message.

- 2) **Subnet Mask** – Enter the subnet mask used for your network.
- 3) **DNS Address 1** – Enter the primary DNS Server's IP address provided by your ISP for your network.
- 4) **DNS Address 2** - Enter the secondary DNS Server's IP address provided by your ISP for your network.
- 5) **Gateway Address** 011.022.033.001– should be changed to the IP address of your default gateway. Typically, this is the lowest address on the subnet, for example 192168100.**001**.
- 6) **DHCP/RARP** – This is a toggle. Entering **3** will switch from Disabled to Enabled and back.

NOTE: If you change to an address that is NOT in the same network range that your PC is, you will still be able to see the FaxReceiver with the FaxConfig utility, but you will not be able to change any parameters until you are on the same subnet. If you use DHCP or RARP you must figure out what IP address it obtained. Methods for doing this are covered in the troubleshooting section.

5, 6, 7) **Timeserver 1 address**....192.043.244.018 – The 192.043.244.018 address is the time server at NCAR. You can change this to a preferred timeserver and add two more timeservers. Without a timeserver the timestamp will be incorrect and your spam filter may trap the email.

NOTE: All timeservers send the time UT. In order to set the time stamps correctly you must adjust your **Time Zone Offset** in the **Setup Fax** section. There is a list of public timeservers at this URL:

<http://tf.nist.gov/service/time-servers.html>

R) Press **R** when the Unit IP settings are all configured to return to the top menu.

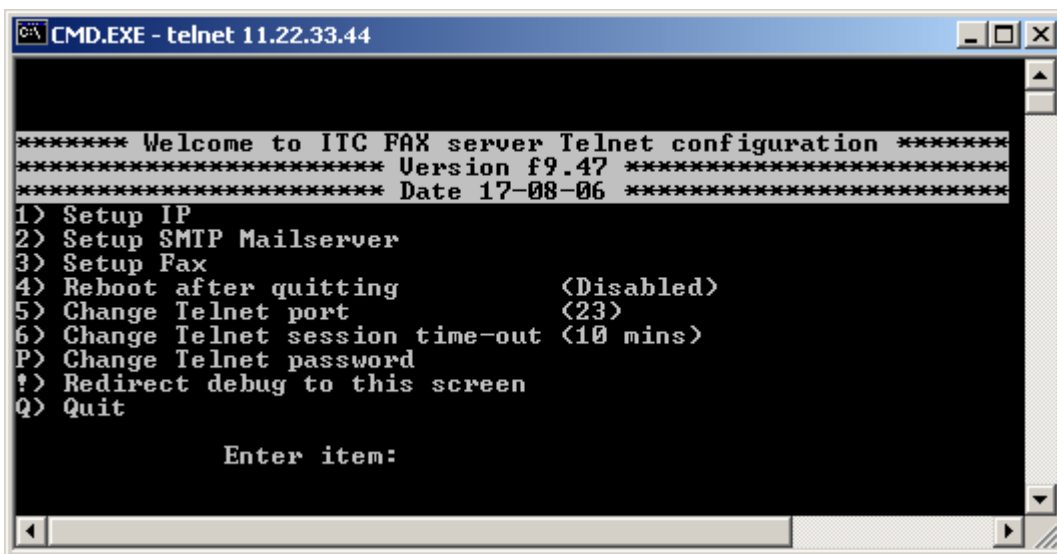

NOTE: Unlike all of the other setup parameters, IP addresses do not take effect immediately, because a change to those would cut off the telnet session. You can use the "Reboot after quitting" to enable the IP addresses without disconnecting power.

To enable IP Addresses:

- 1) Save each setting.
- 2) In the initial menu, set "**Reboot after quitting**" to **Enabled**.
- 3) Use **Q** to quit and select **Y** to the question: "**Do you want to save your changes before quitting (Y/N)**".

UNIT EMAIL SETTINGS

Enter a **2** to setup the SMTP Mailserver.

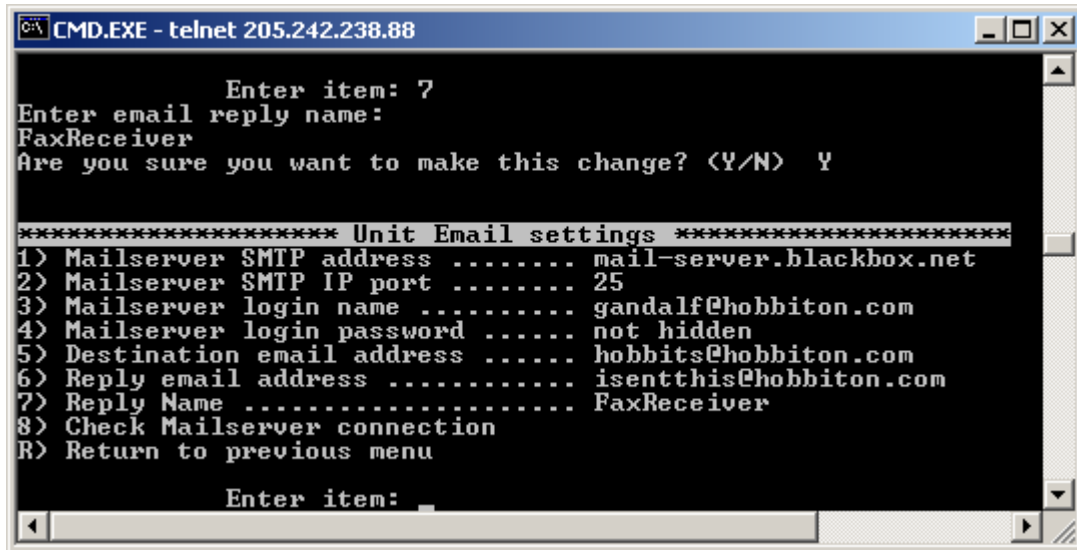

```
CMD.EXE - telnet 205.242.238.88
Enter item: 7
Enter email reply name:
FaxReceiver
Are you sure you want to make this change? (Y/N) Y

***** Unit Email settings *****
1) Mailserver SMTP address ..... mail-server.blackbox.net
2) Mailserver SMTP IP port ..... 25
3) Mailserver login name ..... gandalf@hobbiton.com
4) Mailserver login password ..... not hidden
5) Destination email address ..... hobbits@hobbiton.com
6) Reply email address ..... isentthis@hobbiton.com
7) Reply Name ..... FaxReceiver
8) Check Mailserver connection
R) Return to previous menu

Enter item: _
```

Your email service administrator should provide the items 1-5. In some cases the Mailserver login name and Destination Email address will often be the same email address.

- 1) Mailserver SMTP IP address** – The Mail Server SMTP Address can be entered either as a URL (for example smtp-server.austin.rr.com) or an IP Address. Using the URL is recommended if you may be changing ISP's, but have your own mail server.
- 2) Mailserver SMTP IP port** – The default is 25. This is most common. Other common ports used are 26, and 2525.
- 3) Mailserver login name** – Often this is an email address. When a fax is received in the email box, it will come from this user. Max 58 characters.
- 4) Mailserver login password** – This is the password for the above email account. There is a maximum of 58 characters. NOTE: passwords are case-sensitive.

NOTE: If you enter the wrong login or password, it will still login non-authenticated. The functionality available to a non-authenticated login depends entirely on the way the mailserv is set up. Some mailservers, for example, will accept emails to local addresses, but not to foreign addresses. Some mailservers will not allow anything to be sent, and some will allow everything to be sent.

- 5) Destination Email address** – This is where the email will be sent. This can be the same as item 2) or it may be an alias set up to forward to multiple users. Max 80 characters. Separate each address with commas or semicolons. Do **NOT** put spaces in.

- 6) **Reply e-mail Address** – If the person who receives the fax does a reply, it will go to this address.
- 7) **Reply Name** – This is the name that shows in the email header when you receive a fax.
- 8) **Check Mailserver connection** – After you have set the parameters, use option 6 to send a test email to verify your email settings.

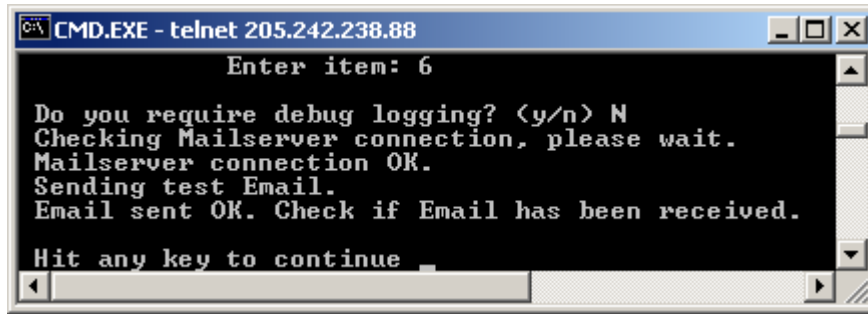

```
CMD.EXE - telnet 205.242.238.88
Enter item: 6
Do you require debug logging? <y/n> N
Checking Mailserver connection, please wait.
Mailserver connection OK.
Sending test Email.
Email sent OK. Check if Email has been received.
Hit any key to continue
```

You will get an email similar to the below.

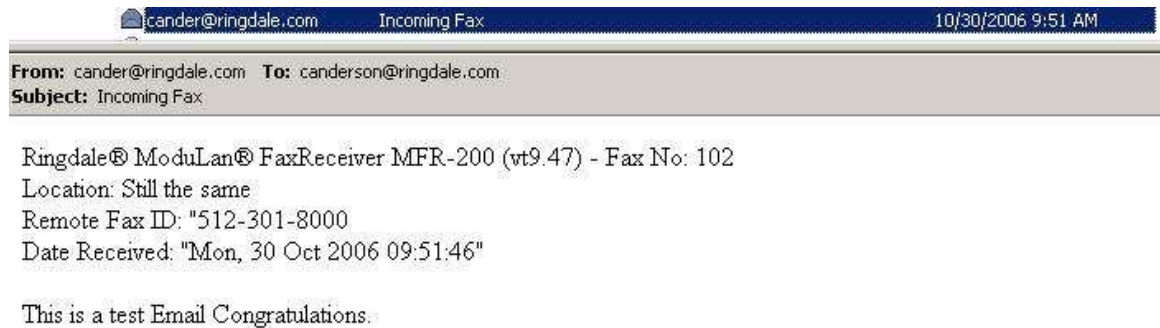

R) Press **R** when you have the Unit Email settings configured.

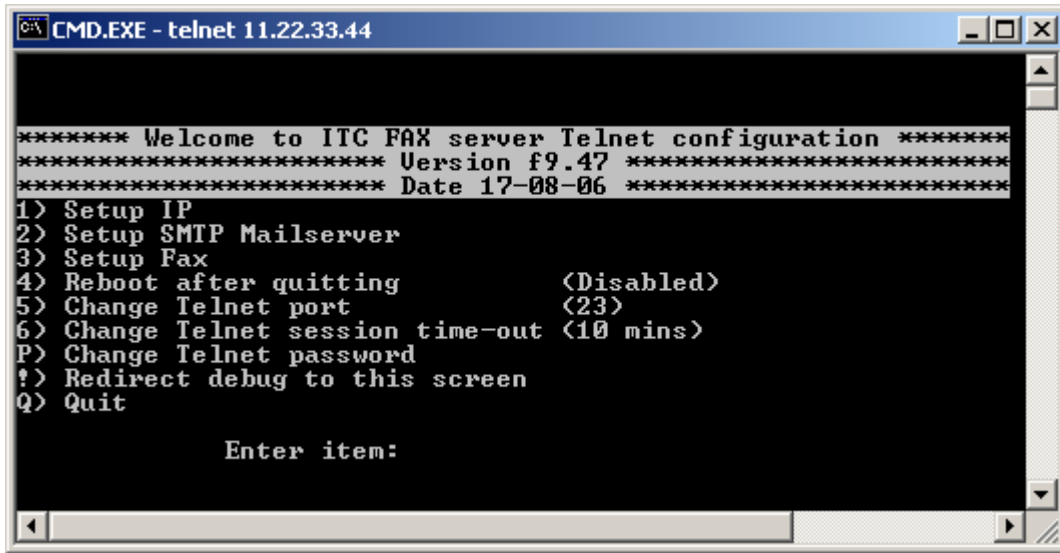

```
CMD.EXE - telnet 11.22.33.44

***** Welcome to ITC FAX server Telnet configuration *****
***** Version f9.47 *****
***** Date 17-08-06 *****

1) Setup IP
2) Setup SMTP Mailserver
3) Setup Fax
4) Reboot after quitting          (Disabled)
5) Change Telnet port            (23)
6) Change Telnet session time-out (10 mins)
P) Change Telnet password
!) Redirect debug to this screen
Q) Quit

Enter item:
```

UNIT FAX SETTINGS

Enter a **3** to setup the Fax Settings.

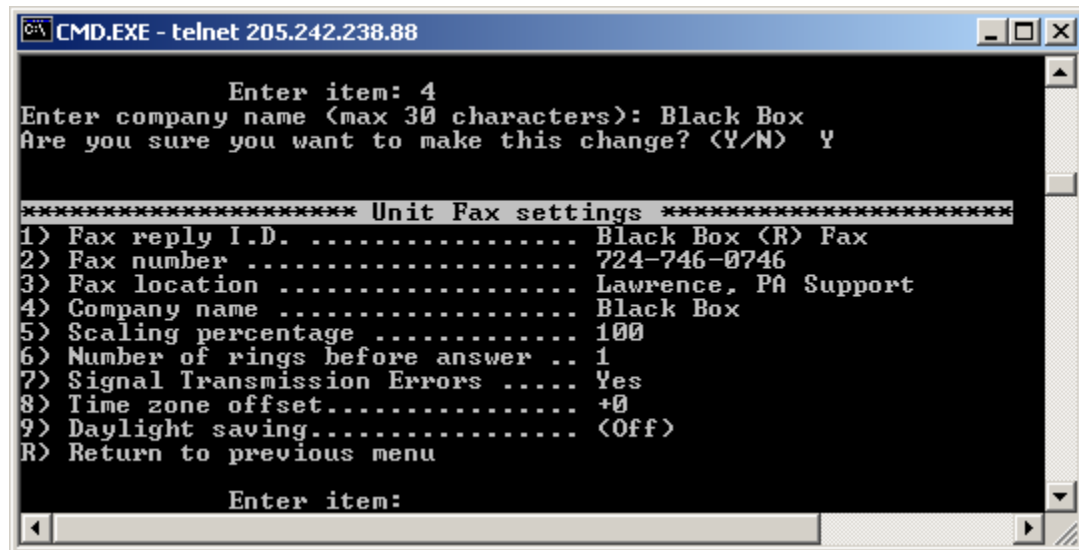

```
CMD.EXE - telnet 205.242.238.88

Enter item: 4
Enter company name (max 30 characters): Black Box
Are you sure you want to make this change? (Y/N) Y

***** Unit Fax settings *****
1) Fax reply I.D. .... Black Box (R) Fax
2) Fax number ..... 724-746-0746
3) Fax location ..... Lawrence, PA Support
4) Company name ..... Black Box
5) Scaling percentage ..... 100
6) Number of rings before answer .. 1
7) Signal Transmission Errors ..... Yes
8) Time zone offset..... +0
9) Daylight saving..... (Off)
R) Return to previous menu

Enter item:
```

- 1) **Fax reply I.D.** is sent to the Sending Fax. 20 characters. This is usually displayed on the display of the sending fax after establishing contact, or recorded in its log/print-out. It is not mandatory to have an ID. If it is not set, the FaxReceiver will send an ID of 20 spaces to the distant fax.
- 2) **Fax number** – This is the telephone number of the FaxReceiver. Not required. Max 20 characters.
- 3) **Fax Location** – This can identify the specific location of the phone line in the building or the city that the FaxReceiver is located in. Not required. Max 28 characters.
- 4) **Company Name** – This is the company that is the proud owner of the FaxReceiver. Not required. Max 28 characters.
- 5) **Scaling Percentage** – This allows you to reduce or increase the size of the graphical image by a percentage (10-150 in increments of 5).
- 6) **Number of rings before answer** – This specifies the number of rings before the FaxReceiver answers the call. Maximum is 30 rings.
- 7) **Signal Transmission Errors** – This is a diagnostic tool that will let you know if you are experiencing phone line problems. Many of these errors will not occur to a degree that will result in a complete failure.
- 8) **Time Zone Offset** – This is the offset from UT. If you are in Greenwich, England, this number will be 0. If your time zone is east of Greenwich, England), the number is positive. If your time zone is west of GMT, the number is negative. For EST, use -5, CST -6, MST -7, PST -8, AKST -9, and HAST -10.

9) **Daylight Saving – (Off)** – This is a toggle. When you are in Daylight Saving time (summer months) this should be on.

R) Press **R** when you have the Unit Fax settings configured.

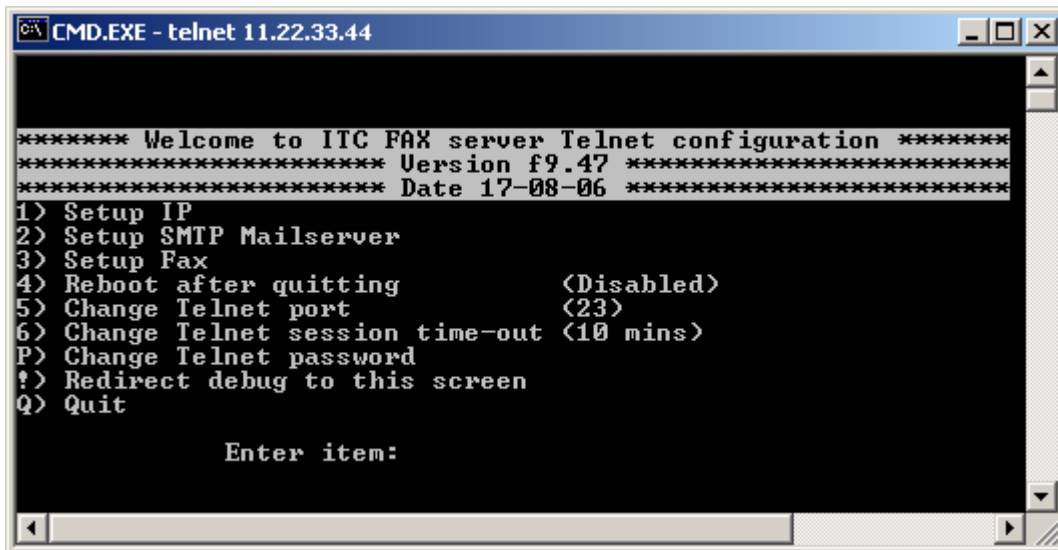

```
CMD.EXE - telnet 11.22.33.44

***** Welcome to ITC FAX server Telnet configuration *****
***** Version f9.47 *****
***** Date 17-08-06 *****

1) Setup IP
2) Setup SMTP Mailserver
3) Setup Fax
4) Reboot after quitting          (Disabled)
5) Change Telnet port             (23)
6) Change Telnet session time-out (10 mins)
P) Change Telnet password
?) Redirect debug to this screen
Q) Quit

Enter item:
```

4) Reboot after quitting (Disabled) – This setting is Enabled if you change an IP address and want to get your new IP address without disconnecting power. Ensure you select "Save settings" when quitting after setting the reboot option, otherwise changes you have made will be lost. Alternatively, you can enable the reboot option and quit without saving settings if you to revert back to the previous settings.

NOTE: Most setup changes will take effect immediately you set them up. The only exceptions are the IP parameters that cannot take effect immediately, because a change to those would cut off the telnet session. If you do a quit and save, the new parameters are all written to Flash so they will be retained through a power cycle.

5) Change Telnet port (23) – This will enable the end user to set up a port that the company does not block (e.g. port 80 or even port 25). That means that you will be able to telnet into the FaxReceiver from your desk, enable debug, send a fax to the unit (also from your desk), and figure out what is going wrong. If you change the TELNET port number and don't reboot, the new number takes effect on the *second* new telnet session. i.e. open telnet on default port 23. Change to port 1234 and do a quit/save. Open another telnet session, still on port 23, and quit. All following telnet sessions must be on port 1234.

6) Change Telnet session time-out – This option allows you to keep your telnet session active longer if you have a lot of interruptions while configuring the FaxReceiver. If you specify zero as the Telnet session time-out, the session will never time-out.

P) Change Telnet password – If you do not change this, anyone can access the unit and change the settings. Max 253 characters. For the telnet password, all ASCII and non-ASCII characters may be used except control characters (those with HEX codes below 0x20). Note however that some telnet clients will modify or not pass non-ASCII characters, or may treat them as control commands for the telnet program rather than passing them on, so best to stick with standard keyboard letters, numbers and punctuation marks. Accented characters on non-English keyboards may also be used without problem. Not required.

NOTE: passwords are case-sensitive. The FaxReceiver defaults to having no telnet password (factory reset).

!) Redirect debug to this screen – This allows you to activate a troubleshooting tool. When activated, telnet will not timeout. You can find more on this screen in the [troubleshooting](#) section of this manual.

Q) Quit When you have completed your changes, press **Q** to Quit.

It will respond:

“Do you want to save your changes before quitting (Y/N)”

If you will enter **Y** it will save your parameters and report: **“All changes saved. Goodbye”**. The Telnet connection will then be dropped.

If you will enter **N** it will not save your parameters and report: **“Quitting WITHOUT saving changes. Goodbye”**. The Telnet connection will then be dropped.

NOTE: *If you select **n** it will keep the parameters until the next power cycle or reboot. This will allow you to test the new parameters before saving them.*

Receiving a Fax

The FaxReceiver is a silent operation device. Connect the FaxReceiver to a fax line. When a fax is received, the Destination Email address will be sent an email. When this occurs, the red Transmit LED will light. The email will have the subject:

"Incoming Fax". The email will have a message similar to this:
Black Box® FaxReceiver RFR 102 (v1.02) - Fax No: 724-746-0746
Location: Lawrence, PA
Remote Fax ID: " 724-746-0746"

It will have an attachment labeled Fax attachment file name is now a date & time stamp in the format YYMMDDHHMMSS_PPP, where YY is the year, MM is the month, DD is the day of the month, HH is the hour, MM is the minutes, SS the seconds, and PPP is the page number. Example **"060930084211_001.gif (28.6 KB)"**

You will be able to see all pages of the fax in Outlook Express. Not all email utilities are able to. If you cannot see the fax in your email utility, then you can open the attachment with any GIF viewer, such as Paint.



The screenshot shows an email client window with a blue header bar. The header bar contains the text "nt-usa-fax-1@ringdal... Incoming Fax" on the left and "9/26/2006 11:31 AM" on the right. Below the header bar, the email content is displayed in a light gray background. The content includes the following text:
From: nt-usa-fax-1@ringdale.com **To:** canderson@ringdale.com
Subject: Incoming Fax

Ringdale® ModuLan® Fax Receiver MFR-200 (v1.03) - Fax No: 512-288-7210
Location: Ringdale Tech Support
Remote Fax ID: "512-301-8000"

At the bottom of the email content, there is a horizontal line. Below the line, the text "Sent by: Cliff Anderson 512-301-8000 9/26/2006 11:36:11 AM Page 1 of 1" is displayed. To the right of this text, the filename "Fax_Return_ID.txt" is visible.

NOTE:

If either your Mailserver (smtp) IP address:port, Mailserver login name or password, the unit's IP address or Gateway Address are incorrect, the FaxReceiver will not answer the call.

The FaxViewer

The FaxViewer is a free tool provided to 1) easily print the FaxReceiver image in standard format, 2) easily view the FaxReceiver image, and 3) save a multi-page FaxReceiver image as a single RFX document.

With this FaxViewer set as your default GIF viewer you can take a look at a fax, if you want it, print it and without any fuss it will be formatted correctly.

It is a standalone utility. Just drag the program to your Desktop, and double-click to run it. You can start the FaxViewer in the future either by making it your default GIF viewer or by using a shortcut.

To create a shortcut:

1) Right-click on the FaxViewer icon.



2) Select **Create Shortcut** then drag the shortcut to your shortcut bar.

To make it your default viewer:

1) Locate a GIF file on your PC and right-click on it.

2) Select **Open With...**

3) Select **Choose Program...** after a little wait, the **Open With** window will pop up.

4) Put a check in "**Always use this program to open these files**"

5) Click **Other...**

6) Browse to your Desktop (or where you put the FaxViewer) and select the FaxViewer.exe and click **Open**.

To use the FaxViewer:

1) Open the FaxViewer utility.

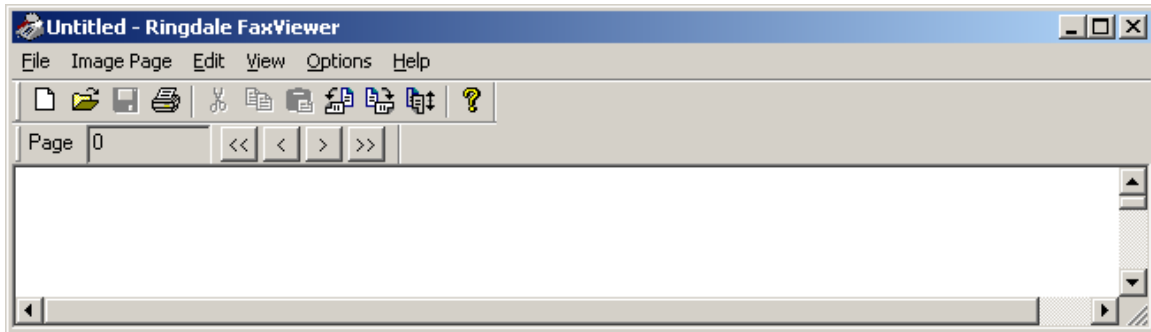

2) When you get e-mail with multiple GIF files, open the email in a separate window.

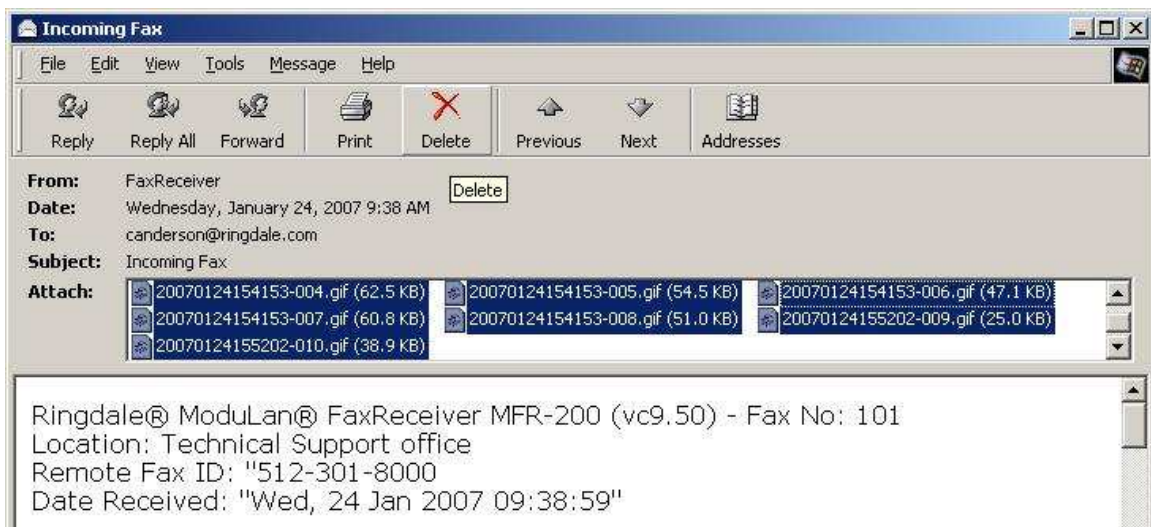

3) Click in the attach block. Then do a **Ctrl / A** - or - select the **Edit** menu, and do a **Select All** then drag and drop the images anywhere on the FaxViewer application.

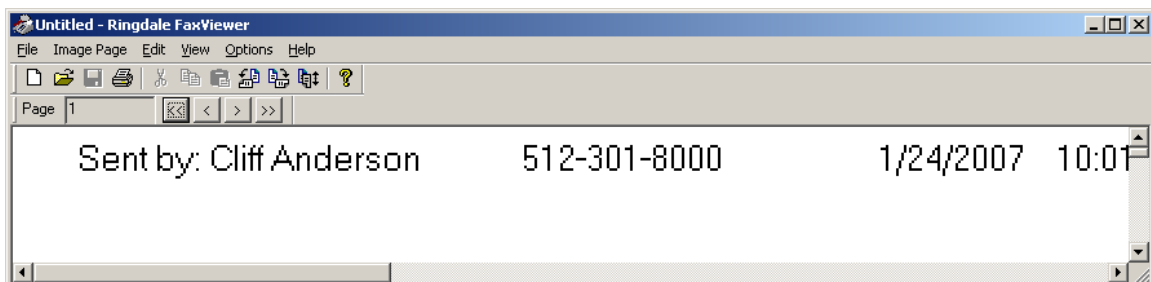

4) If the last page is showing, but the Page shows 1, then you need to reverse the page order. To do this, click on **Image Page**, then **Page Order**, and then **Reverse Image Order**.

5) As soon as the fax starts to come in, the FaxReceiver needs to set up and send the GIF header, which has the values for the size of the "canvas". At that stage however, it only knows the width of the incoming fax. There is no way to know how long it is going to be. So the length is set to a fixed value that corresponds to the longest sheet of standard paper it can expect to be sent by a fax machine. The FaxViewer software has an option, under the Options tab, "**Force Background to white**". This will eliminate the black bar.

6) All pages can be printed immediately by selecting **File / Print**. The print will be formatted to print on standard 8 ½ by 11 inch paper.

7) You can save all of the images as a single RFX file, by selecting **File / Save As...** This will let you name and save the RFX in any folder.

Troubleshooting

PROBLEM: LEDs do not flash at power-up

CAUSE: Power cord not connected or the Ethernet cable is not attached to a live Ethernet network. The LEDs are driven by the Ethernet chip and will not flash unless an Ethernet network is attached.

SOLUTION: Check the green light on the power brick. Look inside the unit for the light inside. Check the Ethernet connections.

PROBLEM: It does not accept a fax.

CAUSE: The modem card may not be plugged all of the way in. The phone number is incorrect or the LAN connection is disconnected. If it cannot reach the SMTP mailservers, it will not answer the call.

SOLUTION: Make certain that the modem card is plugged in until it clicks. Plug an analog phone into the phone jack at the wall and verify the phone number. Make certain that the LAN connection is attached and the Link LED is solid. The green LED should flash when there is LAN activity to or from it.

Check your email parameters with Telnet. In particular, verify the following:

In Unit IP Settings:

This unit IP address ← This must be on the same subnet as the Gateway.
Gateway Address ← Typically the same as the above address, but ending with “.001”.

In Unit Email Settings:

Mailservers (smtp) IP address ← from your SMTP server administrator
Mailservers login name ← often this is your email address
Mailservers login password ← case-sensitive
Destination Email address

After verifying the setup parameters, make certain that you can ping the FaxReceiver. From the same host that you ping the FaxReceiver, you should be able to ping the Gateway Address and the Mailservers (smtp) IP address.

PROBLEM: It accepted the fax but did not seem to email the account that we set up.

CAUSE: Destination Email address is incorrect.

SOLUTION: Verify the Destination Email address.

PROBLEM: I got an "Incoming Fax" email, and when I brought this email up, it had a message that said "OE removed access to the following unsafe attachments in your email".

CAUSE: Outlook Express is configured to view attachments as viruses.

SOLUTION: In Outlook Express, click on the Tools menu and select Options. Click on the Security tab. Take the check out of "Do not allow attachments to be saved or opened that could potentially be a virus".

PROBLEM: I am getting poor quality images in the Fax TIFFs.

CAUSE: Your image viewer does not properly support tagged image file (TIF) format. The default Windows viewer should work fine.

SOLUTION: Try using Imaging or Imaging Preview that comes with Windows.

Right-click on the TIFF file and select Open With.

It will bring up the Open With window, where you can select Imaging or Imaging Preview.

You can also put a check in the "Always use this program to open these files" if you wish. Click OK.

PROBLEM: The sending fax reported "POOR LINE CONDITION".

SOLUTION: This could mean any of the following:

The email parameters are not entered correctly.

The email is being rejected. (email box too full, spam filter parameters)

Ethernet cable is disconnected.

There is a poor line condition.

PROBLEM: My virus checker sees the email attachment as a virus.

SOLUTION:

1) Make sure that the timeserver is picking up the correct time & date.

2) If your sending account name is the same as the account you are sending to (i.e. the "From:" field is the same as the "To:" field) it could cause this. This is one characteristic of some fraudulent email headers. To see if this is the cause, send an email from your PC to yourself *with an attachment*.

PROBLEM: I enabled the DHCP setting, but do not know what address was used.

SOLUTION: After the IP address is assigned, ping the address or range of addresses that it could have. Then within 5 minutes, use the ARP -A command to see the IP Addresses assigned in that range. Look for IP Address assigned to the Physical Address that has the last six digits matching the FaxReceiver's serial number.

Example:

```
C:\WINNT\system32>arp -a
```

```
Interface: 11.22.33.99 on Interface 0x1000003
```

Internet Address	Physical Address	Type
192.168.10.1	00-A0-92-bb-23-20	dynamic
192.168.10.23	00-A0-92-65-ec-c4	dynamic
192.168.10.36	00-A0-92-6d-7d-53	dynamic
192.168.10.165	00-A0-92- 83-8b-0c	dynamic

If the FaxReceiver's serial number is **838B0C** then the IP Address is *192.168.10.165*.

PROBLEM: I have a fax machine used for outgoing faxes connected to a phone splitter with the FaxReceiver. When I try to send a fax, it does not dial.

SOLUTION: The FaxReceiver should not affect the operation of an outgoing fax on the same line.

Ensure that the outgoing fax machine is set up for tone dialing and not pulse dialing. Pulse dialing causes voltage spikes on the line that can be mistaken for an incoming ring, and the FaxReceiver will attempt to answer. If there is no incoming fax, and tone dialing is used, the FaxReceiver should not have any effect at all on the operation of the sending fax machine.

Another potential problem is that if someone tries to send an outgoing fax whilst a fax is being received, it will mess up the reception.

PROBLEM: I have a fax machine used for outgoing faxes connected to a phone splitter with the FaxReceiver. When a fax comes in, the outgoing fax machine answers the call first.

SOLUTION: You will need to disable the sending fax's auto-answer; otherwise it will attempt to answer an incoming fax at the same time as the FaxReceiver.

PROBLEM: I do not know the IP address of my SMTP server and the ISP is unavailable.

SOLUTION: If you have the name of the SMTP mail server, (i.e., mail.company_name.com) you may be able to ping it in order to get the IP address. Try 25 for the port. If that does not work, try 26, and 2525.

QUESTION: What does a good debugger trace look like?

ANSWER: You should see "authenticated", "Answered", "Getting Page", "CCITT data OK", "Sending Page to MAIL", "ok, send it", "filename="Page001.tif", "Goodbye", and "Modem Idle - awaiting call".

QUESTION: My debugger output does not look correct. Can I send it to Tech Support?

ANSWER: Yes. Using your mouse, right-click on the blue bar at the top of your telnet session, and select **Edit**, then **Select All**. Next right-click on the blue bar at the top of your telnet session, and select **Edit**, then **Copy**. Open an email, and do a **Paste** or Ctrl/v. Send the email to support@BlackBox.com.

QUESTION: I would like to be able to disable/enable the FaxReceiver from a remote location.

ANSWER: To remotely switch on/off the answer, simply change the SMTP server IP address to 0.0.0.0 and the device will never answer a call.

PROBLEM: When I print the fax directly from my email about an inch of the data is chopped off.

CAUSE: The print margins are set too wide.

SOLUTION: If you are using Outlook Express, you must go to MSIE (Internet Explorer) and make the Page Setup changes there. Then restart Outlook Express.

- 1) Start **Internet Explorer**.
- 2) Click **File**, then **Page Setup**.
- 3) Adjust the left and right margins to about .25.

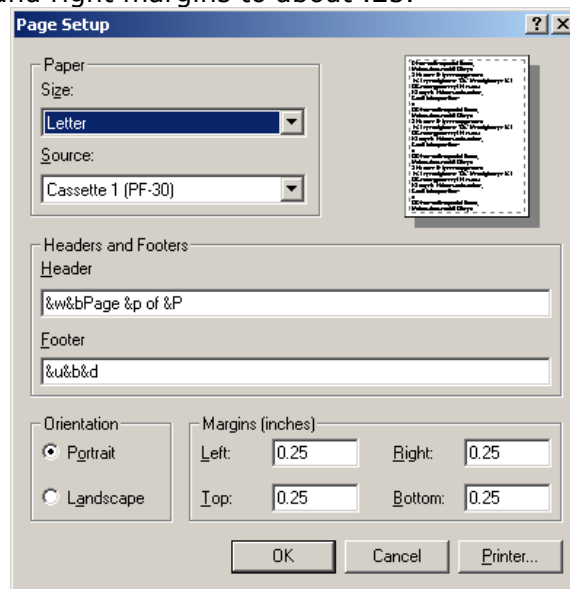

QUESTION: How do I reset to the factory default settings?

ANSWER: Unplug the power, press the reset button, plugging the power back in while holding reset for 10 seconds

PROBLEM: When I use the option 6 Check Mailserver connection it reports: "OK POP3 Service ready" then "Connection Terminated Abnormally".

CAUSE: You are trying to connect to a POP3 mailserver. This is an *incoming* mailserver.

SOLUTION: You need to connect to an *outgoing* mailserver (SMTP). Usually the POP3 is at 110. The SMTP is usually at 25. You might need to just set it back to 25. But check the SMTP port for certain.

Glossary

ARP – **A**ddress **R**esolution **P**rotocol A TCP/IP protocol used to obtain a node's physical address. A client station broadcasts an ARP request onto the network with the IP address of the target node it wishes to communicate with, and the node with that address responds by sending back its physical address so that packets can be transmitted. ARP returns the layer 2 address for a layer 3 address.

BMP – (**BitMaP**) Also known as a "bump" file, it is Windows' native bitmapped graphics file format. BMP files display from the bottom up, and so will be upside-down compared with the same fax sent in GIF or TIFF format.

CCITT – **C**omite **C**onsultatif **I**nternational **T**elegraphique et **T**elephonique (a.k.a. The International Telegraph and Telephone Consultative Committee). The old name for ITU-T, the group responsible for setting the international standards for telecommunications equipment. See ITU below.

CRAM-MD5 - is a **C**hallenge-**R**esponse **A**uthentication **M**echanism (hence "CRAM") defined in RFC 2195 based on the HMAC-MD5 MAC algorithm. It is employed by some SASL implementations, SMTP-AUTH Mail submission agents, and LDAP v3 servers.

DHCP – **D**ynamic **H**ost **C**onfiguration **P**rotocol is a client-server networking protocol that provides a mechanism for allocation of IP addresses to client hosts. A DHCP server also provides configuration parameters specific to the DHCP client host requesting, generally, information required by the client host to participate on an IP network.

GIF -- **G**raphics **I**nterchange **F**ormat (the acronym's officially pronounced "JIF") is a very efficient, and still quite popular picture format. They are small and display on all current graphical browsers without needing a special plug-in or taking up much CPU time.

GMT – **G**reenwich **M**eridian **T**ime or **G**reenwich **M**ean **T**ime is the same as Universal Time.

ICMP -- **I**nternet **C**ontrol **M**essage **P**rotocol - The Internet Control Message Protocol (ICMP) provides end-to-end control messages at the Network layer. The ping utility uses ICMP for echo and echo reply messages, whereas IRDP uses ICMP to generate advertisements for router IP addresses for locally connected workstations.

ISP – **I**nternet **S**ervice **P**rovider

ITU – The **I**nternational **T**elecommunication **U**nion is the United Nations specialized agency dealing with telecommunications.

LED - **l**ight **e**mitting **d**iode, an electronic device that lights up when electricity is passed through it.

MD5 -- MD5 is one of a series of **M**essage **D**igest algorithms. It is a widely-used cryptographic hash function with a 128-bit hash value. Internet standard RFC 1321.

NCAR – **N**ational **C**enter for **A**tmospheric **R**esearch

NPMP -- **N**etwork **P**eripheral **M**anagement **P**rotocol.

NTP – **N**etwork **T**ime **P**rotocol

PCMCIA -- **P**ersonal **C**omputer **M**emory **C**ard **I**nternational **A**ssociation, and pronounced as separate letters, PCMCIA is an organization consisting of some 500 companies that has developed a standard for small, credit card-sized devices, called PC Cards.

PING -- **P**acket **I**nternet **G**roper is a protocol primarily used to troubleshoot IP network problems.

RARP -- (**R**everse **A**RP) A TCP/IP protocol used by a diskless workstation to obtain its IP address. Upon startup, the client station sends out a RARP request in an Ethernet frame to the RARP server, which returns the layer 3 address for a layer 2 address (performing the opposite function of an ARP).

RLE – **R**un **L**ength **E**ncoded is a simple form of compression. RLE consists of the process of searching for repeated runs of a single symbol in an input stream, and replacing them by a single instance of the symbol and a run count.

SMTP -- **S**imple **M**ail **T**ransfer **P**rotocol. Used for e-mail, port 25. SMTP gateways provide access to TCP/IP e-mail services. SMTP is an Application layer protocol.

Subnet Mask – A subnet mask allows IP networks to be subdivided for security and performance purposes.

Telnet – The Internet standard protocol for remote login. Runs on top of TCP/IP. Comes with most Operating Systems.

TIFF - Acronym for **T**agged **I**mage **F**ile **F**ormat, one of the most widely supported file formats for storing bit-mapped images on personal computers (both PCs and Macintosh computers). TIFF graphics can be any resolution, and they can be black and white, gray-scaled, or color. Files in TIFF format often end with a *.tif* extension. Common TIFF are TIFF-CCITT and TIFF-RLE. Many TIFF viewers do not handle CCITT format correctly, but most seem to work fine with RLE format.

Timeserver – A **timeserver** is a computer networking device that reads the actual time from a reference clock and distributes this information to its clients using a computer network.

UDP -- **U**ser **D**atagram **P**rotocol, uses best effort, no error-correction, and simple packets: source address -- destination address -- length – checksum. UDP is carried in the Protocol field of IP.

UT – **U**niversal **T**ime. This is the time kept on the Greenwich meridian (longitude zero), five hours ahead of Eastern Standard Time.

Technical Specifications

Network	10/100 base Ethernet
LAN Connection	RJ45 10baseT
Protocols	ICMP, NPMP, NTP, Ping, RARP, SMTP. TCP/IP, UDP
Email login types	CRAM-MD5, LOGIN (AUTH=LOGIN) and non-authenticated.
Phone Line	PCMCIA Fax/Modem Card V.90 or V.92 56K
Power Supply	External PSU
	Input: 100 - 240 volts AC Frequency: 47-63 Hz
	Output: 5 Vdc 2.5 A (uses less than 5 watts) Approvals CE, UL and CSA
Part No.:	MC200A

Trademark Recognition

ModuLAN®, and FaxReceiver™ are trademarks of ITC, Black Box.

Black Box is a trademark of Black Box Corporation.

Windows is a trademark of Microsoft Corporation.



Legal Notices

FCC Requirements for Telephone-Line Equipment

1. The Federal Communications Commission (FCC) has established rules which permit this device to be directly connected to the telephone network with standardized jacks. This equipment should not be used on party lines or coin lines.
2. If this device is malfunctioning, it may also be causing harm to the telephone network; this device should be disconnected until the source of the problem can be determined and until the repair has been made. If this is not done, the telephone company may temporarily disconnect service.
3. If you have problems with your telephone equipment after installing this device, disconnect this device from the line to see if it is causing the problem. If it is, contact your supplier or an authorized agent.
4. The telephone company may make changes in its technical operations and procedures. If any such changes affect the compatibility or use of this device, the telephone company is required to give adequate notice of the changes.
5. If the telephone company requests information on what equipment is connected to their lines, inform them of:
 - A. The telephone number that this unit is connected to.
 - B. The ringer equivalence number.
 - C. The USOC jack required: RJ-11C.
 - D. The FCC registration number.

Items (B) and (D) can be found on the unit's FCC label. The ringer equivalence number (REN) is used to determine how many devices can be connected to your telephone line. In most areas, the sum of the RENs of all devices on any one line should not exceed five. If too many devices are attached, they may not ring properly.

6. In the event of an equipment malfunction, all repairs should be performed by your supplier or an authorized agent. It is the responsibility of users requiring service to report the need for service to the supplier or to an authorized agent.

NOTE: The manufacturer is not responsible for any radio or T.V. interference caused by unauthorized modifications to this equipment. Such modifications could void the user's authority to operate the equipment.

Normas Oficiales Mexicanas (NOM)

Electrical Safety Statement

Instrucciones De Seguridad

1. Todas las instrucciones de seguridad y operación deberán ser leídas antes de que el aparato eléctrico sea operado.
2. Las instrucciones de seguridad y operación deberán ser guardadas para referencia futura.
3. Todas las advertencias en el aparato eléctrico y en sus instrucciones de operación deben ser respetadas.
4. Todas las instrucciones de operación y uso deben ser seguidas.
5. El aparato eléctrico no deberá ser usado cerca del agua—por ejemplo, cerca de la tina de baño, lavabo, sótano mojado o cerca de una alberca, etc..
6. El aparato eléctrico debe ser usado únicamente con carritos o pedestales que sean recomendados por el fabricante.
7. El aparato eléctrico debe ser montado a la pared o al techo sólo como sea recomendado por el fabricante
8. Servicio—El usuario no debe intentar dar servicio al equipo eléctrico más allá a lo descrito en las instrucciones de operación. Todo otro servicio deberá ser referido a personal de servicio calificado.
9. El aparato eléctrico debe ser situado de tal manera que su posición no interfiera su uso. La colocación del aparato eléctrico sobre una cama, sofá, alfombra o superficie similar puede bloquea la ventilación, no se debe colocar en libreros o gabinetes que impidan el flujo de aire por los orificios de ventilación.
10. El equipo eléctrico deber ser situado fuera del alcance de fuentes de calor como radiadores, registros de calor, estufas u otros aparatos (incluyendo amplificadores) que producen calor.
11. El aparato eléctrico deberá ser connectado a una fuente de poder sólo del tipo descrito en el instructivo de operación, o como se indique en el aparato.
12. Precaución debe ser tomada de tal manera que la tierra fisica y la polarización del equipo no sea eliminada.
13. Los cables de la fuente de poder deben ser guiados de tal manera que no sean pisados ni pellizcados por objetos colocados sobre o contra ellos, poniendo particular atención a los contactos y receptáculos donde salen del aparato.

14. El equipo eléctrico debe ser limpiado únicamente de acuerdo a las recomendaciones del fabricante.
15. En caso de existir, una antena externa deberá ser localizada lejos de las líneas de energía.
16. El cable de corriente deberá ser desconectado del cuando el equipo no sea usado por un largo periodo de tiempo.
17. Cuidado debe ser tomado de tal manera que objetos líquidos no sean derramados sobre la cubierta u orificios de ventilación.
18. Servicio por personal calificado deberá ser provisto cuando:
 - A. El cable de poder o el contacto ha sido dañado; u
 - B. Objetos han caído o líquido ha sido derramado dentro del aparato; o
 - C. El aparato ha sido expuesto a la lluvia; o
 - D. El aparato parece no operar normalmente o muestra un cambio en su desempeño; o
 - E. El aparato ha sido tirado o su cubierta ha sido dañ

Certification Notice for Equipment Used in Canada

The Industry Canada label identifies certified equipment. This certification means that the equipment meets certain telecommunications-network protective, operation, and safety requirements. Industry Canada does not guarantee the equipment will operate to the user's satisfaction.

Before installing this equipment, users should ensure that it is permissible to be connected to the facilities of the local telecommunications company. The equipment must also be installed using an acceptable method of connection. In some cases, the company's inside wiring associated with a single-line individual service may be extended by means of a certified connector assembly (extension cord). The customer should be aware that compliance with the above conditions may not prevent degradation of service in some situations.

Repairs to certified equipment should be made by an authorized maintenance facility—in this case, Black Box. Any repairs or alterations made by the user to this equipment, or equipment malfunctions, may give the telecommunications company cause to request the user to disconnect the equipment.

Users should ensure for their own protection that the electrical ground connections of the power utility, telephone lines, and internal metallic water pipe system, if present, are connected together. This precaution may be particularly important in rural areas.

CAUTION:

Users should not attempt to make such connections themselves, but should contact the appropriate electric inspection authority, or electrician, as appropriate.

The LOAD NUMBER (LN) assigned to each terminal device denotes the percentage of the total load to be connected to a telephone loop which is used by the device, to prevent overloading. The termination on a loop may consist of any combination of devices, subject only to the requirement that the total of the load numbers of all the devices does not exceed 100.

Federal Communications Commission
and
Industry Canada
Radio Frequency Interference Statements

This equipment generates, uses, and can radiate radio-frequency energy, and if not installed and used properly, that is, in strict accordance with the manufacturer's instructions, may cause interference to radio communication. It has been tested and found to comply with the limits for a Class A computing device in accordance with the specifications in Subpart B of Part 15 of FCC rules, which are designed to provide reasonable protection against such interference when the equipment is operated in a commercial environment. Operation of this equipment in a residential area is likely to cause interference, in which case the user at his or her own expense will be required to take whatever measures may be necessary to correct the interference.

Changes or modifications not expressly approved by the party responsible for compliance could void the user's authority to operate the equipment.

This digital apparatus does not exceed the Class A limits for radio noise emission from digital apparatus set out in the Radio Interference Regulation of Industry Canada.

Le présent appareil numérique n'émet pas de bruits radioélectriques dépassant les limites applicables aux appareils numériques de la classe A prescrites dans le Règlement sur le brouillage radioélectrique publié par le Industrie Canada.

**Federal Communications Commission
and Industry Canada
Radio Frequency Interference Statements**

Class B Digital Device. This equipment has been tested and found to comply with the limits for a Class B computing device pursuant to Part 15 of the FCC Rules. These limits are designed to provide reasonable protection against harmful interference in a residential installation. However, there is no guarantee that interference will not occur in a particular installation. This equipment generates, uses, and can radiate radio frequency energy, and, if not installed and used in accordance with the instructions, may cause harmful interference to radio communications. If this equipment does cause harmful interference to radio or telephone reception, which can be determined by turning the equipment off and on, the user is encouraged to try to correct the interference by one of the following measures:

- Reorient or relocate the receiving antenna.
- Increase the separation between the equipment and receiver.
- Connect the equipment into an outlet on a circuit different from that to which the receiver is connected.
- Consult an experienced radio/TV technician for help.

CAUTION

Changes or modifications not expressly approved by the party responsible for compliance could void the user's authority to operate the equipment.

To meet FCC requirements, shielded cables and power cords are required to connect this device to a personal computer or other Class B certified device.

This digital apparatus does not exceed the Class B limits for radio noise emission from digital apparatus set out in the Radio Interference Regulation of Industry Canada.

Technical Support

Telephone:

724-746-5500

Answered in 20 seconds or less!

Fax:

800-321-0746

Answered in 15 minutes or less!

Website:

<http://www.blackbox.com/>

Before you call

Please have the following information ready:

- ✓ Serial number of the unit.
- ✓ Network Information:
- ✓ IP address of FaxReceiver, Mail Server, and Default Gateway.
- ✓ Type of Fax cards installed in the FaxReceiver.
- ✓ The symptoms of the problem.
- ✓ History of the Problem:
 - Did the device work for a period of time or fail immediately after installation?
 - Was any PC option changed (hardware or software) prior to the problem appearing?

Address manual comments to

support@Black Box.com



BLACK BOX[®]

NETWORK SERVICES

CUSTOMER SUPPORT INFORMATION

Order toll-free in the US: Call 877-877-BBOX (outside US call 724-746-5500)

FREE Technical Support 24 hours a day, 7 days a week: Call 724-746-5500 or fax 724-746-0746.

Mailing address: Black Box Corp, 1000 Park Drive, Lawrence, PA 15055-1018.

Web site: www.blackbox.com E-mail: info@blackbox.com.

© Copyright 2006 Black Box Corporation.

All rights reserved.

© Copyright 2006. Black Box Corporation. All rights reserved.

1000 Park Drive • Lawrence, PA 15055-1018 • 724-746-5500 • Fax 724-746-0746

Free Manuals Download Website

<http://myh66.com>

<http://usermanuals.us>

<http://www.somanuals.com>

<http://www.4manuals.cc>

<http://www.manual-lib.com>

<http://www.404manual.com>

<http://www.luxmanual.com>

<http://aubethermostatmanual.com>

Golf course search by state

<http://golfingnear.com>

Email search by domain

<http://emailbydomain.com>

Auto manuals search

<http://auto.somanuals.com>

TV manuals search

<http://tv.somanuals.com>