

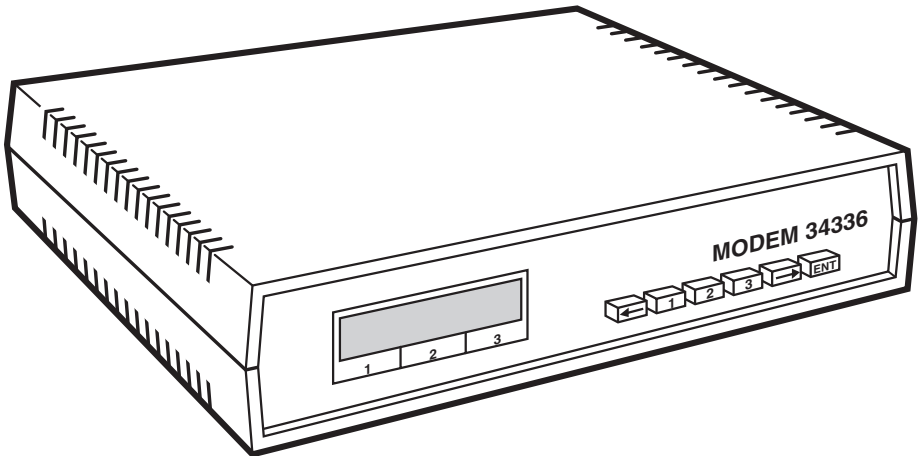

Modem 34336



NOTE

All models include the modem, (1) leased line cable, (1) dialup phone cable and this user manual. The MD885A-R2, MD885AE-R2, and MD885A-R3 include a power supply. The MD885A-R3 also includes (1) 10-ft. RS-232 cable and (1) DB9 F to DB25 M adapter.

**CUSTOMER
SUPPORT
INFORMATION**

Order toll-free in the U.S.: Call 877-877-BBOX (outside U.S. call 724-746-5500)
FREE technical support 24 hours a day, 7 days a week: Call 724-746-5500 or fax 724-746-0746
Mailing address: **Black Box Corporation**, 1000 Park Drive, Lawrence, PA 15055-1018
Web site: www.blackbox.com • E-mail: info@blackbox.com

**FEDERAL COMMUNICATIONS COMMISSION
AND
INDUSTRY CANADA
RADIO FREQUENCY INTERFERENCE STATEMENTS**

This equipment generates, uses, and can radiate radio frequency energy and if not installed and used properly, that is, in strict accordance with the manufacturer's instructions, may cause interference to radio communication. It has been tested and found to comply with the limits for a Class A computing device in accordance with the specifications in Subpart J of Part 15 of FCC rules, which are designed to provide reasonable protection against such interference when the equipment is operated in a commercial environment. Operation of this equipment in a residential area is likely to cause interference, in which case the user at his own expense will be required to take whatever measures may be necessary to correct the interference.

Changes or modifications not expressly approved by the party responsible for compliance could void the user's authority to operate the equipment.

This digital apparatus does not exceed the Class A limits for radio noise emission from digital apparatus set out in the Radio Interference Regulation of Industry Canada.

Le présent appareil numérique n'émet pas de bruits radioélectriques dépassant les limites applicables aux appareils numériques de la classe A prescrites dans le Règlement sur le brouillage radioélectrique publié par Industrie Canada.

TRADEMARKS USED IN THIS MANUAL

Hayes® is a registered trademark of Hayes Microcomputer Products, Inc.

Microcom Networking Protocol® and MNP® are registered trademarks of Microcom Systems, Inc.

Any trademarks mentioned in this manual are acknowledged to be the property of the trademark owners.

Table of Contents

1.0	Specifications	6
2.0	Quick Start	8
2.1	Installation	8
2.1.1	Unpacking	8
2.1.2	Package Contents	8
2.1.3	What You Will Need	8
2.1.4	Connections	8
2.1.5	Jumpers	10
2.2	Front Panel LCD And Controls	11
2.2.1	Power-On Screen	11
2.2.2	EIA Status Screen	12
2.3	Quick Setup	13
2.4	Basic Operation	16
2.4.1	2-Wire Dial (Hayes) Mode	16
2.4.2	2-Wire Dial (V.25 bis) Mode	18
2.4.3	2-Wire Dial (Dumb) Mode	19
2.4.4	Leased Line (2- or 4-Wire) Mode	21
2.4.5	V.33 Leased Line Operation	22
2.4.6	2-Wire Dial (Bell 208) Operation	22
2.4.7	4-Wire Leased Line V.29 Mode	23
2.4.8	V.29 Fast Master and Slave Modes	24
2.5	Problem Solving	25
3.0	Modem Setup Options	27
3.1	Methods For Selecting Options	27
3.2	Selecting Options From The Front Panel	28
3.2.1	Pushbuttons And The LCD	28
3.2.2	How To Select Options	29
3.3	Options	32

3.3.1	V.42 Error Correction Options	35
3.3.2	Dialer Mode	41
3.3.3	Data Format Options	42
3.3.4	Disconnect Options	43
3.3.5	Test Options	44
3.3.6	EIA Options	44
3.3.7	Modem Setups	46
3.3.8	V.33 and BELL 208A/B Options	49
3.3.9	Options Accessible With Summary Setup Only	50
4.0	General Operation and Special Features	54
4.1	Quick Reset	54
4.2	Phone Number Storage	54
4.3	Leased Line Auto-Recovery	55
4.3.1	Autodial Backup	57
4.3.2	Exit From Leased Line Auto-Recovery	57
4.3.3	Leased Line Auto-Recovery Options	58
4.4	Dial Line Auto-Recovery	58
4.4.1	Setting Up The Modem For Dial Line Auto-Recovery	58
4.4.2	Recovery Procedure	58
4.5	DTR Dialing	60
4.5.1	Dialing A Stored Number	60
4.5.2	Answer Mode Operation	60
4.6	Dumb Mode And Bell 208 Operation	60
4.7	Modem Security Operation	62
4.8	Modem-Controlled Remote Control	66
4.8.1	Direct Modem-to-Modem Remote Control	66
4.8.2	Remote Control through a Rack Controller	67
4.9	Diagnostic Interface Control	71
4.9.1	Diagnostic Port	71
4.9.2	Diagnostic Port Commands	71
4.9.3	Responses To Diagnostic Port Commands	73
4.9.4	DTE Displays	75
4.9.5	Disconnecting From A Diagnostic Link	75

4.10	Automatic Fallback	76
4.10.1	Operating Mode Fallback	76
4.10.2	V.32 Speed Fallback	78
4.11	V. 13 Operation	80
5.0	Hayes Emulation Mode	81
5.1	Hayes Mode Autodialer	81
5.1.1	Enabling The Hayes Mode Autodialer	81
5.1.2	Command Guidelines	81
5.1.3	Result Codes	84
5.1.4	Transmission Speed	84
5.2	Hayes Compatible Commands	84
5.3	S Registers	90
5.3.1	Reading And Setting Registers	86
5.3.2	S Register Functions	86
5.4	Selecting Options In Hayes Mode	94
5.4.1	Saving Option Selections	94
5.4.2	Profile 0 and Profile 1.....	94
5.5	Hayes Mode Reference Tables	95
6.0	V.25 bis Autodialer	107
6.1	Enabling The V.25 bis Autodialer	107
6.2	V.25 bis Autodialer Commands	108
6.3	Dialing Parameters	112
6.4	V.25 bis Result Codes	112
6.5	DTR Dialing In V.25 bis Mode	112
7.0	Diagnostics	113
7.1	When And Why To Test	113
7.2	Symptoms And Scope Of The Problem	113
7.3	Physical Inspection	114
7.4	Overview Of Modem Diagnostics	114
7.5	How To Select And Activate Tests	115
7.5.1	Front-Panel Control	115
7.5.2	Running Tests In Hayes Mode.....	115
7.5.3	Remote Test Control	115

7.6 Diagnostic Monitoring: Status Screens115

 7.6.1 EIA Status Screen115

 7.6.2 Other Status Screens.....116

7.7 Local Modem Diagnostics118

 7.7.1 Analog Loopback (ALB) Test118

 7.7.2 Analog Loopback Self Test (ALBST)119

 7.7.3 Analog Loopback Self Test With Errors (ST/E)120

 7.7.4 External Analog Loopback (ALBX) Test121

 7.7.5 External Analog Loopback Self Test (ALXST).....123

 7.7.6 Digital Loopback Test (DLB)124

7.8 Remote Modem Diagnostics126

 7.8.1 Remote Digital Loopback (RDL) Test126

 7.8.2 Remote Digital Loopback Self Test (RDLST)127

Appendix A: DB25 Pin Assignments.....129

Appendix B: Quick Setup Configurations130

Appendix C: Summary Setup135

Appendix D: Jumpers144

Appendix E: LCD Flow Charts147

1.0 Specifications

Available Configurations —	Stand-alone or rack-mount
Compatibility —	<p>V.29 9600, 7200, 4800</p> <p>V.32 terbo 19.2 or 16.8 kbps</p> <p>V.33 14.4 or 12.0 kbps</p> <p>V.32 bis 14.4, 12.0, 9.6, 7.2, or 4.8 kbps</p> <p>V.32 9.6 or 4.8 Kbps</p> <p>V.34+ 33.6, 31.2, 28.8, 26.4, 24, 21.6, 19.2, 16.8, 14.4, and 12 kbps, 9600, 7200, 4800, and 2400 bps</p> <p>V.34 28.8, 26.4, 24, 21.6, 19.2, 16.8, 14.4, and 12 Kbps, 9600, 7200, 4800, and 2400 bps</p> <p>V.22 bis 2.4 kbps,</p> <p>V.21 300 bps</p> <p>Bell 208A/B 4.8 kbps</p> <p>Bell 212A 1.2 kbps</p> <p>Bell 103 0 to 300 bps</p>
Data Rates —	<p>Asynchronous: 300 to 19,200 bps</p> <p>Synchronous: 600 to 19,200 bps</p>
Data Format —	<p>Asynchronous: 9, 10, or 11 bits, serial, binary</p> <p>Synchronous: Serial, binary</p>
Operation —	<p>Full duplex over dialup or leased line</p> <p>Simulated half duplex V.13 operation</p>
Fallback —	<p>Data Rates: 16.8, 14.4, 12.0, 9.6, 7.2, 4.8, 2.4, 1.2, or 0.3 kbps</p> <p>Operation: V.22 bis, V.22, V.21, or V.23</p>
Supported DTE Speeds —	300 to 115,200 bps
Modes —	<p>V.34+ 33.6, 31.2, 28.8, 26.4, 24, 21.6, 19.2, 16.8, 14.4, and 12 kbps, 9600, 7200, 4800, and 2400 bps; full duplex over 2-wire line (Trellis coded)</p> <p>V.34 QAM at 28.8, 26.4, 24, 21.6, 19.2, 16.8, 14.4, and 12 kbps, 9600, 7200, 4800, and 2400 bps; full duplex over 2-wire line (Trellis coded)</p> <p>V.34 Extended AT: 33.6 Kbps, TR-301 proposed</p> <p>V.32 terbo QAM at 19.2 and 16.8 Kbps; V.32bis fallback at 14.4 Kbps and lower</p> <p>V.33 QAM Trellis coded at 14.4 and 12.0 Kbps</p> <p>V.32 bis QAM at 14.4, 12.0, 9.6, 7.2, and 4.8 Kbps; echo cancel, full duplex over 2-wire line (Trellis coded at 7.2 Kbps and higher, or non-coded at 9.6 Kbps)</p> <p>V.32 Kbps; echo cancel, full duplex over 2-wire line (Trellis coded at 7.2 Kbps and higher, or non-coded at 9.6 Kbps)</p>

	V.29	QAM at 9600, 7200, and 4800 bps
	V.27	8-phase DPSK at 4800 and 2400 bps
	V.26	4-phase DPSK at 2400 and 1200 bps
	V.23	FSK at 1200/75 bps, full duplex
	V.22 bis:	QAM at 2400 bps; bandsplit, full duplex
	V.22:	DPSK at 1200 bps; bandsplit, full duplex
	V.21:	PSK at 0 to 300 bps; bandsplit, full duplex
Autodialer —		Automatic dialing using rotary pulses or tone signaling; supports Hayes AT commands or V.25 bis commands
Answer Modes —		Automatic and manual answer
Equalization —	Receiver:	Automatic adaptive equalization
	Transmitter:	Selectable compromise equalization (4 types)
Line Requirement —		Unconditioned
Transmit Timing —		Internal, external, or slaved to receive clock
Transmit Level —	Leased:	Selectable, 0 to -15 dBm
	Dial:	Permissive or programmable
Interface —	Terminal:	RS-232C/D, CCITT V.24/V.28
	Dialup Line:	8-pin RJ-45 modular connector with A/A1 and MI/MIC control
	Leased Line:	6-pin RJ-11 modular connector
	Diagnostic:	8-pin RJ-45 modular connector
Carrier Detect Threshold —	Leased line:	-26, -33, or -43 dBm; selectable
	Dial line:	-34, 41, or -51 dBm; selectable
Test Capabilities —		Analog loopback, analog loopback self-test, self-test with errors, digital loopback, remote digital loopback self-test, external analog loopback (4-wire), external analog loopback self-test (4-wire); front-panel TIA/EIA or front-panel Hayes control
AC Power —	Stand-alone:	90-132 VAC, 60 Hz $\pm 5\%$
	Rackmount:	117/220 VAC
Power Consumption —		13 watts
Heat Generation —		44 BTU/hr
Ringier Equivalence —		0.7 B
Environment —	Ambient temp:	32 to 120°F (0 to 49°C)
	Storage temp.:	20 to 180°F (-7 to 82°C)
	Relative humidity:	5 to 90% at 24°C (75°F) non-condensing
Size (stand-alone unit) —		2.5"H x 9.7"W x 10.1"D (6.4 x 24.6 x 25.7 cm)
Weight —	Stand-alone:	4.1 lb (1.9 kg)
	Rackmount:	2 lb. (0.9 kg)

2.0 Quick Start

All information in this manual applies to both the stand-alone and rack-mount versions of the Modem 34336.

QUICK SETUPS FOR A QUICK START

The simplest and fastest way to set up the Modems for immediate use is to select one of the factory-preset Quick Setup configurations.

Quick Setups are explained in **Section 2.3**, following installation instructions (**Section 2.1**) and a brief introduction to the Modem's front-panel display and controls (**Section 2.2**).

2.1 Installation

2.1.1 UNPACKING

Many early modem failures are a result of damage done during shipping. Visually inspect your modem. Keep the original shipping carton in case you have to return the modem for any reason.

2.1.2 PACKAGE CONTENTS

All models include the following cables:

- A two-conductor crossover cable for a dial-line connection.
- A four-conductor cable for a leased-line connection.

Both cables have an eight-pin modular connector (RJ-45) on one end and a six-pin modular connector (RJ-12) on the other end. You will need to use both of the supplied cables if you want to use the Modem for Leased-Line Auto Recovery, which requires both a leased-line and dial-line connection.

The MD885A-R2, MD885AE-R2, and MD885A-R3 include a power supply.

The MD885A-R3 package also includes additional cables:

- (1) 10-ft. RS-232 cable
- (1) DB9 F to DB25 M adapter

2.1.3 WHAT YOU WILL NEED

- You will need an EIA RS-232 interface cable (supplied with the MD885A-R3, not supplied with the MD885A-R2, MD885AE-R2, or MD885C-R2) to connect the Modem to a DTE (data terminal equipment, usually a computer).

- If you are operating the Modem in a manual dial mode, you also need a standard telephone set.

2.1.4 CONNECTIONS

Figure 2-1 shows how the Modem is connected to the computer or terminal, AC power supply, phone lines, and handset.

Do not install the modem more than 50 feet (15.2m) from the DTE (the EIA standard maximum length for interface cable). For DTE speeds greater than 19.2 Kbps, a shorter low-capacitance DTE interface cable should be used. Call technical support for information on which cable will support your application.

For all applications:

- Connect your RS-232 cable to the rear-panel DB25 connector labeled DTE. Connect the other end to your computer or other DTE.
- Attach the power transformer cable (included) to the rear-panel connector labeled POWER. Plug the other end into an AC outlet.

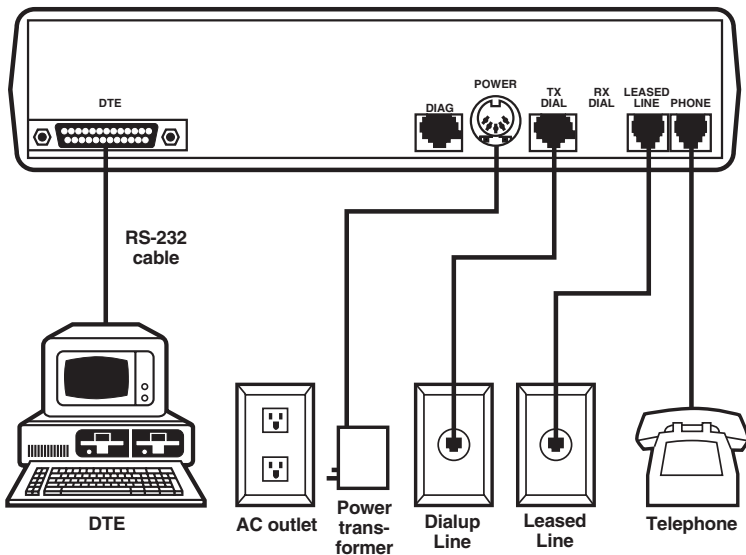

Figure 2-1. Modem 34336 Connections.

For dialup applications:

- Use the supplied two-conductor crossover cable to connect the Modem to the telephone-line modular wall jack. Plug the eight-pin connector (RJ-45) of the cable into the rear-panel jack labeled TX DIAL. Then, plug the six-pin connector (RJ-12) into the telephone jack.

NOTE

Do not bundle the telephone and RS-232 cables together.

- Optional: For manual-dial operation, or if you want to use the telephone line for voice transmissions (when the Modem is not operating in data mode), connect a standard telephone into the rear-panel jack labeled PHONE.

For leased-line applications:

- Use the supplied four-conductor cable to connect the Modem to your leased-line modular wall jack. Attach the six-pin modular connector (RJ-12) to the rear-panel jack labeled LEASED LINE. Attach the eight-pin connector (RJ-45) of the cable into the line's terminal block.

The same cable is used whether you have a 4-wire or 2-wire leased line. In a 4-wire application, the green and red wires are the TRANSMIT pair, and the yellow and black wires are the RECEIVE pair. When the cable is connected to a 2-wire line, only the green and red wires are used.

NOTE

Do not bundle the telephone and RS-232 cables together.

2.1.5 JUMPERS

For most applications, you will not need to reset internal jumpers. However, jumpers must be reset for the following situations:

- If you are connecting frame ground to signal ground.
- If you are switching from A/A1 control to MI/MIC control.
- Change the function of TIA/EIA pin 25 (the default is test mode indicator).
- If you use the Modem in a DC rack enclosure.

For detailed jumper information, see Appendix D.

2.2 Front-Panel LCD and Controls

To select a Quick Setup configuration, you will need to use the pushbuttons and liquid-crystal display (LCD) on the modem's front panel. These features are shown in **Figure 2-2**. For a detailed explanation of the front panel controls, see **Chapter 3**.

2.2.1 POWER-ON SCREEN

When the Modem is powered on, the LCD momentarily displays the power-on screen. The top line identifies the modem type. The lower line indicates the software revision level.

NOTE

The software revision level of your modem may be different from the number shown above.

The Modem spends about two seconds checking the ROM checksum and doing self-tests, and then displays the EIA status screen.

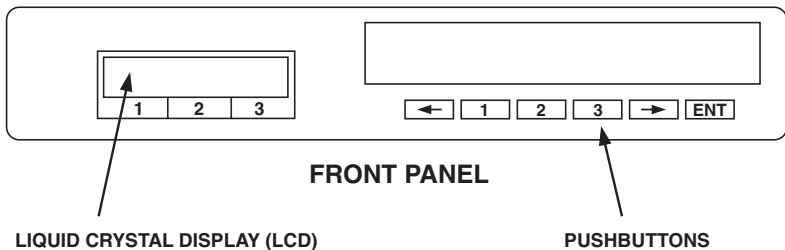
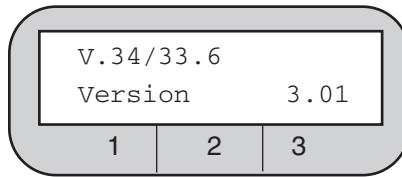
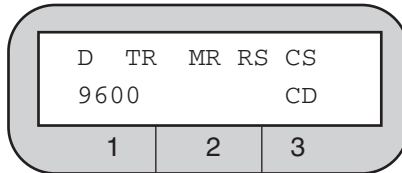

Figure 2-2. Front-Panel LCD and Controls.

2.2.2 EIA STATUS SCREEN

The EIA status screen indicates the operational status of the Modem as well as the condition of certain EIA RS-232 leads. The abbreviations that may appear are identified below. Typically, only a few of these abbreviations will be displayed during actual operation.



D = Dial line occupied.

R = Ringing (R appears in same position as D).

S = Connection secured by security handshake. (S appears in same position as D. S and D may flash alternately).

TR = Data Terminal Ready.

MR = Data Set Ready.

RS = Request to Send.

CS = Clear to Send.

TD = Transmit Data.

14.4, 9600, 4800, etc. = Data speed in Kbps (thousand bits per second) or bps (bits per second) (“idle” or H-01, H-14, etc. may also be displayed in the data speed position; see text below).

TM = Test mode.

ER = Error (poor signal quality).

CD = Carrier Detect.

RD = Receive Data.

Codes beginning with H (such as H-01) in the lower left corner of the status screen indicate that the Modem is handshaking with another modem (attempting to establish a connection).

When the modem is off-line, the word “idle” is displayed in the lower left corner of the status screen.

2.3 Quick Setup

To set up the Modem for immediate use (or to quickly change the modem's configuration for an alternate mode of operation), select one of the factory-preset Quick Setup configurations (see Table 2-1). Your Modem will be ready for operation. You will not need to make further adjustments.

When you select a Quick Setup, the Modem uses internal memory to automatically set all of its options to the chosen configuration. All previously-stored option settings are overwritten. The Quick Setup does not affect telephone numbers stored in the modem's memory.

You can customize a Quick Setup configuration by changing specific option settings (see **3.0 Modem Setup Options**).

HOW TO SELECT A QUICK SETUP

To activate a Quick Setup configuration, follow the steps below. As you do, you may find it helpful to refer to the LCD flow chart at the back of this manual.

1. Press the ENT (enter) pushbutton on the modem's front panel. Screen 1 of the MAIN MENU is displayed:

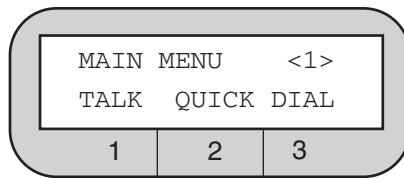

2. Press pushbutton 2. Screen 1 of the QUICK SETUP menu appears:

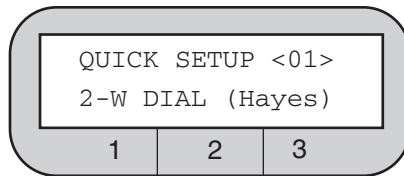

3. Use the front-panel arrow pushbuttons to move through the QUICK SETUP menu. There are 12 QUICK SETUP configurations. Each configuration is discussed in **Table 2-1**.
4. When the LCD shows the Quick Setup configuration you want, press pushbutton 2. The bottom line of the display will flash.
5. Press ENT. You will see SETUP screen 1. Press ENT a second time. The modem resets and the selected Quick Setup takes effect.

All options for each Quick Setup configuration are listed in **Appendix B**. If you want to customize your Quick Setup configuration, see **3.0, Modem Setup Options**. For Hayes® mode options, see **5.0, Hayes Emulation Mode**.

Table 2-1. Available Quick Setup Configurations.

QUICK SETUP IDENTIFIED ON LCD	DESCRIPTION
<p>QUICK SETUP <01> 2-W DIAL (Hayes)</p>	<p>2-WIRE DIAL HAYES EMULATION MODE— This dial mode (for use over ordinary phone lines) allows the Modem to automatically dial (autodial) a previously stored phone number and respond to Hayes commands. This mode is compatible with communication software packages that use Hayes-style AT commands. The Hayes mode Quick Setup is the factory default configuration for the Modem.</p>
<p>QUICK SETUP <02> V25 DIAL (Async)</p>	<p>2-WIRE DIAL V.25 bis MODE, ASYNCHRONOUS—In V.25 bis mode, the Modem operates in conformance with CCITT recommendation V.25 bis, allowing you to store and direct dial or autodial phone numbers from the DTE. Use Quick Setup 2 if the DTE connected to the modem is asynchronous.</p>
<p>QUICK SETUP <03> V25 DIAL (Syn_c)</p>	<p>2-WIRE DIAL V.25 bis MODE, SYNCHRONOUS-CHARACTER ORIENTED— Same as Quick Setup 2 except for data protocol. Use Quick Setup 3 if the DTE is synchronous-character oriented (bisynchronous).</p>
<p>QUICK SETUP <04> V25 DIAL (Syn_b)</p>	<p>2-WIRE DIAL V.25 bis MODE, SYNCHRONOUS BIT ORIENTED—Same as Quick Setup 2 except for data protocol. Use Quick Setup 4 if the DTE is synchronous bit-oriented (SDLC/HDLC).</p>
<p>QUICK SETUP <05> 2-W DIAL (DUMB)</p>	<p>2-WIRE DIAL DUMB MODE—When the Modem is in Dumb mode, you can use it for dial-line answer-only applications, dial a previously stored telephone number from the front panel, or dial telephone numbers via an external source (telephone).</p>
<p>QUICK SETUP <06> 2-W LEASED (ORG)</p>	<p>2-WIRE LEASED-LINE ORIGINATE MODE— In Leased-Line mode, the Modem connects to the leased line and stands ready to send and receive data. Use Quick Setup 6 if the leased line is a 2-wire line and you want to configure the Modem as the originate modem.</p>

Table 2-1 (continued). Available Quick Setup Configurations.

QUICK SETUP <07> 2-W LEASED (ANS)	2-WIRE LEASED-LINE ANSWER MODE— Same as Quick Setup 6 except for modem answer/ originate status. Use Quick Setup 7 if the leased line is a 2-wire line and you want to configure the Modem as the answer modem.
QUICK SETUP <08> 4-W LEASED (ORG)	4-WIRE LEASED LINE ORIGINATE MODE— Same as Quick Setup 6 except for line type. Use Quick Setup 8 if the leased line is a 4-wire line and you want to configure the Modem as the originate modem.
QUICK SETUP <09> 4-W LEASED (ANS)	4-WIRE LEASED LINE ANSWER MODE— Same as Quick Setup 6 except for line type and modem answer/originate status. Use Quick Setup 9 if the leased line is a 4-wire line and you want to configure the Modem as the answer modem.
QUICK SETUP <10> 4-WLL V.33	V.33 LEASED LINE OPERATION— This Quick Setup configures the Modem for V.33 operation. This provides compatibility with V.33 modems.
QUICK SETUP <11> 2-W DIAL (208)	2-WIRE DIAL BELL 208 OPERATION— This Quick Setup configures the Modem for 2-wire dial operation compatible with Bell standard 208B.
QUICK SETUP <12> 2-W DIAL V32/208	2-WIRE DIAL V.32/208 AUTO-DETECT MODE— This Quick Setup configures the Modem to automatically select V.32 bis (V.13) or Bell 208 operation, depending on the mode of the originating modem.
QUICK SETUP <13> 4-WLL V.29	4-WIRE LEASED LINE V.29 MODE— This Quick Setup configures the modem for V.29 operation, for compatibility with V.29 modems.
QUICK SETUP <14> V.29 FAST MASTER	V.29 FAST MASTER MODE— This Quick Setup configures the modem for V.29 fast train <i>master</i> operation, for use in a multidrop network where multiple remote (slave) modems share the master Modem as the host modem.
QUICK SETUP <15> V.29 FAST SLAVE	V.29 FAST SLAVE MODE — This Quick Setup configures the modem for V.29 fast train <i>slave</i> operation, for use in a multidrop network where multiple remote (slave) modems share the same host (master) modem.

2.4 Basic Operation

This section provides basic information for each of the modem's primary operating modes. If you encounter difficulty, refer to **Section 2.5, Problem Solving**.

2.4.1 2-WIRE DIAL (HAYES) MODE (QUICK SETUP 1)

Two-Wire Dial (Hayes) mode is the factory-default configuration for the Modem. Hayes mode operation and commands are explained in detail in **5.0, Hayes Emulation Mode**.

Dialing a Phone Number. To dial a telephone number in Hayes mode, type the Hayes command **AT D** on your computer or terminal keyboard, followed by the number you want to call and `<cr>`. Example:

```
AT D 5551212 <cr>
```

Dashes or spaces may be included for clarity, but they are not necessary. The Modem ignores them.

A carriage return (`<cr>`) is required at the end of each command. On most keyboards, the carriage return (`<cr>`) key is labeled Enter or Return.

In response to the command line shown above, the Modem will dial the number 555-1212.

If you need an access code (such as 9) to dial out of your building, insert the access code and a comma in the dial string:

```
AT D 9,5551212 <cr>
```

The Modem pauses for 2 seconds at the comma. This allows the Modem to wait for a second dial tone (after the access code) before dialing the number.

Dialing Mode. The default dialing mode is tone dialing. To change to pulse dialing, insert a **P** after **AT D**:

AT DP

To change from pulse dialing to tone dialing, insert a **T** after **AT D**:

AT DT

The specified dialing mode remains active until the alternate mode is specified or the modem is reset.

Connected. When a phone number is successfully dialed, a **CONNECT** message appears on the computer screen and the LCD on the Modem displays a status screen similar to the one shown below.

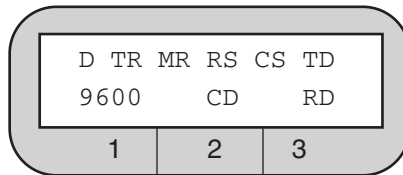

TD and RD flash to indicate that the modem is transmitting and receiving data. The speed may be other than 9600 bps. The Modem automatically adjusts to the speed of the remote modem, provided the remote unit is a compatible modem.

Terminating a Call. To terminate a call, first enter the escape sequence, +++ . When the OK response appears on the DTE screen, enter the command AT H. An alternate method is to drop the DTR signal from the DTE. If you are using a computer with a communication software program, follow the program's instructions for initiating and terminating calls.

2.4.2 2-WIRE DIAL (V.25 BIS) MODE (QUICK SETUPS 2, 3, AND 4)

The Modem supports three types of V.25 bis operation: asynchronous, character-oriented synchronous, or bit-oriented synchronous. There is a Quick Setup for each V.25 bis type.

For V.25 bis operation, the Modem must be configured to use the same data protocol as the attached DTE. V.25 bis mode operation and commands are explained in detail in **Chapter 6.0, V.25 bis Audodialer**.

Asynchronous V.25 bis Operation.

The data format of the DTE should be set to 7 data bits with even parity and one stop bit. The default DTE interface rate is 38,400 bps in asynchronous mode.

V.25 bis commands can be entered from the DTE keyboard. Example:

CRN 5551234

In response to this command, the Modem sends a VAL result code back to the DTE (indicating that the command is accepted), dials the telephone number 555-1234, and then waits for an answer tone from the remote modem. If no carrier is detected within a given time (default is 45 seconds), the modem automatically releases the line and sends a **CFI NT** result code to the attached DTE.

Spaces entered in the command line for clarity are ignored:

CRN 555 1212 has the same effect as **CRN5551212**.

When a phone number is successfully dialed, the EIA status screen on the Modem looks like the one shown below.

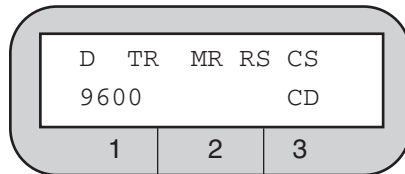

Synchronous V.25 bis Operation

The data format of the DTE should be set to 7 data bits with odd parity.

In synchronous applications, the V.25 bis commands can be used to facilitate computer-controlled operations.

Synchronous bit-oriented operation uses High-Level Data Link Control (HDLC) formatting.

Synchronous character-oriented operation uses synchronous start-of-text and end-of-text characters to frame messages. The start-of-text character is preceded by two synchronous (SY) characters.

2.4.3 2-WIRE DIAL (DUMB) MODE (QUICK SETUP 5)

Dumb mode is used primarily for manual call origination, answer-only applications, and in conjunction with certain dial back security systems that utilize MI/MIC signals to place the modem on-line. (If you need to configure the modem for MI/MIC use, refer to **Appendix D**.) For additional information on Dumb-mode operation, refer to **Chapter 4.0, General Operation and Special Features**.

Answering a Call Automatically. After the Quick Setup for 2-Wire Dial (Dumb) mode is selected, the Modem will automatically answer incoming calls. The only other requirement is that either (1) the DTE must provide the DTR signal (TR on the LCD status screen) to the modem, or (2) DTR must be set to TRUE (using the modem's DTR from EIA option screen).

Originating a Call from the Front Panel. Before you can originate a call from the front panel, you must store the number to be dialed in the modem.

From the Set-up <5> screen, access the PHONE screen by pressing the following pushbuttons in sequence:

- Pushbutton 1 (Phone)**
- Pushbutton 2 (Prog)**

The abbreviations DEC, CTRL, and INC are displayed on the bottom line of the LCD, indicating that you located the PHONE screen.

Follow the steps below to store the phone number:

1. Use the right and left arrow pushbuttons to go to the digit you want to change. The cursor causes the character at that digit location to blink, indicating that the digit or character can be changed.
2. Use pushbutton 1 to decrease numbers, and pushbutton 3 to increase them.
3. Use pushbutton 2 (CTRL) to sequence through the dialing control characters (explained in **Chapter 3**).
4. Use the arrow pushbuttons to move on to the next digit or character you want to change. (The characters that can be stored are listed in Chapter 3.)
5. The phone number is saved when you return to the MAIN MENU. To return to the EIA status screen, press ENT three times.

Autodialing the Stored Number. To autodial the stored number from the EIA status screen, press the following pushbuttons in sequence:

ENT

Pushbutton 3 (to select DIAL from MAIN MENU screen 1)

Pushbutton 1 (to select DIAL from the AUTO-DIAL screen)

When the local modem successfully establishes a connection with the remote unit, the EIA status screen should be present. This screen looks like the one shown below.

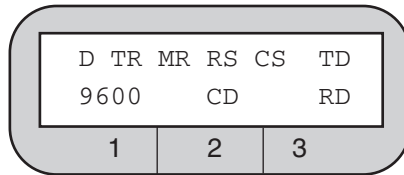

If the modem's LCD displays an AUTO-DIAL FAILURE message, refer to Table 2-2.

Terminating a Data Call. Normal termination of a data call is processed through communication software. An alternate method is switching the HANGUP option on the AUTO-DIAL screen. Another method is to drop the DTR signal from the DTE (by software control or by turning the DTE off). For manual originate/answer operation, see **Chapter 4**.

2.4.4 LEASED LINE (2- OR 4-WIRE) MODE (QUICK SETUPS 6, 7, 8, AND 9)

This section does not apply to V.33 leased line operation. For V.33 leased line operation, see the next section.

Table 2-2. Auto-Dial Failure Messages.

FAILURE MESSAGE	EXPLANATION
LINE OCCUPIED	The data line is already in use.
DIAL NOT ALLOWED	Modem is not configured for dial backup.
NO DTR	DTR is not present.
NO LINE CURR	Loss of line current.

The following information applies to both 2-wire and 4-wire leased-line operation:

- The modem must be configured for the correct line type — 2-wire or 4-wire. If you select the correct Leased Line Quick Setup, the line type is automatically set to the correct setting.
- One modem must be set to originate mode and the other to answer mode. If you select the correct Leased Line Quick Setup, the answer/originate status is automatically set to the correct setting.
- Leased line operation is restricted to data rates of 4800 bps or higher.
- Lines can be conditioned or unconditioned.

After the appropriate Leased Line Quick Setup is selected, the answer unit immediately begins the training sequence. It is ready to handshake with the originate modem.

When the local modem establishes a connection with the remote unit, the EIA status screen should be present. This screen should look like the one shown below.

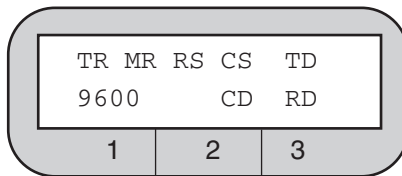

2.4.5 V.33 LEASED-LINE OPERATION (QUICK SETUP 10)

V.33 operation is available on the Modem at speeds of 12,000 and 14,400 bps. V.33 leased-line operation provides compatibility with V.33 modems (synchronous operation only).

A 4-wire line must be used (conditioned or unconditioned), and both connected modems must be set for V.33 operation.

After the V.33 Leased-Line Quick Setup is selected, the answer unit immediately begins the training sequence, meaning it is ready to handshake with the originate modem.

When the local modem successfully establishes a connection with the remote unit, the EIA status screen is present. This screen looks like the one shown below:

TR	MR	RS	CS	TD
9600		CD	RD	
1	2	3		

Three options are intended for V.33 (and Bell 208A/B) operation exclusively. These options are listed in **Section 3.3.8**.

2.4.6 2-WIRE DIAL (BELL 208) OPERATION (QUICK SETUPS 11 AND 12)

The Bell 208 Quick Setup, available on the Modem only, configures the modem for 2-wire dial synchronous operation compatible with Bell standard 208B. The data rate is fixed at 4800 bps, and the data format is set to synchronous. Both connected modems must be set for 208B operation. For additional information on Bell 208 operation, see **Chapter 4**.

Beginning with the section titled **Answering a Call Automatically**, all information in **Section 2.4.3** also applies to Bell 208 operation.

Three options are intended for Bell 208 (and V.33) operation exclusively. These options are listed in **Section 3.3.8**.

2.4.7 4-WIRE LEASED LINE V.29 MODE (QUICK SETUP 13)

The 4-Wire Leased Line V.29 Mode configures the modem for V.29 operation, for compatibility with V.29 modems. Keep these guidelines in mind when using this mode:

- The modem must be configured for use with a 4-wire line.
- Operation is restricted to data rates of 4800, 7200, and 9600 bps.
- Lines can be conditioned or unconditioned.

After you select this Quick Setup mode, the modem will send a training sequence and wait for a training response from the remote modem. The modem will repeat the training sequence every 1.2 seconds until the remote modem responds.

When the local modem has established a connection with the remote unit, the TIE/EIA status screen will appear.

NOTE

For point-to-point 4-wire leased-line V.29 operation, the Auto-Retrain option should be enabled on both modems. (Auto-Retrain is enabled by default if you select the 4-wire Leased Line V.29 Quick Setup.) If the Auto-Retrain option is disabled, the modem will not transmit a training sequence and will instead train on the data stream from the remote modem. Disabling Auto-Retrain in 4-wire leased line V.29 mode is recommended for test purposes only. If Auto-Retrain is disabled, it should be disabled on both modems.

V.34/V.32 Dial Backup

NOTE

Dial backup can only be used in point-to-point applications.

To prevent service interruption in the event of poor leased line conditions, the modem can be configured for V.29 leased line operation with V.34/V.32 dial backup. This means the modem will use dial lines to automatically restore operation when conditions on the leased lines deteriorate. (Use V.34 or V.32 modulation for dial backup.) To set up the Modem for V.29 leased line operation with dial backup, follow these steps:

- 1) Select the 4-wire leased line V.29 (4-WLL V.29) Quick Setup on both the local and remote modem.
- 2) One modem must be set to originate mode and the other to answer mode. To make this selection, use the ANS/ORG DEFAULT screen on the front panel LCD.
- 3) Configure the modems for leased line auto-recovery.

2.4.8 V.29 FAST MASTER AND SLAVE MODES (QUICK SETUPS 14 AND 15)

In multidrop operation, the master modem transmits to all of the slave (remote) modems. When the DTE at a slave site recognizes its own address in the polling protocol, it raises RTS to the slave transmitter. The slave responds by transmitting a special training sequence, then raising CTS and transmitting the data from the DTE. When the DTE has completed transmission, it lowers RTS and the modem will drop carrier to let the next modem on the poll list use the channel.

The V.29 Fast Master and Fast Slave modes support data rates of 4800, 7200, and 9600 bps. The leased lines can be conditioned or unconditioned. The master modem must be set to originate mode, and the slave modem must be set to answer the mode. (The Answer/Organize option is automatically set to these settings when the V.29 Fast Master and Fast Slave Quick Setups are used.)

Slave-to-Master (Inbound) Transmission

When the remote modems come on-line, they automatically synchronize to the incoming carrier and train on the data stream from the master modem. Slave-to-master transmission is always switched carrier operation under control of the RTS signal from the DTE. An anti-streaming timer built into the modem will (if enabled) halt transmission if the DTE holds RTS on for more than 30 seconds. The assumption is that if RTS is held on for more than 30 seconds, there is a fault in the DTE.

If you access the TIA/EIA status screen on the LCD display when a slave modem is transmitting to the master modem, the status screen will typically look like this:

TR	MR	RS	CS	TD
9600			CD	RD

Typically TD, CD, and RD will flash on the master modem, and RS, CS, TD, and RD will flash on the slave modems.

2.5 Problem Solving

If you encounter difficulties in setting up or using the modem, try the remedies described below. If you suspect a system malfunction, follow the diagnostic procedures described in Chapter 7. If you cannot resolve the problem, call your supplier.

1. ALL MODES

Make sure all cables are properly connected to the back of the modem.

2. ALL DIAL MODES (HAYES, V.25 BIS, DUMB, BELL 208, AND V.32/208)

DTR (Data Terminal Ready) must be ON if you want to use the modem's autodial or auto-answer features. (If DTR is ON, the TR indicator is present on the EIA status screen.)

3. ALL ASYNCHRONOUS MODES

The modem's default DTE speed is 38.4 Kbps in asynchronous mode. If the local DTE does not support this speed, change the modem's DTE Speed option setting. In Hayes mode, the default DTE speed is automatically overridden when the Modem is autobauded (the Hayes mode AT attention code is sent to the Modem).

4. HAYES MODE

In Hayes mode with default settings in effect, the Modem transmits result codes (messages) to the DTE. In some instances, this may cause undesirable interaction with the attached DTE. If such interaction occurs, use the **AT Q2** command to suppress result codes for incoming calls.

5. ALL LEASED-LINE MODES (2-WIRE, 4-WIRE, AND V.33)

DTR (Data Terminal Ready) must be ON for the units to train on the leased line. (If DTR is ON, the TR indicator is present on the EIA status screen.)

Four types of compromise equalization are available to compensate for distortion. If the signal quality appears to be inadequate (see **Quality Screen** in **Section 7.6.2**), or if the modems are frequently retraining, try changing the equalization option. See **Compromise Equalizers** in **Section 3.3.6**.

6. LEASED-LINE (EXCLUDING V.33 OPERATION)

Make sure one modem is set to originate mode and that the other is set to answer mode. (If the correct Quick Setup is selected, and not incorrectly modified, the answer/originate status should be correct.)

NOTE

This page is intentionally left blank.

3.0 Modem Setup Options

3.1 Methods For Selecting Options

The Modem allows you to easily select options for tailoring the modem's operation to suit a particular application. You can be select options in the following ways:

- **Quick Setup** — the easiest way to set up the Modem. Quick Setup (explained in **Chapter 2**) automatically sets all options according to a preset configuration.
- **Front-panel selection** — the easiest and most commonly used method for selecting individual options. You can select an overall configuration via Quick Setup, and then change selected options from the front panel to suit your application. To make changes, access individual option screens on the front panel LCD. Make selections using the control pushbuttons.
- **Summary Setup** — the fastest way to selectively change options. All options are accessed using a few of the LCD screens. These screens show numerical codes with very little explanation. Therefore, Summary Setup is recommended for experienced users only. Summary Setup is explained in **Appendix C**.

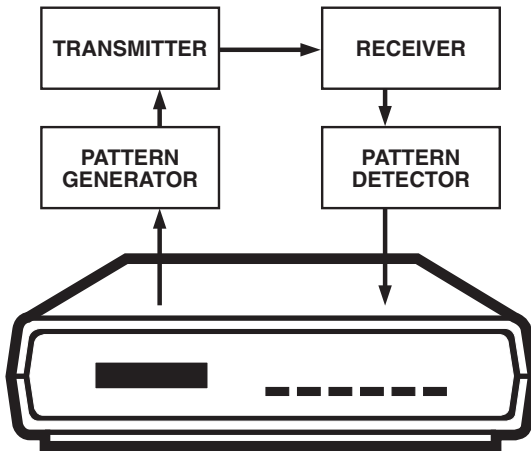

Figure 3-1. LCD Pushbuttons.

3.2 Selecting Options from the Front-Panel

3.2.1 PUSHBUTTONS AND THE LCD

Options are selected from the front panel by pressing the front panel pushbuttons (Figure 3-1). The possible choices for each option are shown on the liquid crystal display (LCD) and on the flow chart at the back of this manual.

1. Arrow Pushbuttons. Use the left arrow and right arrow pushbuttons to display additional or previous pages (screens) of a menu. The right arrow pushbutton displays an additional menu page (if there is one); the left arrow pushbutton displays the previous page of a menu. With respect to how the LCD flow chart is set up, the arrow pushbuttons move you either right or left within the chart.

If the menu has more than one screen, each screen is numbered. This number appears in the upper right corner of the LCD display. If there is no page number, the menu has only one screen. Additional pages of a menu show additional option selections. In the example below, the screen number (or page number) is 2.

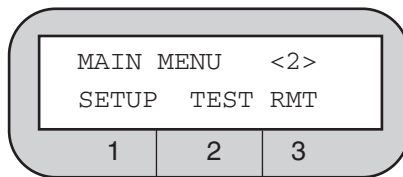

2. Numbered Pushbuttons. Pushbuttons 1, 2, and 3 correspond to segments 1, 2, and 3 of the LCD screen. These segments (left, middle and right positions of the LCD screen) are numbered on the modem's front panel.

With respect to how the LCD flow chart is organized, pushbuttons 1, 2, and 3 either take you to a lower level or allow you to select an option when there is no route to a lower level.

3. ENT Pushbutton. To exit from a displayed screen, press the ENT pushbutton. With respect to how the LCD flow chart is set up, pushing ENT moves you upward through the chart (toward the MAIN MENU).

Pressing ENT repeatedly will return you to screen 1 of the MAIN MENU.

Pressing ENT repeatedly after arriving at the MAIN MENU screen 1 causes the LCD to alternate between the EIA status screen and the MAIN MENU.

In the case of most tests, ENT cannot be used to exit the test screen once the test is activated. To exit a test, first press ENT, and then select OFF to end the test.

NOTE

If you have selected a Quick Setup or have changed certain options settings, pressing the ENT pushbutton to exit the SETUP menu will cause the modem to reset.

3.2.2 HOW TO SELECT OPTIONS

Options are configured from the SETUP menu.

To access the SETUP menu, press the right-arrow pushbutton at page 1 of the MAIN MENU. This will take you to page 2 of the MAIN MENU. Press push button 1 to select SETUP.

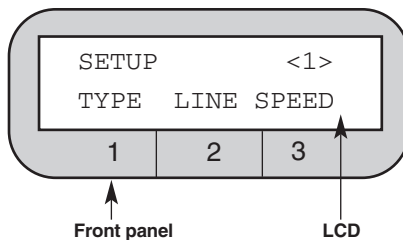

The SETUP menu has six screens. Use the arrow pushbuttons until the option you wish to configure is displayed on the bottom line of the LCD window. Select the option you wish to configure by pressing the pushbutton that corresponds to the number on the front panel.

When you select an option, the option flashes on the LCD. The option will not take effect until you leave the SETUP menu. Simply accessing an option screen does not change the option, so not hesitate to move through the various LCD screens in the SETUP menu.

Note the following points:

- Selected options do not become active until you leave the SETUP menu.
- Changing some options causes the modem to automatically reset.
- The options you select are automatically saved by the Modem when you leave the SETUP menu.

1. DEC/INC (Decrease/Increase) Screens. Several option screens show the abbreviations DEC and INC on the bottom line of the LCD display. The abbreviations mean the numerical value shown on the top line (e.g., a stored phone number) can be changed. Selecting DEC (pushbutton 1) decreases the value; selecting INC (pushbutton 3) increases it.

2. Option-Selection Example. The following example illustrates option selection. As you follow the steps below, refer to the LCD flow chart (SETUP OPTIONS side) at the back of this manual. When you are finished, you can easily restore default settings for the type of application you are using by selecting the appropriate Quick Setup (see **Section 2.3, Quick Setup**).

The example shows how to change the volume of the modem's speaker from LOW or HIGH (the default setting) to MEDIUM. To make this adjustment, locate the SPEAKER VOLUME screen on the LCD. Access MAIN MENU screen 2, then SETUP screen 4. Finally, access MODEM SETUPS screen 5. The steps are explained in detail below.

After powering on the modem, press ENT to get the first screen of the MAIN MENU. Press the right arrow pushbutton to go to screen 2 of the MAIN MENU, shown below.

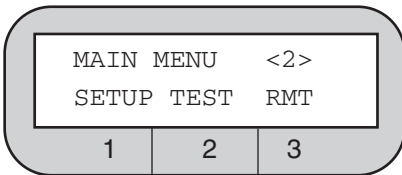

Press pushbutton 1 to access the first page of the SETUP menu, shown right.

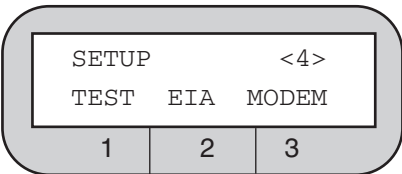
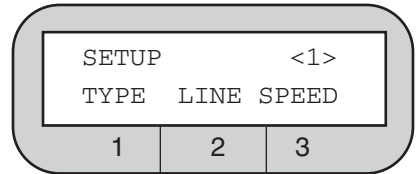

Press the right arrow pushbutton three times to display SETUP screen 4, shown left.

Press pushbutton 3 to select MODEM (for MODEM SETUPS). The first MODEM SETUPS screen is shown right.

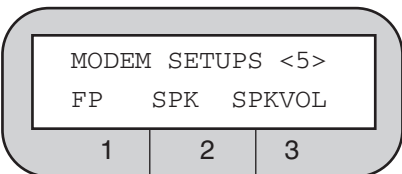
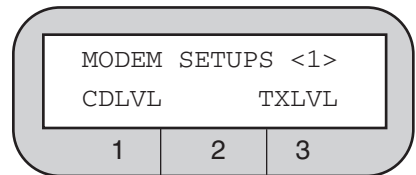

Press the right arrow pushbutton four times to reach MODEM SETUPS screen 5, shown left.

Press pushbutton 3 to select SPKVOL (speaker volume). The SPEAKER VOLUME screen is shown right.

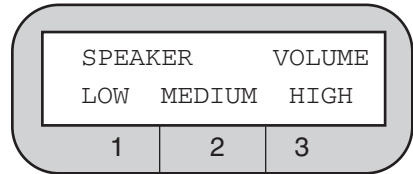

The currently selected setting flashes. Press pushbutton 2 to switch the volume setting to MEDIUM. MEDIUM begins to flash, indicating the new selected setting (although the new selection does not become active until you exit the SETUP menu). To return to the first page of the MAIN MENU, press the ENT button several times.

3. Returning to the EIA Status Screen. Once your selection is complete, return to the EIA status screen. Press the ENT pushbutton several times—the exact amount depends on which screen you are exiting from. (If the modem is in a test mode, press ENT and select OFF to end the test.)

4. Automatic Configuration Save Feature. When you exit the SETUP menu, the Modem automatically saves its current configuration (i.e., option setups, including any changes you made) to its internal memory. The saved configuration remains in effect until it is changed (even if a loss of power occurs).

5. How to Return to Default Settings. The factory default settings are different for each of the Quick Setup configurations available to the modem. To return to the factory default settings for any of these configurations, go to the QUICK SETUP menu and select the desired configuration.

The 2-Wire Dial (Hayes) Quick Setup does not recall the factory-default settings, it recalls the stored user profile 0 or 1, depending on which is designated as the default (see **&Y** command in **5.0, Hayes Emulation Mode**).

To entirely reconfigure the modem to the state it was in when shipped from the factory, hold in the right arrow pushbutton as you power up the modem until the words FACTORY DEFAULT appear on the LCD.

3.3 Options

The rest of this chapter describes the options available from the Modem's front panel. The options are presented in the same order in which they appear in the LCD flow chart at the back of this manual.

The line below each option heading indicates the applicability of the option. A Quick Setup mode is listed only if the option is effective in that mode and if it can be of practical use in that mode.

The default settings for each option are listed in **Appendix B**.

The Quick Setup options (one for each operating mode) affect the entire modem configuration. See **Chapter 2**.

The Line Type options are available for all modes:

- **2-WIRE DIAL** — for dialup applications.
- **2W-LL** — for leased-line applications using 2-wire lines.
- **4W-LL** — for leased-line applications using 4-wire lines.

The Speed Limit option (available for all modes) allows you to set a minimum and/or maximum data rate. The Modem automatically operates at the highest possible data rate within the limits selected, as indicated in Table 3-1.

Only the minimum rate selection applies to Hayes mode operation. EIA-23 is available for setting the maximum rate only. If EIA-23 is selected, the rate is set at either 9600 or 4800 bps, depending on the condition of pin 23 on the EIA interface:

- Pin 23 high (greater than or equal to +3 volts) = 9600 bps.
- Pin 23 low (less than or equal to -3 volts) = 4800 bps.

Use the Speed Matching option if you don't want speed conversion. You can set the DTE interface rate to follow the rate at which the modem connected (i.e., DTE=DCE).

NOTE

Speed matching is only effective for dial applications and will only function if V.42 error correction and/or buffer mode is enabled.

To select speed matching, refer to **Appendix C**. Follow the instructions given there to change the value identified in the MISCELLANEOUS OPTIONS diagram as the DTE=DCE speed parameter from 0 (the factory setting) to 1.

The Speed Limit Type screen is only present on the Modem . The V.32 master handshake normally used by the Modem is incompatible with the CCITT V.33 and Bell 208 handshakes. However, the Modem can be configured for either V.33 or Bell 208 compatibility.

V.33 or Bell 208 speed limits can be set independently of other options via the Speed Limit Type screen. However, to ensure proper operation, it is recommended that you use the V.33 or 208 Quick Setup configuration, as explained in **Chapter 2**.

Table 3-1. Effect of Speed Limit Settings on Data Rate

MAX RATE SETTING, bps	DIALER OPTION	RESULTANT DATA RATE, bps
LEASED LINE MODES		
14,400 ¹	xx	14,400 ¹
12,000 ¹	xx	12,000 ¹
9600	xx	9600
300 to 4800	xx	4800
EIA-CTRL	xx	9600 or 4800 ²
DIAL MODES—ANSWERING		
300 to 14,400 ¹	xx	Negotiated between minimum and maximum setting
EIA-CTRL	xx	9600 or 4800 ²
DIAL MODES—ORIGINATING		
300 to 14,400 ¹	OFF	Negotiated between minimum and maximum setting
EIA-CTRL	OFF	9600 or 4800 ²
xx	HAYES ³	Negotiated between autobaud speed and 300 bps ³
<p>xx Does not matter—condition does not affect resultant data rate.</p> <p>¹ 14,400 and 12,000 bps rates are for the Modem only.</p> <p>² 9600 bps if EIA pin 23 is high, 4800 bps if pin 23 is low.</p> <p>³ If SYNC AFTER DIAL is enabled (using the &Q1 command), the rate is negotiated between the autobaud speed and 1200 bps.</p>		

- **V.32.** The Modem normally uses the V.32 handshake. (The Modem also uses this handshake for V.32/14,400 bps operation.)
- **V.33.** V.33 operation is available on the Modem for 4-wire leased line synchronous operation only. The available data rates are 14,400 and 12,000 bps. Either of these rates may be set as the maximum or minimum by using the Speed Limit MAXIMUM RATE and MINIMUM RATE screens. Both connected modems must be set for V.33 leased-line operation.
- **V.34.** V.34 extended (33.6 kps) mode of operation is in compliance with proposed TR-30.1 implementation of two new data rates (31.2kps and 33.6kps) which are compatible with V.34 recommendation. Interoperability with modems is ensured, provided they comply with the TR30.1 proposal.
- **208.** This selection (on the Modem only) provides both Bell 208A compatibility for 2-wire or 4-wire leased line operation and Bell 208B compatibility for 2-wire dial operation. Operation is full duplex in 4-wire leased line mode only. In Bell 208B mode, synchronous V.25 bis autodialing is available, but Hayes operation is not. In Dumb mode, calls may be originated from the front panel. The data rate is fixed at 4800 bps for 208A/B operation, and the data format is synchronous only. Both connected modems must be set for 208A/B operation. For 2-wire applications, the carrier option must be set for switched carrier operation (SWITCH) via the CARRIER screen, and CTS must be set to follow RTS (CTS to EIA option).

Three options intended only for 208A/B and V.33 operation are accessible through MODEM SETUPS screen 7. These options allow you to select constant or switched carrier, set CTS to follow RTS or set CTS to be always on, or specify an RTS-CTS delay time. For further information, see the **CARRIER**, **CTS**, and **RTS-CTS DELAY** headings later in this chapter.

3.3.1 V.42 ERROR CORRECTION OPTIONS

The Modem supports both CCITT V.42 error correction and Microcom Networking Protocol® (MNP®) error correction (classes 1 through 5). V.42 and MNP provide end-to-end error correction through an automatic repeat-transmission request algorithm. Both types of error correction enable the Modem to detect data transmission errors and automatically request retransmission of adversely affected data until it is received correctly.

Either error-correction standard (V.42 or MNP) may be enabled for dial or leased-line operation. However, error correction can function only if all of the following conditions are present:

- The modem that the Modem is communicating with must be equipped with the same type of error correction (V.42/V.42 bis or MNP).
- The same type of error correction (V.42/V.42 bis or MNP) must be enabled at both ends of the communication link.
- Both communicating modems must be configured for asynchronous data format.
- The connected systems must support data flow control (have buffering capabilities).

The V.42 and MNP error-correction options (listed and described below) are effective only when all of the conditions listed above are present.

Error correction options cannot be changed when the modem is on-line.

For valid test results, disable error correction before running diagnostic tests.

User-selectable options allow you to configure the Modem for V.42 (LAPM) error correction only, MNP error correction only, or V.42 error correction with MNP as the fallback error correction protocol. Data compression may also be enabled by selecting either V.42 bis or MNP class 5 error correction. Other error-correction options are also available.

The available error correction options are listed below:

- V.42 Mode
- MNP Class (class limit)
- Break Handling
- V.42 Selection
- Buffer Mode/Speed Conversion
- DTE Speed
- DTE-DCE and DCE-DTE Flow Control options
- Flyback Buffer
- Pass-Through Flow Control

All of the above options affect the type of error correction selected via the V42 SELECTION screen (discussed below), except that the MNP Class and Flyback Buffer options are applicable only to MNP operation.

The error-correction options can be selected in any order, but the following sequence is suggested:

1. Select the type of error correction desired from the V42 SELECTION screen.
2. Make a selection from the V.42 Mode screen.
3. Select other error-correction options as appropriate for your application.

The **V.42 Mode** is available for Hayes, V.25 bis, Dumb, and Leased-Line modes (except V.33).

The V.42 Mode settings described below apply to the type of error correction selected with the V42 Selection screen. For example, if LAPM ONLY is selected as the error correction protocol, and MANDATORY is selected from the V42 Mode screen, V.42 or V.42 bis error correction is activated. If the error correction cannot be activated, the Modem will hang up.

- **OFF** — Error correction will be disabled.
- **MANDATORY** — Error correction will be activated. If the modem cannot establish a connection using the type of error correction selected via the V.42 Selection option, it will hang up.
- **AUTO** — The Modem will fall back to buffer or non-buffer mode if conditions do not allow it to establish a connection using the type of error correction selected via the V42 SELECTION screen.

The MNP Class (Limit) is available for Hayes, V.25 bis, Dumb, Leased Line modes (except V.33). This option is effective only when MNP error correction is active. It limits MNP operation to the selected MNP class or lower (MNP classes 1-5 are available). In general, the higher MNP classes provide the most throughput efficiency. Class 5, the default, can provide as much as 2-to-1 data compression over the transmission link.

The following two options are available through the **V42 SELECTION** screen:

The **Protocol option** is available for Hayes, V.25 bis, Dumb, and Leased-Line modes (except V.33).

- **LAPM/MNP** — The Modem attempts to establish a connection using the V.42 link access protocol (LAPM/MNP). This is the primary error correction protocol under the CCITT V.42 standard. If such a connection cannot be established (because the other modem does not support LAPM or is not configured for LAPM), the Modem attempts to establish a connection using MNP Class 5 as the fallback error correction protocol.

NOTE

When operating in LAPM mode, the Modem uses V.42 error correction unless V.42 bis is enabled via the V.42 bis option. (V.42 and V.42 bis error-correction both use LAPM.)

- **LAPM ONLY** — The modem only attempts to establish an LAPM connection (will use only V.42 or V.42 bis error correction).
- **MNP ONLY** — The modem will only attempt to establish an MNP connection.

NOTE

If a connection cannot be established using the selected protocol (LAPM/MNP, LAPM ONLY or MNP ONLY), the action the Modem takes depends on the V.42 mode setting.

V.42 bis Operation is available for Hayes, V.25 bis, Dumb, and Leased-Line modes (except V.33). V.42 bis operation provides error correction with data compression. Like V.42 error correction, V.42 bis uses the link access protocol (LAPM). V.42 bis operation may be enabled or disabled.

The **Break Handling** option is available for Hayes, V.25 bis (Async only), Dumb, Leased line modes (except V.33). When error correction is active, a break signal is relayed with an attention packet. The break-handling option determines how the attention packet is sent.

- **NONE** — No attention packet is sent.
- **DESTRUCTIVE/EXPEDITED (DESTR/EXP)** — All data in the buffer is deleted; the attention packet is then passed through the channel.
- **NON-DESTRUCTIVE/ EXPEDITED (NDT/EXP)** — The attention packet is passed through immediately, but data in the buffer is not deleted.
- **NON-DESTRUCTIVE/NON-EXPEDITED (NDT/NEXP)** — The attention packet is passed through the channel in sequence, and any data is buffered; this preserves the sequence of data and breaks received.

The **Buffer Mode/Speed Conversion** option Hayes, V.25 bis, Dumb, Leased line modes (except V.33). It enables or disables speed conversion (for asynchronous operation only) between the DTE and modem when error correction is not used.

- **ENABLE** — When error correction is not enabled, the V.42 circuit functions as a buffer between the DTE and the modem and provides transmission speed conversion.
- **DISABLE** — Speed conversion is not allowed.

The **DTE Speed option** is available for Hayes, V.25 bis, Dumb, Leased-Line modes (except V.33). It controls the DTE speed; however, it is effective only when the modem is operating in V.42 mode, MNP mode, or buffer mode. The DTE speed can be set for **115,200, 57,600, 38,400, 19,200, 9600, 4800, 2400, 1200, 600, 300, or 110 bps**. The default "DTE speed" is 38,400 bps. DTE speed refers to the speed of data transfer between the DTE and the local modem. It is not necessarily the same as the data transmission speed between the connected modems. If flow control is disabled, the DTE speed must be equal to or less than the modem speed, and the local and remote DTE speeds must be equal.

For Hayes mode operation, the DTE Speed option sets the default DTE speed that will be effective after powerup or after a full modem reset. However, the default DTE speed is automatically overridden when the Modem is autobauded (when an AT attention code is sent to the Modem).

The **Flow Control** options control the data flow according to the availability of memory space in the V.42 buffer. Flow control can be set independently for the modem to the terminal and for the terminal to the modem. The flow-control options include DTE-DCE, DCE-DTE and Pass-Through Flow Control, and Flyback Buffer.

NOTE

When flow control is disabled, the DTE data rate must be equal to or less than the modem data rate, and the local and remote DTE data rates must be equal. (This precludes the need for flow control, which some computers and terminals cannot handle, and avoids buffer overflow.)

The **DTE-DCE Flow Control** options are available for Hayes, V.25 bis, Dumb, and Leased-Line modes (except V.33).

- **NONE** — No flow control is used.
- **RTS ON/OFF** — The Request to Send signal controls data flow from the modem to the terminal.
- **DC1/DC2** — Inserts control characters (CONTROL-R and CONTROL-Q) in the data stream stop and start the flow of data from a device.
- **DC1/DC3 (X-ON/X-OFF)** — The most common method of flow control. It inserts control characters into the data stream: CONTROL-S stops the flow of data, and a CONTROL-Q restarts it.

NOTE

When using the modem for binary file transfer, in-band flow control (flow control using control characters) must be disabled. In this case, use hardware flow control or, as an alternative, lower the DTE speed to lessen the possibility of overflow.

The **DCE-DTE Flow Control** options are available for Hayes, V.25 bis, Dumb, and Leased-Line modes (except V.33). All information given above under **DTE-DCE Flow Control options** also applies to DCE-DTE (modem to terminal) flow control options, except that the CTS, Clear to Send, signal is used to control DTE-DCE data flow instead of RTS.

Flyback Buffer options are available Hayes, V.25 bis, Dumb, Leased line modes (except V.33). The Flyback Buffer option is effective only when MNP error correction is active. Flyback buffering is used for specific applications such as printers, teletypes, etc.

- **ENABLE** — If MNP is buffering data, a five-character delay is inserted after the following characters are sent to the terminal: HT (09), LF (0A), VT (0B), FF (0C), and CR (0D).
- **DISABLE** — Flyback buffering will not occur.

The Pass-Through Flow Control options are available for Hayes, V.25 bis, Dumb, and Leased-Line modes (except V.33). Pass-Through Flow Control affects DTE-DCE flow control only. This option determines whether flow control characters are passed through the communication channel (but only if control characters are used for flow control).

- **ENABLE** — Flow-control characters are passed to the remote end of the communication connection after the modem acts upon them.
- **DISABLE** — Flow-control characters are not passed.

The Address option is available for all modes. The address screen allows you to set the address of the modem at your location. An address may be useful if the Modem will be used in a rack enclosure or in a network environment.

The available address numbers are 000,000 through 999,999. On the Address screen, the three digits to the right of the comma are the unit address number. The three digits to the left are the group address number. To change the address, use the right and left arrow pushbuttons to go to the digit you want to change. Then use pushbutton 1 to decrease (DEC) a number and pushbutton 3 to increase (INC) it. The default address is 999,999.

3.3.2 DIALER MODE

Several **Dialer Mode** options can be selected from the DIALER and DIAL V25bis screens.

The **Dialer Options** are available for all modes.

- **OFF** — The autodialer is off, meaning the modem operates in Dumb mode only. Calls must be made using the front panel AUTO-DIAL function or they must be manually originated.
- **HAYES** — The autodialer automatically dials previously stored phone numbers, and the modem responds to Hayes commands.
- **DTR** — This selection enables DTR dialing, an option that allows you to set up the Modem to automatically dial a stored number even when the autodialer is not enabled. (For further information, see Section 4.5).

The V.25 bis **Dialer Modes** are available for V.25 bis mode.

Any of the selections from the DIAL V25bis screen will enable the V.25 bis autodialer. For detailed information on the V.25 bis autodialer, see Chapter 6.

The three selections on the DIAL V25bis screen allow you to select a data protocol that is appropriate for the DTE the Modem is connected to:

- **ASYNCHRONOUS** (Asyn)
- **SYNCHRONOUS, CHARACTER ORIENTED** (Syn_c)
- **SYNCHRONOUS, BIT ORIENTED** (Syn_b)

NOTE

DTR dialing for V.25 bis mode cannot be enabled through the DIALER screen. To select DTR dialing for V.25 bis mode, you must use the Summary Setup feature, as explained in Chapter 6.

The **Auto-Answer** option is available for Hayes, V.25 bis, and Dumb modes. It determines whether or not a call is automatically answered when the phone rings. Setting the Auto-Answer option to **ENABLE** resets Hayes mode register S0 to 1 (meaning that calls are answered on the first ring).

3.3.3 DATA FORMAT OPTIONS

The Data Format (Sync or Async) option is available for V.25 bis, Dumb, and Leased-Line modes. The data format setting for the local modem and for the remote modem must be the same.

- **ASYNCHRONOUS** — Data is transmitted and received in the character asynchronous format. The character length (next option) must be the same for both communicating modems.
- **SYNCHRONOUS** — If this option is selected, data must be transmitted and received in the synchronous format. The appropriate transmitter clocking option must be selected. The synchronous data format is not available for data rates of 300, 19,200, or 38,400 bps.

The **Character Length** option is available for all modes (asynchronous operation only). It selects a character length of 8, 9, 10, or 11 bits for character asynchronous operation. The same character length must be selected for both the local and the remote modems. Use pushbuttons 1 and 3 to select the desired character length.

- **8 BITS:** 1 start bit, 6 data bits and 1 or more stop bits.
- **9 BITS:** 1 start bit, 7 data bits and 1 or more stop bits.
- **10 BITS:** 1 start bit, 8 data bits, including parity, and 1 or more stop bits.
- **11 BITS:** 1 start bit, 9 data bits, including parity, and 1 or more stop bits.

In Hayes mode, character length is set automatically under most conditions.

The **Parity** option is available for all modes. Parity selections are effective only if error correction or buffer mode has been enabled or if the Modem is in 2-Wire Dial (Hayes) mode. For most applications, parity should be set to NONE.

The following parity options are available: **NONE** (no parity), **ODD**, **EVEN**, **MARK** (parity is always 1) and **SPACE** (parity is always 0). All parity settings except **NONE** automatically enable parity conversion (except in Hayes mode), meaning that the parity of received data is converted to match the selected parity option.

In Hayes mode, parity is set automatically under most conditions.

3.3.4 DISCONNECT OPTIONS

When the modem is operating in V.25 bis or Dumb mode, it is necessary to disconnect the modem from the telephone circuit once communications are completed. The most common form of disconnection is by dropping the Data Terminal Ready (DTR) signal from the DTE. However, some applications may require one of the five available automatic disconnect methods listed below.

For all five disconnect options, "disabled" means the modem will not disconnect in the presence of the conditions specified below.

The **RX (Receive) Space Disconnect** option is available for Hayes, V.25 bis, and Dumb modes. If it is enabled, a 1.6-second continuous space will cause the modem to disconnect.

NOTE

For Hayes mode operation, both the RX Space Disconnect and TX Space Disconnect options must be either enabled or disabled.

The **TX (Transmit) Space Disconnect** option is available for Hayes, V.25 bis, Dumb modes. When TX Space Disconnect is enabled, the Modem transmits 4 seconds of space prior to disconnecting from the line. This ensures a clean disconnect if RX space disconnect is enabled on the remote modem.

NOTE

For Hayes mode operation, both the TX Space Disconnect and RX Space Disconnect options must be either enabled or disabled.

The **Character Disconnect** option is available for V.25 bis, and Dumb modes. If it is enabled, a 400-ms loss of carrier signal causes the line to be disconnected. (To set this option for Hayes mode, use S register S10 – see **Section 5.3.**)

The **Line Current Disconnect** option is available for V.25 bis, Dumb modes. If enabled, a 400-ms loss of current causes the line to be disconnected. (To set this option for Hayes mode, use S register S10 – see **Section 5.3.**)

The **RTS Disconnect** option is available for Hayes, V.25 bis, and Dumb modes.

When RTS Disconnect is enabled, if RTS is off for a selected period of time (20 to 140 seconds, user selectable), the line is disconnected. Use pushbuttons 1 and 3 to set the RTS-OFF period required for a disconnect.

3.3.5 TEST OPTIONS

The Test Options *affect* certain tests (as explained below) but do not *activate* tests.

The **DSR During Analog Loopback** is available for all modes. When ON is selected, the Data Set Ready signal is forced on when the modem is in the analog loopback test mode. In general, this option should be left ON (the default selection).

The **Remote Test** option is available for all modes. The Remote Test option allows you to prevent tests from being initiated on the local Modem from a remote modem. If DISABLE is selected from the Remote Test screen, the local Modem ignores test initiation signals from a remote modem. If ENABLE is selected, tests can be initiated from a remote modem.

Note that there are two REMOTE TEST screens. One is for the option just described; the other is used for selecting either the remote digital loopback tests or remote front panel control. The Remote Test option screen (for preventing or allowing remote testing) looks like the one shown below.

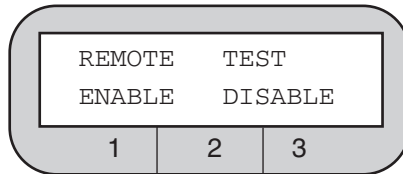

3.3.6 EIA OPTIONS

The seven options described below allow control over specific EIA interface signals.

The **CTS to EIA** options are available for all modes. Regardless of the setting selected for this option, Clear to Send (CTS) is off during flow control (which occurs if error correction and flow control or buffer mode are enabled).

- **NORMAL** — The Clear to Send signal is on while the modem is on-line.
- **RTS** — The CTS signal immediately follows the RTS signal with no delay.
- **TRUE** — The CTS signal follows DTR.

CTS can also be set to be ON at all times regardless of DTR by using the Summary Setup feature. However, if CTS on/off is selected from DCE-DTE screen 1, V.42 flow control, while active, overrides the CTS ON selection. To set CTS ON, refer to **Appendix C**. Note that if you set CTS to ON using Summary Setup and then make a selection from the CTS to EIA screen, that selection cancels the Summary Setup CTS ON selection.

NOTE

The Modem also supports a CTS option intended only for V.33 and Bell 208A/B operation, described later in this chapter.

The **CD to EIA** option is available for Hayes, V.25 bis, and Dumb modes.

- **NORMAL** — Carrier Detect (CD) is on while the modem is on-line.
- **TRUE** — CD follows DTR supplied from the DTE.
- **TOGGLE** — CD turns on whenever DTR is present and then toggles off for 500 ms upon disconnect, allowing the attached DTE to recognize that the call is ended and the connection is dropped.

The **DSR to EIA** option is available for Hayes, V.25 bis, and Dumb modes.

- **NORMAL** — Data Set Ready (DSR) is on while the modem is on-line.
- **TRUE** — DSR follows DTR supplied from the DTE.
- **CROSSOVER (XOVER)** — DSR is ON without DTR and toggles for 500 ms upon local or remote disconnect.

The **DTR from EIA** is available for all modes. It allows you to force the Data Terminal Ready (DTR) signal on (TRUE), which may be needed if your computer or communication software does not supply a DTR signal.

- **NORMAL** — DTR is supplied by the DTE.
- **TRUE** — The DTR signal is internally forced ON regardless of the DTR status at the interface.

The **DTE Control Of ALB (ALB- DTE Ctrl'ed)** option is available for all modes. Analog loopback (ALB) testing can be initiated from the DTE via pin 18. Positive voltage activates the test, whereas negative voltage results in normal operation. Disabling this option keeps the modem from responding to pin 18.

The **DTE Control Of RDL (RDL- DTE Ctrl'ed)** option is available for all modes. Remote digital loopback (RDL) can be initiated from the DTE via pin 21. Positive voltage activates the test, whereas negative voltage results in normal operation. Disabling this option keeps the modem from responding to pin 21.

The Test Mode (TM to EIA) option is available for all modes. It controls pin 25, the test mode (TM) indicator, on the RS-232 interface connector.

- **NORMAL** — TM output is high (active) only during test modes.
- **TRUE** — TM output is high all of the time.

3.3.7 MODEM SETUPS

The options listed below, through RTS-CTS DELAY, are available through the MODEM SETUPS screens.

The **Carrier Detect** option is available for all modes. It selects the carrier detect level. To make a selection, first select either LEASED or DIAL from the CARRIER DET. LVL screen, depending on your application. The appropriate carrier detect level screen is displayed.

- **For leased-line use** — the carrier detect level can be set for 43, 33 or 26 dBm. The default setting is 26 dBm.
- **For dial-line use** — the carrier detect level can be set for 51, 41, or 34 dBm. The default setting is 51 dBm.

The **Transmit Level** option is available for all modes. It controls the modem's transmission level. To make a selection, first select either LEASED or DIAL from the TRANSMIT LEVEL screen.

- **For leased lines** — the transmission level can be set between 0 and -15 dBm, in 1-dBm steps. The standard setting is 0 dBm. (Use pushbuttons 1 and 3 to select the desired transmission level.)
- **For dialup applications** — the transmission level for dial lines can be set as either programmable, if you are using RJ-45S connectors, or permissive, fixed at -10 dBm +/-1 dBm, which is the most common setting.

The **Signal Quality** option is available for all modes. It sets the threshold for the ER (error) indication during normal operation. You can choose either "10 3", one error in 1000 bits, or "10 5", one error in 100,000 bits. Signal quality (along with carrier detect) also controls the threshold the modem uses as a criterion for entering the Leased Line Auto-Recovery mode.

The **Compromise Equalizers** option is available for all modes.

NOTE

The compromise equalizers affect only V.32 operation (4800 to 14,400 bps, asynchronous/synchronous, full duplex).

For most applications, the automatic adaptive equalizer setting provides all the equalization necessary to compensate for line impairments, meaning that equalizer adjustments are generally not necessary. However, in the event that equalizer adjustment is needed, any of four types of compromise equalization can be selected: Type I (T-I on the LCD), Type II (T-II), Type III (T-III) and Type IV (T-IV). The equalizer can also be turned OFF.

Where line conditions are atypical, it may be necessary to adjust the equalizers to optimize the signal quality. If adjustment is necessary, refer to the quality screen for guidance; this screen shows a relative indication of the signal quality, in both numeric and graphic form.

The **Trellis Code** option is available for all modes. Trellis coding provides performance advantages for all modulation patterns. The modem's CCITT compliant trellis coder is normally enabled at speeds of 9600 bps and above, but may be negotiated off by a modem that is not equipped with a trellis coder. The trellis code option allows you to enable or disable the trellis coder.

The **Transmitter Clocking** option is available for all modes. It selects one of three possible sources for the transmitter timing signal:

- **INTERNAL** — The timing of the modem and data terminal transmitting circuits is provided by an internal clock within the modem.
- **RECEIVED (RX-CLK)** — The timing of the received data is used to control the timing of the data transmitted. This timing mode is used if the modem's transmit timing must be controlled by a remote source.
- **EXTERNAL** — The timing of the modem and data terminal transmitting circuits is provided by an external clock within the data terminal and is provided to the modem via the DTE connector pin 24. This mode of clocking is used if the DTE must be in control of the modem's transmit timing.

The **T1 Timer** option is available for Hayes, V.25 bis, and Dumb modes. It determines how long the Modem attempts to handshake with a calling V.32 modem before falling back to a lower speed. The available T1 Timer settings are **0, 0.3, 0.8, 1.6 and 3.0 seconds**.

Normally, as part of the V.32 handshake, the calling modem begins sending a sequence to the answer modem while the answer modem is still sending answer tone. In this case, there is no T1 timer. However, the V.32 recommendation allows for a T1 time of up to 3 seconds, meaning that the answer modem may be set to wait (before falling back) for up to 3 seconds.

The B option is available for all modes. If the Modem makes a connection at one of the V.32 rates (4800 to 14,400 bps) or V.22 bis rate (2400 bps), it can request that the remote modem send a retrain sequence.

- **ENABLE** — The modem requests a retrain sequence.
- **DISABLE** — The modem will not request a retrain sequence.

The **Answer/Originate Default** option is available for Hayes and Leased modes (and manual originate/answer dial operation). It sets the Modem to default to either answer or originate status.

- **ANSWER** — Sets the Modem to answer mode.
- **ORIGINATE** — Sets the Modem is set to originate mode.

The **Answer Tone** option is available for Hayes, V.25 bis, and Dumb modes. The answer-tone frequency is selectable only if the maximum data rate is set to 1200 bps (via the SPEED LIMIT menu), in which case the answer tone can be set to either 2225 or 2100 Hz. Otherwise, the answer tone frequency is 2100 Hz (the standard for V.32 operation). In general, this setting should not be changed (even for fallback with Bell standard modems, which use a 2225-Hz answer tone).

The **Front Panel Control** option is available for all modes. It controls the use of the front panel. If disabled, the front panel of the modem will not respond to changes to the Setup menus. Front Panel Control is a security feature helpful in situations where it is undesirable for the modem's configuration to be changed.

Two speaker options are available: Speaker Control and Speaker Volume.

The **Speaker Control** option is available for all modes.

- **ON** — Speaker is on during the full modem handshake process and while the unit remains on-line.
- **OFF** — The speaker is off; the call cannot be audibly monitored.
- **ON TILL CD** — Speaker remains on until a carrier signal (CD) is detected.

The Speaker Volume option is available for all modes. It can be set to LOW, MEDIUM, or HIGH.

The **Guard Tones** option is available for Hayes, V.25 bis, Dumb modes. Guard tones are used in V.22 and V.22 bis modes only, to assure proper band separation on systems that use international telephone circuits. Unless you are using international circuits in one of these modes, you should turn the guard-tone option OFF. If guard tones are required, their frequency can be set to 550 Hz or 1800 Hz (the most commonly used guard-tone frequency).

V.13 Operation is available for V.25 bis, Dumb, and Leased modes (synchronous operation only).

- **OFF** — V.13 operation is off. This setting allows normal full duplex operation. (All other selections are for enabling V.13 operation.)
- **TX ONLY** — Status of RTS will be sent to remote modem.
- **RX ONLY** — Carrier Detect (CD) will be controlled by V.13 signals from the remote modem.
- **TX AND RX** — Status of RTS will be sent to remote modem, and CD will be controlled by V.13 signals from the remote modem.

To select one of the four V.13 options, press pushbutton 1 or 3 with the V13 screen displayed until the selection you want is displayed. For half-duplex point-to-point applications, select TX AND RX. For multidrop applications, select RX ONLY for all modems at the host site and TX ONLY for all modems at the remote site. For further information on V.13 operation, see **Section 4.10**.

3.3.8 V.33 AND BELL 208A/B OPTIONS

The following three options are available on the Modem only and are intended only for V.33 or Bell 208A/B operation. (For Bell 208 operation, see also the Satellite Delay and Turnaround Delay options.)

The **Carrier Type** option is available for V.25 bis, Dumb, Leased line modes.

- **SWITCHED (SWITCH)** — For 2-wire applications, the carrier type option must be set for switched carrier operation.
- **CONSTANT** — Constant or continuous carrier can only be used for 4-wire leased-line applications (although such applications may also use switched carrier).

The CTS option is available for 4-wire Leased Line modes. It applies only to 4-wire leased line applications using constant carrier.

- **RTS** — The CTS signal follows RTS.
- **ON** — CTS is always ON.

NOTE

The Modem also supports a CTS to EIA option, which is described earlier in this chapter under EIA OPTIONS.

The **RTS-CTS Delay (CTS Delay)** option is available for V.25 bis, Dumb, Leased line modes. The available RTS-to-CTS delay settings are 0, 15, 50, or 150 ms. However, the only available choices for 208A/B operation are 50 and 150 ms. If you select 0 or 15 ms, the actual delay in 208A/B mode will be 50 ms.

NOTE

RTS-to-CTS delay is not effective if the CTS option is set to ON (always ON). For V.33 operation, RTS-to-CTS delay is effective only for 4-wire leased line applications that use constant carrier.

The PHONE screen for storing a telephone number and Auto-Recovery are discussed in **Sections 4.2 and 4.3**.

The **LCD Intensity** option is available for all modes. It allows you to use pushbutton 3 (for INC or increase) to darken characters on the LCD or pushbutton 1 (for DEC or decrease) to lighten them.

3.3.9 OPTIONS ACCESSIBLE WITH SUMMARY SETUP ONLY

The twelve options described below can only be changed through the modem's Summary Setup feature, which is explained in **Appendix C**.

The **Wait For Carrier** option is available for V.25 bis, Dumb modes. The time the modem waits for a carrier signal when originating a call can be set for 30, 45, 60, or 75 seconds. (In Hayes mode, the wait-for-carrier time is determined by the value in register S7.)

The **Phase Reversal in Answer Tone** option is available for all modes. When enabled, the Phase Reversal in Answer Tone option signals the telephone network to turn off its echo cancelers. For virtually all applications, phase reversal should be enabled (the default setting).

The **Satellite Delay** option is available for 208 mode. It facilitates transmission over satellite links (but does not permit fast-turnaround operation). When the Satellite Delay option is on, RTS is inhibited for 275 ms after the answer tone stops and after the DSR signal comes on. The delay occurs at both the originating and answering modems, allowing the echo suppressors on the telephone link to be enabled.

The **Turnaround Delay** option is available for 208 mode. It is intended for circuits where echo is a problem. It prevents the Modem from receiving an echo of its own transmitted data. When the Turnaround Delay option is on, CD (pin 8) is held low for 150 ms after RTS is turned off. If the modem detects an energy loss during the delay, it turns CD on 52 ms after detecting the loss. If the modem does not detect an energy loss, it turns CD on 52 ms after the end of the delay. The modem ignores any energy loss during the first 8.5 ms.

The Analog Loopback Make Busy is available for all modes. If the Analog Loopback Make Busy option is enabled, the Modem provides a busy indication to the dial line interface when the Modem is in analog loopback test mode.

The **Selective Retransmission** option is for Hayes,V.25 bis, Dumb, and Leased-Line modes (except V.33). This option allows the Modem to communicate with certain modems that are not able to respond to the MNP selective retransmission command.

- **Enable** — This setting allows the modem to request retransmission of a single information frame (in the event of a transmission error).
- **Disable** — Data can only be retransmitted in a series of information frames.

The **DCE Pass-Through Flow Control** option is for Hayes,V.25 bis, Dumb, and Leased-Line modes (except V.33)

This option affects DCE–DTE flow control only. It is only effective if error correction or buffer mode/speed conversion is ‘enabled’.

- **Enable** — The Modem will pass flow control characters received from the remote modem to the local DTE.
- **Disable** — The Modem will not pass flow control characters from the remote modem to the local DTE.

The **Link Flow Control** option is for Hayes,V.25 bis, Dumb, Leased-Line modes (except V.33)

This option is effective only if buffer mode/speed conversion is enabled and an error-correction link is not established.

- **Enable** — The Modem will check for X-ON/X-OFF (DC1/DC3) flow control characters received from the remote modem to determine whether to stop or start/restart data transmission to the remote modem. A DC3 (or DC2) control character will cause the Modem/Modem 3242-S to stop data transmission and hold data in its buffer until it receives a DC1 control character (which instructs the modem to resume transmission).
- **Disable** — The Modem will ignore X-ON/X-OFF (DC1/DC3) flow control characters received from the remote modem.
- **Slaved** — Link flow control is controlled by the DCE-DTE Flow Control option. If DCE-DTE Flow Control is set to NONE or CTS, Link Flow Control is disabled. Otherwise, it is enabled.

The **V.32 Mode** option Hayes, V.25 bis, Dumb, and Leased-Line modes (except V.33)

This option is used to select CCITT V.32 bis operation or V.32 extended operation.

When **V.32 bis mode** is selected (factory-default setting), the following are available: RRP (Rate Renegotiation Procedure); data rate of 7200 bps; RATE screen that allows you to manually initiate RRP. RRP enables the modem to auto-matically fall back *or* fall forward to a lower *or* higher data rate during data transmission in response to changes in signal quality. Selecting V.32 bis mode makes RRP available as an option; however, *RRP will not function unless it is enabled* (the default setting is enabled.)

When V.32 bis mode is selected, a RATE screen is available from MAIN MENU screen 3. The RATE screen can be used to manually initiate RRP for diagnostic purposes. For additional information, see *Section 7.6, Diagnostic Monitoring: Status Screens*.

When V.32 bis mode is selected, 7200 bps can be selected as the maximum or minimum data rate (using the Speed Limit option). When V.32 bis is not selected, 7200 bps operation is not available.

NOTE

By definition, V.32 bis operation includes the ability to operate at 12,000 and 14,400 bps. Therefore, only the Modem is a true V.32 bis modem. However, when the V.32 bis mode is selected on the Modem 32192, it will support the following options as well: RRP; 7200 bps data rate; the RATE screen.

The **V.32 extended mode** disables the V.32 bis features. In V.32 extended mode, the Modem's functional ability is identical to that of previous models of this modem series (the MD833A model prior to incorporation of the CCITT V.32 bis recommendation.)

The **208 Phase Detection** option is for 208 mode.

- **Normal** — Conditions the modem's 208 receiver for normal modulation detection.
- **Compensated** — Conditions the 208 receiver for compensated modulation detection for improved performance with older 208 modems.

The **Answer Tone Detection** is for 208 mode.

- **Enable** — Conditions the originating modem's receiver to wait for answer tone detection before going on-line.
- **Disable** — Conditions the originating modem to go on-line without requiring answer tone detection. This setting accommodates operation with automatic calling units that connect the modem to the line at the end of answer tone.

The **Multimode Handshake** option is for Hayes, V.25 bis, and Dumb modes.

This option determines how long the Modem will attempt to handshake with a V.32 modem before falling back to a lower speed.

- **T1 Timer** — If the T1 timer setting is selected, the modem will attempt to handshake with a calling V.32 modem for the time specified by the T1 Timer option.
- **V.32 bis ANNEX A** — If the V.32 bis Annex A setting is selected, the modem will handshake according to the conventions established in *Annex A* of the CCITT V.32 bis recommendation. Handshaking using the Annex A selection will generally be faster than handshaking based on the T1 timer.

NOTE

The T1 Timer option (Section 3.3.7, Modem Setups) is only effective if the Multimode Handshake option is set to 0 (T1 timer).

Two additional options, Operating Mode Fallback and V.32 Speed Fallback, are discussed in **Section 4.9**.

4.0 General Operation and Special Features

This chapter describes the following Modem features and operational modes (listed here in the order in which they are presented):

- Quick reset
- Phone number storage
- Leased Line Auto-Recovery
- Dial Line Auto-Recovery
- DTR dialing
- Dumb mode and Bell 208 operation
- Security operation
- Diagnostic interface control
- Automatic fallback
- V.13 operation

The status screens, which display data concerning the operational status of the modem, are discussed in **Chapter 7**. Instructions for using the pushbutton controls and LCD are included in **Chapter 3**.

4.1 Quick Reset

Quick Reset enables you to reset the modem without powering down the unit. For a soft reset of the Modem—when option settings are not changed but the modem is cleared for a new start, and the ROM memory chip is checked—select RESET from MAIN MENU screen 3. The modem displays the power-on screen for a few seconds. Then it displays the EIA status screen.

4.2 Phone Number Storage

This feature is used to store a number to be used later for autodialing from the front panel, DTR dialing, or for leased line or dial line auto-recovery. To store numbers in Hayes mode, see **Chapter 5**.

To store a number from the front panel, select PHONE from MODEM SETUPS screen 5. The following screen is displayed:

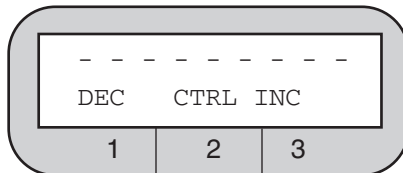

If a number has been previously stored, the number is displayed on the top line of the LCD (instead of dashes, as shown above).

Only one phone number can be stored per cell. To store a phone number, use the right and left arrow pushbuttons to go to the digit you want to change. The character at the current cursor location flashes. Use pushbutton 1 to decrease a number at the current cursor location or pushbutton 3 to increase a number. Use pushbutton 2 (CTRL) to sequence through the dialing control characters (listed below). Use the arrow pushbuttons to move on to the next digit or character to be changed. The phone number is saved when you return to the MAIN MENU.

4.3 Leased Line Auto-Recovery

When conditions on the leased lines deteriorate, the Leased Line Auto-Recovery feature allows the Modem to automatically restore operation for a leased line application by using dial lines as a backup. The Modem uses signal quality and loss of carrier detect to determine if line conditions are unsatisfactory. Leased Line Auto-Recovery is accessed via the AUTO-RECOVERY screen on the front panel LCD. The following conditions are required for Leased Line Auto-Recovery operation:

- Leased Line Auto-Recovery must be enabled (using the Leased Line Auto-Recovery Select option) on both communicating modems.
- The Leased Line Auto-Recovery Select, Return and Test options must be set correctly on both communicating modems, as explained in the following sections.
- A dial backup line (or lines) must be installed.
- The phone number to be dialed (the backup line) must be stored in the originate modem, as explained in the previous section.
- Auto-answer must be enabled on the answer modem.

Table 4-1. Dialing Control Characters.

Character	Function
A-D	Used in some PBX applications (tone dialing only).
L	Links a phone number to another number to be dialed as an alternate.
T	Sets tone-dialing mode.
P	Sets pulse-dialing mode.
R	Configures modem for Dial Line Auto-Recovery. Requires / prefix. See DIAL LINE AUTO-RECOVERY section later in this chapter.
W or : (colon)	Wait 30 seconds for dial tone before proceeding.
, (comma)	Inserts 4-second pause.
. (period)	Marks end of phone number.
- (dash)	Used only for clarity (no function).
(space)	Used only for clarity.
*	Dial * (tone dialing only).
#	Dial # (tone dialing only).
<p>A, B, C and D are used in some private branch exchange (PBX) applications. The * and # symbols are sometimes used for access to remote computer systems.</p>	

4.3.1 AUTODIAL BACKUP

The Modem automatically dials the stored number to connect over the backup line if it detects poor signal quality (ER) or a loss of carrier detect (CD) on the leased line. The criteria used by the Modem in assessing the condition of the leased line depend upon the settings of the Signal Quality option (one error in 10^5 or 10^6 bits) and the Carrier Detect Level option (-43, -33 or -26 dBm).

When Dial Backup occurs (either automatically or by operator intervention), the following message flashes on the front-panel LCD of both modems:

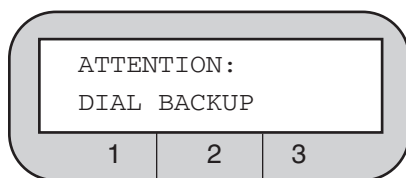

The message clears when the modem returns to the leased line. If you want to clear the message while the Modem is still in dial-backup mode, press the ENT pushbutton.

4.3.2 EXIT FROM LEASED LINE AUTO-RECOVERY

If the Leased Line Auto-Recovery Return option is enabled (see below), the Modem automatically exits the Auto-Recovery mode when leased-line conditions are satisfactory. Any normal disconnects (such as loss of carrier or line current) may also disconnect the dial connections and return communication to the leased line. To ensure the proper disconnect capabilities for Leased Line Auto-Recovery mode, both the line current disconnect (CURRENT DISC'T screen) and carrier disconnect (CARRIER DISC'T) options must be enabled on both modems. To manually exit the Leased Line Auto-Recovery mode and return to leased line operation, select DIAL from MAIN MENU screen 1, and then select HANGUP from the AUTO-DIAL screen.

4.3.3 LEASED LINE AUTO-RECOVERY OPTIONS

Three options allow you to specify the criteria the Modem uses in determining when to enter and exit the Leased Line Auto-Recovery mode:

- Leased Line Auto-Recovery Select (Select)
- Return From Leased Line Auto-Recovery (retn)
- Test Interval (Test)

The **Leased Line Auto-Recovery Select** option determines the type of Leased Line Auto-Recovery desired. "DIAL IF BAD >> (1, 2, 3 or 4) min" means dial backup occurs if bad line conditions are present for the number of minutes selected. To disable Leased Line Auto Recovery, select NO AUTO RECOVERY. A sixth option, **Manual Recovery**, is discussed below.

NOTE

If **DIAL IF BAD >> (1, 2, 3 or 4) min** is selected, the **Select option setting of the answer unit must be equal to or less than the Select option of the originate unit.**

If both modems are set for **Manual Recovery**, the originate unit is used to autodial the number stored via the **PHONE** screen without having to change the **LINE TYPE** setting on either unit. To autodial, access the **AUTO-DIAL** screen and select **DIAL**. To return to the leased line, select **HANGUP** from the **AUTO-DIAL** screen.

The **Return From Leased Line Auto-Recovery** option determines the criteria for exiting the Leased Line Auto-Recovery mode. <D%0> “**RETURN IF GOOD >> (10, 40, 60, or 120) seconds**” means the modem automatically exits the Leased Line Auto-Recovery mode when it tests and finds the leased <M%-2>line in good condition for more than the time period specified (10, 40, 60 or 120 seconds). <D%0> If the Return option is set to **OFF**, the modem stays in the Auto-Recovery mode indefinitely, unless you select **HANGUP** from the **AUTO-DIAL** screen, a loss of line current, or other normal disconnect occurs. Either event returns communication to the leased line.

NOTE

The Return option setting must be the same on both communicating units.

If the Return option is enabled (>> 10, 40, 60, or 120 seconds), the Test Interval selections control how frequently the Modem tests the leased line conditions to determine if exit from the Leased Line Auto-Recovery mode is desirable. Exiting is based on the criteria selected for return from Auto-Recovery. The Modem can be set to test every 10, 20, 40, or 60 minutes.

NOTE

The Test option setting must be the same on both units.

4.4 Dial Line Auto-Recovery

The Dial Line Auto-Recovery feature allows you to set up the Modem for a dial-up application so it automatically redials to restore a broken connection if the modem goes on-hook. In this way, the Dial Line Auto-Recovery feature emulates the reliability of a leased line connection.

4.4.1 SETTING UP THE MODEM FOR DIAL LINE AUTO-RECOVERY

Two steps are required to set up the Modem for Dial Line Auto-Recovery. First, enter or store the number to be dialed with the **/R** command. Then, enable Dial Line Auto-Recovery. To configure the Modem for Dial Line Auto-

4.0 General Operation and Special Features

Recovery from the front panel, enter the phone number to be dialed followed by /R (the Dial Line Auto-Recovery command) on the PHONE screen (shown below).

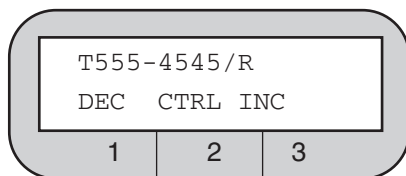

If you need assistance, see **Section 4.2**.

An alternate way to configure the Modem for Dial Line Auto-Recovery (in Hayes mode only) is to use the Hayes AT &Z command to store the phone number to be redialed and the /R command in memory location 0, by entering the following command:

AT &Z0=T555-4545/R

Dial Line Auto-Recovery is not enabled until you select DIAL from the front panel AUTO-DIAL screen. If power is removed from the modem, select DIAL to re-enable Dial Line Auto-Recovery. To disable Dial Line Auto-Recovery, select RESET from MAIN MENU screen 3.

4.4.2 RECOVERY PROCEDURE

If Dial Line Auto-Recovery is enabled and the Modem goes on-hook, it redials the stored phone number up to 10 times. It redials 5 times at 30-second intervals, waits 2 hours, and then redials 5 additional times at 30-second intervals. The Modem stops redialing after 10 attempts.

If a connection is broken, re-established, and broken again, the full sequence of 10 redial attempts does not occur unless the Modem is on-line for more than 1 hour. The modem redials, but it is programmed not to exceed more than 10 redial attempts in 1 hour.

4.5 DTR Dialing

NOTE

To use DTR dialing in V.25 bis mode, you must use the Summary Setup feature, explained in Chapter 6.

4.5.1 DIALING A STORED NUMBER

DTR dialing allows you to set up the Modem to automatically dial a stored number even when the autodialer is not enabled.

To enable DTR dialing, select DTR from the DIALER option screen. When DTR dialing is enabled, an OFF-to-ON transition of DTR causes the Modem to automatically dial the number previously stored using the front-panel LCD. DTR must remain on for at least 50 ms to effect automatic dialing. A 50-ms drop of DTR aborts the process or disconnects the call. When DTR goes high again for at least 50 ms, the automatic-dialing process begins again.

4.5.2 ANSWER MODE OPERATION

If the Modem is set for DTR dialing, it automatically answers without DTR. However, it will not transfer data until DTR goes high. The call may be terminated by dropping DTR.

4.6 Dumb Mode And Bell 208 Operation

Bell 208 operation is available on the Modem only. For additional information, see **Section 2.4.6**. Table 6-2 in **Chapter 6** lists dialing parameters that may be used to modify Dumb mode or Bell 208 dialing operations.

MANUAL ORIGINATE/ANSWER OPERATION

When the Modem is operating in Dumb mode or configured for Bell 208 operation, data calls may be manually originated from a phone set. (Plug the phone into the Modem jack marked PHONE.)

For manual-originate operation, the remote modem may be configured for either automatic or manual answer. For manual originate/answer operation, one modem must be set to ANSWER and one must be set to ORIGINATE via the ANS/ORG DEFAULT screen. For either type of operation, use the Dumb mode or Bell 208 Quick Setup to configure the Modem. (The Dumb mode Quick Setup defaults to asynchronous operation; the Bell 208 Quick Setup defaults to synchronous operation.)

Either Quick Setup sets the Modem to originate mode. If you want to set your Modem to answer mode, use the front-panel controls to access the ANS/ORG DEFAULT screen (MODEM SETUPS screen 4). Then, select ANSWER (answer mode). To manually originate a data call, select TALK from MAIN MENU screen 1. The MANUAL-DIAL screen is displayed. Select TALK again. This puts the Modem in talk mode. Lift the handset and listen for the dial tone. Dial the phone number of the remote modem. When you hear a high-pitched answer tone, select DATA from the MANUAL-DIAL screen, and

place the handset back on the cradle. The LCD displays the status of the communication. It appears as shown below.

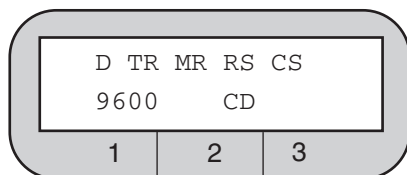

The data link between the two modems is now established, and data transfer begins.

An incoming call may be answered manually or automatically. To answer a data call manually, you must disable the Auto-Answer option. Before the call is received, the Modem must be set to TALK, as explained in the previous section. The first unit that is switched to DATA mode must be set for answer mode (using the answer/originate option). The other unit must be set for originate mode.

NOTE

If you set the Modem to talk mode, the phone rings, but the Modem will not answer, even if the Auto-Answer option is enabled.

After you answer the phone and initiate a conversation with the caller, the Modem must be set for data mode. With the MANUAL-DIAL screen still displayed, select DATA to put the Modem in data mode.

The first person to go to data mode hears his telephone disconnect as his modem connects. The other person must wait until he hears an answer tone, and then switch to data mode (select DATA). When both modems are in data mode, the data communication begins. The LCD displays the status of the connection.

There are several ways a data call can be terminated. You can terminate a call through communication software by following the software manufacturer's instructions. An alternate method is to switch to the TALK option (talk mode) on the MANUAL-DIAL screen, as described in the previous section. Or you can drop the DTR signal from the DTE (by software control or by turning the DTE off).

4.7 Modem Security Operation

In 2-Wire-Dial Hayes emulation mode only, the Modem can be configured to provide security on incoming calls. Remote users attempting to connect to the Modem are required to enter a password. Incoming calls are accepted only if the user enters a valid password.

NOTE

The security features described in this manual provide a deterrent to unauthorized access. No communications system can be made perfectly secure.

PASSWORD PROTECTION

NOTE

Password protection functions only if the Modem is in Hayes emulation mode, error correction and/or buffer mode are enabled, and the data format is asynchronous.

In Hayes mode only, the Modem can be configured for two types of security operation: security callback or password pass-through operation. Both types of security operation provide security on incoming calls by requiring remote users to enter a valid password. In addition, access to Hayes compatible commands for viewing and storing phone numbers is password-protected.

If callback operation is enabled, the Modem calls back an authorized user after he or she enters a valid password. If pass-through operation is enabled, the Modem passes a connection on to the DTE interface only after it receives a valid password.

The password-protection scheme used by the Modem for incoming calls is summarized below.

- A remote modem calls the local Modem.
- Local Modem answers.
- Remote user sends carriage return [CR].
- Local Modem sends PASSWORD? query, displayed on remote terminal.
- Remote user sends unique password (assigned to remote modem).
- Local Modem confirms password and, according to the password, grants access (if programmed for pass-through operation) or initiates security callback.

4.0 General Operation and Special Features

The modem's security configuration for password protection is controlled from the DTE by a special set of password commands. The commands are implemented by using the Hayes AT &Z command to store them in memory. If an administrative password is implemented, the AT &Z command will not function until it is unlocked.

The Modem incorporates 10 memory locations for storing telephone numbers, passwords, and the password commands listed in Table 4-2. To implement a security command, use the Hayes AT &Z command to store the command in a specific memory location. The password commands are listed in Table 4-2 and explained in detail in the sections that follow.

Table 4-2. Password Commands

COMMAND	FUNCTION	EXAMPLE ¹	MEM.LOC. ²
/A	Set/change administrative password; password-protects use of certain Hayes commands.	/ASECURITY	1
/P	Set password for pass-through operation or security callback operation	/PYELLOW 4443535/PGREEN	2-49
/U	User-defined text string. Used to send a response to the remote terminal user after a valid password is received.	/UCONNECTED	0

¹Command string stored using AT &Z commands.
²Each command will function only in the listed memory locations.

Rules for using passwords and password commands are listed below.

- Memory locations 0 and 2-9 may be used for storing phone numbers; locations 2-9 may be used to store passwords.
- The entire command string, including the AT &Z command, cannot exceed 40 characters.
- Passwords and commands may be entered in capitals or lowercase letters. They are stored and displayed as capitals.
- For password pass-through operation, / must be the first character in a storage location. For security callback operation, a phone number must be listed first in a storage location.
- Special characters (! @ ? , etc.) may be used for passwords entered with the DTE interface, but these characters cannot be entered with the Modem's front panel.
- A phone number cannot be stored after / .
- Only one command (/A, /P, or /U) can be stored in each memory location.
- Do not leave a space after a command.
- When using the /U command, do not include spaces or control characters in the specified text string.

The following instructions explain how to use the password commands.

1. Establishing or changing the administrative password. For greatest security, you should use an administrative password. If implemented, the administrative password controls access to the Hayes compatible &V and &Z commands. The commands are required to view or modify the modem's security configuration (as explained in the following sections). To establish or change an administrative password enter the following command replacing SECURITY with your password:

AT &Z1=/ASECURITY

NOTE

The administrative password may be stored only in memory location 1. The command line, including AT &Z1=, cannot exceed 40 characters.

2.Unlocking the &V and &Z commands. If an administrative password is implemented, the Hayes compatible **&V** and **&Z** commands cannot be accessed unless they are first unlocked using the current administrative password. (**&V** is used to view the active modem configuration, stored phone numbers, password commands and passwords; **&Z** is used to store phone numbers, password commands and passwords). To unlock the **&V** and **&Z** commands, enter the following command; substituting your password for SECURITY:

AT &Z1=/ASEcurity

The **&V** and **&Z** commands are accessible. To re-lock the **&V** and **&Z** commands, enter AT Z. The DTE responds with OK, and the **&V** or **&Z** commands will not function until they are unlocked.

3.Programming security callback operation. Use the commands **AT& Z** and **/P** to specify the callback phone number and password to be used. The following example programs memory location 3 for callback operation:

AT &Z3=T5551212/PVIOLET

The callback number in this example is 555-1212 (with **T** used to specify tone dialing); the password is VIOLET. A remote user can now call from the specified callback number, 555-1212. After the modems connect, the remote user presses the Enter key. The DTE prompts the user to enter the assigned password by displaying the **PASSWORD?** query. Upon receipt of the correct password, VIOLET, the local Modem calls back the remote user at 555-1212. Once this connection is established, data may pass freely.

NOTE

Callback numbers and passwords may be stored only in memory locations 2 through 9.

4.Programming pass-through operation. Use the commands **AT &Z** and **/P** to specify the password used for pass-through operation. The following example programs memory location 5 for pass-through operation:

AT &Z5=/PYELLOW

The password is YELLOW. The DTE prompts the user to enter the assigned password by displaying the **PASSWORD?** query. If the user enters the correct password, YELLOW, the call is connected.

NOTE

Passwords may be stored only in memory locations 2 through 9.

5. Programming a response to a correct password. Enter the following command, replacing CONNECTED with your message:

AT &Z0=/UNCONNECTED

The DTE responds with the specified message when the modem receives a correct password.

NOTE

The /U command and message can be stored only in memory location 0.

4.8 Modem-Controlled Remote Control

Certain modems can be used to remotely control other modems. Alternately, modems may be remotely controlled from a computer or other DTE. This section explains modem-controlled remote control. Remote control from a DTE is explained in **Section 4.9**.

Two types of modem-controlled remote control are possible:

- **Direct modem-to-modem control**—One modem can be used to control the front panel of another modem through a phone link.
- **Control through a rack controller**—A modem in a rack enclosure *equipped with an intelligent rack controller* can control:

Another modem in the same rack *or*

A remote modem connected to any modem in the rack.

For both types of remote control, the controlling modem and the controlled (remote) modem must be connected at a data rate that uses trellis coding. (This does not apply, however, if both modems are installed in the same rack and the rack is equipped with a rack controller.)

4.8.1 DIRECT MODEM-TO-MODEM REMOTE CONTROL

REMOTE screen 1 on the LCD allows you to use one Modem 34336 to control the front panel of another Modem 34336 via a phone link. (REMOTE screen 2 is discussed in **Section 4.8.2**.)

Control Procedure (Modem-to-Modem)

Enabling Modem-to-Modem Remote Control Mode

To remotely control a modem connected by a direct phone link, access REMOTE screen 1 (shown below).

REMOTE CONTROL	<1> TEST
-------------------	-------------

If you select CONTROL, you will be able to control the front panel of the remote modem from the front panel of the modem you are using. When you select CONTROL, you will see (on the LCD of the modem you are using) whatever is currently displayed on the LCD of the remote modem. The characters on the LCD will be displayed in lower case—this is to let you know you are actually looking at a “copy” of the LCD of the remote modem. Buttons pressed on the front panel of the controlling modem will affect the controlled modem (and not the controlling modem). When you are remotely controlling another modem, the LCD will not change as quickly as it normally does.

NOTE

While a Modem 34336 is being remotely controlled by another Modem 34336 or is remotely controlling another Modem 34336, its diagnostic port cannot be used for other purposes—commands from the diagnostic port will be ignored.

(You can also access two remote test options from REMOTE 1 screen by selecting TEST. These test options, remote digital loopback and remote digital loopback self test, are described in **Chapter 7**.)

Exiting from Remote Control Mode

To exit from remote control mode, press the ENT pushbutton five times in succession on the front panel of the controlling modem. (If the remote modem resets as a result of a configuration change, the local modem will appear to have no control. To remedy this situation, press the ENT button five times.)

4.8.2 REMOTE CONTROL THROUGH A RACK CONTROLLER

When installed in a rack enclosure equipped with an intelligent rack controller, the Modem 34336 can be used to control:

- Another modem in the same rack or
- A remote modem connected to any modem in the rack (address control mode only).

Remote control through a rack controller is an especially valuable capability for modem used in high-density 16-slot enclosures. The low-profile modems specially designed for these racks are manufactured without an LCD user interface or control pushbuttons. One way to access the low-profile modems to monitor, test, or configure them is by using the modem-control feature described below.

The controlling modem must be a Modem 34336 equipped with a front-panel LCD and pushbuttons. (Low-profile rackmount versions of these modems cannot be used as controlling modems because they do not have LCDs and pushbuttons.) The controlling Modem 34336 can control another Modem 34336.

Control Procedure (Using a Rack Controller)

Enabling Remote Control through a Rack Controller

The main screen used to control other modems through a rack controller is REMOTE screen 2 (shown below).

REMOTE	<2>
CONTROL	ADDR/C ADDR

This screen is used as follows:

1. Select address control or slot control—To control a modem in the same rack as the controlling modem, or to control a connected remote modem, you must first specify the address or slot number (location in the rack) of the modem you want to control. If you want to specify the modem by its address, select ADDR/C (address control) on the bottom line of REMOTE screen 2.

NOTE

Each modem must have a unique address.

If you want to specify the modem by its slot number, select SLOT/C. (For slot 16, use 00 or 16, whichever is displayed on your modem.) Press pushbutton 2 to toggle between ADDR/C and SLOT/C (slot control).

2. Enter the address or slot number—To enter the address or slot number of the modem to be controlled, press pushbutton 3. If ADDR/C is displayed on REMOTE screen 2, a screen showing ADDRESS: 000,000 on the top line will be displayed. If SLOT/C is displayed on REMOTE screen 2, a screen showing SLOT NUMBER: 01 on the top line will be displayed.

Enter the address or slot number as follows: Use the right and left arrow pushbuttons to go to the digit you want to change. Then use pushbutton 1 to decrease (DEC) a number or pushbutton 3 to increase (INC) it.

If SLOT/C is selected, only modems in the same rack as the controlling modem may be specified (slots 1–16). However, if ADDR/C is selected, you can specify any modem in the same rack with the controlling modem or a remote modem connected to any modem in that rack (**Figure 4-1**). The remote modem may be in a rack without a rack controller, or it may be a standalone modem.

When the address or slot number you want is shown, press ENT. The LCD will return to REMOTE screen 2.

3. Initiate control—After entering the address or slot number of the modem to be controlled, select CTRL from REMOTE screen 2. “CTRL” will flash on and off for about seven seconds until the connection to the specified modem is made. When the connection is made, all characters on the LCD of the *controlling modem* will be in lower case instead of capitals—this indicates that the screens displayed are for the controlled modem. Buttons pressed on the front panel of the controlling modem will affect the controlled modem (and not the controlling modem).

If the specified modem is not present or is not working, the LCD will display a “NO RESPONSE” message. If a rack controller is not installed on the rack enclosure or is not working, “CTRL” will continue to flash on and off indefinitely (until you exit from the address or slot control mode).

Exiting from Remote Control Mode

To exit from the address or slot control mode, press the ENT button five times in succession. (If the remote modem resets as a result of a configuration change, the local modem will appear to have no control. To remedy this situation, press the ENT button five times.)

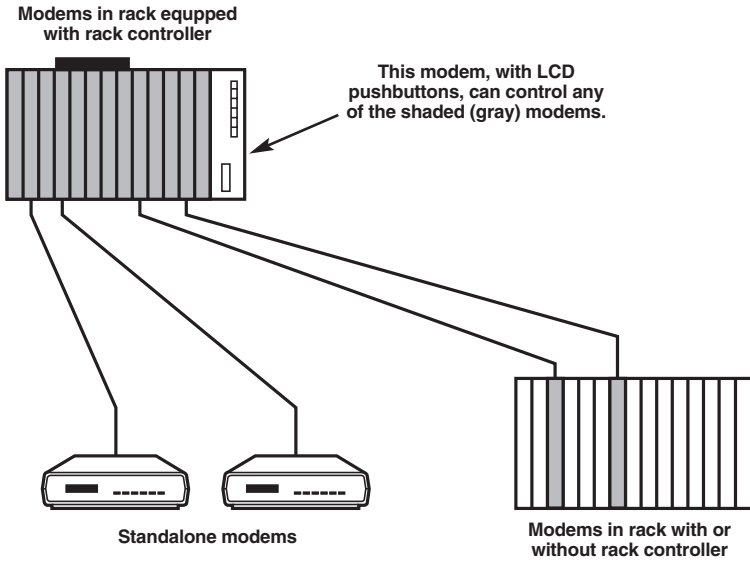

Figure 4-1. Remote control—address control mode.

4.9 Diagnostic Interface Control

The diagnostic software built into the Modem supports a special set of commands known as diagnostic port commands. The commands (listed in Table 4-3) are used to configure modems (from either a local or remote location), or to monitor modems for diagnostic purposes. The diagnostic port commands are entered from a computer or terminal keyboard.

NOTE

To configure or otherwise control a remote modem, the data rate must be 9600 bps or higher.

4.9.1 DIAGNOSTIC PORT

The Modem's diagnostic port is an 8-pin RJ-45 connector allowing you to test or configure the Modem from a connected computer or other DTE. The location of the diagnostic connector next to the power connector on the modem's rear panel is shown in Figure 2-1. The diagnostic connector requires a cable with an RJ-45 modular connector on one end (modem) and a DB25 connector on the other (terminal) end. The pin assignments of this connector are shown below.

Pin	Function
1	Constellation X output
2	Constellation Y output
3	Not used
4	Ground
5	Receive data (output from modem)
6	Transmit data (input to modem)
7	Not used
8	Not used

4.9.2 DIAGNOSTIC PORT COMMANDS

The diagnostic software built into the Modem supports the diagnostic port commands listed in Table 4-3. These commands are issued from a computer or other DTE, which must be connected to the modem's diagnostic port. To communicate with a modem via the diagnostic port, the DTE must be configured for 8-bit character length, no parity, 1 stop bit, and a data rate of 9600 bps.

Table 4-3. Diagnostic Port Commands.

COMMAND	FUNCTION
CONNECT g,u	Connect to diagnostic port of modem at group address g, unit address u. An address must be specified unless the wildcard character * is used: CONNECT * (meaning Connect to local modem; address unknown/unspecified.). When the connection is made, the DTE displays the modem's address. Echo, line feed, and Auto-Display are enabled.
CON g,u	CON performs same functions as CONNECT command, except that echo, line feed, and Auto-Display are disabled. The wild card character * may be used: CON * .
NOTE: The remaining commands listed in this table will function only if CONNECT or CON (with address or *) has been previously issued.	
D	Displays the current front-panel LCD screen of the connected modem on the DTE monitor.
E	Performs same function as front panel ENT button. (Exits from screen.)
1, 2, or 3	Performs same functions as corresponding buttons on front panel. (Selects choice 1, 2, or 3 from LCD.)
> or .	Performs same function as right arrow on the modem front panel. (Displays next menu screen.)
< or ,	Performs same function as left arrow on the modem front panel. (Displays previous menu screen.)
RESET	Resets the Modem without changing option settings. (Same as selecting RESET from the MAIN MENU.)
FRESET	Resets the Modem to factory defaults. (Reconfigures modem to Hayes mode default settings).

A carriage return [CR] is required at the end of a command line except when the command line consists of only one single-character command. Commands can be entered in upper or lower case.

Other diagnostic port commands are available for factory use only. Therefore, some commands that are not listed above may produce a response.

When an address is specified with the **CONNECT** or **CON** command, leading zeros are ignored, meaning that any of the following forms will work:

```
CONNECT 3,22  
CONNECT 003,022  
CON 000003,22
```

If a group or unit address is not specified, it is assumed to be zero: **CONNECT, 3** (same as **CONNECT 0,3**). Note that a comma is required, even if no group or unit number is used.

4.9.3 RESPONSES TO DIAGNOSTIC PORT COMMANDS

In response to the diagnostic port commands listed in Table 3-3, the Modem may display the responses listed in Table 4-4 on the DTE monitor.

Table 4-4. Responses To Diagnostic Port Commands.

RESPONSE	MEANING
ERROR	Command error (incomplete, wrong syntax, etc.). (If CONNECT or CON is issued without an address or *, the modems will not connect, and there will be no ERROR message.)
ADDRESS g,u	The Modem has connected with diagnostic port of modem at address g,u (group and unit). Address may be preceded by A, S, or both—see below.
A	One or more modem alarms has been detected. An alarm indicates a condition that may require attention (power loss, loss of carrier, etc.).
S	Valid statistics have been collected on a call or attempted call. Statistics include information such as call duration call, signal quality level, etc.
RESET	Response to RESET command. Prompt (>) appears when reset is complete.

4.9.4 DTE DISPLAYS

When Auto-Display is enabled, an update of the LCD is automatically displayed on the DTE screen each time a command (E, 1, 2, 3, left arrow, or right arrow) is entered to control the front-panel LCD on the connected modem. Auto-Display is enabled when the long-form connect command (CONNECT) is used.

Auto-Display is disabled when the CON command is used. However, even with Auto-Display disabled, the D command can be used to display the LCD screen.

The CONNECT command also enables echo and line feed on the DTE screen, whereas both are disabled when CON is used. Data from the connected modem is easier to read when CONNECT is used; however, data throughput is faster if CON is used.

On the Modem's front-panel LCD, a selected option flashes so it is easily identified as the current selection. When an LCD display is sent to the DTE in response to the CONNECT command, characters flashing on the LCD are indicated on the DTE screen by asterisks. An asterisk appears below each flashing character. In the example below, the selected CTS to EIA option is TRUE.

Actual LCD on connected modem:

```
CTS to EIA
NORM  RTS TRUE
```

DTE display:

```
CTS  to  EIA
NORM RTS  TRUE
****
```

Asterisks denoting flashing characters are also displayed if the D command is used to request a display of the LCD—provided the connect command last used was CONNECT and not CON. Even when the CON command is used (meaning the LCD of the connected modem is not automatically displayed), a computer reading data from the diagnostic port is able to determine which characters are flashing because bit 7 (MSB) is set in each flashing character.

4.9.5 DISCONNECTING FROM A DIAGNOSTIC LINK

There are two ways to disconnect from a modem-DTE diagnostic link:

- If you want to connect to another modem, issue the CONNECT command followed by the address of the modem to which you want to connect. The DTE disconnects from the first modem and immediately connects to the one you specified.

- If you want to disconnect from the diagnostic link without establishing a new link, issue the CONNECT command without an address.

4.10 Automatic Fallback

The Modem incorporates two automatic fallback features that are controlled by the user:

- **Operating Mode Fallback**—Provides compatibility with modems that use any of several different operating modes.
- **V.32 Speed Fallback**— Allows the Modem to automatically select the highest possible data rate, depending on the signal quality during handshake.

Both of the above fallback features function when the modem is in either manual or automatic originate mode, or manual or automatic answer mode.

4.10.1 OPERATING MODE FALLBACK

This section applies to dial-line operation only.

When the Modem originates or answers a call, it determines from the handshake routine with the other modem the most efficient operating mode that is supported by the other modem and automatically falls back to that mode. The Modem supports two alternatives for operating mode fallback: V.22 bis/Bell 212A/Bell 103 fallback operation (default setting) and V.22 bis/V.22/V.21/V.23 fallback operation. For communication within the United States, use the default setting for Operating Mode Fallback: V.22 bis/Bell 212A/Bell 103.

To configure the modem for V.22 bis/V.22/V.21/V.23 fallback operation, refer to **Appendix C**. Follow the instructions given there to change the value identified in the MISCELLANEOUS OPTIONS diagram (Appendix C) as the Operating Mode Fallback parameter from 0 (default setting) to 1.

Changing the Operating Mode Fallback parameter to 1 has the following effects:

- The Modem is configured for V.22 bis 2400 bps/V.22 1200 and 600 bps/V.21 300 bps/V.23 1200/75 bps fallback operation. As a result, 600 and 1200/75 bps appear as additional selections on the SPEED LIMIT LCD screens.
- Fallback to V.22 bis Bell 212A and Bell 103 compatibility is disabled.
- An AT command is available (in Hayes mode only) that allows control over operating mode as follows: F0—Multi-mode operation (default); F1—V.21, 300 bps; F2—V.22, 600 bps; F3—V.23, 1200/75 bps; F4—V.22, 1200 bps; F5—V.22 bis, 2400 bps; F6—V.32 (highest common speed). Except for multi-mode operation, the mode and speed are limited to the mode and speed specified. Multi-mode operation allows the modem to automatically fall back to the most efficient mode that can be used by both modems.

The preferred mode is V.32 (9600 or 4800 bps, asynchronous/ synchronous, full duplex); however, if the other modem does not support the V.32 standard, the Modem falls back to one of the modes listed below. The fallback modes are listed in the order in which they are attempted by the Modem in normal operation.

Table 4-5. V.22 bis/BELL 212A/BELL 103 FALLBACK (DEFAULT).

MODE	DESCRIPTION
V.22 bis	2400 bps asynchronous/synchronous
Bell 212A	1200 bps asynchronous/synchronous
Bell 103	0-300 bps asynchronous
All modes are full duplex.	

If V.22 bis/V.22/V.21/V.23 fallback operation is enabled, the following fallback modes are available. As in the previous list, the modes are listed in the order in which they are attempted by the Modem.

Table 4-6. V.22 bis/V.22/V.21/V.23 FALLBACK.

MODE	DESCRIPTION
V.22 bis	2400 bps asynchronous/ synchronous
V.22	1200 and 600 bps asynchronous/synchronous
V.21	300 bps asynchronous
V.23	1200/75 bps asynchronous
All modes are full duplex.	

The operating mode is controlled through the SPEED LIMIT screens on the LCD in all modes except Hayes mode. See **Chapter 3** for details.

4.10.2 V.32 SPEED FALLBACK

This feature applies only to V.32 mode operation. It functions only if enabled and the maximum speed is set (via the Speed Limit option) to the highest available speed—9600 bps for the Modem, 14,400 bps for the Modem.

When V.32 Speed Fallback is enabled, the Modem automatically selects the highest possible data rate, depending on the signal quality during handshake. The Modem automatically selects either 9600 bps or the fallback rate of 4800 bps. The Modem selects either 14,400 bps or the fallback rate of 12,000 bps. If the error rate is one error in 1000 bits or lower, the Modem connects at the highest available rate. If the error rate exceeds this threshold, the Modem connects at the fallback rate. Fallback may also occur during retrain sequences.

To configure the modem for automatic V.32 Speed Fallback, refer to **Appendix C**. Follow the instructions to change the value identified in the DATA PUMP OPTIONS diagram (**Appendix C**) as the V.32 Speed Fallback parameter from 1 (default setting) to 0.

Rate Renegotiation Procedure (RRP)

Rate Renegotiation Procedure (RRP) is a third type of automatic fallback; it can be controlled by the user.

Like V.32 Speed Fallback, RRP allows the Modem to automatically select the highest possible data rate, depending on the signal quality. Unlike Speed Fallback, RRP allows for data rate fallback *or* fallforward at any time during data transmission. *Retraining is not required.* RRP may be used with either dial-up lines or leased line operation.

If Rate Renegotiation Procedure (RRP) is enabled, the modem will automatically fall back *or* fall forward to a lower *or* higher data rate in response to changes in signal quality. This may happen at any time during data transmission, and it is done without a retraining procedure. Your data transmission is virtually uninterrupted.

Note that data-rate adjustments are limited:

- to the range of 4800 to 14,400 bps for the Modem (4800 to 9600 bps for the Modem 3242-S)
- by the minimum and maximum rate settings of the Speed Limit option.

If satisfactory performance cannot be attained at any of the available data rates, the Modem will initiate a GSTN cleardown (line disconnect). If the originate modem attempts to negotiate a rate that is lower than the minimum rate setting of the answer modem, the answer modem will initiate a GSTN cleardown.

How to Enable or Disable RRP

NOTE

RRP will function only if Speed Fallback is enabled (factory default) and if the V.32 Mode option is set to V.32 bis (factory default). Both functions are Summary Setup options.

The factory-default setting for RRP is enabled. To change the RRP option, refer to the DATA PUMP OPTIONS diagram in Appendix C. Change the Rate Renegotiation Procedure (RRP) parameter shown in the diagram to 0 (disable) or 1 (enable). This is the only way the RRP option can be changed.

Rate Change Screen

If V.32 bis mode and the Rate Renegotiation Procedure (RRP) option are both enabled, the Modem will automatically adjust during data transmission to a higher or lower data rate, depending on the receive signal quality. For diagnostic purposes, the RATE screen (accessed from screen 3 of the MAIN MENU, as illustrated below) may be used to manually initiate speed renegotiation from the front panel, as explained below.

NOTE

The RATE screen is only displayed if V.32 bis mode is enabled (via Summary Setup, V.32 Mode option).

If you select DOWN from the RATE screen, the Modem will fall back to the next-lower speed. If you select UP, the modem will fall forward to the next-higher speed if the signal quality is good enough. Remember, the data-speed range within which the Modem can fall forward or fall back is limited by the minimum and maximum rates set via the Speed Limit option.

After you select UP or DOWN, the LCD will automatically switch to the EIA status screen so you can see the result of the rate-change request (i.e., the current data rate, which is displayed in the lower left corner of the EIA status screen). However, if the Modem has reached the minimum or maximum speed, it will not switch to the EIA status screen.

NOTE

A request to increase the data rate may result in no change in the data rate if the signal quality is poor.

If you manually initiate speed renegotiation with RRP enabled, the modem will automatically renegotiate the speed (again) after four seconds. If the originate modem attempts to negotiate a rate that is lower than the minimum rate setting of the answer modem, the answer modem will disconnect (GSTN clear-down).

4.11 V.13 Operation

The Modem can be configured for CCITT V.13 operation (which emulates half-duplex operation) for either point-to-point or multidrop applications. (The correct options for these applications are identified in **Chapter 2**.) The Modem normally operates in full duplex; however, some applications (such as certain network environments) may require control of a remote CD signal by a local Request to Send (RTS) signal. V.13 operation allows local RTS control of a remote CD signal without actual ON-OFF switching of the modem carrier.

The following paragraph explains how the Modem responds to RTS signals when it is configured for V.13 operation.

When RTS is raised HIGH by the terminal, the V.13 ON PATTERN is sent. The Modem then raises CTS and data can be sent. When RTS is brought LOW, the V.13 IDLE PATTERN is sent, and the Modem drops CTS. (If V.13 TX is enabled but the Modem's data pump is not ready to send, i.e., if it is training or retraining, raising RTS causes CTS to be raised, but the V.13 ON PATTERN is not sent.) When V.13 RX is enabled, CD turns ON if the V.13 ON PATTERN is detected; CD turns OFF if the V.13 IDLE PATTERN is detected or if the Modem retrains, loses carrier, or is reset.

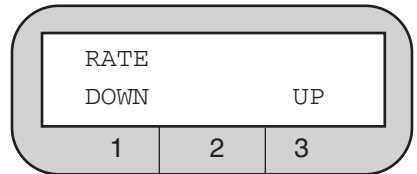
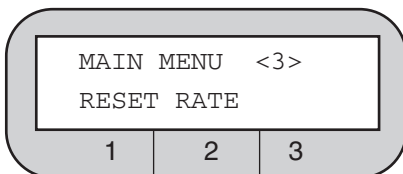

5.0 Hayes Emulation Mode

For easy reference, the following tables appear consecutively at the end of this chapter:

- Table 5-1. Hayes Compatible Commands
- Table 5-2. Hayes Mode Result Codes
- Table 5-3. S Register Functions

5.1 Hayes Mode Autodialer

When the Hayes emulation mode is enabled, the Modem emulates a Hayes autodialer and functions like a Hayes modem. Commands are issued from the computer keyboard (or other DTE), and the Modem is compatible with software written to drive a Hayes style AT command set.

5.1.1 ENABLING THE HAYES MODE AUTODIALER

You can enable the Hayes mode autodialer either by using the Quick Setup feature or by selecting HAYES from the DIALER screen:

- **Quick Setup.** If you use the Quick Setup feature to select 2-Wire Dial (Hayes), the Hayes mode autodialer is enabled, and all modem options are automatically set to a preset configuration suitable for typical Hayes mode applications. To select the 2-Wire Dial (Hayes) Quick Setup, access QUICK SETUP screen 1 on the LCD and press pushbutton 2.
- **Dialer Mode.** If you enable the Hayes mode autodialer using the Dialer Mode option, no other options are changed. Select DIALER from SETUP screen 2. Then, select HAYES from the DIALER screen.

5.1.2 COMMAND GUIDELINES

The following guidelines for using Hayes compatible AT commands also provide a summary of the fundamentals of Hayes mode autodialer operation.

Note that although carriage returns are not shown in the examples in this chapter, a carriage return is required at the end of each command line.

- **Escape Sequence (+++).** The escape sequence causes the modem to escape from the data transfer mode so it can interpret commands. (Alternate characters for the escape sequence can be assigned via S register S2.)
- **Attention Code.** AT, the attention code, must begin all command lines.

- **Command Sequence.** For dialing, a command line begins with AT, followed by a D and the phone number. Other commands should be placed before the dial command—or after the dial command if it is terminated with a semicolon. See the example below:

AT M2 V1 D 555-1212; S2=1O

The above command instructs the Modem to keep the speaker on (**M2**), send word result codes (**V1**), dial (**D**) 555-1212, end dial command, set register 2 to 1 (**S2=1**), and go on-line and wait for carrier (**O**).

Characters not in the command set are ignored during the dial command. Therefore, you can include punctuation or spaces in the telephone number for easier reading. See the example below:

AT DT 9,(212)555-1234 or

AT DT 9, 212 555 1234

- **A/ Command.** Repeats the commands included in the previous command line. Because the AT is also repeated, no AT is needed to begin this command, nor is a carriage return needed. A/ is useful for redialing a telephone number.
- **Backspace Key.** The backspace key deletes the last character entered (provided there is no intervening carriage return) and is used for simple editing.
- **Carriage Return [CR].** A carriage return is required at the end of a command line. The modem will not execute a command without it. A carriage return is sent from the DTE keyboard. A period, which may be entered via the modem's front panel (PHONE LCD screen), has the same function as a carriage return. (On most keyboards, the carriage return [CR] key is labeled Enter or Return.)

- **Dial Command Modifiers.** Several modifiers can be used with the basic D (dial) command to alter dialing operations. The modifiers are explained below.

Dial Command Modifiers:

L — Links a phone number to another number to be dialed as an alternate

P — Sets pulse-dialing mode

S=m — Dial number stored at memory location m

T — Sets tone-dialing mode

W or : (colon) — Wait for dial tone before proceeding

, (comma) — Pause for 2 seconds

; (**semicolon**) — Return to command state after dialing

@ — Wait for silence

! (**exclamation**) — Flash

With few exceptions, dial-command modifiers function only if they are used in a command line with the D command, or if they are included in a stored number. A carriage return or period must be used at the end of a dial string.

An example of a command line with two dial modifiers is shown below.

AT DT 9,555-1212

The modifier T instructs the modem to tone-dial. The comma instructs the modem to pause after dialing 9 before it dials the remaining digits.

- **Missing Parameter.** A missing parameter is interpreted as a zero. For example, the E command (echo) can be sent as either E0 or E1, but if an E alone is sent, the Modem interprets it as if an E0 was sent.
- **Command Buffer.** The command buffer holds a maximum of 40 characters. If the command line exceeds 40 characters, the modem refuses to execute any portion of the command line and sends an error message. The AT at the beginning of the command line, control characters, and spaces do not take up space in the command buffer. Punctuation (except for spaces) does take up space in the command buffer.

5.1.3 RESULT CODES

Result codes (see Table 5-2) are messages sent by the modem to the DTE monitor in response to your commands. Result code options are selected using the **V** and **X** commands, as explained below.

Result codes may be words (**V1** command) or digits (**V0**). Word codes are preceded and followed by a carriage-return, line-feed sequence. Digit codes are followed by a carriage return. The result codes and their meanings are summarized below:

Result codes 0-4 comprise the basic result code set: OK, CONNECT, RING, NO CARRIER, and ERROR. Codes 5-43 provide additional response information, as explained in Table 5-2. Various combinations of these codes can be enabled or disabled by using the **X** command and its four parameters.

5.1.4 TRANSMISSION SPEED

Transmission speed is governed by the speed of the system with which you wish to communicate. You must set the transmission speed of your computer by setting a switch in the hardware or by issuing a software command. (Refer to your computer documentation.) When the Modem originates a call, it automatically detects and adjusts to the transmission speed set when the communication port was initialized.

When answering a call, the Modem determines the transmission speed from the carrier signal of the originating modem. Change the setting of your equipment to match that of the remote system. Other-wise, unintelligible data appears on your screen. (Depending on the parameter used with the **X** command, the speed is indicated by the CONNECT response code.)

When a call is originated in Hayes mode, the AT attention code causes the Modem to autobaud and override any front-panel Speed Limit or DTE Speed settings. The speed at which the Modem autobauds defines the speed limit for subsequent connections. If the unit is not autobauded, the default interface rate is 38,400 bps.

5.2 Hayes Compatible Commands

All Hayes compatible commands that are used with the Modem are listed in Table 5-1 (near the end of the chapter). More detailed information is provided below for selected Hayes commands—particularly those used to answer and originate calls, and other commonly used commands. For Hayes commands that control modem options, additional information on options may be found in **Chapter 3**. Commands are listed in alphabetical order in this section and in Table 5-1.

For most commands, there are parameters—numerical values used with the command specifying the function of the command. For example, the command **L** controls the modem's speaker volume. **L2** sets the volume to medium. The default value is a predetermined value which is in effect the first time the Modem is powered up or when a reset command is given. The possible parameters and default value for each command are shown in Table 5-1.

- **A** — **Quick Answer**. The **A** command immediately puts the modem into the answer mode. The modem will not execute any command entered in the command line after **A**.

The **A** command is used to transfer a call between two individuals to a communication between their computers: One person enters **A** while the other enters **D**.

- **A/** — **Repeat Previous Command**. **A/** is most commonly used to redial a busy telephone number. The **AT** prefix is not used with **A/**, and no carriage return is required. Commands are available for repetition in the command buffer only until **AT** is entered or power to the unit is turned off. **A/** will not work following an **AT** or after the power has been turned off and back on.
- **D** — **Originate Mode For Dialing**. The modem dials the number that follows and attempts to go on-line. The dial command **D** is followed by either a telephone number to be dialed, or a string consisting of a phone number and dial command modifiers (e.g., **T**, **P**, and **;**). An example of the **D** command is shown below:

AT D3331234.

In response to the command above, the Modem dials the telephone number 333-1234, and then waits for a carrier tone from the remote modem (default wait time is 30 seconds). If the modem is able to establish a call, it gives a **CONNECT** result code, indicating that it is on-line. If it cannot connect, it issues a different result code, such as **NO CARRIER**, **BUSY**, or **NO DIALTONE**. The characters that can be dialed are 0 through 9, **A**, **B**, **C**, **D**, **#**, and *****.

- **AT D** — the dial command without a telephone number causes the modem to pick up the telephone line without dialing a number.
- **DS** — **Dial Stored Number**. The **DS** command instructs the Modem to dial a telephone number or dial string previously stored using the **&Z** command. The syntax is **DS=m**, with **m** specifying the memory location where the dialed number will be stored. Up to ten numbers may be stored in memory locations 0-9. **S=m** may be placed anywhere in the dial string; for example, **AT D2345S=2** dials 2345 and the number is stored in memory location **2**.

- **H — Telephone Switch Hook.** The **H** command (on-hook) is used to terminate a call. (On-hook corresponds to off-line.) **H** may also alternate between voice and data transmission during the same call (if your communication software supports this capability).

The **H1** command (off-hook) activates the telephone line relay, causing a dial tone to be sent after a 2-second delay. For most purposes the command is not necessary, since the switch hook is automatically activated when the Modem originates or answers a call.

- **L — Link.** The **L** dial modifier is used to link one phone number to another. One number can be an alternate number to be dialed if a connection is not made to the primary number. The **L** parameter must be used after a phone number, and before a carriage return or period. A number is used after **L** to specify the memory address (0-9) containing the number to be linked to the first number. See the command below.

AT D 555-1212 L5

NOTE

L may also be used in V.25 bis mode with the CRN command (instead of AT D), in both Dumb mode and 208 operation. In Dumb mode or 208 operation, L is stored via the PHONE screen. In all cases, L is used in the same way and has the same function as described above (except that AT D is not used).

Two or more addresses may be linked in a cyclic fashion to alternate dialing until a connection is established:

Contents of cell 0: 555-1212 L1
Contents of cell 1: 444-1234 L2
Contents of cell 2: 888-5555 L0

With the cells loaded as shown above, if the command **AT DS=0** is issued, the autodialer goes to cell 0 and dials the number stored there. If unable to connect, the **L1** command stored in cell 0 directs the autodialer to dial the number in cell 1. The **L2** stored in cell 1 directs the autodialer to cell 2 (assuming a connection cannot be made), and the **L0** command stored in cell 2 directs the autodialer back to cell 0. The numbers are dialed in a loop until a connection is established or until 10 calls are attempted.

- **O — Forced On-Line.** For asynchronous operation only. When the modem is on-line, you can return to the command state by entering the escape code (+++). After the desired command is executed, use the **O** command to force the modem from the command state to the on-line state.
- **P — Pulse Dial.** The **P** command instructs the modem to pulse dial. It can be entered anywhere in the dialing string: **AT P5551212**; or it can be entered alone, followed by a carriage return, **AT P**, in which case all subsequent telephone numbers are pulse dialed. If the dial command does not specify which dialing mode to use, the modem defaults to the last mode specified.
- **S= - Modify S Register.** This command is used to write information to a specified S register. The syntax is **Sr=n**, where r is the number of the register to be modified and n is the value to be written to it; for example:

AT S7=30

This command would change the value of register S7 to 30. If you enter just **=5**, the auto-dialer changes the value of the last register used to 5. More information on S registers is included in **Section 5.3**.

- **S? — Read S Register.** This command instructs the autodialer to read the contents of the specified S register. The syntax is **Sr?**, where r specifies the register to be read. For example, **S7?** reads the value of register S7. The value is displayed on the computer or terminal monitor. If you enter **?** by itself, the autodialer displays the value of the last register used; if **=** is entered by itself, the autodialer displays the number of the last register used (e.g., S2). For information on how to interpret S register values, see Table 5-3.
- **T — Tone Dialing.** This command causes a telephone number in the dial command string to be dialed using tone signals. (See the P command above for additional information.)
- **W — Wait For Dial Tone.** The **W** command (or colon) is used in a dial string to instruct the Modem to wait for a dial tone before proceeding. Adjust the wait time (default, 30 seconds) by changing the value in register S7. If no dial tone is detected within the specified time, the Modem hangs up and gives a NO DIALTONE result code (if the result code is enabled by the X command).

- **Z—Recall Stored User Profile.** The **Z** command resets the modem and recalls a profile of the modem configuration settings previously saved using the **&W** command. The profile is designated as profile 0 or profile 1 when it is saved using the **&W** command.
- **,—Pause.** A comma causes the modem to pause for 2 seconds (or time specified in register S8) before processing the next character in a dial string or command. The Pause command is used to place an outside call through a PBX switchboard, where 9 must be dialed to gain outside access—the pause allows time for the dial tone to occur before the modem dials the number:

AT D9,3331234

Similarly, a comma may be used to cause the Modem to wait for a second dial tone before beginning to dial a telephone number. Use multiple commas to increase the pause time.

- **;— Forced Command State.** A semicolon placed at the end of a dial command causes the Modem to return to the command state after dialing without disconnecting.

The following examples illustrate how the **;** command is used:

The first example is a banking transaction. The command **AT D333-1234;** dials the bank's phone number and returns the Modem to the command state. After the **OK** prompt is displayed on the DTE, the command **AT DT 0901#** is entered. The command transmits the identification number 0901 to the bank, and again returns the Modem to the command state. An account number and other data may be transmitted in the same way.

The second example illustrates one method of autodialing. Enter a dial string that ends with a semicolon—for example, **AT DT9, 3331234;** During the ring signal or when the call is answered, pick up the phone and enter **AT H**. You may then use a telephone connected to the Modem for voice communication.

- **Wait For Silence Before Dialing.** The **@** command is used to gain access to a system without a dial tone. It tells the modem to wait for 30 seconds (or the time specified by register S7) for one or more rings followed by 5 seconds of silence before processing the next symbol in the dial string.

- **!** — **Initiate Flash.** The **!** command causes the Modem to go on-hook for 1/2 second. The command has the same effect as holding the switch-hook button on your telephone down for 1/2 second. Some PBX systems use a flash to transfer calls.
- **&F** — **Recall Factory Configuration.** The **&F** command restores the Modem to its original factory configuration, using data stored in ROM. However, the change is not permanent. If the Modem is turned off or reset, the recalled configuration is replaced with the default stored profile. (See **&Y** command.)
- **&V** — **View Active Configuration, etc.** This command displays the active modem configuration, user profiles stored using the **&W** command, and phone numbers stored using the **&Z** command. When **&V** is invoked, the DTE displays the configuration commands last issued, including parameters used, and the values currently stored in the S registers. The **&V** command should be issued as the last command on a line.
- **&W** — **Write Profile To Memory.** The **&W** command saves the storable parameters of the Modem's active configuration by writing the configuration profile to non-volatile memory. By selecting either **&W0** or **&W1**, two different user profiles can be saved (profile 0 or 1). One of these profiles is automatically restored whenever the modem is powered on or when the **Z** command is issued. (See **&Y** and **Z** commands.)

The **&W** command cannot be used to write changes to the user profiles if the Modem's front panel is disabled with the Front Panel Control option.

The parameters listed below cannot be stored—all are set by changing S register values (as indicated in Table 5-3):

Backspace character (ASCII 08)

Carrier-detect response time

Carriage-return character (ASCII 13)

DTMF tone duration

DTR detection

Escape-sequence character (ASCII 43)

Escape-sequence guard time

Line-feed character (ASCII 10)

Lost-carrier-until-hangup time

Pause duration (effected by comma)

Ring count

Wait time before blind dialing

Wait time for carrier/dial tone

In addition, the **&W** command does not save stored phone numbers.

- **&Z — Store Telephone Number.** The **&Z** command is used to store a telephone number dialed using the **DS** (dial stored number) command. The syntax is **&Zm=n**, where **m** specifies the memory location in which the phone number or dial string is stored and **n** is the number or dial string to be stored. For example, **AT &Z5=T 1 (301) 555-1212** stores the specified number at memory location 5. Ten memory locations are available—0-9.

For pulse dialing, digits 0 through 9 can be stored. For tone dialing, 0 through 9, A through D, #, and * can be stored. The dial-command modifiers listed in **Section 5.1.2** can also be stored.

Each memory cell can hold a maximum of 25 digits. Cells 1 through 9 automatically expand to the next empty cell if loaded with more than 25 digits. Even if a stored number is continued to another cell, the maximum number of characters that can be stored is 36. If more than 36 characters are included in a dial string, the command is ignored. A cell cannot hold a number unless it is empty. Only cell 0 can be accessed from the Modem's front panel (via the PHONE LCD screen).

- **\S — View Status Of V.42-Related Configuration.** The **\S** command displays the active V.42 error correction configuration, stored V.42 profiles, and certain other data not displayed by the **&V** command.

5.3 S Registers

The Modem includes 28 registers (S0-S27) that are used to control specific modem operations in Hayes mode only. Each register holds a value serving as a specific operating instruction for the modem. Several of the S registers affect how the previously described commands are executed.

The functions of the registers intended for user access are explained below and summarized in Table 5-3.

5.3.1 READING AND SETTING REGISTERS

Use the S command to read the value of a register or to change its value.

To read the current value of a register, use the command **S?**, where the number of the register is specified between the S and the ?—for example, **S9?**. The decimal value of the register contents is displayed. You may read multiple registers. For example, if you wish to read the current value in registers S0 and S7, enter the following command.

AT S0? S7?

A typical response might be 001, 030, OK, meaning the values stored in registers S0 and S7 are 1 and 30, respectively.

To set or change a parameter, use the command **S=**, where the number of the register follows S and a value between 0 and 255 (the range of values that can be assigned to the registers) follows the equal sign:

AT S0=5

The above command changes the value stored in S0 to 5.

The S command can also be used without ? or = to point to a register that will be read from or written to without being specified. To illustrate this, if you enter the following command, a pointer is set to the address of register S7.

AT S7

As long as no other S command is entered, the register value can be requested at any time without specifying the number. If you enter **AT ?** the modem displays the current value in the S7 register. Similarly, if you enter **AT=8** the modem changes the value in the S7 register to 8.

5.3.2 S REGISTER FUNCTIONS

This section describes the function of each S register. Table 5-3 lists the range of possible parameters and the default value for each S register.

- **S0 — Ring To Answer On.** The value in this register determines on what ring (first, second, third, etc.) the modem answers. Setting S0 to 0 disables auto-answer.
- **S1 — Ring Count.** Register S1 counts the number of ring signals for each incoming call. If more than 8 seconds pass since the last ring, S1 is cleared to zero.
- **S2 — Escape-Code Character.** The escape code is effective for asynchronous operation only. Values greater than 127-completely disable escape code detection and prevent you from issuing a hang-up command.

- **S3 — Carriage Return.** Register S3 is effective for asynchronous operation only. Normally, the ASCII carriage-return value, 13, is used.
- **S4 — Line Feed.** This register is effective for asynchronous operation only. The line-feed character follows the carriage return only when word result codes are selected (command V1). Line feed can be changed to a null but cannot be totally disabled.
- **S5 — Backspace.** This register is effective for asynchronous operation only. The value in S5 defines the backspace character. Do not use values between 33 and 126.
- **S6 — Blind-Dialing Wait Time.** The value in S6 determines how long the Modem waits after picking up the telephone line (going off-hook) before beginning to dial. If S6 is set for less than 2 seconds, the modem waits 2 seconds before dialing. If the X2 or X4 command is in effect, dial-tone detection is enabled and blind dialing is disabled, meaning the value in S6 has no effect.
- **S7 — Carrier/Dial-Tone Wait Time.** This register controls two wait times—wait time for carrier and, if W is included in the dial string, wait time for dial tone (or wait time for silence if @ is used).
- **S8 — Pause Time.** Register S8 controls the pause time effected by a comma in a dial string or other command line.
- **S9 — Carrier Detect Response Time.** Register S9 determines how long a carrier tone must be present for the Modem to recognize the tone and indicate a carrier detect. (The time required for the absence of a carrier tone to be recognized is fixed at 0.5 seconds.)
- **S10 — Loss Of Carrier Delay.** The value in register S10 determines the length of the delay from the occurrence of a loss of carrier until the Modem hangs up the telephone line. A value of 255 disables the Modem's carrier disconnect option (and line-current disconnect option), meaning the Modem will not hang up in the absence of carrier or line current.
- **S11 — Tones.** This register sets the spacing of tones used for dialing. The rate is slowed by increasing the value of S11 to the maximum value, 255. This register has no effect on pulse dialing, which is fixed at 10 pulses per second.
- **S12 — Guard Time.** This register is effective for asynchronous operation only. The escape guard-time delay is required immediately before and after entering the escape code; therefore, the three escape-code characters must be entered within the guard time delay of each other. The unit for this register is 1/50 second (or 20 ms), meaning the default value of 50 equals 1 second.

If the guard time is zero, timing is not a factor. The three escape characters can occur with any timing relationship, but they must be consecutive. Be cautious when assigning small guard times. You may not be able to enter three characters fast enough, especially if the guard time is less than the time required to transmit one character at the current transmission rate.

- **S18 — Diagnostic Timer.** The value in register S18 determines how long a diagnostic test runs. For example, if S18 is set to 120, the test (activated by one of the &T commands) runs for 120 seconds. If S18 is set to zero (the default), the test timer is disabled and the test runs indefinitely. To terminate a test when the test timer is disabled, use the command &T0, or reset the modem. Register S18 is set to zero on powerup, or by the command AT Z or AT S18=0.
- **S25 — Delay To DTR.** The effect of the value stored in register S25 is dependent on the operating mode, as explained below.

Synchronous mode 1 — Before the Modem examines the state of DTR, a delay occurs after a call is established. The duration of the delay is the value specified in S25 (in seconds). This allows the operator time to disconnect the Modem from an asynchronous data terminal and attach it to a synchronous terminal without forcing the Modem back into the command state.

Asynchronous mode and synchronous modes 1 and 3 — A change in DTR (ON or OFF) lasting for less than the value in register S25 (in hundredths of a second) is ignored by the Modem.

- **S26 — RTS To CTS Delay Interval.** This register affects synchronous operation only. With the command &R0 in effect, CTS is turned on in response to an OFF-to-ON transition of RTS from the local DTE—after the delay specified by the value in register S26, but only if the Modem is on-line and ready to receive synchronous data.

5.4 Selecting Options In Hayes Mode

In Hayes mode, options may be selected by using one of the following:

- AT commands (Table 5-1)
- The front panel
- The Summary Setup feature

The easiest way to change options in Hayes mode is to use the AT commands listed in Table 5-1 or the Modem's front panel.

The following guidelines apply to option selection in Hayes mode:

- If an option is changed using an AT command, the change is effective for Hayes mode only, unless option changes are saved to memory.

If you change an option using an AT command, and then switch to a different mode without saving the change, the front panel display LCD remains unaffected.

- The effect of option changes made using the Summary Setup feature depends on which user profile (0 or 1) is active. See Section 5.4.1.

5.4.1 SAVING OPTION SELECTIONS

Changes made to option settings cease to be effective if power is removed from the Modem or if a factory reset occurs—unless the Modem's configuration is saved to nonvolatile memory. The storable parameters of the Modem's configuration can be saved to user profile 0 or 1 using the **&W** command (**&W0** or **&W1**). Upon powerup, the Modem recalls either profile 0 or profile 1, depending on which is designated as the default profile. (The **&Y** command is used to designate the default profile.) The Modem is shipped from the factory with profile 0 as the default profile.

As explained in the following sections, the Modem is programmed to treat profile 0 and profile 1 differently. It is recommended that you use profile 0 for your standard configuration and make it the default profile (**&Y0**). Profile 1 is intended for storing an alternate configuration if you need one (e.g., an alternate application). To view the contents of the user profiles, use the **&V** and **\S** commands.

5.4.2 PROFILE 0 AND PROFILE 1

User Profile 0 is linked to the Modem's front panel (i.e., selections made using the front panel LCD).

- If you make option changes using the front panel, the option changes for which there are associated Hayes commands are saved to profile 0 when you exit the SETUP menu.

- If profile 0 is recalled as the active configuration, the LCD screens reflect the profile 0 configuration.
- If profile 0 is changed by means of Hayes commands or via the Summary Setup feature and then saved, the changes made are reflected on the LCD and are effective for all modes.

If you make option changes from the front panel without exiting the SETUP menu, and then make option changes using Hayes commands and use the &W command to save them to profile 0, the changes saved to profile 0 override the front-panel selections.

User Profile 1 is not linked to the front panel.

- Option changes made from the front panel are not saved to profile 1. (Profile 1 can be changed only by using Hayes commands or the Summary Setup feature.)
- If profile 1 is recalled as the active configuration, the LCD screens are not affected. When profile 1 is active, it is possible for the LCD to display an option setting not reflecting the setting currently in effect.
- If profile 1 is changed by means of Hayes commands or via the Summary Setup feature, the changes are not reflected on the LCD and only affect Hayes mode operation.

If profile 1 is being used as the active configuration, the options marked with an asterisk (*) in Table 5-1 should be controlled either with the AT commands listed in Table 5-1 or using the Summary Setup feature described in **Appendix C**. When Profile 1 is active, these options can be changed via the front-panel LCD, but the changes are effective only for Hayes mode operation. However, if Profile 0 is subsequently recalled as the active configuration, the changes are effective at that time.

5.5 Hayes Mode Reference Tables

Table 5-1 lists the Hayes compatible commands used with the Modem.

Table 5-1. Hayes Compatible Commands.

COMMAND	FUNCTION/EXPLANATION
A	Quick Answer No parameters.
A/	Repeat Previous Command No parameters.
B B0 B1	Bell/CCITT Compatibility Mode * Selects CCITT V.22 mode. Selects Bell 212A mode.
C1	Modem displays OK; command has no other effect. This response instead of ERROR maintains a degree of compatibility with older modems supporting this command.
D	Originate Mode For Dialing No parameters.
DS	Dial Stored Number Parameters are 0-9 (available memory locations).
E E0 E1	Echo No echo. Echoes all characters back to terminal screen when using a full-duplex terminal and in local command mode.
F1	Modem displays OK. Command has no other effect unless V.22 bis/V.22/ V.21/V.23 fallback operation is enabled.
H H0 H1 or H2	Telephone Switch Hook On-hook (hang up). Off-hook.
<p>Default settings (where applicable) are in bold face.</p> <p>* If user profile 1 is active, options are controlled (for Hayes mode operation) by given commands or Summary Setup. Do not change via front panel (except via Summary Setup).</p>	

Table 5-1 (continued). Hayes Compatible Commands.

COMMAND	FUNCTION/EXPLANATION
I I0 I1	Product Code Or Checksum Requests product code. Requests checksum for the Modem's software. (Only a portion of the checksum displayed via the front panel is displayed in decimal format.)
I2 I3	Requests verification of software checksum. Requests the following for each EPROM (programmable memory unit): chip, part and revision number; checksum.
I4	Reserved.
L	Link Dial (L specifies LINK function when used as a dial command modifier.)
L L0 or L1 L2 L3	Speaker Volume * Low speaker volume. Medium volume. High volume.
M M0 M1 M2 M3	Speaker Control * Speaker always OFF. Speaker ON until carrier is detected. Speaker always ON. Speaker OFF during dialing; otherwise ON until carrier is detected.
O O0 O1	Forced On-Line Forces Modem to on-line state. Forces Modem to on-line state and initiates equalizer retrain.
P	Pulse Dial No parameters, but the default is T (for tone dial).
Q Q0 Q1 Q2	Send Result Code Send result codes. Withhold result codes (quiet). Withhold result codes for incoming calls only (quiet answer).

Table 5-1 (continued). Hayes Compatible Commands.

COMMAND	FUNCTION/EXPLANATION
S=	Modify S Register Parameters are register and value to be written.
S?	Read S Register Parameter is the register number.
T	Tone Dialing No parameters.
V V0 V1	Word/Digit Result Code Result codes are transmitted as digits. Result codes are transmitted as words.
W	Wait For Dial Tone No parameters, but default wait time (register S7) is 30 seconds.
X X0 X1 X2 X3 X4	Select Result Code Selects basic result codes, 0-4. No speed indication; no busy or dial tone detect. Selects result codes 0-5, 10, 11, 13, 14, 15, and 18. Connection speed (up to 14,400 bps) indicated; no busy or dial tone detect. Selects result codes 0-6, 10, 11, 13, 14, 15, and 18. Same as X1 except dial tone detect is enabled. Selects result codes 0-5, 7, 10, 11, 13, 14, 15, and 18. Same as X1 except busy-signal detect is enabled. Selects all result codes. Connection speed (up to 14,400 bps) indicated; busy-signal and dial-tone detect enabled. Note: Result code 8 is independent of the X command; it is displayed only when the @ dial modifier is used.

Default settings (where applicable) are in **bold face**.

* If user profile 1 is active, options are controlled (for Hayes mode operation) by given commands or Summary Setup. Do not change via front panel (except via Summary Setup).

Table 5-1 (continued). Hayes Compatible Commands.

COMMAND	FUNCTION/EXPLANATION
Y Y0 Y1	Long-Space Disconnect* Disables long-space disconnect. Enables long-space disconnect.
Z Z0 Z1	Recall Stored User Profile Resets modem and recalls stored user profile 0. Resets modem and recalls stored user profile 1.
, (comma)	Pause — No parameters, but default pause time (in register S8) is two seconds.
; (semicolon)	Forced Command State No parameters.
@	Wait For Silence Before Dialing — No parameters, but default wait time (register S7) is 30 seconds.
! (exclamation)	Initiate Flash No parameters
&C &C0 &C1 &C2	Data Carrier Detect Control * DCD always ON when DTR is present. DCD ON only in the presence of suitable data. DCD ON when DTR is present; then toggles off for 50 ms upon disconnect.
&D &D0 &D2 &D3	Data Terminal Ready Control * Ignore DTR. Go on-hook, assume command state and disable auto-answer upon DTR ON-to-OFF. Reinitialize in the event of DTR ON-to-OFF.
&F	Recall Factory Configuration No parameters.
&G &G0 &G1 &G2	Guard Tone Control * Guard tone disabled. Enables 550 Hz guard tone. Enables 1800 Hz guard tone.

Table 5-1 (continued). Hayes Compatible Commands.

COMMAND	FUNCTION/EXPLANATION
&J	Modem displays OK result code; command has no other effect. (The Modem is configured for A/A1 control or MI/MIC control via jumpers JP2 and JP3, as detailed in Appendix D.)
&L	Modem displays OK result code; command has no other effect. (The Modem is configured for leased line or dialup line operation via the front-panel QUICK SETUP and/or LINE TYPE screens.)
&M	Can be substituted for &Q.
&P	Modem displays OK result code; command has no other effect. (The pulse-dialing ratio is factory-set, depending on whether the modem is a U.S. or international model.)
&Q &Q0 &Q1 &Q2	<p>Asynchronous/Synchronous Mode Asynchronous mode. Synchronous mode 1— Synchronous/asynchronous mode Synchronous mode 2—OFF-to-ON DTR causes Modem to automatically dial a stored number.</p>
&R &R0 &R1 &R2	<p>RTS And CTS Options * CTS follows RTS. CTS follows DTR from the DTE. CTS is on while the modem is on-line.</p>
&S &S0 &S1 &S2	<p>Data Set Ready Control * DSR always on. DSR operates according to RS-232 specification. Options DSR operation for a crossover connection.</p>
<p>Default settings (where applicable) are in bold face.</p> <p>* If user profile 1 is active, options are controlled (for Hayes mode operation) by given commands or Summary Setup. Do not change via front panel (except via Summary Setup).</p>	

Table 5-1 (continued). Hayes Compatible Commands.

COMMAND	FUNCTION/EXPLANATION
&T &T0	Test Commands Terminates a test in progress. &T0 must be the last command in a command line.
&T1	Initiates a local analog loopback test.
&T3	Initiates a local digital loopback test.
&T4	Allows the local modem to accept a request from the remote modem for a remote digital loopback test.
&T5	Prevents the Modem from accepting a request from the remote modem for a remote digital loopback test.
&T6	Initiates a remote digital loopback test.
&T7	Initiates a remote digital loopback test self-test.
&T8	Initiates a local analog loopback self-test.
&V &V0	View Active Configuration, etc. Displays modem configuration, user profiles and phone numbers stored in memory cells 0-5.
&V1	Displays all stored phone numbers (contents of memory cells 0-9).
&W &W0	Write Profile To Memory Saves storable configuration parameters as user profile 0.
&W1	Saves storable configuration parameters as user profile 1.
&X &X0	Transmitter Clocking * Selects internal clocking.
&X1	Selects external clocking.
&X2	Selects receive mode (slaved) clocking.
&Y &Y0	Default User Profile Stored user profile 0 will be recalled on powerup.
&Y1	Stored user profile 1 will be recalled on powerup.
Default settings (where applicable) are in bold face .	
* If user profile 1 is active, options are controlled (for Hayes mode operation) by given commands or Summary Setup. Do not change via front panel (except via Summary Setup).	

Table 5-1 (continued). Hayes Compatible Commands.

COMMAND	FUNCTION/EXPLANATION
&Z	Store Telephone Number Parameters are 0-9 (available memory locations).
B \B0 \B1	Buffer Mode/Speed Conversion * 1 Disables speed conversion. Enables speed conversion. <\$!B10>
\C \C1 \C2 \C3 \C4 \C5	MNP Class (Limit) * 1 Limits operation to MNP class 1. Limits operation to MNP classes 1 and 2 Limits operation to MNP classes 1 through 3. Limits operation to MNP classes 1 through 4. Limits operation to MNP classes 1 through 5.
\D \D0 \D1	Dialing Message Disables DIALING message. Enables DIALING message.
\F \F0 \F1	MNP Flyback Buffer * 1 Enables flyback buffer. Disables flyback buffer.
\K \K0 \K1 \K2 \K3	V.42 Break Handling * 1 Selects normal break handling. Selects destructive/expedited break handling. Selects non-destructive/expedited break handling. Selects non-destructive/ non-expedited break handling.
M \M0 \M1	V.42 bis Operation * 1 Enables V.42 bis operation (error correction with data compression). Disables V.42 bis operation.

¹Option can be changed only when Modem is off-line.

Default settings (where applicable) are in **bold face**.

* If user profile 1 is active, options are controlled (for Hayes mode operation) by given commands or Summary Setup. Do not change via front panel (except via Summary Setup).

Table 5-1(continued). Hayes Compatible Commands.

COMMAND	FUNCTION/EXPLANATION
\N \N0 \N1 \N2 \N3	V.42 Mode * 1 Disables error correction. Enables mandatory mode for error correction. Disables error correction. Enables automatic mode for error correction.
\P \P0 \P1 \P2	V.42 Protocol * 1 Selects LAPM protocol only. Selects MNP protocol only. Selects LAPM/MNP protocol (MNP as alternate).
\Q 0 1 2 3	V.42 Flow Control * 1 Two parameters may be used (e.g., \Q0,1; \Q3,2 , etc.). First parameter specifies DCE-DTE flow; second (optional) specifies DTE-DCE flow control. None (no flow control). CTS on/off or RTS on/off (CTS for DCE-DTE flow control, RTS for DTE-DCE). DC1/DC2 flow control. DC1/DC3 flow control (default for DCE-DTE and DTE-DCE).
\S	View Status Of V.42-Related Configuration No parameters.
\T \T0 \Tn	Load Inactivity Timer Disables inactivity timer. Sets inactivity timer to n minutes (where n = 0 to 60).
\V \V0 \V1	V.42 Result Codes 1 Activates regular V.42 result codes. Activates extended V.42 result codes.
\X \X0 \X1	V.42 Pass-Through Flow Control * 1 Enables pass-through flow control. Disables pass-through flow control.
NOTE: DTE speed and parity are set automatically. Auto-answer is enabled or disabled by S register S0. 1Option can be changed only when Modem is off-line.Default settings (where applicable) are in bold face . * If user profile 1 is active, options are controlled (for Hayes mode operation) by given commands or Summary Setup. Do not change via front panel (except via Summary Setup).	

Table 5-2. Hayes Mode Result Codes.

DIGIT CODE	WORD	CODE MEANING
0	OK	Command line executed without errors.
1	CONNECT	Carrier detected at 0-300, 1200, or 2400 bps (basic code set).
2	RING	Ring signal detected (in answer mode). (When the Modem detects a ring, it sends a RING result code unless it is in the process of accepting a command. However, the Modem answers the call only if it is set for automatic answer or is given an A command.)
3	NO CARRIER	Carrier lost or never detected.
4	ERROR	Error in command line, invalid command, command line exceeds 40 characters, or invalid character format.
5	CONNECT 1200	Carrier detected at 1200 bps.
6	NO DIALTONE	No dial tone detected.
7	BUSY	Busy signal detected.
8	NO ANSWER	No period of silence detected. This code appears only if @ (wait for silence before dialing) is included in the dial string.
10	CONNECT 2400	Carrier detected at 2400 bps.
11	CONNECT 1275	Modem is on-line in V.23 mode (1200/75 bps).
13	CONNECT 12.0	Carrier detected at 12,000 bps.
14	CONNECT 14.4	Carrier detected at 14,400 bps.

Table 5-2 (continued). Hayes Mode Result Codes.

DIGIT CODE	WORD	CODE MEANING
15	CONNECT 4800	Carrier detected at 4800 bps.
18	CONNECT 9600	Carrier detected at 9600 bps.
20	LINKING	Modem is dialing numbers that are linked using the L (link) dial modifier.
<p>Note: Four additional word codes are BUFFER, MNP, V42, and V42 bis, followed by the DTE interface speed. These codes indicate if the Modem is in buffer, MNP or LAPM (V.42/V.42 bis) mode. The corresponding digit codes and speeds they indicate are listed below (with all speeds in bits per second):</p> <p>BUFFER: 28=19200, 29=9600, 30=4800, 31=2400, 32=1200, 33=600, 34=300, 35 =110, 53=38400</p> <p>MNP: 36=19200, 37=9600, 38=4800, 39=2400, 40=1200, 41=600, 42=300, 43 =110, 54=38400</p> <p>V42: 44=19200, 45=9600, 46=4800, 47=2400, 48 =1200, 49=600, 50=300, 51=110, 52=38400</p> <p>V42 bis: 55=38400, 56=19200, 57=9600, 58=4800, 59=2400, 60=1200, 61=600, 62=300, 63=110</p>		

Table 5-3. S Register Functions.
(Only registers intended for user access are listed.)

REGISTER	RANGE	UNITS	DEFAULT	DESCRIPTION
S0	0-255	rings	1	Ring to answer on
S1	0-255	rings	0	Counts number of rings
S2	0-127	ASCII	43	Escape-code character
S3	0-127	ASCII	13	Carriage-return character
S4	0-127	ASCII	10	Line-feed character
S5	0-127	ASCII	8	Backspace character
S6	2-255	sec	2	Wait time before blind dialing
S7	1-60	sec	30	Wait time for carrier or dial tone
S8	0-255	sec	2	Pause time for comma
S9	1-255	1/10 sec	6	Carrier-detect response time
S10	1-255	1/10 sec	14	Delay time between loss of carrier and hang-up
S11	70-255	ms	70	Tone spacing
S12	0-255	1/50 sec	50	Escape code guard time
S18	0-255	sec	0	Test timer
S25	0-255	sec or 1/100 sec	5	Delay to DTR ¹
S26	0-255	1/100 sec	0	RTS-to-CTS delay (half duplex)
¹ Depends on mode; see previous section, S25 - DELAY TO DTR.				

6.0 V.25 bis Autodialer

For international compatibility, the Modem can function as a V.25 bis autodialer. In V.25 bis mode, the Modem is compliant with CCITT recommendation V.25 bis—an internationally recognized standard for serial automatic call origination and answering.

The V.25 bis autodialer uses the dialing command set defined by the V.25 bis recommendation. You can store and dial phone numbers from the DTE in both synchronous and asynchronous applications. You can dial numbers directly, or you can instruct the Modem to automatically dial a previously stored number.

6.1 Enabling The V.25 bis Autodialer

The V.25 bis autodialer can be enabled by either using the Quick Setup feature, or selecting one of the Dialer Mode options.

QUICK SETUP

Three Quick Setup configurations are available for 2-Wire Dial (V.25 bis). Selecting any of the three V.25 bis Quick Setups (via QUICK on SETUP screen 1) enables the V.25 bis autodialer and causes all modem options to be automatically set to a preset configuration. Each V.25 bis Quick Setup is suitable for a typical V.25 bis application, depending on the DTE to be used. To select a 2-Wire Dial (V.25 bis) Quick Setup, access QUICK SETUP screen 2, 3, or 4 (for asynchronous; synchronous, character-oriented; or synchronous, bit-oriented operation) on the LCD, and then press push-button 2. After selecting the desired V.25 bis Quick Setup configuration, you can reset individual options to suit your application (see **Chapter 2**).

In accordance with the CCITT V.25 bis recommendation, the Modem V.25 bis asynchronous Quick Setup sets the character length to 10 bits, including 1 even parity bit. Both V.25 bis synchronous Quick Setups set the modem for odd parity. (For synchronous operation, the character length option setting has no effect.)

DIALER MODE (DIAL V25BIS SCREEN)

If you enable the V.25 bis autodialer using the Dialer Mode option, no other options are changed. Select DIALER from SETUP screen 2. Then, press the right arrow pushbutton to go to the DIAL V25 bis screen (screen 2). Select the V.25 bis data protocol appropriate for the DTE to be used: asynchronous (Asyn); synchronous, character-oriented (Syn_c); or synchronous, bit-oriented (Syn_b).

DTR DIALING IN V.25 BIS MODE

An alternative to using the V.25bis CRS command to dial a stored number is to use the DTR dialing option. With DTR dialing enabled, the autodialer will dial the number stored in the phone cell displayed in the front-panel AUTO-DIAL screen when DTR goes high for at least 50 ms.

To enable V.25 bis DTR dialing, use the Summary Setup feature (see **Appendix C**) to change the parameter for V25 bis DTR dialing to 1. Do not select DTR dialing via the front panel DIALER screen; this will not enable DTR dialing for V.25 bis mode. V.25 bis DTR dialing will function only if the V25bis DTR dialing parameter is enabled (set to 1) and the V.25 bis autodialer is enabled.

6.2 V.25 bis Autodialer Commands

In asynchronous applications, V.25 bis commands are issued directly from the DTE keyboard or through communications software. In synchronous applications, the V.25 bis commands are used to facilitate computer-controlled communications.

Punctuation and spaces may be used with V.25 bis commands for clarity, but they are not required. If used, they are ignored by the modem. One exception is the colon (:), which instructs the autodialer to wait for a dial tone.

The V.25 bis commands are described below and are summarized in Table 6-1. See Table 6-3 for explanation of the codes displayed in response to commands.

- **CIC — Connect Incoming Call.** The CIC command instructs the autodialer to answer incoming calls. The effect is the same as enabling auto-answer on the modem's front panel.
- **CRN — Call Request, Number Provided (Syntax: CRN 5557979).** By using the CRN command, you can dial a number directly from the DTE keyboard. Numbers from 0 through 9 can be dialed, and if tone dialing is enabled, the characters A, B, C, D, #, and * can also be dialed.

The dialing parameters listed in Table 6-2 are used with the CRN command to specify how or when a number should be dialed. For example, the command line **CRN :T3331234** instructs the autodialer to wait for a dial tone (:) and then tone-dial (T) the number 333-1234.

- **CRS — Call Request, Address Provided (Syntax: CRS 2).** The CRS command allows you to dial a number simply by specifying its memory address. In the example given above, the autodialer dials the number stored in memory address 2. Store the number at the specified address using the PRN command (Table 6-1).

- **DIC — Disregard Incoming Call.** The DIC command instructs the autodialer not to answer an incoming call. The DIC command is cancelled when the CIC command is issued or auto-answer is enabled from the front panel.
- **PRN — Program Normal (Store Number)**
(Syntax: PRN<|>1;<|>5551212). The PRN command is used to store a number or dial string in a memory address location (cell) so it can be dialed later by specifying only the address. As shown above, PRN is followed by the memory location, a semicolon, and the phone number to be stored. After a number is stored, it can be dialed using the CRS command. You can store any of the characters listed in Table 6-2.

Ten memory cells (0-9) are available for phone number storage. Each cell can hold a maximum of 25 characters, although cells 1 through 9 automatically expand to the next empty cell if loaded with more than 25 digits. Even if a stored number is continued to another cell, the maximum number of characters that can be stored is 36. You cannot store a number in a cell unless it is empty. To clear a cell, enter PRN and the address, without a number. Only cell 0 can be accessed from the modem's front panel (via the PHONE LCD screen).

- **RLN — Request Stored Number(s).** RLN is used to request a list of all stored numbers or to show the number stored in a specific memory address. RLN, used alone, requests a list of all stored numbers. The DTE display shows the stored numbers as follows:

```
LSN 0;    301 555 1234
LSN 1;    301 123 4567
LSN 2;    301 555 5555
```

(and so on through memory address 9)

If a memory address is specified after RLN, e.g., RLN 5, the DTE display shows only the number stored at the specified address.

Table 6-1. V.25 bis Autodialer Commands.

COMMAND	FUNCTION
CIC	Connect incoming call.
CRN n	Call request—dial number (n) entered on DTE keyboard.
CRS m	Call request—dial number stored in specified memory address (m).
DIC	Disregard incoming call.
PRN m n	Program normal—store number or dial string n in memory address m.
RHA	Switch to Hayes dialing mode (also resets modem configuration).
RLN	Request list of all stored numbers.
RLN m	Request to see number stored at address m.

n — represents a number to be dialed or stored (e.g., 5557979).

m — represents a memory address where a number is stored (0-9).

A comma (,) can be included in a dial string to effect a pause.

A colon (:) can be included to instruct the autodialer to wait for a dial tone before proceeding.

Table 6-2. V.25 bis Dialing Parameters.*(Table also applies to Dumb mode and Bell 208 operation)*

Characters that can be dialed:	0—9
Can only be tone dialed:	A, B, C, D, #, and *
L	Links a phone number to another number to be dialed as an alternate when the primary number is busy or does not answer. See L - LINK in Section 5.2 .
P	Sets pulse-dialing mode.
T	Sets tone-dialing mode.
W or : (colon)	Wait 30 seconds for dial tone before proceeding.
[CR] or . (carriage return or period)	Required at end of dial command line. [CR] is sent from DTE keyboard. Dumb/208 mode only: Period has same function, but may be entered via front panel (PHONE LCD screen).
, (comma) or <	Pause before processing next character in dial string.
L, P, T, and W may be entered as upper- or lower-case letters. Spaces or hyphens (-) may be used as separators for clarity; they have no effect.	

6.3 Dialing Parameters

Table 6-2 lists dialing parameters you can use with the CRN command to modify dialing operations.

6.4 V.25 bis Result Codes

Table 6-3 explains the result codes, or responses, that are displayed on the DTE monitor during V.25 bis operation.

6.5 DTR Dialing In V.25 bis Mode

An alternative to using the CRS command to dial a stored number is to use the DTR dialing option. With DTR dialing enabled, the autodialer dials the number stored in memory address 0 when DTR goes high for at least 50 ms.

To enable V.25 bis DTR dialing, use the Summary Setup feature (as described in **Appendix C**) to change the parameter for V.25 bis DTR dialing to 0. Do not select DTR dialing via the front-panel DIALER screen; it does not enable DTR dialing for V.25 bis mode.

Table 6-3. V.25 bis Result Codes.

CODE	MEANING
CFI AB	Call failure; absence of carrier.
CFI ET	Call failure because of busy signal.
CFI NS	Call failure; call request specified an address that does not contain a stored number.
CFI NT	Call failure; no answer tone detected.
INC	Incoming call.
INV	Invalid command entry.
LSN	List of stored numbers; is followed by memory address, stored number, next memory address, next stored number, etc.
VAL	Command accepted; waiting for next command.
A semicolon may be used to separate parameters, e.g., LSN 4;5559797.	

7.0 Diagnostics

The troubleshooting information in this chapter applies to all Modem applications (all dialup and leased line modes), unless specifically stated otherwise.

For specific test procedures, turn to one of the following sections in this chapter:

- **Section 7.7** — Local Modem Diagnostics
- **Section 7.8** — Remote Diagnostics

7.1 When And Why To Test

If you experience communications difficulties, you should try to isolate the defective component in your communications system. You must first identify the symptoms and scope of the problem. Then, perform a physical inspection of all units and connections in the system. Finally, conduct diagnostic tests. Very often the diagnostic testing capabilities of the Modem help identify the specific faulty component, whether it is the modem, the DTE, or the telephone line.

7.2 Symptoms and Scope of The Problem

To isolate the problem, carefully consider each of the following questions:

- When did the problem begin?
- What is malfunctioning? Try to isolate the component or components of your system that are malfunctioning.
- Has there been a recent change in the system?
- Has the modem been reconfigured?

You can quickly find out if the modem is reconfigured by checking the checksum shown in the SUMMARY screen (accessed via SETUP screen 6) and comparing it with the checksum displayed when the modem was operating properly. If the checksum is different from the original, one or more option settings are changed. If you previously recorded the number strings (i.e., option parameters) displayed in the setups screens, you can determine which option settings are changed (by comparing the previous and current option parameters).

7.3 Physical Inspection

The next step in isolating a defective component is inspecting the system. If you can trace the problem to a specific site, examine that site. Check the installation of the modem and DTE. Are all cables in good condition and fully connected? Are all components in the system receiving power? Inspect the system as thoroughly as possible.

7.4 Overview Of Modem Diagnostics

Once you identify the symptoms and conduct a physical inspection of the sites in question, you can use diagnostic monitoring and testing to further isolate the problem. The Modem is equipped with diagnostic capabilities enabling you to locate faults quickly and easily. The diagnostic features of the Modem fall into two categories — local and remote — as listed below. There are six types of local modem diagnostics:

- Analog loopback (ALB)
- Analog loopback self-test (ALBST, or ST)
- Analog loopback self-test with errors (ST/E)
- External analog loopback (ALBX)
- External analog loopback self-test (ALXST)
- Digital loopback (DLB)

There are two types of remote diagnostics:

- Remote digital loopback (RDL)
- Remote digital loopback self-test (RDLST)

The sequence in which you should conduct diagnostic tests depends upon the symptoms you identified, the availability of personnel at the remote site, and external test equipment. The self-test pattern generator and pattern detector built into the Modem alleviate the requirement for external test equipment. With the non-self tests, use either a standard DTE or an external bit error rate test (BERT) to generate test data and compare it with received data.

Because more transmission errors occur at higher speeds on marginal transmission facilities, begin testing at the highest available speed. If errors occur, reduce the speed and try again. If you cannot correct the problem, contact your supplier.

7.5 How to Select and Activate Tests

7.5.1 FRONT-PANEL CONTROL

Tests are accessed and activated in the same way options are selected: by using the LCD and front panel pushbuttons (as explained in Chapter 3). To find the LCD screen for a specific test, refer to the LCD flow chart (Diagnostic And Control Functions) at the end of this manual. Once you access the screen for a specific test, press pushbutton 1 to begin the test (select ON). A test status screen is automatically displayed. To deactivate a test, press the ENT pushbutton and then pushbutton 3. (The ENT button cannot be used to exit the text screen until the test is deactivated.)

NOTE

For valid test results, error correction must be disabled before diagnostic tests are run. To disable error correction, set the V.42 Mode option to OFF.

7.5.2 RUNNING TESTS IN HAYES MODE

In Hayes emulation mode only, most of the diagnostic tests available on the Modem can be activated via the DTE keyboard using the **&T** commands listed in Chapter 5. To set the duration of a test, assign a value to register S18. For example, **AT S18=30** sets the test time to 30 seconds. The command **&TO** terminates a test. For further information, see **Section 5.2**.

7.5.3 REMOTE TEST CONTROL

You can configure the Modem to ignore or accept requests from remote modems to initiate tests on your Modem. To access the remote-test control option, select TEST from SETUP screen 4. Then, select RMT from the TEST OPTIONS screen. From the REMOTE TEST screen, select ENABLE to allow remote test initiation or DISABLE to refuse remote test requests.

7.6 Diagnostic Monitoring: Status Screens

To obtain additional information about the status of the communications system, observe the status screens described in the following sections. To view these screens, push the ENT button until the EIA status screen appears. Use the right arrow pushbutton to advance to other status screens.

7.6.1 EIA STATUS SCREEN

The EIA status screen indicates the operational status of the modem and the condition of certain EIA RS-232 leads. The abbreviations that appear are identified below; however, only a few of these abbreviations are displayed during actual operation.

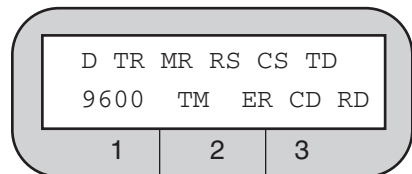

D = Dial line occupied

R = Ringing (R appears in same position as D.)

S = Connection secured by security handshake (S appears in same position as D. S and D may flash alternately.)

TR = Data Terminal Ready

MR = Data Set Ready

RS = Request to Send

CS = Clear to Send

TD = Transmit Data

9600, 4800, etc. = Data speed

(idle—the Modem is off-line—or H-01, H-14, etc., may also be displayed in the data speed position; see following text.)

TM = Test mode

ER = Error (poor signal quality)

CD = Carrier Detect

RD = Receive Data

When two modems establish a connection, they engage in an exchange known as a handshake. While a handshake is taking place, the Modem displays several codes ranging from H-01 to H-28 in the lower left corner of the EIA status screen. A handshake lasts for up to 12 seconds and is accompanied by various audible tones.

By pressing pushbutton 1 while the EIA status screen is displayed, you can access two checksum screens, one for the Modem's main circuit board and one for the data pump. The checksums provide data intended for use by servicing personnel. The checksum screens also show the software revision levels (which are also shown on the power-on screen).

7.6.2 OTHER STATUS SCREENS

- **Quality Screen.** Displays the quality of the received signal carrier as a numeric value and as a horizontal bar graph. A low numeric value indicates good signal quality. The best possible signal quality is indicated when the bar graph extends all the way to the right edge of the LCD.
- **Line Levels Screen.** Shows the preset level of the transmit signal (TX) and the measured level of the receive signal (RX).

The RX value is the local receive level of the incoming signal. The receive level range of measurement is from 0 to -43 dBm in 1.5-dBm increments. If the signal level is less than the carrier detect threshold, "<CD" is displayed.

- **Echo Characteristics Screen.** Displays the characteristics of the echo portion of the receive signal. Specifically, it shows milliseconds of delay and the offset frequency in Hertz.
- **Channel Frequency Offset.** Displays the frequency offset of the receive signal in Hertz.
- **Throughput Screen.** Functions only if error correction is enabled. It shows the rate (in bits per second) at which the Modem is accepting characters from the DTE.
- **Packet Screen.** The packet screen functions only when error correction is enabled. It has three components, as explained below.

Size. Shows size of data packets (MNP) or blocks (V.42/V.42 bis) currently being transmitted. MNP uses shorter packets to transmit through noisy lines and longer packets (allowing greater throughput) when line conditions are good. The maximum MNP packet size is 64 (MNP classes 1-3) or 256 characters (MNP classes 4 and 5). The block size for V.42/V.42 bis is fixed at 128 characters.

Transmitted (TX). Number of packets or blocks transmitted since the connection was established.

Errors (ER). Number of retransmissions (retransmitted because of data errors) since the connection was established.

- **Mode and Rate Screen.** Shows the following data:

Mode. Below MODE, the screen indicates the error correction status:

NORMAL — Error correction and buffer mode are both inactive.

V42 — V.42 error correction (LAPM) is active.

V42bis — V.42 bis error correction (LAPM with data compression) is active.

MNP 01 to MNP 05 — MNP error correction is active.

BUFFER — Buffer mode is active.

OFFLINE — Modem is off-line.

Rate. Shows the data rate of the DTE.

7.7 Local Modem Diagnostics

Local modem diagnostics are for testing the Modem and its adjoining system. The tests are accessed from the main menu and are easily performed if the Modem is attached to DTE or an external BERT.

7.7.1 ANALOG LOOPBACK (ALB) TEST

Analog loopback testing allows you to test the local modem and its associated terminal independently from the telephone interface and the remote modem. Figure 7-1 shows the connections automatically made during the test.

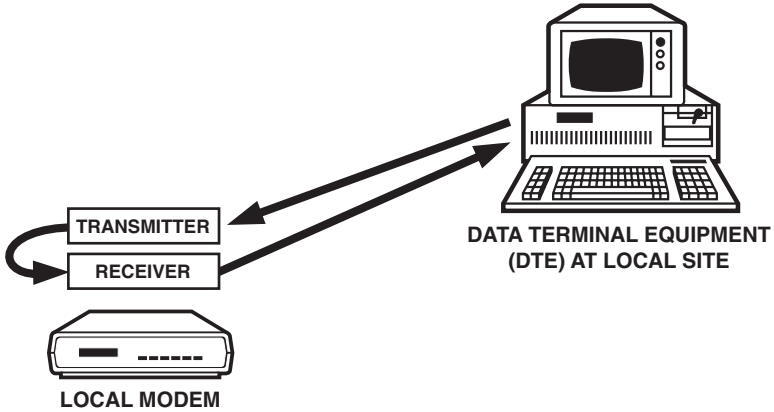

Figure 7-1. Analog Loopback Test.

In Hayes emulation mode only, initiate the ALB test using the command **&T1** (preceded by **AT**). In any mode, initiate the ALB test using the modem's front panel controls, explained in the following paragraphs.

Make sure the modem is idle, the data rate is the same as the DTE's data rate, and the DTR circuit is on. (If TR is present on the EIA status screen, the DTR circuit is on.)

From the second page of the LCD MAIN MENU, select TEST. TEST takes you to screen 1 of the LOCAL TEST menu, where ALB is displayed as one of the test selections. Select ALB.

The ANALOG LOOPBACK screen is displayed, with ON and OFF as the possible selections.

Select ON to activate the test. In general, the "DSR during ALB test option" discussed in **Chapter 3** should be left ON (default selection) to avoid disrupting the DTE and DTE software operations.

The EIA status screen is displayed while the test is being conducted. Make sure that test data is being generated. Watch for data errors. By transmitting test data and comparing it with the received copy, you can make sure the DTE and modem are both working.

To end the test, press the ENT pushbutton to return to the ANALOG LOOPBACK screen, and then select OFF.

7.7.2 ANALOG LOOPBACK SELF-TEST (ALBST)

In the analog loopback self test, the modem is placed in analog loopback and data is sent and received by an internal 511-bit pattern generator and receiver. Therefore, no DTE or external BERT is necessary. Figure 7-2 shows the data flow for this test.

In Hayes mode only, initiate the ALBST using the command **&T8** (preceded by **AT**). In any mode, initiate the ALBST using the modem's front-panel controls, as follows:

From page 2 of the LCD MAIN MENU, select TEST. This takes you to screen 1 of the LOCAL TEST menu, where ALBST is visible as one of the selections. Select ALBST.

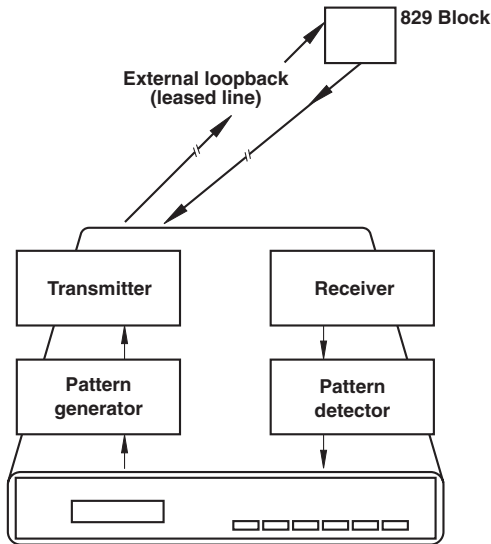

Figure 7-2. Analog Loopback Self-Test (ALBST).

The SELFTEST screen is displayed, with ON and OFF as the possible selections. Select ON to activate the test. The EIA status screen is displayed while the test is being conducted. If ER is present on the front panel, data errors occurred. The ER indicator may flash on when the test is first started, but it should quickly go out and remain off until the end of the test.

To end the test, press the ENT pushbutton to return to the SELFTEST screen. Then select OFF.

7.7.3 ANALOG LOOPBACK SELF TEST WITH ERRORS (ST/E)

In the analog loopback self test with errors, data is sent and received by an internal 511-bit pattern generator and receiver. No DTE or external BERT is necessary. This test differs from the ALBST in that errors are injected into the data flow every few seconds. The data flow is the same as that shown in Figure 7-2 (the ALBST).

To run the test, go to the LCD MAIN MENU. From page 2 of the LCD MAIN MENU, select TEST. This takes you to screen 1 of the LOCAL TEST menu, where ST/E is visible as one of the selections. Select ST/E.

The SELFTEST W/ERROR screen is displayed, with ON and OFF as the possible selections. Select ON to activate the test. The EIA status screen is displayed. The ER indicator should flash every few seconds, indicating that the pattern generator and detector are working. Errors are injected every few seconds. To end the test, press the ENT pushbutton to return to the SELFTEST W/ERROR screen. Then select OFF.

7.7.4 EXTERNAL ANALOG LOOPBACK (ALBX) TEST

The external analog loopback test is available for B.

The ALBX test allows you to test the local modem and its associated terminal, and to verify the availability of the leased-line circuit. The test circuit does not include the remote modem. Figure 7-3 shows the connections automatically made during the ALBX test.

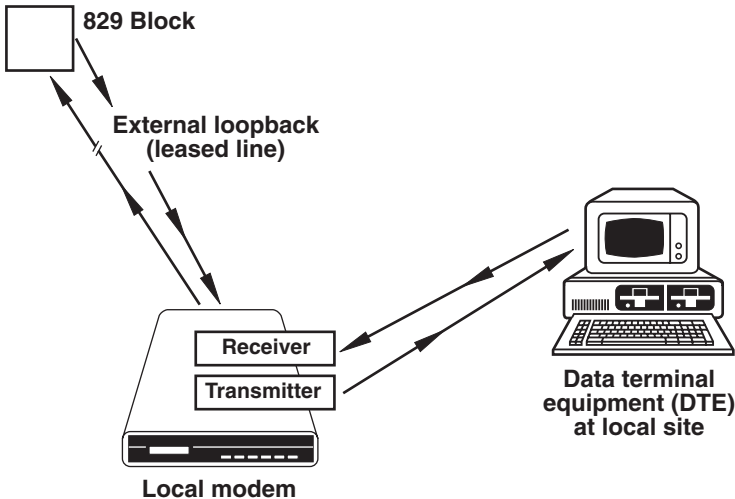

Figure 7-3. External Analog Loopback Test (ALBX).

NOTE

The ALBX test may result in errors or may fail altogether even where conditions are satisfactory for normal operation. The test channel presented to the modem during the ALBX test includes all impairments of both the inbound and outbound channels (amplitude distortion, delay distortion, noise, etc.). The main purpose of the ALBX test is to verify that the Modem is connected to the leased line and the leased-line circuit is complete. The test is not meant to assess the suitability of the leased line.

Initiate the ALBX test using the Modem's front-panel controls, as explained in the following paragraphs.

Make sure the local modem is not in communication with the remote modem, the data rate is the same as the DTE's data rate, and the DTR circuit is on. (If TR is present on the EIA status screen, the DTR circuit is on.)

From the second page of the LCD MAIN MENU, select TEST. Go to the second page of the LOCAL TEST menu. Select ALBX.

The ANALOG LOOP(EXT) screen is displayed, with ON and OFF as the possible selections.

Select ON to activate the test. In general, the "DSR during ALB test" option discussed in **Chapter 2** should be left ON (default selection) to avoid disrupting the DTE and DTE software operations.

The EIA status screen is displayed while the test is being conducted. If no external loopback is present, the status screen displays an IDLE message. If a loopback is present, handshake sequence codes appear (H-01, etc.), followed by the modem speed. Ensure that test data is being generated and watch for data errors. By transmitting test data and comparing it with the received copy, the DTE and modem are checked for proper operation. During the ALBX test, RD (receive data) may appear on the status screen even though no data is being received.

On a flat line, the Modem in ALBX test mode trains and remains running across the following range of signal loss: in V.32 mode, 0-51 dBm (0-52 dBm at 12,000 bps); for V.33 operation, 0-47 dBm; and for Bell 208A/B operation, 0-37 dBm. If signal loss exceeds the limits, the test may not start or may be halted.

During the ALBX test, the modem attempts to retrain upon loss of carrier. In switched carrier mode, the modem attempts to retrain upon loss of RTS.

To end the test, press the ENT pushbutton to return to the ANALOG LOOP(EXT) screen. Then select OFF.

7.7.5 EXTERNAL ANALOG LOOPBACK SELF-TEST (ALXST)

The external analog loopback self-test is available for **4-wire leased line mode only**.

The ALXST places the modem in analog loopback and causes data to be sent and received by an internal 511-bit pattern generator and receiver. No DTE or external BERT is necessary. As shown in Figure 7-4, the test circuit includes the leased lines (the external loopback).

NOTE

The ALXST may result in errors or may fail altogether even where conditions are satisfactory for normal operation. The test channel presented to the modem during the ALXST includes all impairments of both the inbound and outbound channels (amplitude distortion, delay distortion, noise, etc.). The main purpose of the ALXST is to verify that the modem is connected to the leased-line and the leased line circuit is complete. The test is not meant to assess the suitability of the leased line.

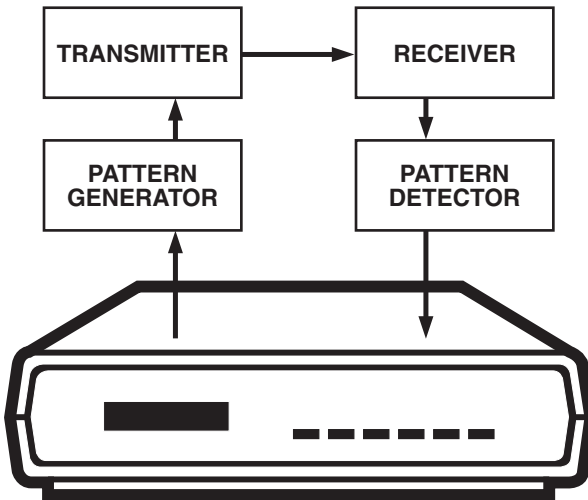

Figure 7-4. External Analog Loopback Self Test (ALBST).

To initiate the ALXST, use the Modem's front-panel controls to go to the LCD MAIN MENU. From page 2 of the LCD MAIN MENU, select TEST. Go to the second page of the LOCAL TEST menu. Select ALXST.

The ANALOG ST (EXT) screen is displayed, with ON and OFF as the possible selections. Select ON to activate the test.

The EIA status screen is displayed while the test is being conducted. If no external loopback is present, the status screen displays an IDLE message. If a loopback is present, handshake-sequence codes appear, followed by the modem speed. If "ER" is present on the front panel, data errors occurred. The ER indicator may flash on when the test is first turned on, but it should quickly go out and remain off until the end of the test.

The information at the end of the previous section (for the ALBX test) concerning signal loss, loss of carrier, and loss of RTS also applies to the ALXST.

To end the test, press the ENT pushbutton to return to the ANALOG ST (EXT) screen. Then select OFF.

7.7.6 DIGITAL LOOPBACK TEST (DLB)

Digital loopback testing determines the operational performance of the local modem, the remote modem, and the telephone line as a composite system. For the test, data must be sent and received at the remote modem. The test regenerates the data and loops it back to the remote modem. As with the ALB test, a comparison of the results of the DLB test indicates whether or not the DTE is performing satisfactorily. A comparison of the results of the ALB and DLB tests can help determine whether the modem or the telephone line is defective.

In the DLB test, the data to be sent and received is originated and checked by the DTE or external BERT. Figure 7-5 shows the data flow for this test.

In Hayes mode only, initiate the DLB test using the command **&T3** (preceded by AT). In any mode, initiate the DLB test using the modem's front-panel controls.

From page 2 of the LCD MAIN MENU, select TEST. Go to the second page of the LOCAL TEST menu. Select DLB.

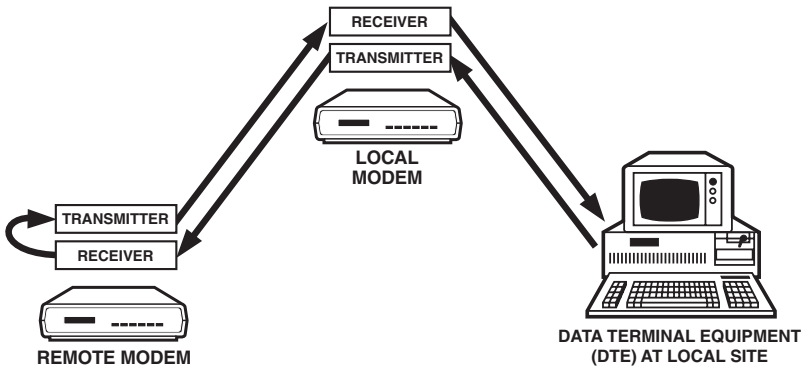

Figure 7-5. Digital Loopback Test (DLB).

The DIGITAL LOOPBACK screen is displayed, with ON and OFF as the possible selections. Select ON to activate the test. The EIA status screen is displayed while the test is being conducted. Ensure that test data is being generated and watch for data errors. By transmitting test data and comparing it with the received copy, the DTE is checked for proper operation. To end the test, press the ENT pushbutton to return to the DIGITAL LOOPBACK screen. Then select OFF.

7.8 Remote Modem Diagnostics

The Modem performs two tests on compatible remote modems: remote digital loopback (RDL) and remote digital loopback self test (RDLST). If a problem is encountered and the local Modem passes all diagnostic tests, the local Modem can test the remote modem.

Two (noncontiguous) REMOTE TEST screens are on the Modem's LCD. The remote tests are initiated from the REMOTE TEST menu. (Select RMT from MAIN MENU screen 2. Select TEST. Then, select the test type.) A remote test cannot be initiated unless the Remote Test option is enabled on the remote modem. This option (also REMOTE TEST on the LCD) is accessed via SETUP screen 4.

7.8.1 REMOTE DIGITAL LOOPBACK (RDL) TEST

The RDL test (Figure 7-6) allows testing of the local modem, remote modem and telephone line from the local site.

In Hayes mode only, initiate the RDL test using the command **&T6** (preceded by AT). In any mode, initiate the RDL test from the Modem's front panel. Both modems should be on-line and should be tested at the DTE's data rate. Ensure that the DTR circuit is on. If TR is present on the EIA status screen, the DTR circuit is on.

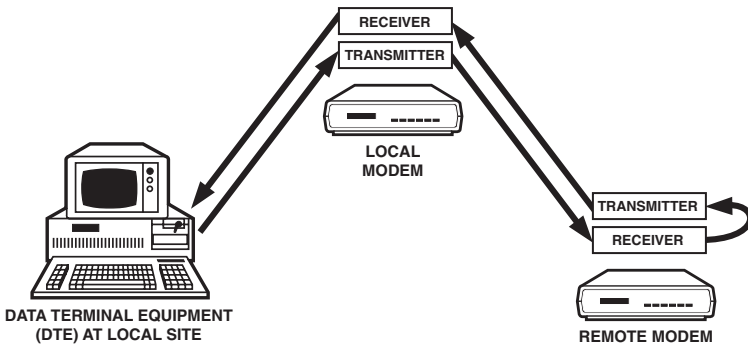

Figure 7-6. Remote Digital Loopback Test (RDL).

From page 2 of the MAIN MENU, select RMT. Then select TEST.
From the REMOTE TEST menu, select RDL.

From the REMOTE DIGIT LOOP screen, select ON to activate the test. The status screen is displayed as the test is being conducted. Make sure that test data is being generated and watch for data errors. By transmitting test data and comparing it with the received copy, you can make sure the Modems and the telephone line are working.

To end the test, press the ENT pushbutton to return to the REMOTE DIGIT LOOP screen. Then select OFF.

7.8.2 REMOTE DIGITAL LOOPBACK SELF-TEST (RDLST)

The RDLST allows testing of the local modem, remote modem, and telephone line from the local site (as did the previous test). However, test data is generated by internal modem circuitry as opposed to a DTE or external BERT. Figure 7-7 shows the connections automatically made during the test.

In Hayes mode only, initiate the RDLST using the command **&T7 (AT &T7)**. In any mode, initiate the RDLST test from the front panel.

Both modems must be on-line. From the second page of the MAIN MENU, select RMT. Then, select TEST. From the REMOTE TEST menu, select RDLST.

From the RDL SELFTTEST screen, select ON to activate the test. The status screen is displayed as the test is being conducted. If "ER" is present on the status screen, the modem is detecting errors. If numerous errors are detected, take steps to try to identify their source.

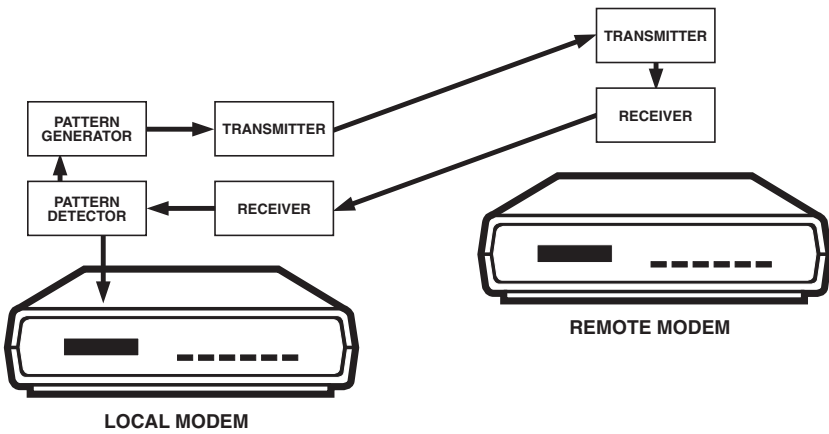

Figure 7-7. Remote Digital Loopback Self Test.

Appendix A: DB25 Pin Assignments

Pin	Designation	Function	LCD Indicator	Source
1	AA	Frame ground—not connected		
2	BA	Transmit data (TD)	TD	DTE
3	BB	Receive data (RD)	RD	Modem
4	CA	Request to send (RTS)	RS	DTE
5	CB	Clear to send (CTS)	CS	Modem
6	CC	Data set (modem) ready (DSR)	MR	Modem
7	AB	Signal Ground (SG)		Ground
8	CF	Carrier Detect (CD)	CD	Modem
9	+P	Testing voltage, +10V		Modem
10	-P	Testing Voltage - 10V		Modem
15	DB	Transmit Clock (TC)		Modem
17	DD	Receive Clock (RC)		Modem
18	CN	Analog loopback (ALB) control ¹		DTE
20	CD	Data terminal ready (DTR)	TR	DTE
21	CN	Remote digital loopback (RDL) control ¹		DTE
22	CE	Ring Indicator (RI)	R	Modem
23	CH	Speed Select (CH/CI) ²		DTE
24	DA	External transmit clock		DTE
25	CN	Test mode indicator (TM) ³	TM	Modem

¹ +voltage activates indicated loopback test (only if ALB-DTE controlled or RDL-DTE controlled option is enabled); -voltage disables test.

² +voltage, 14,400 bps; -voltage, 2400 bps.

³ Alternatively, pin 25 may be used for analog loopback (ALB) control. See Appendix D.

Appendix B: Quick Setup Configurations

Table B-1 shows the complete default configuration for each of the Quick Setup modes. When you select a Quick Setup, the modem automatically sets all options as indicated in the table. The options are listed in the same order in which they appear on the LCD flow chart. See **2.0, Quick Start**, for instructions on selecting Quick Setups.

NOTE: All notes appear at the end of the table.

Table B-1. Quick Setup Configurations.

	OPTION	Default Settings Listed by Mode or Type of Operation						
		V.25 bis HAYES	ASYNC ¹	2-WIRE DUMB	4-WIRE LEASED ²	LEASED ²	BELL V.33	208 ³
Line Type	Line Type	2W-D	2W-D	2W-D	2W-LL	4W-LL	4W-LL	2W-D
Speed (Data Rate)	Speed, Max	19200	19200	19200	19200	19200	14400	4800
	Speed, Min	300	300	300	4800	4800	12000	4800
	Speed Type	V.32	V.32	V.32	V.32	V.32	V.33	208
V.42 Error Correction Options	V.42 Mode	Auto	Auto ¹	Auto	Auto	Auto	OFF	OFF
	MNP Class (Limit)	5	5	5	5	5	5	5
	V.42 Break Handling	NDT/ NEXP	NDT/ NEXP	NDT/ NEXP	NDT/ NEXP	NDT/ NEXP	NDT/ NEXP	NDT/ NEXP
	V.42 Protocol	LAPM/ MNP	LAPM/ MNP	LAPM/ MNP	LAPM/ MNP	LAPM/ MNP	LAPM/ MNP	LAPM/ MNP
	V.42 bis	Enable	Enable	Enable	Enable	Enable	Enable	Enable
	Buffer	Enable	Enable ¹	Enable	Enable	Enable	Disable	Disable
	DTE Speed	38400	38400	38400	38400	38400	38400	38400
Flow Control DTE-DCE	DC1/ DC3	DC1/ DC3	DC1/ DC3	DC1/ DC3	DC1/ DC3	DC1/ DC3	DC1/ DC3	
Flow Control DCE-DTE	DC1/ DC3	DC1/ DC3	DC1/ DC3	DC1/ DC3	DC1/ DC3	DC1/ DC3	DC1/ DC3	
DTE Pass-thru Flow Control	Disable	Disable	Disable	Disable	Disable	Disable	Disable	

See notes on page 127.

Table B-1 (continued). Quick Setup Configurations.

	OPTION	Default Settings Listed by Mode or Type of Operation						
		V.25 bis HAYES	ASYNC ¹	2-WIRE DUMB	4-WIRE LEASED ²	LEASED ²	BELL V.33	208 ³
Misc.	Address	999,999	999,999	999,999	999,999	999,999	999,999	999,999
	Dialer Mode	Hayes	V.25 bis/ Async ¹	OFF	OFF	OFF	OFF	OFF
	Auto Answer	Enable	Enable	Enable	Disable	Disable	Disable	Enable
Data Format Options	Data Format	Async	Async ¹	Async	Sync	Sync	Sync	Sync
	Character Length	10	10	10	10	10	10	10
	Parity	None	Even ¹	None	None	None	None	None
Disconnect Options	RX Space Disconnect	Enable	Enable ¹	Enable	Enable	Enable	Enable	Enable
	TX Space Disconnect	Enable	Enable ¹	Enable	Enable	Enable	Enable	Enable
	Carrier Disconnect	Enable	Enable	Enable	Enable	Enable	Enable	Enable
	Line Current Disconnect	Enable	Enable	Enable	Enable	Enable	Enable	Enable
	RTS Disconnect	OFF	OFF	OFF	OFF	OFF	OFF	OFF
Test Options	DSR During ALB	ON	ON	ON	ON	ON	ON	ON
	Remote Test	Enable	Enable	Enable	Enable	Enable	Enable	Enable
EIA Options	CTS to EIA	True	True	Normal	Normal	Normal	Normal	Normal
	CD to EIA	Normal	Normal	Normal	Normal	Normal	Normal	Normal
	DSR to EIA	True	Normal	Normal	True	True	True	Normal
	DTR from EIA	Normal	Normal	Normal	True	True	True	Normal
	ALB—DET controlled	Disable	Disable	Disable	Disable	Disable	Disable	Disable

See notes on page 127.

Table B-1 (continued). Quick Setup Configurations.

	OPTION	Default Settings Listed by Mode or Type of Operation						
		V.25 bis HAYES	ASYNC ¹	2-WIRE DUMB	4-WIRE LEASED ²	LEASED ²	BELL V.33	208 ³
EIA Options (continued)	RDL—DTE controlled	Disable	Disable	Disable	Disable	Disable	Disable	Disable
	TM to EIA	Normal	Normal	True	True	True	True	True
Modem Setup Options	CD Level, Leased	-26 dBm	-26 dBm	-26 dBm	-26 dBm	-26 dBm	-26 dBm	-26 dBm
	CD Level, Dial	-51 dBm	-51 dBm	-51 dBm	-51 dBm	-51 dBm	-51 dBm	-51 dBm
	TX Level, Leased	0 dBm	0 dBm	0 dBm	0 dBm	0 dBm	0 dBm	0 dBm
	TX Level, Dial	Permis.	Permis.	Permis.	Permis.	Permis.	Permis.	Permis.
	Signal Quality Level	10 ^{^3}	10 ^{^3}	10 ^{^3}	10 ^{^3}	10 ^{^3}	10 ^{^3}	10 ^{^3}
	Compromise Equalizer	T-III	T-III	T-III	T-III	T-III	T-III	T-III
	Trellis Code	Enable	Enable	Enable	Enable	Enable	Enable	Enable
	Transmit Clocking	Internal	Internal	Internal	Internal	Internal	Internal	Internal
	T1 Timer	0.8 sec	0.8 sec	0.8 sec	0.8 sec	0.8 sec	0.8 sec	0.8 sec
	Auto-retrain	Enable	Enable	Enable	Enable	Enable	Enable	Enable
	Answer/Originate	ORIG	ORIG	ORIG	See note 2	See note 2	ORIG	ORIG
	Answer Tone	2100Hz	2100Hz	2100Hz	2100Hz	2100Hz	2100Hz	2100Hz
	Front Panel	Enable	Enable	Enable	Enable	Enable	Enable	Enable
	Speaker Control	Till-CD	Till-CD	Till-CD	Till-CD	Till-CD	Till-CD	Till-CD
	Speaker Volume	High	High	High	High	High	High	High
Guard Tones	OFF	OFF	OFF	OFF	OFF	OFF	OFF	
V.13 Operation	OFF	OFF	OFF	OFF	OFF	OFF	OFF	

See notes on page 127.

Table B-1 (continued). Quick Setup Configurations.

	OPTION	Default Settings Listed by Mode or Type of Operation						
		V.25 bis HAYES	ASYNC ¹	2-WIRE DUMB	4-WIRE LEASED ²	LEASED ²	BELL V.33	208 ³
V.33 and Bell 208A/B options	Carrier	Switched	Switched ⁴	Switched	Switched	Switched	Constant	Switched
	CTS	RTS	RTS ⁴	RTS	RTS	RTS	ON	RTS
	RTS-CTS Delay	0	0 ⁴	0	0	0	0	150 ms
Auto-Recovery Options	Auto-Recovery Select	None	None	None	None	None	None	None
	Return from Auto-Recovery	OFF	OFF	OFF	OFF	OFF	OFF	OFF
	Auto-Recovery Test Interval	20 min	20 min	20 min	20 min	20 min	20 min	20 min
LCD Panel	LCD Intensity	3	3	3	3	3	3	3

See notes on next page.

Table B-1 (continued). Quick Setup Configurations.**Notes:**

¹V.25 bis synchronous configurations (character- and bit-oriented) are the same as the V.25 bis asynchronous configuration except as follows:

- V.42 MODE is OFF
- BUFFER is disabled
- DATA FORMAT is synchronous
- PARITY is ODD
- RX SPACE DISCONNECT is disabled
- TX SPACE DISCONNECT is disabled
- DIALER MODE (V.25 bis) is: Sync_c for character-oriented mode,
Sync_b for bit-oriented mode.

²Leased line originate and answer Quick Setups [(ORG) and (ANS) on the LCD] are the same except that ANSWER/ORIGINATE is set to ORIGINATE for the originate Quick Setups and is set to ANSWER for the answer Quick Setups (2-wire or 4-wire).

³The V.32/208 auto-mode Quick Setup configuration is the same as the Dumb mode Quick Setup configuration except as follows:

- SPEED TYPE is AUTO
- DATA FORMAT is synchronous
- V.13 OPERATION is set to TX and RX
- CARRIER is constant
- Summary Setup V.32/208 option (data pump options group) is set to 1 (enable).

⁴Effective for synchronous modes only.

Appendix C: Summary Setup

C.1 Introduction to Summary Setup

Summary Setup is designed to allow experienced users to quickly change option settings for any mode. There are three Summary Setup screens: SETUPS, AT PROFILES, and S-REG. They are briefly described on the next page.

Because the screens show numerical codes with very little explanation, Summary Setup is recommended for experienced users only. Changes made through Summary Setup modify the active modem configuration and are saved to memory when you exit Summary Setup.

ACCESSING SUMMARY SETUP

Summary Setup is accessed from screen 6 of the SETUP menu. The SUMMARY screen includes a four-digit checksum value to the right of the word SUMMARY. This number changes if any of the option settings are changed. You can determine *if* any of the modem's settings were changed, but you cannot determine what options were changed.

From the SUMMARY screen, choose SETUPS to change options, AT to change options that are associated AT commands, or S-REG to change S Register values. (See Figure C-1.)

KEY TO THE SUMMARY SETUP SCREENS

Each Summary Setup Screen is essentially the same: brief descriptive information on the top line and a long string of numbers on the bottom line.

The numbers are broken down into groups that represent a category of options (for example, EIA interface options).

Each digit position represents an option, and the number in each digit position indicates the current option setting (parameter). The diagrams in this appendix show the following information:

- Which options are included in each option group
- Which option is indicated by each digit position within the group
- The possible parameters for each option.

NOTE

The number in each digit position is the current option setting (parameter). The diagrams of this Appendix show the factory-default setting for each option.

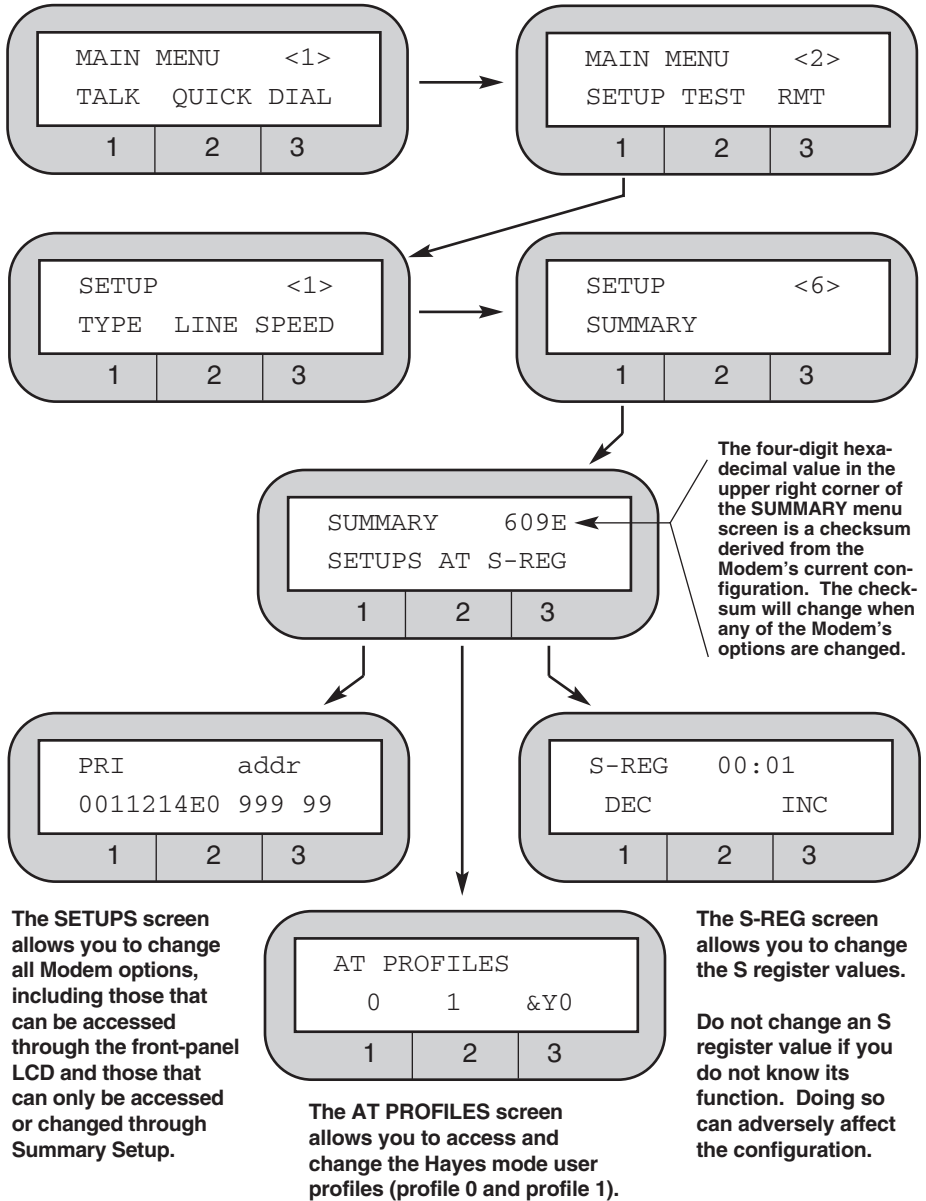
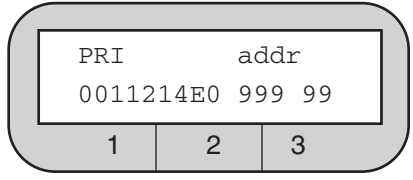

Figure C-1. How to access the Summary-Setup Screens.

C.2 SETUPS Screen

Only part of the SETUPS screen can be displayed at any one time. The full screen is displayed below next to the numbers 1, 2, and 3.



To make configuration and viewing easier, the screen is broken down into a number of sections. Use the front-panel pushbuttons to move around within the SETUPS screen (see Figure C-2).

1

PRI	addr	dial	eia	v42<1>
0011214E0	999 999	11111002210	000100000	20334300

2

v42<2>	L.L.	pump1	pump2	pump3
210001021	10000010	30100101100	00000110	00000000

3

misc1	misc2	misc3
1141110	0000 001FFFF1	71000000

Primary Options:

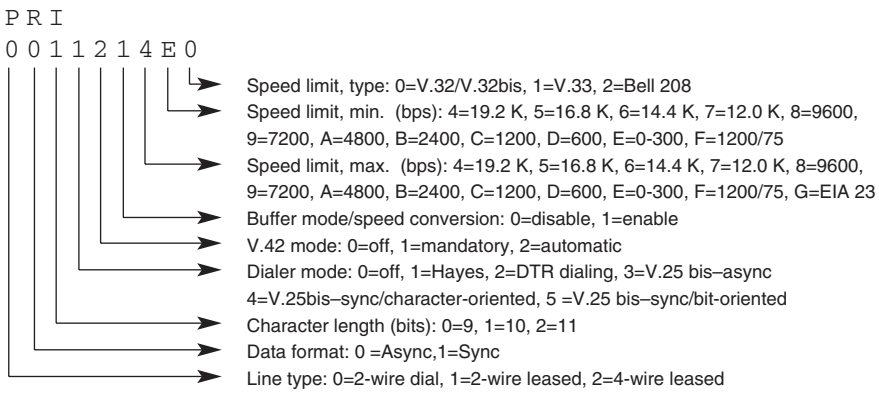

NOTE

Speed limit, min. and Speed limit, max.: 7200 bps parameters are available only if V.32 bis mode is enabled.

Primary Options:

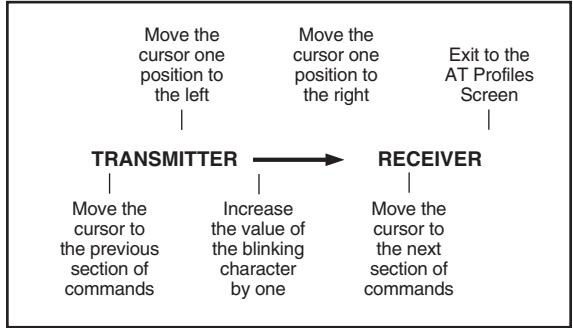
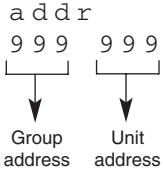
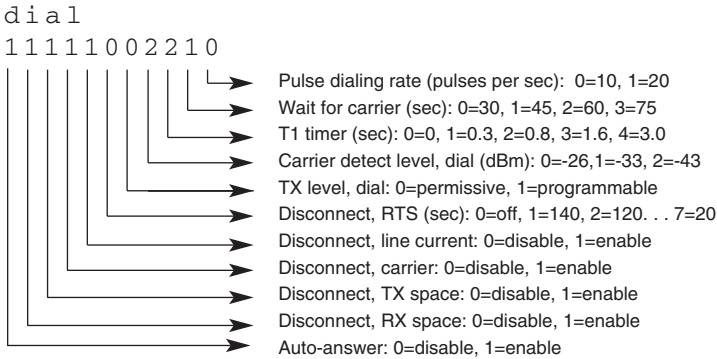
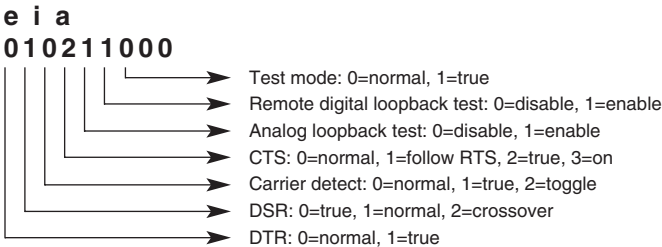

Figure C-2. How to move the cursor in the SETUPS screen using the pushbuttons.

Dial Line Options:



EIA INTERFACE OPTIONS:



V.42 ERROR CORRECTION OPTION:

NOTE

“V42 <1>” and “V42 <2>” are displayed to help indicate the relative positions of individual options across the LCD.

V42 <1> V42 <2>
00335311 20001021

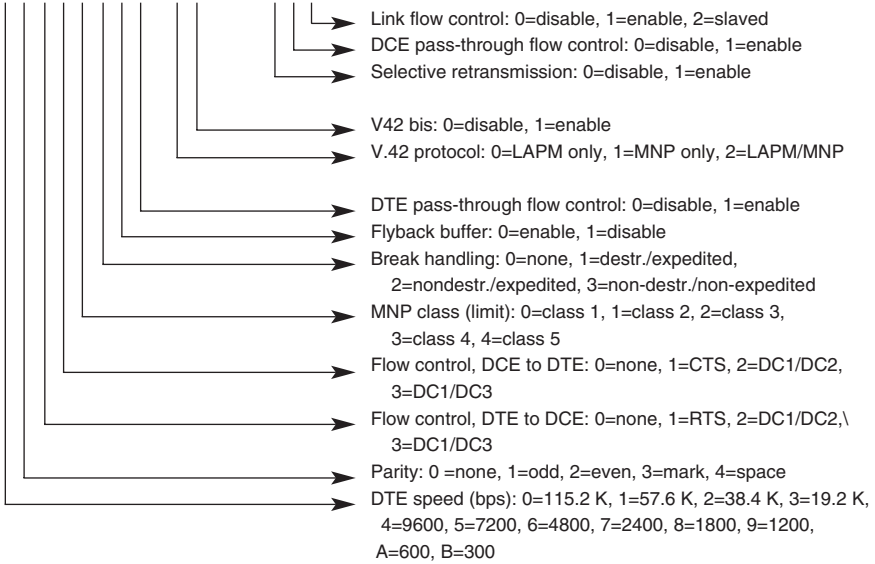

LEASED LINE OPTIONS:

L. L.
10020010

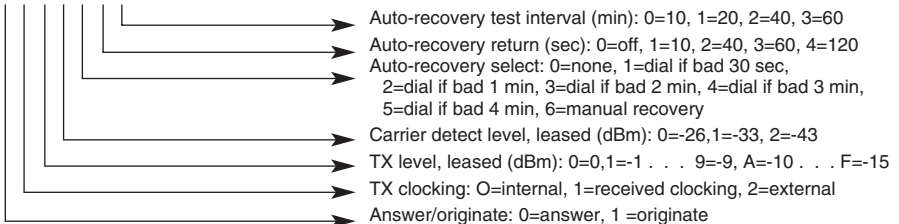

DATA PUMP OPTIONS:

NOTE

“pump1” and “pump2” are displayed to help indicate the relative positions of individual options across the LCD.

pump1 pump2
2002103010100011110

These five options apply to the Modem (MD833A–R2) only.

- 208 phase detection: 0=normal, 1=compensated
- V.32 mode: 0=V.32 extended, 1=V.32 bis
- Rate renegotiation (RRP): 0=disable, 1=enable

- Turnaround delay: 0=on, 1=off
- Satellite delay: 0=disable, 1=enable
- RTS to CTS delay (ms): 0=none, 1=15, 2=50, 3=150
- CTS: 0=always ON, 1=follow RTS
- Carrier type: 0=switched, 1=constant

- Phase reversal in answer tone: 0=enable, 1=disable
- Auxiliary channel: 0=disable, 1=enable
- Speed fallback: 0=disable, 1=enable

- Trellis coding: 0=disable, 1=enable
- Answer tone: 0=2100 Hz, 1=2225 Hz
- Guard tone: 0=off, 1=550 Hz, 2=1800
- Auto-retrain: 0=disable, 1=enable
- Signal quality level (error/bits): 0=1 in 103, 1=1 in 105
- Compromise equalizer type: 0=off, 1=I, 2=II, 3=III, 4=IV

MISCELLANEOUS OPTIONS:

NOTE

“misc1” and “misc2” are displayed to help indicate the relative positions of individual options across the LCD. The dashes (-) are shown in this example to help indicate the relative positions of these three particular options across the LCD.

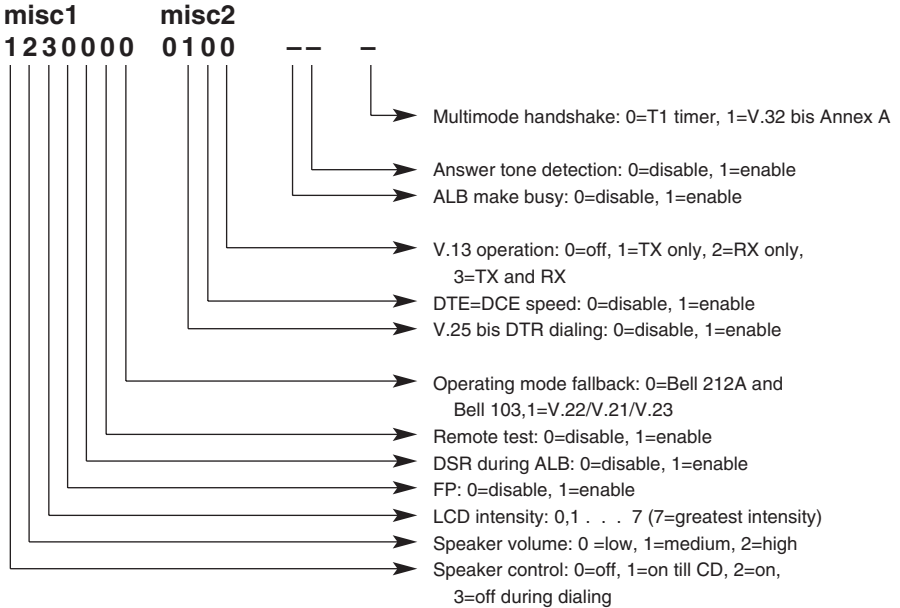

C.3 AT PROFILES Screen

From the AT PROFILES screen you can select a Hayes mode configuration profile (either 0 or 1). Only part of the profile can be displayed at one time. The selected profile is used as the active configuration and is also designated as the default user profile.

- Press pushbutton 1 to select profile 0.
- Press pushbutton 2 to select profile 1.
- Press pushbutton 3 to toggle between profile 0 and profile 1 as the default. You can achieve the same effect by issuing the **&Y** command (**&Y0** or **&Y1**).

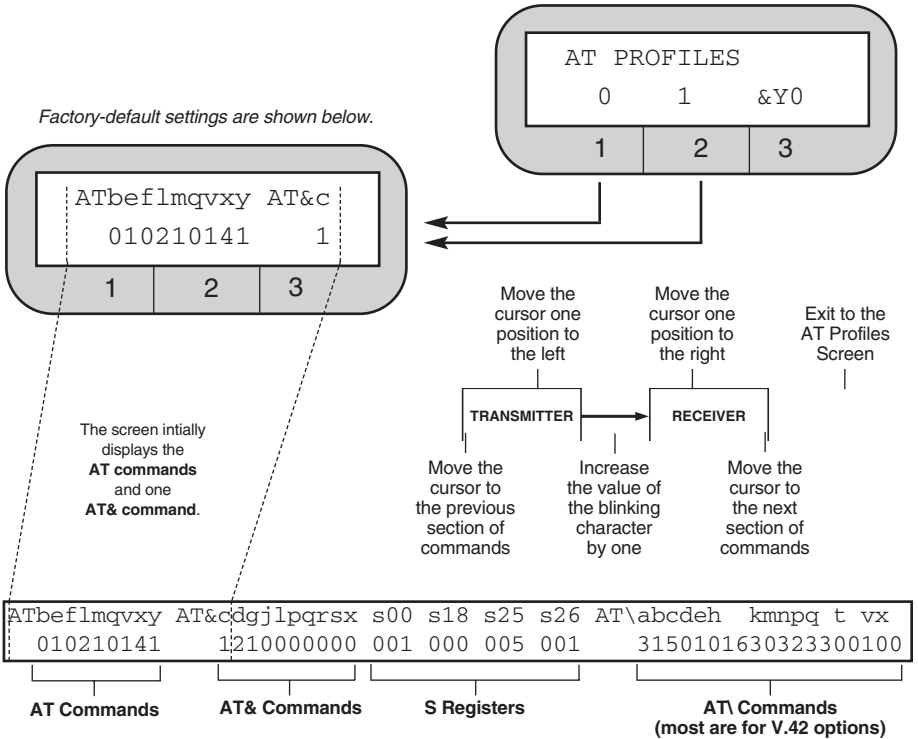

Figure C-3. Selecting a Profile.

NOTE

Refer to Table 5-1, Hayes Compatible Commands, for an explanation of the commands represented in this diagram.

C.4 S-REG Screen

The S-REG screen may be used to read or change the value stored in an S register. For more information, see 5.3, **S Registers**.

NOTE

Not all S registers are intended for user access. Do not change the value of an A register if you do not know the register's function. Doing so can adversely affect the modem's configuration.

The S-REG Screen displays an S register number and the value currently stored in the displayed S register.

HOW TO CHANGE S REGISTER VALUES

Select the desired S register number, then modify its value, as follows: Use the arrow pushbuttons to move the LCD cursor from one digit to the next. Then select DEC or INC to decrease or increase the selected (blinking) value until the desired value is displayed.

S registers can also be changed by using the Hayes mode S command, as explained in 5.0 **Hayes Emulation Mode**.

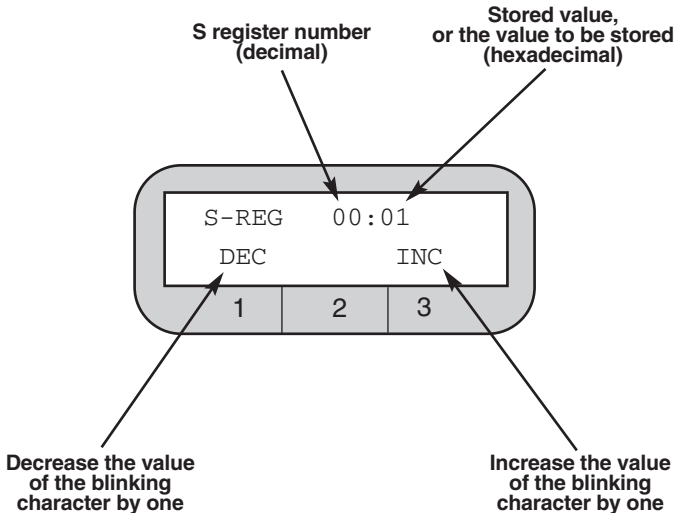

Figure C-3. Changing the S Register Value.

Appendix D: Jumpers

WARNING

Jumpers should be switched only by qualified service personnel.

For most applications, there is no need to reset the modem's internal jumper switches. However, a jumper switch will have to be reset if you need to do any of the following:

- Connect frame ground to signal ground.
- Switch from A/A1 control to MI/MIC control.
- Strap the modem for use in a DC rack enclosure.
- Change the function of EIA interface pin 25.

If you need to reset a jumper switch, refer to the next page to determine the jumper that should be switched, where it is located, and how it should be set. The jumpers are numbered on the circuit board; for example, JP4 is jumper 4. To access the jumpers, unscrew the four screws on the bottom of the modem and carefully lift off the cover.

WARNING

Improper setting of AC and DC power jumpers could result in serious damage to the modem.

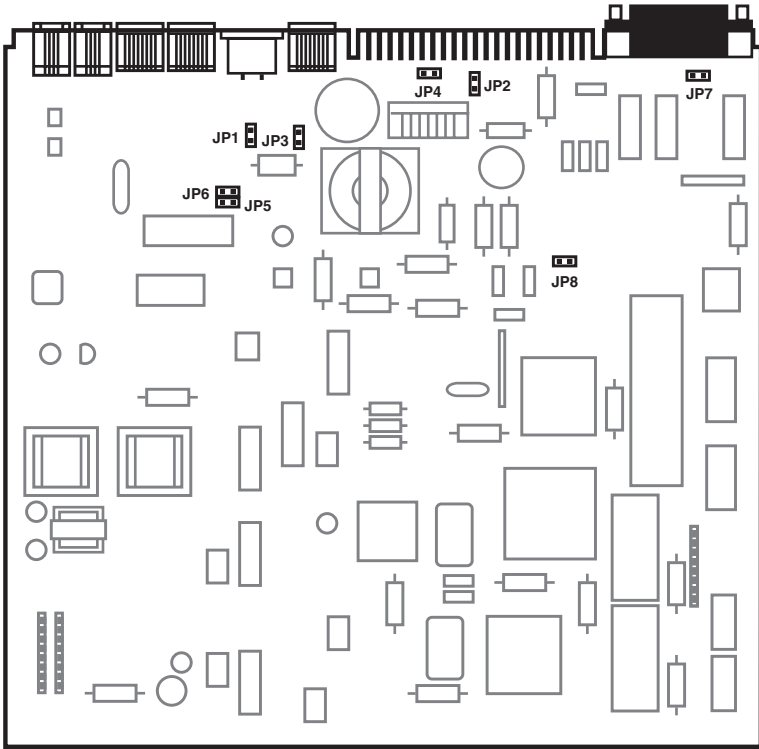

Figure D-1. Modem Circuit Board—Jumper Locations.

Table D-1. Jumper Switch Functions.

JUMPER(S)	Pins 1 and 2 connected	Pins 2 and 3 connected
JP1	Frame and signal ground connected	Frame and signal ground not connected
JP2		-12/-24/-48 VDC operation
JP3, JP4 (Set to same position)	-12/-24/-48 VDC operation	
JP5, JP6 (Set to same position)	A/A1 control	MI/MIC control
JP7	Pin 25 used for analog loopback (input)	Pin 25 used as test mode indicator (output)
JP8	For factory use only. <i>Do not change JP8 setting!</i>	
<p>Factory settings are shown in bold face.</p> <p>For each jumper, pin 1 is identified by a "1" printed on modem circuit board. (The JP2 pin 1 label may be difficult to read; JP2 pin 1 is the pin closest to the edge connector.)</p>		

NORMAS OFICIALES MEXICANAS (NOM) ELECTRICAL SAFETY STATEMENT

INSTRUCCIONES DE SEGURIDAD

1. Todas las instrucciones de seguridad y operación deberán ser leídas antes de que el aparato eléctrico sea operado.
2. Las instrucciones de seguridad y operación deberán ser guardadas para referencia futura.
3. Todas las advertencias en el aparato eléctrico y en sus instrucciones de operación deben ser respetadas.
4. Todas las instrucciones de operación y uso deben ser seguidas.
5. El aparato eléctrico no deberá ser usado cerca del agua—por ejemplo, cerca de la tina de baño, lavabo, sótano mojado o cerca de una alberca, etc..
6. El aparato eléctrico debe ser usado únicamente con carritos o pedestales que sean recomendados por el fabricante.
7. El aparato eléctrico debe ser montado a la pared o al techo sólo como sea recomendado por el fabricante.
8. Servicio—El usuario no debe intentar dar servicio al equipo eléctrico más allá a lo descrito en las instrucciones de operación. Todo otro servicio deberá ser referido a personal de servicio calificado.
9. El aparato eléctrico debe ser situado de tal manera que su posición no interfiera su uso. La colocación del aparato eléctrico sobre una cama, sofá, alfombra o superficie similar puede bloquea la ventilación, no se debe colocar en libreros o gabinetes que impidan el flujo de aire por los orificios de ventilación.

10. El equipo eléctrico deber ser situado fuera del alcance de fuentes de calor como radiadores, registros de calor, estufas u otros aparatos (incluyendo amplificadores) que producen calor.
11. El aparato eléctrico deberá ser connectado a una fuente de poder sólo del tipo descrito en el instructivo de operación, o como se indique en el aparato.
12. Precaución debe ser tomada de tal manera que la tierra fisica y la polarización del equipo no sea eliminada.
13. Los cables de la fuente de poder deben ser guiados de tal manera que no sean pisados ni pellizados por objetos colocados sobre o contra ellos, poniendo particular atención a los contactos y receptáculos donde salen del aparato.
14. El equipo eléctrico debe ser limpiado únicamente de acuerdo a las recomendaciones del fabricante.
15. En caso de existir, una antena externa deberá ser localizada lejos de las lineas de energia.
16. El cable de corriente deberá ser desconectado del cuando el equipo no sea usado por un largo periodo de tiempo.
17. Cuidado debe ser tomado de tal manera que objetos liquidos no sean derramados sobre la cubierta u orificios de ventilación.
18. Servicio por personal calificado deberá ser provisto cuando:
 - A: El cable de poder o el contacto ha sido dañado; u
 - B: Objetos han caído o líquido ha sido derramado dentro del aparato; o
 - C: El aparato ha sido expuesto a la lluvia; o
 - D: El aparato parece no operar normalmente o muestra un cambio en su desempeño; o
 - E: El aparato ha sido tirado o su cubierta ha sido dañada.



© Copyright 1999. Black Box Corporation. All rights reserved.

1000 Park Drive • Lawrence, PA 15055-1018 • 724-746-5500 • Fax 724-746-0746

Free Manuals Download Website

<http://myh66.com>

<http://usermanuals.us>

<http://www.somanuals.com>

<http://www.4manuals.cc>

<http://www.manual-lib.com>

<http://www.404manual.com>

<http://www.luxmanual.com>

<http://aubethermostatmanual.com>

Golf course search by state

<http://golfingnear.com>

Email search by domain

<http://emailbydomain.com>

Auto manuals search

<http://auto.somanuals.com>

TV manuals search

<http://tv.somanuals.com>