

## EncryptTight Enforcement Point (EPEP) Installation Guide

The EncryptTight™ Enforcement Point Installation Guide provides detailed information on how to install and configure EncryptTight Enforcement Points.



### Customer Support Information

Order toll-free in the U.S.: Call 877-877-BBOX (outside U.S. call 724-746-5500)  
FREE technical support 24 hours a day, 7 days a week: Call 724-746-5500 or fax 724-746-0746  
Mailing address: Black Box Corporation, 1000 Park Drive, Lawrence, PA 15055-1018  
Web site: [www.blackbox.com](http://www.blackbox.com) • E-mail: [info@blackbox.com](mailto:info@blackbox.com)



# Table of Contents

<b>About This Document .....</b>	<b>7</b>
Purpose .....	7
Intended audience .....	7
Assumptions .....	7
Conventions used in this document .....	7
Contacting Black Box Technical Support .....	7
<b>Product Overview .....</b>	<b>9</b>
ETEP Introduction .....	9
ET0010A Physical Description .....	10
Front Panel Connectors .....	10
Status Indicators .....	11
Rear Panel .....	11
ET0100A Physical Description .....	12
Front Panel Connectors .....	12
LED Indicators .....	12
Rear Panel .....	13
ET1000A Physical Description .....	14
Front Panel Connectors .....	14
LED Indicators .....	15
Rear Panel .....	16
ET10000A Physical Description .....	17
Front Panel Connectors .....	17
LED Indicators .....	17
Rear Panel .....	19
Features .....	20
Specifications .....	21
MIB Support .....	24
<b>Installation .....</b>	<b>27</b>
Safety Guidelines .....	27
Software Requirements .....	27
ETEP Site Preparation .....	28
Firewall Ports .....	29
Installation Instructions: ET0010A .....	29
Rack Mount Installation .....	30
To install the ETEP in a rack: .....	30
Solid Surface Installation .....	32
To install the ETEP on a solid surface: .....	32
Connecting the Cables: ET0010A .....	34

To cable the ET0010A: .....	34
Powering On the ET0010A .....	35
To power on the ETEP: .....	35
Installing the ET0100A .....	36
Cabling Requirements: ET0100A .....	36
Unpacking the Shipping Carton: ET0100A .....	37
Rack-Mount Installation: ET0100A .....	37
To install the ETEP in a rack: .....	38
Connecting the Cables: ET0100A .....	38
To cable the ET0100A: .....	38
Powering on the ET0100A .....	39
To power on the ET0100A: .....	39
Installing the ET1000A .....	40
Cabling Requirements: ET1000A .....	41
Unpacking the Shipping Carton: ET1000A .....	42
Rack Mount Installation: ET1000A .....	42
To install the ET1000A in a rack: .....	43
Grounding of DC Power Supply: ET1000A .....	44
For DC Power Supply Only .....	44
For Earth Connection .....	44
Connecting the Cables: ET1000A .....	44
To cable the ET1000A: .....	44
Powering on the ET1000A .....	45
To power on the ET1000A: .....	46
Installing the ET10000A .....	47
Cabling Requirements: ET10000A .....	48
Unpacking the Shipping Carton: ET10000A .....	49
Rack Mount Installation: ET10000A .....	49
To install the ET10000A in a rack: .....	50
Connecting the Cables: ET10000A .....	51
To cable the ET10000A: .....	51
Powering on the ET10000A .....	52
Safety Guidelines .....	52
Power-Up Procedure .....	53
To power on the ET10000A: .....	53
Shutting Down the ETEP .....	54
To shut down the ETEP from the CLI: .....	54
<b>Initial Setup .....</b>	<b>57</b>
Overview .....	57
Logging In Through a Serial Link .....	57
To log in to the CLI via a serial link: .....	57
Configuring the Management Port .....	58
About the management port IP address, mask and gateway .....	58
About auto-negotiation .....	59
To configure the management port: .....	59

Setting the Date and Time .....	61
To set the date and time: .....	61
Entering a Throughput License .....	62
To add a license from the command line: .....	62
To view the ETEP throughput speed: .....	63
Configuration Example .....	63
Managing the ETEP .....	63
<b>Maintenance .....</b>	<b>65</b>
Preventative Maintenance .....	65
What To Do If an Appliance Fails .....	65
Obtaining a License for Replacement Units .....	66
Replacing a Power Supply .....	66
Replacing the ET1000A Power Supply .....	66
To replace a power supply in the ET1000A: .....	66
Replacing the ET10000A Power Supply .....	67
To replace a power supply in the ET10000A: .....	67
Tamper Switch and Zeroization .....	69
To recover the ETEP following zeroization: .....	70
Cable Pinouts .....	70
RS-232 Serial Cable: ET0010A and ET10000A .....	70
RS-232 Serial Cable: ET0100A, ET1000A Models .....	71
<b>Troubleshooting .....</b>	<b>73</b>
Symptoms and Solutions .....	73
LED Indicators .....	73
Error State .....	74
Temperature Threshold and Discarded Traffic .....	74
Diagnostic Code Display .....	75
Status Codes: ET0010A .....	75
Diagnostic Codes: ET0100A, ET1000A and ET10000A .....	76
Environmental and Regulatory Information .....	77
WEEE Directive .....	77
RoHS Directive .....	77
Regulatory Information.....	77
ET0010A Regulatory Information .....	78
Safety .....	78
Immunity .....	78
Emissions .....	78
FCC Information (USA) .....	78
Interference-Causing Equipment Standard Compliance Notice (Canada) .....	78
European Notice .....	79
ET0100A Regulatory Information .....	79
Safety .....	79
Immunity .....	79

Emissions .....	79
FCC Information (USA) .....	79
Interference-Causing Equipment Standard Compliance Notice (Canada) .....	79
European Notice .....	80
ET0100A Cabling .....	80
ET1000A Regulatory Information .....	80
Safety .....	80
Immunity .....	80
Emissions .....	80
FCC Information (USA) .....	80
Interference-Causing Equipment Standard Compliance Notice (Canada) .....	81
European Notice .....	81
ET1000A Regulatory Information .....	81
Safety .....	81
EMI/EMC .....	81
FCC Information (USA) .....	81
Interference-Causing Equipment Standard Compliance Notice (Canada) .....	82
European Notice .....	82
ET1000A Regulatory Information .....	82
Normas Oficiales Mexicanas (NOM): Electrical Safety Statement .....	82
INSTRUCCIONES DE SEGURIDAD .....	82
<b>Index .....</b>	<b>85</b>

# About This Document

---

## Purpose

The *ETEP Installation Guide* describes how to cable and install the Black Box™ ETEP Black Box Enforcement Point.

## Intended audience

This document is intended for use by network technicians and security administrators who are familiar with setting up and maintaining network equipment.

## Assumptions

This document assumes that its readers have an understanding of the following:

- Basic principles of TCP/IP networking, including IP addressing, switching and routing.
- Personal computer (PC) operation and common PC terminology
- Terminal emulation software and FTP operations.

## Conventions used in this document

---

<b>Bold</b>	Indicates one of the following: <ul style="list-style-type: none"><li>• a menu title</li><li>• the name of a command</li><li>• the name of a parameter</li></ul>
<i>Italics</i>	Indicates a new term
Monospaced	Indicates machine text, such as terminal output or a file name
<b>Monospaced bold</b>	Indicates a command to be issued by the user

---

# Contacting Black Box Technical Support

Contact our FREE technical support, 24 hours a day, 7 days a week:

- Phone: 724-746-5500
- Fax: 724-746-0746
- e-mail: [info@blackbox.com](mailto:info@blackbox.com)
- Web site: [www.blackbox.com](http://www.blackbox.com)





# 1 Product Overview

---

## ETEP Introduction

The EncrypTight Enforcement Point (ETEP) Variable Speed Encryptors (VSEs) are purpose-built encryption appliances that provide multi-layer data protection. With straightforward setup and configuration, the ETEP has the flexibility to provide Ethernet frame encryption for Layer 2 networks, IP packet encryption for Layer 3 networks, and Layer 4 data payload encryption for MPLS networks.

The ETEP's variable speed capability lets you enable just the bandwidth you need, using a software license. As your bandwidth needs increase, simply update your license. No need to replace your hardware. The ETEP offer full-duplex, line rate encryption from 3 Mbps to 1 Gbps using the AES-256 encryption algorithm.

**Figure 1 Multipoint Ethernet Encryption using EncrypTight Manager**

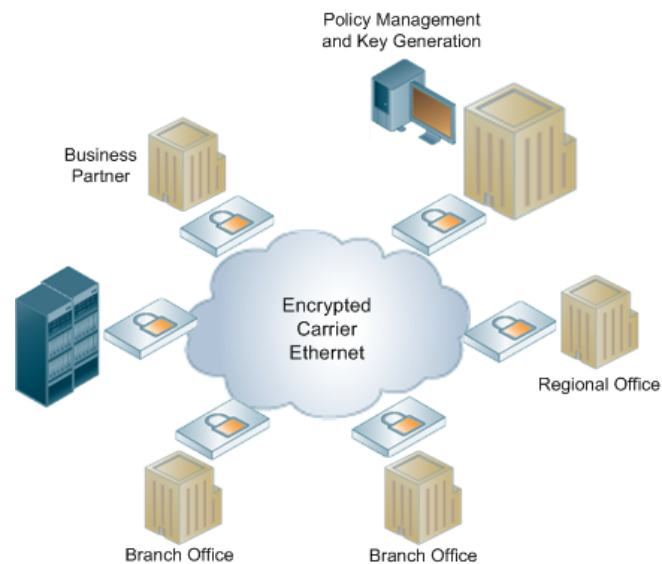

The ETEP interfaces with network equipment through two data ports, the local port and the remote port. Unencrypted traffic that originates from a trusted, local network is received on the local port, where the ETEP applies security processing. Encrypted traffic is sent from the remote port to an untrusted network such as the Internet. At the opposite endpoint, the process is reversed. Encrypted traffic is received on the ETEP remote port and decrypted. The decrypted traffic is sent from the local port to the destination.

The ETEP is managed in-line or out-of-band through a dedicated Ethernet management interface. The ETEP can be managed in two ways, depending on the size and complexity of your deployment:

- Command Line Interface (CLI)

The CLI is all you need to manage a standalone deployment, typically a pair of ETEPs. CLI commands are available to perform initial setup of the ETEP, along with diagnostic and troubleshooting commands. In Layer 2 deployments, you can configure the ETEPs for operation and create Layer 2 point-to-point policies using the CLI commands.

- EncrypTight Manager

EncrypTight Manager is an application for managing group encryption deployments. EncrypTight Manager separates the functions of policy management, key generation and distribution, and policy enforcement. As a result, multiple ETEPs can use common keys. This works for complex mesh, hub and spoke, and multicast networks, as well as in straightforward point-to-point topologies. [Figure 1](#) shows ETEPs deployed in a multipoint Ethernet network.

EncrypTight Manager is a web application and database server that is accessed using a browser-based GUI and supports role-based access. It is through this multi-user web user interface that the ETEP devices are configured and policies defined. EncrypTight Manager handles the policy generation and distribution. EncrypTight Manager offers high availability and the web-based, three-tier architecture scales linearly. EncrypTight Manager is responsible for generating and distributing the key material for use by the ETEP devices. It can be configured to use a Hardware Security Module (HSM) if required for random number generation and other functions. EncrypTight Manager also provides SNMP access to host information, and has the capability to forward logs to an administrator assigned syslog server.

## ET0010A Physical Description

The ET0010A is a rack-mountable encryptor that can run at speeds ranging from 3-50 Mbps. It has two data ports on the front panel labeled Remote and Local. The following sections describe the Black Box ET0010A connectors and LED indicators.

### Front Panel Connectors

The ET0010A front panel connectors are shown in [Figure 2](#).

**Figure 2** ET0010A Front Panel Connectors

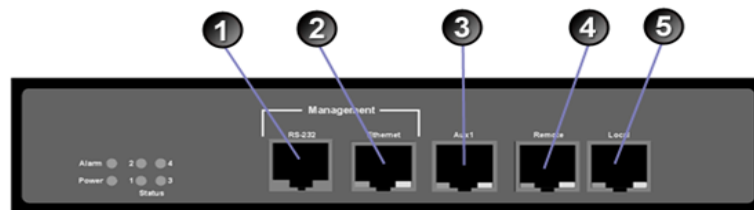

Elements in [Figure 2](#):

- 1) RS-232 management port
- 2) Ethernet management port
- 3) Auxiliary port (not enabled in this release)
- 4) Remote port (encrypted traffic):
- 5) Local port (clear traffic):

## Status Indicators

The ET0010A status indicators are shown in [Figure 3](#). The status indications are described in [Table 1](#).

**Figure 3 ET0010A Status Indicators**



Elements of [Figure 3](#):

- 1) Power LED
- 2) Alarm LED
- 3) Status indicators
- 4) Link indicators

The following table describes how to interpret the ET0010A status indicators.

**Table 1 ET0010A Status Indicators**

Indicator Light	State	Indication
Power (green)	Off	Unit is powered off.
	On	Unit is powered on.
10/100 link status (green) <sup>a</sup>	Off	Loss of signal on the 10/100 link.
	On	The 10/100 link is up but no traffic is passing over the link.
	Blinking	Indicates the presence of traffic on the 10/100 link.
Gigabit link status (amber) <sup>a</sup>	Off	Loss of signal on the Gigabit link.
	On	The Gigabit link is up but no traffic is passing over the link.
	Blinking	Indicates the presence of traffic on the Gigabit link.
Alarm (green)	Off	Normal operation.
	On	The unit is in an error state. This occurs when the diagnostics detect a boot failure, a critical error threshold is exceeded, or a FIPS test fails when the ETEP is in FIPS mode.
Status (1,2,3,4)	Off	Unit is up and operational.
	On	Displays diagnostic codes during boot up.

a. The link status LEDs are on the remote and local data ports, Ethernet management port, and Aux1 port.

## Rear Panel

The ET0010A rear panel and external power supply are shown in [Figure 4](#).

**Figure 4 ET0010A Rear Panel and External Power Supply**

Elements of [Figure 4](#):

- 1) External power supply power connector
- 2) Rear panel power connector

## ET0100A Physical Description

The ET0100A is a rack-mountable encryptor that can run at speeds ranging from 100–250 Mbps. The following sections describe the connectors and LED indicators that appear on the front and rear panels of the ET0100A.

### Front Panel Connectors

The ET0100A front panel connectors are shown in [Figure 5](#).

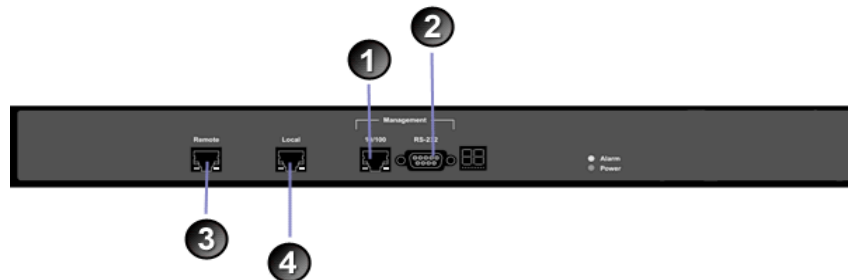
**Figure 5 ET0100A Front Panel Connectors**

Elements of [Figure 5](#):

- 1) Ethernet management port
- 2) RS-232 port
- 3) Remote port (encrypted traffic)
- 4) Local port (clear traffic)

### LED Indicators

The ET0100A LED indicators are shown in [Figure 6](#). The LED indications are described in [Table 2](#).

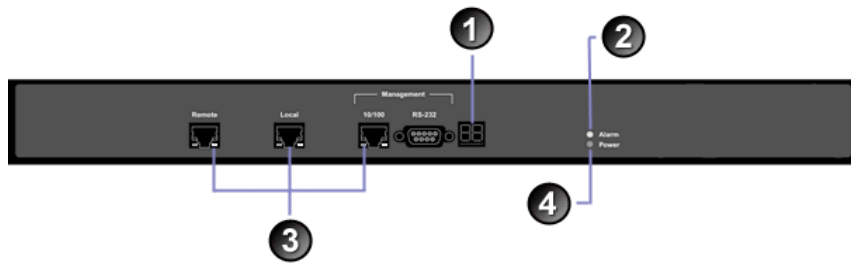
**Figure 6 ET0100A LED Indicators**

Elements of [Figure 6](#):

- 1) Diagnostic display
- 2) Alarm LED
- 3) Link indicators
- 4) Power indicator

The following table describes how to interpret the LEDs on the ET0100A front panel.

**Table 2 ET0100A Front Panel LED Indicators**

Indicator Light	State	Indication
Power (green)	Off	Unit is powered off.
	On	Unit is powered on.
10/100 link status (green) <sup>a</sup>	Off	Loss of signal on the 10/100 link.
	On	The 10/100 link is up but no traffic is passing over the link.
	Blinking	Indicates the presence of traffic on the 10/100 link.
Gigabit link status (amber) <sup>a</sup>	Off	Loss of signal on the Gigabit link.
	On	The Gigabit link is up but no traffic is passing over the link.
	Blinking	Indicates the presence of traffic on the Gigabit link.
Alarm (green)	Off	Normal operation.
	On	The unit is in an error state. This occurs when the diagnostics detect a boot failure, a critical error threshold is exceeded, or a FIPS test fails when the ETEP is in FIPS mode.
Diagnostic code display	On	Displays diagnostic codes during boot up. After boot up, it reflects the operational state of the appliance and error conditions.

a. The link status LEDs are on the remote and local data ports, Ethernet management port, and Aux1 port.

## Rear Panel

The ET0100A rear panel is shown in [Figure 7](#).

**Figure 7 ET0100A Rear Panel**

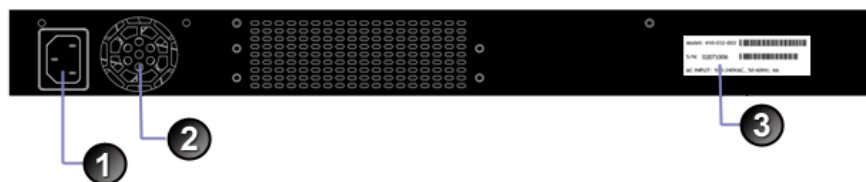

Elements of [Figure 7](#):

- 1) Power receptacle
- 2) Fan
- 3) Product ID label

## ET1000A Physical Description

The ET1000A is a rack-mountable 1 Gbps encryptor with dual power supplies. It can operate at speeds ranging from 500 Mbps–1 Gbps. The following sections describe the ET1000A connectors and LED indicators.

### Front Panel Connectors

The ET1000A front panel connectors are shown in [Figure 8](#).

**Figure 8 ET1000A Front Panel Connectors**

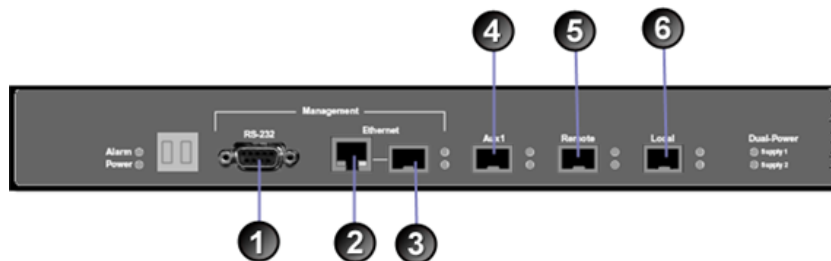

Elements of [Figure 8](#):

- 1) RS-232 serial port
- 2) 10/100 Ethernet management port
- 3) Gigabit Ethernet management port (not enabled in this release)
- 4) Aux1 port (not enabled in this release)
- 5) Remote port (encrypted traffic)
- 6) Local port (clear traffic)

## LED Indicators

The ET1000A LED indicators are shown in [Figure 9](#). The LEDs are described in [Table 3](#).

**Figure 9 ET1000A LED Indicators**

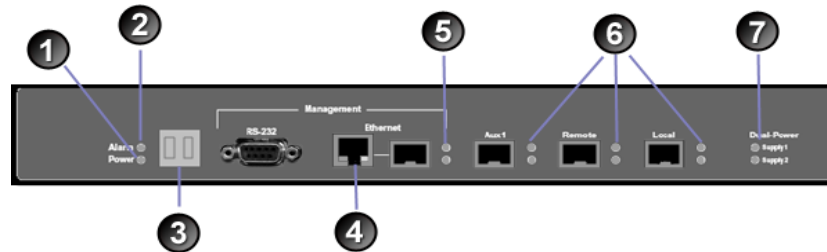

Elements of [Figure 9](#):

- 1) Power LED
- 2) Alarm LED
- 3) Diagnostic display
- 4) Link indicators: 10/100 Ethernet management port
- 5) Link indicators: Gigabit management port
- 6) Link indicators: Aux1, Remote and Local ports
- 7) Power supply status LEDs

[Table 3](#) describes how to interpret the LEDs on the ET1000A front panel.

**Table 3 ET1000A Front Panel LED Indicators**

Indicator Light	State	Indication
Power (green)	Off	Unit is powered off.
	On	Unit is powered on.
Alarm (green)	Off	Normal operation.
	On	The unit is in an error state. This occurs when the diagnostics detect a boot failure, a critical error threshold is exceeded, or a FIPS test fails when the ETEP is in FIPS mode.
Diagnostic code display	On	Displays diagnostic codes during boot up. After boot up, it reflects the operational state of the appliance and error conditions.
10/100 link status (green)	Off	Loss of signal on the 10/100 link.
	On	The 10/100 link is up but no traffic is passing over the interface.
	Blinking	Indicates the presence of traffic on the 10/100 link.
Gigabit link status (green) <sup>a</sup>	Off	Loss of signal on the Gigabit link.
	On	The Gigabit link is up but no traffic is passing over the interface link.
	Blinking	Indicates the presence of traffic on the Gigabit link.

**Table 3 ET1000A Front Panel LED Indicators**

Indicator Light	State	Indication
Power supply status	Off	Power supply is not operational. Possible causes include power supply unplugged, power supply removed from chassis, or a malfunction.
	On	Power supply is operational.

a. Gigabit links include the remote and local data ports, gigabit Ethernet management port, and Aux1 port.

## Rear Panel

The ET1000A rear panel is shown in [Figure 10](#).

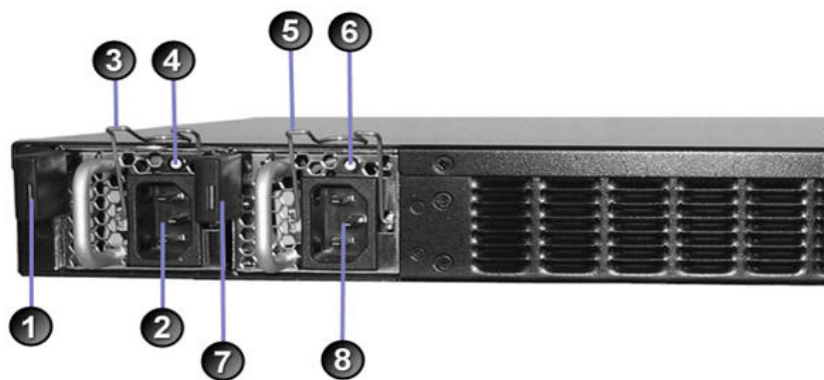
**Figure 10 ET1000A Rear Panel**

Elements of [Figure 10](#):

### Power Supply # 2

- 1) Release lever for power supply 2
- 2) Power supply 2 receptacle
- 3) Power cord clip for power supply 2
- 4) Status LED for power supply 2. Green indicates normal operation. Red indicates a power fail state.

### Power Supply # 1

- 5) Power cord clip for power supply 1
- 6) Status LED for power supply 1. Green indicates normal operation. Red indicates a power fail state.
- 7) Release lever for power supply 1
- 8) Power supply 1 receptacle



# ET10000A Physical Description

The ET10000A is a rack-mountable 10 Gbps encryptor with dual power supplies. It can operate at speeds ranging from 2.5–10 Gbps. The following sections describe the ET10000A connectors and LED indicators.

## Front Panel Connectors

The ET10000A front panel connectors are shown in [Figure 11](#).

**Figure 11 ET10000A Front Panel Connectors**

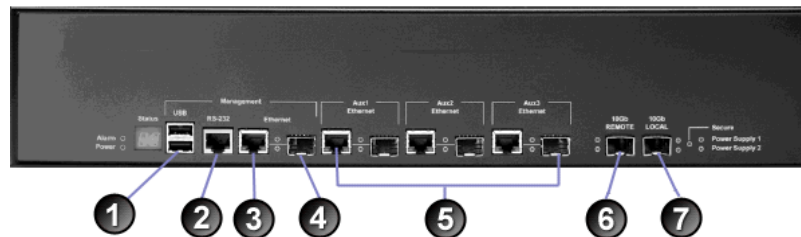

Elements of [Figure 11](#):

- 1) USB management port (not enabled in this release)
- 2) RS-232 serial port
- 3) 10/100 Ethernet management port
- 4) Gigabit Ethernet management port (not enabled in this release)
- 5) Aux ports (not enabled in this release)
- 6) Remote port (encrypted traffic)
- 7) Local port (clear traffic)

## LED Indicators

The ET10000A LED indicators are shown in [Figure 12](#). The LEDs are described in [Table 4](#).

**Figure 12 ET10000A LED Indicators**

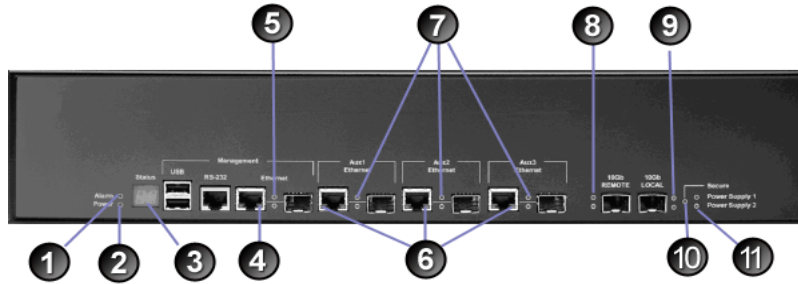

Elements of [Figure 12](#):

- 1) Alarm LED
- 2) Power LED
- 3) Diagnostic display
- 4) Link indicators: 10/100 Ethernet management port
- 5) Link indicators: Gigabit management port
- 6) Link indicators: 10/100 Ethernet Aux ports
- 7) Link indicators: Gigabit Aux ports
- 8) Link indicators: Remote port
- 9) Link indicators: Local port
- 10) Secure traffic LED
- 11) Power supply status LEDs

[Table 4](#) describes how to interpret the LEDs on the ET10000A front panel.

**Table 4 ET10000A Front Panel LED Indicators**

Indicator Light	State	Indication
Power (green)	Off	Unit is powered off.
	On	Unit is powered on.
Alarm (green)	Off	Normal operation.
	On	The unit is in an error state. This occurs when the diagnostics detect a boot failure, a critical error threshold is exceeded, or a FIPS test fails when the ETEP is in FIPS mode.
Diagnostic code display	On	Displays diagnostic codes during boot up. After boot up, it reflects the operational state of the appliance and error conditions.
10/100 link status (green)	Off	Loss of signal on the 10/100 link.
	On	The 10/100 link is up but no traffic is passing over the interface.
	Blinking	Indicates the presence of traffic on the 10/100 link.

**Table 4 ET10000A Front Panel LED Indicators**

Indicator Light	State	Indication
Gigabit link status (green) <sup>a</sup>	Off	Loss of signal on the Gigabit link.
	On	The Gigabit link is up but no traffic is passing over the interface link.
	Blinking	Indicates the presence of traffic on the Gigabit link.
Power supply status	Off	Power supply is not operational. Possible causes include power supply unplugged, power supply removed from chassis, or a malfunction.
	On	Power supply is operational.

a. Gigabit links include the remote and local data ports, gigabit Ethernet management port, and Aux1 port.

## Rear Panel

The ET10000A rear panel is shown in [Figure 13](#).

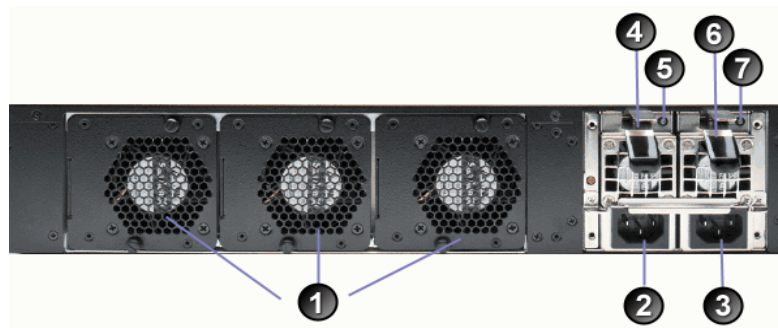
**Figure 13 ET10000A Rear Panel**

Elements of [Figure 13](#):

1) Fans

### Power Supply # 2

2) Power supply 2 receptacle

4) Release lever for power supply 2

5) Status LED for power supply 2. Green indicates normal operation. Red indicates a power fail state.

### Power Supply # 1

3) Power supply 1 receptacle

6) Release lever for power supply 1

7) Status LED for power supply 1. Green indicates normal operation. Red indicates a power fail state.

## Features

ETEPs share many of the same features and capabilities across hardware models, as shown in [Table 6](#). Hardware differences between the ETEP models are summarized in [Table 5](#).

**Table 5 ETEP Hardware Comparison**

Model	Form Factor	Data Port Speed	Data Port Interface	Mgmt Port Interface	Auxiliary port	Dual Power Supplies
<b>ET0010A</b>	1u rack-mount	(2) 3–50 Mbps	RJ-45	RJ-45	Yes	No
<b>ET0100A</b>	1u rack-mount	(2) 100–250 Mbps	RJ-45	RJ-45	No	No
<b>ET1000A</b>	1u rack-mount	(2) 500–1000 Mbp	SFP	RJ-45 and SFP	Yes	Yes
<b>ET10000A</b>	2 u rack-mount	(2) 2.5-10 Gbps	SFP	RJ-45, SFP, USB	Yes (3)	Yes

The ETEP features are summarized in [Table 6](#).

**Table 6 ETEP Feature Summary**

Category	Feature
Throughput	<ul style="list-style-type: none"> <li>ET0010A: Supports encrypted throughput rates of 3, 6, 10, 25 and 50 Mbps</li> <li>ET0100A: Supports encrypted throughput rates of 100, 155, and 250 Mbps</li> <li>ET1000A and ET1000A: Support encrypted throughput rates of 500, 650, and 1000 Mbps</li> <li>ET10000A: Supports encrypted throughput rates of 2.5, 5, and 10 Gbps</li> </ul>
Encryption Support	<ul style="list-style-type: none"> <li>Advanced Encryption Standard (AES): FIPS 197 (256 bit keys)</li> <li>3DES: ANSI X9.52 (168 bit keys), standard CBC mode</li> <li>User-configurable for Layer 2 Ethernet or Layer 3 IP encryption, with option to encrypt only the Layer 4 payload</li> </ul>
Authentication Methods	<ul style="list-style-type: none"> <li>X.509 v3 digital certificates (management interface)</li> <li>HMAC-SHA-1-96</li> <li>HMAC-MD5-96</li> </ul>
Encapsulation Modes	<ul style="list-style-type: none"> <li>Layer 2: Ethernet payload encryption</li> <li>Layer 3: IPSec Tunnel mode with original IP header preservation</li> <li>IPSec Transport mode for Layer 4 payload encryption option</li> </ul>

**Table 6 ETEP Feature Summary**

Category	Feature
Device Management	<ul style="list-style-type: none"> <li>• EncrypTight Manager software for device and policy management</li> <li>• Out-of-band management</li> <li>• Alarm condition detection and reporting</li> <li>• Syslog support</li> <li>• SNMPv2c and SNMPv3 managed object support</li> <li>• Audit logging</li> <li>• Management access using X.509 v3 digital certificates</li> <li>• Security options include TLS, SSH, IKE/IPsec</li> </ul>
Network Support	<ul style="list-style-type: none"> <li>• Ethernet</li> <li>• VLAN tag preservation</li> <li>• MPLS tag preservation</li> <li>• Jumbo frame support</li> <li>• Link state pass-through</li> <li>• IPv4</li> <li>• IPv6 (Layer 2 Ethernet encryption mode)</li> <li>• NTP</li> <li>• Host or gateway packet reassembly option</li> </ul>
Policy Selector Options	<ul style="list-style-type: none"> <li>• Source or destination IP address</li> <li>• Source or destination port number</li> <li>• Protocol ID (Layer 3 IP packet and Layer 4 payload options)</li> <li>• VLAN ID (Layer 2 encryption option)</li> <li>• Multicast address</li> </ul>

## Specifications

This section lists the mechanical and environmental specifications for the following ETEP models:

- ET0010A specifications are listed in [Table 7](#)
- ET0100A specifications are listed in [Table 8](#)
- ET1000A specifications are listed in [Table 9](#)
- ET10000A specifications are listed in [Table 10](#)

**Table 7 ET0010A Mechanical and Environmental Specifications**

Category	Specification
Interfaces	(2) 10/100 Mbps Ethernet ports for encrypting and decrypting traffic (1) 10/100 Mbps Ethernet auxiliary port 10/100/1000 Mbps auto-sensing Ethernet LAN port for management RS-232 port for management

**Table 7 ET0010A Mechanical and Environmental Specifications**

Category	Specification
ET0010A Electrical/Mechanical Dimensions	19 inch rack mount design 1u tamper evident chassis Dimensions: 1.6" H x 9.1" W x 7.1" D Weight (without external power supply), 1 pound 10 ounces External power supply: <ul style="list-style-type: none"> <li>• Weight: 11 ounces</li> <li>• Input voltage: 100-240 VAC @ 1.8 amps, 50/60 Hz, auto-sensing</li> <li>• Output voltage: 12 VDC @ 5 amps</li> </ul> Nominal input current: 0.3 amps Nominal power dissipation: 36 watts Thermal power: In-rush 123 BTU/hour, steady state 123 BTU/hour
Environmental	Operating temperature: 0 to 40 degrees C (32 to 104 degrees F) Operating humidity: Up to 90% (non-condensing) Operating altitude: -200 to 10,000 feet AMSL
Regulatory	See <a href="#">"ET0010A Regulatory Information" on page 78.</a>

**Table 8 ET0100A Mechanical and Environmental Specifications**

Category	Specification
Interfaces	(2) 10/100/1000 Mbps Ethernet ports for encrypting and decrypting traffic 10/100 Mbps auto-sensing Ethernet LAN port for management RS-232C port for management
Electrical/Mechanical Dimensions	19 inch rack mount design 1U tamper evident chassis Dimensions: 1.75" H x 17" W x 10" D Weight: 6 pounds 100-240 VAC @ 4 amps, 50/60 Hz, auto-sensing Nominal input current: 1.0A Nominal power dissipation: 65 watts Thermal power: In-rush 380 BTU/hour, steady state 140 BTU/hour
Environmental	Operating temperature: 0 to 40 degrees C (32 to 104 degrees F) Operating humidity: Up to 90% (non-condensing) Operating altitude: -200 to 10,000 feet AMSL
Regulatory	See <a href="#">"ET0100A Regulatory Information" on page 79.</a>

**Table 9 ET1000A Mechanical and Environmental Specifications**

Category	Specification
Interfaces	(2) Gigabit Ethernet ports for encrypting and decrypting traffic (single mode, multimode, or copper) 10/100 Mbps auto-sensing Ethernet LAN port for management RS-232C port for management (1) Auxiliary Gigabit port for data traffic (not enabled) (1) Gigabit Ethernet port for management (not enabled)
ET1000A Electrical/Mechanical Dimensions	19 inch rack mount design 1U tamper evident chassis Dimensions: 1.75" H x 17" W x 10" D Weight: 6 pounds 100-240 VAC @ 4 amps, 50/60 Hz, auto-sensing Nominal power dissipation: 65 watts Nominal input current: 1.0A Thermal power: In-rush 310 BTU/hour, steady state 280 BTU/hour
ET1000A Electrical/Mechanical Dimensions	19 inch rack mount design 1U tamper evident chassis Dimensions: 1.75" H x 17" W x 15.5" D Weight: 10 pounds 100-240 VAC @ 3-1.5A, 47-63 Hz, auto-sensing Nominal input power: 72 watts Maximum power: 90 watts Nominal input current: 0.65 A @ 110V Thermal power, single power supply: In-rush 266 BTU/hour, steady state 222 BTU/hour Thermal power, dual power supplies: In-rush 440 BTU/hour, steady state 263 BTU/hour
Environmental	Operating temperature: 0 to 40 degrees C (32 to 104 degrees F) Operating humidity: Up to 90% (non-condensing) Operating altitude: -200 to 10,000 feet AMSL
Regulatory	See <a href="#">"ET1000A Regulatory Information"</a> on page 81 and <a href="#">"ET1000A Regulatory Information"</a> on page 81.

**Table 10 ET10000A Mechanical and Environmental Specifications**

Category	Specification
Interfaces	(2) 10 Gigabit Ethernet ports for encrypting and decrypting traffic (single mode, multimode, or copper) 10/100 Mbps auto-sensing Ethernet LAN port for management RS-232C port for management (3) Auxiliary Gigabit LAN ports (not enabled) (3) Auxiliary 10/100 Ethernet LAN ports (not enabled) (1) Gigabit Ethernet port for management (not enabled) (1) USB port for management (not enabled)
Mechanical Dimensions	19 inch rack mount design 2U tamper evident chassis Dimensions: 3.5" H x 17" W x 20" D Weight: 18 pounds
Electrical: AC power supplies	Voltage: 90 - 264 VAC Full Range Frequency: 47 - 63 Hz Input Current: 6.0 / 3.0 A for 115 / 230 VAC Inrush Current: 60A / 80A MAX. FOR 115 / 230 VAC Per Power Module MAX Input Power: 350W
Electrical: DC power supplies	Voltage: DC -36 V - -72 V Input Current: 12A Maximum for -48VDC Inrush Current: 20A MAX for each power unit MAX Input Power: 350W
Environmental	Operating temperature: 0 to 40 degrees C (32 to 104 degrees F) Operating humidity: Up to 90% (non-condensing) Operating altitude: -200 to 10,000 feet AMSL
Regulatory	See <a href="#">"ET10000A Regulatory Information"</a> on page 82.

## MIB Support

This section identifies the Black Box MIBs and standard MIBs that are used to manage ETEP appliances. The MIBs can be loaded into a management station SNMP client application, which typically includes a MIB browser and an SNMP trap receiver. The SNMP management application uses the MIBs to interpret the SNMP queries made on the appliance and to interpret SNMP traps generated by the appliance.

The ETEP supports the MIBs listed in [Table 11](#). In some cases MIB objects are supported only to the extent that they return values when a MIB walk is performed on the appliance. Refer to the MIBs themselves, which are included on the software CD, for details about the MIB objects and expected behavior.

To learn more about the traps that the ETEP generates and how to configure them, see the "ETEP Configuration" chapter in the *EncryptTight Manager User Guide*.



**Table 11 ETEP MIBs**

Module	Filename
BLACKBOX-SMI	BLACKBOX-SMI.txt
BLACKBOX-CRYPTO-MIB	BLACKBOX-CRYPTO-MIB.txt
SNMPv2-CONF	SNMPv2-CONF.txt
SNMPv2-MIB	SNMPv2-MIB.txt
SNMPv2-SMI	SNMPv2-SMI.txt
SNMPv2-TC	SNMPv2-TC.txt



# 2 Installation

---

## Safety Guidelines

The ETEP does not contain any field-replaceable internal parts. Do not remove the unit's cover for any reason. The cover is to be removed only by authorized Black Box service personnel.

Authorized service personnel should review the following safety information prior to performing service or maintenance procedures on the ETEP.

### CAUTION

---

*Disconnect all power cords before servicing.*

### WARNING

---

*The ETEP contains a lithium battery, which users should not attempt to replace. Battery replacement must be performed by qualified Black Box personnel. Risk of explosion if battery is replaced by an incorrect type. Used batteries should be disposed of according to the manufacturer's instructions.*

### CAUTION

---

*Electrostatic discharge (ESD) can damage electronic components and equipment. ESD occurs when electronic components are improperly handled and can result in complete or intermittent failures. Always follow ESD-prevention procedures when removing and replacing components.*

Qualified service personnel should use the following guidelines to prevent ESD damage:

- Always use an ESD wrist or ankle strap and ensure that it makes skin contact.
- Connect the equipment end of the strap to an unpainted metal chassis surface.
- If no wrist strap is available, ground yourself by touching the metal chassis.

## Software Requirements

ETEP software is factory installed on the appliance. A backup copy of the software is provided on the ETEP CD. To learn how to reinstall your software or install an update, refer to the user guide for your management software.

If you are using EncrypTight Manager to manage your ETEPs, you will need to install the EncrypTight Manager software on the management station to configure the ETEPs for network operation and to create and deploy policies. See the *EncrypTight Manager User Guide* for more information about using ETEPs with the EncrypTight Manager system.

The third party software listed in [Table 12](#) is used when managing the ETEP in a standalone deployment. See the *EncrypTight Manager User Guide* for additional third party software you may want to install when using in EncrypTight Manager to manage Black Box appliances.

**Table 12 Third party management station software**

Software	How it's used	Vendor
FTP server	Copies files to and from Black Box appliances, including log files and new firmware	Microsoft FTP server, included with Windows XP
SFTP server (optional: available with ETEP 1.6 and later)	Secures file transfers to and from Black Box appliances	Cerberus FTP Server 4 – Professional Edition
PDF reader	Opens the user documentation files on the product CD	Adobe Acrobat Reader version 6.0 or higher. Free download available from <a href="http://www.adobe.com">www.adobe.com</a> .
SSH client (ETEPs)	Securely connects to the ETEP CLI	PuTTY, included with the EncrypTight Manager installation

## ETEP Site Preparation

Most ETEP models can be mounted in a standard 19-inch rack using the supplied mounting kit, or simply placed on a rack shelf or solid surface. Before installing the ETEP in a 19-inch rack, consider the following guidelines:

- *Ambient temperature*

Install the ETEP in an environment compatible with the 40°C maximum recommended ambient temperature. Extra clearance above or below the unit on the rack is not required; however, be aware that equipment placed in the rack beneath the ETEP can add to the heat load. Therefore, avoid installing in an overly congested rack. Air flowing to or from other equipment in the rack might interfere with the normal flow of cooling air through the ETEP, increasing the potential for overheating.

- *Air flow*

Make sure that there is sufficient flow of air around the ETEP so that safe operation is not compromised. Maintain a clearance of at least 3 inches (7.62 cm) at the sides of the ETEP to ensure adequate air intake and exhaust. If installing in an enclosed rack, make sure the rack has adequate ventilation or an exhaust fan. An enclosed rack with a ventilation system that is too powerful can prevent proper cooling by creating negative air pressure around the ETEP.

- *Mechanical Loading*

Keep the center of gravity in the rack as low as possible. This ensures that the weight of the ETEP will not make the rack unstable. Make sure that the rack is secured and use the proper mounting hardware to secure the ETEP to the rack.

- *Circuit Loading*

Consider the connection of the ETEP to the supply circuit and the effect that overloading of circuits might have on overcurrent protection and supply wiring. Consult the voltage and amperage ratings on the UL label affixed to the unit's rear panel when addressing this concern.

- *Grounding*  
Maintain reliable grounding of a rack-mounted ETEP. Pay particular attention to supply connections other than direct connections to the branch circuit, such as the use of power strips.
- *Maintenance*  
Allow at least 19 inches (48.3 cm) of clearance at the front of the rack for maintenance. Use a cable-management system to help keep cables organized, out of the way, and free from kinks or bends that degrade cable performance.

## Firewall Ports

[Table 13](#) lists the protocols that are used by the ETEPs and the EncrypTight Manager system. Make sure that any firewalls in your system are configured to allow for the protocols that are required for your deployment: standalone ETEPs used for point-to-point encryption or ETEPs used in the EncrypTight Manager system.

**Table 13** Firewall ports

Protocol	Port	Description	Standalone ETEPs	EncrypTight Manager
FTP	TCP 20, 21	Used for upgrading the software on the ETEP and retrieving appliance log files.	Yes	Yes
ICMP/Ping		Used to check connectivity with a device.	Yes	Yes
IKE / ISAKMP	UDP 500	Used to establish security associations in IKE policies.	Yes	
IPSec ESP	IP protocol 50	Used in encryption policies.	Yes	Yes
SFTP	TCP 22	Used for secure FTP operations.	Yes	Yes
SNMP	UDP 161, 162	Used to send SNMP traps from the ETEPs to a management workstation.		Yes
SNTP	UDP 123	Used for time synchronization among EncrypTight Manager components.		Yes
SSH	TCP 22	Used to securely access the CLI on ETEPs.	Yes	Yes
Syslog	UDP 514	Used to send syslog messages from the ETEPs to a syslog server.		Yes
TLS (HTTPS)	TCP 443	A secure method of communicating management information between EncrypTight Manager and the ETEPs.		Yes
XML-RPC	TCP 443	Used for communications between EncrypTight Manager components.		Yes

## Installation Instructions: ET0010A

The ET0010A can be mounted in a standard 19-inch rack using the mounting kit, or simply placed on a rack shelf or solid surface. Before installing the ETEP in a 19-inch rack, review the mounting guidelines listed in [“ETEP Site Preparation”](#) on page 28.

## Rack Mount Installation

To mount the ETEP in a standard 19-inch equipment rack, have the following tools and materials available:

- External power supply
- Two mounting brackets, supplied in the Accessory Kit
- (4) small black screws and (4) large #10-32 screws, supplied in the Accessory Kit
- #1 Phillips and #2 Phillips screwdrivers (user-supplied)

### To install the ETEP in a rack:

- 1 Place the unit on a solid surface, with the bottom panel facing up.

When looking at the ET0010A from the bottom rear, the bracket that holds the power supply is on the right, as shown in [Figure 14](#).

On the ET0010A, the bracket that holds the power supply is on the left.

**Figure 14** Bottom rear view of the ET0010A, with rack mount brackets

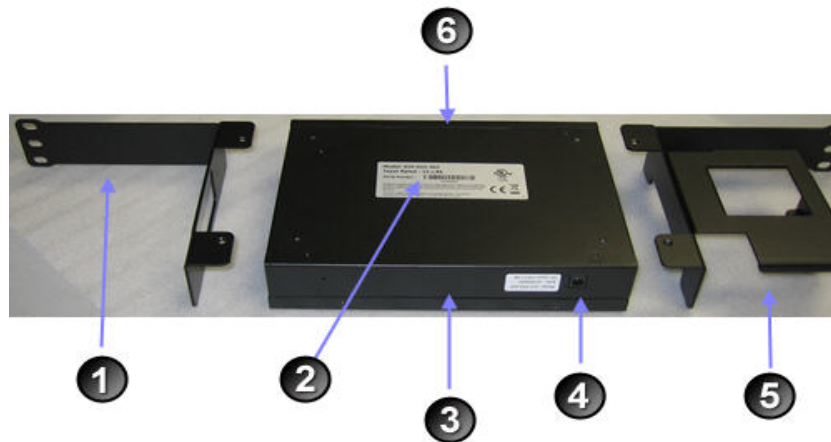

Elements of [Figure 14](#):

- 1) Mounting bracket
- 2) Regulatory label on the bottom of the unit
- 3) Rear panel
- 4) Power supply connector
- 5) Mounting bracket with power supply cradle
- 6) Front panel

- 2 Attach the mounting brackets to each side of the unit using the four small black screws provided in the Accessory Kit (item 2 in [Figure 23](#)), and a #1 Phillips screwdriver.

When looking at the ET0010A-402 from the bottom rear, the bracket that holds the power supply is on the right, as shown in [Figure 15](#).

On the ET0010A, the bracket that holds the power supply is on the left.

**Figure 15** Attach mounting brackets to the bottom panel. ET0010A is shown below.

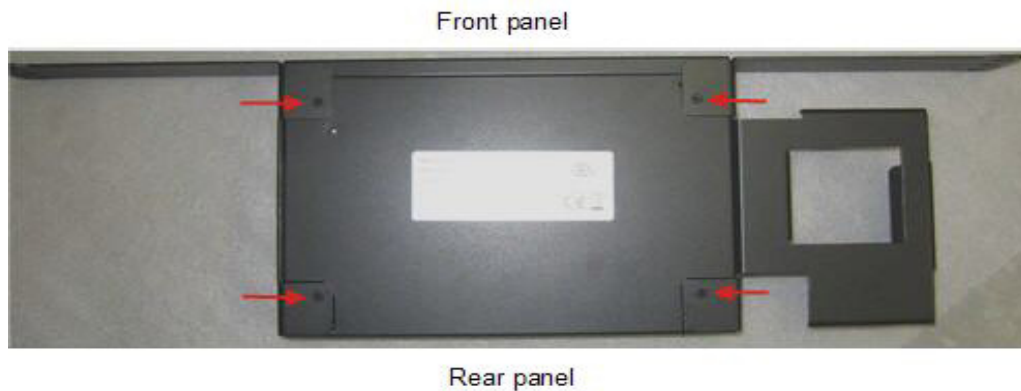

- 3 Turn the ETEP face up and locate the external power supply. With the label side facing down, place the power supply in the mounting bracket cradle and snap it into place, as shown in [Figure 16](#).

**Figure 16** Power supply installed in mounting bracket cradle on the ET0010A

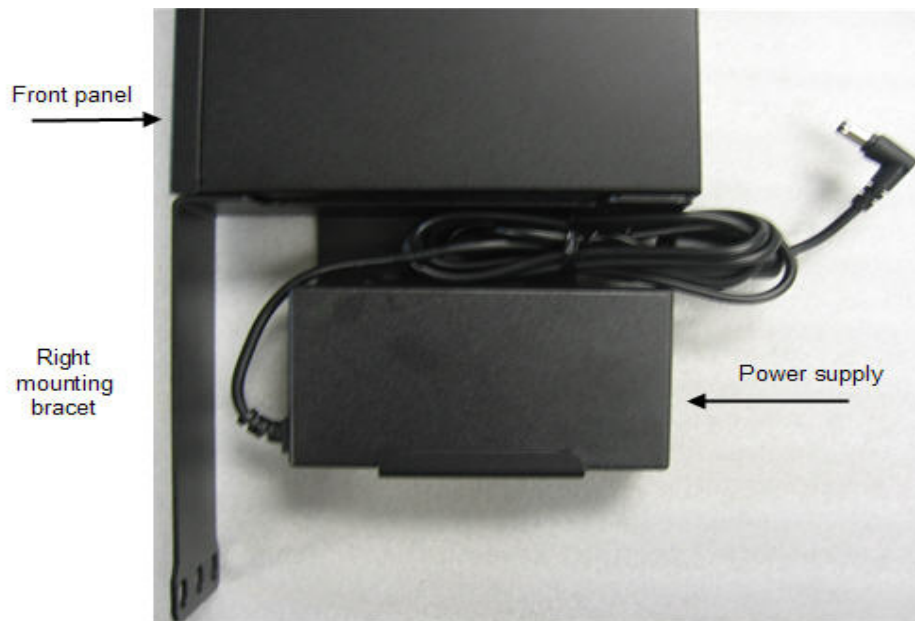

- 4 Connect the power supply cable to the rear panel connector.  
[Figure 17](#) shows the ET0010A-402 power connector. On the ET0010A, the power connector is located on the right side of the rear panel.

**Figure 17** Insert the power supply cable into the connector on the rear panel



- 5 Attach the mounting brackets to the rack's front supports with the large #10-32 screws (item 1 in [Figure 23](#)), using a #2 Phillips screwdriver. Insert two screws in each bracket, using the top and bottom holes.

**Figure 18** Front view of ET0010A mounting brackets and power supply



## Solid Surface Installation

When installing the ET0010A on a solid surface, have the following tools and materials available to attach the rubber feet to the bottom of the unit:

- External power supply
- (4) rubber feet, supplied in the Accessory Kit (item 3 in [Figure 23](#)).
- (4) small silver screws with built-in washers, supplied in the Accessory Kit (item 4 in [Figure 23](#)).
- #1 Phillips screwdriver (user-supplied)

### To install the ETEP on a solid surface:

- 1 Place the unit on a solid surface, with the bottom panel facing up.
- 2 Locate the four screw holes on the bottom of the unit ([Figure 19](#)).



**Figure 19** Screw holes for rubber feet installation on bottom of unit



- 3 Place one of the rubber feet over the hole and insert a screw into the opening (Figure 20). Tighten the screw.

**Figure 20** Rubber feet installed



- 4 Repeat step 3 for the remaining feet.
- 5 Turn the unit over so that it is resting on the rubber feet.
- 6 Attach the external power supply to the power connector on the rear panel.

Figure 21 shows the ET0010A-402 rear panel and power supply. On the ET0010A, the power connector is located on the right side of the rear panel.

**Figure 21 ET0010A rear panel connector for external power supply.**



## Connecting the Cables: ET0010A

Follow the instructions below to connect the ET0010A to the appropriate network devices (see [Figure 22](#)).

### To cable the ET0010A:

- 1 For initial setup, connect the RS-232 serial port directly to a PC or workstation. Using the null modem cable supplied by Black Box, insert the RJ-45 connector in the RS-232 port and connect the DB-9 female connector to your PC. This cable can be removed after initial setup is complete.
- 2 Connect the Ethernet management port to a LAN using a Category 5 cable with an RJ-45 connector.
- 3 Connect the remote port to the untrusted network, typically via a router port, using a Category 5 cable with an RJ-45 connector.
- 4 Connect the local port to the local device, such as a server or switch, using a Category 5 cable with an RJ-45 connector.

**Figure 22 ET0010A Cabling**

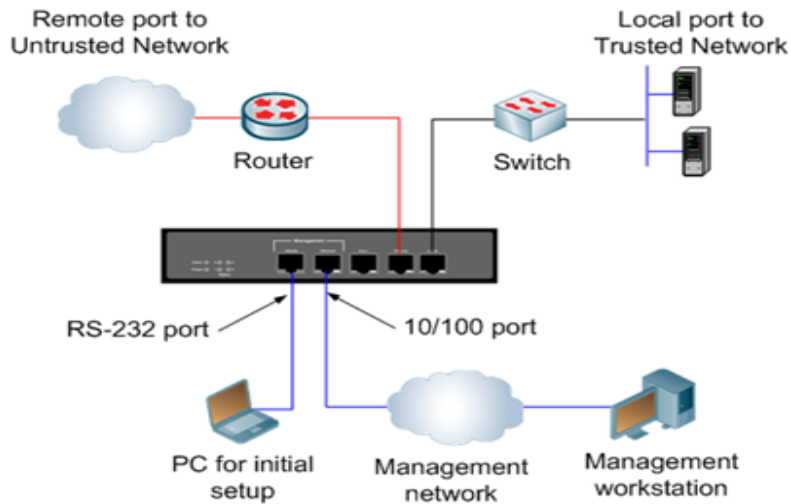

**NOTE**

The Aux1 port on the ET0010A is not enabled in this release.

## Powering On the ET0010A

Use the following procedure to power up the ETEP.

**Figure 23 Attaching the power cables on the ET0010A-402**



**To power on the ETEP:**

- 1 Check that the power supply cable is properly inserted in the power connector on the ETEP rear panel. The ET0010A-402 is shown in [Figure 23](#). On the ET0010A, the power connector is on the right side of the rear panel.
- 2 Plug the power cord into the ETEP power supply. Attach the opposite end to a power source to apply power to the appliance.

When the appliance powers up, all LEDs illuminate. The power LED remains lit until the unit is powered off.

During the boot process the ETEP cycles through its startup tests, and the corresponding status LEDs are illuminated. After the tests execute successfully, the status indicators turn off.

 **NOTE**

*During the boot process the ETEP discards all traffic on its data ports. Once the appliance is operational, the default mode of operation passes all packets in the clear until you deploy security policies.*

## Installing the ET0100A

To prepare the ET0100A for installation, review the installation steps in [Table 14](#), unpack the shipping carton, and prepare a space for the installation of the appliance.

The steps to perform for a typical installation are listed below.

**Table 14 ET0100A Installation Steps**

Step	Action to Perform	Description
1	Review the cabling requirements.	<a href="#">on page 36</a>
2	Unpack the shipping package.	<a href="#">on page 37</a>
3	Prepare a space for installation of the ET0100A.	<a href="#">on page 37</a>
4	Connect the cables.	<a href="#">on page 38</a>
5	Apply power to the ET0100A.	<a href="#">on page 39</a>

## Cabling Requirements: ET0100A

[Table 15](#) outlines the standard cables used with each port on the ET0100A. The connector type listed indicates only what is required to connect to the ET0100A port, and may or may not be the same connector type required for the other end of the cable. Some cables are supplied by Black Box and others are user-supplied.

**Table 15 ET0100A Standard Cables**

ET0100A Port	Cabling	Supplied by...
Power receptacle	Power supply cable certified and approved for use in the country of interest	Black Box
RS-232 Port	Shielded copper null modem cable, RS-232 DB9 connector (female to male)	Black Box
10/100 Ethernet Management Port	Shielded Category 5 straight through cable (STP), RJ-45 connector <sup>a</sup>	Black Box

**Table 15 ET0100A Standard Cables**

ET0100A Port	Cabling	Supplied by...
Remote and Local ports	Shielded Category 5 straight through cables (STP), RJ-45 connector <sup>a</sup>	User

- a. The local, remote, and Ethernet management ports are auto-sensing for polarity. You can use shielded Category 5 straight through cables or crossover cables when connecting to these ports.

 **NOTE**

To meet the requirements of FCC Part 15 and the EU EMC Directive 2004/108/EC, use only shielded cables with the ET0100A (DB-9 null modem cables and Category 5 STP cables).

## Unpacking the Shipping Carton: ET0100A

Remove all product components from the shipping carton and compare the contents to the packing list. Keep all packaging in case it is necessary to return the unit.

The ET0100A is packaged with the standard items listed below. Additional cables, country-specific power cords, and other accessories can be ordered separately.

- 1 ET0100A chassis
  - Firmware and software is factory-installed on the unit.
- 2 Accessory Kit
  - Rack mount kit containing two mounting brackets and 10 screws
  - (1) Power cable (US)
  - (1) Shielded DB-9 null modem cable (female to male)
  - (1) Shielded Category 5 straight through cable (STP) with RJ-45 connector
  - CD containing user documentation and a backup copy of the ETEP software

## Rack-Mount Installation: ET0100A

The ET0100A can be mounted in a standard 19-inch rack using the mounting kit, or simply placed on a rack shelf or solid surface. Before installing the ET0100A in a 19-inch rack, review the rack-mounting guidelines listed in [“ETEP Site Preparation” on page 28](#).

To mount the ETEP in a standard 19-inch equipment rack, have the following tools and materials available:

- Two mounting brackets, supplied in the Accessory Kit
- (6) small screws and (4) large screws, supplied in the Accessory Kit
- #1 Phillips and #2 Phillips screwdrivers (user-supplied)

**To install the ETEP in a rack:**

- 1 Attach a mounting bracket to each side of the ETEP (near the front panel). Attach each bracket with three small screws provided in the Accessory Kit, using a #1 Phillips screwdriver.
- 2 Attach the ETEP to the rack's front supports with the large screws, using a #2 Phillips screwdriver (Figure 24). Insert two screws in each bracket, using the top and bottom holes.

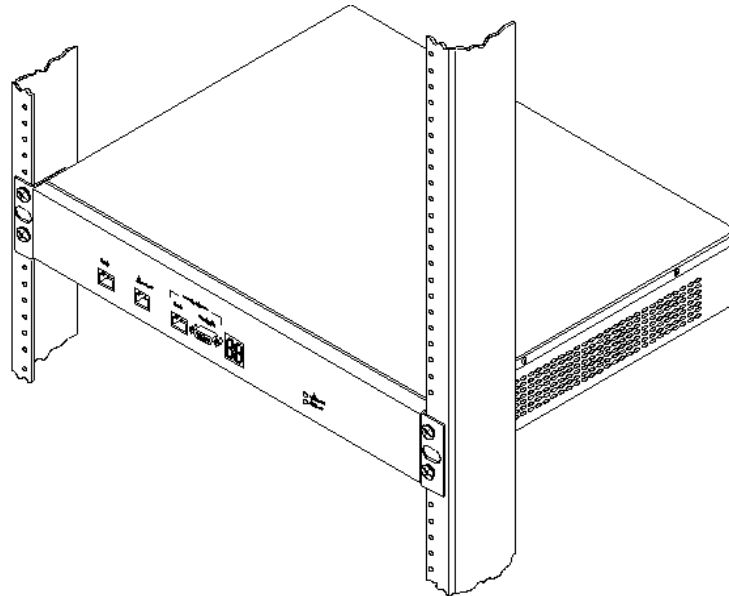
**Figure 24 Rack Mounted ETEP, Front Panel View**

## Connecting the Cables: ET0100A

The procedure in this section describes how to connect the ET0100A to your network devices, as shown in Figure 25.

**To cable the ET0100A:**

- 1 For initial setup, connect the RS-232 port directly to a PC or workstation using a DB-9 null modem cable. This cable can be removed after initial setup is complete.
- 2 Connect the 10/100 Ethernet management port to a LAN using a Category 5 shielded twisted pair (STP) cable with an RJ-45 connector.
- 3 Connect the remote port to the untrusted network, typically via a router port, using a Category 5 STP cable with an RJ-45 connector.
- 4 Connect the local port to the local device, such as a server or switch, using a Category 5 STP cable with an RJ-45 connector.

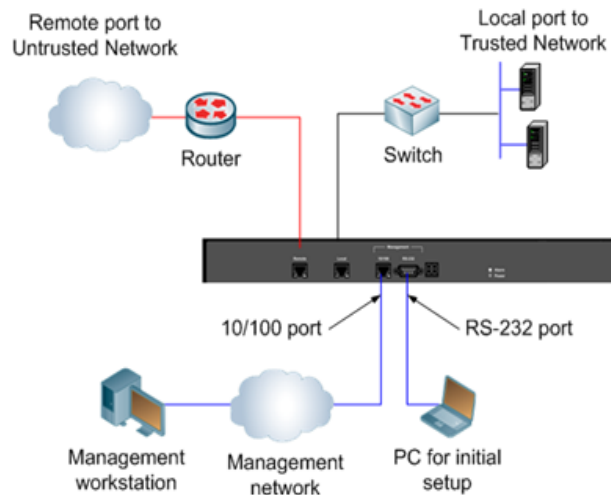
**Figure 25 ET0100A Cabling**

## Powering on the ET0100A

Use the following procedure to power up the ET0100A.

### To power on the ET0100A:

- On the appliance's rear panel, plug the power cord into the ET0100A power receptacle. Attach the opposite end to a power source to apply power to the appliance.

Due to the shielding in the power cable, you must exert significant pressure to properly insert the power cord into the ET0100A power receptacle. A properly seated power cord cannot be moved within the receptacle (Figure 26). Wiggling or jostling an improperly seated power cord may cause the appliance to reboot (Figure 27).

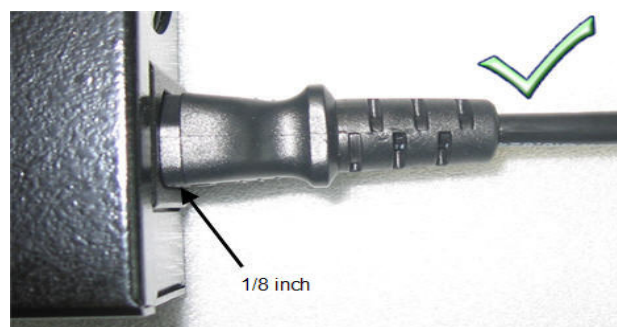
**Figure 26 Properly seated ET0100A power cable**

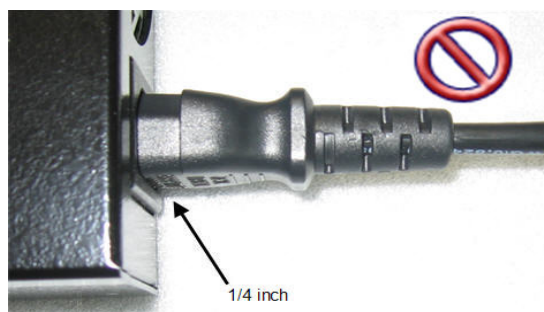
**Figure 27** Improperly seated ET0100A power cable

When the appliance powers up, all LEDs illuminate (see [Figure 28](#)). The Alarm LED illuminates briefly and the diagnostic code LED displays 88 to verify that the diagnostic display segments are functioning. The power LED remains lit until the unit is powered off.

During the boot process the ET0100A cycles through its startup tests, and the corresponding diagnostic codes are displayed. After the tests execute successfully, the diagnostic code display is solidly illuminated with code 00.

 **NOTE**

*During the boot process the ET0100A discards all traffic on its data ports. Once the appliance is operational, the default mode of operation passes all packets in the clear until you deploy security policies.*

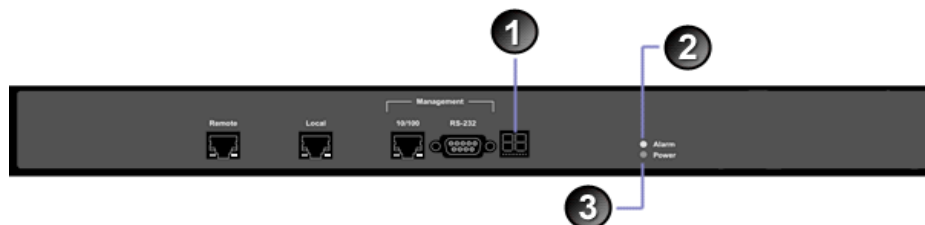
**Figure 28** ET0100A Front Panel Status Indicators

Elements of [Figure 28](#):

- 1) Diagnostic display
- 2) Alarm LED
- 3) Power indicator

## Installing the ET1000A

To prepare the ET1000A for installation, review the installation steps in [Table 16](#), unpack the shipping carton, and prepare a space for the installation of the appliance.



The steps to perform for a typical installation are listed below.

**Table 16 ET1000A Installation Steps**

Step	Action to Perform	Description
1	Review the cabling requirements.	<a href="#">on page 41</a>
1	Unpack the shipping package.	<a href="#">on page 42</a>
2	Prepare a space for installation of the ET1000A.	<a href="#">on page 42</a>
3	Connect the cables.	<a href="#">on page 44</a>
4	Apply power to the ET1000A.	<a href="#">on page 45</a>

## Cabling Requirements: ET1000A

[Table 17](#) outlines the standard cables used with each port on the ET1000A. The connector type listed indicates only what is required to connect to the ET1000A port, and may or may not be the same connector type required for the other end of the cable. Some cables are supplied by Black Box and others are user-supplied.

**Table 17 ET1000A Standard Cables**

ET1000A Port	Cabling	Supplied by...
Power receptacles	Power supply cables certified and approved for use in the country of interest	Black Box
RS-232 Port	Shielded copper null modem cable, RS-232 DB9 connector (female to male)	Black Box
Ethernet Management Port (RJ-45)	Shielded Category 5 straight through cable (STP), RJ-45 connector <sup>a</sup>	Black Box
Ethernet Management port (SFP)	Not applicable. Port is not enabled in this release.	Not applicable
Local and Remote Gigabit Ethernet ports <ul style="list-style-type: none"> <li>Optical SFP transceivers</li> </ul>	<ul style="list-style-type: none"> <li>1000Base-LX SFPs 9/125<math>\mu</math>m single-mode duplex fiber or simplex fiber pair (1 transmit, 1 receive), 1310 nm nominal wavelength, LC connector</li> </ul> OR <ul style="list-style-type: none"> <li>1000Base-SX SFPs 62.5/125<math>\mu</math>m multi-mode duplex fiber or simplex fiber pair (1 transmit, 1 receive), 850nm nominal wavelength, LC connector</li> </ul>	Available as accessory options
Local and Remote Gigabit Ethernet ports <ul style="list-style-type: none"> <li>Copper SFP transceivers</li> </ul>	Shielded Category 5 straight through cable (STP), RJ-45 connector	Available as accessory options
Aux1 port (SFP)	Not applicable. Port is not enabled in this release.	Not applicable

a. The 10/100 Ethernet management port is auto-sensing for polarity. You can use a shielded Category 5 straight through cable or a shielded crossover cable when connecting to this port.

 **NOTE**

To meet the requirements of FCC Part 15 and the EU EMC Directive 2004/108/EC, use only shielded Category 5 cables with the ET1000A Ethernet management port.

## Unpacking the Shipping Carton: ET1000A

Remove all product components from the shipping carton and compare the contents to the packing list. Keep all packaging in case it is necessary to return the unit.

The ET1000A is packaged with the standard items listed below. Additional cables, country-specific power cords, SFPs, and other accessories can be ordered separately. A list of approved transceivers is included in the *ETEP Release Note*.

- 1 ET1000A chassis
  - Firmware and software is factory-installed on the unit.
- 2 Accessory Kit
  - Rack mount kit includes 2 mounting brackets, 4 large screws (#10-32), and 8 small black screws
  - (2) Power cables (US)
  - (1) 6 ft. shielded DB-9 null modem cable (female to male)
  - (1) 6 ft. shielded Category 5 straight through cable (STP) with RJ-45 connector
  - CD containing user documentation and a backup copy of the ETEP software

## Rack Mount Installation: ET1000A

The ET1000A can be mounted in a standard 19-inch rack using the mounting kit, or simply placed on a rack shelf or solid surface. Before installing the ET1000A in a 19-inch rack, review the rack-mounting guidelines listed in [“ETEP Site Preparation” on page 28](#).

To mount the ET1000A in a standard 19-inch equipment rack, have the following tools and materials available:

- Two mounting brackets, supplied in the Accessory Kit
- 8 small black screws and 4 large #10-32 screws, supplied in the Accessory Kit
- #1 Phillips and #2 Phillips screwdrivers (user-supplied)

 **CAUTION**

In order to safely and securely install the ET1000A in a rack, you must use the mounting brackets supplied in the Accessory Kit. Other brackets may fail to properly support the weight of the ET1000A.

**To install the ET1000A in a rack:**

- 1 Place the unit on a solid surface, with the top facing up. Position the mounting brackets on each side of the appliance, as shown in [Figure 29](#).

**Figure 29 Mounting bracket orientation**

- 2 Attach the mounting brackets to each side of the unit using the 8 small black screws provided in the accessory kit, and a #1 Phillips screwdriver, as shown in [Figure 30](#).

**Figure 30 Each bracket is attached to the side of the ET1000A using four screws**

- 3 Attach the mounting brackets to the rack's front support with the large #10-32 screws, using a #2 Phillips screwdriver. Insert two screws in each bracket, using the top and bottom holes ([Figure 31](#)).

**Figure 31 Front view of mounting brackets**

## Grounding of DC Power Supply: ET1000A

### For DC Power Supply Only

Rating -36 to -72Vdc  $\pm$  0%, 6 - 4.5A

### For Earth Connection

- 1 Loosen the ground terminal screw.
- 2 Insert an earthing wire to earth.
- 3 Protective device of the DC power source is rated at 20A, which is physically connected in front of the DC power supply.

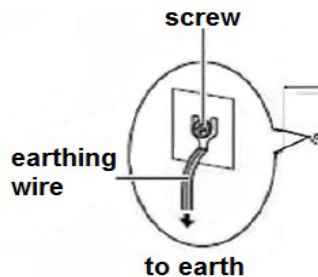

### WARNING

#### WARNING

- 1 At first, before powering on, connect the frame of the switch to earth.
- 2 Proper earthing (connection to earth) is very important to protect the switch from the negative effects of external noise or to reduce the risk to the user of electrocution in the case of a lightning strike.
- 3 To uninstall, power off device and then disconnect the earthing wire.
- 4 The earthing wire requires green-and-yellow insulation and the cross-sectional area of the conductor must be more than 0.75 mm<sup>2</sup> or 18 AWG.

## Connecting the Cables: ET1000A

Follow the instructions below to connect the ET1000A to the appropriate network devices (see [Figure 32](#)).

### To cable the ET1000A:

- 1 For initial setup, connect the RS-232 port directly to a PC or workstation using a DB-9 null modem cable. This cable can be removed after initial setup is complete.
- 2 Connect the Ethernet management port to a LAN using a Category 5 shielded twisted pair (STP) cable with an RJ-45 connector.

- 3 Plug an SFP Gigabit transceiver into the ET1000A remote port. If you are using an optical SFP, insert the fiber cable in the SFP and connect the other end to the untrusted network, typically via a router port. If you are using a copper SFP, use a shielded Category 5 straight through cable.
- 4 Plug a second SFP Gigabit transceiver into the ET1000A local port. If you are using an optical SFP, insert the fiber cable in the SFP and connect the other end to the local device, such as a server or switch. If you are using a copper SFP, use a shielded Category 5 straight through cable.

**Figure 32 ET1000A Cabling**

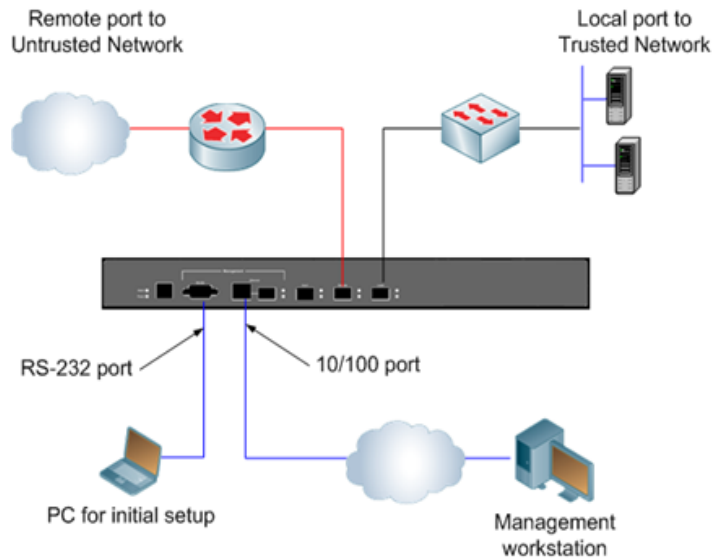

 **NOTE**

*The Gigabit management and Aux1 ports are not enabled in this release.*

## Powering on the ET1000A

Review the following guidelines prior to powering up the ET1000A:

- The ET1000A has two power supplies. We recommend that you connect the power cords to separate live circuits to provide redundancy in the case of a power outage on one of the circuits.
- When manually cycling the power, remove power on both circuits, wait five seconds, and then reapply power on both circuits.

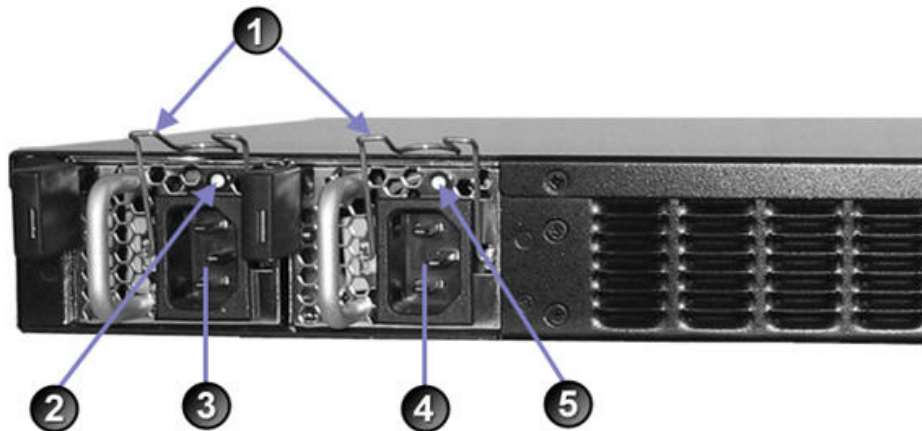
**Figure 33** Dual power supplies on the ET1000A rear panel

Elements of [Figure 33](#):

- 1) Power cord clips
- 2) Status LED for power supply 2
- 3) Power receptacle for power supply 2
- 4) Power receptacle for power supply 1
- 5) Status LED for power supply 1

#### To power on the ET1000A:

- 1 On the appliance's rear panel, plug the power cords into the power receptacles for each power supply.
- 2 Attach the opposite end of the first power cord to a power source. Attach the second power cord to a power source on a different circuit. The power supply status LED illuminates when power is applied.
- 3 After the power cords are plugged in, secure the cords using the clips on the rear of the unit.

**Figure 34** The power cord for power supply # 1 is secured with a clip

When the appliance powers up, all of the front panel LEDs illuminate (see [Figure 35](#)). The Alarm LED illuminates briefly and the diagnostic code LED displays 88 to verify that the diagnostic display segments are functioning. The power LED remains lit until the unit is powered off. The Power Supply LEDs illuminate for each operational power supply.

During the boot process the ET1000A cycles through its startup tests, and the corresponding diagnostic codes are displayed. After the tests execute successfully, the diagnostic code display is solidly illuminated with code 00.

#### NOTE

*During the boot process the ET1000A discards all traffic on its data ports. Once the appliance is operational, the default mode of operation passes all packets in the clear until you deploy security policies.*

**Figure 35 ET1000A Front Panel Status Indicators**



Elements of [Figure 35](#):

- 1) Alarm LED
- 2) Diagnostic display
- 3) Power indicator
- 4) Power supply LEDs

## Installing the ET1000A

To prepare the ET1000A for installation, review the installation steps in [Table 18](#), unpack the shipping carton, and prepare a space for the installation of the appliance.

The steps to perform for a typical installation are listed below.

**Table 18 ET1000A Installation Steps**

Step	Action to Perform	Description
1	Review the cabling requirements.	<a href="#">on page 48</a>
1	Unpack the shipping package.	<a href="#">on page 49</a>
2	Prepare a space for installation of the ET1000A.	<a href="#">on page 50</a>
3	Connect the cables.	<a href="#">on page 51</a>
4	Apply power to the ET1000A.	<a href="#">on page 52</a>

## Cabling Requirements: ET10000A

Table 19 outlines the standard cables used with each port on the ET10000A. The connector type listed indicates only what is required to connect to the ET10000A port, and may or may not be the same connector type required for the other end of the cable. Some cables are supplied by Black Box and others are user-supplied.

**Table 19 ET10000A Standard Cables**

ET1000A Port	Cabling	Supplied by...
Power receptacles	Power supply cables certified and approved for use in the country of interest	Black Box
RS-232 Port	1.8 meter shielded null modem cable with an RJ45 connector at one end and a DB9 female connector at the opposite end.	Black Box
10/100 Ethernet Management Port (RJ-45)	Unshielded Category 5 straight through cable (STP), RJ-45 connector <sup>a</sup>	Black Box
Gigabit Ethernet Management port (SFP)	Not applicable. Port is not enabled in this release.	Not applicable
USB Management port	Not applicable. Port is not enabled in this release	Not applicable
Local and Remote Gigabit Ethernet ports <ul style="list-style-type: none"> <li>Optical SFP transceivers</li> </ul>	<ul style="list-style-type: none"> <li>1000Base-LX SFPs 9/125µm single-mode duplex fiber or simplex fiber pair (1 transmit, 1 receive), 1310 nm nominal wavelength, LC connector</li> </ul> OR <ul style="list-style-type: none"> <li>1000Base-SX SFPs 62.5/125µm multi-mode duplex fiber or simplex fiber pair (1 transmit, 1 receive), 850nm nominal wavelength, LC connector</li> </ul>	Available as accessory options
Local and Remote Gigabit Ethernet ports <ul style="list-style-type: none"> <li>Copper SFP transceivers</li> </ul>	Unshielded Category 5 straight through cable (STP), RJ-45 connector	Available as accessory options
Aux1 ports (SFP and RJ-45)	Not applicable. Ports are not enabled in this release.	Not applicable

a. The 10/100 Ethernet management port is auto-sensing for polarity. You can use a unshielded Category 5 straight through cable or a unshielded crossover cable when connecting to this port.

### NOTE

To meet the requirements of FCC Part 15 and the EU EMC Directive 2004/108/EC, use only shielded Category 5 cables with the ET10000A Ethernet management port.



 **NOTE**

The polarity of the ET10000A DC power cable is indicated via color coding with Yellow being + (plus), Black being - (minus), and Green being (Ground)

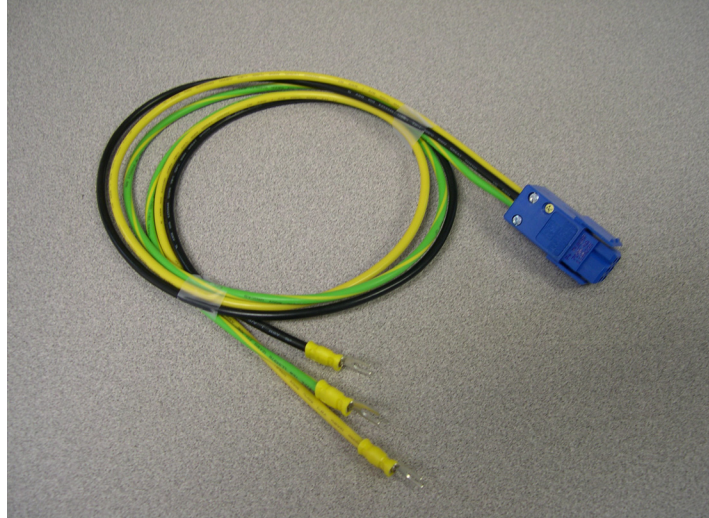

## Unpacking the Shipping Carton: ET10000A

Remove all product components from the shipping carton and compare the contents to the packing list. Keep all packaging in case it is necessary to return the unit.

The ET10000A is packaged with the standard items listed below. Additional cables, country-specific power cords, SFPs, and other accessories can be ordered separately. A list of approved transceivers is included in the *ETEP Release Note*.

- 1 ET10000A chassis
  - Firmware and software is factory-installed on the unit.
- 2 Accessory Kit
  - Rack mount kit includes 2 mounting brackets, 16 small black screws, and 4 large silver screws (#10-32)
  - (2) Power cables (US)
  - (1) Shielded null modem cable with an RJ-45 connector at one end and a DB-9 female connector at the opposite end
  - (1) 6 ft. shielded Category 5 straight through cable (STP) with RJ-45 connector
  - CD containing user documentation and a backup copy of the ETEP software

## Rack Mount Installation: ET10000A

The ET10000A can be mounted in a standard 19-inch rack using the mounting kit, or simply placed on a rack shelf or solid surface. Before installing the ET10000A in a 19-inch rack, review the rack-mounting guidelines listed in “[ETEP Site Preparation](#)” on page 28.

To mount the ET10000A in a standard 19-inch equipment rack, have the following tools and materials available:

- Two mounting brackets, supplied in the Accessory Kit
- 16 small black screws, and 4 large silver screws (#10-32), supplied in the Accessory Kit
- #1 Phillips and #2 Phillips screwdrivers (user-supplied)

### CAUTION

*In order to safely and securely install the ET10000A in a rack, you must use the mounting rails supplied in the Accessory Kit. Other rails may fail to properly support the weight of the ET10000A.*

#### To install the ET10000A in a rack:

- 1 Place the unit on a solid surface, with the top facing up. Position the mounting brackets on each side of the appliance, oriented as shown in [Figure 36](#).

**Figure 36** Mounting bracket orientation



- 2 Attach the mounting brackets to each side of the unit using the small black screws provided in the accessory kit, and a #1 Phillips screwdriver, as shown in [Figure 37](#). Each bracket uses 8 screws.

**Figure 37** Each bracket is attached to the side of the ET10000A using eight screws



- 3 Attach the mounting brackets to the rack's front support with the large #10-32 screws, using a #2 Phillips screwdriver. Insert two screws in each bracket, using the top and bottom holes (Figure 38).

**Figure 38** Front view of mounting brackets



## Connecting the Cables: ET10000A

Follow the instructions below to connect the ET10000A to the appropriate network devices (see [Figure 39](#)).

### To cable the ET10000A:

- 1 For initial setup, connect the RS-232 port directly to a PC or workstation. Using the null modem cable supplied by Black Box, insert the RJ-45 connector in the RS-232 port and connect the DB-9 female connector to your PC. This cable can be removed after initial setup is complete.
- 2 Connect the Ethernet management port to a LAN using a Category 5 shielded twisted pair (STP) cable with an RJ-45 connector.
- 3 Plug an SFP Gigabit transceiver into the ET10000A remote port. If you are using an optical SFP, insert the fiber cable in the SFP and connect the other end to the untrusted network, typically via a router port. If you are using a copper SFP, use an shielded Category 5 straight through cable.
- 4 Plug a second SFP Gigabit transceiver into the ET10000A local port. If you are using an optical SFP, insert the fiber cable in the SFP and connect the other end to the local device, such as a server or switch. If you are using a copper SFP, use an shielded Category 5 straight through cable.

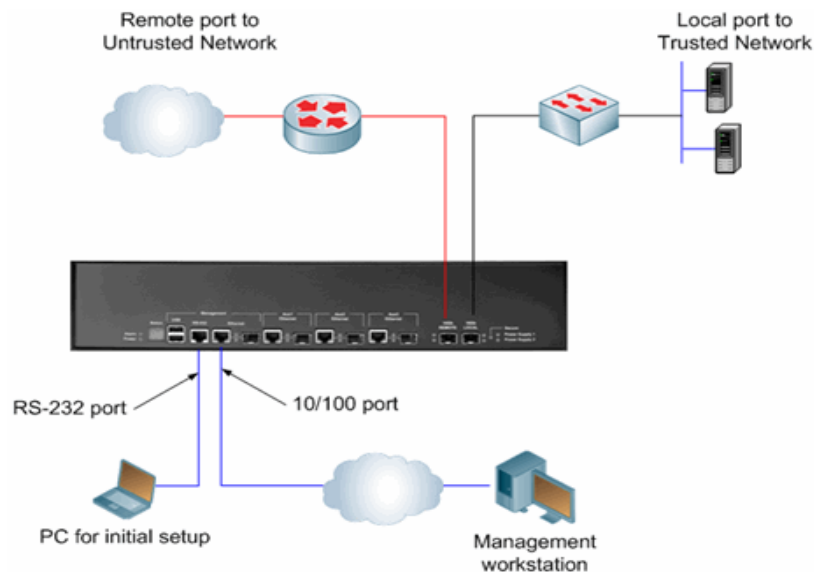
**Figure 39 ET10000A Cabling****NOTE**

*The Aux ports, and USB and Gigabit management ports are not enabled in this release.*

## Powering on the ET10000A

This section lists important safety guidelines for the ET10000A power modules, and describes how to safely apply power to the appliance.

### Safety Guidelines

Review the following guidelines prior to powering up the ET10000A:

- The ET10000A has two power supplies. We recommend that you connect the power cords to separate live circuits to provide redundancy in the case of a power outage on one of the circuits.
- When manually cycling the power, remove power on both circuits, wait five seconds, and then reapply power on both circuits.

When equipped with DC power supplies, the ET10000A is intended for connection to DC mains. It should be installed only in a restricted access location. Use only the following fuse type for each DC power module input circuit:

- 250 Vac/125Vdc, 25A, Type=Slow Blow, Time Lag

## Power-Up Procedure

Follow the instructions in this section to safely apply power to the ET10000A.

**Figure 40** Dual power supplies on the ET10000A rear panel



Elements of [Figure 40](#):

- 1) Status LED for power supply 2
- 2) Status LED for power supply 1
- 3) Power receptacle for power supply 2
- 4) Power receptacle for power supply 1

### To power on the ET10000A:

- 1 On the appliance's rear panel, plug the power cords into the power receptacles for each power supply.
- 2 Attach the opposite end of the first power cord to a power source. Attach the second power cord to a power source on a different circuit. The power supply status LED illuminates when power is applied.

When the appliance powers up, all of the front panel LEDs illuminate (see [Figure 41](#)). The Alarm LED illuminates briefly and the diagnostic code LED displays 88 to verify that the diagnostic display segments are functioning. The power LED remains lit until the unit is powered off. The Power Supply LEDs illuminate for each operational power supply.

During the boot process the ET10000A cycles through its startup tests, and the corresponding diagnostic codes are displayed. After the tests execute successfully, the diagnostic code display is solidly illuminated with code 00.

### NOTE

*During the boot process the ET10000A discards all traffic on its data ports. Once the appliance is operational, the default mode of operation passes all packets in the clear until you deploy security policies.*

**Figure 41 ET10000A Front Panel Status Indicators**

Elements of [Figure 41](#):

- 1) Alarm LED
- 2) Power indicator
- 3) Diagnostic display
- 4) Power supply LEDs

## Shutting Down the ETEP

It is important that a proper system shutdown is performed prior to powering off the appliance. The **shutdown** command halts all running tasks on the ETEP and prepares it for being powered off. Failure to perform a shutdown may lead to file system corruption and potential appliance failure.

The ETEP remains in a shutdown state until the power is cycled. The shutdown state is indicated with an operational code on the status/diagnostic display as shown in [Table 20](#).

**Table 20 Shutdown operational codes**

Appliance model	Operational code
ET0010A	2, 3, 4
ET0100A, ET1000A, ET10000A	--

You can perform a shutdown using a CLI command or EncrypTight Manager. The following procedure describes the CLI command.

### To shut down the ETEP from the CLI:

- 1 Log in as Administrator (user name **admin**) or Ops (user name **ops**).
- 2 At the command prompt, type **shutdown**. After the system shutdown is complete, the following message is displayed on the terminal.
 

```
Power cycle required to reboot appliance
```
- 3 Unplug the power cable from the back of the unit or from the power outlet.

### Example

In the following example the user logs in as **admin** and shuts down the ETEP.

```
pep login: admin
Password:
Last login: Tue Apr  8 15:12:21 2008 on ttyS0
Welcome admin it is Tue Apr  8 15:17:57 UTC 2008
admin> shutdown
```





# 3 Initial Setup

---

## Overview

The following steps are required for initial setup of the ETEP:

- 1 Log in through a serial link.
- 2 Configure the management port.
- 3 Set the date and time.
- 4 Enter the throughput license.

## Logging In Through a Serial Link

Initial setup is performed through a serial link to the RS-232 port. The initial setup commands are available to the Admin and Ops users. The procedures and examples in this chapter assume that the Admin user is performing the setup tasks.

### To log in to the CLI via a serial link:

- 1 Connect the RS-232 serial port directly to a PC or workstation, as described in [Chapter 2](#).
- 2 Open a terminal session through a VT-100 terminal emulation program such as HyperTerminal. Enter the connection name, the appropriate serial port (usually COM1 or COM2), and the following serial port parameters:

<b>Baud Speed</b>	38,400
<b>Parity</b>	None
<b>Data Bits</b>	8
<b>Stop Bits</b>	1
<b>Flow Control</b>	None

- 3 In the terminal session window, press ENTER. The login prompt displays.

```
Linux 2.6.16.17 on mips
pep login:
```

- 4 At the login prompt, type the default user name **admin** and press ENTER. User names and passwords are case-sensitive.
- 5 At the password prompt, type the default password **admin** and press ENTER.

- 6 When you are successfully logged in, the command line prompt displays as shown below (password text is not displayed).

```
pep login: admin
Password:
Last login: Tue Jan 29 19:18:59 2008 on ttyS0
Welcome admin it is Tue Jan 29 19:37:12 UTC 2008
admin>
```

It is strongly recommended that you change the default passwords when you configure the ETEP for operation. For more information about user management see the documentation for your management software: *ETEP CLI User Guide* or the *EncryptTight Manager User Guide*.

## Configuring the Management Port

The ETEP can be managed in-line or out-of-band through a dedicated Ethernet management interface. Management port configuration consists of the following items:

- Setting the IP address and default gateway
- Reviewing the auto-negotiation settings

### About the management port IP address, mask and gateway

The management port must have an assigned IP address in order to be managed remotely and communicate with other devices. An IPv4 IP address is mandatory, even when the ETEP is operating in an IPv6 network. When the ETEP is operating in an IPv6 network, configure the ETEP for dual-homed operation by assigning an IPv4 and an IPv6 address to the management port.

The Ethernet management port *IP address* identifies the ETEP to the management workstation. The *subnet mask* is the portion of the IP address that identifies the network or subnetwork for routing purposes.

When the ETEP management port and the management workstation are on different subnets, the ETEP uses a *default gateway* to route packets to the other devices. The default gateway identifies the local router port that is on the same subnet as the ETEP Ethernet management port. The appliance sends all packets to the specified router for forwarding to the management station or other EncryptTight Manager components (key generation server, time server). When the management port and workstation are on the same subnet a default gateway is not needed to route packets between the devices.

[Figure 42](#) shows an example of a default gateway when the management station and ETEP are on different subnets. The management station's IP address is 192.168.1.10, and the ETEP's management port IP address is 192.168.10.10. To send packets between the two devices, the local port on Router #1 is specified as the default gateway (192.168.10.1). The gateway address must match the subnet of the management port.

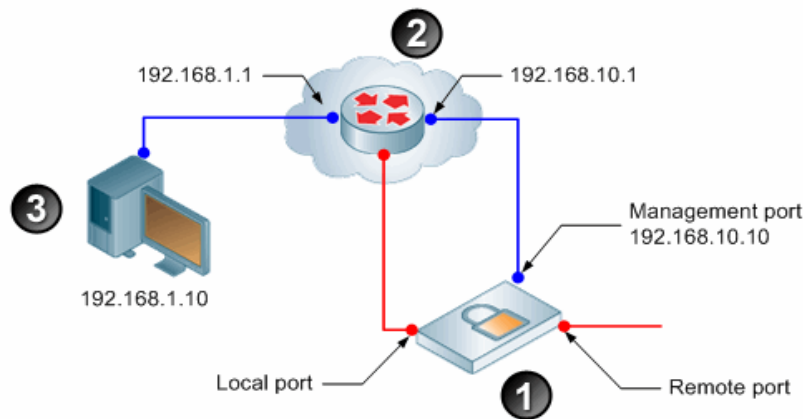
**Figure 42 Management Port Default Gateway**

Elements of [Figure 42](#):

- |          |                        |
|----------|------------------------|
| <b>1</b> | ETEP                   |
| <b>2</b> | Router                 |
| <b>3</b> | Management workstation |

### About auto-negotiation

The default setting for the ETEP enables auto-negotiation, which negotiates the link speed, duplex setting, and flow control. Use the **autoneg** command if the device that the ETEP connects to from a particular port does not support auto-negotiation or flow control.

It is important to configure the ETEP and the other device the same way. Both devices should either auto-negotiate or be set manually to the same speed and duplex mode. Having one device set manually and the other auto-negotiate can cause problems that make the link perform slowly. When manually setting the ETEP link speed, configure the speed and duplex mode to match that of the other device.

On the management port, the ETEPs can negotiate to the following link speeds:

**Table 21 Link speeds on the management port**

Link speed	Duplex mode	Auto-negotiate All ETEPs	Fixed Speed All ETEPs
10 Mbps	Half-duplex	✓	✓
10 Mbps	Full-duplex	✓	✓
100 Mbps	Half-duplex	✓	✓
100 Mbps	Full-duplex	✓	✓

### To configure the management port:

- At the command prompt, type **configure** to enter configuration mode.
- At the `config>` prompt, type **management-interface**.
- Assigning an IPv4 address to the management port is mandatory. To set the management port IPv4 address, mask, and gateway, type

```
ip <ip address> <subnet mask> [gateway]
```

- ip address** Management port IP address, entered in dotted decimal notation.
- subnet mask** IP subnet mask, entered in dotted decimal notation.
- gateway** Specifies how to route traffic between the ETEP management port and the management station. When the management port is on a different subnet than the management station, specify the IP address of the router's local port on the same subnet as the ETEP management port (see [Figure 42](#)). If the devices are on the same subnet, you do not need to enter a default gateway.

After entering the new IP address, it takes 10-20 seconds for the ETEP to set the address on the management port. During that time you cannot enter any CLI commands. When the operation is complete, the `man-if>` prompt is displayed.

- 4 *Optional.* If the ETEP is operating in an IPv6 network you can also assign an IPv6 address to the management port. To do so, type

```
ip6 {<ip address>/<prefix-length>} [gateway]
```

- ip address** IPv6 address of the ETEP management port. This is a 128-bit address consisting of eight hexadecimal groups that are separated by colons. Each group is a 4-digit hexadecimal number. The hexadecimal letters in IPv6 addresses are not case sensitive.
- prefix-length** A decimal value that indicates the number of contiguous, higher-order bits of the address that make up the network portion of the address. The decimal value is preceded by a forward slash (/).
- gateway** IPv6 address of the router port that is on the same local network as the ETEP management port.

- 5 Auto-negotiation is enabled by default. If you want to disable auto-negotiation and manually set the link speed and flow control, configure the `autoneg` command. Attributes are described in [Table 22](#).

```
autoneg {on} | {off [<speed>] [<flow-control>]}
```

- 6 Type `exit` to return to the config prompt, or type `top` to return to the command prompt.

**Table 22 Management port autoneg command description**

Attribute	Description
on	Enables auto-negotiation on the management port. This is the default setting.
off	Disables auto-negotiation on the management port. Use this setting to manually configure link speed and flow control.
speed	[10m   100m   1000m] When auto-negotiation is disabled, the speed attribute specifies the link speed. The speed defaults to 100m.
duplex	[half/full] When auto-negotiation is disabled, the duplex attribute specifies the duplex setting. The duplex setting defaults to full.
flow control	[on   off] When auto-negotiation is disabled, this attribute configures the flow control setting to be on or off. The flow control setting defaults to on.

## Example

The following example sets the management port IPv4 address, subnet mask, and gateway for the ETEP as shown in Figure 42. Auto-negotiation is left at its default setting of enabled.

```
admin> configure
config> management-interface
man-if> ip 192.168.10.10 255.255.255.0 192.168.10.1
man-if> exit
```

The next example sets the management IPv4 address and subnet mask, and omits the default gateway. The default gateway can be omitted when the management station and the ETEP management port and are wired directly to each other on the same subnet. Auto-negotiation is disabled. The link speed is set to 100 Mbps full-duplex and flow control is turned on.

```
admin> configure
config> management-interface
man-if> ip 192.168.10.10 255.255.255.255
man-if> autoneg off 100m full on
man-if> exit
```

The following example sets an IPv6 address, prefix length, and default gateway on the management port.

```
admin> configure
config> management-interface
man-if> ip6 2001:DB8::211:11FF:FE58:743/64 2001:DB8::20F:F7FF:FE84:BFC2
man-if> exit
config>
```

# Setting the Date and Time

Setting the date and time on the ETEP helps ensure that the appliance's time can be synchronized properly with other ETEPs or components in the EncrypTight Manager system.

The time zone on the ETEP is set to UTC 0 (Coordinated Universal Time), and is not user configurable. Enter the date and time relative to UTC 0, also referred to as Greenwich Mean Time (GMT). To calculate the local time relative to UTC, add or subtract the offset hours from UTC for the local time zone (UTC  $\pm n$ ). The following examples give the local time at various locations at 12:00 UTC when daylight saving time is not in effect:

- New York City, United States: UTC-5; 07:00
- New Delhi, India: UTC+5:30; 17:30

### To set the date and time:

- 1 At the command prompt, type **configure** to enter configuration mode.
- 2 At the `config>` prompt, type **date <year> <month> <day> <hour> <minutes> <seconds>**

<b>year</b>	2008-2037
<b>month</b>	01-12
<b>day</b>	01-31

```

hour           00-23
minutes       00-59
seconds      00-59

```

- 3 Type **exit** to return to the command prompt.

#### Example

```

admin> configure
config> date 2008 10 11 15 30 00
config> exit

```

## Entering a Throughput License

The method for entering licenses on the ETEP depends on your management software:

- For ETEPs that are managed exclusively through the command line, follow the procedure in this section.
- For EncrypTight Manager deployments, throughput licenses *must* be managed with the EncrypTight Manager software. Licenses entered from the CLI are not recognized as valid in a EncrypTight Manager deployment. See the *EncrypTight Manager User Guide* for more information.

Each ETEP is capable of transmitting traffic at a range of speeds that varies by model. When you install the license you purchased, ETEPs transmit traffic at the speed specified by the license. [Table 23](#) lists the available speeds for each ETEP model.

**Table 23 ETEP Throughput Speeds**

Model	Available Throughput
ET0010A	3, 6, 10, 25, 50 Mbps
ET0100A	25, 50, 75, 100, 155, 250 Mbps
ET1000A	100, 155, 250, 500, 650 Mbps, 1 Gbps
ET10000A	500, 650 Mbps, 1, 2.5, 5, 10 Gbps

You need to install a license on each ETEP that you use. Licenses are linked to the serial number of the ETEP on which they are installed. You cannot install a license intended for one ETEP on a different ETEP.

If you upgrade from a command line-only installation to a full EncrypTight Manager deployment, you can no longer use the command line-only license and must acquire a license for EncrypTight Manager.

#### To add a license from the command line:

- 1 At the command prompt, type **configure** to enter configuration mode.
- 2 At the `config>` prompt, type **license <string>**, where string is the license provided by Customer Support. The license is case sensitive. Enter the license exactly as provided. It will look something like this: 1:0:0508C482:10:258482fab2

**To view the ETEP throughput speed:**

- 1 At the command prompt, type `show throughput-speed`.

## Configuration Example

The following example illustrates the commands used for initial setup of the ETEP to configure the following parameters: management IP address, subnet mask, and default gateway, auto-negotiation, date and time. The `autoneg` command needs to be configured only if you want to disable auto-negotiation and configure the link speed and flow control manually.

```
pep login: admin
Password: *****
admin> configure
config> management-interface
man-if> ip 192.168.10.10 255.255.255.0 192.168.10.1
man-if> autoneg disable 100m-full on
man-if> exit
config> date 2008 10 15 12 30 00
config> exit
admin>
```

## Managing the ETEP

The ETEP can be managed in two ways, depending on the size and complexity of your deployment:

- Command Line Interface (CLI)

You can configure the ETEPs for operation and create Layer 2 point-to-point policies using the CLI commands.

To manage the ETEP using the CLI, you can attached a PC directly to the serial port or use any SSH client for a secure remote connection through the Ethernet management port.

- EncrypTight Manager Policy and Key Manager™

EncrypTight Manager can distribute keys to a large number of ETEPs. It works for complex mesh, hub and spoke, and multicast networks, as well as in straightforward point-to-point topologies.

EncrypTight Manager includes tools for appliance configuration, policy definition and deployment, and key generation and distribution.

To prepare the ETEP for operation in the network, you will need to perform the following tasks:

- 1 Assign passwords
- 2 Configure the ETEP
- 3 Define security policies

If you plan to operate the ETEP in FIPS mode, we recommend enabling FIPS mode as your first configuration task. Entering FIPS mode resets many configuration items, such as passwords, policies, and certificates. To avoid having to reconfigure the ETEP, enable FIPS mode and then perform the rest of the appliance and policy configuration tasks.

 **CAUTION**

*After entering FIPS Mode, the user must replace the admin and ops passwords from the default settings.*

See the user guide for your management software for details:

- *ETEP CLI User Guide*
- *EncrypTight Manager User Guide*



# 4 Maintenance

---

## Preventative Maintenance

Periodically perform maintenance on your ETEP. Keep components free of dust and other particulate matter. Examine cables for damage and ensure that airflow requirements have been met. On ETEP models that have fans, check the fans for reduced airflow caused by dust build-up and clean as necessary. No special maintenance is required.

The ETEP is housed in a tamper evident chassis. Periodically check the chassis for evidence of tampering. Items to look for include stripped screws and damage to the tamper-evident seal. The tamper-evident seal is located on the rear panel;

The frequency of a physical inspection depends on the value of the intellectual property being protected and the security of the environment in which the ETEP is located. For example, a locked equipment closet is more secure than an open server room. At a minimum, it is recommended that the unit's physical integrity be checked on a monthly basis.

### CAUTION

---

*The ETEP does not contain any field-replaceable internal parts. Do not remove the unit's cover for any reason. Removing the cover will zeroize the ETEP, returning it to its factory default state. All configuration data and keys are destroyed during the zeroization process. The cover is to be removed only by authorized service personnel. Unauthorized cover removal voids the product warranty.*

### CAUTION

---

*Disconnect all power cords before servicing.*

## What To Do If an Appliance Fails

Most ETEP models do not contain any field-replaceable parts. If you experience an appliance failure, contact Customer Support for a replacement ETEP and throughput license.

The ET1000A and ET10000A have field-replaceable power supplies. Contact Customer Support to obtain a replacement power supply in the event of a failure. See [“Replacing a Power Supply” on page 66](#) for removal and installation instructions.

## Obtaining a License for Replacement Units

When replacing the ETEP with a spare, the replacement ETEP will run at full throughput for a grace period. During the grace period, contact customer support to report the RMA unit and to receive a new license for the replacement. Licenses are linked to the serial number of the ETEP on which they are installed. You cannot install a license intended for one ETEP on a different ETEP.

Upon receipt of the new license, install it on the ETEP as described in [“Entering a Throughput License” on page 80](#).

## Replacing a Power Supply

The ET1000A and ET10000A come with dual internal power supplies. In the event of a failure, the power supplies can be removed and replaced in the field.

### Replacing the ET1000A Power Supply



#### CAUTION

*Disconnect all power cords before servicing the ET1000A.*

#### To replace a power supply in the ET1000A:

- 1 Unplug both power supplies at the power source.
- 2 On the rear panel, lift the power cord clip on the affected power supply, and then remove the power cord from the receptacle ([Figure 43](#)).

**Figure 43** Power cord is removed from power supply # 2

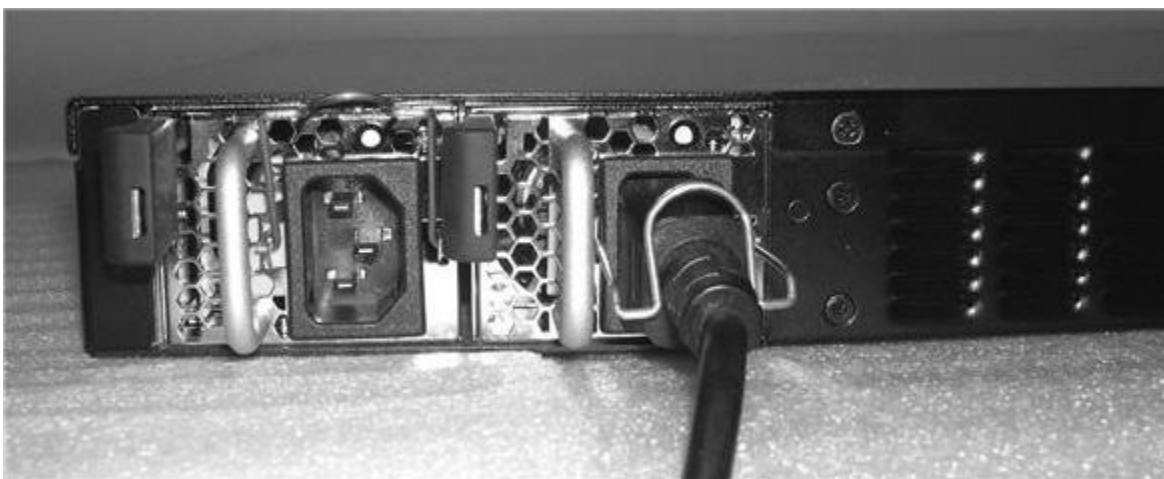

- 3 Locate the release lever on the left of the power supply ([Figure 44](#)). Press the release lever inward toward the metal support to release the power supply latch. Pull the power supply outward to remove it from the chassis.

**Figure 44 Release lever on power supply # 2**

- 4 On the replacement power supply, press the release lever toward the metal support and insert the new power supply until it latches (Figure 45). When the power supply is correctly inserted, you should not be able to remove it by pulling on it. It can only be removed when the latch is disengaged.

**Figure 45 Slide the replacement power supply into the slot on the rear panel**

- 5 Insert the power cord in the replacement power supply and secure it with the clip.
- 6 Reconnect power supplies 1 and 2 to their respective power sources.
- 7 Return the failed power supply to Black Box as directed by Customer Support.

## Replacing the ET10000A Power Supply



*Disconnect all power cords before servicing the ET10000A.*

### To replace a power supply in the ET10000A:

- 1 Unplug both power supplies at the power source.
- 2 On the rear panel, remove the two screws that secure the power supply bracket using a Phillips screw driver. Remove the bracket and set aside (Figure 46).

**Figure 46** The power supply bracket is secured with two screws

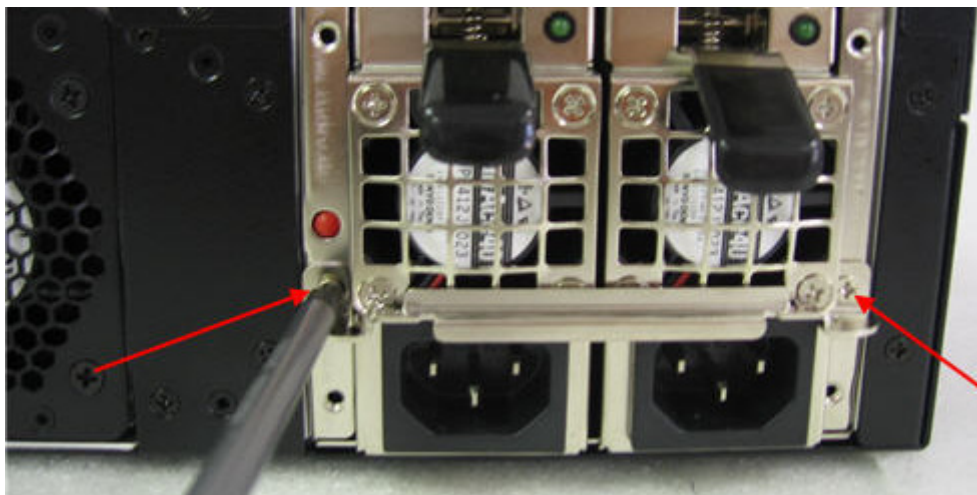

- 3 Locate the release lever at the top of the power supply ([Figure 47](#)). Press the release lever downward toward the black support support to release the power supply latch.

**Figure 47** Press the release lever downward to unlatch the power supply

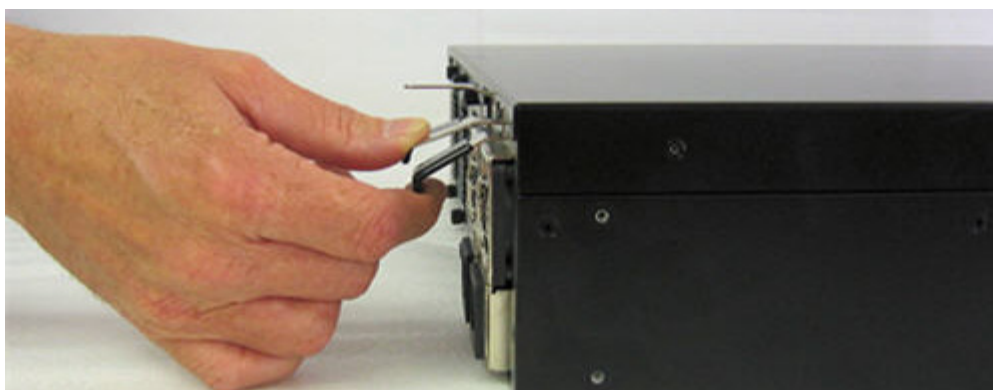

- 4 Keeping the lever in the release position, pull the power supply outward to remove it from the chassis. When the power supply is clear of the chassis, release the lever ([Figure 48](#)).

**Figure 48** Remove the power supply from the chassis



- 5 On the replacement power supply, press the release lever downward toward the support and insert the new power supply until it latches ([Figure 49](#)). When the power supply is correctly inserted, you should not be able to remove it by pulling on it. It can only be removed when the latch is disengaged.

**Figure 49** Correctly inserted and latched power supply is shown on the left. Note the position of the release levers.

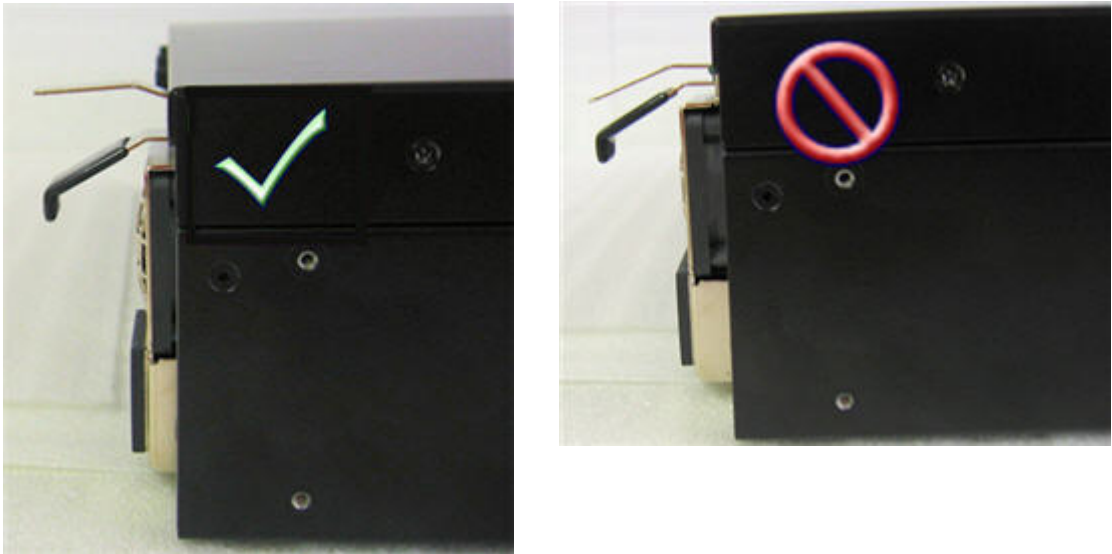

- 6 Replace the power supply bracket (Figure 46).
- 7 Insert the power cord in the replacement power supply.
- 8 Reconnect power supplies 1 and 2 to their respective power sources.
- 9 Return the failed power supply to Black Box as directed by Customer Support.

## Tamper Switch and Zeroization

The following ETEP models include a tamper switch: ET0010A, ET0100A, ET1000A, and ET10000A. The switch is activated if the ETEP cover is removed while the unit is operating or if the ETEP detects that the cover is open while it is booting. When the ETEP detects that the switch is activated it enters an error state, zeroizes the appliance's keying material, and discards all traffic. Zeroization has the same effect as issuing the **filesystem-reset** command.

The following events occur when the ETEP is zeroized:

- Alarm LED illuminates
- The ETEP sends a critical error trap
- The ETEP discards all packets that it receives on the local and remote ports
- Ethernet management port communication is disabled. You will be unable to manage the ETEP using EncrypTight Manager.
- CLI login is disabled via the serial port and Ssh
- Data files are permanently deleted, including log files
- The file system is reset to factory defaults

The zeroization process takes about 20 minutes to complete.

**To recover the ETEP following zeroization:**

Wait approximately 20 minutes for the zeroization process to complete. If you are connected to the ETEP through the serial port, you will see the following message:

```
Power cycle required to reboot appliance
```

After cycling the power, you will be able to configure and manage the ETEP from its factory default settings. If you cycle the power prior to the completion of the zeroization process the appliance will enter an unrecoverable state, which requires returning the ETEP to the factory.

## Cable Pinouts

This section lists the serial cable pinouts for the following ETEPs:

- ET0010A and ET10000A
- ET0100A and ET1000A

## RS-232 Serial Cable: ET0010A and ET10000A

The RS-232 serial cable on the ET0010A and ET10000A is a null modem cable with an RJ-45 connector to the ET0010A and a DB-9 female connector to a PC or laptop.

**Figure 50 ET0010A Null Modem Serial Cable**

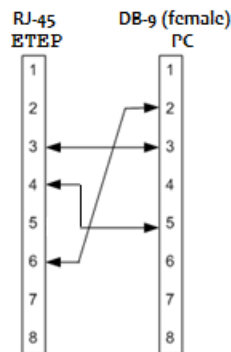

**Table 24 ET0010A Null Modem Pin Connection**

RJ-45 Pin	DB-9 Pin
3 Receive Data	3 Transmit Data
6 Transmit Data	2 Receive Data
5 Signal Ground	5 Signal Ground

## RS-232 Serial Cable: ET0100A, ET1000A Models

The RS-232 serial cable on the ET0100A, and ET1000A is a null modem cable with DB-9 connectors (female to male).

**Figure 51 ETEP100x Null Modem Serial Cable**

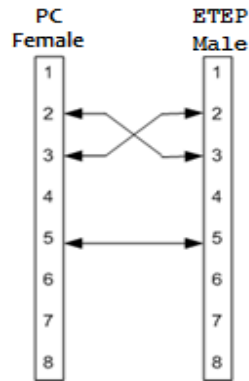
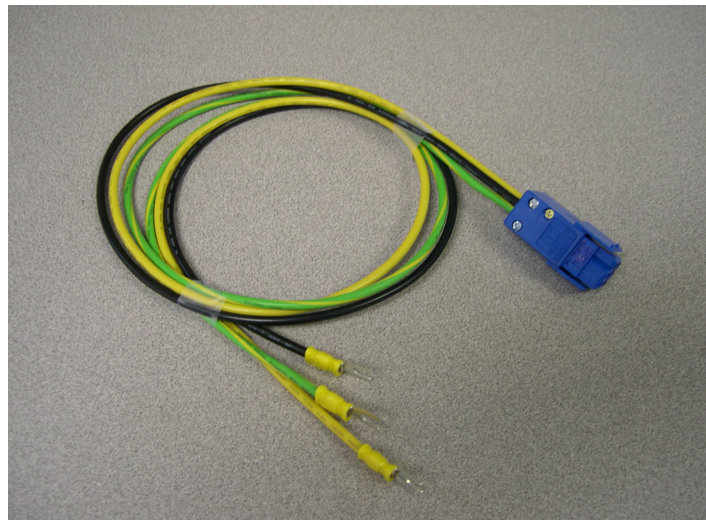

**Table 25 ETEP100x Null Modem Pin Connection**

Pin	Pin
2 Receive Data	3 Transmit Data
3 Transmit Data	2 Receive Data
5 Signal Ground	5 Signal Ground

### NOTE

The polarity of the ET10000A DC power cable is indicated via color coding with Yellow being + (plus), Black being - (minus), and Green being (Ground)







# 5 Troubleshooting

## Symptoms and Solutions

The following tables provide some solutions to common problems that may occur with your ETEP.

### LED Indicators

**Table 26 LED Indicators**

Symptom	Explanation and Possible Solution
No power light.	<ul style="list-style-type: none"><li>• Make sure the power cable is attached and plugged in to both the device and the power outlet.</li></ul>
Alarm light is lit.	<ul style="list-style-type: none"><li>• The ETEP is in an error state. See <a href="#">“Error State” on page 74</a> for information about possible causes and recovery procedures.</li></ul>
Port status LED is off (no link).	<ul style="list-style-type: none"><li>• Check the network cable. Verify correct transmit and receive cable polarity.</li><li>• Check the operational status of the equipment being connected.</li><li>• Verify that the auto-negotiation and flow control settings on the local or remote port in question match the settings of the equipment to which they are connected.</li><li>• If the problem is not resolved, the network may not be functioning properly. Consult a local network administrator.</li></ul>
Port status LED is not blinking (no traffic).	<ul style="list-style-type: none"><li>• Check physical connectivity.</li><li>• Verify that the policies are set up to allow traffic to pass through the appliance.</li><li>• Check with your Network Administrator to ensure proper placement in the network.</li></ul>
Power supply LED is off	<p>The power supply is unplugged or is unable to recover from a power interruption.</p> <ul style="list-style-type: none"><li>• Make sure the power cable is attached and plugged in to the power supply and the power outlet.</li><li>• Check the status LED on the power supply on the rear of the unit. If the LED is off, the power supply is not receiving power. If the LED is red, the power supply requires a manual power cycle. Unplug the power cord, wait 5 seconds, and then reapply power. The LED is green during normal operation. If a manual power cycle does not restore power, contact customer support.</li></ul>

## Error State

**Table 27 Error State Symptoms and Solutions**

Symptom	Explanation and Possible Solutions
The Alarm LED is illuminated	<p>The ETEP enters an error state when a boot test fails, the operating temperature threshold is exceeded, signature errors are detected on critical files pertaining to policies and keys. or a FIPS test fails when the ETEP is in FIPS mode.</p> <p>When the ETEP is in an error state the Alarm LED illuminates, and the appliance discards all packets it receives. Depending on the error, other notifications may be sent (traps, status messages to the EncrypTight Manager or the terminal).</p> <p>To recover from an error state when FIPS mode is disabled:</p> <ul style="list-style-type: none"> <li>• When the ETEP detects a corrupted policy, it enters an error state and sends a critical error trap to the management station. To recover, redeploy the policies and then reboot the ETEP.</li> <li>• For non-policy errors, reboot the appliance. If the operating temperature threshold is exceeded, cycle the power to restart the ETEP.</li> <li>• If a failure occurs during the boot process, refer to <a href="#">“Diagnostic Code Display” on page 75</a> for additional troubleshooting information.</li> <li>• If the actions listed above do not clear the error, contact customer support.</li> </ul>

 **NOTE**

*A FIPS failure puts the ETEP into FIPS error mode, lights the alarm indicator, and puts dataplane in discard mode, but does not zeroize the ETEP. A user can recover by doing a reboot or exiting FIPS mode*

### Temperature Threshold and Discarded Traffic

When the ETEP enters an alarm state due to a temperature failure, the Alarm indicator illuminates and the ETEP discards traffic. The ETEP remains in an error state until it is rebooted. However, once the temperature drops below the critical threshold, the alarm indicator turns off and the ETEP stops reporting an alarm state to EncrypTight Manager, even though the alarm state has not been cleared and the ETEP continues to discard traffic.

If the ETEP is discarding traffic, check the system log for temperature warning notices to confirm that a temperature error occurred. Reboot the ETEP to resume normal operation.

# Diagnostic Code Display

ETEPs display self-test codes during boot up, in addition to operational status and error conditions. See the following sections for information about your appliance model.

## Status Codes: ET0010A

The ET0010A status LEDs display self-test codes during boot up. After the ET0010A boots, the status LEDs reflect the operational state of the appliance.

When the appliance powers up, the Alarm LED illuminates briefly and the four status LEDs illuminate to verify that they are functioning. As the ET0010A cycles through its self-tests the status LEDs indicate the self-test that is in progress (see [Table 28](#)). After the tests execute successfully, the status LEDs turn off.

If the ET0010A fails to boot properly the illuminated status LEDs indicate the number of the last test that completed successfully, and a message describing the failure is displayed on the terminal. In addition, the Alarm light illuminates if any of the first four self-tests fail (status LEDs 1, 2, 1&2, or 3). In the event of a failure, make a note of the status code and of the error message on the console, and then contact Black Box customer support.

**Table 28 ET0010A Self-Tests**

Status LEDs Illuminated	Description
1, 2, 3, 4	LED display test.
1	Bootflash CRC test.
2	DRAM test #1.
1, 2	Initialize IO devices. DRAM test #2.
3	Initialize compact flash.
1,3	Complete bootloader initialization.
2,3	Download operating system.
1, 2, 3	Start operating system, IPSec dataplane code, and management and control software.
1, 3, & 4	Restart/reboot command issued.
All status LEDs off	Up and operational.

After the ET0010A boots up, the status LEDs reflect the operational state of the appliance.

**Table 29 ET0010A Operational Codes**

Code	Description
All status LEDs off	Up and operational.
2, 3, 4	The ET0010A is in a shutdown state.

## Diagnostic Codes: ET0100A, ET1000A and ET10000A

The 7-segment diagnostic display on the front panel of the following models displays self-test codes during boot up: ET0100A, ET1000A, and ET10000A. After the ETEP boots, the display reflects the operational state of the appliance and error conditions.

When the appliance powers up, all LEDs illuminate. The Alarm LED illuminates briefly and the diagnostic code LED displays 88 to verify that the diagnostic display segments are functioning. As the ETEP cycles through its self-tests the corresponding diagnostic code is displayed (see ). After the tests execute successfully, the diagnostic code display is solidly illuminated with code 00.

If the ETEP fails to boot properly the diagnostic code display indicates the number of the last test that completed successfully, and a message describing the failure is displayed on the terminal. In addition, the Alarm light illuminates if diagnostic tests 01-04 fail. In the event of a failure, make a note of the code and of the error message on the console, and then contact Black Box customer support.

After the ETEP boots up, the diagnostic display reflects the operational state of the appliance. .

### ETEP Self-Tests

Code	Description
88	7-segment display test.
01	Bootflash CRC test.
02	DRAM test #1.
03	Initialize IO devices. DRAM test #2.
04	Initialize compact flash.
05	Complete bootloader initialization.
06	Download operating system.
07	Start operating system, IPSec dataplane code, and management and control software.
00	Up and operational.

**Table 30 ETEP Operational Codes**

Code	Description
00	Up and operational.
rb	The ETEP is in a reboot required state.
AL	An alarm condition or error condition has been reported.
dL	The ETEP is downloading new software.
rS	The ETEP has issued a restart/reboot command.
--	The ETEP is in a shutdown state.

# Appendix A Environmental and Regulatory Information

---

## WEEE Directive

Black Box is committed to environmentally responsible behavior. As part of this commitment, we have put in place a product end-of-life management solution that meets the European Union's Waste Electrical and Electronic Equipment (WEEE) Directive. All products shipped from the Black Box manufacturing facility have the appropriate WEEE markings and qualify for the recycling program. Black Box products that have reached the end of their useful life are to be recycled. Send all requests for recycling to [info@blackbox.com](mailto:info@blackbox.com). Black Box will arrange for pick up and transport to a recycling location that complies in an environmentally responsible manner with the EU WEEE Directive.

## RoHS Directive

The Restriction of Hazardous Substances (RoHS) Directive restricts the use of certain materials that are commonly found in electronic products. Restricted substances are heavy metals, including lead, and poly-brominated materials.

Black Box has eliminated or substantially reduced its usage of the prohibited materials. However, the RoHS Directive allows a lead-in-solder exemption for Category 3 Telecommunications Products. It is Black Box' position that its network security products qualify for the lead-in-solder exemption.

Black Box is committed to completely eliminating its use of RoHS prohibited materials as that becomes technically feasible. We are constantly monitoring the availability of lead-free components and the progress of the lead-free manufacturing processes. We pledge to continually evolve and refine our products and processes as viable alternatives that do not impact product reliability or performance become available.

For more information on the status of our RoHS efforts or product-specific environmental questions, please e-mail us at [info@blackbox.com](mailto:info@blackbox.com).

## Regulatory Information

This section contains regulatory information for the following Black Box appliances:

- ET0010A
- ET0100A
- ET1000A
- ET10000A

## ET0010A Regulatory Information

The ET0010A and ET0010A-Desktop, have received a statement of compliance for the items listed in the following sections:

- Application of Regulations: FCC Title 47, Part 15, Subpart B, EMC Directive 2004/108/EC
- Class of Equipment: Class A

### Safety

- UL: IEC 60950-1:2005, Second Edition; EN 60950-1:2006
- CSA-C22.2 No. 60950-1

### Immunity

- EN 55024:1998/A1:2001/A2:2003 (IEC 61000-4-2:1995/A2:2000, IEC 61000-4-3:2002, IEC 61000-4-4:2004, IEC 61000-4-5:1995/A1:2000, IEC 61000-4-6:1996/A1:2000, IEC 61000-4-8:1993/A1:2000, IEC 61000-4-11:1994/A1:2000)

### Emissions

- FCC Part 15, Subpart B, Class A
- EN55022: 2006, Class A
- EN61000-3-2:2006, EN61000-3-3:1995/A1:2001/A2:2005
- AS/NZS CISPR 22:2006 Class A

### FCC Information (USA)

This equipment has been tested and found to comply with the limits for a Class A digital device, pursuant to Part 15 of FCC rules. Operations are subject to the following conditions:

- This device may not cause harmful interference
- This device must accept any interference received, including interference that may cause undesirable operation.

### Interference-Causing Equipment Standard Compliance Notice (Canada)

“The Class A digital apparatus complies with Canadian ICES-003.”

“Cet appareil numerique de la class A est conforme a la norme NMB-003 du Canada.”

## European Notice

Products with the CE Marking comply with both the EMC Directive (2004/108/EC) and the Low Voltage Directive (2006/95/EC) issued by the Commission of the European Community.

## ET0100A Regulatory Information

The ET0100A, part number 410-032-002, has received a statement of compliance for the items listed in the following sections.

- Application of Regulations: FCC Title 47, Part 15, Subpart B, EMC Directive 2004/108/EC
- Class of Equipment: Class B

## Safety

- UL 60950-1
- CSA-C22.2 No. 60950-1

## Immunity

- EN 55024:1998/A1:2001/A2:2003 (IEC 61000-4-2:1995/A2:2000, IEC 61000-4-3:2002, IEC 61000-4-4:2004, IEC 61000-4-5:1995/A1:2000, IEC 61000-4-6:1996/A1:2000, IEC 61000-4-8:1993/A1:2000, IEC 61000-4-11:1994/A1:2000)

## Emissions

- EN55022: 2006, ANSI C63.4:2006, EN61000-3-2:2006, EN61000-3-3:1995/A1:2001/A2:2005

## FCC Information (USA)

This equipment has been tested and found to comply with the limits for a Class B digital device, pursuant to Part 15 of the FCC Rules. These limits are designed to provide reasonable protection against harmful interference in a residential installation. This equipment generates, uses, and can radiate radio frequency energy and, if not installed and used in accordance with the instructions, may cause harmful interference to radio communications. However, there is no guarantee that interference will not occur in a particular installation. If this equipment does cause harmful interference to radio or television reception, which can be determined by turning the equipment off and on, the user is encouraged to try to correct the interference by one or more of the following measures:

- Reorient or relocate the receiving antenna.
- Increase the separation between the equipment and receiver.
- Connect the equipment into an outlet on a circuit different from that to which the receiver is connected. Consult the dealer or an experienced radio/TV technician for help.

## Interference-Causing Equipment Standard Compliance Notice (Canada)

“The Class B digital apparatus complies with Canadian ICES-003.”

“Cet appareil numérique de la class B est conforme a la norme NMB-003 du Canada.”

## European Notice

Products with the CE Marking comply with both the EMC Directive (2004/108/EC) and the Low Voltage Directive (2006/95/EC) issued by the Commission of the European Community.

## ET0100A Cabling



### WARNING

*Use only shielded cables to connect I/O devices to this equipment. You are cautioned that changes or modifications not expressly approved by the party responsible for compliance could void your authority to operate the equipment.*

## ET1000A Regulatory Information

The ET1000A, part number 410-032-102, have received statements of compliance for the items listed in the following sections:

- Application of Regulations: FCC Title 47, Part 15, Subpart B (US), Canada Standard ICES-003, European Council Directive 2004/108/EC
- Class of Equipment: Class A

## Safety

- UL 60950-1, 2nd Edition, 2007-03-27
- CSA-C22.2 No. 60950-1-07, 2nd Edition, 2007-03

## Immunity

- EN 55024:1998/A1:2001/A2:2003 (IEC 61000-4-2:1995/A2:2000, IEC 61000-4-3:2002, IEC 61000-4-4:2004, IEC 61000-4-5:1995/A1:2000, IEC 61000-4-6:1996/A1:2000, IEC 61000-4-8:1993/A1:2000, IEC 61000-4-11:1994/A1:2000)

## Emissions

- EN55022: 2006/A1:2007 Class A
- EN61000-3-2:2006, EN61000-3-3:1995/A1:2001/A2:2005
- AS/NZS CISPR 22:2006 Class A

## FCC Information (USA)

This equipment has been tested and found to comply with the limits for a Class A digital device, pursuant to Part 15 of FCC rules. Operations are subject to the following conditions:

- This device may not cause harmful interference
- This device must accept any interference received, including interference that may cause undesirable operation.



## Interference-Causing Equipment Standard Compliance Notice (Canada)

“The Class A digital apparatus complies with Canadian ICES-003.”

“Cet appareil numerique de la class A est conforme a la norme NMB-003 du Canada.”

## European Notice

Products with the CE Marking comply with the European Council Directive 2004/108/EC.

## ET1000A Regulatory Information

The ET1000A, part number 410-032-103, has received statements of compliance for the items listed in the following sections:

- Application of Regulations: FCC Title 47, Part 15, Subpart B (US), Canada Standard ICES-003, European Council Directive 2004/108/EC
- Class of Equipment: Class B

## Safety

- UL 60950-1, 2nd Edition, 2007-03-27
- CSA-C22.2 No. 60950-1-07, 2nd Edition, 2007-03
- IEC 60950-1, 2nd Edition
- EN 60950-1:2006+A11:2009

## EMI/EMC

- ANSI C63.4:2003
- FCC Title 47, Part 15 Subpart B
- Canada Standard ICES-003
- European Council Directive 2004/108/EC
- EN55022: 2006/A1:2007 Class B
- EN61000-3-2:2006, EN61000-3-3:1995/A1:2001/A2:2005
- EN 55024:1998/A1:2001/A2:2003 (IEC 61000-4-2:1995/A2:2000, IEC 61000-4-3:2002, IEC 61000-4-4:2004, IEC 61000-4-5:1995/A1:2000, IEC 61000-4-6:1996/A1:2000, IEC 61000-4-8:1993/A1:2000, IEC 61000-4-11:1994/A1:2000)
- Australian Standard AS/NZS CISPR 22:2006 Class B

## FCC Information (USA)

This equipment has been tested and found to comply with the limits for a Class B digital device, pursuant to Part 15 of FCC rules.

## Interference-Causing Equipment Standard Compliance Notice (Canada)

“The Class B digital apparatus complies with Canadian ICES-003.”

“Cet appareil numérique de la class B est conforme a la norme NMB-003 du Canada.”

## European Notice

Products with the CE Marking comply with the European Council Directive 2004/108/EC.

## ET10000A Regulatory Information

At the time of publication of this manual, testing was in process for the ET10000A, part number 410-032-702. To obtain updated information about safety, emissions, and FCC test findings, contact Customer Support.

## Normas Oficiales Mexicanas (NOM): Electrical Safety Statement

### INSTRUCCIONES DE SEGURIDAD

- 1 Todas las instrucciones de seguridad y operación deberán ser leídas antes de que el aparato eléctrico sea operado.
- 2 Las instrucciones de seguridad y operación deberán ser guardadas para referencia futura.
- 3 Todas las advertencias en el aparato eléctrico y en sus instrucciones de operación deben ser respetadas.
- 4 Todas las instrucciones de operación y uso deben ser seguidas.
- 5 El aparato eléctrico no deberá ser usado cerca del agua—por ejemplo, cerca de la tina de baño, lavabo, sótano mojado o cerca de una alberca, etc..
- 6 El aparato eléctrico debe ser usado únicamente con carritos o pedestales que sean recomendados por el fabricante.
- 7 El aparato eléctrico debe ser montado a la pared o al techo sólo como sea recomendado por el fabricante.
- 8 Servicio—El usuario no debe intentar dar servicio al equipo eléctrico más allá a lo descrito en las instrucciones de operación. Todo otro servicio deberá ser referido a personal de servicio calificado.
- 9 El aparato eléctrico debe ser situado de tal manera que su posición no interfiera su uso. La colocación del aparato eléctrico sobre una cama, sofá, alfombra o superficie similar puede bloquea la ventilación, no se debe colocar en libreros o gabinetes que impidan el flujo de aire por los orificios de ventilación.
- 10 El equipo eléctrico deber ser situado fuera del alcance de fuentes de calor como radiadores, registros de calor, estufas u otros aparatos (incluyendo amplificadores) que producen calor.
- 11 El aparato eléctrico deberá ser conectado a una fuente de poder sólo del tipo descrito en el instructivo de operación, o como se indique en el aparato.
- 12 Precaución debe ser tomada de tal manera que la tierra física y la polarización del equipo no sea eliminada.

- 13 Los cables de la fuente de poder deben ser guiados de tal manera que no sean pisados ni pellizcados por objetos colocados sobre o contra ellos, poniendo particular atención a los contactos y receptáculos donde salen del aparato.
- 14 El equipo eléctrico debe ser limpiado únicamente de acuerdo a las recomendaciones del fabricante.
- 15 En caso de existir, una antena externa deberá ser localizada lejos de las líneas de energía.
- 16 El cable de corriente deberá ser desconectado del cuando el equipo no sea usado por un largo periodo de tiempo.
- 17 Cuidado debe ser tomado de tal manera que objetos líquidos no sean derramados sobre la cubierta u orificios de ventilación.
- 18 Servicio por personal calificado deberá ser provisto cuando:
  - a El cable de poder o el contacto ha sido dañado; u
  - b Objetos han caído o líquido ha sido derramado dentro del aparato; o
  - c El aparato ha sido expuesto a la lluvia; o
  - d El aparato parece no operar normalmente o muestra un cambio en su desempeño; o
  - e El aparato ha sido tirado o su cubierta ha sido dañada.



# Index

---

## A

### alarm LED

- ET0010A 11
- ET0100A 13
- ET1000A 15
- ET10000A 18

### autoneg command 60

## B

### battery replacement 27

### booting the appliance

- ET0010A 35
- ET0100A 39
- ET1000A 45
- ET10000A 52

## C

### cables

#### connecting the cables

- ET0010A 34
- ET0100A 38
- ET1000A 44
- ET10000A 51

#### pinouts 70

#### requirements

- ET0100A 36
- ET1000A 41
- ET10000A 48

### command line interface

#### logging in 57

### connectors

- ET0010A connectors 10
- ET0100A connectors 12
- ET1000A connectors 14
- ET10000A connectors 17

## D

### default gateway configuration, management port 58

## diagnostics

### power up codes

- ET0010A description 75
- ET0100A description 76
- ET1000A description 76

## diagrams

### ET0010A

- front panel connectors 10
- front panel LEDs 11
- rear panel connectors 12

### ET0100A

- front panel connectors 12
- front panel LEDs 12
- rear panel 13

### ET1000A

- front panel connectors 14
- front panel LEDs 15
- rear panel 16

### ET10000A

- front panel connectors 17
- front panel LEDs 17
- rear panel 19

## E

### environmental compliance 77

### error state 74

## F

### failures

- replacing appliances 65
- replacing ET1000A power supplies 66

### FIPS mode operation 63

### firewall ports 29

### front panel diagrams

- ET0010A 10, 11
- ET0100A 12
- ET1000A 14, 15
- ET10000A 17, 18

**I**

- initial setup
    - auto-negotiation settings 59
    - logging in through the serial port 57
    - overview 57
    - setting the management IP address 58
  - installation
    - ET0010A
      - applying power 35
      - connecting the cables 34
      - rack mounting 30
      - table top installation 32
    - ET0100A
      - applying power 39
      - connecting the cables 38
      - rack mounting 28
      - unpacking the shipping carton 37
    - ET1000A
      - applying power 45
      - cabling requirements 41
      - connecting the cables 44
      - rack mounting 42
      - unpacking the shipping carton 42
    - ET10000A
      - applying power 52
      - cabling requirements 48
      - connecting the cables 51
      - rack mounting 49
      - unpacking the shipping carton 49
  - firewall ports 29
  - IP address, setting on the management port 58
- L**
- LEDs
    - ET0010A indicator description 11
    - ET0100A indicator description 13
    - ET1000A indicator description 15
    - ET10000A indicator description 18
  - troubleshooting 73
- license**
- entering 62
  - for replacement units 66
  - viewing 63
- lithium battery warning 27**
- 
- logging in through the serial port 57**

**M**

- maintenance**
    - recommendations 65
    - replacing appliances 65
  - management interface**
    - auto-negotiation 59
    - default gateway 58
    - description 58
    - IP address 58
  - MIB support 24
- P**
- packing list**
    - ET0100A 37
    - ET1000A 42
    - ET10000A 49
  - pinouts**
    - ET0010A 70
  - port status**
    - ET0100A LED description 13
    - ET1000A LED description 15
    - ET0010A LED description 11
    - ET10000A LED description 18
  - ports, configuring your firewall 29**
  - power indicator LED**
    - ET0010A 11
    - ET0100A 13
    - ET1000A 15
    - ET10000A 18
  - power supply**
    - replacing on the ET1000A 66
    - replacing on the ET10000A 67
  - powering up the appliance**
    - ET0010A 35
    - ET0100A 39
    - ET1000A 45
    - ET10000A 52
- R**
- rack mount**
    - ET0010A instructions 30
    - ET0100A mounting instructions 37
    - preparation 28
  - rear panel diagrams**
    - ET0010A 12
    - ET0100A 12, 13
    - ET1000A 16
    - ET10000A 19

- regulatory information
  - ET0010A 78
  - ET0100A 79
  - ET1000A 80
  - ET10000A 82
- requirements
  - ET0100A cables 36
  - ET1000A cables 41
  - ET10000A cables 48
  - safety guidelines 27
  - software 27
- RoHS directive 77
- S**
- safety guidelines 27
- self-tests
  - ET0010A 75
  - ET0100A models 76
- serial port, logging in to the CLI 57
- SFTP server
  - third party software 28
- shutting down the ETEP 54
- software
  - ETEP software requirements 28
- specifications
  - ET0010A 21
  - ET0100A 22
  - ET1000A 23
  - ET10000A 24
- status LEDs
  - ET0010A self-tests 75
  - ET0100Ax self-tests 76
- T**
- tamper-evident seal 65
- throughput license
  - See also* license
  - entering 62
  - licensed ETEP speeds 62
- traffic status LED
  - ET0100A 13
  - ET1000A 15
  - ET0010A 11
  - ET10000A 18
- troubleshooting
  - diagnostic code display
    - ET0010A 75
    - ET0100A models 76
  - error state 74
  - LED indicators 73
  - power up codes
    - ET0010A 75
    - ET0100A models 76
- U**
- unpacking the shipping carton
  - ET0100A 37
  - ET1000A 42
  - ET10000A 49
- W**
- WEEE directive 77
- Z**
- zeroization
  - how it works 69
  - recovery from 70

**Black Box Tech Support: FREE! Live. 24/7.**

Tech support the  
way it should be.



Great tech support is just 30 seconds away at 724-746-5500 or [blackbox.com](http://blackbox.com).



### About Black Box

Black Box Network Services is your source for an extensive range of networking and infrastructure products. You'll find everything from cabinets and racks and power and surge protection products to media converters and Ethernet switches all supported by free, live 24/7 Tech support available in 30 seconds or less.

© Copyright 2012. All rights reserved. Black Box and the Double Diamond logo are registered trademarks, and EncrypTight is a trademark, of BB Technologies, Inc. Any third-party trademarks appearing in this manual are acknowledged to be the property of their respective owners.

ET0010A Installation Guide, version 2



## Free Manuals Download Website

<http://myh66.com>

<http://usermanuals.us>

<http://www.somanuals.com>

<http://www.4manuals.cc>

<http://www.manual-lib.com>

<http://www.404manual.com>

<http://www.luxmanual.com>

<http://aubethermostatmanual.com>

Golf course search by state

<http://golfingnear.com>

Email search by domain

<http://emailbydomain.com>

Auto manuals search

<http://auto.somanuals.com>

TV manuals search

<http://tv.somanuals.com>