



# Compact T1

## QUICK START GUIDE



---

**CUSTOMER  
SUPPORT  
INFORMATION**

Order toll-free in the U.S.: Call **877-877-BBOX** (outside the U.S. call **724-746-5500**)  
FREE technical support, 24 hours a day, 7 days a week: Call **724-746-5500** or fax **724-746-0746**  
Mail order: **Black Box Corporation**, 1000 Park Drive, Lawrence, PA 15055-1018  
Web site: [www.blackbox.com](http://www.blackbox.com) • E-mail: [info@blackbox.com](mailto:info@blackbox.com)

---

**Supporting Software Version:**

Controller 6.1

IP Router 1.6

CMG Router 2.0

# PREFACE

---

## *Safety Information*

---

**CAUTION!** ALWAYS USE CAUTION WHEN INSTALLING TELEPHONE LINES. READ THE CAUTIONS BELOW FOR DETAILS ON SAFETY GUIDELINES TO PREVENT INJURY.

---

- **Never touch uninsulated telephone wires and terminals** unless the telephone line has been disconnected at the Network Interface (NI) as voltage potentials as high as 300 VAC may be present across the transmit and receive pairs.
- **Only use No. 26 AWG or larger** telecommunication line cord, to reduce the risk of fire.
- **Never install telephone wiring during a lightning storm.**
- **Never install telephone jacks in wet locations** unless the jack is specifically designed for wet locations.
- Refer to the installation section of this manual for a safe and proper installation procedure. All wiring external to this equipment should follow the current provision of the National Electrical Code.

## *Preface*

### *Electrostatic Discharge (ESD) Precautions*

---

## **Electrostatic Discharge (ESD) Precautions**

ESD can damage processors, circuit cards, and other electronic components. Always observe the following precautions before installing a system component.

1. Do not remove a component from its protective packaging until ready to install it.
2. Wear a wrist grounding strap and attach it to a metal part of the system unit before handling components. If a wrist strap is not available, maintain contact with the system unit throughout any procedure requiring ESD protection.

---

**WARNING! INTEGRATED CIRCUITS (ICs) ARE EXTREMELY SUSCEPTIBLE TO ELECTROSTATIC DISCHARGE. UNLESS YOU ARE A QUALIFIED SERVICE TECHNICIAN WHO USES TOOLS AND TECHNIQUES THAT CONFORM TO ACCEPTED INDUSTRY PRACTICES, DO NOT HANDLE ICs.**

---

The ESD warning label appears on packages and storage bags that contain static-sensitive products and components.



# QUICK START

---

## **In this Guide**

- Unpacking and Inspection
- Installation Environment
- Assembly of Compact T1
- Wall Mounting
- Rack Mounting (Optional Feature)
- Compliant Installation
- Chassis Connectors and Buttons
- Interface Connectors
- Local and Remote Management Option
- Configuration
- Controller Cards
- Power Supplies
- Service Cards

## Unpacking and Inspection

---

**WARNING! OBSERVE PRECAUTIONS FOR HANDLING ELECTROSTATIC DEVICES.**

---

1. Inspect containers for damage during shipment. Report any damage to the freight carrier for possible insurance claims.
2. Compare packing list with office records. Report any discrepancies to the office.
3. Open shipping containers, be careful not to damage contents.
4. Inspect contents and report any damage.
5. If equipment must be returned for any reason, carefully repack equipment in the original shipping container with original packing materials if possible.
6. If equipment is to be installed later, replace equipment in original shipping container and store in a safe place until ready to install.

## Installation Environment

The environment in which you are installing the Compact T1 must meet the following conditions:

- Operating temperature range: 32° to 104° F (0° to 40° C)
- Storage temperature range: -40° to 158° F (-40° to 70° C)
- Cooling method is by free air convection, requires long axis of unit to be mounted horizontally
- Maximum operating altitude: 10,000 ft. (3,048 m)
- Maximum non-operating altitude: 40,000 ft. (12,192 m)
- Relative humidity (non-condensing) range: 0 to 95%

For operation outside the defined environment requirements, the Compact T1 must be placed in an environmentally controlled enclosure.

## Assembly of Compact T1

The cards should be positioned in the chassis as follows:

Note: Slots are labeled on the top and the bottom of the chassis.

- Power Supply in the POWER Slot
- T1 Controller in Slot A
- Service Cards can be in any slot 1 through 6.  
Note: When an Unit is mounted to the wall, cards that use the front cable connections should be loaded from Slot 6 to 1. This will minimize card access issues due to cable interference.
- Always install blank faceplates in any unused slots.

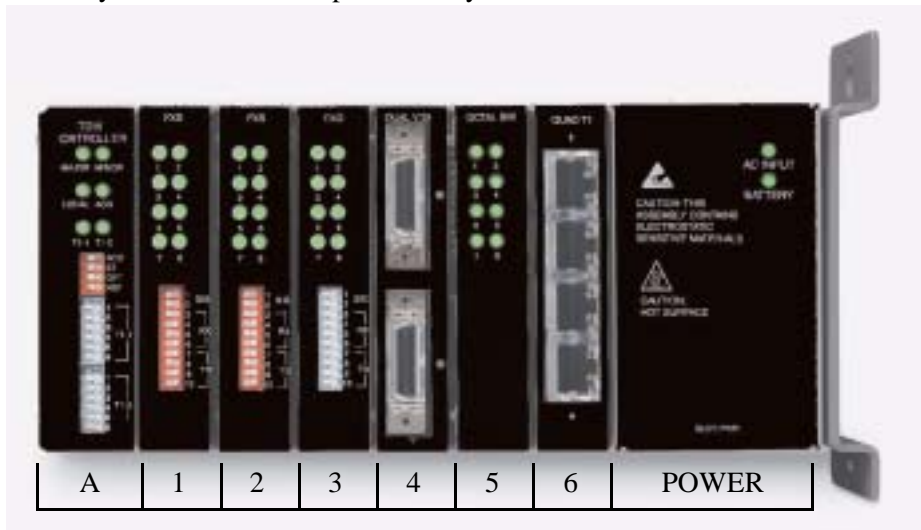

Service Card Slots

## Wall Mounting

Before beginning the mounting process, verify that the area meets the following requirements:

- A stable environment, clean and free from extremes of temperature, shock, vibration and EMI, that meets the all installation environment requirements, see *Installation Environment on page 1-2*.

Leave adequate clearance at the back for access to connectors

Leave at least 3.5" above and below the Unit for adequate ventilation



Mounting Bracket

Leave at least 14" at the front of the unit for access to cards and DIP switches

The Unit is delivered with a mounting bracket attached for quick and easy wall mounting, as shown in the illustration above.

To install the unit to the wall, attach the unit using the four screws provided, one at each bracket foot.

**NOTE:** Do not mount the Unit in any other orientation as show above.



## ***Rack Mounting (Optional Feature)***

Rack mounting kits are available for both 19 and 23 inch racks.

***To rack mount the Unit, follow the instructions below:***

1. Attach bracket ears to rack mounting bracket using four #8-32 x 3/16" screws on each side.

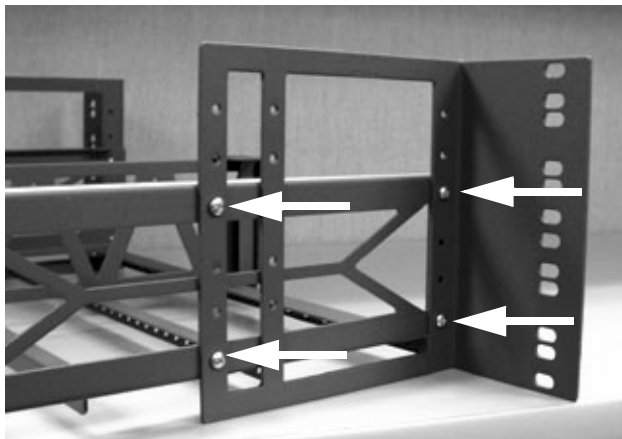

**Bracket Ear  
Left Side View**

## **Quick Start**

### *Rack Mounting (Optional Feature)*

---

2. Attach heat baffle to bracket ears using two #8-32 x 5/16" screws on each side.

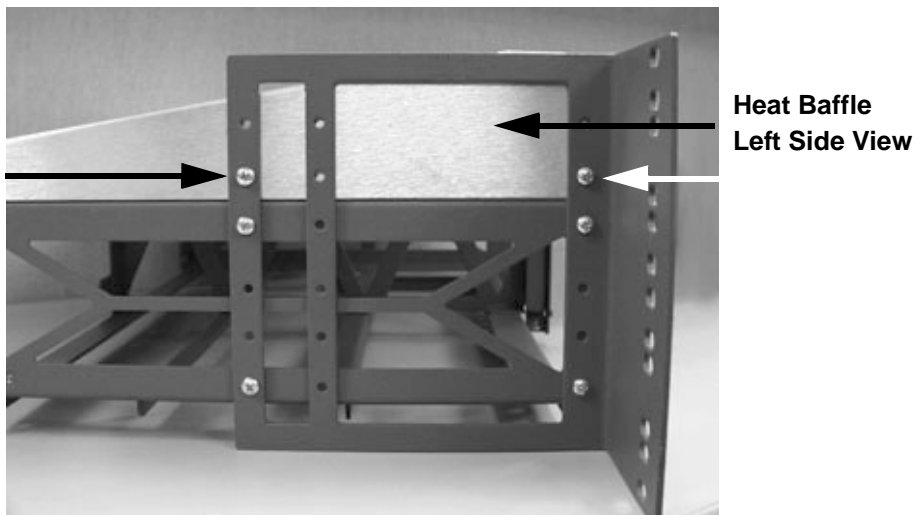

3. Attach rack mounting bracket ears to rack using two #12-24 x 5/8" rack mounting screws on each side.

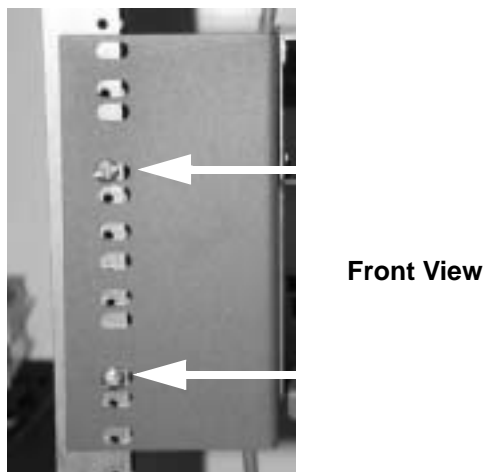

4. Remove wall mount and screws from Unit.



5. Slide the Unit into rack mounting bracket.



**Thumbscrew**

6. Swing the front latch up to secure the Unit(s), and tighten thumbscrew.

## Quick Start

### Rack Mounting (Optional Feature)

---

As many as 20 Units can be mounted on a single 7 foot rack, as shown in the following illustration (2 Adits are mounted side-by side and 10 high).

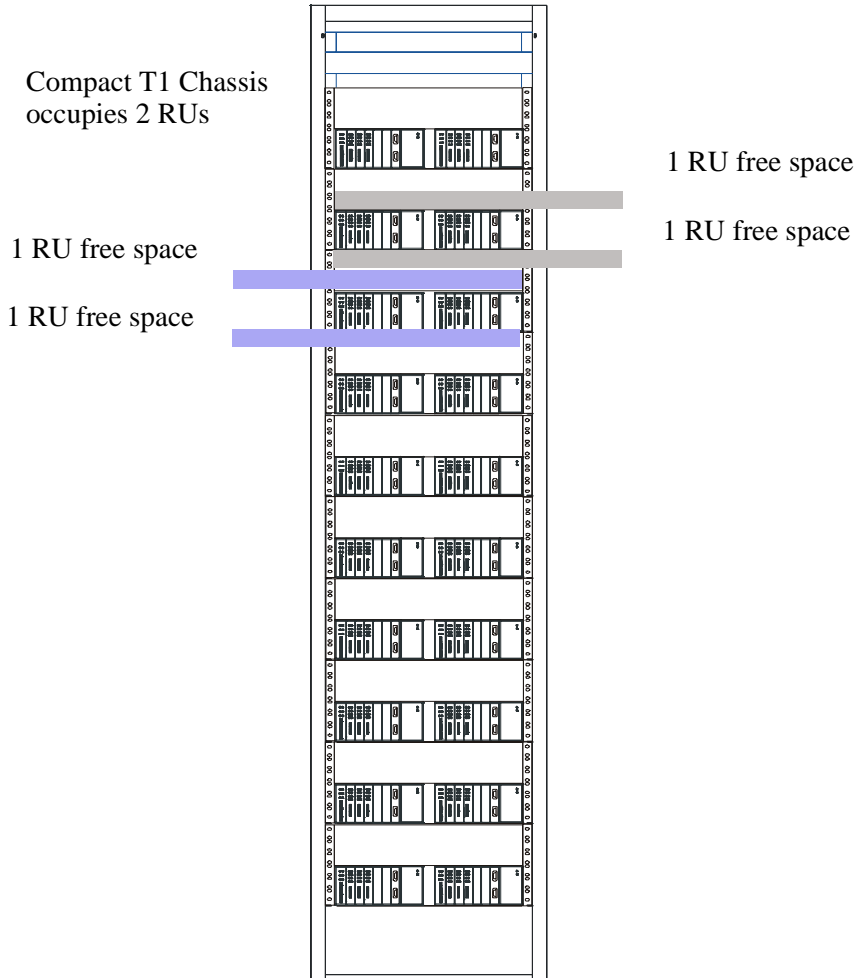

Compact T1 Chassis = 2 RUs (3.5 in) Spacing = 1 RU above and below for **each** unit.

---

**NOTE:** the mounting brackets are 7 inches high and will not allow units to be mounted closer than recommended.

---

## Compliant Installation

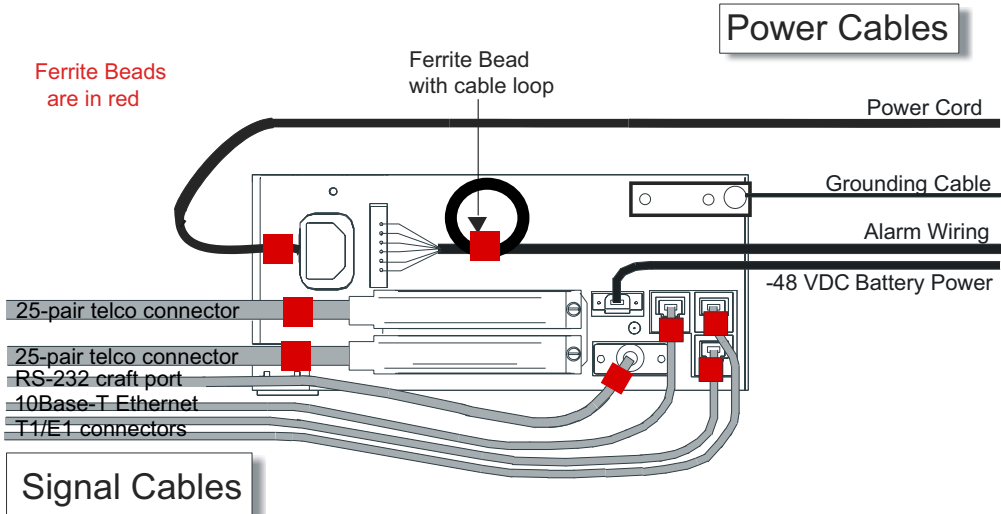

1. Connect all of the signal cables as shown in the illustration above, and secure them with a plastic tie. Dress the signal cables toward the left of the unit.
2. If using the 115V Power Supply, connect the -48 VDC battery power cable
3. Secure the ground lugs to the terminals using the nuts provided.
4. Secure the power cable and the ground cable with a plastic tie (not included). Keep these cables separate from the signal cables.
5. Terminate each signal cable to its appropriate connector.
6. Secure the signal cables using the small holes along the bottom of the rack and plastic ties (not included).

**NOTE:** It is important that the Signal Cables are secured separately from the Power Cables, for proper equipment operation.

## Quick Start

### Compliant Installation

---

## Ferrite Beads

To be compliant with Part 15A of the FCC and for NEBS compliant facilities, the following beads are included with each chassis, as well as additional ferrite bead(s) with the Service cards listed below.

### Ferrite Beads shipped with Adit chassis:

Ferrite Provided	Intended For
1 large	(1) Power (AC or DC) cable
3 small	(2) One on each T1 cable (1) Ethernet (10Base-T) cable

### Service Card Cables that Require Additional Ferrite Beads:

Card	Ferrites Shipped with Card	Intended For
ISDN BRI	2 large	(1) 25-pair Telco cable (ISDN BRI card in slot 1-3 top telco, 4-6 bottom) (1) Alarm cable (requires a loop through the bead, see drawing above)
OCU-DP	1 large	Alarm cable (requires a loop through the bead, see drawing above)
Quad T1	2 large	T1 cables from front of Quad T1 card (1 bead can hold 1-4 cables) <b>or</b> , (2) One on each 25-pair Telco cable
IP Router	1 small	Ethernet Cable (from front of card)
CMG Router	1 small	Ethernet Cable (from front of card)

For additional information on Ferrite beads and their installation on the unit, please contact Customer Support.

## **Chassis Connectors and Buttons**

The following illustrations show all connectors on the back of the unit.

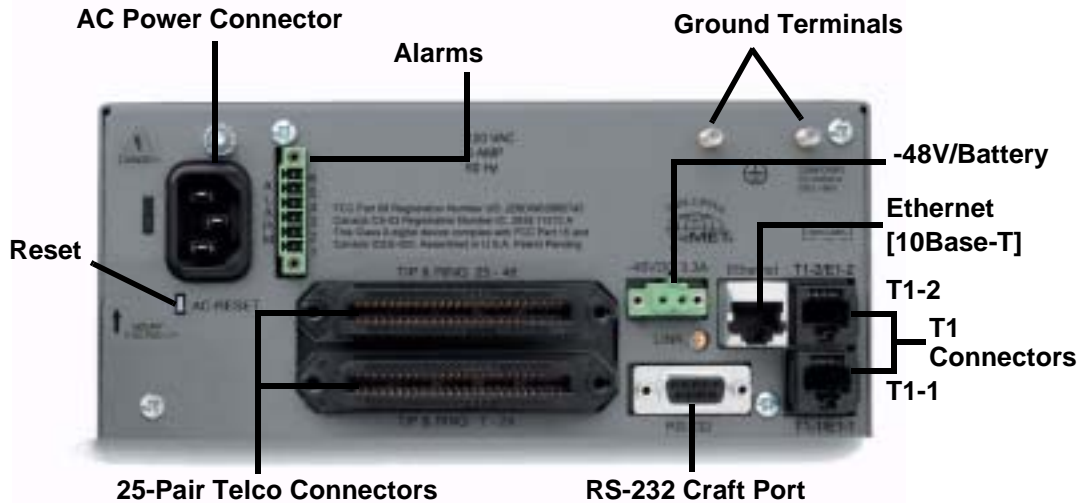

## **Interface Connectors**

The following are the Compact T1 chassis interface connectors:

- T1-1 and T1-2 line connection ports each equipped with standard RJ-48C 8-pin connector jack
- RS-232 craft port connector
- Tip and Ring Analog Interfaces equipped with standard 25-pair Telco Connectors
- 10Base-T Ethernet port to be connected to a remote management tool such as Telnet or an SNMP-based Network Management System with an RJ-45 8-pin connector jack
- External Alarm Connector
- Ground Lugs

## Chassis Ground Connector



1. Route wire (#6 or #8 AWG copper) from building ground to lug on Unit.
2. Strip insulation off wire end, if necessary.

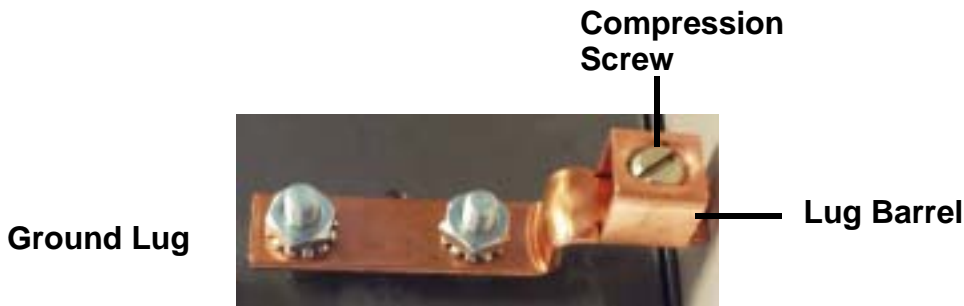

3. Loosen compression screw until opening is large enough to accept ground wire.
4. Insert ground wire into lug barrel, beneath compression plate and tighten compression screw.
5. Attach ground lug to chassis



## Power Reset

This is a resettable circuit breaker. If at any time there is a short or power surge on the incoming AC/DC line, the breaker will trip to protect the Power supply from damage.

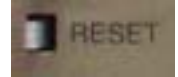

## Power Connections

### AC Power

The AC Power cord is a standard AC Power cord and is provided with a 115 VAC Power Supply.

#### To connect the Power Cord:

1. Insert power cord (male-end) to AC power source.
2. Plug connector into the Unit.
3. A green light should appear on the DC Input LED on the front of the Power Supply.



AC Power Connector

### -48V Battery

The -48 VDC input connector on the Unit is used for either direct DC powering of the Unit or for a Battery Backup connection when AC is used. There is no power cable provided for this connector, however the connector is provided.

The pinouts are as follows:

Pin #	Description
1 (+)	Battery return
2 (-)	-48VDC



1(+) 2(-)

Connector  
on back  
of Unit  
(male)

**WARNING!** POSSIBLE SHOCK HAZARD EXISTS, PLEASE FOLLOW INSTRUCTIONS CAREFULLY.

## Quick Start

### Interface Connectors

---

#### To connect -48 VDC power:

1. Ensure that no power is present on the two wires to be connected.
2. Strip the two wires from the power source so that approximately 5/16 inch of bare wire is exposed. 16 or 18 AWG insulated copper wire is recommended for power connections.
3. Insert the Battery Return and DC wires into the appropriate square holes, one at a time.
4. Tighten screws to clamp wires.
5. Ensure that no bare wire shows after the wires are installed.
6. Plug connector in the -48 VDC connector, as seen in the graphic and secure with set screws.
7. Apply power to connector from -48 VDC power source.
8. Verify with voltmeter that voltage is correct and polarity is correct.
9. Plug connector in the -48 VDC connector, as seen in the graphic and secure with set screws.

Connector  
on back  
of Unit  
(male)



1(+) 2(-)

Provided connector (female)



Battery Return  
1(+)

-48 VDC  
2(-)



Battery  
Return (+)

-48 VDC (-)



## External Alarm Connector

The external alarm 6-pin connector with one input pair (pins 5 and 6) and two output pairs (pins 1 and 2 - major alarms; pins 3 and 4 - minor alarms).

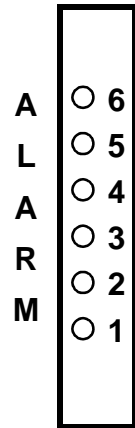

The pinouts are as follows:

Pin #	Description	Explanation
1	Major Alarm +	The major alarm output is available for power supply or major alarm failure alerting. The maximum voltage across the contacts is 350 V, and the maximum current is 150 mA.  This alarm is closed when power is off.
2	Major Alarm -	
3	Minor Alarm +	The minor alarm output is available for power supply or minor alarm failure alerting. The maximum voltage across the contacts is 350 V, and the maximum current is 150 mA.  This alarm remains open when power is off.
4	Minor Alarm -	
5	Alarm In +	The alarm inputs provide 5 VDC across the two contacts, and generate an alarm when a short circuit is detected between the contacts.  The alarm generated is a minor severity alarm.
6	Alarm In -	

## Quick Start

### Interface Connectors

## 25-Pair Telco Connectors

Tip and Ring Analog Interfaces equipped with standard 25-pair Telco Connectors (female) for connection to key systems, fax machines, modems, and PBXs. These interfaces are also used for ISDN BRI ports and are jumper selectable on the Quad T1 card.

Circuit connections are made at the 25-pair telco connectors. A standard 25-pair telephone cable with RJ-21X wiring and a male D-type connector at the Unit end is required.

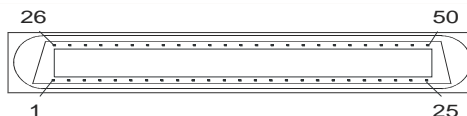

The pinouts are as follows:

Pair	Pin Location	Function	Color Code
1	26 1	Tip Channel 1 Ring Channel 1	White/Blue Blue/White
2	27 2	Tip Channel 2 Ring Channel 2	White/Orange Orange/White
3	28 3	Tip Channel 3 Ring Channel 3	White/Green Green/White
4	29 4	Tip Channel 4 Ring Channel 4	White/Brown Brown/White
5	30 5	Tip Channel 5 Ring Channel 5	White/Slate Slate/White
6	31 6	Tip Channel 6 Ring Channel 6	Red/Blue Blue/Red
7	32 7	Tip Channel 7 Ring Channel 7	Red/Orange Orange/Red
8	33 8	Tip Channel 8 Ring Channel 8	Red/Green Green/Red
9	34 9	Tip Channel 9 Ring Channel 9	Red/Brown Brown/Red
10	35 10	Tip Channel 10 Ring Channel 10	Red/Slate Slate/Red

<b>Pair</b>	<b>Pin Location</b>	<b>Function</b>	<b>Color Code</b>
11	36 11	Tip Channel 11 Ring Channel 11	Black/Blue Blue/Black
12	37 12	Tip Channel 12 Ring Channel 12	Black/Orange Orange/Black
13	38 13	Tip Channel 13 Ring Channel 13	Black/Green Green/Black
14	39 14	Tip Channel 14 Ring Channel 14	Black/Brown Brown/Black
15	40 15	Tip Channel 15 Ring Channel 15	Black/Slate Slate/Black
16	41 16	Tip Channel 16 Ring Channel 16	Yellow/Blue Blue/Yellow
17	42 17	Tip Channel 17 Ring Channel 17	Yellow/Orange Orange/Yellow
18	43 18	Tip Channel 18 Ring Channel 18	Yellow/Green Green/Yellow
19	44 19	Tip Channel 19 Ring Channel 19	Yellow/Brown Brown/Yellow
20	45 20	Tip Channel 20 Ring Channel 20	Yellow/Slate Slate/Yellow
21	46 21	Tip Channel 21 Ring Channel 21	Violet/Blue Blue/Violet
22	47 22	Tip Channel 22 Ring Channel 22	Violet/Orange Orange/Violet
23	48 23	Tip Channel 23 Ring Channel 23	Violet/Green Green/Violet
24	49 24	Tip Channel 24 Ring Channel 24	Violet/Brown Brown/Violet
25	50 25	Reserved	Violet/Slate Slate/Violet

## Quick Start

### Interface Connectors

#### RS-232 Craft Port (Female DB-9)

The RS-232 craft port connector (female) is for connection to an external PC or Hayes-compatible modem for local or remote configuration, management, and performance monitoring using the Command Line Interface (CLI).

The RS-232 craft port connects via a female DB-9 connector on the Unit.

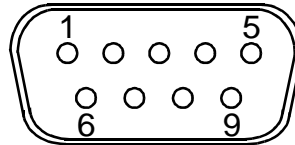

The pinouts are as follows:

Pin Number	Direction	Description
1	Outbound	Carrier Detect
2	Outbound	Receive Data
3	Inbound	Transmit Data
4	Inbound	Data Terminal Ready
5	N/A	Signal Ground
6	Outbound	Data Set Ready
7	Inbound	Request to Send
8	Outbound	Clear to Send
9	N/C	Not connected

## **T1 Connection Ports**

The T1 connection ports are each equipped with a standard RJ-48C (female) on the Unit.

The pinouts are as follows:

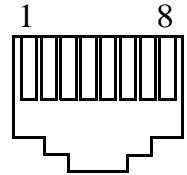

### **T1 (RJ-48C)**

Pin	Name	Description
1	Receive Ring	Receive from DS1 network
2	Receive Tip	Receive from DS1 network
3	N/C	Not connected
4	Transmit Ring	To DS1 network
5	Transmit Tip	To DS1 network
6 - 8	N/C	Not connected

## **10Base-T Ethernet**

The 10Base-T Ethernet (female) port to connect to a remote management tool such as Telnet or an SNMP-based Network Management System. **Note a LINK LED on the back of the unit displays green when the system has a good ethernet link.**

The pinouts are as follows:

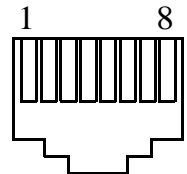

### **Ethernet (RJ-45)**

Pin	Name	Description
1	Receive +	Receive from network
2	Receive -	Receive from network
3	Transmit +	Transmit to network
4 - 5	N/C	Not connected
6	Transmit -	Transmit to network
7 - 8	N/C	Not connected

## **Quick Start**

### *Local and Remote Management Option*

---

## **Local and Remote Management Option**

This Quick Start Guide will focus on CLI and DIP switches. If you need further information on other management options, please refer to the Compact T1 User Manual.

- Local using CLI, Telnet, SNMP or DIP Switches (Controller and voice cards)
- Remotely over an in-band DS0 or through the Access Navigator over the FDL or an in-band DS0

### **Command Line Interface (CLI)**

You can access the CLI using either of the following methods:

- RS-232 connected to the DB-9 port.
- Telnet via Ethernet (10Base-T)

#### **Setting up a CLI connection**

To connect to the CLI via the RS-232 port, set up a connection to a PC serial port or dumb terminal using Hyperterm, ProComm, or similar terminal emulation software:

- Set the port settings to: **9600 baud 8/N/1/No Flow Control**
- Set the terminal emulation screen size to 24 lines by 80 characters.
- The Compact T1 default is set configure locally (using DIP switches). Use the *set local off* command to enable the use of CLI commands.



## **Configuration**

The following basic setups and upgrades for the Compact T1 are shown below using CLI. For more information on CLI commands and configurations, see the Compact T1 User Manual.

- ***Initial Setup***
- ***Set Up Security***
- ***Set Up a DS1/T1***
- ***Set Up a DS0/Channel***
- ***Set Up an Analog Port***
- ***Set Up the Router (IP or CMG) Cards***
- ***Establish a Static Channel Connection***
- ***Set Up a ISDN BRI Service***
- ***Set Up the OCU-DP Card***
- ***Set Up a V.35 Port***
- ***Change the IP Address of the DS0 Management Channel***
- ***Upgrade the Controller Software***
- ***Upgrade the Router (IP or CMG) Software***
- ***Install Country Specific Ringer Tones***

## Initial Setup

Use the following commands for your initial setup, for further information see the specific command listed in this chapter.

Command	Description
<code>set local off</code>	Disables DIP switches.
<code>set date {mm/dd/yyyy}</code>	Set the date used for event logging.
<code>set time {hh:mm:ss}</code>	Set the time used for event logging.
<code>set id {"id-name"}</code>	Set a system ID name.
<code>set clock1 {slot:port}</code> <code>internal</code>	Set the primary clock source.
<code>set clock2 {slot:port}</code> <code>internal</code>	Set the secondary clock source.
<code>set ethernet ip address</code> <code>{ip-addr} {mask}</code>	Set the ethernet IP address, in the conventional IP address format.
<code>set ip gateway {ip-addr}</code>	Set the IP gateway, in the conventional IP address format.

## Set Up Security

Use the following commands to set up the security on the Compact T1. See the *set user* command for details.

Command	Description
<code>set user {"username"}</code> <code>level {1-3}</code>	Specify the user name and the security level.
<code>set user {"username"}</code> <code>password</code>	Set a password for the user.

## Set Up a DS1/T1

Use the following commands to set up a DS1. See the *set (ds1)* command for more details.

Command	Description
<code>set {slot:port} up</code>	Activate the port.
<code>set {slot:port} id {"id-string"}</code>	Set the identification string.
<code>set {slot:port} lbo {1-9}</code>	Set the line buildout value for the DS1.
<code>set {slot:port} linecode {ami b8zs}</code>	Set the linecode for the DS1.
<code>set {slot:port} framing {d4 esf tr8afd1 tr8anofd1 tr8b}</code>	Set the framing option for the DS1.
<code>set {slot:port} loopdetect {on off}</code>	Set the detection/reaction to CSU loopcodes.

## Set Up a DS0/Channel

Use the following commands to set up a DS0. See the *set (ds0)* command for details.

Command	Description
<code>set {slot:port:channel} up</code>	Activate the channel.
<code>set {slot:port:channel} signal {1s gs emw emdwl emicpd dpt}</code>	Set the signaling option for the channel.
<code>set {slot:port:channel} type {data voice}</code>	Set the channel type.

## Set Up an Analog Port

Use the following commands to set up an analog port.

Command	Description
<code>set {slot:port} up</code>	Activate the port. See <i>set (ds1)</i> command for details.
<code>set {slot:port} signal {dpt gs gsrb gsw gswrb ls lscpd lsrb}</code>	Set the signaling option for the port. See the <i>set (fxs)</i> or <i>set (fxo)</i> command for details.
<code>set {slot:port} rxgain {n}</code>	Set the receive gain/loss in dB. See the <i>set (fxs)</i> or <i>set (fxo)</i> command for details.
<code>set {slot:port} txgain {n}</code>	Set the transmit gain/loss in dB. See the <i>set (fxs)</i> or <i>set (fxo)</i> command for details.

## Set Up the Router (IP or CMG) Cards

See the Router (IP or CMG) Quick Start Guides for detailed information. The following is the basic setup, see the Router family User Manuals or Quick Start Guides for the following configuration setups:

- PPP Internet Connection and Public IP Address Routing
- Frame Relay Internet Connection and Public IP Address Routing
- Internet Connection using PPP, NAT/PAT and Firewall Filters
- Internet Connection using NAT and Static NAT Addresses
- PPP Internet Connection and Public IP Address Routing
- Back-to-Back with PPP

Command	Description
<code>set {ds0-addr} type data</code>	Confirm DS0 is set to type data. ds0-addr = {slot:port:channel} of DS0 Example: set a:1:1-24 type data
<code>connect {slot:port:trunk} {slot:port:channel}</code>	Cross-connect T1 to router card. Example: connect a:1:1-24 6:1:1 (router in slot 6)
<code>set {router-addr} proxy</code>	Disable/enable router proxy. router-addr = {slot:port} of router card. Example: set 6:1 proxy disable.
<code>set {slot:port} up</code>	Set Router LAN as In-Service. Example: set 6:1 up
<code>telnet {router_card-addr}</code>	Telnet to Router card. router_card-addr = {slot} location of router card Example: telnet 6 (if earlier than 3.0 release {slot:port} must be used)
Local and Remote Profile Setup <code>reinitialize</code>	To enable any configuration changes, the card must be reinitialized.

## **Establish a Static Channel Connection**

Use the following commands to establish a static channel connection.

<b>Command</b>	<b>Description</b>
<code>set {slot:port:channel} type {voice data}</code>	Set the channel type for the channel you want to map. See <i>set (ds0)</i> command for details.
<code>set {slot:port:channel} signal {ls gs emw emdw emicpd dpt}</code>	Set the channel signaling option. See <i>set (ds0)</i> command for details.
<code>connect {slot:port} {slot:port}</code>	Connect the channels. See the <i>connect (card-trunk) (card-trunk)</i> command for details.

## **Set Up a ISDN BRI Service**

Use the following commands to set up a ISDN BRI Service. See the *set (bri)* command for details.

<b>Command</b>	<b>Description</b>
<code>set {slot:port} up</code>	Put the ISDN line In-Service.
<code>set {slot} mode {lt3ds0 lt4to1tdm nt3ds0}</code>	Set the ISDN mode.
<code>set {slot:port} crv {1-768}</code>	Set the Call Reference Value. Note: value must be the same as the Access Navigator.
<code>set {slot:port} threshold {day hour} {es ses}</code>	Set the threshold for the ISDN lines.
<code>set {slot} pmsync {adit switch}</code>	Set the source for performance monitoring synchronization.
<code>set {slot:port} autoactivate {on off}</code>	Only used in 4 to 1 mode. Establishes the D channel when the FDL link can not be used.

## Set Up the OCU-DP Card

The following is a basic setup for the OCU-DP card.

Command	Description
<pre>set {ocudp-addr} baud {2400 4800 9600 19200 38400  56000* 64000}</pre>	<p>Set the OCU-DP Baud rate. Where ocudp-addr = {slot:port} of the OCU-DP card to apply settings to.</p>
<pre>set {ocudp-addr} up</pre>	<p>Set the OCU-DP port 1 up.</p>
<pre>show {ocudp_card-addr}</pre>	<p>Show the OCU-DP card settings. Where ocudp_card-addr = {slot} of the OCU-DP card.</p>
<pre>disconnect a</pre>	<p>Disconnects all connections to slot a (controller)</p>
<pre>set {ds0-addr} type data</pre>	<p>Sets a DS0 data signaling type</p>
<pre>connect {ds0-addr} {ocudp-addr}</pre>	<p>Connects DS0 (in previous step) to OCU-DP port (in previous step).</p>
<pre>show connect (ocudp_card-addr)</pre>	<p>Displays connect information for OCU-DP card.</p>

## Set Up a V.35 Port

Use the following commands to set up a V.35 port. See the *set (v35)* command for details.

Command	Description
<code>set {slot:port} cts {cd high low rts}</code>	Set the Clear to Send operation mode.
<code>set {slot:port} data {invert normal}</code>	Set the data mode.
<code>set {slot:port} clock {source external}</code>	Set the clock mode.
<code>set {slot:port} speed {56K 64K}</code>	Set the speed.
<code>set {slot:port} txclkinv {invert normal}</code>	Set the transmit clock inversion mode.
<code>set {slot:port} rxclkinv {invert normal}</code>	Set the receive clock inversion mode.

## Change the IP Address of the DS0 Management Channel

Use the following commands to change the IP over DS0 Management Channel for the Compact T1.

Command	Description
<code>set ipds0 down</code>	Set the DS0 management channel down
<code>set ipds0 ip address {ip-addr}</code>	Set the DS0 management channel IP address.
<code>set ipds0 up</code>	Set the DS0 management channel up.



## **Upgrade the Controller Software**

Use the following commands to determine the system software level, then upgrade the software to the latest version.

<b>Command</b>	<b>Description</b>
<code>status equipment</code>	Determine the system software level. The Slot A line (SW Vers) will display the current software level
<code>load tftp {ip-addr} {"file-name"} (or load xmodem)</code>	Load the new controller system software. See the <i>load tftp</i> and <i>load xmodem</i> command for more information. Note: must have TFTP running in the background

## **Upgrade the Router (IP or CMG) Software**

Use the following commands to determine the Router card software level, then upgrade the software to the latest version.

<b>Command</b>	<b>Description</b>
<code>status equipment</code>	Determine the Router software level. The Router Slot line (SW Vers) will display the current software level
<code>load {router-slot} tftp {ip-addr} {"file-name"}</code>	Load the new Router software to the Adit Router card. See the <i>load tftp</i> command for more information. Note: must have TFTP running in the background

## **Install Country Specific Ringer Tones**

Use the following command to load the ringer tone for the location of the Compact T1. Ringer tones are shipped with the CMG Router software. The default tone is "us.tdb".

<b>Command</b>	<b>Description</b>
<code>load {cmg_card-addr} tftp {"tone_file"}</code>	Will load the tone file onto the CMG card. Note: must have TFTP running in the background.

## Controller Cards

### T1 Controller Card

#### Dip Switches

On the front of the T1 Controller card on the Compact T1 are DIP switches used to configure the Compact T1 locally.



Switch	Function	Description
ACO	Alarm Cut Off	<b>0</b> = Alarm contacts enabled (close when alarm occurs). <i>Default.</i> <b>1</b> = Alarm contacts disabled (open).
ST	Self Test	<b>0</b> = Normal operation. <i>Default.</i> <b>1</b> = Perform Self Test.
OPT	Spare	
RST	Reset	<b>0</b> = User-configured operation. <i>Default.</i> <b>1</b> = Reset configuration to factory defaults, & reset CLI password
T1-1 T2-1	Line Coding	<b>0</b> = B8ZS. <i>Default.</i> <b>1</b> = AMI
T1-2 T2-2	Line Loopback	<b>0</b> = Loopback off. <i>Default.</i> <b>1</b> = Loopback on
T1 3-4 T2 3-4	Framing	<b>0</b> = ESF (Extended Superframe). <i>Default.</i> <b>1</b> = D4
T1 5 - 6 T2 5 - 6	Signaling	

Switch 3	Switch 4	Switch 5	Switch 6	Setting
0	1	1	1	TR-08 A-Shelf with FDL, 16-bit Alarm frame
1	0	0	0	TR-08 A-Shelf with FDL, 13-bit Alarm frame
1	0	0	1	TR-08 A-Shelf with FDL disabled
1	0	1	0	TR-08 B-Shelf
0	0	0	0	Loop Start/Ground Start. <i>Default.</i>
0	0	0	1	E&M Immediate Start with ringback. (used for D3 PLAR and DPT)
0	0	1	0	E&M Immediate Start with ringback and Calling Party Disconnect (CPD)

## LEDs

The T1 Controller has a set of six LEDs you can use to troubleshoot your Compact T1. The table below describes each LED.



LED	State	Description
MAJOR	Off	No major alarms present
	Red	Major alarm present
MINOR	Off	No minor alarms present
	Yellow	Minor alarms present
LOCAL	Off	Remote mode (DIP switches disabled)
	Green	Local mode (DIP switches enabled)
ACO	Off	Normal mode. No alarms are being suppressed.
	Yellow	Alarm cutoff active. One or more active alarms suppressed.
T1-1 and T1-2	Off	Off line
	Green	Normal
	Red	Loss of Signal (LOS) detected
	Yellow	Bipolar Violation (BPV) detected
	Flashing Green	Loopback active
	Flashing Red	Loss of Frame (LOF) or Alarm Indication Signal (AIS) detected
	Flashing Yellow	Yellow alarm (Remote Alarm Indication) detected.

## Power Supplies

### 115 VAC/-48 VDC Power Supply



The power supply card has two LEDs, as described in the table below.

LED	State	Description
AC Input	Off	AC input missing or failure
	Green	AC input present
Battery	Off	Battery input not used
	Green	Battery charging or operating from DC source only.
	Yellow	Battery discharging
	Red	Battery low (less than 42V), ringer disabled

## Service Cards

### FXO Card

#### DIP Switch Settings

The DIP switches on the FXO card control all eight channels. In order to apply different settings to channels on the same card, use the CLI.



Switch	Function	Description	Note
1-2	Signal Type	1 2  <b>0 0</b> = FXO Loop Start <b>1 0</b> = FXO Ground Start <b>0 1</b> = DPT (use with E&M setting on T1) <b>1 1</b> = FXO Loop Start with Calling Party Disconnect	
3-6	Receive Gain/Loss	3 4 5 6  <b>0 0 0 0</b> = 0 dB <b>0 0 0 1</b> = -9 dB <b>0 0 1 0</b> = +2 dB <b>0 1 0 0</b> = +3 dB <b>1 0 0 0</b> = +4 dB	These settings allow for receive gain and losses of -9, -7, -6, -5, -4, -3, -2, 0, 2, 3, 4, 5, 6, and 7. <b>+9 (1110 is not available).</b>
7-10	Transmit Gain/Loss	7 8 9 10  <b>0 0 0 0</b> = 0 dB <b>0 0 0 1</b> = -9 dB <b>0 0 1 0</b> = +2 dB <b>0 1 0 0</b> = +3 dB <b>1 0 0 0</b> = +4 dB	These settings allow for transmit gain and losses of -9, -7, -6, -5, -4, -3, -2, 0, 2, 3, 4, 5, 6, and 7. <b>+9 (1110 is not available).</b>

#### LEDs

Each port on the FXO card has its own LED, as described in the table below

State	Loop Start Meaning	Ground Start Meaning	Dial Pulse Termination Meaning
Off	N/A	Idle (tip open)	Idle (loop open)
Green	Idle	Tip ground (incoming seizure)	Incoming seizure
Red	N/A	Ring ground (outgoing seizure)	Loop closure (outgoing seizure)
Yellow	Call in progress	Call in progress	Call in progress (reverse battery)
Flashing Green	Ringing	Ringing	N/A

## FXS Card

### DIP Switch Settings

Each FXS card contains ten DIP switches that can be used to select signaling options for all eight channels.



Switch	Function	Description	Note
1-2	Signal Type	1 2	
		<b>00</b> = FXS Loop Start <b>10</b> = FXS Ground Start	FXS and FXS5G card
		00 = R2	FXS INTL card
3-6	Receive Gain/Loss	3 4 5 6	These settings allow for receive gain and losses of -9, -7, -6, -5, -4, -3, -2, 0, 2, 3, 4, 5, 6, and 7. <b>+9 (1110) is not available.</b>
		<b>0000</b> = 0 dB	
		<b>0001</b> = -9 dB	
		<b>0010</b> = +2 dB	
		<b>0100</b> = +3 dB	
<b>1000</b> = +4 dB			
7-10	Transmit Gain/Loss	7 8 9 10	These settings allow for transmit gain and losses of -9, -7, -6, -5, -4, -3, -2, 0, 2, 3, 4, 5, 6, and 7. <b>+9 (1110) is not available.</b> Maximum setting on the 5G is +6 dB.
		<b>0000</b> = 0 dB	
		<b>0001</b> = -9 dB	
		<b>0010</b> = +2 dB	
		<b>0100</b> = +3 dB	
		<b>1000</b> = +4 dB	

### LEDs

Each port on the FXS card has its own LED, as described in the table below.

State	Loop Start Meaning	Ground Start Meaning
Off	N/A	Idle (tip open)
Green	Idle	Tip ground (incoming seizure)
Red	N/A	Ring ground (outgoing seizure)
Yellow	Call in progress	Call in progress
Flashing green	Ringing	Ringing

## ISDN BRI Card

There is an LED for each ISDN BRI on a card, as described in the table below:



State	Description
Off	Line U-interface is attempting synchronization, or BRI is Out-of-Service.
Red	Line alarm (LOS or self test failure)
Yellow	ES or SES has occurred.
Flashing yellow	Line U-interface is synchronized with customer equipment, but is not passing customer data.
Flashing green	Line U-interface is in external loopback toward the switch at the unit.
Green	Normal (Line U-interface is active and transparently passing customer data)

## OCU-DP Card

There are two LEDs for each channel on the OCU-DP card. The function for each LED is listed below:



State		Description
Yellow Flickering	ALL	Boot Software in control.
Green (walking down) Red (walking up)	ALL	Application Software in control (repeated 3.5 times).
Red, slow flash	ALL	In Boot. Application flash code checksums did not match and Boot is waiting for application download.
Red	ALL	In Application code waiting for Controller to issue SW/HW revision request. This is the first request that comes from the OCU-DP card manager in the Controller.
Green Yellow	Top Bottom	Port in Self-test. Duration is 5-8 seconds.
Off	Top Bottom	Port is set down (Out-Of-Service).
Green	Top	Port is receiving valid signals.
Red	Top	Port is receiving no signal (primary) or no frame sync (secondary or clear channel).
Red Flashing	Bottom	Port is receiving bipolar violations
Yellow	Bottom	Port is in loopback.

## Quad T1 Card

Each channel on the Quad T1 card has two LEDs. The description of the top LED is shown below, the bottom LED is not used with this application.



State	Description
Off	Off line
Green	Normal
Red	Loss of Signal (LOS)
Yellow	Bipolar Violation (BPV)
Flashing Green	Loopback active
Flashing Yellow	Yellow Alarm (Remote Alarm Indication)
Flashing Red (Slow)	Loss of Frame (LOF) or Alarm Indication Signal (AIS)
Flashing Red (Fast)	Self-test Failure

## V.35/V.54 Card

Each V.35 port has its own LED, as shown in the table below.



State	Description
Off	No T1 Assignment
Green	Normal (CD/RTS) Active
Red	CD inactive (T1-side failure)
Yellow	RTS inactive (equipment-side failure)
Flashing Yellow	Loopback toward T1 or equipment loop test
Flashing Green	Loopback toward equipment or network loop test



## CMG Router Card

The following chart describes each LED, and it's state, of the CMG Router card.



LED	State	Description
CRD	Off	Loss of power
	Green	No current alarms
	Red	Alarm state active. See alarm log for cause
	Red Flashing	Self-test or Boot in-process
	Yellow Flashing	Card is saving data to flash RAM, do not power down
VOIP	Off	No active VoIP calls or if the MGCP protocol is optioned <b>down</b>
	Green	Active VoIP calls
	Red	Call agent unreachable
	Yellow	Insufficient VoIP resources to complete call
LNK	Off	No ethernet link
	Green	Good ethernet link
10/100	Off	10 Mb ethernet
	Green	100 Mb ethernet
TX	Off	No ethernet transmit activity
	Green	Ethernet transmit activity
	Yellow	Current ethernet transmit collision
RX	Off	No current ethernet receive activity
	Green	Current ethernet receive activity

## IP Router Card

The following chart describes each LED, and it's state, of the Router card.



LED	State	Description
CRD	Off	Loss of power
	Green	No current alarms
	Red	Alarm state active. See alarm log for cause
	Red Flashing	Self-test or Boot in-process
	Yellow Flashing	Card is saving data to flash RAM, do not power down
10/100	Off	10 Mb ethernet
	Green	100 Mb ethernet
LNK	Off	No ethernet link
	Green	Good ethernet link
COL	Off	No current ethernet transmit collisions
	Yellow	Ethernet collisions have occurred and have not dropped to minimum level
	Yellow Flashing	Ethernet collision occurring
TX	Off	No ethernet transmit activity
	Green	Ethernet transmit activity
RX	Off	No current ethernet receive activity
	Green	Current ethernet receive activity

## Free Manuals Download Website

<http://myh66.com>

<http://usermanuals.us>

<http://www.somanuals.com>

<http://www.4manuals.cc>

<http://www.manual-lib.com>

<http://www.404manual.com>

<http://www.luxmanual.com>

<http://aubethermostatmanual.com>

Golf course search by state

<http://golfingnear.com>

Email search by domain

<http://emailbydomain.com>

Auto manuals search

<http://auto.somanuals.com>

TV manuals search

<http://tv.somanuals.com>