

8003

1/8 DIN

Temperature Controller

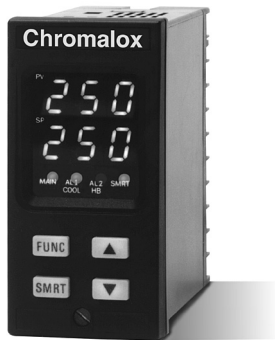

Issue Date
April 1994

USER'S MANUAL

0037-75212

Contents

Model Identification	Page ii
Dimensions and Panel Cutout	1
Wiring	2
Hardware Setup	3
Configuration Mode	4
Operator Mode	9
Error Messages	12
Warranty and Return	14

Model Identification

Model

8003

1/8 DIN Temperature Controller

Code Output 1 - Heat or Cool

1 SPDT Relay, 3 Amps at 250 Vac (Resistive) or
SSR Drive, 14V @ 20mA, Jumper Selectable

Code Output 2 - Cool or Alarm

1 Relay, 2 Amps at 250 Vac (Resistive) or
SSR Drive, 14V @ 20mA, Jumper Selectable

Code Options

0 None
1 Alarm #2, 2 Amps at 250 Vac (Resistive load)

Code Power Supply

3 100/240 Vac
5 24 Vac/dc

Code

0 Add to complete model number

8003 -

1

1

1

3

0

Typical Model Number

Download from www.Somanuals.com. All Manuals Search And Download.

Dimensions in inches (mm in parenthesis)

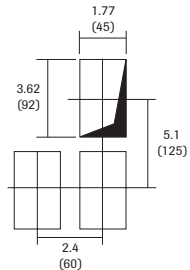
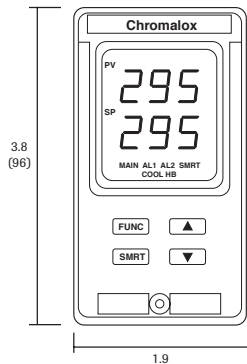
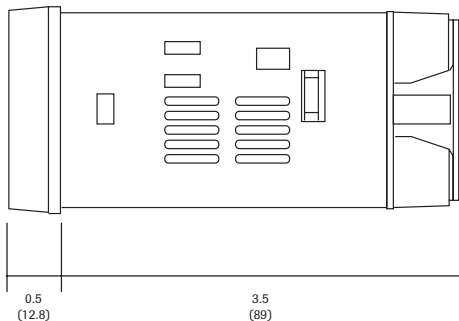

Wiring

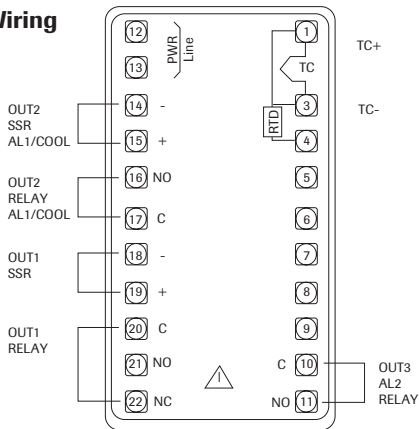

Warnings:

- When a relay output is used to drive an inductive load, it is suggested that you connect an external snubber network (RC) across the terminals in accordance with the following table (or use Chromalox snubber P/N 0149-01305):

Load Current (mA)	C (mF)	R (Ω)	P. (W)	Operating Voltage
<40 mA	0.047	100	1/2	260 Vac
<150 mA	0.1	22	2	260 Vac
<0.5 A	0.33	47	2	260 Vac

- Do not run sensor input wires together with power cables.
- For thermocouple (TC) wiring, use matching thermocouple extension wire (i.e. for J T/C, use type "J" thermocouple extension wire).
- When using shielded sensor cable, ground the shield at one end only.

Hardware Setup

To select the output type(s) and the alarm contact settings:

1. Remove the instrument from its case.
2. Move the jumpers to the desired position as shown in the diagram.
3. Set J304 and J305 as shown in the following figure.

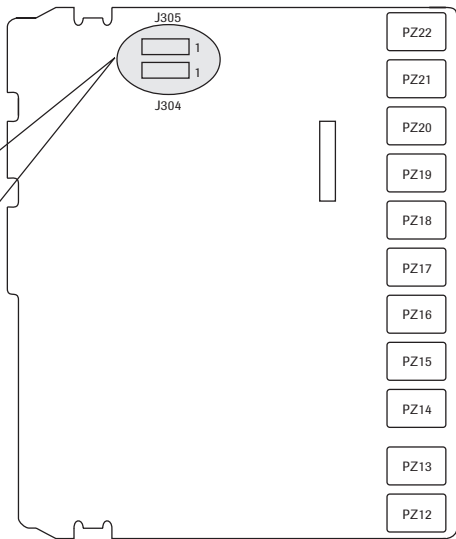
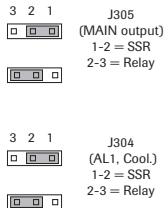

General Operation

There are two setup modes for the 8003:

- Configuration Mode
- Operator Mode

In general, the Configuration Mode is the initial setup of the controller when first installed. Input type and alarm setup are examples of Configuration Mode settings. The Operator Mode includes settings that might be adjusted frequently with daily control operations such as setpoints and PID parameters.

Notes for Configuration Mode:

- FUNC** = Stores the new value of a selected parameter and increments to the next parameter.
- SMRT** = Scrolls parameters back (in reverse order) without storing the new parameter value.
- ▲ = Increases the value of the selected parameter.
- ▼ = Decreases the value of the selected parameter.

Configuration Procedure

1. Remove the instrument from its case.
2. Set the internal switch V2 (see the following figure) in open position.

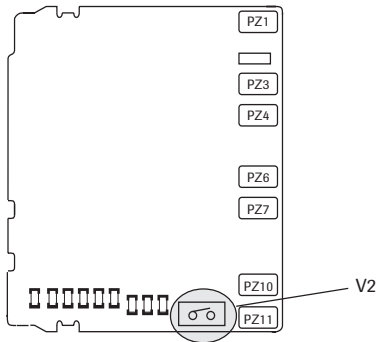

3. Reinsert the instrument in its case.
4. Switch on the instrument. "CNF" should be displayed in the upper display.

Note: If "CAL" indication is immediately displayed, press the ▲ pushbutton to return to the configuration mode (CNF).

5. Push the **FUNC** pushbutton.
The lower display shows the parameter code while the upper display shows the actual parameter value.

P1 = Input Type and Standard Range

			<u>Range</u>
0	= TC type	L	0 / +800 °C
1	= TC type	J	0 / +800 °C
2	= TC type	K	0 / +999 °C
3	= TC type	N	0 / +999 °C
4	= RTD type	Pt 100	-199 / +500 °C
5	= RTD type	Pt 100	-19.9 / +99.9 °C
8	= TC type	L	0 / +999 °F
9	= TC type	J	0 / +999 °F
10	= TC type	K	0 / +999 °F
11	= TC type	N	0 / +999 °F
12	= RTD type	Pt 100	-199 / +999 °F

P2 = Initial Scale Value

Not present when P1 = 5

The initial and full scale values are used by the PID algorithm to calculate the input span.

P3 = Full Scale Value

Not present when P1 = 5

The initial and full scale values are used by the PID algorithm to calculate the input span.

Note: the *minimum* input span (P3 - P2) is 300°C or 600°F for TC input and 100°C or 200°F for RTD input.

P4 = Output Configuration

H = Heating HC = Heating / cooling

P5 = Heating Output Type

rEL = Relay

SSr = SSR

The output type selected here must match hardware jumper setup (see page 2).

P6 = Cooling Element

Available only when P4 = HC

Air = Air

OIL = Oil

H2O = Water

P7 = Alarm 1 Type

Available only when P4 = H

0 = None

1 = Process alarm (absolute)

2 = Band alarm (+ and - deviation)

3 = Deviation alarm

P8 = Alarm 1 Operation

Available only when P7 is different from 0

H = High Alarm L = Low Alarm

(outside if band alarm) (inside if band alarm)

P9 = Alarm 1 Inhibit

Available only when P7 is different from 0.

- OFF = inhibit disabled
- ON = inhibit enabled

Note: The Alarm Inhibit disables the alarm action after a setpoint change. At startup, it automatically enables the alarm when the process temperature reaches the present condition.

P10 = Alarm 2 Type

- 0 = Not provided 2 = Band alarm
- 1 = Process alarm 3 = Deviation alarm

P11 = Alarm 2 Operative Mode

Available only when P10 is different from 0.

- H = High Alarm L = Low Alarm

P12 = Alarm 2 Inhibit

Available only when P10 is different from 0

- OFF = Inhibit disabled
- ON = Inhibit enabled

Note: The Alarm Inhibit disables the alarm action after a setpoint change. At startup, it automatically enables the alarm when the process temperature reaches the present condition.

P13 = Type of OFFSET Applied to the Measured Value

- P13 = 0 = constant OFFSET (P14) all over the range
- P13 different from 0 = P13 shows the application point of the offset value set by P14 parameter.

P14 = OFFSET Value

When P13 = 0, P14 is programmable, in engineering units, from -20 % to +20 % of the input range.

When P13 is different from 0, P14 is programmable from -20 % to + 20 % of P13 value.

-20% to +20%

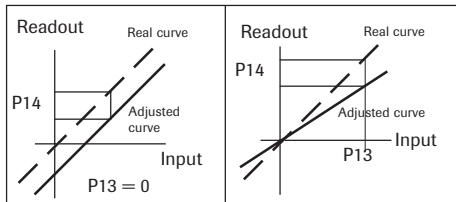

P15 = Threshold of the "Soft Start" Function

Enter the threshold value, in °F or °C, for the automatic start of the "Soft Start" function (output power limit). The range of this setting is determined by the range of the sensor selected in P1 (i.e., if type J T/C °F is selected in P1, range is 0-999).

If the unit powers-up below the threshold value, the "Soft Start" function is enabled and limits the power output to "OLH" for "toL" minutes. "OLH" and "toL are setup in the Operator Mode.

P16 = Not used

P17 = Not used

P18 = User Defined Security Code

0 = Security lock disabled (all Operator Mode parameters may be adjusted)

1 = Security lock enabled (only setpoints may be adjusted)
From 2 to 499 = SP parameter may be modified and other Operator Mode parameters may be accessed.

From 500 to 999 = SP, A1 and A2 parameters may be modified and other Operator Mode parameters may be accessed.

- When configuration is completed, the instrument shows " .-. ." on both displays.

End of Configuration

- Push the **FUNC** pushbutton. The instrument will return to the beginning of the configuration procedure.

For Advanced Configuration

- Push the ▲ or ▼ pushbutton and set the "217" code on the upper display.
- Push **FUNC**. The following advanced configuration parameters, P19-P29 will be displayed.

P19 = Main Output Action

Available only when P4 = H

r = Reverse (heating)

d = Direct (cooling)

Note: when P4 = HC, this parameter is forced to "r"

P21 = Alarm 1 Relay Action

This parameter is available only if P7 is different from 0 and P4 = H.

r = Reverse (relay de-energized in alarm condition)

d = Direct (relay energized in alarm condition)

P22 = Alarm 2 Relay Action

This parameter is available only if P10 is different from 0 and P16 is different from OFF.

r = Reverse (relay de-energized in alarm condition)

d = Direct (relay energized in alarm condition)

P23 = Automatic Adjustment of "Relative Cooling Gain"

OFF = the SMART function does not adjust the "relative cooling gain" parameter

ON = the SMART function adjusts the "relative cooling gain" parameter

P24 = Output Maximum Rate of Change

This parameter allows you to set the output maximum rate of change. P24 is programmable from 1 to 10% per second change of the control output. If blank display, no rate is applied and output changes in steps.

P25 = Protected Parameter Viewing

This parameter is available only if P18 is different from 0.

OFF = all protected parameters are not displayed

ON = the parameter values are displayed

P26 = SMART enabled/disabled

0 = SMART function is disabled

1 = SMART function enabling/disabling is NOT protected by the security code

2 = SMART function enabling/disabling is protected by the security code

P27 = Proportional Band Maximum Limit is Adjustable

SMART function—This parameter may be programmed from P28 or P29 value to 99.9.

P28 = Proportional Band Minimum Limit is Adjustable

SMART function in heating control only—This parameter may be programmed from 1.0% to P27 value.

P29 = Proportional Band Minimum Value is Adjustable

SMART function in heating/cooling only—This parameter may be programmed from 1.5% to P27 value.

SMART Function

SMART automatically determines the best PID control parameters for your application.

To enable the SMART function, push the SMRT pushbutton. The SMRT LED will light or flash according to the algorithm automatically selected.

When the SMART function is enabled, it is possible to display, but not to modify, the control parameters (PB, TI, TD and rC).

When the traditional PID control is desired, push the SMRT pushbutton again. The instrument maintains the last set of SMART PID control parameters and enables parameter modification.

- Notes:
1. When ON/OFF control is programmed (PB = 0), the SMART function is disabled.
 2. The SMART enabling/disabling is protected by security code.

Operator Mode

1. Remove the instrument from its case
2. Set the internal switch V2 in closed position
3. Re-insert the instrument
4. Switch on the instrument

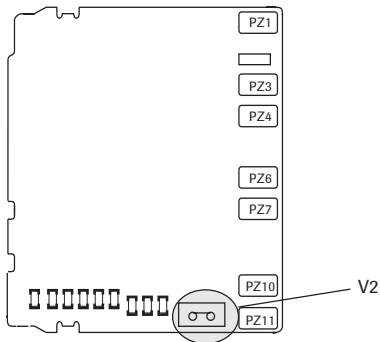

The upper display will show the measured value while the lower display will show the programmed setpoint value (we define this status as “normal display mode”).

Pushbutton functionality during operating mode :

- FUNC** = Stores the new value of a selected parameter and increments to the next parameter.
- SMRT** = Scrolls parameters back (in reverse order) without storing the new parameter value.
- ▲ = Increases the value of the selected parameter.
- ▼ = Decreases the value of the selected parameter.

Note: A 10 second timeout is operative during parameter modification.

If, during operator parameter modification, no pushbuttons are pressed for more than 10 seconds, the instrument goes automatically to the “normal display mode” and it stores only the new settings that were followed by pressing **FUNC** pushbutton.

Output Power Off

To turn OFF the output signal, push and hold the ▲ pushbutton, then push **FUNC**. Pressing both pushbuttons for more than 3 seconds will cause the instrument to display "OFF" instead of the setpoint value.

In the output power off condition, the parameters can always be reviewed and modified.

To return to normal control, press and hold the ▲ pushbutton and then push the **FUNC** pushbutton.

Press and hold both pushbuttons for more than 3 seconds. The instrument then goes to the NORMAL DISPLAY MODE.

8003 Operator Parameters

Push the **FUNC** pushbutton. The lower display shows the cue, the upper display shows the value of the selected parameter.

<u>Cue</u>	<u>Description</u>
SP	Control Setpoint, range from "rL" to "rH".
nnn	Software key for parameter protection set in Conf mode P18.
A1	Alarm 1 Setpoint, range from Conf mode P2 to P3.
A2	Alarm 2 Setpoint, range from Conf mode P2 to P3.
H1	Alarm 1 hysteresis (deadband) 0.1 to 10.0% of alarm span.
H2	Alarm 2 hysteresis (deadband) 0.1 to 10.0% of alarm span.
Pb	Proportional Band, range from 1.0 to 99.9% of span for heating output, 1.5 to 99.9% of span for heating/cooling output. If Pb = 0, ON/OFF control is enabled and ti, td, C, C2, rC, OLP, OLH and IOL are not displayed.
HS	Hysteresis (deadband) for ON/OFF control (active if Pb = 0), range 0.1 to 10.0% of span.
ti	Integral time (automatic reset), range 1 minute and 20 seconds to 20 minutes and 00 seconds, or if blank integral is disabled.
td	Derivative (rate), range 1 second to 9 minutes and 59 seconds. If 0, derivative is disabled.
C	Heating cycle time, range 1 to 200 seconds (30 seconds or greater recommended for relay outputs).
C2	Cycle Time for Output 2 (heat/cool control selected), range 1 to 200 seconds (30 seconds or greater recommended for relay outputs).
rC	Relative cooling gain (for heat/cool) control range 0.20 to 1.00.
OLP	Overlap/Deadzone (for heat/cool) Positive value is amount of overlap; negative value separation between heat and cool Pbs, range -20 to 50% of Pb.
rL	SP minimum value (low limit)
rH	SP maximum value (high limit)
rP	Ramp on setpoint changes, range 1 to 100 degrees/minute or blank (step change).
OLH	Output power max. value, range 0 to 100% heating, -100 to 100% heat/cool, limits power continuously (tOL = blank) or on startup per tOL settings.
tOL	Time interval for OLH power output limit, range 1 to 100 minutes or if blank infinite. The timer starts if the actual temperature is less than P15 (threshold value).

<u>Cue</u>	<u>Description</u>
SP	Control Setpoint, range from "rL" to "rH".
nnn	Software key for parameter protection set in Conf mode P18.
A1	Alarm 1 Setpoint, range from Conf mode P2 to P3.
A2	Alarm 2 Setpoint, range from Conf mode P2 to P3.
H1	Alarm 1 hysteresis (deadband) 0.1 to 10.0% of alarm span.
H2	Alarm 2 hysteresis (deadband) 0.1 to 10.0% of alarm span.
Pb	Proportional Band, range from 1.0 to 99.9% of span for heating output, 1.5 to 99.9% of span for heating/cooling output. If Pb = 0, ON/OFF control is enabled and ti, td, C, C2, rC, OLP, OLH and IOL are not displayed.
HS	Hysteresis (deadband) for ON/OFF control (active if Pb = 0), range 0.1 to 10.0% of span.
ti	Integral time (automatic reset), range 1 minute and 20 seconds to 20 minutes and 00 seconds, or if blank integral is disabled.

td	Derivative (rate), range 1 second to 9 minutes and 59 seconds. If 0, derivative is disabled.
C	Heating cycle time, range 1 to 200 seconds (30 seconds or greater recommended for relay outputs).
C2	Cycle Time for Output 2 (heat/cool control selected), range 1 to 200 seconds (30 seconds or greater recommended for relay outputs).
rC	Relative cooling gain (for heat/cool) control range 0.20 to 1.00.
OLP	Overlap/Deadzone (for heat/cool) Positive value is amount of overlap; negative value separation between heat and cool Pbs, range -20 to 50% of Pb.
rL	SP minimum value (low limit)
rH	SP maximum value (high limit)
rP	Ramp on setpoint changes, range 1 to 100 degrees/minute or blank (step change).
OLH	Output power max. value, range 0 to 100% heating, -100 to 100% heat/cool, limits power continuously (tOL = blank) or on startup per tOL settings.
tOL	Time interval for OLH power output limit, range 1 to 100 minutes or if blank infinite. The timer starts if the actual temperature is less than P15 (threshold value).

Error Messages

Overrange or Underrange Indications

The instrument shows the OVERRANGE conditions with the following indication on the upper display:



The instrument shows the UNDERRANGE conditions with the following indication on the upper display:



Burn-out conditions are shown as well as overrange condition.

For TC input it is possible to specify optional underrange indication when ordering the controller. Contact the factory for information.

Note: When an overrange condition is detected, the instrument forces the control output to the minimum possible value.

When an underrange condition is detected, the instrument forces the control output to the maximum possible value.

Error Messages

The instrument has a self-diagnostic algorithm. When an error is detected, the instrument shows “Err” indication on the lower display while the upper display shows the code of the detected error.

Error List

100	Write EEPROM error.
150	CPU error.
200	Write on protected memory.
201-2xx	Configuration parameter error. The two least significant digit's show the number of the wrong parameter (ex. 209 Err shows an Error on P9 parameter)
301	RTD input calibration error
305	TC input calibration error
307	RJ input calibration error
310	CT input calibration error

400	Control parameters error
500	Auto-zero error
502	RJ error
510	General error during calibration procedure

- Note:**
1. When a configuration parameter error is parameter only.
 2. If an error 400 is detected, simultaneously push the ▲ and ▼ pushbuttons for loading the default parameters, then repeat control parameter setting.
 3. For all the other errors, contact your supplier.

Warranty And Limitation Of Remedy And Reliability

Chromalox warrants only that the Products and parts manufactured by Chromalox, when shipped, and the work performed by Chromalox when performed, will meet all applicable specification and other specific product and work requirements (including those of performance), if any, and will be free from defects in material and workmanship under normal conditions of use. All claims for defective or nonconforming (both hereinafter called defective) Products, parts or work under this warranty must be made in writing immediately upon discovery, and in any event, within three (3) years from delivery, provided, however all claims for defective Products and parts must be made in writing no later than eighteen (18) months after shipment by Chromalox. Defective and nonconforming items must be held by Chromalox's inspections and returned to the original f.o.b. point upon request. THE FOREGOING IS EXPRESSLY IN LIEU OF ALL OTHER WARRANTIES WHATSOEVER, EXPRESS, IMPLIED AND STATUTORY, INCLUDING, WITHOUT LIMITATION, THE IMPLIED WARRANTIES OF MERCHANTABILITY AND FITNESS FOR A PARTICULAR PURPOSE.

Notwithstanding the provisions of this WARRANTY AND LIMITATIONS Clause, it is specifically understood that Products and parts not manufactured and work not performed by Chromalox are warranted only to the extent and in the manner that the same are warranted to Chromalox by Chromalox's vendors, and then only to the extent that Chromalox is reasonably able to enforce such a warranty, it being understood Chromalox shall have no obligation to initiate litigation unless buyer undertakes to pay all cost and expenses therefore including but not limited to attorney's fees, and indemnifies Chromalox against any liability to Chromalox's vendors arising out of such litigation.

Upon buyer's submission of a claim as provided above and in its substantiation, Chromalox shall at its option either (i) repair or replace its Products, parts or work at the original f.o.b. point of delivery or (ii) refund an equitable portion of the purchase price.

The foregoing is Chromalox's only obligation and buyer's exclusive remedy for breach of warranty, and is buyer's exclusive remedy against Chromalox for all claims arising hereunder or relating hereto whether such claims are based on breach of contract, tort (including negligence and strict liability) or other theories, buyer's failure to

submit a claim as provided above shall specifically waive all claims for damages or other relief, including but not limited to claims based on latent defects. In no event shall buyer be entitled to incidental or consequential damages and buyer should hold Chromalox harmless therefrom. Any action by buyer arising hereunder or relating hereto, whether based on breach of contract, tort (including negligence and strict liability) or other theories, must be commenced within three (3) years after the date of shipment or it shall be barred.

Returns

Items returned to Chromalox Instruments and Controls must be accompanied by a Return Authorization Number. This number may be obtained from Chromalox Instruments and Controls, Customer Service Department, Telephone Number (615) 793-3900. It should appear on the exterior of the shipping carton and on the shipping documents. Defective items will be repaired or replaced at our option, at no charge.

Return the defective part or product, freight prepaid, to:
Chromalox Instruments and Controls
1382 Heil-Quaker Blvd.
LaVergne, TN 37086-3536

Chromalox[®]

INSTRUMENTS AND CONTROLS

1382 HEIL QUAKER BOULEVARD
LAVERGNE, TN 37086-3536

PHONE (615) 793-3900

FAX (615) 793-3563

Free Manuals Download Website

<http://myh66.com>

<http://usermanuals.us>

<http://www.somanuals.com>

<http://www.4manuals.cc>

<http://www.manual-lib.com>

<http://www.404manual.com>

<http://www.luxmanual.com>

<http://aubethermostatmanual.com>

Golf course search by state

<http://golfingnear.com>

Email search by domain

<http://emailbydomain.com>

Auto manuals search

<http://auto.somanuals.com>

TV manuals search

<http://tv.somanuals.com>