

# FUZZYSCAN FIXED MOUNT SCANNER

**Programming Manual**

International Edition, Rev. A5

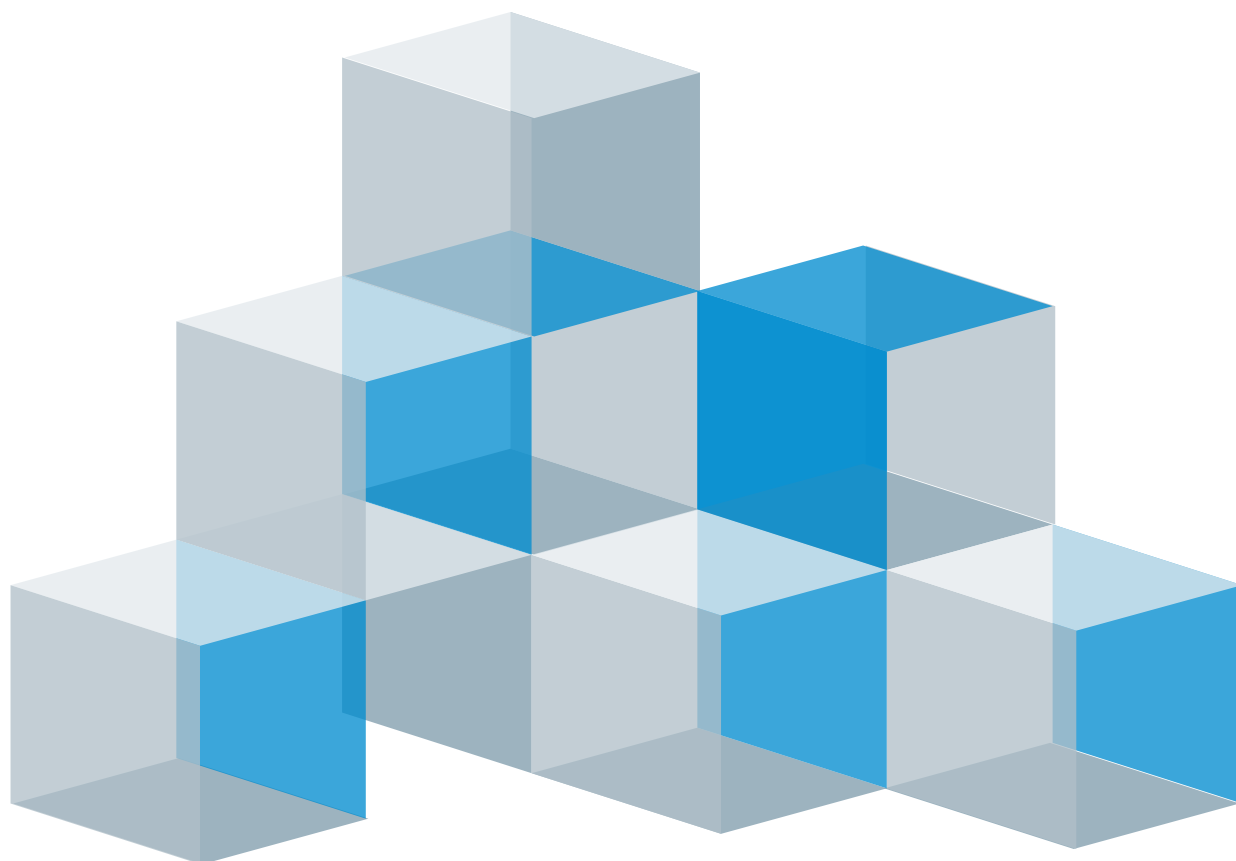

**cino**

## Revision History

Rev. No.	Released Date	Description
Rev. A	May 26, 2010	First Release
Rev. A1	Jun. 18, 2010	<ul style="list-style-type: none"> <li>❖ Page 16 Add "UPC/EAN Security Level"</li> <li>❖ Page 38 Add "Immediate" parameter (option 5) to "Time Delay to Low Power Mode" and change the default value from 5 seconds to immediate.</li> </ul>
Rev. A2	Sep. 16, 2010	<ul style="list-style-type: none"> <li>❖ Page 19,20 Add "Supplement Scan Voting" in Symbology Reading Control</li> <li>❖ Page 21 Add "EAN Supplement Control"</li> <li>❖ Page 32 Keyboard Layout – Add "Czech (QWERTY)", remove "Universal", and rename Spain (QWERTY) to Spain (Spanish QWERTY), Latin America (QWERTY) to Spain (Latin America, QWERTY)</li> <li>❖ Page 36 Cancel "Power On Indicator" and add "Good Read Indicator".</li> <li>❖ Page 41 "Scan Rate Control "</li> <li>❖ Page 45 Add "NG Message Output"</li> </ul>
Rev. A3	Nov 11, 2010	<ul style="list-style-type: none"> <li>❖ Page 38 Baud Rate – Cancel Baud Rate 300/600 BPS.</li> </ul>
Rev. A4	Mar 04, 2011	<ul style="list-style-type: none"> <li>❖ Page 38 Baud Rate – Revise 57.6K BPS and 115.2K BPS option code from 6.7. to 8.9.</li> </ul>
Rev. A5	Mar 22, 2011	<ul style="list-style-type: none"> <li>❖ Page 17 Add "Code 39 Security Level"</li> <li>❖ Page 39 Add "NAK Retry Count"</li> <li>Add "ACK/NAK Transmission Indication"</li> </ul>





© Copyright Cino Group  
© Copyright PC Worth Int'l Co., Ltd

Cino makes no warranty of any kind with regard to this publication, including, but not limited to, the implied warranty of merchantability and fitness for any particular purpose. Cino shall not be liable for errors contained herein or for incidental consequential damages in connection with the furnishing, performance, or use of this publication. This publication contains proprietary information that is protected by copyright. All rights are reserved. No part of this publication may be photocopied, reproduced or translated into any language, in any forms, in an electronic retrieval system or otherwise, without prior written permission of Cino. All product information and specifications shown in this document may be changed without prior notice.

## Warranty

Cino warrants its products against defects in workmanship and materials from the date of shipment, provided that the product is operated under normal and proper conditions. The warranty provisions and durations are furnished by different warranty programs. The above warranty does not apply to any product which has been (i) misused; (ii) damaged by accident or negligence; (iii) modified or altered by the purchaser or other party; (iv) repaired or tampered by unauthorized representatives; (v) operated or stored beyond the specified operational and environmental parameters; (vi) applied software, accessories or parts are not supplied by Cino; (vii) damaged by circumstances out of Cino's control, such as, but not limited to, lightning or fluctuation in electrical power. Any defective product must follow the warranty program and RMA procedures to return Cino for inspection.

## Regulatory

	FCC part 15B
	EN55022, EN55024, EN61000-3-2, EN61000-3-3
	CNS13438
	Industry Canada ICES-003
<b>LED Eye Safety</b>	IEC60825-1, EN60825-1

# Table of Contents

## Getting Started

Getting Familiar with Your FuzzyScan	1
Connect to Your Host	2
Install Your FuzzyScan	3
Use the Test Mode	4
Use Your FuzzyScan	5

## Configure Your FuzzyScan

Bar Code Programming Manual	7
Programming Procedures	8
Host Interface Selection	12
Symbology Reading Control	13
Keyboard Interface Control	32
Serial Interface Control	36
Operation Control	39
Condensed DataWizard	46

## Appendix

Symbology ID Table	53
Keyboard Function Code Table	54
ASCII Input Shortcut	55
Host Interface Quick Set	56
Operation Mode Quick Set	56
Option Codes	57
System Commands	58
Indications	59

## Getting Familiar with Your FuzzyScan

Thank you for choosing Cino FuzzyScan FM400 Series Fixed Mount Scanner. Integrated with the innovative FuzzyScan 2.0 Imaging Technology and durable ultra-compact design, FM400 series not only provides outstanding reading performance, but also meets various demands for both industrial and general purpose applications. This document provides a quick reference for installation and operation purpose. The complete documentation is available at [www.cino.com.tw](http://www.cino.com.tw).

### FM400 Series (Front-view Model)

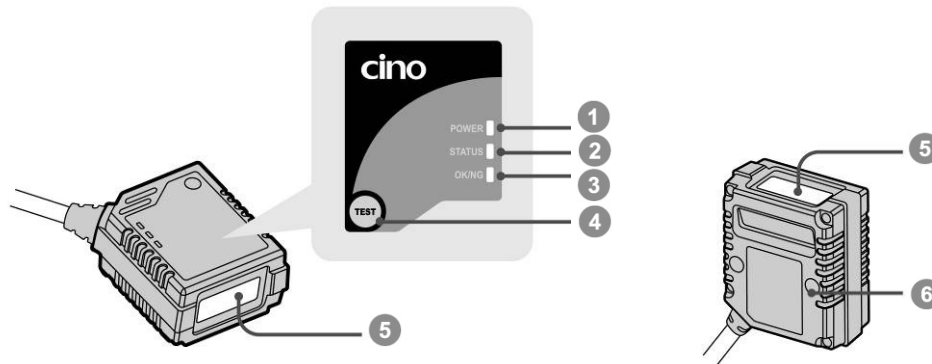

### FM400 Series (Side-view Model)

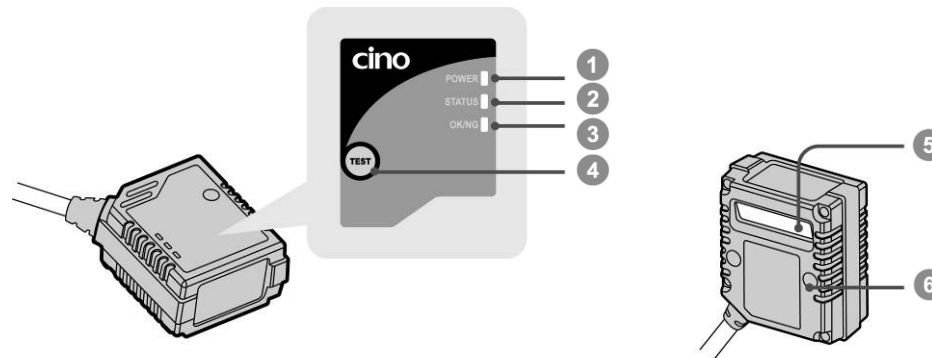

- 1 Power Indicator
- 2 Status Indicator
- 3 OK/NG Indicator
- 4 Test Button
- 5 Scan Window
- 6 M3 Mounting Hole

## Connect to Your Host

Both RS232 and USB interfaces are available in different models of FM400 series. Each model is equipped with corresponding connector to meet various application demands.

### USB Models (FM4xx-11x)

The USB models provide a plug-and-play solution. Both USB HID and USB COM Port Emulation interfaces are available for user's choice.

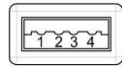

4-pin Type A Connector

Pin No.	Signal	Description	I/O Type
Case	FG	Frame Ground	---
1	VCC	---	I
2	Data -	USB Data -	I/O
3	Data +	USB Data +	I/O
4	GND	---	---

### RS232 Models (FM4xx-00x)

The RS232 models support the standard RS232 interface equipped a 9-pin D-sub connector with power jack for external 5Vdc power inlet.

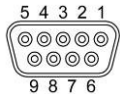

9-pin D-sub Female Connector

Pin No.	Signal	Description	I/O Type
Case	FG	Frame Ground	---
1	---	---	---
2	TXD	Transmit Data	I
3	RXD	Receive Data	O
4	---	---	---
5	GND	Signal Ground	---
6	---	---	---
7	CTS	Clear to Send	I
8	RTS	Request to Send	O
9	VCC	5Vdc Power Supply	I

### Universal Models (FM4xx-98x)

The universal models support RS232 and USB interfaces with OK/NG signal outputs and external trigger input.

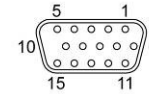

15-pin D-sub HD Female Connector

Pin No.	Signal	Description	I/O Type
1	VCC	5Vdc Power Supply	I
2	TXD	Transmit Data	O
3	RXD	Receive Data	I
4	GND	Signal Ground	---
5	---	---	---
6	RTS	Request to Send	O
7	OK	OK Signal Output (3-24Vdc)	O
8	Data +	USB Data +	I/O
9	Trigger	External Trigger Input	I
10	CTS	Clear to Send	I
11	---	---	---
12	Data -	USB Data -	I/O
13	Shield	Frame Ground	---
14	NG	NG Signal Output (3-24Vdc)	O
15	Reserved	---	---

## Install Your FuzzyScan

### Adjust Reading Angle

The readability may be impacted by the specular reflection caused by the perpendicular reading angle. To get the most optimal reading performance, you are suggested to install the FM400 at an approximate **15°** angle to the perpendicular line of the target barcode. However, the reading angle and distance may vary depending on the size and printing quality of barcodes.

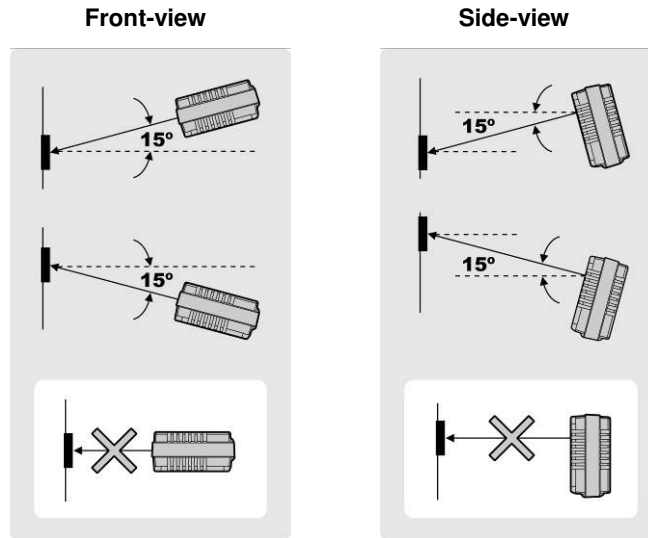

### Mount Your FuzzyScan

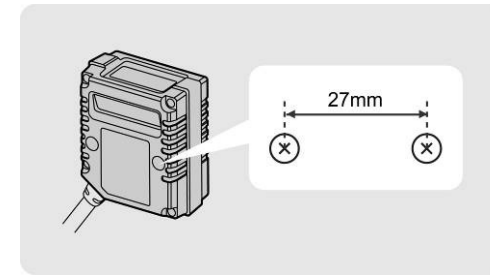

There are two **M3** mounting holes on the bottom of the chassis. Please follow below procedures to mount your scanner.

- 1 Prepare two appropriate M3 screws (minimal 4mm in depth) and decide your desired mounting location. Then adjust the two screws to accommodate **27mm** center width.
- 2 Optimize the mounting position by adjusting the reading angle and distance. Ensure the illumination envelop is not blocked by any external object.
- 3 Use the test mode to verify the actual reading rate. If the reading rate is not good enough, please adjust the reading angle and distance to get the optimum readability.

## Use the Test Mode

The FuzzyScan FM400 provides an useful test mode which is helpful for you to quickly identify the best mounting position. Please refer to the descriptions listed below for details.

### Test Button

Under normal operation, the Test Button of FM400 just acts as a normal trigger switch of hand-held scanner. You can press the Test Button to scan the corresponding barcode commands to configure your scanner with ease.

 **Please note that if you press the Test button for more than 5 seconds, the FM400 will enter the test mode automatically.**

### Test Mode

Once determine your desired location to install the scanner, you may use the test mode to optimize the mounting position with ease. Please follow below procedures to use the test mode.

- 1 Hold the Test Button over **5** seconds until the status indicator gives one green blink, then release the button to activate test mode. The scanner will give 2 short beeps and the power indicator will flash blue blink per 1 second. The scanner will turn on the light source to scan barcodes continuously before exit the test mode.
- 2 Keep scanner to read the same test barcode. The scanner will count the **Good Read** numbers, then output the information of reading rate and refresh LED indications every 100 scans. The format of output message is listed below.

< Readout data > : < Reading rate (0 to 100) >

At the same time, both Status and OK/NG indicators will provide the visible reading rate information as well. You may refer to the table listed below for details.

Reading rate	STATUS Indicator	OK/NG Indicator
100%	Steady Green	Steady Green
80 to 99%	Steady Red	Steady Green
50 to 79%	Steady Green	Steady Red
20 to 49%	Steady Orange	Steady Orange
0 to 19%	Steady Red	Steady Red

- 3 If the reading rate is not good enough, please adjust the reading angle and distance to get the optimum readability. If you would like to exit the test mode, please press the Test Button once again.

-  1. **If the scanner is unable to read any barcode during preset scan input time-out (default is 900ms), the scanner will count it as a NG reading.**
2. **Under test mode, the OK/NG output signals will not be performed.**



## Use Your FuzzScan

Both FuzzyScan **Barcode commands** and **Serial commands** are available to configure your FM400. The FuzzyScan barcode commands are a series of proprietary barcodes which allow you to easily configure the scanner for most applications. Moreover, the FuzzyScan serial commands are ideal for precise and complicated reading control in machine-controllable environments. Please refer to the relevant documentations for details.

### External Trigger and Serial Trigger

The FM400 provides both external trigger and serial trigger to activate the scanning processes. Please note that the external trigger is available for universal models only. The serial trigger is one of serial commands available for all models including RS232 serial and USB COM Port Emulation interfaces.

### Scan Input Time-out

The scan input time-out is a preset light source on time available for presentation, alternative and level modes. The scanner keeps the light source on and continues to scan until the preset scan input time-out is up. You can adjust the time-out duration from 100 milliseconds to 99 seconds to meet various application demands.

### OK/NG Signals

The universal models provide additional OK and NG outputs for more precise reading control. If the scanner got a good read, a signal will be outputted through scanner OK pin. However, if the scanner failed to read the barcode during a reading cycle or preset scan input time-out, a signal will be outputted through scanner NG pin.

The OK and NG outputs are designed as **NPN** signal outputs and have been preset to active low. If necessary, you are able to change the active state of OK and NG outputs to meet your applications.

### Operation Modes

The FuzzyScan FM400 series provides five different operation modes, including trigger, alternative, level, presentation and force modes to meet various application demands.

Both the presentation and force modes support **triggerless** operation, you don't need to use either external trigger or serial trigger to activate the scanning. But the trigger, alternative and level modes **have to** work with **external trigger** or **serial trigger** to scan barcode.



Trigger mode

Under trigger mode, the scanner will turn on the light source to read barcode when it receives an external trigger or a serial trigger ON command. Once the external trigger has been released, or the scanner gets a good read or a serial trigger OFF command, the scanner will stop reading and wait for the next trigger to activate scanning again.



Alternative mode

When the scanner receives an external trigger or a serial trigger ON command under alternative mode, the scanner will turn on the light source to read barcodes until the **preset scan input time-out** is up. The scan input time-out will be reset after each good read. Once the light source goes off, the scanner is waiting for the next trigger to activate scanning again.



Level mode

When the scanner receives an external trigger or a serial trigger ON command under level mode, the scanner will turn on the light source to read barcodes until **a good read**

is performed or the **preset scan input time-out** is up. Once the light source goes off, the scanner is waiting for the next trigger to activate scanning again.



Presentation mode

Under presentation mode, the scanner will automatically detect the object movement in the scanner field of view. Once the scanner detects a similar barcode image, the scanner will turn on the light source to read barcodes until the **preset scan input time-out** is up. For dark environments, you may adjust the setting of “Presentation Sensitivity” to increase the detection sensitivity.



Force mode

Under force mode, the scanner continues to read barcodes without using external trigger or serial trigger. Please note that the scanner will not stop reading until you switch into another operation mode.

## Bar Code Programming Menu

The FuzzyScan bar code commands are specially designed **Proprietary** bar code labels which allow you to set the FuzzyScan internal programming parameters. There are **System Command**, **Family Code** and **Option Code** for programming purpose.

Each programmable family and bar code command label is listed on the same page with major system commands. The detailed explanations and special programming flowchart are printed on facing or following pages. You can read the explanation and set the FuzzyScan concurrently.

A supplemental bar code command menu incorporates the bar code command labels of System Command and Option Code. As you set the FuzzyScan, open the bar code command menu to find the option code page. You may scan the desired family code and option code to set FuzzyScan. If you want to change the programming family for multiple settings, you need only turn over the programming page to find next desired programming family.

### System Command

The System Command is the highest level bar code command which directs FuzzyScan to perform immediate operations, such as entering programming mode (**PROGRAM**), exiting programming mode (**EXIT**), listing system information (**SYSLIST**), recovering to factory preset configurations (**M\_DEFAULT**), and so on. Please note that all system commands will take a few seconds to complete the operations. User must wait for the completion beeps before scanning another bar code.

### Family Code

The Family Code is scanned to select the user desired programming family. FuzzyScan has already provided more than one hundred programming families to meet any specific requirements.

### Option Code

The Option Codes is a set of bar code commands represented by "0-9", "A-F" and finishing selection (**FIN**). For most setting, you must select at least one option code following the family code selection to set the desired parameter for the selected programming family.

## Programming Procedures

As you scan the bar code command to select the desired parameters, information about the final selected parameters represented by the bar code commands are stored in the FuzzyScan's internal Flash Memory ASIC or non-volatile memory. If you turn off the unit, the Flash Memory ASIC or non-volatile memory retains all programming options. You need not re-program the FuzzyScan if you want to keep the existing configurations in the next power on.

The programming procedures of FuzzyScan are designed as simple as possible for ease of setting. Most programming families take the **Single Scan Selection** programming procedure. But several programming families have more complex and flexible programmable options, and you must take **Multiple Scans Selection, Cycling Scan Selection or Dual Level Selection** to complete their programming procedures. Each kind of programming procedure is listed in the following pages for your reference. Please give careful attention to become familiar with each programming procedure.

If the programming family must take multiple scans selection, cycling scan selection, or dual level selection procedures, the family of the programming menu will be marked with the matched representing symbol of **Programming Category** (P.C.) in bold font listed in the following table. You can easily find the bold mark in the programming menu, and refer to their flowcharts for details. Before setting the FuzzyScan, please also refer to the "Beeping Indications" listed in Appendix to understand the details of programming beeping indications. It will be very helpful for you to know the existing status while you are programming the FuzzyScan.

### Conventions of Programming Menu

◆	<b>Factory Default Value</b>
<b>P.C.</b>	<b>Programming Category</b> <b>SS</b> : Single scan selection <b>MS</b> : Multiple scans selection <b>CS</b> : Cycling scan selection <b>DS</b> : Dual level scan selection
( )	<b>Necessary Option Code</b>
[ ]	<b>Selectable Option Code</b>

### Program & End

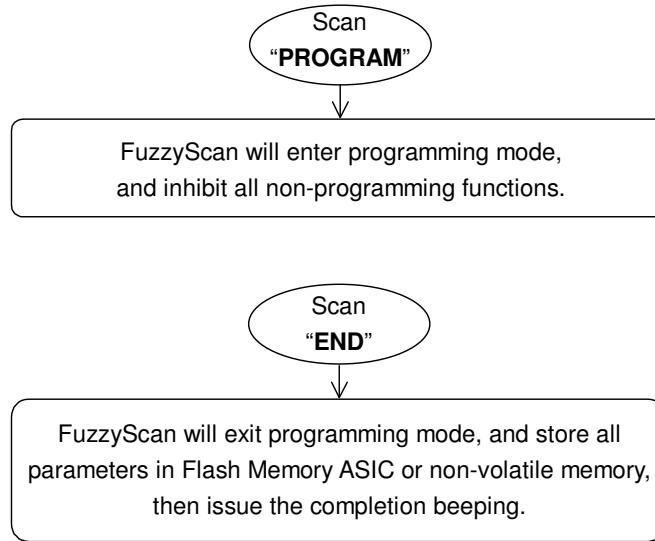

 Please note that the FuzzyScan will take 3-4 seconds to store parameters in internal Flash Memory ASIC or non-volatile memory after you scan the "END". Please **don't** turn off the power before the completion beeping. It may destroy all configured parameters.

### System List, Group & Master Default

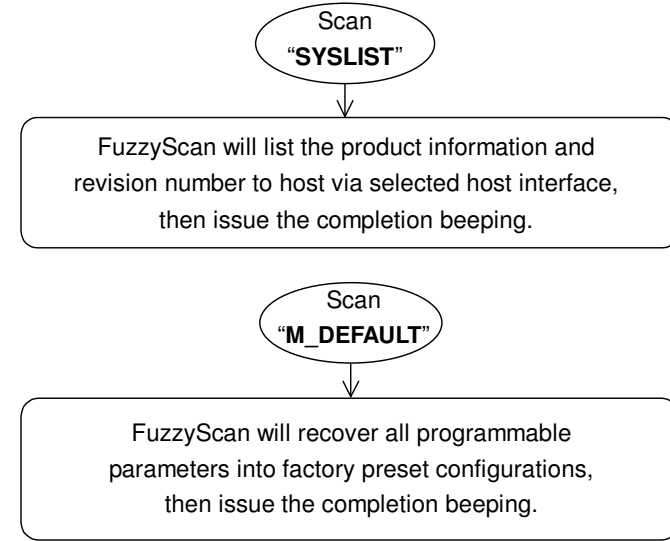

### Single scan selection

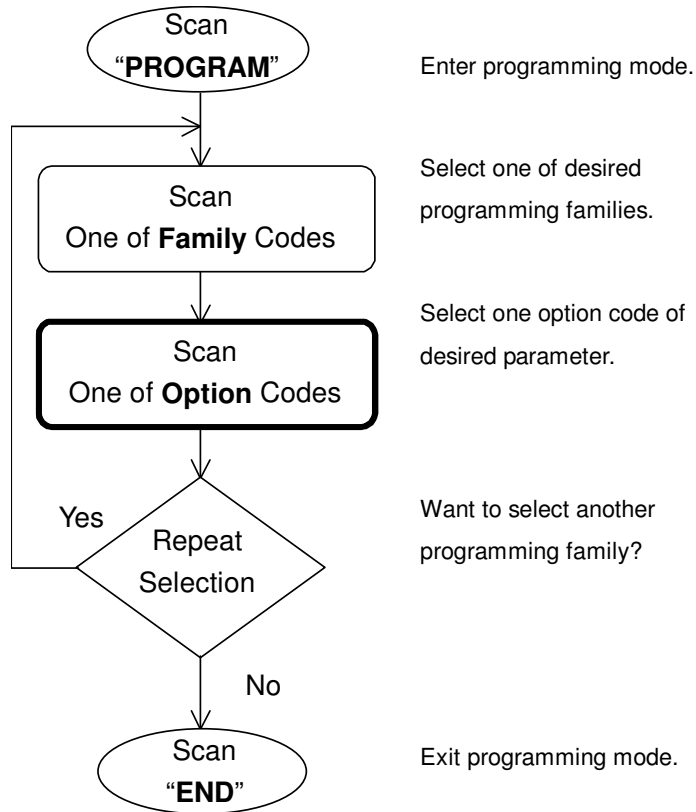

### Multiple scans selection

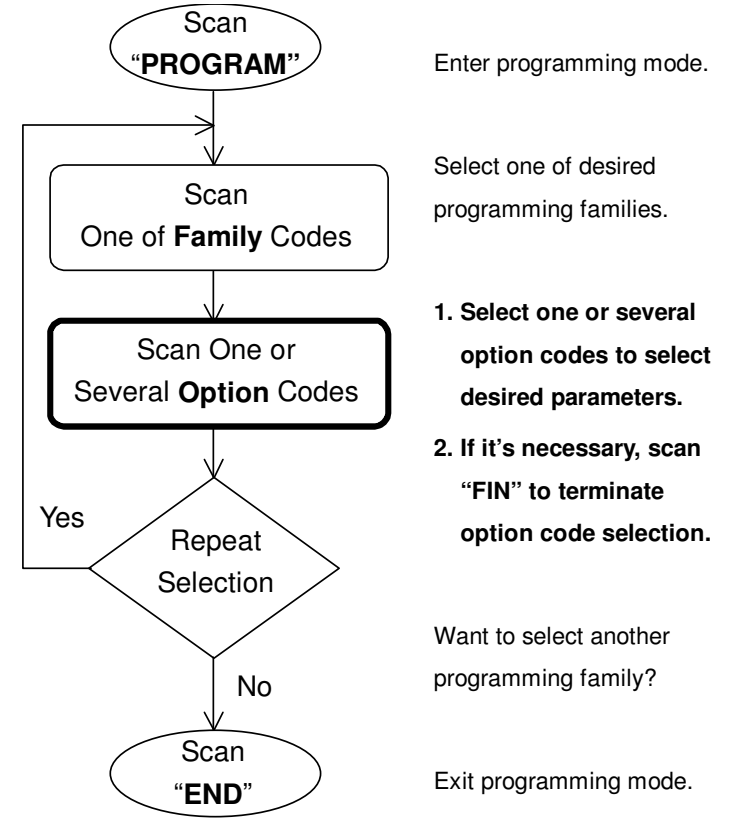

### Cycling scan selection

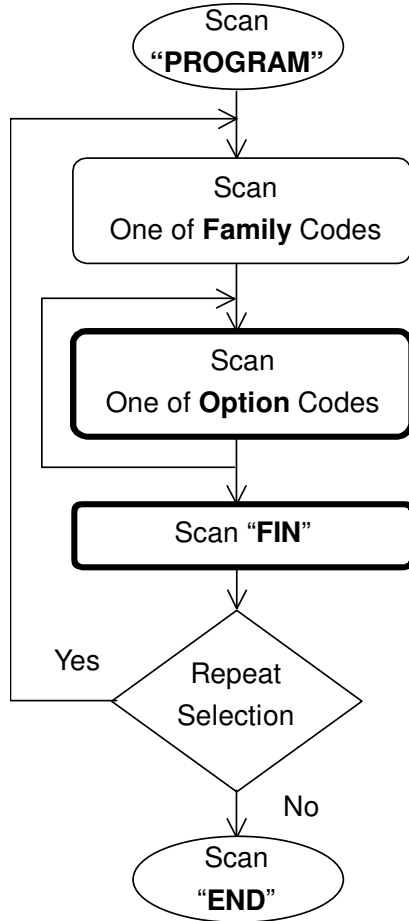

Enter programming mode.

Select one of desired programming families.

Cycling select one or several option codes of desired parameters as "Single" or "Multiple" scans selection.

Finish cycling selection. (If necessary)

Want to select another programming family?

Exit programming mode.

### Dual level selection

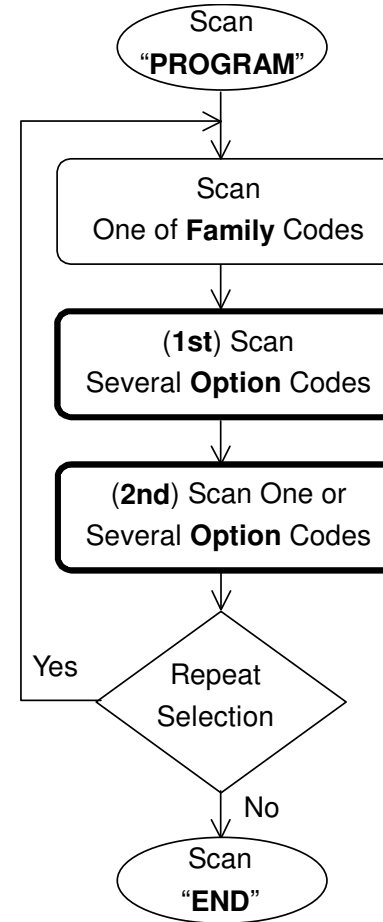

Enter programming mode.

Select one of desired programming families.

Select several option codes of desired parameters.

1. Select one or several option codes of desired parameters.

2. If it's necessary, scan "FIN" to terminate option code selection.

Want to select another programming family?

Exit programming mode.



**PROGRAM**

## Host Interface Selection



**F\_DEFAULT**

 <b>Host Interface Selection</b>	<b>MS</b>	Standard/TTL RS-232 peer-to-peer serial	06
	<b>MS</b>	USB Com Port Emulation	09
	<b>MS</b>	USB HID standard mode	18
	<b>MS</b>	USB HID turbo mode	19





**PROGRAM**

## Symbology Reading Control

### ◆ User Defined Symbol ID ◆



**F\_DEFAULT**

Symbol ID : 1 character	DS			
		Code 128 (default= <b>B</b> )	00	(1 character)
		UCC/EAN-128 (default= <b>C</b> )	01	(1 character)
		UPC-A (default= <b>A</b> )	02	(1 character)
		EAN-13 (default= <b>F</b> )	03	(1 character)
		Codabar/NW-7 (default= <b>D</b> )	04	(1 character)
		Code 39/Code 32 (default= <b>G</b> )	05	(1 character)
		Code 93 (default= <b>H</b> )	06	(1 character)
		Standard/Industrial 2 of 5 (default= <b>I</b> )	07	(1 character)
		Interleaved 2 of 5 (default= <b>J</b> )	08	(1 character)
		Matrix 2 of 5 (default= <b>K</b> )	09	(1 character)
		China Postal Code (default= <b>L</b> )	10	(1 character)
		German Postal Code (default= <b>M</b> )	11	(1 character)
		IATA (default= <b>O</b> )	12	(1 character)
		Code 11 (default= <b>P</b> )	13	(1 character)
		MSI/Plessey (default= <b>R</b> )	14	(1 character)
		UK/Plessey (default= <b>S</b> )	15	(1 character)
		Telepen (default= <b>T</b> )	16	(1 character)
		GS1 DataBar (default= <b>X</b> )	17	(1 character)
		UPC-E (default= <b>E</b> )	18	(1 character)
		EAN-8 (default= <b>N</b> )	19	(1 character)
	Trioptic Code 39 (Default= <b>W</b> )	20	(1 character)	
	UCC Coupon Extended Code (Default= <b>Z</b> )	21	(1 character)	
	PDF417/Micro PDF417 (default= <b>V</b> )	22	(1 character)	
	Codablock F (default= <b>Y</b> )	23	(1 character)	
	Korea Post Code (default = <b>a</b> )	26	(1 character)	



PROGRAM

## Symbology Reading Control

### ◆ Symbology ID Transmission ◆



F\_DEFAULT

<b>Symbology ID Transmission</b> 	SS	Disable symbology ID transmission ◆	0
	SS	Enable prefix CINO symbology ID transmission	1
	SS	Enable suffix CINO symbology ID transmission	2
	SS	Enable both prefix and suffix CINO symbology ID transmission	3
	SS	Enable prefix AIM symbology ID transmission	4
	SS	Enable suffix AIM symbology ID transmission	5
	SS	Enable both prefix and suffix AIM symbology ID transmission	6



PROGRAM

## Symbology Reading Control

### ◆ Readable Bar Code Setting ◆



F\_DEFAULT

Readable Symbology Setting			
 <div style="border: 1px solid black; padding: 5px; margin-top: 10px;">                     Remember to scan "FIN" to terminate this selection. But if you select the "Auto", FuzzyScan will terminate this selection automatically.                 </div>	SS	Auto ◆	00
	CS	Code 128 *	01
	CS	UPC-A *	02
	CS	UPC-E *	03
	CS	EAN-13 *	04
	CS	EAN-8 *	05
	CS	Codabar/NW-7 *	06
	CS	Code 39 *	07
	CS	Trioptic Code 39	47
	CS	Standard/Industrial 2 of 5	08
	CS	Matrix 2 of 5	38
	CS	Interleaved 2 of 5 *	48
	CS	China Postal Code	58
	CS	German Postal Code	68
	CS	Code 93 *	09
	CS	Code 11	10
	CS	MSI/Plessey	11
	CS	UK/Plessey	12
	CS	Telepen	13
	CS	GS1 DataBar (RSS-14) *	14
CS	IATA	15	
CS	PDF417/Micro PDF417	17	
CS	Codablock F	18	
CS	Korea Post Code	21	

- If your application is known, you may select those known symbologies only to increase the reading speed and decrease the possibility of reading error. Furthermore, to add the "Symbology ID" into the transmitted data is also helpful to identify the specific symbology.
- Above symbologies marketed with \* are enable as default. When you select "Auto", the imager only read those symbologies marked with \*.
- When you set the minimum and maximum length of each symbology, please note the data length of scanned bar code doesn't include star/stop characters.







PROGRAM

## Symbology Reading Control

### ◆ Code 39/Code 32 Setting ◆



F\_DEFAULT

<b>Code 39 Family Setting</b>  	SS	Disable Code 39	0
	SS	Enable Code 39 ◆	1
	SS	Select Standard Code 39 as primary format ◆	2
	SS	Select Full ASCII Code 39 as primary format	3
	SS	Select Code 32 (PARAF, Italian Pharmaceutical) as primary format	4
	SS	Disable start/stop symbol transmission ◆	5
	SS	Enable start/stop symbol transmission	6
	SS	Disable Code 32 leading A transmission ◆	7
	SS	Enable Code 32 leading A transmission	8
	SS	Disable MOD 43 check digit verification ◆	9
	SS	Enable MOD 43 check digit verification	A
	SS	Disable check digit transmission ◆	B
	SS	Enable check digit transmission	C
	SS	Disable Code 39 buffering ◆	D
SS	Enable Code 39 buffering	E	
<b>Trioptic Code 39 Setting</b>  	SS	Disable Trioptic Code 39 ◆	0
	SS	Enable Trioptic Code 39	1
<b>Code 39 Min. Length</b>  	SS	Default (01) ◆	<b>FIN</b> <b>(2 digits)</b>
	MS	01-Maximum  Scan 2 digits from the option code chart in Appendix, then FuzzyScan will terminate this selection automatically.	
<b>Code 39 Max. Length</b>  	SS	Default (98) ◆	<b>FIN</b> <b>(2 digits)</b>
	MS	98-Minimum  Scan 2 digits from the option code chart in Appendix, then FuzzyScan will terminate this selection automatically.	

■ Trioptic Code 39 and Code 39 Full ASCII cannot be enabled simultaneously.



PROGRAM

## Symbology Reading Control

### ◆ Code 39 Setting ◆



F\_DEFAULT

PROGRAM		F_DEFAULT	
<b>Code 39 Security Level</b> 	SS	Level 0	0
	SS	Level 1	1
	SS	Level 2 ◆	2
	SS	Level 3	3

▪ **Code 39 Security Level**

The scanner offers four levels of decode security for Code39 bar codes:

Level 0: If you are experiencing misread of poorly-printed or serious out-of-spec. bar codes in level 1, please select level 0.

Level 1: If you are experiencing misread of poorly-printed or out-of-spec. bar codes in level 2, please select level 1.

Level 2: This is the default setting which allows the scanner to operate fastest, while providing sufficient security in decoding "in-spec" Code39 bar codes.

Level 3: If you failed to read poorly-printed or out-of-spec. bar codes in level 2, please select level 3. This is the most aggressive setting and may increase the misread.





PROGRAM

## Symbology Reading Control

### ◆ Codabar/NW-7 Setting ◆



F\_DEFAULT

<b>Codabar Setting</b> 	SS	Disable Codabar	0
	SS	Enable Codabar ◆	1
	SS	Select Codabar standard format ◆	2
	SS	Select Codabar ABC format	3
	SS	Select Codabar CLSI format	4
	SS	Select Codabar CX format	5
	SS	Disable start/stop symbol transmission ◆	6
	SS	Enable ABCD/ABCD start/stop symbol transmission	7
	SS	Enable abcd/abcd start/stop symbol transmission	8
	SS	Enable ABCD/TN*E start/stop symbol transmission	9
	SS	Enable abcd/tn*e start/stop symbol transmission	A
	SS	Disable check digit verification ◆	B
	SS	Enable check digit verification	C
SS	Disable check digit transmission ◆	D	
SS	Enable check digit transmission	E	
<b>Codabar Min. Length</b> 	SS MS	Default (04) ◆ 01-Maximum Scan 2 digits from the option code chart in Appendix, then FuzzyScan will terminate this selection automatically.	<b>FIN</b> <b>(2 digits)</b>
<b>Codabar Max. Length</b> 	SS MS	Default (98) ◆ 98-Minimum Scan 2 digits from the option code chart in Appendix, then FuzzyScan will terminate this selection automatically.	<b>FIN</b> <b>(2 digits)</b>



PROGRAM

## Symbology Reading Control

### ◆ UPC-A & UPC-E Setting ◆



F\_DEFAULT

UPC Family Setting			
	SS	Disable UPC-A	0
	SS	Enable UPC-A ◆	1
	SS	Disable UPC-E	2
	SS	Enable UPC-E ◆	3
	SS	Disable UPC-E expansion ◆	4
	SS	Enable UPC-E expansion	5
	SS	Disable UPC standardization ◆	6
	SS	Enable UPC standardization	7
	SS	Disable UPC numeric system	8
	SS	Enable UPC numeric system ◆	9
	SS	Disable UPC-A check digit transmission	A
	SS	Enable UPC-A check digit transmission ◆	B
	SS	Disable UPC-E check digit transmission	C
	SS	Enable UPC-E check digit transmission ◆	D
	SS	Disable UPC "leading 1" portion ◆	E
	SS	Enable UPC "leading 1" portion	F

- When enable UPC-E expansion, the UPC-E decoded data will be converted to UPC-A format and affected by related setting, such as UPC standardization, UPC numeric system, UPC-A check digit transmission.
- **UPC-E & EAN-8 Expansion** : Expand the 8-digit UPC-E and 8-digit EAN-8 to 12-digit UPC-A and 13-digit EAN-13.
- **UPC-A Standardization** : Expand the 12-digit UPC-A to 13-digit EAN-13 with 1 zero insertion.
- **UPC Lead 1 Numeric System** : Enable to read UPC leading with the 1 numeric system, you must enable this option.

WPC Selection (UPC/EAN/CAN)	Basic Length	Disable Check Digit	Disable Numeric System	With 2-digit Addendum	With 5-digit Addendum	Enable Standardization	Enable Expansion
UPC-A	12	- 1	- 1	+ 2	+ 5	+ 1	0
UPC-E	8	- 1	- 1	+ 2	+ 5	+ 1	+ 4
EAN-13	13	- 1	NC	+ 2	+ 5	NC	0
EAN-8	8	- 1	NC	+ 2	+ 5	NC	+ 5





PROGRAM

## Symbology Reading Control

### ◆ UPC-A & UPC-E Setting , Supplement Scan Voting◆



F\_DEFAULT

<b>UPC Supplement Setting</b> 	SS	Select UPC without supplement digits ◆		0	
	SS	Select UPC with only 2 supplement digits		1	
	SS	Select UPC with only 5 supplement digits		2	
	SS	Select UPC with 2/5 supplement digits		3	
	SS	Disable force supplement digits output ◆		4	
	SS	Enable force supplement digits output		5	
	SS	UPC Family Addenda Separator Off ◆		6	
	SS	UPC Family Addenda Separator On		7	
<b>UPC/EAN Security Level</b> 	SS	Level 0		0	
	SS	Level 1 ◆		1	
	SS	Level 2		2	
		Only available for UPC-A & EAN-13			
<b>Supplement Scan Voting</b> 	SS	None	Level 7	0	7
	SS	Level 1	Level 8	1	8
	SS	Level 2	Level 9	2	9
	SS	Level 3 ◆	Level 10	3	A
	SS	Level 4	Level 11	4	B
	SS	Level 5	Level 12	5	C
	SS	Level 6	Level 13	6	D

- **UPC/EAN Security Level**  
 The scanner offers three levels of decode security for UPC/EAN bar codes:  
 Level 0: If you are experiencing misread of poorly-printed or out-of-spec. bar codes, especially in characters 1, 2, 7, and 8 in level 1, please select level 0. Selection of this security level may significantly impair the decoding ability of the scanner.  
 Level 1: This is the default setting which allows the scanner to operate fastest, while providing sufficient security in decoding “in-spec” UPC/EAN bar codes.  
 Level 2: If you are experiencing misread of poorly-printed, soiled or damage bar codes in level 1, please select level 2. This is the most aggressive setting and may increase the misread.
- **The Supplement Scan Voting** is the number of times the same UPC/EAN with 2/5 supplement digits has to be decoded before it is transmitted. It is helpful when decoding a mix of UPC/EAN symbols with and without supplement digits. This function is effective when you select UPC/EAN with only 2 supplement digits, UPC/EAN with only 5 supplement digits or UPC/EAN with 2/5 supplement digits. The default value is Level 3. When you select higher level, it may impact the reading speed on poorly-printed, low contrast or damage barcode labels.





PROGRAM

## Symbology Reading Control

### ◆ EAN Setting , Supplement , Supplement Scan Voting◆



F\_DEFAULT

<b>EAN Setting</b> 	SS	Disable EAN-13		0	
	SS	Enable EAN-13 ◆		1	
	SS	Disable EAN-8		2	
	SS	Enable EAN-8 ◆		3	
	SS	Disable EAN-8 expansion ◆		4	
	SS	Enable EAN-8 expansion		5	
	SS	Disable EAN-13 check digit transmission		6	
	SS	Enable EAN-13 check digit transmission ◆		7	
	SS	Disable EAN-8 check digit transmission		8	
	SS	Enable EAN-8 check digit transmission ◆		9	
	SS	Disable ISBN/ISSN Conversion reading check ◆		A	
	SS	Enable ISBN/ISSN Conversion reading check		B	
	<b>EAN Supplement Setting</b> 	SS	Select EAN without supplement digits ◆		0
SS		Select EAN with only 2 supplement digits		1	
SS		Select EAN with only 5 supplement digits		2	
SS		Select EAN with 2/5 supplement digits		3	
SS		Disable force supplement digits output ◆		4	
SS		Enable force supplement digits output		5	
SS		EAN Addenda Separator Off ◆		6	
SS		EAN Addenda Separator On		7	
<b>Supplement Scan Voting</b> 	SS	None	Level 7	0	7
	SS	Level 1	Level 8	1	8
	SS	Level 2	Level 9	2	9
	SS	Level 3 ◆	Level 10	3	A
	SS	Level 4	Level 11	4	B
	SS	Level 5	Level 12	5	C
	SS	Level 6	Level 13	6	D

▪ The **Supplement Scan Voting** is the number of times the same UPC/EAN with 2/5 supplement digits has to be decoded before it is transmitted. It is helpful when decoding a mix of UPC/EAN symbols with and without supplement digits. This function is effective when you select UPC/EAN with only 2 supplement digits, UPC/EAN with only 5 supplement digits or UPC/EAN with 2/5 supplement digits. The default value is Level 3. When you select higher level, it may impact the reading speed on poorly-printed, low contrast or damage barcode labels.





PROGRAM

## Symbology Reading Control

### ◆ UPC/EAN Security Level Setting , EAN Supplement Control◆



F\_DEFAULT

<b>UPC/EAN Security Level</b> 	SS	Level 0	0
	SS	Level 1 ◆	1
	SS	Level 2	2
			Only available for UPC-A & EAN-13
<b>EAN Supplement Control</b> 	SS	Disable all specific prefix supplement digital output ◆	0
	SS	Enable all specific prefix supplement digital output	1
	SS	Enable 491 Supplement Digit Output	2
	SS	Enable 978/979 Supplement Digit Output	3
	SS	Enable 977 Supplement Digit Output	4
	SS	Enable 378/379 Supplement Digit Output	5
	SS	Enable 414/419 Supplement Digit Output	6
	SS	Enable 434/439 Supplement Digit Output	7

▪ **UPC/EAN Security Level**

The scanner offers three levels of decode security for UPC/EAN bar codes:

Level 0: If you are experiencing misread of poorly-printed or out-of-spec. bar codes, especially in characters 1, 2, 7, and 8 in level 1, please select level 0. Selection of this security level may significantly impair the decoding ability of the scanner.

Level 1: This is the default setting which allows the scanner to operate fastest, while providing sufficient security in decoding "in-spec" UPC/EAN bar codes.

Level 2: If you are experiencing misread of poorly-printed, soiled or damage bar codes in level 1, please select level 2. This is the most aggressive setting and may increase the misread.

▪ **EAN Supplement Control**

If you select EAN with only 2, or 5 or 2/5 supplement digits and enable 491 prefix supplement digit output, the scanner will transmit EAN with 2, or 5 or 2/5 supplement digits bar codes starting with 491 prefix. The EAN without supplement digit **will not** be transmitted.

If you select EAN with only 2, or 5 or 2/5 supplement digits and enable the other except 491 prefix supplement digit output, the scanner will transmit EAN with 2, or 5, or 2/5 supplement digits bar codes starting with specific prefix. The EAN without supplement digit **will** be transmitted.



PROGRAM

## Symbology Reading Control

### ◆ UCC Coupon Extended Code Setting ◆



F\_DEFAULT

<b>UCC Coupon Extended Code</b>	SS	Disable UCC Coupon Extended Code ◆	0
	SS	Enable UCC Coupon Extended Code	1

▪ UCC Coupon Extended Code

When UCC coupon extended code function is enabled, scanner decodes UPC-A barcodes starting with digit “5”, EAN-13 barcodes starting with digit “99” and UCC/EAN-128 Coupon Codes. UPC-A, EAN-13 and EAN-128 must be enabled to scan all types of Coupon Codes.





PROGRAM

## Symbology Reading Control

### ◆ IATA & Interleaved 2 of 5 Setting ◆



F\_DEFAULT

<p><b>IATA Setting</b></p> 	SS	Disable IATA ◆	0
	SS	Enable IATA	1
	SS	Select 15-digit fixed length IATA checking ◆	2
	SS	Select variable length IATA	3
	SS	Disable check digit verification ◆	4
	SS	Enable check digit automatic verification	5
	SS	Enable S/N checking digit verification only	6
	SS	Enable CPN checking digit verification only	7
	SS	Enable CPN, Airline and S/N check digit verification	8
	SS	Disable check digit transmission ◆	9
	SS	Enable check digit transmission	A
	SS	Disable start/stop symbol transmission ◆	B
SS	Enable start/stop symbol transmission	C	
<p><b>Interleaved 2 of 5 Setting</b></p> 	SS	Disable Interleaved 2 of 5	0
	SS	Enable Interleaved 2 of 5 ◆	1
	SS	Select Interleaved 2 of 5 as primary format ◆	2
	SS	Select German Postal Code as primary format	3
	SS	No check character ◆	4
	SS	Validate USS check digit	5
	SS	Validate OPCC check digit	6
	SS	Disable check digit transmission ◆	7
SS	Enable check digit transmission	8	





PROGRAM

## Symbology Reading Control

### ◆ Code 25 Family Setting ◆



F\_DEFAULT

<b>Code 25 Setting</b> 	SS	Disable Standard/Industrial 2 of 5 ◆	0
	SS	Enable Standard/Industrial 2 of 5	1
	SS	Disable Matrix 2 of 5 ◆	2
	SS	Enable Matrix 2 of 5	3
	SS	Disable China Postal Code ◆	4
	SS	Enable China Postal Code	5
	SS	Disable check digit verification ◆	6
	SS	Enable check digit verification	7
	SS	Disable check digit transmission ◆	8
	SS	Enable check digit transmission	9
<b>Code 25 Family Min. Length</b> 	SS MS	Default (04) ◆ 01-Maximum Scan 2 digits from the option code chart in Appendix, then FuzzyScan will terminate this selection automatically.	<b>FIN</b> <b>(2 digits)</b>
<b>Code 25 Family Max. Length</b> 	SS MS	Default (98) ◆ 98-Minimum Scan 2 digits from the option code chart in Appendix, then FuzzyScan will terminate this selection automatically.	<b>FIN</b> <b>(2 digits)</b>

- For Code25 setting, we recommend you to select **only one** type of Code 25 or set the **maximum/minimum bar code length**. To decode all types of Code 25 or to variable length of Code 25 will increase the possibility of reading error.



PROGRAM

## Symbology Reading Control

### ◆ Code 11 & Code 93 Setting ◆



F\_DEFAULT

<p><b>Code 11 Setting</b></p>	<p>SS Disable Code 11 ◆            SS Enable Code 11            SS Disable check digit verification ◆            SS Select 1-check digit verification            SS Select 2-check digit verification            SS Disable check digit transmission ◆            SS Enable check digit transmission</p>	<p>0 1 2 3 4 5 6</p>
<p><b>Code 11 Min. Length</b></p>	<p>SS Default (04) ◆            MS 01-Maximum            Scan 2 digits from the option code chart in Appendix, then FuzzyScan will terminate this selection automatically.</p>	<p><b>FIN</b> (2 digits)</p>
<p><b>Code 11 Max. Length</b></p>	<p>SS Default (98) ◆            MS 98-Minimum            Scan 2 digits from the option code chart in Appendix, then FuzzyScan will terminate this selection automatically.</p>	<p><b>FIN</b> (2 digits)</p>
<p><b>Code 93 Setting</b></p>	<p>SS Disable Code 93            SS Enable Code 93 ◆            SS Disable check digit transmission ◆            SS Enable check digit transmission</p>	<p>0 1 2 3</p>
<p><b>Code 93 Min. Length</b></p>	<p>SS Default (01) ◆            MS 01-Maximum            Scan 2 digits from the option code chart in Appendix, then FuzzyScan will terminate this selection automatically.</p>	<p><b>FIN</b> (2 digits)</p>
<p><b>Code 93 Max. Length</b></p>	<p>SS Default (98) ◆            MS 98-Minimum            Scan 2 digits from the option code chart in Appendix, then FuzzyScan will terminate this selection automatically.</p>	<p><b>FIN</b> (2 digits)</p>



PROGRAM

## Symbology Reading Control

### ◆ MSI/Plessey Setting ◆



F\_DEFAULT

<b>MSI/Plessey Setting</b> 	SS	Disable MSI/Plessey ◆	0
	SS	Enable MSI/Plessey	1
	SS	Select MOD 10 check digit ◆	2
	SS	Select MOD 10-10 check digit	3
	SS	Select MOD 11-10 check digit	4
	SS	Disable check digit transmission ◆	5
	SS	Enable check digit transmission	6
<b>MSI/Plessey Min. Length</b> 	SS	Default (04) ◆	<b>FIN</b> <b>(2 digits)</b>
	MS	01-Maximum Scan 2 digits from the option code chart in Appendix, then FuzzyScan will terminate this selection automatically.	
<b>MSI/Plessey Max. Length</b> 	SS	Default (98) ◆	<b>FIN</b> <b>(2 digits)</b>
	MS	98-Minimum Scan 2 digits from the option code chart in Appendix, then FuzzyScan will terminate this selection automatically.	



PROGRAM

## Symbology Reading Control

### ◆ Code 128 & UCC/EAN 128 Setting ◆



F\_DEFAULT

<b>Code 128/EAN-128 Setting</b> 	SS SS SS SS SS SS	Disable Code 128 and UCC/EAN-128 Enable Code 128 and UCC/EAN-128 ◆ Disable function code conversion ◆ Enable function code conversion ISBT Concatenation Off ◆ ISBT Concatenation On	0 1 2 3 4 5
<b>Code 128/EAN-128 Min. Length</b> 	SS MS	Default (01) ◆ 01-Maximum Scan 2 digits from the option code chart in Appendix, then FuzzyScan will terminate this selection automatically.	<b>FIN</b> <b>(2 digits)</b>
<b>Code 128/EAN-128 Max. Length</b> 	SS MS	Default (98) ◆ 98-Minimum Scan 2 digits from the option code chart in Appendix, then FuzzyScan will terminate this selection automatically.	<b>FIN</b> <b>(2 digits)</b>





PROGRAM

## Symbology Reading Control

### ◆ UK/Plessey Setting ◆



F\_DEFAULT

<b>UK/Plessey Setting</b> 	SS	Disable UK/Plessey ◆	0
	SS	Enable UK/Plessey	1
	SS	Select UK/Plessey Standard Format ◆	2
	SS	Select UK/Plessey CLSI Format	3
	SS	Disable Convert X to A-F ◆	4
	SS	Enable Convert X to A-F	5
	SS	Disable check digit transmission ◆	6
	SS	Enable check digit transmission	7
<b>UK/Plessey Min. Length</b> 	SS MS	Default (04) ◆ 01-Maximum Scan 2 digits from the option code chart in Appendix, then FuzzyScan will terminate this selection automatically.	<b>FIN</b> <b>(2 digits)</b>
<b>UK/Plessey Max. Length</b> 	SS MS	Default (98) ◆ 98-Minimum Scan 2 digits from the option code chart in Appendix, then FuzzyScan will terminate this selection automatically.	<b>FIN</b> <b>(2 digits)</b>





PROGRAM

## Symbology Reading Control

### ◆ Telepen Setting ◆



F\_DEFAULT

<b>Telepen Setting</b> 	SS	Disable Telepen ◆	0
	SS	Enable Telepen	1
	SS	Select Telepen Numeric mode ◆	2
	SS	Select Telepen Full ASCII mode	3
	SS	Disable check digit transmission ◆	4
	SS	Enable check digit transmission	5
<b>Telepen Min. Length</b> 	SS	Default (04) ◆	<b>FIN (2 digits)</b>
	MS	01-Maximum Scan 2 digits from the option code chart in Appendix, then FuzzyScan will terminate this selection automatically.	
<b>Telepen Max. Length</b> 	SS	Default (98) ◆	<b>FIN (2 digits)</b>
	MS	98-Minimum Scan 2 digits from the option code chart in Appendix, then FuzzyScan will terminate this selection automatically.	





PROGRAM

## Symbology Reading Control

### ◆ GS1 DataBar Setting ◆



F\_DEFAULT

<b>GS1 DataBar Setting</b> 	SS	Disable GS1 DataBar (RSS-14)	0
	SS	Enable GS1 DataBar (RSS-14) ◆	1
	SS	Disable GS1 DataBar Limited	2
	SS	Enable GS1 DataBar Limited ◆	3
	SS	Disable GS1 DataBar Expanded	4
	SS	Enable GS1 DataBar Expanded ◆	5
<b>GS1 DataBar Min. Length</b> 	SS	Default (04) ◆	<b>FIN</b> <b>(2 digits)</b>
	MS	01-Maximum  Only available for <b>Expanded</b> GS1 Databar. Scan 2 digits from the option code chart in Appendix, then FuzzyScan will terminate this selection automatically.	
<b>GS1 DataBar Max. Length</b> 	SS	Default (74) ◆	<b>FIN</b> <b>(2 digits)</b>
	MS	74-Minimum  Only available for <b>Expanded</b> GS1 Databar. Scan 2 digits from the option code chart in Appendix, then FuzzyScan will terminate this selection automatically.	







PROGRAM

## Symbology Reading Control

### ◆ Linear-stacked & Korea Post Code Setting ◆



F\_DEFAULT

<b>Composite Codes Setting</b> 	SS SS SS SS	Disable composite codes ◆ Enable composite codes UPC Composite Mode: UPC never linked ◆ UPC Composite Mode: UPC always linked	0 1 2 3
<b>PDF417/MicroPDF417 Setting</b> 	SS SS SS SS	Disable PDF417 Enable PDF417 ◆ Disable MicroPDF417 ◆ Enable MicroPDF417	0 1 2 3
<b>Codablock F Setting</b> 	SS SS	Disable ◆ Enable	0 1
<b>Korea Post Code Setting</b> 	SS SS	Disable ◆ Enable  Length fixed in 6 characters.	0 1

■ Composite Codes Setting

If UPC Composite Mode: UPC never linked is selected, UPC barcodes are transmitted regardless of whether a MicroPDF417 symbol is detected.

If UPC Composite Mode: UPC always linked is selected, UPC barcodes are only transmitted when the MicroPDF417 is detected.



PROGRAM

## Keyboard Interface Control

### ◆ Keyboard Layout (Language) Setting ◆



F\_DEFAULT

Keyboard Layout	SS		
	SS	USA (QWERTY) ◆	00
	SS	France (AZERTY)	01
	SS	Germany (QWERTZ)	02
	SS	United Kingdom - UK (QWERTY)	03
	SS	Canadian French (QWERTY)	04
	SS	Spain (Spanish, QWERTY)	05
	SS	Sweden/Finland (QWERTY)	06
	SS	Portugal (QWERTY)	07
	SS	Norway (QWERTY)	08
	SS	Spain (Latin America, QWERTY)	09
	SS	Italy (QWERTY)	10
	SS	Netherlands (QWERTY)	11
	SS	Denmark (QWERTY)	12
	SS	Belgium (AZERTY)	13
	SS	Switzerland-Germany (QWERTY)	14
	SS	Iceland (QWERTY)	15
	SS	Japan (DOS/V)	16
SS	Czech (QWERTY)	17	

▪ Please refer to the **ASCII/HEX Table** listed in the Appendix to determine HEX codes for characters, symbols, and functions to be used as preamble or postamble.

▪ To set preamble or postamble as function key output, you must enable the **“Function Key Emulation”** feature as listed in page 3-25 first.

▪ **Keyboard Interface Message String :**

Preamble	Data Length	Prefix Symbol ID	Scanned Data	Suffix Symbol ID	Postamble	Record Suffix
1-15 characters	2-3 digits	1 or 2 characters	Variable length	1 or 2 characters	1-15 characters	1 character



PROGRAM

## Keyboard Interface Control

### ◆ Record Suffix, Preamble, Postamble & Caps Lock ◆



F\_DEFAULT

<p><b>Record Suffix</b></p>	SS SS SS SS SS SS	None RETURN ◆ TAB SPACE ENTER (Numeric Key Pad) User defined character (1 character)	0 1 2 3 4 5, (00-7F)
<p><b>Preamble</b></p>	SS MS	None ◆ 1-15 characters  Maximum 15-character input; scan "FIN" to terminate this selection.	FIN [00-7F], [FIN]
<p><b>Postamble</b></p>	SS MS	None ◆ 1-15 characters  Maximum 15-character input; scan "FIN" to terminate this selection.	FIN [00-7F], [FIN]
<p><b>Caps Lock Control</b></p>	SS SS SS	"Caps Lock Off" State ◆ "Caps Lock On" State Auto Detect (PC/AT, PS/2, Keyboard Replacement and DOS/V Machines only)	0 1 2
<p><b>Caps Lock Release Control</b></p>	SS SS	"Caps Lock On, Caps Off" ◆ "Caps Lock On, Shift Off"	0 1

- The function of "Caps Lock Control" and "Key Pad Emulation" are **only** available for IBM PC/AT, PS/VP, PS/2 series personal computers and compatible machines. While selecting the other host interfaces, these selections don't perform the above functions for you.
- Please check the **actual** Caps Lock state in use while software application is running. If the Caps Lock state is off, select "**Caps Lock Off**" state, then FuzzyScan will perform normal data transmission. If the Caps Lock state is on, select "**Caps Lock On**" state. Select "**Auto Detect**", FuzzyScan will perform special transmission handshaking without changing the status of Caps Lock switch.



PROGRAM

## Keyboard Interface Control

### ◆ Delay Setting ◆



F\_DEFAULT

<b>Intermessage Delay</b> 	SS MS	None ◆ 1-99 (x5) msec. Scan 2 digits from the option code chart in Appendix, then FuzzyScan will terminate this selection automatically.	FIN (2 digits)
<b>Intercharacter Delay</b> 	SS MS	None ◆ 1-99 (x5) msec. Scan 2 digits from the option code chart in Appendix, then FuzzyScan will terminate this selection automatically.	FIN (2 digits)
<b>Interfunction Delay</b> 	SS MS	None ◆ 1-99 (x5) msec. Scan 2 digits from the option code chart in Appendix, then FuzzyScan will terminate this selection automatically.	FIN (2 digits)

- **Intermessage Delay** is a time delay between messages output by FuzzyScan. Increasing this delay will help host applications process the incoming data on time.
- **Intercharacter Delay** is a time delay between data characters output by FuzzyScan. These two parameters are used to synchronize data communication when : 1) the data transmission speed is too fast, characters may be skipped; 2) multitasking operation system or host computers in a network may slow down the keyboard handling; 3) various notebook or desktop PC systems require different timing parameter settings. Please always add one extra unit as safety margin when adjusting these two parameters.
- **Interfunction Delay** is a time delay between the transmission of each segment of the message string.





PROGRAM

## Keyboard Interface Control

### ◆ Emulation Setting & Upper/Lower Case Setting ◆



F\_DEFAULT

<b>Function Key Emulation</b> 	SS SS	Enable ASCII 00-31 code as keyboard function code output ◆ Ctrl-Output  Refer to Appendix – Keyboard Function Code Table for details.	0 1
<b>Key Pad Emulation</b> 	SS SS	Disable key pad emulation ◆ Enable numeric output as key pad (Num Lock On) output	0 1
<b>Upper/Lower Case</b> 	SS SS SS SS	Normal case (neglect the upper/lower case control) ◆ Inverse case (change all characters output to inverse case) Upper case (force all characters output as upper case) Lower case (force all characters output as lower case)	0 1 2 3





PROGRAM

## Serial Interface Control

### ◆ Record Suffix, Preamble, Postamble Setting ◆



F\_DEFAULT

<b>STX/ETX Control</b> 	SS SS	Disable STX/ETX transmission ◆ Enable STX/ETX transmission STX/ETX are two characters used to indicate the starting and ending of the total data frame transmitted via serial interface.	0 1
<b>Record Suffix</b> 	SS SS SS SS SS SS <b>MS</b>	None ◆ CR (0DH) ◆ LF (0AH) CRLF (0D0AH) TAB (09H) SPACE (20H) User defined character (1 character)	0 1 2 3 4 5 <b>6, (00-7F)</b>
<b>Preamble</b> 	SS <b>MS</b>	None ◆ 1-15 characters Maximum 15-character input; scan "FIN" to terminate this selection.	<b>FIN</b> <b>[00-7F], [FIN]</b>
<b>Postamble</b> 	SS <b>MS</b>	None ◆ 1-15 characters Maximum 15-character input; scan "FIN" to terminate this selection.	<b>FIN</b> <b>[00-7F], [FIN]</b>

▪ Serial Interface Message String (RS232, USB COM) :

STX	Preamble	Data Length	Prefix Symbol ID	Scanned Data	Suffix Symbol ID	Postamble	ETX	Record Suffix
1 character	1-15 characters	2-3 digits	1 or 2 characters	Variable length	1 or 2 characters	1-15 characters	1 character	1 character



PROGRAM

## Serial Interface Control

### ◆ Delay Setting ◆



F\_DEFAULT

<b>Intermessage Delay</b> 	SS MS	None ◆ 1-99 (x5) msec. Scan 2 digits from the option code chart in Appendix, then FuzzyScan will terminate this selection automatically.	<b>FIN</b> <b>(2 digits)</b>
<b>Intercharacter Delay</b> 	SS MS	None ◆ 1-99 (x5) msec. Scan 2 digits from the option code chart in Appendix, then FuzzyScan will terminate this selection automatically.	<b>FIN</b> <b>(2 digits)</b>
<b>Interfunction Delay</b> 	SS MS	None ◆ 1-99 (x5) msec. Scan 2 digits from the option code chart in Appendix, then FuzzyScan will terminate this selection automatically.	<b>FIN</b> <b>(2 digits)</b>

- **Intermessage Delay** is a time delay between messages output by FuzzyScan. Increasing this delay will help host applications process the incoming data on time.
- **Intercharacter Delay** is a time delay between data characters output by FuzzyScan. These two parameters are used to synchronize data communication when : 1) the data transmission speed is too fast, characters may be skipped; 2) multitasking operation system or host computers in a network may slow down the keyboard handling; 3) various notebook or desktop PC systems require different timing parameter settings. Please always add one extra unit as safety margin when adjusting these two parameters.
- **Interfunction Delay** is a time delay between the transmission of each segment of the message string.





PROGRAM

## Serial Interface Control

### ◆ Protocol, ACK/NAK Setting ◆



F\_DEFAULT

<b>Handshaking Protocol</b> 	SS	None (free running mode) ◆	0
	SS	RTS/CTS (hardware handshaking)	1
	SS	ACK/NAK (software handshaking)	2
	SS	Xon/Xoff (software handshaking)	3
<b>NAK Retry Count</b> 	SS	3 times ◆	<b>FIN</b> <b>(3 digits)</b>
	SS	0~255 times	
<b>ACK/NAK Transmission Indication</b> 	SS	Disable	0
	SS	Enable ◆	1

▪ USB COM doesn't support RTS/CTS handshaking protocol.

▪ When the **ACK/NAK Software Handshaking** option is selected, the FuzzyScan waits for an **ACK** (acknowledge) or **NAK** (not acknowledge) from the host computer after each data transmission. If the NAK is received, FuzzyScan will re-send the data until receiving ACK.

▪ **NAK Retry Count**

After transmitting data, the scanner expects a NAK response from the host up to the preset "Serial Response Time-out". If the scanner doesn't get a response, the scanner will issue an error indication and discard the data. When a NAK is received, the scanner transmits the same data again and waits for either an ACK or NAK. The scanner issues an error indication and discards the data under following two conditions:

- 1) After preset NAK retry counts is received within the preset serial response time-out.
- 2) If the preset time-out is up but the preset NAK retry counts haven't come to the end.

The default retry counts are three times. If you program "0 time", the scanner won't resend the data to the host when the scanner receives a NAK. The scanner will discard the data. If you program "255 times", the scanner can receive unlimited NAKs from the host within the pre-set serial response time-out.

This function is not available for batch mode. When you enable this function in on-line mode, the out-of-range function will be disable automatically.

▪ **ACK/NAK Transmission Indication:**

Disable: There's neither LED nor beeping indication for this setting.

Enable: There's a specific LED and beeping indication for this setting.



PROGRAM

## Serial Interface Control

◆ Time Out Setting, Baud Rate, Data Frame ◆



F\_DEFAULT

<b>Serial Response Time-out</b> 	SS	None	1 second	0	3
	SS	200 mseconds	2 seconds	1	4
	SS	500 mseconds ◆	5 seconds	2	5
	MS		User defined value (seconds)		6, (2 digits)
<b>Baud Rate (BPS)</b> 	SS	38.4K BPS	2400 BPS	0	4
	SS	19.2K BPS	1200 BPS	1	5
	SS	9600 BPS ◆	57.6K BPS	2	8
	SS	4800 BPS	115.2K BPS	3	9
<b>Data Frame</b> 	SS	8, None, 1 ◆	7, Space, 1	0	8
	SS	8, Odd, 1	7, Mark, 1	1	9
	SS	8, Even, 1	7, None, 2	2	A
	SS	8, Space, 1	7, Odd, 2	3	B
	SS	8, Mark, 1	7, Even, 2	4	C
	SS	8, None, 2	7, Space, 2	5	D
	SS	7, Odd, 1	7, Mark, 2	6	E
	SS	7, Even, 1		7	

- When the **RTS/CTS Hardware Handshaking** option is selected, the **RTS** (request to send) and **CTS** (clear to send) signals will be issued before normal data communication. This option is very helpful to ensure the reliability of data communication.
- The **Serial Response Time-out** is a pre-defined delay time for FuzzyScan to wait for handshaking, acknowledgment or non-acknowledgment from the host computer.



PROGRAM

## Operation Control

### ◆ Operation Mode Setting ◆



F\_DEFAULT

Operation Mode			
	SS	Trigger mode ◆	1
	SS	Presentation mode	2
	SS	Alternative mode	3
	SS	Force mode	5
	SS	Level mode	8

- **Trigger Mode (External Triggering)** When the scanner receives an external trigger or a serial trigger ON command under trigger mode, the scanner will turn on the light source to read barcode until gets a good read, a serial trigger OFF command or a release of external trigger. Once the light source goes off, the scanner is waiting for the next trigger to activate scanning again.
- **Presentation Mode (Auto Detection)** Under presentation mode, the scanner will automatically detect the object movement in the scanner field of view. Once the scanner detected a similar barcode image, the scanner will turn on the light source to read barcodes until the **preset scan input time-out** is up. For dark environments, you may adjust the setting of "Presentation Sensitivity" to increase the detection sensitivity
- **Alternative Mode (Periodic Power Off)** When the scanner receives an external trigger or a serial trigger ON command under alternative mode, the scanner will turn on the light source to read barcodes until the **preset scan input time-out** is up. The scan input time-out will be reset after each good read. Once the light source goes off, the scanner is waiting for the next trigger to activate scanning again.
- **Force Mode (Continued Power On)** Under force mode, the scanner continues to read barcodes without using external trigger or serial trigger. Please note that the scanner will not stop reading until you switch into another operation mode.
- **Level Mode (Auto Power Off)** When the scanner receives an external trigger or a serial trigger ON command under level mode, the scanner will turn on the light source to read barcodes until a **good read** is performed or the **preset scan input time-out** is up. Once the light source goes off, the scanner is waiting for the next trigger to activate scanning again.



PROGRAM

## Operation Control

### ◆ Buzzer, Indicator, Inverse Reading ◆



F\_DEFAULT

<b>Buzzer Tone Adjust</b> 	SS	Buzzer tone – mute	0
	SS	Buzzer tone – low	1
	SS	Buzzer tone – medium ◆	2
	SS	Buzzer tone – high	3
	SS	Buzzer tone - extremely high	4
	SS	Power-on beep ◆	5
	SS	No power-on beep	6
<b>Power On Indicator</b> 	SS	Disable (LED off)	0
	SS	LED steady on ◆	1
		LED flash	2
<b>Good Read Indicator</b> 	SS	Disable	0
	SS	Enable ◆	1
<b>Inverse Reading</b> 	SS	Disable ◆	0
	SS	Enable	1





PROGRAM

## Operation Control

### ◆ Dollar Sign, Redundancy, Scan Rate Control ◆



F\_DEFAULT

<b>Dollar Sign Control</b> 	SS	Dollar sign output as "\$" ◆	0
	SS	Dollar sign output as "¥"	1
	SS	Dollar sign output as "€"	2
	SS	Dollar sign output as "£"	3
	SS	Dollar sign output as "¢"	4
<b>Redundancy</b> 	SS	None	0
	SS	Level 1 ◆	1
	SS	Level 2	2
	SS	Level 3	3
	SS	Level 4	4
	SS	Level 5	5
		To prevent potential miss reading.	
<b>Scan Rate Control</b> 	SS	Dynamic ◆	0
	SS	Fixed	1

- The **Redundancy** is the number of times the same bar code label has to be decoded before it is transmitted.
- **Scan Rate Control**: The scanner will have better motion tolerance when you select "Fixed" scan rate. It's suitable for application which needs higher motion tolerance on the move. But this may impact to the reading distance.





PROGRAM

## Operation Control

### ◆ Delay Setting ◆



F\_DEFAULT

<b>Reread Delay</b> <b>(Double San Verification)</b> 	SS	Disable	0
	SS	Immediate time out ◆	1
	SS	Short time out	2
	SS	Medium time out	3
	SS	Long time out	4
	SS	Force verification	5
	<b>Good Read Delay</b> 	SS	None ◆
SS		200 msec.	1
SS		500 msec.	2
SS		1 sec.	3
SS		1.5 sec.	4
SS		2 sec.	5
SS		3 sec.	6

- The **Reread Delay (Double Scan Verification)** is designed to inhibit FuzzyScan from reading the same bar code label twice in pre-defined short duration. Force Verification will not allow reading of the same bar code twice.
- This **Good Read Delay** is the minimum amount of time before the imager can read another bar code.





PROGRAM

## Operation Control

### ◆ Time-out and Duration Setting ◆



F\_DEFAULT

<b>Scan Input Time-out</b> 	SS	100 msec.	600 msec.	0
	SS	200 msec.	700 msec.	1
	SS	300 msec.	800 msec.	2
	SS	400 msec.	900 msec. ◆	3
	SS	500 msec.		4
	MS		User define: 1-99 sec.	
<b>Hands Free Time-out</b> 	SS	Short ◆		0
	SS	Medium		1
	SS	Long		2
	SS	Extremely long		3
	SS	Disable		4
<b>Good Read Duration</b> 	SS	Short		0
	SS	Medium ◆		1
	SS	Long		2
	SS	Extremely long		3
	SS	Extremely short		4

- The **Scan Input Time-out** is a preset light source time out counter for Alternative Mode, Presentation Mode and Level Mode. The scanner keeps the light source on till the preset light source on time is up. You can adjust this parameter to meet your own application requirement.
- The presentation mode and force mode will be automatically changed to manual trigger mode when you activate the trigger. You can remain the scanner in manual trigger mode by setting the **Hands Free Time-Out**. Once the time-out duration is up (if there's no any trigger operation), the imager will revert to the original presentation or force mode.



PROGRAM

## Operation Control

### ◆ Presentation Scanning Setting ◆



F\_DEFAULT

<b>Presentation Sensitivity</b> 	SS	Level 1	Level 6	0	5
	SS	Level 2	Level 7	1	6
	SS	Level 3		2	
	SS	Level 4		3	
	SS	Level 5 ◆		4	

■ The presentation sensitivity is used to configure the sensitivity level when the scanner is set as presentation mode. The higher level means higher sensitivity for detecting the barcode.



PROGRAM

## Operation Control

### ◆ OK/NG Signal and Beeping Control ◆



F\_DEFAULT

<b>OK/NG Signal Active State</b> 	SS OK low/NG low ◆ SS OK low/NG high SS OK high/NG low SS OK high/NG high	0 1 2 3													
<b>OK/NG Signal Output Control</b> 	SS Disable OK and NG output SS Enable NG output SS Enable OK output SS Enable OK and NG output ◆	0 1 2 3													
<b>NG Message Output</b> 	SS None SS Message "NG" SS User defined message (1~15 characters) Maximum 15-character input ; scan "FIN" to terminate this section.	0 1 2, [ 00- 7F ]													
<b>OK/NG Signal Duration</b> 	SS 10 msec. SS 20 msec. SS 30 msec. SS 40 msec. SS 50 msec. <b>MS</b>	60 msec. 70 msec. 80 msec. 90 msec. 100 msec. ◆ User define: 1-99 (x50) msec.	<table border="1"> <tr> <td>0</td> <td>5</td> </tr> <tr> <td>1</td> <td>6</td> </tr> <tr> <td>2</td> <td>7</td> </tr> <tr> <td>3</td> <td>8</td> </tr> <tr> <td>4</td> <td>9</td> </tr> <tr> <td colspan="2">A, (2 digits)</td> </tr> </table>	0	5	1	6	2	7	3	8	4	9	A, (2 digits)	
0	5														
1	6														
2	7														
3	8														
4	9														
A, (2 digits)															
<b>OK/NG Beeping Control</b> 	SS Disable OK and NG beep SS Enable OK and NG beep ◆ SS Enable OK beep and disable NG beep SS Enable NG beep and disable OK beep	0 1 2 3													

- The **OK/NG Signal Active State** can control the logic level in digit circuits design, you can adjust the active-high or active-low state for OK and NG signal outputs. The OK and NG signals are NPN outputs.
- The **OK/NG Signal Output Control** can control the OK/NG signal outputs and OK/NG indications of the scanner. If you disable OK or NG signal output, the scanner OK or NG indication will be disabled.
- The **OK/NG Signal Duration** can control the OK/NG signal duration and OK/NG indication duration of the scanner.



PROGRAM

## Condensed DataWizard

### ◆ Preamble, Postamble, Data Length & Symbol ID Trans. ◆



F\_DEFAULT

<p><b>Preamble</b></p>	<p>SS None ◆ MS 1-15 characters</p>	<p>Maximum 15-character input; scan "FIN" to terminate this selection.</p>	<p><b>FIN</b> [00-7F], [FIN]</p>
<p><b>Postamble</b></p>	<p>SS None ◆ MS 1-15 characters</p>	<p>Maximum 15-character input; scan "FIN" to terminate this selection.</p>	<p><b>FIN</b> [00-7F], [FIN]</p>
<p><b>Data Length Transmission</b></p>	<p>SS Disable ◆ SS Enable 2 digits data length transmission</p>	<p>If data length exceeds 99, 3-digit data length will be transmitted.</p>	<p>0 1</p>
<p><b>Symbology ID Transmission</b></p>	<p>SS Disable symbology ID transmission ◆ SS Enable prefix symbology ID transmission SS Enable suffix symbology ID transmission SS Enable both prefix and suffix symbology ID transmission SS Enable prefix AIM symbology ID transmission SS Enable suffix AIM symbology ID transmission SS Enable both prefix and suffix AIM symbology ID transmission</p>		<p>0 1 2 3 4 5 6</p>

- **DataWizard** is the most powerful, Artificial-Intelligence based data editing expert system provided specially for the FuzzyScan family bar code readers. Through DataWizard, you can process the scanned data prior the transmissions in many ways as: **Insert, Delete, Match, Verify, Replace, Reorganize, and Repeat Transmission**. It will help you to arrange the transmission of scanned data to any specific format without software modification.
- Due to the resources used by this system, **Full-feature DataWizard** is only supported by **PowerTool**. Through the PowerTool, all settings and configurations can be done on-screen, under Windows 95/98/NT/2000/XP environment.
- A **Condensed Version DataWizard** is provided by each FuzzyScan series. Through this menu, the condensed DataWizard can be utilized via bar code menu readings with ease.
- Please note that all "**Character**" input should be referred to the **ASCII/HEX Table** listed in Appendix to find matched HEX value.
- If you have any problem to use DataWizard, please refer to following pages for details and consult your local FuzzyScan vendor or our web site for any assistance.



PROGRAM

## Condensed DataWizard

### ◆ Data Formatter Setting ◆



F\_DEFAULT

<b>Formatter Control</b> 	SS <b>MS</b> MS	Disable ◆ Select one bar code symbology Select all bar code symbologies	<b>FIN</b> <b>(2 digits)</b> 00	automatic termination automatic termination
<b>1st Insertion</b> 	SS <b>DS</b>	Disable ◆ Enable  2-digits identified position; max. 3 insertion characters	<b>FIN</b> <b>(2 digits)</b>  position	[1-3 characters], [FIN]
<b>2nd Insertion</b> 	SS <b>DS</b>	Disable ◆ Enable  2-digits identified position; max. 3 insertion characters	<b>FIN</b> <b>(2 digits)</b>  position	[1-3 characters], [FIN]
<b>3rd Insertion</b> 	SS <b>DS</b>	Disable ◆ Enable  2-digits identified position; max. 3 insertion characters	<b>FIN</b> <b>(2 digits)</b>  position	[1-3 characters], [FIN]
<b>4th Insertion</b> 	SS <b>DS</b>	Disable ◆ Enable  2-digits identified position; max. 3 insertion characters	<b>FIN</b> <b>(2 digits)</b>  position	[1-3 characters], [FIN]

- The **Data Formatter** is used to edit the scanned raw data prior to transmitting the data to the host computers or terminals. It allows you to select desired bar code symbologies for formatter control, and provides **Multiple Position Insertion** and **Multiple Character Insertion** (max three characters) in the identified position.
- While the Data Formatter is enabled, it arranges only scanned data without **Preamble**, **Postamble**, **STX**, **ETX**, **Data Length**, **Prefix/Suffix Symbology ID** or **Record Suffix**. All of the above programmable parameters perform the same function depending on your setting.
- Regarding the “**Bar Code Selection**” and “**Position Calculation**” of data formatter, please refer to page 49 for details.
- Please note that all “**Character**” input should be referred to the **ASCII/HEX Table** listed in Appendix to find matched HEX value.



PROGRAM

## Condensed DataWizard

### ◆ Data Verifier Setting ◆



F\_DEFAULT

<b>Verifier Control</b> 	SS <b>MS</b> MS	Disable ◆ Select one bar code symbology Select all bar code symbologies	<b>FIN</b> <b>(2 digits)</b> <b>00</b>	automatic termination automatic termination
<b>Identified Data Length</b> 	SS <b>DS</b>	Disable ◆ Enable  Determine the identified data length for verification.	<b>FIN</b> <b>(2 digits)</b>	
<b>1st Identified Character</b> 	SS <b>DS</b>	Disable ◆ Enable  2-digits checking position; 1 identified character	<b>FIN</b> <b>(2 digits)</b>  position	<b>[00-7F]</b>
<b>2nd Identified Character</b> 	SS <b>DS</b>	Disable ◆ Enable  2-digits checking position; 1 identified character	<b>FIN</b> <b>(2 digits)</b>  position	<b>[00-7F]</b>
<b>3rd Identified Character</b> 	SS <b>DS</b>	Disable ◆ Enable  2-digits checking position; 1 identified character	<b>FIN</b> <b>(2 digits)</b>  position	<b>[00-7F]</b>

- The **Data Verifier** is used to provide advanced verification for error-free scanning and to work as an **Embedded Data Transmitting Filter**.
- All data must conform to the **Identified Bar Code Symbologies**, **Identified Data Length**, and one to three **Identified Characters** in the checking position. Otherwise, the FuzzyScan will not transmit the data to the host computers or terminals, but will instead issue **3 long beeps** for verification error and **skip** the scanned data.
- The Data Verifier checks only scanned data without **Preamble**, **Postamble**, **STX**, **ETX**, **Data Length**, **Prefix/Suffix Symbology ID** or **Record Suffix**.
- Regarding the “**Bar Code Selection**” and “**Position Calculation**” of **Data Verifier**, please refer to page 49 for details.
- Please note that all “**Character**” input should be referred to the **ASCII/HEX Table** listed in Appendix to find matched HEX value.



PROGRAM

## Condensed DataWizard

### ◆ Data Replacer Setting ◆



F\_DEFAULT

<b>Replacer Control</b> 	SS MS MS	Disable ◆ Select one bar code symbology Select all bar code symbologies	<b>FIN</b> <b>(2 digits)</b> 00	automatic termination automatic termination
<b>1st Replacement</b> 	SS DS	Disable ◆ Enable  2-digits identified position; 1 replacement character	<b>FIN</b> <b>(2 digits)</b>  position	[00-7F]
<b>2nd Replacement</b> 	SS DS	Disable ◆ Enable  2-digits identified position; 1 replacement character	<b>FIN</b> <b>(2 digits)</b>  position	[00-7F]
<b>3rd Replacement</b> 	SS DS	Disable ◆ Enable  2-digits identified position; 1 replacement character	<b>FIN</b> <b>(2 digits)</b>  position	[00-7F]

- The **Data Replacer** is used to edit the scanned raw data prior to transmitting the data to the host computers or terminals. It allows you to select desired bar code symbologies for replacer control, and provides **Multiple Position Replacement** in the identified position.
- All data must conform to the **Identified Bar Code Symbologies**, and one to three **Identified Characters** in the identified position. While the Data Replacer is enabled, it arranges only scanned data without **Preamble**, **Postamble**, **STX**, **ETX**, **Data Length**, **Prefix/Suffix Symbology ID** or **Record Suffix**.
- Regarding the “**Bar Code Selection**” and “**Position Calculation**” of Data Replacer, please refer to page 49 for details.
- Please note that all “**Character**” input should be referred to the **ASCII/HEX Table** listed in Appendix to find matched HEX value.





PROGRAM

## Condensed DataWizard

### ◆ Data Organizer Setting ◆



F\_DEFAULT

<b>Organizer Control</b> 	SS MS MS	Disable ◆ Select one bar code symbology Select all bar code symbologies	<b>FIN</b> <b>(2 digits)</b> 00	automatic termination automatic termination
<b>1st Organization</b> 	SS DS	Disable ◆ Enable 2-digits identified position; Forward/backward data transmission setting	<b>FIN</b> <b>(2 digits)</b> position direction	0 (Forward) ◆ 1 (Backward)
<b>2nd Organization</b> 	SS DS	Disable ◆ Enable 2-digits identified position; Forward/backward data transmission setting	<b>FIN</b> <b>(2 digits)</b> position direction	0 (Forward) ◆ 1 (Backward)
<b>Include/Exclude Control</b> 	SS DS	Transmitted data excluded the data of identified position ◆ Transmitted data included the data of identified position	0 1	

- The **Data Organizer** is used to edit the scanned raw data prior to transmitting the data to the host computers or terminals. It allows you to select desired bar code symbologies for organizer control, and provides maximum two identified positions to send the data **forward** or **backward**. It also allows you to control the transmitted data **including** or **excluding** the data of identification position. Please refer to the application example listed in page 37 for details.
- While the Data Organizer is enabled, it arranges only scanned data without **Preamble**, **Postamble**, **STX**, **ETX**, **Data Length**, **Prefix/Suffix Symbology ID** or **Record Suffix**.
- Regarding the “**Bar Code Selection**” and “**Position Calculation**” of Data Organizer, please refer to page 49 for details.
- Please note that all “**Character**” input should be referred to the **ASCII/HEX Table**.

### Select a Bar Code Symbology

You can select one or all types of bar code symbologies to use Condensed DataWizard for advanced transmission arrangement. If you scan “00” to select all types, the FuzzyScan will arrange all incoming data to meet your pre-defined format. If you want to select only one type bar code, please select one of the option code listed below.

Code 128 : <b>01</b>	EAN-8 : <b>05</b>	Code 93 : <b>09</b>
UCC/EAN 128 : <b>31</b>	EAN-8 with 2 suppl. : <b>35</b>	Code 11 : <b>10</b>
UPC-A : <b>02</b>	EAN-8 with 5 suppl. : <b>45</b>	MSI/Plessey : <b>11</b>
UPC-A with 2 suppl. : <b>32</b>	Codabar/NW-7 : <b>06</b>	UK/Plessey : <b>12</b>
UPC-A with 5 suppl. : <b>42</b>	Code 39 : <b>07</b>	Telepen : <b>13</b>
UPC-E : <b>03</b>	Code 32 : <b>37</b>	GS1 Data Bar : <b>14</b>
UPC-E with 2 suppl. : <b>33</b>	Trioptic Code 39 : <b>47</b>	IATA : <b>15</b>
UPC-E with 5 suppl. : <b>43</b>	Matrix 2 of 5 : <b>38</b>	Coupon Code : <b>16</b>
EAN-13 : <b>04</b>	Interleaved 2 of 5 : <b>48</b>	PDF417/MicroPDF417 : <b>22</b>
EAN-13 with 2 suppl. : <b>34</b>	China Postal Code : <b>58</b>	Codablock : <b>23</b>
EAN-13 with 5 suppl. : <b>44</b>	German Postal Code : <b>68</b>	Korea Post Code : <b>26</b>

### Position Calculation

#### [Data Formatter]

If there is a 5-character input data string, refer to the following to calculate the actual position for insertion:

	X		X		X		X		X	
00	01	02	03	04	05					

### [Data Verifier, Data Replacer, Data Organizer]

If there is a 11-character data string, please refer to the following to calculate the actual position for identification.

X	X	X	X	X	X	X	X	X	X	X
00	01	02	03	04	05	06	07	08	09	10

### Application Example

If your bar code label is a 16-digit Interleaved 2 of 5 which includes the information of 6-digit date code, 6-digit serial number and 4-digit unit price, you want the FuzzyScan do the following for you without software modification:

- Apply only Interleaved 2 of 5 to the condensed DataWizard.
- Check bar code is actually with 16-digit length.
- Allow bar code output whose date code is leading with “9”.
- Three outputs with “TAB” suffix.
- The date code output should skip “9” and replaced it by “A”.
- The serial number output should be led with “SN”.
- The unit price output should be skipped the first 2 digits.
- Test Bar Code : **9 8 1 0 2 5 1 2 3 4 5 6 9 8 7 6**
- Actual Output : **A81025[TAB]SN123456[TAB]76[TAB]**

## Programming Procedure

### [Data Verifier]

- Scan “Program” to enter the programming mode.
- Scan “Verifier Control” and set bar code symbology to “**48**” (Interleaved 2 of 5).
- Scan “Identified Data Length” and set the length to “**16**”.
- Scan “1st Identified Character” and set the identified position to “**00**”, then set the identified character to “**39**” (Hex Code of 9).

### [Data Formatter]

- Scan “Formatter Control” and set bar code symbology to “**48**”.
- Scan 1st Insertion” and set the identified position to “**06**”, then inserted characters to “**09**” (Hex Code of TAB), “**53**” (Hex Code of S), “**4E**” (Hex Code of N).
- Scan “2nd Insertion” and set the identified position to “**12**”, then inserted character to “**09**”. In the final, you must scan “**FIN**” (Finish) code to terminate this selection.
- Scan “3rd Insertion” and set the identified position to “**16**”, then inserted character to “**09**”. In the final, you must scan “**FIN**” (Finish) code to terminate this selection.

### [Data Replacer]

- Scan “Replacer Control” and set bar code symbology to “**48**”.
- Scan “1st Replacement” and set the identified position to “**00**”, then replaced character to “**41**” (Hex Code of A).

### [Data Organizer]

- Scan “Organizer Control” and set bar code symbology to “**48**”.
- Scan “1st Organization” and set the identified position to “**16**”, then set the data transmission to “**0**” (forward).
- Scan “2nd Organization” and set the identified position to “**17**”, then set the data transmission to “**1**” (backward).
- Scan “**END**” (Exit) to terminate the programming.

### [Important Notice]

Please note that Condensed DataWizard will follow the preset working flow as below:

**Verifier ► Formatter ► Replacer ► Organizer**

So when you set the identified position in Data Organizer, you must consider the inserted data which you already set via Data Formatter.

## Symbology ID Table

Each AIM Code Identifier contains the three-character string **Jcm** where:

J = Flag Character

c = Code Character

m = Modifier Character

Code Family	Primary Format	Cino ID	AIM ID		Code Family	Primary Format	Cino ID	AIM ID	
		Code Character	Code Character	Modified Character			Code Character	Code Character	Modified Character
UPC	UPC-A	A	E	m	EAN/JAN	EAN/JAN-8	N	E	4
	UPC-A with 2 suppl.			1		EAN/JAN-8 with 2 suppl.			1
	UPC-A with 5 suppl.			2		EAN/JAN-8 with 5 suppl.			2
	UPC-E	E		m		EAN/JAN-13	F	E	m
	UPC-E with 2 suppl.			1		EAN/JAN-13 with 2 suppl.			1
	UPC-E with 5 suppl.			2		EAN/JAN-13 with 5 suppl.			2
	Example: A UPC-A bar code 012345678950 with 2 supplement 12 is transmitted as <b>JE0012345678950JE112</b>					Example: A EAN/JAN-8 bar code 49123562 with 5 supplement 12345 is transmitted as <b>JE449123562JE212345</b>			
Code 128	Code 128	B	C	m	Code 93	Code 93	H	G	m
	UCC/EAN-128	C		1	Code 11	Code 11	P	H	m
Codabar	Codabar/NW-7	D	F	m	MSI/Plessey	MSI/Plessey	R	M	m
Code 25	Standard/Industrial 2 of 5	I	S	0	UK/Plessey	UK/Plessey	S	P	0
	Matrix 2 of 5	K	X	0	Telepen	Telepen	T	B	m
	Interleaved 2 of 5	J	I	m	GS1 DataBar	GS1 Databar	X	e	0
	China Postal Code	L	X	0	Composite	Composite Code			
	German Postal Code	M	I	3	Code 39	Code 39	G	A	m
				Code 39 Trioptic		W	X	0	
IATA	IATA	O	R	m		Code 32	G	A	0
UCC Coupon	UCC Coupon Code	Z			PDF417	PDF417/Micro PDF417	V	L	0
	Example : A UPC-A 512345678900 + UCC/EAN-128 81010123451297 bar code is transmitted as <b>JE0512345678900JC181010123451297</b>				Codablock	Codablock F	Y	O	0
	Example: A EAN-13 9923456789019 + UCC/EAN-128 81010123451297 bar code is transmitted as <b>JE09923456789019JC181010123451297</b>				Korea Post	Korea Post Code	a	X	0
	Remark: Above examples are given for the transmission of AIM ID.								

## Keyboard Function Code Table

No.	ANSI	ASCII	Key Function	No.	ANSI	ASCII	Key Function
00	NUL	00H	RESERVED	16	DLE	10H	F7
01	SOH	01H	CTRL (Left)	17	DC1	11H	F8
02	STX	02H	ALT (Left)	18	DC2	12H	F9
03	ETX	03H	SHIFT	19	DC3	13H	F10
04	EOT	04H	CAPS LOCK	20	DC4	14H	F11
05	ENQ	05H	NUM LOCK	21	NAK	15H	F12
06	ACK	06H	ESC	22	SYN	16H	INS (Insert) (Edit)
07	BEL	07H	F1	23	ETB	17H	DEL (Delete) (Edit)
08	BS	08H	BACK SPACE	24	CAN	18H	HOME (Edit)
09	HT	09H	TAB	25	EM	19H	END (Edit)
10	LF	0AH	F2	26	SUB	1AH	PAGE UP (Edit)
11	VT	0BH	F3	27	ESC	1BH	PAGE DOWN (Edit)
12	FF	0CH	F4	28	FS	1CH	UP (Edit)
13	CR	0DH	ENTER (CR)	29	GS	1DH	DOWN (Edit)
14	SO	0EH	F5	30	RS	1EH	LEFT (Edit)
15	SI	0FH	F6	31	US	1FH	RIGHT (Edit)

 To emulate the keyboard function key input for user definable parameters, user must configure actual content using the **Reserved ASCII 0 – 31** characters, and also **Enable** the “Function Key Emulation”. Otherwise, the Ctrl output will be done by the scanner. Please refer to the above Keyboard Function Code Table which is for IBM PC/XT/AT, PS/2, PS/VP, COMPAQ PC, HP Vectra PC, Notebook PC, APPLE and PowerMac, and WYSE PC Enhanced or fully compatible machines.

## ASCII Input Shortcut

To configure the user definable parameters of FuzzyScan via programming menu, FuzzyScan will ask you to scan your desired ASCII value in **HEX** form. You have to refer to the “**HEX/ASCII Table**” for details.

### Example:

If you want the scanned data output leading with a Dollar Sign, you have to set the “Preamble” to “\$”. The configuration procedure is listed below for reference.

- Scan the system command – **PROGRAM** listed on page 3-24 to enter programming mode.
- Scan family code – **PREAMBLE** to select this family.
- Refer to the **Hex/ASCII Table**, you will find the HEX value of “\$” is **24**.
- Scan the option code – **2** listed on the fold out back cover.
- Scan the option code – **4** listed on the fold out back cover.
- Scan the system command – **FIN (Finish)** to terminate Preamble setting.
- Scan the system command – **End** to exit the programming mode for normal operation.

## HEX/ASCII Reference Table

L \ H	0	1	2	3	4	5	6	7
<b>0</b>	NUL	DLE	SPACE	0	@	P	`	p
<b>1</b>	SOH	DC1	!	1	A	Q	a	q
<b>2</b>	STX	DC2	"	2	B	R	b	r
<b>3</b>	ETX	DC3	#	3	C	S	c	s
<b>4</b>	EOT	DC4	\$	4	D	T	d	t
<b>5</b>	ENQ	NAK	%	5	E	U	e	u
<b>6</b>	ACK	SYN	&	6	F	V	f	v
<b>7</b>	BEL	ETB	'	7	G	W	g	w
<b>8</b>	BS	CAN	(	8	H	X	h	x
<b>9</b>	HT	EM	)	9	I	Y	i	y
<b>A</b>	LF	SUB	*	:	J	Z	j	z
<b>B</b>	VT	ESC	+	;	K	[	k	{
<b>C</b>	FF	FS	,	<	L	\	l	
<b>D</b>	CR	GS	-	=	M	]	m	}
<b>E</b>	SO	RS	.	>	N	^	n	~
<b>F</b>	SI	US	/	?	O	_	o	DEL

Example : ASCII “A” → HEX “41”; ASCII “a” → “61”

: High Byte of HEX Value

: Low Byte of HEX Value

### Host Interface Quick Set



RS232 Serial



USB Com Port Emulation



USB HID Standard Mode



USB HID Turbo Mode

### Operation Mode Quick Set



◆ Trigger Mode



Force Mode (Continued power on)



Alternative Mode (Periodic power off)



Presentation Mode (Auto sensing)



Level Mode (Auto power off)

## Option Codes



0



1



2



3



4



5



6



7



8



9



A



B



C



D



E



F



**FIN (Finish)**



**END (Exit)**



## System Commands



**PROGRAM**  
(Enter Programming Mode)



**FIN (Finish)**



**END**  
(Exit Programming Mode)



**Save User Default**



**User Default**



**System Information List**  
(SYSLIST)



**PowerTool Host Link**



**Factory Default**



**Master Default**

- 
**Factory Default:** After scanning "Factory Default" command, all parameters will be returned to factory default value.
- Master Default:** After scanning "Master Default" command, the scanner will remain the pre-set parameters of **Host Interface Selection**, **Keyboard Interface Control** (except Record Suffix; Preamble; Postamble), **Serial Interface Control** (except Record Suffix; Preamble; Postamble), and **Wand/Laser Emulation Control**, the rest of parameters will be returned to default value.
- User Default:** After scanning "Save User Default" command, all current parameters will be stored to the flash memory. Once you change the parameter and would like to return to previous setting, please scan "User Default".

## Indications

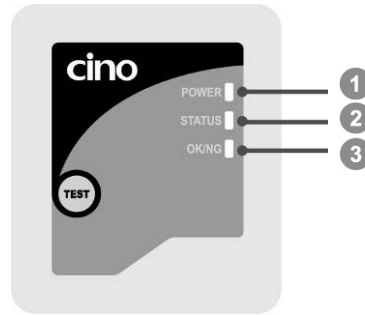

- 1 Power Indicator
- 2 Status Indicator
- 3 OK/NG Indicator

### Normal Operation

Descriptions	Indicators			Beeper
	Power	Status	OK/NG	
Power on	Steady blue	Off	Off	Power on beep
Good read (OK reading)	Off	Off	1 green blink	1 good read beep
No read (NG reading)	Off	Off	1 red blink	1 no read beep

### Test Mode Reading Rate Information

Reading Rate	Indicators			Beeper
	Power	Status	OK/NG	
100%	1 blue blink per 1 sec.	Steady Green	Steady Green	One short beep
80 to 99%		Steady Red	Steady Green	
50 to 79%		Steady Green	Steady Red	
20 to 49%		Steady Orange	Steady Orange	
0 to 19%		Steady Red	Steady Red	



[www.cino.com.tw](http://www.cino.com.tw)

## Fixed Mount Scanner Programming Manual

CINO GROUP  
PC WORTH INT'L CO., LTD.

**cino**

## Free Manuals Download Website

<http://myh66.com>

<http://usermanuals.us>

<http://www.somanuals.com>

<http://www.4manuals.cc>

<http://www.manual-lib.com>

<http://www.404manual.com>

<http://www.luxmanual.com>

<http://aubethermostatmanual.com>

Golf course search by state

<http://golfingnear.com>

Email search by domain

<http://emailbydomain.com>

Auto manuals search

<http://auto.somanuals.com>

TV manuals search

<http://tv.somanuals.com>