







Cisco Unified IP Phone 7965G and 7945G Phone Guide for Cisco Unified Communications Manager 7.0 (SCCP and SIP)

Americas Headquarters

Cisco Systems, Inc.
170 West Tasman Drive
San Jose, CA 95134-1706
USA
<http://www.cisco.com>
Tel: 408 526-4000
800 553-NETS (6387)
Fax: 408 527-0883

Common Phone Tasks

View online help on phone	Press  .
Place a call	Go off-hook before or after dialing a number.
Redial a number	Press Redial .
Switch to handset during a call	Pick up the handset.
Switch to speaker or headset during a call	Press  or  , then hang up the handset.
Mute your phone	Press  .
Use your call logs	Press  to choose a call log. To dial, highlight a listing and go off-hook.
Edit a number	Press EditDial , << or >>.
Hold/resume a call	Press Hold or Resume .
Transfer call to new number	Press Transfer , enter the number, then press Transfer again.
Place an intercom call	Press intercom button , enter a number if necessary, and speak after you hear the tone.
Start a standard (ad hoc) conference call	Press more > Confrn , dial the participant, then press Confrn again.



Cisco, Cisco Systems, the Cisco logo, and the Cisco Systems logo are registered trademarks or trademarks of Cisco Systems, Inc. and/or its affiliates in the United States and certain other countries. All other trademarks mentioned in this document or Website are the property of their respective owners. The use of the word partner does not imply a partnership relationship between Cisco and any other company. (0705R)

© 2008 Cisco Systems, Inc. All rights reserved.

OL-15896-01



QUICK REFERENCE



Cisco Unified IP Phone 7965G and 7945G for Cisco Unified Communications Manager 7.0 (SCCP and SIP)



















Softkey Definitions
Phone Screen Icons
Button Icons
Common Phone Tasks











Softkey Definitions

AbbrDial	Dial using a speed dial index number
Answer	Answer a call
Back	Return to the previous Help topic
Barge	Add yourself to a call on a shared line
CallBack	Receive notification when a busy extension becomes available
Cancel	Cancel an action or exit a screen without applying changes
cBarge	Add yourself to a call on a shared line and establish a conference
CFwdALL	Setup/cancel call forwarding
Clear	Delete records or settings
Close	Close the current window
ConfList	View conference participants
Confrn	Create a conference call
Delete	Remove characters to the right of the cursor when using EditDial
Details (SCCP only)	Open the Details record for a multiparty call in the Missed Calls and Received Calls logs
Dial	Dial a phone number
DirTrfr (SCCP only)	Transfer two calls to each other
DND	Turn on/off Do Not Disturb (DND)
EditDial	Edit a number in a call log
EndCall	Disconnect the current call or the current intercom call
Erase	Reset settings to their defaults
Exit	Return to the previous screen









GPickUp	Answer a call that is ringing in another group or on another line
iDivert	Divert or redirect a call to a voice message system
Join	Join together existing calls to create a conference
Links	View related Help topics
Main	Display the Help main menu
MeetMe	Host a Meet-Me conference call
more	Display additional softkeys
New Call	Make a new call
OPickUp	Answer a call that is ringing in an associated group
Park	Store a call using Call Park
PickUp	Answer a call that is ringing on another phone in your group
QRT	Submit call problems to the system administrator
Redial	Redial the most recently dialed number
Remove	Remove a conference participant
Resume	Resume a call on hold
RmLstC	Drop the last party added to a conference call
Save	Save the chosen settings
Search	Search for a directory listing
Select	Select a menu item or call
Transfer	Transfer a call
Update	Refresh content
VidMode (SCCP only)	Choose a video display mode
<<	Delete entered characters
>>	Move through entered characters

Phone Screen Icons

	Call Forwarding enabled
	Call on hold
	Connected call
	Incoming call
	Off-hook
	On-hook
	Shared line in use
	Message waiting
	Authenticated call
	Encrypted call
	BLF- monitored line is in-use
	BLF-monitored line is idle
	BLF-monitored line is ringing (BLF Pickup)
	Speed-dial, call log, or directory listing (line status unknown)
	Line in Do Not Disturb (BLF feature)
	Intercom line in idle state
	Intercom line in one-way audio
	Intercom line in two-way audio
	Handset in use
	Headset in use
	Speakerphone in use

	Video enabled (SCCP only)
	Feature assigned to button
	Mobility assigned to button
	Hold assigned to button
	Conference assigned to button
	Transfer assigned to button
	Phone service URL assigned to button
	URL entry is ready to edit (SIP only)
	Option selected
	Feature enabled

Button Icons

	Messages
	Services
	Help
	Directories
	Settings
	Volume
	Speaker
	Mute
	Headset

Contents

Getting Started 1

Using this Guide 1

Finding Additional Information 2

 Accessing Cisco Unified IP Phone 7900 Series eLearning Tutorials 2

Safety and Performance Information 2

Cisco Product Security Overview 3

Accessibility Features 3

Connecting Your Phone 4

An Overview of Your Phone 8

Understanding Buttons and Hardware 8

Understanding Lines and Calls 13

 Understanding Line and Call Icons 13

Understanding Phone Screen Features 15

 Choosing Phone Screen Items 16

 Cleaning and Maintaining the Phone Screen 16

 Waking the Phone Screen from Sleep Mode 16

Understanding Feature Buttons and Menus 17

 Accessing the Help System on Your Phone 17

Understanding Feature Availability 18

Understanding SIP vs. SCCP 19

Basic Call Handling 20

Placing a Call—Basic Options 20

Placing a Call—Additional Options 21

Answering a Call 23

Ending a Call 25

Using Hold and Resume	25
Using Mute	26
Switching Between Multiple Calls	27
Switching an In-Progress Call to Another Phone	27
Viewing Multiple Calls	27
Transferring Calls	28
Sending a Call to a Voice Message System	29
Forwarding Calls to Another Number	30
Using Do Not Disturb	31
Making Conference Calls	32
Using Conference Features	32
Using Conference	33
Using Join	34
Using cBarge	34
Using Meet-Me	35
Viewing or Removing Conference Participants	36
Starting or Joining a Meet-Me Conference Call	36
Placing or Receiving Intercom Calls	37
Advanced Call Handling	39
Speed Dialing	39
Picking Up a Redirected Call on Your Phone	40
Storing and Retrieving Parked Calls	41
Logging Out of Hunt Groups	42
Using a Shared Line	42
Understanding Shared Lines	42
Using Barge to Add Yourself to a Shared-Line Call	43
Understanding Barge Features	43
Using Barge Features	44
Preventing Others from Viewing or Barging a Shared-Line Call	44
Using BLF to Determine a Line State	45
Making and Receiving Secure Calls	46
Tracing Suspicious Calls	47

Prioritizing Critical Calls	47
Using Cisco Extension Mobility	49
Managing Business Calls Using a Single Phone Number	49

Using a Handset, Headset, and Speakerphone 52

Using a Handset	52
Using a Headset	52
Using a Speakerphone	53
Using AutoAnswer with a Headset or Speakerphone	54

Changing Phone Settings 55

Customizing Rings and Message Indicators	55
Customizing the Phone Screen	56

Using Call Logs and Directories 57

Using Call Logs	57
Directory Dialing	59
Using Corporate Directory on Your Phone	59
Using Personal Directory on Your Phone	60

Accessing Voice Messages 63

Using the User Options Web Pages 64

Accessing Your User Options Web Pages	64
Configuring Features and Services on the Web	65
Using Personal Directory on the Web	65
Using Your Personal Address Book on the Web	65
Configuring Fast Dials on the Web	67
Using the Address Book Synchronization Tool	68
Setting Up Speed Dials on the Web	68
Setting Up Phone Services on the Web	70
Controlling User Settings on the Web	72
Controlling Line Settings on the Web	72
Setting Up Phones and Access Lists for Mobile Connect	75
Using Cisco WebDialer	77

Understanding Additional Configuration Options 79

Troubleshooting Your Phone 82

General Troubleshooting 82

Viewing Phone Administration Data 83

Using the Quality Reporting Tool 83

Cisco One-Year Limited Hardware Warranty Terms 85

Index 87

Getting Started

Using this Guide

This guide provides you with an overview of the features available on your phone. You can read it completely for a solid understanding of your phone's capabilities or refer to the table below for pointers to commonly used sections.

If you want to...	Then...
Explore your phone on your own	Press  on the phone when you need assistance.
Review safety information	See Safety and Performance Information , page 2.
Connect your phone	See Connecting Your Phone , page 4.
Use your phone after it is installed	Start with An Overview of Your Phone , page 8.
Learn what the button lights mean	See Understanding Buttons and Hardware , page 8.
Learn about the phone screen	See Understanding Phone Screen Features , page 15.
Make calls	See Placing a Call—Basic Options , page 20.
Put calls on hold	See Using Hold and Resume , page 25.
Mute calls	See Using Mute , page 26.
Transfer calls	See Transferring Calls , page 28.
Make conference calls	See Making Conference Calls , page 32.
Set up speed dialing	See Speed Dialing , page 39.
Share a phone number	See Using a Shared Line , page 42.
Use your phone as a speakerphone	See Using a Handset, Headset, and Speakerphone , page 52.
Change the ring volume or tone	See Changing Phone Settings , page 55.
View your missed calls	See Using Call Logs , page 57.
Listen to your voice messages	See Accessing Voice Messages , page 63.
See softkey and icon definitions	Refer to the Quick Reference Card in the front of this guide.

Finding Additional Information

You can access the most current Cisco Unified IP Phone documentation on the World Wide Web at this URL:

http://www.cisco.com/en/US/products/hw/phones/ps379/products_user_guide_list.html

You can access the Cisco website at this URL:

<http://www.cisco.com/>

International Cisco websites can be accessed from this URL:

http://www.cisco.com/public/countries_languages.shtml

You can access the most current Licensing Information at this URL:

http://www.cisco.com/en/US/docs/voice_ip_comm/cuipph/all_models/openssl_license/7900_sslic.html

Accessing Cisco Unified IP Phone 7900 Series eLearning Tutorials

(SCCP phones only)

Cisco Unified IP Phone 7900 Series eLearning tutorials use audio and animation to demonstrate basic calling features. You can access eLearning tutorials online (for several phone models) from your personal computer. Look for the eLearning tutorial (English only) for your phone model in the documentation list at the following location:

http://www.cisco.com/en/US/products/hw/phones/ps379/products_user_guide_list.html



Note Although eLearning tutorials for the 7965G and 7945G Cisco Unified IP Phone are not available, refer to the Cisco Unified IP Phone 7900 Series eLearning tutorials for an overview of the common IP phone features and functionality.

Safety and Performance Information

Refer to these sections for information about the impact of power outages and other devices on your Cisco Unified IP Phone.

Power Outage

Your accessibility to emergency service through the phone is dependent on the phone being powered. If there is an interruption in the power supply, Service and Emergency Calling Service dialing will not function until power is restored. In the case of a power failure or disruption, you may need to reset or reconfigure equipment before using the Service or Emergency Calling Service dialing.

Using External Devices

The following information applies when you use external devices with the Cisco Unified IP Phone: Cisco recommends the use of good quality external devices (such as headsets) that are shielded against unwanted radio frequency (RF) and audio frequency (AF) signals.

Depending on the quality of these devices and their proximity to other devices such as mobile phones or two-way radios, some audio noise may still occur. In these cases, Cisco recommends that you take one or more of the following actions:

- Move the external device away from the source of the RF or AF signals.
- Route the external device cables away from the source of the RF or AF signals.
- Use shielded cables for the external device, or use cables with a better shield and connector.
- Shorten the length of the external device cable.
- Apply ferrites or other such devices on the cables for the external device.

Cisco cannot guarantee the performance of the system because Cisco has no control over the quality of external devices, cables, and connectors. The system will perform adequately when suitable devices are attached using good quality cables and connectors.



Caution

In European Union countries, use only external headsets that are fully compliant with the EMC Directive [89/336/EC].

Cisco Product Security Overview

This product contains cryptographic features and is subject to United States and local country laws governing import, export, transfer and use. Delivery of Cisco cryptographic products does not imply third-party authority to import, export, distribute or use encryption. Importers, exporters, distributors and users are responsible for compliance with U.S. and local country laws. By using this product you agree to comply with applicable laws and regulations. If you are unable to comply with U.S. and local laws, return this product immediately.

Further information regarding U.S. export regulations may be found at http://www.access.gpo.gov/bis/ear/ear_data.html.

Accessibility Features

A list of accessibility features is available upon request. You can find more information about Cisco accessibility features at this URL:

www.cisco.com/go/accessibility

Connecting Your Phone

Your system administrator will likely connect your new Cisco Unified IP Phone to the corporate IP telephony network. If that is not the case, refer to the graphic and table below to connect your phone.

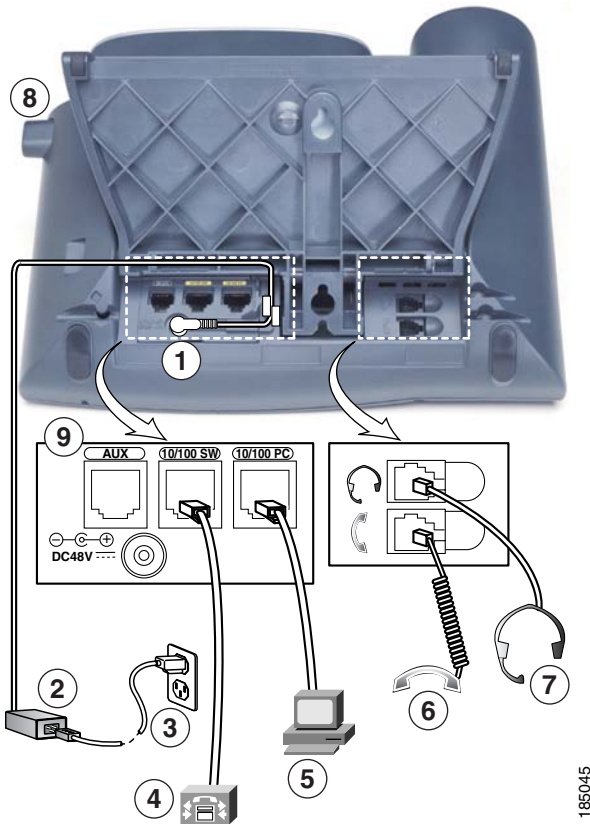

185045

1	DC adaptor port (DC48V)	6	Handset port
2	AC-to-DC power supply	7	Headset port
3	AC power cord	8	Footstand button
4	Network port (10/100/1000 SW)	9	Auxiliary port (AUX)
5	Access port (10/100/1000 PC)		

Removing the Hookswitch Clip (Required)

Before you use your phone, remove the hookswitch clip from the cradle area. With the clip removed, the hookswitch lifts slightly when you pick up the handset.

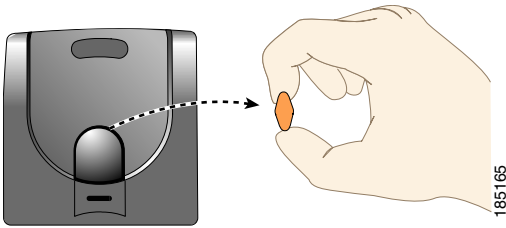

Adjusting the Handset Rest (Optional)

Cisco recommends adjusting the handset rest, particularly when wall-mounting the phones, as this will ensure that the receiver will not readily slip out of the cradle. See the table below for instructions.

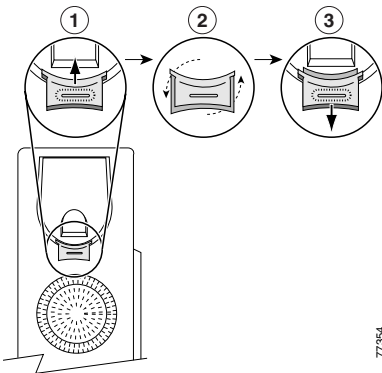

1	Set the handset aside and pull the square plastic tab from the handset rest.
2	Rotate the tab 180 degrees.
3	Slide the tab back into the handset rest. An extension protrudes from the top of the rotated tab. Return the handset to the handset rest.

Adjusting the Footstand (Optional)

To change the angle of the phone base, adjust the footstand while pressing the footstand button.

Registering with TAPS

After your phone is connected to the network, your system administrator might ask you to auto-register your phone using TAPS (Tool for Auto-Registered Phones Support). TAPS might be used either for a new phone or to replace an existing phone.

To register with TAPS, pick up the handset, enter the TAPS extension provided by your system administrator, and follow the voice prompts. You might need to enter your entire extension, including the area code. After your phone displays a confirmation message, hang up. The phone will re-start.

Using a Headset

You can use a wired headset, or you can use a wireless headset in conjunction with the wireless headset remote hookswitch control feature.

Headset Support

Although Cisco Systems performs limited internal testing of third-party headsets for use with the Cisco Unified IP Phones, Cisco does not certify or support products from headset (or handset) vendors.

Cisco recommends the use of good quality external devices, for example, headsets that are screened against unwanted radio frequency (RF) and audio frequency (AF) signals. Depending on the quality of these devices and their proximity to other devices such as mobile phones and two-way radios, some audio noise or echo may still occur. An audible hum or buzz may be heard by either the remote party or by both the remote party and the Cisco Unified IP Phone user. Humming or buzzing sounds can be caused by a range of outside sources: for example, electric lights, electric motors, or large PC monitors. See [Using External Devices, page 3](#), for more information.



Note In some cases, hum may be reduced or eliminated by using a local power cube or power injector.

These environmental and hardware inconsistencies in the locations where Cisco Unified IP Phones are deployed means that there is not a single headset solution that is optimal for all environments.

Cisco recommends that customers test headsets in their intended environment to determine performance before making a purchasing decision and deploying en masse.

Audio Quality Subjective to the User

Beyond the physical, mechanical and technical performance, the audio portion of a headset must sound good to the user and to the party on the far end. Sound quality is subjective and Cisco cannot guarantee the performance of any headsets. However, a variety of headsets from leading headset manufacturers have been reported to perform well with Cisco Unified IP Phones. See manufacturer's sites for details.

For information about wireless headsets that work in conjunction with the wireless headset remote hookswitch control feature, go to the following URL: <http://www.cisco.com/cgi-bin/ctdp/Search.pl>

1. Choose **IP Communications** from the Enter Solution drop-down list box. The Select a Solution Category drop-down list box displays.
2. Choose **IP Phone Headsets** to see a list of Technology Development Program partners.

If you want to search for a particular Technology Development Program partner, enter the partner's name in the Enter Company Name box.

An Overview of Your Phone

Your Cisco Unified IP Phone is a full-feature telephone that provides voice communication over the same data network that your computer uses, allowing you to place and receive phone calls, put calls on hold, transfer calls, make conference calls, and so on.

In addition to basic call-handling features, your Cisco Unified IP Phone can provide enhanced productivity features that extend your call-handling capabilities. Depending on configuration, your phone supports:

- Access to network data, XML applications, and web-based services.
- Online customizing of phone features and services from your Cisco Unified CM User Options web pages.
- A comprehensive online help system that displays information on the phone screen.

Understanding Buttons and Hardware

You can use the graphics below to identify buttons and hardware on your phone.











Cisco Unified IP Phone 7965G















186422

Cisco Unified IP Phone 7945G



	Item	Description	For more information, see...
1	Programmable buttons 	Depending on configuration, programmable buttons provide access to: <ul style="list-style-type: none"> • Phone lines and intercom lines (line buttons) • Speed-dial numbers (speed-dial buttons, including the BLF speed-dial feature) • Web-based services (for example, a Personal Address Book button) • Phone features (for example, a Privacy, Hold, or Transfer button) Buttons illuminate to indicate status: <ul style="list-style-type: none">  Green, steady—Active call or two-way intercom call  Green, flashing—Held call  Amber, steady—Privacy in use, one-way intercom call, DND active, or logged into Hunt Group  Amber, flashing—Incoming call or reverting call  Red, steady—Remote line in use (shared line or BLF status) 	<ul style="list-style-type: none"> • Understanding Phone Screen Features, page 15 • Basic Call Handling, page 20 • Speed Dialing, page 39 • Using a Shared Line, page 42 • Using BLF to Determine a Line State, page 45 • Placing or Receiving Intercom Calls, page 37
2	Footstand button	Allows you to adjust the angle of the phone base.	Adjusting the Handset Rest (Optional), page 5
3	Display button 	Awakens the phone screen from sleep mode. <ul style="list-style-type: none">  No color—Ready for input  Green steady—Sleep mode 	Cleaning and Maintaining the Phone Screen, page 16
4	Messages button 	Auto-dials your voice message service (varies by service).	Accessing Voice Messages, page 63
5	Directories button 	Opens/closes the Directories menu. Use it to access call logs and directories.	Using Call Logs, page 57

6	<p>Help button</p> 	Activates the Help menu.	Accessing the Help System on Your Phone, page 17
7	<p>Settings button</p> 	Opens/closes the Settings menu. Use it to change phone screen and ring settings.	Changing Phone Settings, page 55
8	<p>Services button</p> 	Opens/closes the Services menu.	Using the User Options Web Pages, page 64
9	<p>Volume button</p> 	Controls the handset, headset, and speakerphone volume (off-hook) and the ringer volume (on-hook).	Using a Handset, Headset, and Speakerphone, page 52
10	<p>Speaker button</p> 	Toggles the speakerphone on or off. When the speakerphone is on, the button is lit.	Using a Handset, Headset, and Speakerphone, page 52
11	<p>Mute button</p> 	Toggles the microphone on or off. When the microphone is muted, the button is lit.	Using Mute, page 26
12	<p>Headset button</p> 	Toggles the headset on or off. When the headset is on, the button is lit.	Using a Handset, Headset, and Speakerphone, page 52
13	<p>4-way navigation pad and Select button (center)</p> 	<p>Allows you to scroll through menus and highlight items. Use the Select button to select an item that is highlighted on the screen.</p> <p>Navigation button</p> <ul style="list-style-type: none"> • Scroll up and down to see menus and highlight items. • Scroll right and left to scroll horizontally in multi-column displays. <p>Select button—scroll to highlight a line using the Navigation button, and then:</p> <ul style="list-style-type: none"> • Press  to open a menu. • Press  to play a ringer item. • Press  to access other features as described on the screen. <p>Note The Select button does not take action.</p>	Using Call Logs, page 57
14	<p>Keypad</p>	Allows you to dial phone numbers, enter letters, and choose menu items.	Basic Call Handling, page 20
15	<p>Softkey buttons</p> 	Each activates a softkey option (displayed on your phone screen).	Understanding Phone Screen Features, page 15

16	Handset light strip	Indicates an incoming call or new voice message.	Accessing Voice Messages, page 63
17	Phone screen	Shows phone features.	Understanding Phone Screen Features, page 15









Understanding Lines and Calls









To avoid confusion about lines and calls, refer to these descriptions:

- **Lines**—Each corresponds to a directory number or intercom number that others can use to call you. Each line corresponds to a directory number or intercom number that others can use to call you. The Cisco Unified IP Phone 7965G supports one to six lines and the Cisco Unified IP Phone 7945G supports one to two lines, depending on configuration. To see your phone lines, look at the right side of your phone screen. You have as many lines as you have directory numbers and phone line icons: .
- **Calls**—Each line can support multiple calls. By default, your phone supports four connected calls per line, but your system administrator can adjust this number according to your needs. Only one call can be active at any time; other calls are automatically placed on hold.

Understanding Line and Call Icons

Your phone displays icons to help you determine the line and call state.

Icon	Line or call state	Description
	On-hook line	No call activity on this line.
	Off-hook line	You are dialing a number or an outgoing call is ringing.
	Connected call	You are connected to the other party.
	Ringing call	A call is ringing on one of your lines.
	Call on hold	You have put the call on hold. See Using Hold and Resume, page 25 .
	Remote-in-use	Another phone that shares your line has a connected call. See Using a Shared Line, page 42 .
	Reverting call	A holding call is reverting to your phone. See Using Hold and Resume, page 25 .
	Authenticated call	See Making and Receiving Secure Calls, page 46 .

Icon	Line or call state	Description
	Encrypted call	See Making and Receiving Secure Calls, page 46 .
	BLF- monitored line is idle	See Using BLF to Determine a Line State, page 45 .
	BLF- monitored line is in-use	See Using BLF to Determine a Line State, page 45 .
	BLF- monitored line is ringing (BLF Pickup)	See Using BLF to Determine a Line State, page 45 .
	Line in Do Not Disturb (BLF)	See Using BLF to Determine a Line State, page 45 .
	Idle Intercom line	The intercom line is not in use. See Placing or Receiving Intercom Calls, page 37 .
	One-way intercom call	The intercom line is sending or receiving one-way audio. Placing or Receiving Intercom Calls, page 37 .
	Two-way intercom call	The recipient pressed the intercom line to activate two-way audio with the caller. Placing or Receiving Intercom Calls, page 37 .

Understanding Phone Screen Features

This is what your main phone screen might look like with active calls and several feature menus open.

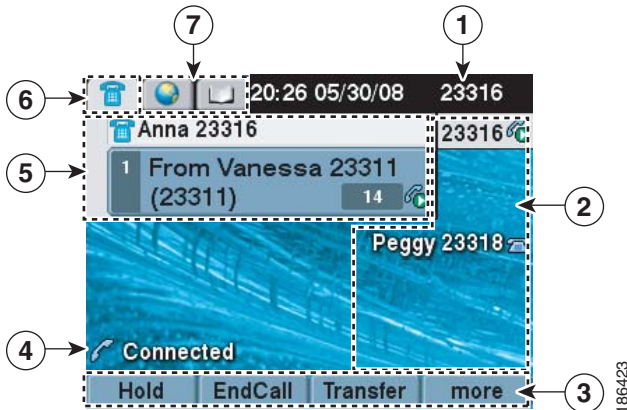

1	Primary phone line	Displays the phone number (directory number) for your primary phone line.
2	Programmable button indicators	Programmable buttons  can serve as phone line buttons, intercom line buttons, speed-dial buttons, phone service buttons or phone feature buttons. Icons and labels indicate how these buttons are configured. For an icon reference, see the “ Phone Screen Icons ” section in the Quick Reference Card at the front of this guide.
3	Softkey labels	Each displays a softkey function.
4	Status line	Displays audio mode icons, status information, and prompts.
5	Call activity area	Displays current calls per line, including caller ID, call duration, and call state for the highlighted line (standard view). See Understanding Line and Call Icons, page 13 , and Viewing Multiple Calls, page 27 .
6	Phone tab	Indicates call activity.
7	Feature tabs	Each indicates an open feature menu. See Understanding Feature Buttons and Menus, page 17 .

Choosing Phone Screen Items

There are two ways to choose items on your phone's screen.

To choose a phone screen item...	Do this...
By item number	Press the corresponding number on your keypad. For example, press 4 to choose the fourth item in a menu.
By scrolling	Use the Navigation button to highlight an item. Press the Select button to select the item, or a softkey to finish the action.

Cleaning and Maintaining the Phone Screen

Use only a soft, dry cloth to wipe the phone screen. Do not use any liquids or powders on the phone, as they can contaminate phone components and cause failures.





Waking the Phone Screen from Sleep Mode

You can wake the phone screen from sleep mode.

If you want to...	Then...
Wake the phone screen from sleep mode	Press any button or lift the handset. After a period of inactivity (determined by your system administrator), the phone screen enters sleep mode to save power. In this mode, the phone screen appears blank and the Display button  remains lit.







Understanding Feature Buttons and Menus

Press a feature button to open or close a feature menu.

If you want to...	Then...
Open or close a feature menu	Press a feature button: <ul style="list-style-type: none">  Messages  Services  Help  Directories  Settings
Scroll through a list or menu	Press the Navigation button.
Go back one level in a feature menu	Press Exit . Pressing Exit from the top level of a menu closes the menu.
Switch between open feature menus	Press a feature button on your phone.

Accessing the Help System on Your Phone

Your phone provides a comprehensive online help system. Help topics appear on the phone screen.























If you want to...	Then...
View the main menu	Press  on your phone and wait a few seconds for the menu to display. Main menu topics include: <ul style="list-style-type: none"> • About Your Cisco Unified IP Phone—Details about your phone • How do I...?—Procedures for common phone tasks • Calling Features—Descriptions and procedures for calling features
Learn about a button or softkey	Press  , then quickly press a button or softkey.
Learn about a menu item	Press  , then quickly press the menu item on the phone screen. Or, press  twice quickly with the menu item highlighted.
Get help using Help	Press  . After a second or two, press  again, or choose Help from the main menu.

Understanding Feature Availability

Depending on your phone system configuration, features included in this Phone Guide might not be available to you or might work differently on your phone. Contact your support desk or system administrator for information about feature operation or availability.

You can access many features either by using a softkey or by pressing a line button. You can configure some features but your system administrator controls most of them.

Here are some details about using softkeys and line buttons to access features:

Feature	Softkey	Line Button Label and Icon
Call Back	CallBack	CallBack 
Call Forward	CFwdALL	Forward All 
Call Park	Park	Park 
Call Pickup	PickUp	PickUp 
Conference	Confrn	Conference 
Conference List	ConfList	Conference List 
Do Not Disturb	DND	Do Not Disturb  or Do Not Disturb 
End Call	EndCall	End Call 
Group Pickup	GPickUp	Group Pickup 
Hold	Hold	Hold 
Hunt Group	HLog	Hunt Group  or Hunt Group 
Malicious Call Identification	MCID	Malicious Call ID 
Meet Me Conferencing	MeetMe	MeetMe 
Mobility	Mobility	Mobility 
New Call	New Call	New Call 
Other Pickup	OPickUp	Other Pickup 
Quality Reporting Tool	QRT	Quality Reporting Tool 
Redial	Redial	Redial 
Remove Last Conference Party	RmLstC	Remove Last Participant 
Transfer	Transfer	Transfer 
Video Mode Command	VidMode	Video 

Understanding SIP vs. SCCP

Your phone can be configured to work with one of two signaling protocols: SIP (Session Initiation Protocol) or SCCP (Skinny Call Control Protocol). Your system administrator determines this configuration.





Phone features can vary depending on the protocol. This Phone Guide indicates which features are protocol-specific. To learn which protocol your phone is using, you can ask your system administrator or you can choose  > **Model Information** > **Call Control Protocol** on your phone.

Basic Call Handling



You can perform basic call-handling tasks using a range of features and services. Feature availability can vary; see your system administrator for more information.

Placing a Call—Basic Options

Here are some easy ways to place a call on your Cisco Unified IP Phone.



If you want to...	Then...	For more information, see...
Place a call using the handset	Pick up the handset and enter a number.	An Overview of Your Phone, page 8
Place a call using the speakerphone	Press  and enter a number.	Using a Handset, Headset, and Speakerphone, page 52
Place a call using a headset	Press  and enter a number. Or, if  is lit, press New Call and enter a number.	Using a Handset, Headset, and Speakerphone, page 52
Redial a number	Press Redial to dial the last number, or press the Navigation button (with the phone idle) to see your Placed Calls .	Using Call Logs, page 57
Place a call while another call is active (using the same line)	<ol style="list-style-type: none">1. Press Hold.2. Press New Call.3. Enter a number.	Using Hold and Resume, page 25
Dial from a call log	<ol style="list-style-type: none">1. Choose  > Missed Calls, Received Calls, or Placed Calls.2. Scroll to the item using the navigation keys, and select the item using the select button.	Using Call Logs, page 57

Tips

- You can dial on-hook, without a dial tone (pre-dial). To pre-dial, enter a number, then go off-hook by lifting the handset or by pressing **Dial**, , or .
- When you pre-dial, your phone tries to anticipate the number you are dialing by displaying matching numbers (if available) from your Placed Calls log. This is called Auto Dial. To call a number displayed with Auto Dial, press the number, or scroll to it and go off-hook.
- If you make a mistake while dialing, press << to erase digits.
- Your phone might be set up for international call logging, which is indicated by a “+” symbol on the call logs, redial, or call directory entries. See your system administrator for more information.

Placing a Call—Additional Options

You can place calls using special features and services that might be available on your phone. See your system administrator for more information about these additional options.







If you want to...	Then...	For more information, see...
Place a call while another call is active (using a different line)	<ol style="list-style-type: none">1. Press  for a new line. The first call is automatically placed on hold.2. Enter a number.	Using Hold and Resume, page 25
Speed dial a number	Do one of the following: <ul style="list-style-type: none">• Press  (a speed-dial button).• Use the Abbreviated Dial feature.• Use the Fast Dial feature.	Speed Dialing, page 39
Dial from a corporate directory on your phone	<ol style="list-style-type: none">1. Choose  > Corporate Directory (name can vary).2. Enter a name and press Search.3. Highlight a listing and go off-hook.	Using Call Logs, page 57
Dial from a corporate directory on your personal computer using Cisco WebDialer	<ol style="list-style-type: none">1. Open a web browser and go to a WebDialer-enabled corporate directory.2. Click the number that you want to dial.	Setting Up Phones and Access Lists for Mobile Connect, page 75

If you want to...	Then...	For more information, see...
Use CallBack to receive notification when a busy or ringing extension is available	<ol style="list-style-type: none"> 1. Press CallBack while listening to the busy tone or ring sound. 2. Hang up. Your phone alerts you when the line is free. 3. Place the call again. 	Your system administrator
See if a line associated with a speed-dial, call record, or directory listing is busy before placing a call to that line	Look for Busy Line Feature indicators.	Using BLF to Determine a Line State, page 45
Make a priority (precedence) call (SCCP phones only)	Enter the MLPP access number, then enter a phone number.	Prioritizing Critical Calls, page 47
Dial from a Personal Address Book (PAB) entry	<ol style="list-style-type: none"> 1. Choose  > Personal Directory to log in. 2. Choose Personal Address Book and search for a listing. 	Using Personal Directory on Your Phone, page 60
Place a call using a billing or tracking code (SCCP phones only)	<ol style="list-style-type: none"> 1. Dial a number. 2. After the tone, enter a client matter code (CMC) or a forced authorization code (FAC). 	Your system administrator
Place a call using your Cisco Extension Mobility profile	Log in to the Cisco Extension Mobility service on a phone.	Using Cisco Extension Mobility, page 49
Make a call from a mobile phone using Mobile Voice Access	<ol style="list-style-type: none"> 1. Dial your assigned Mobile Voice access number. 2. Enter your mobile phone number (if requested) and PIN. 3. Press 1 to make a call to an enterprise IP phone. 4. Dial a desktop phone number other than your desktop phone number. <p>Note Before using Mobile Voice Access to make a call, obtain your Mobile Voice Access number and End user PIN from your system administrator.</p>	Using Cisco Extension Mobility, page 49

If you want to...	Then...	For more information, see...
Place a call using Fast Dial	<p>Note Before using this option, your system administrator must configure this feature and assign a service URL to the line button. Contact your system administrator for more information.</p> <ol style="list-style-type: none"> 1. Press the Fast Dial line button. 2. Scroll to or press the index number to find the entry. 3. Press Dial. 	Configuring Fast Dials on the Web, page 67
Place a call using your PAB	<p>Note Before using this option, your system administrator must configure this feature and assign a service URL to the line button. Contact your system administrator for more information.</p> <ol style="list-style-type: none"> 1. Press the PAB line button. 2. Access the contact and select the number. 3. Press Dial. 	Using Your Personal Address Book on the Web, page 65

Answering a Call

You can answer a call by simply lifting the handset, or you can use other options if they are available on your phone.

If you want to...	Then...	For more information, see...
Answer with a wired headset	<p>Press , if unlit. Or, if  is lit, press Answer or  (flashing).</p> <p>If you are using a wireless headset, refer to the wireless headset documentation.</p>	Using a Handset, Headset, and Speakerphone, page 52
Answer with the speakerphone	Press  , Answer , or  (flashing).	Using a Handset, Headset, and Speakerphone, page 52
Switch from a connected call to answer a new call	Press Answer or, if the call is ringing on a different line, press  (flashing).	Using Hold and Resume, page 25



If you want to...	Then...	For more information, see...
Answer using call waiting	Press Answer .	Using Hold and Resume, page 25
Send a call to a voice message system	Press iDivert .	Sending a Call to a Voice Message System, page 29
Auto-connect calls	Use AutoAnswer .	Using AutoAnswer with a Headset or Speakerphone, page 54
Retrieve a parked call on another phone	Use Call Park or Directed Call Park .	Storing and Retrieving Parked Calls, page 41
Use your phone to answer a call ringing elsewhere	Use Call Pickup .	Picking Up a Redirected Call on Your Phone, page 40
Answer a priority call (SCCP phones only)	Hang up the current call and press Answer .	Prioritizing Critical Calls, page 47
Answer a call on your mobile phone or other remote destination	<p>Set up Mobile Connect and answer your phone.</p> <p>When you enable Mobile Connect:</p> <ul style="list-style-type: none"> • Your desktop and remote destinations receive calls simultaneously. • When you answer the call on your desktop phone, the remote destinations stop ringing, are disconnected, and display a missed call message. • When you answer the call on one remote destination, the other remote destinations stop ringing, are disconnected, and a missed call message is shown on the other remote destinations. 	Using Cisco Extension Mobility, page 49

Tip



If parties on a call hear a beep tone, the call might be monitored or recorded. Ask your system administrator for more information.

Ending a Call

To end a call, hang up. Here are some more details.



If you want to...	Then...
Hang up while using the handset	Return the handset to its cradle. Or press EndCall .
Hang up while using a wired headset	Press  . Or, to keep headset mode active, press EndCall . If you are using a wireless headset, refer to the wireless headset documentation.
Hang up while using the speakerphone	Press  or EndCall .
Hang up one call, but preserve another call on the same line	Press EndCall . If necessary, remove the call from hold first.

Using Hold and Resume



You can hold and resume calls. When you put a call on hold, the Hold icon  appears next to the caller ID and the corresponding line button flashes green .

If the Hold Reversion feature is enabled for your phone, a call that you put on hold reverts back to ringing after a certain period of time. The 'reverting' call remains on hold until you resume it or until Hold Reversion times out.

Your phone indicates the presence of a reverting call by:

- Alerting you at intervals with a single ring (or flash or beep, depending on your phone line setting).
- Briefly displaying a “Hold Reversion” message in the status bar at the bottom of the phone screen.
- Displaying the animated Hold Reversion icon  next to the caller ID for the held call.
- Displaying a flashing amber line button  (depending on the line state).

If you want to...	Then...
Put a call on hold	<ol style="list-style-type: none">1. Make sure the appropriate call is highlighted.2. Press Hold.
Remove a call from hold on the current line	<ol style="list-style-type: none">1. Make sure the appropriate call is highlighted.2. Press Resume.



If you want to...	Then...
Remove a call from hold on a different line	<ol style="list-style-type: none"> 1. Press the appropriate line button:  or  (flashing). Doing so might cause a held call to resume automatically: <ul style="list-style-type: none"> • If there is a reverting call on the line, that call will resume. • If there is more than one reverting call on the line, the oldest reverting call will resume. • If a non-reverting held call is the only call on the line, it will resume. 2. If necessary, scroll to the appropriate call and press Resume.

Tips

- Engaging the Hold feature typically generates music or a beeping tone.
- If you receive an alert for an incoming call and a reverting call at the same time, by default your phone will shift the focus of the phone screen to display the incoming call. Your system administrator can change this focus priority setting.
- If you use a shared line, Hold Reversion rings only on the phone that put the call on hold, not on the other phones that share the line.
- Your system administrator determines the duration between Hold Reversion alerts.



Using Mute

With Mute enabled, you can hear other parties on a call but they cannot hear you. You can use Mute with the handset, speakerphone, or a headset.

If you want to...	Then...
Toggle Microphone on	Press  .
Toggle Microphone off	Press  .

Switching Between Multiple Calls

You can switch between multiple calls on one or more lines. If the call that you want to switch to is not automatically highlighted, scroll to it.

If you want to...	Then...
Switch between connected calls on one line	<ol style="list-style-type: none">1. Make sure the call that you want to switch to is highlighted.2. Press Resume. Any active call is placed on hold and the selected call is resumed.
Switch between connected calls on different lines	Press  for the line that you are switching to. If a single call is holding on the line, the call automatically resumes. If multiple calls are holding, highlight the appropriate call and press Resume .
Switch from a connected call to answer a ringing call	Press Answer , or if the call is ringing on a different line, press  (flashing). Any active call is placed on hold and the selected call is resumed.

Switching an In-Progress Call to Another Phone

You can switch in-progress calls between the desktop phone and your mobile phone or other remote destination.

If you want to...	Then...
Switch an in-progress call on your desktop phone to a mobile phone	<ol style="list-style-type: none">1. Press the Mobility softkey and select Send call to mobile.2. Answer the in-progress call on your mobile phone. The desktop phone line button turns red  and handset icons and the calling party number appear on the phone display. You cannot use same phone line for any other calls, but if your desk phone supports multiple lines, you can use another line to make or receive calls.
Switch an in-progress call from a mobile phone to your desktop phone	<ol style="list-style-type: none">1. Hang up the call on your mobile phone to disconnect the mobile phone, but not the call.2. Press Resume on your desk phone within 4 seconds and start talking on the desk phone.





Viewing Multiple Calls

Understanding how multiple calls are displayed on your phone can help you organize your call-handling efforts.

In standard viewing mode, your phone displays calls as follows for the highlighted line:

- Calls with the highest precedence and longest duration display at the top of the list.
- Calls of a similar type are grouped together. For example, calls that you have interacted with are grouped near the top, and calls on hold are grouped last.

You can use these additional methods to view multiple calls on multiple lines:

If you want to...	Then...
View calls on another line	<ol style="list-style-type: none">1. Press .2. Immediately press the line button .
Switch to call overview mode	<p>Press  for the highlighted line.</p> <p>The phone switches to call overview mode, displaying only one call per line. The displayed call is either the active call or the held call with the longest duration.</p> <p>To return to standard viewing mode, press , then immediately press the line button.</p>

Transferring Calls

Transfer redirects a connected call. The *target* is the number to which you want to transfer the call.

If you want to...	Then...
Transfer a call without talking to the transfer recipient	<ol style="list-style-type: none">1. From an active call, press Transfer.2. Enter the target number.3. Press Transfer again to complete the transfer or EndCall to cancel. <p>Note If your phone has on-hook transfer enabled, complete the transfer by hanging up.</p>
Talk to the transfer recipient before transferring a call (consult transfer)	<ol style="list-style-type: none">1. From an active call, press Transfer.2. Enter the target number.3. Wait for the transfer recipient to answer.4. Press Transfer again to complete the transfer or EndCall to cancel. <p>Note If your phone has on-hook transfer enabled, complete the transfer by hanging up.</p>

If you want to...	Then...
Transfer two current calls to each other (direct transfer) without staying on the line (SCCP phones only)	<ol style="list-style-type: none"> 1. Scroll to highlight any call on the line. 2. Press Select. 3. Repeat this process for the second call. 4. With one of the selected calls highlighted, press DirTrfr. (To display DirTrfr you might need to press more.) <p>The two calls connect to each other and drop you from the call.</p> <p>Note If you want to stay on the line with the callers, use Join instead.</p>
Redirect a call to a voice message system	Press iDivert . For more information, see Sending a Call to a Voice Message System , page 29.

Tips

- If your phone has on-hook transfer enabled, complete the call by hanging up.
- If on-hook transfer is *not* enabled on your phone, hanging up without pressing **Transfer** again places the call on hold.
- You cannot use **Transfer** to redirect a call on hold. Press **Resume** to remove the call from hold before transferring it.

Sending a Call to a Voice Message System

You can use **iDivert** to send an active, ringing, or on-hold call to your voice message system. Depending on the type of call and your phone configuration, you can also use **iDivert** to send the call to another party's voice message system.

- If the call was originally sent to someone else's phone, **iDivert** allows you to redirect the call either to your own voice message system or to the original called party's voice message system. Your system administrator must make this option available to you.
- If the call was sent to you directly (not transferred or forwarded to you), or if your phone does not support the option described above, using **iDivert** redirects the call to your voice message system.

If you want to...	Then...
Send an active, ringing, or on-hold call to a voice message system	<p>Press iDivert. One of two things occurs:</p> <ul style="list-style-type: none"> • The call is transferred to your voice message system. • Your phone screen displays a menu that allows you to choose between your voice message system or the voice message system of the original called party. Choose an option to redirect the call.

Tip

If your phone displays a menu that disappears before you make your selection, you can press **iDivert** again to re-display the menu. You can also ask your system administrator to configure a longer timeout value.

Forwarding Calls to Another Number

You can use the call forwarding features to redirect incoming calls from your phone to another number.

Your system administrator might allow you to choose from two types of call forwarding features:

- Unconditional call forwarding (Call Forward All)—Applies to all calls that you receive.
- Conditional call forwarding (Call Forward No Answer, Call Forward Busy, Call Forward No Coverage)—Applies to certain calls that you receive, according to conditions.

You can access Call Forward All on your phone or from your User Options web pages; conditional call forwarding features are accessible only from your User Options web pages. Your system administrator determines which call forwarding features are available to you.

If you want to...	Then...
Set up Call Forward All on your primary line	Press CFwdALL or Forward All and enter a target phone number.
Cancel Call Forward All on your primary line	Press CFwdALL or Forward All.
Verify that Call Forward All is enabled on your primary line	Look for: <ul style="list-style-type: none">• The call forward icon above your primary phone number.• The call forward target number in the status line.
Set up or cancel call forwarding remotely, or for a non-primary line	<ol style="list-style-type: none">1. Log in to your User Options web pages. (See Accessing Your User Options Web Pages, page 64.)2. Access your call forwarding settings. (See Controlling Line Settings on the Web, page 72.) <p>Note When call forwarding is enabled for any line other than the primary line, your phone does not provide you with confirmation that calls are being forwarded. Instead, you must confirm your settings in the User Options web pages.</p>

Tips

- Enter the call forward target number exactly as you would dial it from your phone. For example, enter an access code or the area code, if necessary.

- You can forward your calls to a traditional analog phone or to another IP phone, although your system administrator might restrict the call forwarding feature to numbers within your company.
- Call forwarding is phone line specific. If a call reaches you on a line where call forwarding is not enabled, the call will ring as usual.
- Your system administrator can enable a call forward override feature that allows the person receiving your forwarded calls to reach you. With override enabled, a call placed from the target phone to your phone is not forwarded, but rings through.
- Your phone may reject your attempt to set up Call Forward All directly on the phone if the target number that you enter would create a call forwarding loop or would exceed the maximum number of links permitted in a call forwarding chain.



Using Do Not Disturb

You can use the Do Not Disturb (DND) feature to turn off only the ringer on your phone or to turn off all audible and visual notifications of incoming calls. Your system administrator enables DND for your phone.

When DND and Call Forward All are both enabled on your phone, calls are forwarded and the caller does not hear a busy tone.

DND interaction with other types of calls includes:

- DND does not affect intercom calls or non-intercom priority calls.
- If both DND and auto-answer are enabled, only intercom calls will be auto-answered.

If you want to...	Then...
Turn on DND	Press Do Not Disturb  or DND. “Do Not Disturb” displays on the phone, the DND  lights, and the ring tone is turned off.

Turn off DND	Press Do Not Disturb  or DND.
Customize DND settings	<p>If your system administrator configured DND settings to appear on the User Options page, follow these steps:</p> <ol style="list-style-type: none"> 1. Log in to your User Options web pages. See Accessing Your User Options Web Pages, page 64. 2. From the drop-down menu, choose User Options > Device. 3. Set the following options: <ul style="list-style-type: none"> - Do Not Disturb—Set to enable/disable DND. - DND Option—Choose either Call Reject (to turn off all audible and visual notifications) or Ringer Off (to turn off only the ringer). - DND Incoming Call Alert (applies to either DND option set)—Set the alert to beep only, flash only, disable the alert, or choose “None” (to use the “Alert” setting configured by your system administrator).

Making Conference Calls

Your Cisco Unified IP Phone allows you to talk simultaneously with multiple parties in a conference call.

Using Conference Features

You can create a conference in various ways, depending on your needs and the features that are available on your phone.

- **Conference**—Allows you to create a standard (ad hoc) conference by calling each participant. Use the **ConfRn** softkey or the **Conference** button. Conference is available on most phones.
- **Join**—Allows you to create a standard (ad hoc) conference by combining existing calls. Use the **Join** softkey or button.
- **cBarge**—Allows you to create a standard (ad hoc) conference by adding yourself to a call on a shared line. Press a line button or use the **cBarge** softkey or button. cBarge is only available on phones that use shared lines.
- **Meet-Me**—Allows you to create or join a conference by calling a conference number. Use the **MeetMe** softkey or button.



Using Conference

Conference allows you to call each participant. Conference is available on most phones.

If you want to...	Then...
Create a conference	<ol style="list-style-type: none">1. From a connected call, press Confrn or Conference. (You may need to press the more softkey to see Confrn.)2. Enter the participant's phone number.3. Wait for the call to connect.4. Press Confrn or Conference again to add the participant to your call.5. Repeat to add additional participants.
Add new participants to an existing conference	Repeat the steps listed above. Your system administrator determines whether non-initiators of a conference can add or remove participants.
See a list of participants or remove participants	See Viewing or Removing Conference Participants, page 36 .

Using Join

Join allows you to combine two or more existing calls to create a conference in which you are a participant.

If you want to...	Then...
Create a conference by joining together existing calls that are on a single phone line	<ol style="list-style-type: none"><li data-bbox="438 316 1213 423">1. From an active call, highlight another call that you want to include in the conference and press Select. Selected calls display this icon .<li data-bbox="438 430 1213 464">2. Repeat this step for each call that you want to add.<li data-bbox="438 470 1213 505">3. Press Join. (You may need to press the more softkey to see Join.)
Create a conference by joining together existing calls that are on multiple phone lines	<ol style="list-style-type: none"><li data-bbox="438 511 1213 578">1. From an active call, press Join. (You may need to press the more softkey to see Join.)<li data-bbox="438 584 1213 829">2. Press the green flashing line button  for the call(s) that you want to include in the conference. One of the following occurs:<ul style="list-style-type: none"><li data-bbox="443 699 1213 734">• The calls are joined.<li data-bbox="443 740 1213 829">• A window opens on your phone screen prompting you to select the call(s) that you want to join. Highlight the call(s) and press Select, then press Join to complete the action. <p data-bbox="438 836 1213 902">Note If your phone does not support Join for calls on multiple lines, transfer the calls to a single line before using Join.</p>
See a list of participants or remove participants	Press ConfList or Conference List . (You may need to press the more softkey first.) See Viewing or Removing Conference Participants, page 36 .

Tips

- If you frequently join more than two parties into a single conference, you might find it useful to first select the calls that you want to join, then press **Join** to complete the action.
- When Join completes, caller ID changes to “Conference.”
- You may be able to combine multiple conference calls by using the **Join** or **DirTrfr** softkeys. Check with your system administrator to see if this feature is available to you.

Using cBarge

You can create a conference by using cBarge to add yourself to a call on a shared line.

If you want to...	Then...
Create a conference by barging a call on a shared line	<p>Press the line button for the shared line.</p> <p>In some cases, you must highlight the call and press cBarge to complete the action.</p> <p>See Using Barge to Add Yourself to a Shared-Line Call, page 43 for more information.</p>
See a list of participants or remove participants	See Viewing or Removing Conference Participants , page 36.

Using Meet-Me

Meet-Me conferencing allows you to start or join a conference by calling the conference number.





If you want to...	Then...
Start a Meet-Me conference	<ol style="list-style-type: none"> 1. Obtain a Meet-Me phone number from your system administrator. 2. Distribute the number to participants. 3. When you are ready to start the meeting, go off-hook to get a dial tone, then press MeetMe. 4. Dial the Meet-Me conference number. <p>Participants can now join the conference by dialing in.</p> <p>Note Participants hear a busy tone if they call the conference before the initiator has joined. In this case, participants must call back.</p>
Join a Meet-Me conference	<p>Dial the Meet-Me conference number (provided by the conference initiator).</p> <p>Note You will hear a busy tone if you call the conference before the initiator has joined. In this case, try your call again.</p>
End a Meet-Me conference	<p>All participants must hang up.</p> <p>The conference does not automatically end when the conference initiator disconnects.</p>

Tip

If you call a secure Meet-Me conference number from a non-secure phone, your phone displays the message, “Device Not Authorized.” For more information, see [Making and Receiving Secure Calls](#), page 46.

Viewing or Removing Conference Participants

During a standard (ad hoc) conference, you can view a list of participants and remove participants.

View a list of conference participants	Press ConfList or Conference List . Participants are listed in the order in which they join the conference with the most recent additions at the top.
Get an updated list of conference participants	While viewing the conference list, press Update .
See who initiated the conference	While viewing the conference list, locate the participant listed at the bottom of the list with an asterisk (*) next to the name.
Remove any conference participant	While viewing the conference list, highlight the participant's name and press Remove .
Drop the last participant added to the conference	While viewing the conference list, press RMLstC or Remove Last Participant .
Verify that a conference call is secure	Look for the  or  icon after "Conference" on the phone screen.
Verify that a participant is calling from a secure phone	Look for the  or  icon beside the participant's name on the phone screen.
Add more participants	See Using Conference, page 33 .

Starting or Joining a Meet-Me Conference Call

Meet-Me conferencing allows you to start or join a conference by calling the conference number.

If you want to...	Then...
Start a Meet-Me conference	<ol style="list-style-type: none">1. Obtain a Meet-Me phone number from your system administrator.2. Distribute the number to participants.3. When you are ready to start the meeting, go off-hook to invoke a dial tone, then press MeetMe.4. Dial the Meet-Me conference number. Participants can now join the conference by dialing in. <p>Note Participants hear a busy tone if they call the conference before the initiator has joined. In this case, participants must call back.</p>

If you want to...	Then...
Join a Meet-Me conference	Dial the Meet-Me conference number (provided by the conference initiator). Note You will hear a busy tone if you call the conference before the initiator has joined. In this case, try your call again.
End a Meet-Me conference	All participants must hang up. The conference does not automatically end when the conference initiator disconnects.

Tip

If you call a secure Meet-Me conference number from a non-secure phone, your phone displays the message, “Device Not Authorized.” For more information, see [Making and Receiving Secure Calls](#), page 46.

Placing or Receiving Intercom Calls

You can make an intercom call to a target phone that auto-answers the call in speakerphone mode with mute activated. The one-way intercom call allows you to deliver a short message to the recipient. If the recipient’s handset or headset is in use, the audio is sent to the device that is use. Any current call activity that your recipient is engaged in continues simultaneously.

The target destination receives an intercom-alert tone and can then choose to:

- Listen to the caller with your microphone muted (you can hear the caller but the caller cannot hear you).
- End the intercom call by pressing the EndCall softkey with the intercom call in focus. Do this if you do not want to hear the message.
- Talk to the caller by pressing the active intercom button, and use either the handset, headset or speaker. The intercom call becomes a two-way connection so that you can converse with the caller.



When using the intercom feature, be aware of the following:

- From an intercom line, you can only dial other intercom lines.
- You can use only one intercom line at a time.
- When your active call is being monitored or recorded, you cannot receive or place intercom calls.
- You cannot place an intercom call on hold.



Note

If you log into your desk phone every day using your Extension Mobility profile, make sure that your system administrator configures your Extension Mobility profile to include the intercom feature.

If you want to...	Then...
Place an intercom call to a preconfigured intercom target	Press  (intercom target line) and, after you hear the intercom-alert tone, begin speaking.
Place an intercom call to any intercom number	Press  (an intercom line). Enter the intercom target number or press a speed-dial number for your target. After you hear the intercom-alert tone, begin speaking.
Receive an intercom call	<p>When you hear the intercom-alert tone, handle the call in one of these ways:</p> <ul style="list-style-type: none"> • Listen to the message in one-way audio. • Speak to the caller by pressing  (the active intercom line). • Press EndCall with the intercom call in focus.

Advanced Call Handling

Advanced call-handling tasks involve special features that your system administrator might configure for your phone depending on your call-handling needs and work environment.

Speed Dialing

Speed dialing allows you to enter an index number, press a button, or select a phone screen item to place a call. Depending on configuration, your phone can support several speed-dial features:

- Speed-dial buttons
- Abbreviated Dialing
- Fast Dials



Note

- To set up speed-dial buttons and Abbreviated Dial, you must access your User Options web pages. See [Accessing Your User Options Web Pages, page 64](#).
- To set up Fast Dials, you must access the Personal Directory feature. See [Using Personal Directory on Your Phone, page 60](#).
- Alternately, your system administrator can configure speed-dial features for you.

If you want to...	Then...
Use speed-dial buttons	<ol style="list-style-type: none">1. Set up speed-dial buttons. See the “Setting Up Speed Dials on the Web” section on page 68.2. To place a call, press  (a speed-dial button). <p>Note If your phone supports the Busy Lamp Field (BLF) speed-dial feature, you can see if the speed-dial number is busy before dialing. See Using BLF to Determine a Line State, page 45.</p>
Use Abbreviated Dial	<ol style="list-style-type: none">1. Set up Abbreviated Dialing codes. See Setting Up Speed Dials on the Web, page 68.2. To place a call, enter the Abbreviated Dialing code and press AbbrDial.
Use Fast Dial	<ol style="list-style-type: none">1. Create a Personal Address Book entry and assign a Fast Dials code. See Using Personal Directory on the Web, page 65.2. To place a call, access the Fast Dial service on your phone. See Using Personal Directory on Your Phone, page 60.

Picking Up a Redirected Call on Your Phone

Call PickUp allows you to answer a call that is ringing on a coworker's phone by redirecting the call to your phone. You might use Call PickUp if you share call-handling tasks with coworkers.

If you want to...	Then...
Answer a call that is ringing on another extension within your call pickup group	<ol style="list-style-type: none">1. Press the PickUp softkey or button. (You might have to go off-hook to display the softkey.) If your phone supports auto-pickup, you are now connected to the call.2. If the call rings, press Answer to connect to the call.
Answer a call that is ringing on another extension outside of your call pickup group	<ol style="list-style-type: none">1. Press the GPickUp softkey or the Group PickUp button. (You might have to go off-hook to display the softkey.)2. Enter the group pickup number. If your phone supports auto-pickup, you are now connected to the call.3. If the call rings, press Answer to connect to the call.
Answer a call that is ringing on another extension in your group or in an associated group	<ol style="list-style-type: none">1. Press the OPickUp softkey or the Other PickUp button. (You might have to go off-hook to display the softkey.) If your phone supports auto-pickup, you are now connected to the call.2. If the call rings, press Answer to connect to the call.
Answer a call that is ringing on a particular extension (line number)	<ol style="list-style-type: none">1. Press the GPickUp softkey or the Group PickUp button. (You might have to go off-hook to display the softkey.)2. Enter the line number with the call that you want to pick up. For example, if the call that you want to pick up is ringing on line 12345, enter 12345. If your phone supports auto-pickup, you are now connected to the call.3. If the call rings, press Answer to connect to the call.

Tips







- If multiple calls are available for pick up, your phone picks up the oldest call first (the call that has been ringing for the longest time).
- If you press **GPickUp** or **Group PickUp** and enter a line number, your phone picks up the ringing call on that particular line (if available).
- If you have multiple lines and want to pick up the call on a non-primary line, first press  for the desired line, then press a Call PickUp softkey or button.

- Depending on how your phone is configured, you might receive an audio and/or visual alert about a call to your pickup group.
- If you use the BLF Pickup feature on your phone, see [Using BLF to Determine a Line State, page 45](#).

Storing and Retrieving Parked Calls

You can park a call when you want to store the call so that you or someone else can retrieve it from another phone in the Cisco Unified Communications Manager system (for example, a phone at a co-worker's desk or in a conference room). You can park a call by using these methods:

- **Call Park**—Use the **Park** softkey to store the call. Your phone displays the call park number where the system stored your call. You must record this number and then use the same number to retrieve the call.
- **Directed Call Park**—Use the **Transfer** softkey to direct the call to an available directed call park number that you dial or speed dial. To retrieve the call from a directed call park number, dial the park retrieval prefix, then dial or speed dial the same directed call park number. You can use a Directed Call Park button to speed-dial the directed call park number and to monitor whether a directed call park number is occupied or available.

If you want to...	Then...
Store an active call using Call Park	<ol style="list-style-type: none"> 1. During a call, press Park. (You may need to press the more softkey to see Park.) 2. Note the call park number displayed on your phone screen. 3. Hang up.
Retrieve a parked call	Enter the call park number from any Cisco Unified IP Phone in your network to connect to the call.
Direct and store an active call at a directed call park number	<ol style="list-style-type: none"> 1. During a call, press Transfer. 2. Press Directed Call Park  with the park-unoccupied icon  to speed dial the directed call park number. A Directed Call Park  (flashing) with park-occupied icon  indicates the directed call park number is not available. 3. Press Transfer again to finish storing the call.
Retrieve a parked call from a directed call park number	From any Cisco Unified IP Phone in your network, enter the park retrieval prefix and dial the directed call park number. Or after entering the park retrieval prefix, press the  (flashing) with  to connect to the call.

Tips

- You have a limited time to retrieve a parked call before it reverts to ringing at the original number. See your system administrator for details.

- Your system administrator can assign Directed Call Park buttons to available line buttons on your Cisco Unified IP Phone 7965G that has a Cisco Unified IP Phone Expansion Module (the Cisco Unified IP Phone 7945G does not support the Cisco Unified IP Phone Expansion Module).
- You can dial directed call park numbers if you do not have Directed Call Park buttons on your phone. However, you will not be able to see the status of the directed call park number.

Logging Out of Hunt Groups

If your organization receives a large number of incoming calls, you might be a member of a hunt group. A hunt group includes a series of directory numbers that share the incoming call load. When the first directory number in the hunt group is busy, the system hunts for the next available directory number in the group and directs the call to that phone.

When you are away from your phone, you can prevent hunt group calls from ringing your phone by logging out of hunt groups.

If you want to...	Then...
Log out of hunt groups to temporarily block hunt group calls	Press HLog or Hunt Group . Your phone screen displays, “Logged out of Hunt Group.”
Log in to receive hunt group calls	Press HLog or Hunt Group . When logged in, the Hunt Group  button is lit.

Tip

Logging out of hunt groups does not prevent non-hunt group calls from ringing your phone.

Using a Shared Line

Your system administrator might ask you to use a shared line if you:

- Have multiple phones and want one phone number
- Share call-handling tasks with coworkers
- Handle calls on behalf of a manager

Understanding Shared Lines

Remote-in-Use Icon

The remote-in-use icon  appears when another phone that shares your line has a connected call. You can place and receive calls as usual on the shared line, even when the remote-in-use icon appears.

Sharing Call Information and Barging

Phones that share a line each display information about calls that are placed and received on the shared line. This information might include caller ID and call duration. (See the [Privacy](#) section for exceptions.)

When call information is visible in this way, you and coworkers who share a line can add yourselves to calls using either **Barge** or **cBarge**. See [Using Barge to Add Yourself to a Shared-Line Call](#), page 43.

Privacy

If you do not want coworkers who share your line to see information about your calls, enable the Privacy feature. Doing so also prevents coworkers from barging your calls. See [Preventing Others from Viewing or Barging a Shared-Line Call](#), page 44.



Note

The maximum number of calls that a shared line supports can vary by phone.

Using Barge to Add Yourself to a Shared-Line Call

You can use barge features (cBarge or Barge) to add yourself to calls on your shared line. (Calls must be non-private calls. See [Using a Shared Line](#), page 42.)

Understanding Barge Features

cBarge and Barge

Depending on how your phone is configured, you can add yourself to a non-private call on a shared line using either cBarge or Barge:

- cBarge converts the call into a standard conference, allowing you to add new participants. (See [Making Conference Calls](#), page 32 for information about standard conferences.)
- Barge allows you to add yourself to the call but does not convert the call into a conference or allow you to add new participants.



Single-button and Multi-touch Barge

Your system administrator determines whether the barge feature on your phone (cBarge or Barge) operates as a single-button or multi-touch feature.

- Single button barge allows you to press a line button to barge a call (if only one call is on the line).
- Multi-touch barge allows you to view call information before barging.

Using Barge Features

The table below describes how to use barge features to add yourself to a call on a shared line.







If you want to...	Then...
See if the shared line is in use	Look for the remote-in-use icon  next to a red line button  .
Add yourself to a call on a shared line	Press the red line button  for the shared line. One of the following occurs: <ul style="list-style-type: none"> You are added to the call. A window opens on your phone screen prompting you to select the call that you want to barge. Press Barge or cBarge to complete the action. (You may need to press the more softkey to display Barge or cBarge.)
View conference participants (if you used cBarge)	See Viewing or Removing Conference Participants, page 36 .

Tips

- When you barge a call, other parties hear a beep tone announcing your presence. With cBarge, other parties hear a brief audio interruption and the phone screen changes to display conference details.
- If a phone that is using the shared line has Privacy enabled, call information and barge softkeys will not appear on the other phones that share the line.
- You will be disconnected from a call that you have joined using Barge if the call is put on hold, transferred, or turned into a conference call.

Preventing Others from Viewing or Barging a Shared-Line Call

If you share a phone line, you can use the Privacy feature to prevent others who share the line from viewing or barging (adding themselves to) your calls.















If you want to...	Then...
Prevent others from viewing or barging calls on a shared line	<ol style="list-style-type: none"> Press Private . To verify that Privacy is on, look for the feature-enabled icon  next to an amber line button .
Allow others to view or barge calls on a shared line	<ol style="list-style-type: none"> Press Private . To verify that Privacy is off, look for the feature-disabled icon  next to an unlit line button .

Tips

- If the phone that shares your line has Privacy enabled, you can make and receive calls using the shared line as usual.
- The Privacy feature applies to all shared lines on your phone. Consequently, if you have multiple shared lines and Privacy is enabled, coworkers cannot view or barge calls on any of your shared lines.

Using BLF to Determine a Line State

Busy Lamp Field features (BLF) allow you to view the state of a phone line that is associated with a speed-dial button, call log, or directory listing on your phone. If you use BLF Pickup, you can answer a ringing call for the line that you are monitoring. Your system administrator determines which BLF features are configured for your phone.

If you want to...	Then...
See the state of a line listed in a call log or directory	<p>Look for one of these indicators next to the line number:</p> <ul style="list-style-type: none">  Line is in-use.  Line is idle.  Line is in Do Not Disturb state.  BLF indicator unavailable for this line.
See the state of a speed-dial line	<p>Look for BLF indicators next to the line number:</p> <ul style="list-style-type: none">  +  —Line is in-use.  +  —Line is idle.  +  —Line is in Do Not Disturb state.  +  (flashing)—Line is ringing (BLF Pickup only).  —BLF indicator unavailable for this line.
Use BLF Pickup to answer a call ringing on a coworker's phone	<p>Press the BLF Pickup button  while the line is ringing.</p> <p>The call is redirected to the next available line on your phone. (If you want to specify a line, first press a line button, then press the BLF button.)</p> <p>If your phone supports auto-pickup, the call connects automatically. Otherwise, the call rings on your phone for you to answer.</p> <p>Note If you press the BLF Pickup button when the monitored line is <i>not</i> ringing, your phone will speed dial the line number.</p>

Tips



- Your phone might play an audible indicator to alert you when a call is ringing on the monitored line (BLF Pickup only).
- BLF Pickup answers the oldest ringing call first (if the line that you are monitoring has more than one ringing call).

Making and Receiving Secure Calls

Depending on how your system administrator has configured your phone system, your phone might support making and receiving secure calls.

Your phone can support these types of calls:

- *Authenticated* call—The identities of all phones participating in the call have been verified.
- *Encrypted* call—The phone is receiving and transmitting encrypted audio (your conversation) within the Cisco IP network. Encrypted calls are also authenticated.
- *Protected* call—The phone is receiving and transmitting encrypted audio (your conversation) with another phone. A protected call provides a similar level of security as an encrypted call, but adds additional security. If the call is protected at both ends, a security tone plays at the beginning of the conversation. Some features, such as conference calling, shared lines, Extension Mobility, and join across lines are not available when protected calling is configured. Protected calls are not authenticated.
- *Non-secure* call—At least one of the participating phones or the connection does not support these security features, or the phones cannot be verified.

If you want to...	Then...
Check the security level of a call or conference	Look for a security icon in the top right corner of the call activity area, next to the call duration timer:  Authenticated call or conference  Encrypted call or conference  Non-secure call or conference

If you want to...	Then...
Verify that the phone on the other end of the connection is also secure	<p>Look for the encrypted lock icon and listen for a security tone at the beginning of the call.</p> <p>When encrypted calling is configured on your phone, the lock icon is displayed. However, the conversation is protected only when the security tone plays at the beginning of a call, indicating that the call is protected on both ends of the call. If your call is connected to a non-protected phone, the secure tone is not played.</p>
Determine if secure calls can be made in your company	Contact your system administrator.



Note There are interactions, restrictions, and limitations that affect how security features work on your phone. For more information, ask your system administrator.

Tracing Suspicious Calls

If you are receiving suspicious or malicious calls, your system administrator can add the Malicious Call Identification (MCID) feature to your phone. This feature enables you to identify an active call as suspicious, which initiates a series of automated tracking and notification messages.

If you want to...	Then...
Notify your system administrator about a suspicious or harassing call	<p>Press MCID or Malicious Call ID.</p> <p>Your phone plays a tone and displays the message, “MCID successful.”</p>





Prioritizing Critical Calls

(SCCP phones only.)

In some specialized environments, such as military or government offices, you might need to make and receive urgent or critical calls. If you have the need for this specialized call handling, your system administrator can add Multilevel Precedence and Preemption (MLPP) to your phone.

Keep these terms in mind:

- *Precedence* indicates the priority associated with a call.
- *Preemption* is the process of ending an existing, lower priority call while accepting a higher priority call that is sent to your phone.



If you...	Then...
Want to choose a priority (precedence) level for an outgoing call	Contact your system administrator for a list of corresponding precedence numbers for calls.
Want to make a priority (precedence) call	Enter the MLPP access number (provided by your system administrator) followed by the phone number.
Hear a special ring (faster than usual) or special call waiting tone	You are receiving a priority (precedence) call. An MLPP icon on your phone screen indicates the priority level of the call.
Want to view priority level of a call	<p>Look for an MLPP icon on your phone screen:</p> <ul style="list-style-type: none">  Priority call  Medium priority (immediate) call  High priority (flash) call  Highest priority (flash override) or Executive Override call <p>Higher priority calls are displayed at the top of your call list. If you do not see an MLPP icon, the priority level of the call is normal (routine).</p>
Hear a continuous tone interrupting your call	You or the other party are receiving a call that must preempt the current call. Hang up immediately to allow the higher priority call to ring through.

Tips

- When you make or receive an MLPP-enabled call, you will hear special ring tones and call waiting tones that differ from the standard tones.
- If you enter an invalid MLPP access number, a verbal announcement will alert you of the error.
- An MLPP-enabled call retains its priority and preemptive status when you:
 - Put the call on hold
 - Transfer the call
 - Add the call to a three-way conference
 - Answer the call using PickUp
- MLPP overrides the Do Not Disturb feature.

Using Cisco Extension Mobility

Cisco Extension Mobility (EM) allows you to temporarily configure a Cisco Unified IP Phone as your own. Once you log in to EM, the phone adopts your user profile, including your phone lines, features, established services, and web-based settings. Your system administrator must configure EM for you.

If you want to...	Then...
Log in to EM	<ol style="list-style-type: none">1. Choose  > EM Service (name can vary).2. Enter your user ID and PIN (provided by your system administrator).3. If prompted, select a device profile.
Log out of EM	<ol style="list-style-type: none">1. Choose  > EM Service (name can vary).2. When prompted to log out, press Yes.

Tips

- EM automatically logs you out after a certain amount of time. Your system administrator establishes this time limit.
- Changes that you make to your EM profile from your User Options web pages take effect immediately if you are logged in to EM on the phone; otherwise, changes take effect the next time you log in.
- Changes that you make to the phone from your User Options web pages take effect immediately if you are logged out of EM; otherwise, changes take effect after you log out.
- Local settings controlled by the phone are not maintained in your EM profile.

Managing Business Calls Using a Single Phone Number

With Mobile Connect and Mobile Voice Access installed, you can use your mobile phone to handle calls associated with your desktop phone number.

If you want to...	Then...
Configure Mobile Connect	Use the User Options web pages to set up remote destinations and create access lists to allow or block calls from specific phone numbers from being passed to the remote destinations. See Setting Up Phones and Access Lists for Mobile Connect , page 75.
Answer a call using your mobile phone	See Answering a Call , page 23.
Switch an in-progress call between your desk phone and mobile phone	See Switching an In-Progress Call to Another Phone , page 27.

If you want to...	Then...
Put a call that has been picked up on your mobile phone on hold	<ol style="list-style-type: none"> 1. Press the <i>Enterprise Hold</i> (name may vary) softkey. The other party is placed on hold. 2. On your mobile phone, press the <i>Resume</i> (name may vary) softkey. See Switching an In-Progress Call to Another Phone, page 27.
Connect to Mobile Voice Access	<ol style="list-style-type: none"> 1. From any phone, dial your assigned Mobile Voice Access number. 2. Enter the number you are calling from, if prompted, and your PIN.
Turn on Mobile Connect from your mobile phone	<ol style="list-style-type: none"> 1. Dial your assigned Mobile Voice Access number. 2. Enter your mobile phone number (if requested) and PIN. 3. Press 2 to activate Mobile Connect. 4. Choose whether to turn on Mobile Connect for all configured phones or just one: <ul style="list-style-type: none"> - All phones—Enter 2. - One phone—Enter 1, then the remote destination you want to add, followed by #.
Make a call from your mobile phone	See Placing a Call—Additional Options, page 21 .
Turn off Mobile Connect from your mobile phone	<ol style="list-style-type: none"> 1. Dial your assigned Mobile Voice Access number. 2. Enter your mobile phone number (if requested) and PIN. 3. Press 3 to disable Mobile Connect. 4. Choose whether to turn off Mobile Connect for all configured phones or just one: <ul style="list-style-type: none"> - All phones—Enter 2. - One phone—Enter 1, then the remote destination you want to add, followed by #.
Turn on or off Mobile Connect access to all your remote destinations from your desk phone	<ol style="list-style-type: none"> 1. Press Mobility to display the current remote destination status (Enabled or Disabled). 2. Press Select to change the status. 3. Press Exit.

Tips

- When calling Mobile Voice Access, you must enter the number you are calling and your PIN if any of the following are true:
 - The number you are calling from is not one of your remote destinations.
 - The number is blocked by you or your carrier (shown as “Unknown Number”).

- The number is not accurately matched in the Cisco Unified Communications Manager database; for example, if your number is 510-666-9999, but it is listed as 666-9999 in the database, or your number is 408-999-6666, but it is entered as 1-408-999-6666 in the database.
- If you incorrectly enter any requested information (such as mobile phone number or PIN) three times in a row, the Mobile Voice Access call disconnects, and you are locked out for a period of time. Contact your system administrator if you need assistance.



Using a Handset, Headset, and Speakerphone

You can use your phone with these audio devices: a handset, headset, or speakerphone.

The phone is *off-hook* when the handset is lifted or another audio device is in use.



The phone is *on-hook* when the handset is in its cradle and other audio devices are not in use.

Using a Handset



If you want to...	Then...
Go off-hook	Lift the handset.
Go on-hook	Replace the handset in the cradle.
Switch to the speakerphone or headset during a call	Press  or  , then hang up the handset.
Adjust the volume level for a call	Press  during a call or after invoking a dial tone. Press Save to preserve the volume level for future calls.

Using a Headset

Your phone supports four- or six-wire headset jacks for wired headsets, and also supports wireless headsets. For information about purchasing headsets, see [Headset Support, page 6](#).

You can use a headset with all of the controls on your phone, including  and .

However, if you use a wireless headset, refer to the wireless headset documentation for information.

If you want to...	Then...
Toggle headset mode on and off	Press  .
Switch to a handset	Lift the handset.
Adjust the volume level for a call	Press  during a call or after invoking a dial tone. Press Save to preserve the volume level for future calls.

If you use AutoAnswer, see [Using AutoAnswer with a Headset or Speakerphone, page 54](#).

Using a Wireless Headset

Refer to the wireless headset documentation for information about using the wireless headset's remote features. Also, check with your system administrator to be sure your phone is enabled to use a wireless headset with the wireless headset remote hookswitch control feature.

Using Wideband with your Headset



If you use a headset that supports wideband, you might experience improved audio sensitivity if you enable the wideband setting on your phone (this setting is disabled by default). To access the setting, choose  > **User Preferences > Audio Preferences > Wideband Headset**.

If the Wideband Headset setting shows as dimmed, then this setting is not user controllable.

Check with your system administrator to be sure your phone system is configured to use wideband. If the system is not configured for wideband, you may not detect any additional audio sensitivity even when using a wideband headset. To learn more about your headset, refer to the headset documentation or ask your system administrator for assistance.



Using a Speakerphone

Many of the actions you can take to dial a number or answer a call will automatically trigger speakerphone mode, assuming that the handset is in its cradle and  is not lit.

If you want to...	Then...
Toggle speakerphone mode on or off	Press  .
Switch to a handset	Lift the handset.
Adjust the volume level for a call	Press  during a call or after invoking a dial tone. Press Save to preserve the volume level for future calls.

Using AutoAnswer with a Headset or Speakerphone

When AutoAnswer is enabled, your phone answers incoming calls automatically after a few rings. Your system administrator configures AutoAnswer to use either the speakerphone or a headset. You might use AutoAnswer if you receive a high volume of incoming calls.

If you...	Then...
Use AutoAnswer with a headset	<p>Keep headset mode active (in other words, keep  illuminated), even when you are not on a call.</p> <p>To keep headset mode active, do the following:</p> <ul style="list-style-type: none">• Press EndCall to hang up.• Press New Call or Dial to place new calls. <p>If your phone is set up to use AutoAnswer in headset mode, calls are automatically answered only if  is illuminated.</p> <p>Otherwise, calls ring normally and you must manually answer them.</p>
Use AutoAnswer with the speakerphone	<p>Keep the handset in the cradle and headset mode inactive ( unlit).</p> <p>Otherwise, calls ring normally and you must manually answer them.</p>

Tip

AutoAnswer is disabled when the Do Not Disturb feature is active.

Changing Phone Settings

You can personalize your Cisco Unified IP Phone by adjusting the ring tone, background image, and other settings.



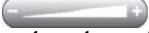

Customizing Rings and Message Indicators

You can customize how your phone indicates an incoming call and a new voice mail message. You can also adjust the ringer volume for your phone.

If you want to...	Then...
Change the ring tone per line	<ol style="list-style-type: none">1. Choose  > User Preferences > Rings.2. Choose a phone line or the default ring setting.3. Choose a ring tone to play a sample of it.4. Press Select and Save to set the ring tone, or press Cancel.
Change the ring pattern per line (flash-only, ring once, beep-only, etc.)	<ol style="list-style-type: none">1. Log in to your User Options web pages. (See Accessing Your User Options Web Pages, page 64.)2. Access your call ring pattern settings. (See Controlling Line Settings on the Web, page 72.) <p>Note Before you can access this setting, your system administrator might need to enable it for you.</p>
Adjust the volume level for the phone ringer	Press  while the handset is in the cradle and the headset and speakerphone buttons are off. The new ringer volume is saved automatically.
Change the way that the voice message light on your handset works	<ol style="list-style-type: none">1. Log in to your User Options web pages. (See Accessing Your User Options Web Pages, page 64.)2. Access your message indicator settings. (See Controlling Line Settings on the Web, page 72.) <p>Note Typically, the default system policy is to indicate a new voice message by displaying a steady light on the handset light strip.</p>

Customizing the Phone Screen

You can adjust the characteristics of the phone screen.







If you want to...	Then...
Change the phone screen brightness	<ol style="list-style-type: none"> 1. Choose  > User Preferences > Brightness. 2. To make adjustments, press Up, Down or . 3. Press Save, or press Cancel.
Change the background image	<ol style="list-style-type: none"> 1. Choose  > User Preferences > Background Images. 2. Scroll through available images and press Select to choose an image. 3. Press Preview to see a larger view of the background image. 4. Press Exit to return to the selection menu. 5. Press Save to accept the new image, or press Cancel.
Change the language on your phone screen	<ol style="list-style-type: none"> 1. Log in to your User Options web pages. (See Accessing Your User Options Web Pages, page 64.) 2. Access your user settings. (See Controlling User Settings on the Web, page 72.)
Change the line text label	<ol style="list-style-type: none"> 1. Log in to your User Options web pages. (See Accessing Your User Options Web Pages, page 64.) 2. Access your line label settings. (See Controlling Line Settings on the Web, page 72.)
Adjust contrast for your Cisco Unified IP Phone Expansion Module	<ol style="list-style-type: none"> 1. Choose  > User Preferences > Contrast. 2. To make adjustments, press Up, Down or . 3. Press Save, or press Cancel. <p>Note The Cisco Unified IP Phone 7945G does not support the Cisco Unified IP Phone Expansion Module.</p>
Turn off illumination of the phone screen	<p>Contact your system administrator to see if this optional feature is available to you. This feature allows you to turn off phone screen illumination for a pre-determined time (as set by your system administrator).</p>



Using Call Logs and Directories

This section describes how you can use call logs and directories. To access both features, use the Directories button .

Using Call Logs

Your phone maintains logs of your missed, placed, and received calls.

If you want to...	Then...
View your call logs	Choose  > Missed Calls, Placed Calls, or Received Calls . Each stores up to 100 records.
Display details for a single call record	<ol style="list-style-type: none"> 1. Choose  > Missed Calls, Placed Calls, or Received Calls. 2. Highlight a call record. 3. Press Details. Doing so displays information such as called number, calling number, time of day, and call duration (for placed and received calls only).
Erase all call records in all logs	Press  , then press Clear .
Erase all call records in a single log	<ol style="list-style-type: none"> 1. Choose  > Missed Calls, Placed Calls, or Received Calls. 2. Highlight a call record. 3. Press Clear. (You may need to press the more softkey to display Clear.)
Erase a single call record	<ol style="list-style-type: none"> 1. Choose  > Missed Calls, Placed Calls, or Received Calls. 2. Highlight a call record. 3. Press Delete.
Dial from a call log (while not on another call)	<ol style="list-style-type: none"> 1. Choose  > Missed Calls, Placed Calls, or Received Calls. 2. Highlight a call record. <p>Note If the Details softkey appears, the call is the primary entry of a multiparty call. See the Tips section below.</p> <ol style="list-style-type: none"> 3. If you need to edit the displayed number, press EditDial followed by << or >>. To delete the number, press EditDial followed by Delete. (You may need to press the more softkey to display Delete.) 4. Go off-hook to place the call.

If you want to...	Then...
Dial from a call log (while connected to another call)	<ol style="list-style-type: none"> 1. Choose  > Missed Calls, Placed Calls, or Received Calls. 2. Highlight a call record. <p>Note If the Details softkey appears, the call is the primary entry of a multiparty call. See the Tips section below.</p> <ol style="list-style-type: none"> 3. If you need to edit the displayed number, press EditDial followed by << or >>. To delete the number, press EditDial followed by Delete. (You may need to press the more softkey to display Delete.) 4. Press Dial. 5. Choose a menu item to handle the original call: <ul style="list-style-type: none"> • Hold—Puts the first call on hold and dials the second. • Transfer—Transfers the first party to the second and drops you from the call. (Press Transfer again after dialing to complete the action.) • Conference—Creates a conference call with all parties, including you. (Confrn or Conference again after dialing to complete the action.) • EndCall—Disconnects the first call and dials the second.
See if the line in the call log is busy before placing a call to that line	Look for Busy Lamp Field indicators. See Using BLF to Determine a Line State, page 45 .
Place a call from a URL entry in a call log (SIP phones only)	<ol style="list-style-type: none"> 1. Choose  > Missed Calls, Placed Calls, or Received Calls. 2. Highlight the URL entry that you want to dial. 3. If you need to edit the entry, press EditDial. 4. The  icon appears to indicate that you can begin editing characters in the URL entry. 5. Press Dial.

Tips

- (SCCP and SIP phones) Your phone might be set up for international call logging, which is indicated by a “+” symbol on the call logs, redial, or call directory entries. See your system administrator for more information.
- (SCCP phones only) To view the complete call record of a multiparty call (for example, of call that has been forwarded or transferred to you), highlight the call record and press **Details**. The Details record shows two entries for each missed or received multiparty call. The entries are listed in reverse chronological order:
 - The first logged entry is the name/number of the last completed call of a multiparty call received on your phone.

- The second logged entry is the name/number of the first completed call of a multiparty call received on your phone.



Directory Dialing

Depending on configuration, your phone can provide corporate and personal directory features:

- Corporate Directory—Corporate contacts that you can access on your phone. Your system administrator sets up and maintains your Corporate Directory.
- Personal Directory—If available, personal contacts and associated speed-dial codes that you can configure and access from your phone and User Options web pages. Personal Directory is comprised of Personal Address Book (PAB) and Fast Dials:
 - PAB is a directory of your personal contacts.
 - Fast Dials allows you to assign codes to PAB entries for quick dialing.

Using Corporate Directory on Your Phone

You can use a corporate directory to place calls to coworkers.

If you want to...	Then...
Dial from a corporate directory (while not on another call)	<ol style="list-style-type: none"> 1. Choose  > Corporate Directory (exact name can vary). 2. User your keypad to enter a full or partial name and press Search. 3. To dial, press the listing, or scroll to the listing and go off-hook.
Dial from a corporate directory (while on another call)	<ol style="list-style-type: none"> 1. Choose  > Corporate Directory (exact name can vary). 2. User your keypad to enter a full or partial name and press Search. 3. Scroll to a listing and press Dial. 4. Choose a menu item to handle the original call: <ul style="list-style-type: none"> • Hold—Puts the first call on hold and dials the second. • Transfer—Transfers the first party to the second and drops you from the call. (Press Transfer again after dialing to complete the action.) • Conference—Creates a conference call with all parties, including you. (Press Confrn or Conference again after dialing to complete the action.) • EndCall—Disconnects the first call and dials the second.
See if the phone line in the directory is busy	Look for Busy Lamp Field (BLF) indicators. See Using BLF to Determine a Line State, page 45 .



Tip

Use the numbers on your keypad to enter characters on your phone screen. Use the Navigation button on your phone to move between input fields.

Using Personal Directory on Your Phone

The Personal Directory feature set contains your Personal Address Book (PAB) and Fast Dials. This section describes how to set up and use Personal Directory on your phone. Alternately, see the [“Using Personal Directory on the Web”](#) section on page 65.

If you want to...	Then...
Access Personal Directory (for PAB and Fast Dial codes)	<ol style="list-style-type: none">1. Choose  > Personal Directory (exact name can vary).2. Enter your Cisco Unified Communications Manager user ID and PIN, then press Submit.
Search for a PAB entry	<ol style="list-style-type: none">1. Access Personal Directory, then choose Personal Address Book.2. Enter search criteria and press Submit.3. You can choose Previous or Next to move through listings.4. Highlight the PAB listing that you want and press Select.
Dial from PAB entry	<ol style="list-style-type: none">1. Search for a listing.2. Highlight the listing and press Select.3. Press Dial. (You may need to press the more softkey to see Dial.)4. Enter the participant's phone number.5. Highlight the number that you want to dial and press OK.6. Press OK again to dial the number.
Delete a PAB entry	<ol style="list-style-type: none">1. Search for a listing.2. Highlight the listing and press Select.3. Press Delete.4. Choose OK to confirm the deletion.
Edit a PAB entry	<ol style="list-style-type: none">1. Search for a listing.2. Highlight the listing and press Edit to modify a name or email address.3. If necessary, choose Phones to modify a phone number.4. Press Update.

If you want to...	Then...
Add a new PAB entry	<ol style="list-style-type: none"> 1. Access Personal Directory, then choose Personal Address Book. 2. Access the Search page by choosing Submit. (You do not need to input search information first.) 3. Press New. 4. Use your phone keypad to enter a name and email information. 5. Choose Phones and use the keypad to enter phone numbers. Be sure to include any necessary access codes such as a 9 or 1. 6. Choose Submit to add the entry to the database.
Assign a Fast Dial code to a PAB entry	<ol style="list-style-type: none"> 1. Search for a PAB entry. 2. Highlight the listing and press Select. 3. Press Fast Dial. 4. Highlight the number that you want to dial and press Select. 5. Highlight the Fast Dial code that you want to assign to the number and press Select.
Add a new Fast Dial code (not using a PAB entry)	<ol style="list-style-type: none"> 1. Choose  > Personal Directory > Personal Fast Dials. 2. Press Fast Dial. 3. Highlight a Fast Dial code that is unassigned and press Select. 4. Press Assign. 5. Enter a phone number. 6. Press Update.
Search for Fast Dial codes	<ol style="list-style-type: none"> 1. Choose  > Personal Directory > Personal Fast Dials. 2. You can choose Previous or Next to move through listings. 3. Highlight the listing that you want and press Select.
Place a call using a Fast Dial code	<ol style="list-style-type: none"> 1. Search for a Fast Dial code. 2. Highlight the listing you want and press Select. 3. Press Dial. 4. Choose OK to complete the action.
Delete a Fast Dial code	<ol style="list-style-type: none"> 1. Search for a Fast Dial code. 2. Highlight the listing you want and press Select. 3. Press Remove.
Log out of Personal Directory	<ol style="list-style-type: none"> 1. Choose  > Personal Directory (exact name can vary). 2. Choose Logout.

Tips



- Your system administrator can provide you the user ID and PIN that you need to log in to Personal Directory.
- Personal Directory automatically logs you out after a certain amount of time. This time limit can vary. Ask your system administrator for more information.
- Use the numbers on your keypad to enter characters on your phone screen. Use the Navigation button on your phone to move between input fields.
- Your phone might be set up for international call logging, which is indicated by a “+” symbol on the call logs, redial, or call directory entries. See your system administrator for more information.

Accessing Voice Messages

To access voice messages, use the Messages button .



Note Your company determines the voice message service that your phone system uses. For the most accurate and detailed information, refer to the documentation that came with your voice message service.

If you want to...	Then...
Set up and personalize your voice message service	Press  and follow the voice instructions. If a menu appears on your phone screen, choose an appropriate menu item.
Check for your new voice messages	Look for: <ul style="list-style-type: none"> • A steady red light on your handset. (This indicator can vary. See Customizing Rings and Message Indicators, page 55.) • A flashing message waiting icon  and text message on your phone screen. <p>Note The red light and message waiting icon display only when you have a voice message on your primary line, even if you receive voice messages on other lines.</p> Listen for: <ul style="list-style-type: none"> • A stutter tone from your handset, headset, or speakerphone when you place a call. <p>Note The stutter tone is line-specific. You hear it only when using the line with the waiting messages.</p>
Listen to your voice messages or access the voice messages menu	Press  . Depending on your voice message service, doing so either auto-dials the message service or provides a menu on your phone screen.
Send a call to a voice message system	Press iDivert . For more information, see the Sending a Call to a Voice Message System, page 29.

Using the User Options Web Pages

Your Cisco Unified IP Phone is a network device that can share information with other network devices in your company, including your personal computer. You can use your computer to log in to your Cisco Unified CM User Options web pages, where you can control features, settings, and services for your Cisco Unified IP Phone. For example, you can set up speed-dial buttons from your User Options web pages.

Accessing Your User Options Web Pages

This section describes how to log in and select a phone device.

If you want to...	Then do this...
Log in to your User Options web pages	<ol style="list-style-type: none">1. Obtain a User Options URL, user ID, and default password from your system administrator.2. Open a web browser on your computer, enter the URL, and log on.3. If prompted to accept security settings, click Yes or Install Certificate. The Cisco Unified Communications Manager User Options main web page displays. From this page you can choose User Options to access User Settings, Directory features, a Personal Address Book, and Fast Dials. Or, to access phone-specific options, select a device (see below).
Select a device after logging in	<ol style="list-style-type: none">1. After you have logged in to your User Options web pages, choose User Options > Device. The Device Configuration page displays.2. If you have multiple devices assigned to you, choose the appropriate device (phone model, Extension Mobility profile, or Remote Destination profile) from the Name drop-down menu. <p>Note Toolbar buttons located at the top of the Device Configuration page are specific to the selected device type.</p>
Select a configuration option after logging in	<ol style="list-style-type: none">1. After you have logged in to your User Options web pages, choose User Options to access User Settings, Directory, Personal Address Book, Fast Dials, and Mobility Settings.2. To return to the Device Configuration page from another page, choose User Options > Device.

Configuring Features and Services on the Web

The topics in this section describe how to configure features and services from your User Options web pages after logging in. See [Accessing Your User Options Web Pages, page 64](#).

Using Personal Directory on the Web

The Personal Directory feature set that you can access on your computer consists of:

- A Personal Address Book (PAB)
- Fast Dials
- Cisco Unified Communications Manager Address Book Synchronizer



Note You can also access PAB and Fast Dials from your phone. See [Using Personal Directory on Your Phone, page 60](#).

Using Your Personal Address Book on the Web

This section describes how to use your PAB from your User Options web pages.

If you want to...	Then do this after you log in...
Add a new PAB entry	<ol style="list-style-type: none">1. Choose User Options > Personal Address Book.2. Click Add New.3. Enter information for the entry.4. Click Save.
Search for a PAB entry	<ol style="list-style-type: none">1. Choose User Options > Personal Address Book.2. Specify search information and click Find.
Edit a PAB entry	<ol style="list-style-type: none">1. Search for a PAB entry.2. Click a name or nickname.3. Edit the entry as needed and click Save.

If you want to...	Then do this after you log in...
Delete a PAB entry	<ol style="list-style-type: none"> 1. Search for a PAB entry. 2. Select one or more entries. 3. Click Delete Selected.
Assign a line button for PAB	<p>Note Before you can assign a line button for PAB, your system administrator must configure the phone to display services. Contact your system administrator for more information.</p> <ol style="list-style-type: none"> 1. Choose User Options > Device. 2. Click Service URL. 3. Choose the Personal Address Book service from the Button drop-down list box. 4. Enter a phone label for the button. 5. Click Save. 6. Click Reset and then click Restart to refresh the phone configuration. <p>You can now press the line button to access PAB codes.</p>

Configuring Fast Dials on the Web

This section describes how to assign Fast Dials from your User Options web pages.

If you want to...	Then do this after you log in...
Assign a line button for Fast Dial	<p>Note Before you can assign a line button for Fast Dial, your system administrator must configure the phone to display services. Contact your system administrator for more information.</p> <ol style="list-style-type: none">1. Choose User Options > Device.2. Click Service URL.3. Choose the Fast Dial service from the Button drop-down list box.4. Enter a phone label for the button.5. Click Save.6. Click Reset and then click Restart to refresh the phone configuration. <p>You can now press the line button to access Fast Dial codes.</p>
Assign a Fast Dial code to a PAB entry	<ol style="list-style-type: none">1. Create a PAB entry. See Using Your Personal Address Book on the Web, page 65.2. Choose User Options > Fast Dials.3. Click Add New.4. Use the Search Options area to find the appropriate PAB entry.5. Click a phone number in the Search Results area.6. Change the Fast Dial code, if desired.7. Click Save.
Assign a Fast Dial code to a phone number (without using a PAB entry)	<ol style="list-style-type: none">1. Choose User Options > Fast Dials.2. Click Add New.3. Change the Fast Dial code, if desired.4. Enter a phone number.5. Click Save.
Search for a Fast Dial entry	<ol style="list-style-type: none">1. Choose User Options > Fast Dials.2. Specify search information and click Find.

If you want to...	Then do this after you log in...
Edit a Fast Dial phone number	<ol style="list-style-type: none"> 1. Choose User Options > Fast Dials. 2. Search for the Fast Dial entry that you want to edit. 3. Click on a component of the entry. 4. Change the phone number. 5. Click Save.
Delete a Fast Dial entry	<ol style="list-style-type: none"> 1. Search for a Fast Dial. 2. Select one or more entries. 3. Click Delete Selected.

Tips

- You can create up to 500 Fast Dial and PAB entries.
- You can create a new Fast Dial entry without using a PAB entry. Such Fast Dial entries are labeled “raw” in the User Options web pages and do not display a configurable text label.

Using the Address Book Synchronization Tool

You can use the Address Book Synchronization Tool (TABSynch) to synchronize your existing Microsoft Windows Address Book (if applicable) with your PAB. Entries from your Microsoft Windows Address Book will then be accessible on your Cisco Unified IP Phone and User Options web pages. Your system administrator can give you access to TABSynch and provide detailed instructions.

Setting Up Speed Dials on the Web

Depending on configuration, your phone can support several speed-dial features:

- Speed-dial buttons
- Abbreviated Dialing
- Fast Dials



Note For help using speed-dial features, see [Speed Dialing, page 39](#).

If you want to...	Then do this after you log in...
Set up speed-dial buttons	<ol style="list-style-type: none">1. Choose User Options > Device.2. Choose a phone from the Name drop-down menu.3. Click Speed Dials.4. Enter a number and label for a speed-dial button (programmable button) on your phone.5. Click Save. <p>Note Your phone uses the ASCII Label field.</p>
Set up Abbreviated Dialing	<ol style="list-style-type: none">1. Choose User Options > Device.2. Choose a phone from the Name drop-down menu.3. Click Speed Dials.4. Enter a number and label for an Abbreviated Dialing code.5. Click Save.
Set up Fast Dials	See Configuring Fast Dials on the Web, page 67 . You can also set up Fast Dials on your phone. See Using Personal Directory on Your Phone, page 60 .









Tip You can set up a speed-dial button for each programmable button on your phone that is not reserved as line button. Alternately, use Abbreviated Dial or Fast Dial.

Setting Up Phone Services on the Web

Phone services can include special phone features, network data, and web-based information (such as stock quotes and movie listings). You must first subscribe to a phone service before accessing it on your phone.

If you want to...	Then do this after you log in...
Subscribe to a service	<ol style="list-style-type: none">1. Choose User Options > Device.2. Choose a phone from the Name drop-down menu.3. Click Phone Services.4. Click Add New.5. Choose a service from the drop-down list and click Next.6. Change the service label and/or enter additional service information, if available (optional).7. Click Save.
Search for services	<ol style="list-style-type: none">1. Select a device.2. Click Phone Services.3. Click Find.
Change or end services	<ol style="list-style-type: none">1. Search for services.2. Select one or more entries.3. Click Delete Selected.
Change a service name	<ol style="list-style-type: none">1. Search for services.2. Click on the service name.3. Change the information and click Save.

If you want to...	Then do this after you log in...
Add a service to an available programmable phone button 	<ol style="list-style-type: none"> 1. Choose User Options > Device. 2. Choose a phone from the Name drop-down menu. 3. Click Service URL. <p>Note If you do not see this option, ask your system administrator to configure a service URL button for your phone.</p> <ol style="list-style-type: none"> 4. Choose a service from the Button Service drop-down list. 5. If you want to rename the service, edit the label fields. <p>Note Your phone uses the ASCII Label field if the phone does not support double-byte character sets.</p> <ol style="list-style-type: none"> 6. Click Save. 7. Click Reset to reset your phone (necessary to see the new button label on your phone).
Access a service on your phone	Select a service using one of the following buttons: Programmable phone button:  () > Services Feature buttons:  Messages  Services  Directories <p>Note The services available for your phone depend on the phone system configuration and the services you subscribed to. Ask your phone system administrator for more information.</p> <p>Note If only one service is configured, the service opens by default. If more than one service is configured, select an option from the menu on the screen.</p>

Controlling User Settings on the Web

User settings include your password, PIN, and language (locale) settings.

If you want to...	Then do this after you log in...
Change your password	<ol style="list-style-type: none">1. Choose User Options > User Settings.2. In the Browser Password area, enter information.3. Click Save.
Change your PIN	<ol style="list-style-type: none">1. Choose User Options > User Settings.2. In the Phone PIN area, enter information.3. Click Save.
Change the language (locale) for your User Options web pages	<ol style="list-style-type: none">1. Choose User Options > User Settings.2. In the User Locale area, choose an item from the Locale drop-down list.3. Click Save.
Change the language (locale) for your phone screen	<ol style="list-style-type: none">1. Choose User Options > User Settings.2. Choose an item from the User Locale drop-down list.3. Click Save.

Tip

Your PIN and password allow you to access different features and services. For example, use your PIN to log in to Cisco Extension Mobility or Personal Directory on your phone. Use your password to log in to your User Options web pages and Cisco WebDialer on your personal computer. For more information, ask your system administrator.

Controlling Line Settings on the Web

Line settings affect a specific phone line (directory number) on your phone. Line settings can include call-forwarding, voice message indicators, ring patterns, and line labels.

You can set up other line settings directly on your phone:

- Set up call forwarding for your primary phone line—see [Forwarding Calls to Another Number, page 30](#).
- Change rings, display, and other phone-model specific settings—see [Changing Phone Settings, page 55](#).

If you want to...	Then do this after you log in...
Set up call forwarding per line	<ol style="list-style-type: none"> 1. Choose User Options > Device. 2. Choose a phone from the Name drop-down menu. 3. Click Line Settings. 4. If you have more than one directory number (line) assigned to your phone, choose a line from the Line drop-down menu. 5. In the Incoming Call Forwarding area, choose call forwarding settings for various conditions. 6. Click Save.
Change the voice message indicator (lamp) setting per line	<ol style="list-style-type: none"> 1. Choose User Options > Device. 2. Choose a phone from the Name drop-down menu. 3. Click Line Settings. 4. If you have more than one directory number (line) assigned to your phone, choose a line from the Line drop-down menu. 5. In the Message Waiting Lamp area, choose from various settings. <p>Note Typically, the default message waiting setting prompts your phone to display a steady red light from the handset light strip to indicate a new voice message.</p> <ol style="list-style-type: none"> 6. Click Save.

If you want to...	Then do this after you log in...
<p>Change the audible voice message indicator setting per line</p>	<ol style="list-style-type: none"> 1. Choose User Options > Device. 2. Choose a phone from the Name drop-down menu. 3. Click Line Settings. 4. If you have more than one directory number (line) assigned to your phone, choose a line from the Line drop-down menu. 5. In the Audible Message Waiting Indicator area, choose from various settings. <p>Note Typically, the default message waiting setting prompts your phone to display a steady red light from the handset light strip to indicate a new voice message.</p> <ol style="list-style-type: none"> 6. Click Save.
<p>Change or create a line text label that appears on your phone screen</p>	<ol style="list-style-type: none"> 1. Choose User Options > Device. 2. Choose a phone from the Name drop-down menu. 3. Click Line Settings. 4. If you have more than one directory number (line) assigned to your phone, choose a line from the Line drop-down menu. 5. In the Line Text Label area, enter a text label. 6. Click Save. <p>Note Your phone uses the ASCII Label field if the phone does not support double-byte character sets.</p>

Setting Up Phones and Access Lists for Mobile Connect

When using Cisco Mobile Connect, you must add your mobile and other phones that you want to use to make and receive calls using the same directory numbers as your desk phone. These phones are called *remote destinations*. You can also define access lists to restrict or allow calls from certain numbers to be sent to your mobile phone.

If you want to...	Then do this after you log in...
Create an access list	<ol style="list-style-type: none">1. Choose User Options > Mobility Settings > Access Lists.2. Click Add New.3. Enter a name to identify the access list and a description (optional).4. Choose whether the access list will allow or block specified calls.5. Click Save.6. Click Add Member to add phone numbers or filters to the list.7. Select an option from the Filter Mask drop-down list box. You can filter a directory number, calls with restricted caller ID (Not Available), or calls with anonymous caller ID (Private).8. If you select a directory number from the Filter Mask drop-down list box, enter a phone number or filter in the DN Mask field. You can use the following wild cards to define a filter:<ul style="list-style-type: none">- X (upper or lower case)—Matches a single digit. For example, 408555123X matches any number between 4085551230 and 4085551239.- !—Matches any number of digits. For example, 408! matches any number starts with 408.- #—Used as a single digit for exact match.9. To add this member to the access list, click Save.10. To save the access list, click Save.

If you want to...	Then do this after you log in...
Add a new remote destination	<ol style="list-style-type: none"> 1. Choose User Options > Mobility Settings > Remote Destinations. 2. Click Add New. 3. Enter the following information: <ul style="list-style-type: none"> – Name—Enter a name for the mobile (or other) phone. – Destination Number—Enter your mobile phone number. 4. Select your remote destination profile from the drop-down list box. Your remote destination profile contains the settings that apply to remote destinations that you create. 5. Select the Mobile Phone check box to allow your remote destination to accept a call sent from your desktop phone. 6. Select the Enable Mobile Connect check box to allow your remote destination to ring simultaneously with your desktop phone. 7. Choose one of the following options in the Ring Schedule area: <ul style="list-style-type: none"> – All the time—Choose this option if you do not want to impose day and time restrictions on ringing the remote destination. – As specified below—Choose this option and select from the following items to set up a ring schedule based on day and time: <ul style="list-style-type: none"> • Select a check box for each day of the week you want to allow calls to ring the remote destination. • For each day, select All Day or select the beginning and ending times from the drop-down lists. • Select the time zone from the drop-down list box. 8. Choose one of the following ringing options: <ul style="list-style-type: none"> – Always ring this destination. – Ring this destination only if the caller is in the allowed access list that you select. – Do not ring this destination if the caller is in the blocked access list that you select. <div style="margin-top: 10px;">  <hr style="border: 0.5px solid black;"/> <p>Note The ring schedule drop-down list boxes include only the access lists that you have created.</p> <hr style="border: 0.5px solid black;"/> </div> <ol style="list-style-type: none"> 9. Click Save.

Using Cisco WebDialer

Cisco WebDialer allows you to make calls on your Cisco Unified IP Phone to directory contacts by clicking items in a web browser. Your system administrator must configure this feature for you.

If you want to...	Then...
Use WebDialer with your User Options directory	<ol style="list-style-type: none"><li data-bbox="383 326 1271 391">1. Log in to your User Options web pages. See Accessing Your User Options Web Pages, page 64.<li data-bbox="383 391 1271 431">2. Choose User Options > Directory and search for a coworker.<li data-bbox="383 431 1271 472">3. Click the number that you want to dial.<li data-bbox="383 472 1271 545">4. If this is your first time using WebDialer, set up preferences and click Submit. (See the last row in this table for details.)<li data-bbox="383 545 1271 659">5. If the Make Call page appears, click Dial. (See the last row in this table to learn how to suppress this page in the future, if desired.) The call is now placed on your phone.<li data-bbox="383 659 1271 708">6. To end a call, click Hangup or hang up from your phone.
Use WebDialer with another online corporate directory (not your User Options directory)	<ol style="list-style-type: none"><li data-bbox="383 708 1271 773">1. Log in to a WebDialer-enabled corporate directory and search for coworkers.<li data-bbox="383 773 1271 813">2. Click the number that you want to dial.<li data-bbox="383 813 1271 854">3. When prompted, enter your user ID and password.<li data-bbox="383 854 1271 927">4. If this is your first time using WebDialer, set up preferences and click Submit. (See the last row in this table for details.)<li data-bbox="383 927 1271 1040">5. If the Make Call page appears, click Dial. (See the last row in this table to learn how to suppress this page in the future, if desired.) The call is now placed on your phone.<li data-bbox="383 1040 1271 1084">6. To end a call, click Hangup or hang up from your phone.

If you want to...	Then...
Log out of WebDialer	Click the logout icon in the Make Call or Hang Up page.
Set up, view, or change WebDialer preferences	<p data-bbox="338 230 661 263">Access the Preferences page.</p> <p data-bbox="338 269 1205 334">The Preferences page appears the first time that you use WebDialer (after you click the number that you want to dial.)</p> <p data-bbox="338 341 1171 406">To return to Preferences in the future, click the preferences icon from the Make Call or Hang Up page.</p> <p data-bbox="338 412 942 444">The Preferences page contains the following options:</p> <ul data-bbox="352 451 1205 917" style="list-style-type: none"> <li data-bbox="352 451 1137 516">• Preferred language—Determines the language used for WebDialer settings and prompts. <li data-bbox="352 522 1205 711">• Use permanent device—Identifies the Cisco Unified IP Phone and directory number (line) that you will use to place WebDialer calls. If you have one phone with a single line, the appropriate phone and line are automatically selected. Otherwise, choose a phone and/or line. Phones are specified by host name. (To display the host name on your phone, choose  > Network Configuration > Host Name.) <li data-bbox="352 717 1205 815">• Use Extension Mobility—If selected, prompts WebDialer to use the Cisco Unified IP Phone that is associated with your Extension Mobility profile (if available). <li data-bbox="352 821 1205 917">• Do not display call confirmation—If selected, prompts WebDialer to suppress the Make Call page. This page appears by default after you click a phone number in a WebDialer-enabled online directory.

Understanding Additional Configuration Options

Your system administrator can configure your phone to use specific button and softkey templates along with special services and features, if appropriate. This table provides an overview of some configuration options that you might want to discuss with your phone system administrator based on your calling needs or work environment.



Note

You can locate Phone Guides and other documents listed in this table on the web:
http://www.cisco.com/en/US/products/hw/phones/ps379/tsd_products_support_series_home.htm

If you...	Then...	For more information...
Need to handle more calls on your phone line	Ask your system administrator to configure your line to support more calls.	Talk to your system administrator or phone support team.
Need more than one phone line	Ask your system administrator to configure one or more additional directory numbers for you.	Talk to your system administrator or phone support team.
Need more speed-dial buttons	<p>First make sure that you are using all of your currently available speed-dial buttons.</p> <p>If you need additional speed-dial buttons, try using Abbreviated Dialing or subscribing to the Fast Dial service.</p> <p>Another option is to attach a Cisco Unified IP Phone Expansion Module to your Cisco Unified IP Phone 7965G.</p>	<p>See:</p> <ul style="list-style-type: none">• Speed Dialing, page 39• <i>Cisco Unified IP Phone Expansion Module 7914 Phone Guide</i>• <i>Cisco Unified IP Phone Expansion Module 7915 Phone Guide</i>• <i>Cisco Unified IP Phone Expansion Module 7916 Phone Guide</i> <p>Note The Cisco Unified IP Phone 7945G does not support the Cisco Unified IP Phone Expansion Module.</p>

If you...	Then...	For more information...
Work with (or work as) an administrative assistant	Consider using: <ul style="list-style-type: none"> • Cisco Unified Communications Manager Assistant • A shared line 	See: <ul style="list-style-type: none"> • Using a Shared Line, page 42 • <i>Cisco Unified Communications Manager Assistant User Guide</i>
Want to use one extension for several phones	Request a shared line. This allows you to use one extension for your desk phone and lab phone, for example.	See Using a Shared Line, page 42.
Share phones or office space with coworkers	Consider using: <ul style="list-style-type: none"> • Call Park to store and retrieve calls without using the transfer feature. • Call Pickup to answer calls ringing on another phone. • A shared line to view or join coworkers' calls. • Cisco Extension Mobility to apply your phone number and user profile to a shared Cisco Unified IP Phone. 	Ask your system administrator about these features and see the: <ul style="list-style-type: none"> • Advanced Call Handling, page 39. • Using a Shared Line, page 42. • Using Cisco Extension Mobility, page 49.
Answer calls frequently or handle calls on someone's behalf	Ask your system administrator to set up the AutoAnswer feature for your phone.	See Using AutoAnswer with a Headset or Speakerphone, page 54.
Need to make video calls (SCCP phones only)	Consider using Cisco Unified Video Advantage, which enables you to make video calls using your Cisco Unified IP Phone, your personal computer, and an external video camera.	Contact your system administrator for additional assistance and see the <i>Cisco Unified Video Advantage Quick Start Guide</i> and <i>User Guide</i> .



If you...	Then...	For more information...
Determine the state of a phone line associated with a speed-dial button, call log, or directory listing on your phone	Ask your administrator to set up the Busy Lamp Field (BLF) feature for your phone.	See Using BLF to Determine a Line State, page 45 .
Want to temporarily apply your phone number and settings to a shared Cisco Unified IP Phone	Ask your system administrator about the Cisco Extension Mobility Service.	See Using Cisco Extension Mobility, page 49 .

Troubleshooting Your Phone

This section provides troubleshooting information for your Cisco Unified IP Phone.

General Troubleshooting





This section provides information to help you troubleshoot general problems with your phone. For more information, see your system administrator.

Symptom	Explanation
You cannot hear a dial tone or complete a call	One or more of the following factors might apply: <ul style="list-style-type: none">You must log into the Extension Mobility service.You must enter a client matter code (CMC) or forced authorization code (FAC) after dialing a number. (SCCP phones only)Your phone has time-of-day restrictions that prevent you from using some features during certain hours of the day.
The Settings button is unresponsive	Your system administrator might have disabled  on your phone.
The phone screen appears blank	The phone screen has gone into sleep mode to save power after a period of inactivity. Wake the phone screen by lifting the handset, or by pressing any button, such as  . See Cleaning and Maintaining the Phone Screen , page 16.
The phone screen does not illuminate under any circumstances	You might have disabled phone screen illumination on your phone. Contact your system administrator to determine if this feature is available to you.
The softkey that you want to use does not appear	One or more of the following factors might apply: <ul style="list-style-type: none">You must press more to reveal additional softkeys.You must change the line state (for example, go off-hook or have a connected call).Your phone is not configured to support the feature associated with that softkey.
Barge fails and results in a fast busy tone	You cannot barge an encrypted call if the phone you are using is not configured for encryption. When your barge attempt fails for this reason, your phone plays a fast busy tone.

Symptom	Explanation
You are disconnected from a call that you joined using Barge	You will be disconnected from a call that you have joined using Barge if the call is put on hold, transferred, or turned into a conference call.
CallBack fails	The other party might have call forwarding enabled.
The phone shows an error message when you attempt to set up Call Forward All	Your phone may reject your attempt to set up Call Forward All directly on the phone if the target number that you enter would create a Call Forward All loop or would exceed the maximum number of links permitted in a Call Forward All chain (also known as a maximum hop count). Ask your system administrator for details.

Viewing Phone Administration Data

Your system administrator might ask you to access administration data on your phone for troubleshooting purposes.

If you are asked to...	Then...
Access network configuration data	Choose  > Network Configuration and select the network configuration item that you want to view.
Access status data	Choose  > Status and select the status item that you want to view.
Access phone model information	Choose  > Model Information .
Access phone call and voice quality information	Choose  > Status > Call Statistics .

Using the Quality Reporting Tool

Your system administrator may temporarily configure your phone with the Quality Reporting Tool (QRT) to troubleshoot performance problems. You can press **QRT** or **Quality Reporting Tool** to submit information to your system administrator. Depending on configuration, use the QRT to:

- Immediately report an audio problem on a current call.
- Select a general problem from a list of categories and choose reason codes.

Cisco One-Year Limited Hardware Warranty Terms

There are special terms applicable to your hardware warranty and various services that you can use during the warranty period. Your formal Warranty Statement, including the warranties and license agreements applicable to Cisco software, is available on Cisco.com at the following URL:

http://www.cisco.com/en/US/docs/general/warranty/English/1Y1DEN__.html

Index

A

Abbreviated Dialing [39](#), [68](#)
access lists
 creating [75](#)
 setting up [75](#)
Address Book Synchronization Tool [68](#)
answering calls [23](#)
ASCII label field support [69](#)
audible message waiting indicator [63](#)
audio, quality of [6](#)
authenticated calls [46](#)
Auto Dial [21](#)
AutoAnswer [54](#)

B

barge
 and privacy [44](#)
 and shared lines [42](#)
 using [43](#)
BLF [45](#)
Busy Lamp Field [45](#)
button [38](#)
buttons, identifying [8](#)

C

call activity area [15](#)
call forwarding
 configuring from web page [72](#)
call logs
 dialing from a URL entry in [58](#)
 erasing [57](#)
 viewing and dialing from [57](#)
call overview mode [27](#)
call park [41](#)
call pickup [40](#)
call waiting [24](#)
CallBack [22](#)
caller ID [15](#)
call-handling
 advanced [39](#)
 basic [20](#)
calls
 answering [23](#)
 barging [43](#)
 blocking [31](#)
 compared to lines [13](#)
 conference features for [32](#)
 ending [25](#)
 forwarding [72](#)
 handling multiple [27](#)
 holding and resuming [25](#)

- icons for [13](#)
- maximum per line [13](#)
- multiple parties on [32](#)
- multiple, switching between [27](#)
- muting [26](#)
- parking [41](#)
- placing [20, 21](#)
- prevent barging of [44](#)
- prioritizing [47](#)
- redirecting while ringing [40](#)
- reporting problems with [83](#)
- secure [46](#)
- storing and retrieving [41](#)
- transferring [28](#)
- using DND [31](#)
- viewing [15, 27](#)

Cisco Extension Mobility [49](#)

Cisco Unified Communications Manager
Address Book Synchronizer [68](#)

Cisco Unified IP Phone

- adjusting height of [6](#)
- connecting [4](#)
- documentation for [2](#)
- feature configuration for [18, 79](#)
- illustration of [8, 9, 10](#)
- online help for [17](#)
- registering [6](#)
- securing handset rest [5](#)
- troubleshooting [82](#)
- web-based services for [64](#)

Cisco Unified IP Phone Expansion Module [79](#)

Cisco Unified IP Phone Expansion Module
7914 [42, 56, 79](#)

Cisco Unified Video Advantage [80](#)

Cisco WebDialer [77](#)

Client Matter Code, see CMC

CMC [22, 82](#)

conference calls

- Meet-Me [35, 36](#)
- removing participants from [36](#)
- security-level for [36](#)
- types of [32](#)
- viewing participants for [36](#)

connected [14](#)

corporate directory

- using from web page [77](#)
- using on phone [57, 59](#)

D

Details softkey, viewing multiparty calls with
[57, 58](#)

device configuration page [64](#)

dialing, options for [20, 21](#)

directories button [11](#)

directory

- corporate [59](#)
- personal [59, 60](#)
- using from web page [77](#)
- using on phone [59](#)

display button [11, 16](#)

DND [31](#)

Do Not Disturb [31](#)

documentation, accessing [2](#)

E

EM [49](#)

- encrypted calls [46](#)
- ending a call, options for [25](#)
- Extension Mobility [49](#)

F

- FAC [22, 82](#)
- Fast Dials
 - configuring from web page [67](#)
 - using on phone [60](#)
- feature buttons
 - directories [11](#)
 - display of [17](#)
 - help [12](#)
 - messages [11](#)
 - services [12](#)
 - settings [12](#)
- feature menus [17](#)
- feature tabs [15](#)
- features, availability of [18, 79](#)
- footstand
 - adjusting [6](#)
 - button for [11](#)
- Forced Authorization Code, see FAC

G

- group call pickup [40](#)

H

- handset
 - light strip [13](#)

- securing in cradle [5](#)
 - using [52](#)
- hanging up, options for [25](#)
- headset
 - answering calls with [23](#)
 - answering calls with wireless [23](#)
 - button for [12](#)
 - hanging up with [25](#)
 - placing calls with [20](#)
 - using [52](#)
- headset performance, general [6](#)
- help button [12, 28](#)
- help, using [17](#)
- hold
 - and switching calls [27](#)
 - and transferring [28](#)
 - mobile connect call [50](#)
 - using [25](#)
- hold reversion indicators, reverting calls [25](#)
- hookswitch clip, removing [5](#)
- Hunt groups, logging out [42](#)

I

- icons
 - for call states [13](#)
 - for lines [13](#)
- idle [14](#)
- installing, Cisco Unified IP Phone [4](#)
- intercom calls [37](#)
- intercom line [14, 38](#)
- international call logging [21, 58, 62](#)

K

keypad [12](#)

L

language (locale) settings [72](#)

line buttons [11](#)

lines

- and call forwarding [72](#)

- and call states [13](#)

- and using BLF [45](#)

- buttons for [11](#)

- description of [13](#)

- icons for [13](#)

- number of calls supported on [13](#), [79](#)

- ring patterns for [72](#)

- ring tones for [55](#)

- shared [42](#)

- switching between [27](#)

- text label for [72](#)

- viewing [15](#)

- voice message indicator setting for [72](#)

logging out of hunt groups [42](#)

M

Malicious Call Identification [47](#)

MCID [47](#)

Meet-Me conferences [35](#), [36](#)

menus, using [17](#)

messages

- indicator for [55](#), [63](#)

- listening to [63](#)

messages button [11](#)

missed calls, records of [57](#)

MLPP, using [47](#)

Mobile Connect [49](#)

mobile connect

- access to remote destinations [50](#)

- configuring [49](#)

- enabling [76](#)

- making call from mobile phone [50](#)

- putting call on hold [50](#)

- setting up access lists [75](#)

- turning off from mobile phone [50](#)

mobile phone

- make call from [50](#)

- turning off mobile connect [50](#)

Mobile Voice Access [49](#)

mobile voice access

- connect to [50](#)

multiparty calls

- identifying in call logs [57](#), [58](#)

- viewing details of [57](#), [58](#)

multiple calls, handling [27](#)

mute button [12](#)

mute, using [26](#)

N

Navigation button [12](#)

network configuration data, locating [82](#)

O

one-way [14](#)

on-hook dialing [21](#)
online help, using [17](#)

P

PAB

- using from web page [65](#)
- using on phone [60](#)

password, changing [72](#)

Personal Address Book, see PAB

Personal Directory

- using from web page [65](#)
- using on phone [60](#)

phone lines

- buttons for [11](#)
- description of [13](#)
- viewing [15](#)

phone screen

- adjusting contrast [56](#)
- changing language [56](#)

phone services

- configuring [65](#)
- see also User Options web pages

phone tab [15](#)

PIN, changing [72](#)

placed calls, records of [57](#)

placing calls, options for [20, 21](#)

pre-dial [21](#)

prioritizing calls [47](#)

privacy

- and shared lines [42](#)
- using [44](#)

programmable buttons

- description of [11](#)

- labels for [15](#)

Q

QRT [83](#)

Quality Reporting Tool [83](#)

R

received calls, records of [57](#)

redial [20](#)

remote destination [49](#)

- creating [76](#)
- ring schedule [76](#)
- turn off access [50](#)

remote-in-use icon for shared lines [42](#)

resume, using [25](#)

ring patterns, changing [72](#)

ring schedule for remote destinations [76](#)

ring tones, changing [55](#)

ringer

- customizing [55](#)
- indicator for [13](#)
- volume for [55](#)

S

safety, warnings [2](#)

screen

- cleaning [16](#)
- features of [15](#)
- illumination setting [56](#)

- sleep mode [16](#)
- secure calls [46](#)
- secure conferences [36](#)
- security, for calls [46](#)
- Select button [12](#)
- services button [12](#)
- services, subscribing to [70](#)
- settings button [12](#)
- settings, customizing [55](#)
- shared lines
 - and remote-in-use icon [42](#)
 - description of [42](#)
 - with barge [43](#)
 - with privacy [44](#)
- sleep mode, waking phone screen from [16](#)
- softkey buttons
 - description of [12](#)
 - labels for [15](#)
- speakerphone
 - answering calls with [23](#)
 - button for [12](#)
 - hanging up with [25](#)
 - placing calls with [20](#)
 - using [52](#)
- speed dial
 - buttons for [11](#)
 - configuring [39](#), [68](#)
 - description of [39](#)
 - labels [15](#), [68](#)
 - using [21](#)
 - using BLF with [39](#)
- status data, locating [82](#)
- status line, viewing [15](#)

- subscriptions, for phone services [70](#)
- suspicious calls, tracing [47](#)
- switching calls [27](#), [49](#)

T

- TABSynch [68](#)
- TAPS [6](#)
- telephony features
 - audible message waiting indicator [63](#)
- Tool for Auto-Registered Phones Support [6](#)
- transferring
 - options for [28](#)
- troubleshooting
 - general [82](#)
 - see also QRT
- two-way [14](#)

U

- URL dialing, from call log [58](#)
- User Options web pages
 - accessing [64](#)
 - configuring features and services with [65](#)
 - subscribing to phone services with [70](#)

V

- voice message indicator
 - changing setting for [72](#)
 - description of [63](#)
- voice message service [63](#)
- volume

for phone ringer [55](#)
volume button [12](#)

W

warnings, safety [2](#)

web-based services

 configuring [64](#)

 see also User Options web pages

WebDialer [77](#)

whisper [14](#)

wideband

 headset [53](#)



Americas Headquarters
Cisco Systems, Inc.
San Jose, CA

Asia Pacific Headquarters
Cisco Systems (USA) Pte. Ltd.
Singapore

Europe Headquarters
Cisco Systems International BV
Amsterdam, The Netherlands

Cisco has more than 200 offices worldwide. Addresses, phone numbers, and fax numbers are listed on the
Cisco Website at www.cisco.com/go/offices.

CCDE, CCENT, Cisco Eos, Cisco Lumin, Cisco Nexus, Cisco StadiumVision, the Cisco logo, DCE, and Welcome to the Human Network are trademarks; Changing the Way We Work, Live, Play, and Learn is a service mark; and Access Registrar, Aironet, AsyncOS, Bringing the Meeting To You, Catalyst, CCDA, CGBP, CCIE, CCIP, GCNA, CCNP, CCSP, CCVP, Cisco, the Cisco Certified Internetwork Expert logo, Cisco IOS, Cisco Press, Cisco Systems, Cisco Systems Capital, the Cisco Systems logo, Cisco Unity, Collaboration Without Limitation, EtherFast, EtherSwitch, Event Center, Fast Step, Follow Me Browsing, FormShare, GigaDrive, HomeLink, Internet Quotient, IOS, iPhone, iQ Expertise, the iQ logo, iQ Net Readiness Scorecard, iQuick Study, IronPort, the IronPort logo, LightStream, Linksys, MediaTone, MeetingPlace, MGX, Networkers, Networking Academy, Network Registrar, PCNow, PIX, PowerPanels, ProConnect, ScriptShare, SenderBase, SMARTnet, Spectrum Expert, StackWise, The Fastest Way to Increase Your Internet Quotient, TransPath, WebEx, and the WebEx logo are registered trademarks of Cisco Systems, Inc. and/or its affiliates in the United States and certain other countries.

All other trademarks mentioned in this document or Website are the property of their respective owners. The use of the word partner does not imply a partnership relationship between Cisco and any other company. (0805R)



The Java logo is a trademark or registered trademark of Sun Microsystems, Inc. in the U.S. or other countries.

© 2008 Cisco Systems, Inc. All rights reserved.

Free Manuals Download Website

<http://myh66.com>

<http://usermanuals.us>

<http://www.somanuals.com>

<http://www.4manuals.cc>

<http://www.manual-lib.com>

<http://www.404manual.com>

<http://www.luxmanual.com>

<http://aubethermostatmanual.com>

Golf course search by state

<http://golfingnear.com>

Email search by domain

<http://emailbydomain.com>

Auto manuals search

<http://auto.somanuals.com>

TV manuals search

<http://tv.somanuals.com>