

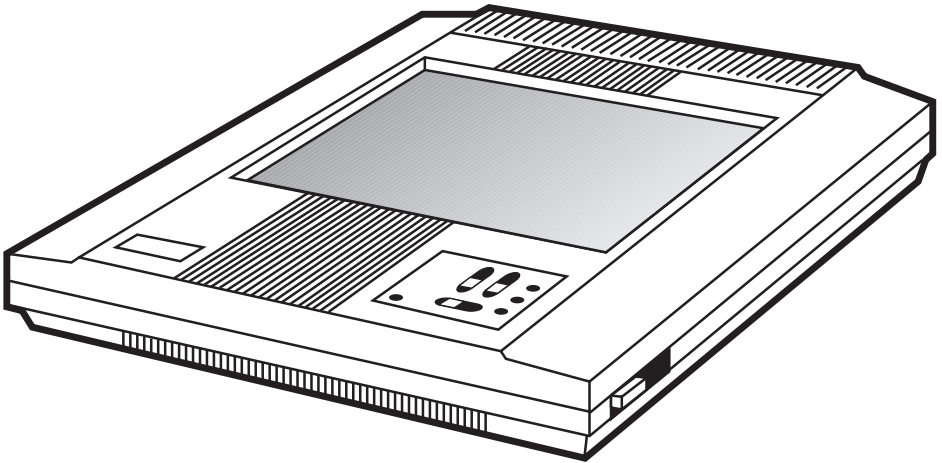

# Real Color 16 LCD Projection Panel Monochrome 16 LCD Projection Panel



---

**CUSTOMER  
SUPPORT  
INFORMATION**

Order **toll-free** in the U.S. 24 hours, 7 A.M. Monday to midnight Friday: **877-877-BBOX**  
FREE technical support, 24 hours a day, 7 days a week: Call **724-746-5500** or fax **724-746-0746**  
Mail order: **Black Box Corporation**, 1000 Park Drive, Lawrence, PA 15055-1018  
Web site: [www.blackbox.com](http://www.blackbox.com) • E-mail: [info@blackbox.com](mailto:info@blackbox.com)

## FEDERAL COMMUNICATIONS COMMISSION RADIO FREQUENCY INTERFERENCE STATEMENT

This equipment generates, uses, and can radiate radio frequency energy and if not installed and used properly, that is, in strict accordance with the manufacturer's instructions, may cause interference to radio communication. It has been tested and found to comply with the limits for a Class A computing device in accordance with the specifications in Subpart J of Part 15 of FCC rules, which are designed to provide reasonable protection against such interference when the equipment is operated in a commercial environment. Operation of this equipment in a residential area is likely to cause interference, in which case the user at his own expense will be required to take whatever measures may be necessary to correct the interference.

Changes or modifications not expressly approved by the party responsible for compliance could void the user's authority to operate the equipment.

*This digital apparatus does not exceed the Class A limits for Radio noise emission from digital apparatus set out in the Radio Interference Regulation of Industry Canada.*

*Le présent appareil numérique n'émet pas de bruits radioélectriques dépassant les limites applicables aux appareils numériques de la classe A/ prescrites dans le Règlement sur le brouillage radioélectrique édicté par Industrie Canada.*

### TRADEMARKS

UL® is a registered trademark of Underwriters Laboratories Incorporated.

Macintosh® and Apple® are registered trademarks of Apple Computer, Inc.

IBM® and PS/2® are registered trademarks of IBM Corporation.

MS-DOS® is a registered trademark of Microsoft Corporation.

Compaq® is a registered trademark of Compaq Computer Corporation.

Dell® is a registered trademark of Dell Corporation.

Epson® is a registered trademark of Seiko Epson Corporation.

Sharp® is a registered trademark of Sharp Corporation.

Toshiba® is a registered trademark of Toshiba Corporation.

Zenith® is a registered trademark of Zenith Electronics Corporation.

*Any other trademarks mentioned in this manual are acknowledged to be the property of the trademark owners.*

# Contents

<b>Chapter</b>	<b>Page</b>
1. Specifications.....	4
2. Introduction .....	5
2.1 Description .....	5
2.2 Shipping Container Contents .....	6
2.3 General Guidelines .....	7
3. Installation.....	8
3.1 Setup Instructions .....	8
3.2 Connecting the Projection Panel to a Desktop Computer .....	12
3.3 Connecting the Projection Panel to an IBM PC Compatible Laptop Computer .....	13
3.4 Connecting the Projection Panel to a Macintosh Series Computer .....	14
4. Operation .....	15
4.1 Adjusting the Projection Panel .....	15
4.2 Non-Shift Control Button Functions .....	17
4.3 Shift-Activated Control Button Functions .....	19
4.4 Using the Control Buttons to Make Adjustments .....	22
4.5 User Menu.....	23
4.6 Moving Through the User Menu.....	24
4.7 Adjusting a Menu Option .....	24
5. Maintenance and Troubleshooting .....	28
5.1 Cleaning the Display Surface .....	28
5.2 Cleaning the Projection Panel Filter .....	28
5.3 Troubleshooting Guide .....	29
Appendix A: Working With Colors (AC400A only) .....	32
Appendix B: Interface Requirements .....	33
B.1 Power Connector Polarity .....	34
B.2 Screen Area.....	34
Appendix C: Special Guidelines for IBM and Compatibles .....	36
C.1 IBM Computers with Two Display Cards .....	36
C.2 Instructions for Activating Portables and Laptops .....	37

# 1. Specifications

**Resolution** — 640 x 480

**Power** — UL® approved 12 VDC,  
1.5A power supply

**Size** — 15.3"H x 13.1"W x 2.6"D  
(38.9 x 33.3 x 6.6 cm)

**Weight** — 5.9 lb. (2.7 kg)

## 2. Introduction

### 2.1 Description

For remarkably impressive presentations, use the Real Color or Monochrome 16 LCD Projection Panel. The Panel, which projects 16 real colors or 16 shades of grey, delivers the computer compatibility and ease of use you never thought possible in an LCD projection panel. Fig. 2-1 illustrates the Panel coupled with an overhead projector.

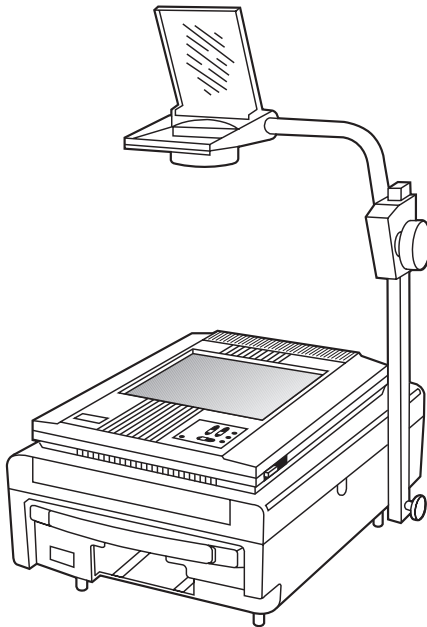

**Fig. 2-1. The Projection Panel on an Overhead Projector.**

The Projection Panel is easy to use. Simply connect the Panel to a computer graphics card and place the unit onto an ordinary overhead projector. The data and graphics normally displayed on the computer monitor will be projected in images that you can easily see in typical room lighting. The Projection Panel has a temperature-regulating fan, which works with the heat-producing overhead projector, to hold the liquid crystal display (LCD) to the optimum temperature. You can use the Projection Panel on a wide range of overhead projectors rated up to 650 watts.

The Projection Panel, with a 640x480 pixel display, is compatible with the Macintosh® series and Macintosh II series; with Apple® IIGS RGB; with IBM® PC and compatibles in CGA, EGA, and VGA modes, and with the IBM PS/2® with VGA or CGA.

### 2.2 Shipping Container Contents

The components shown in Fig. 2-2 are included with the Projection Panel.

1. Projection Panel
2. This User Manual
3. 12-volt power supply
- 4, 6. 15-pin Mac II, LC, Apple IIgs
5. 15-pin VGA

If any pieces are missing when you first open the box, contact Black Box immediately.

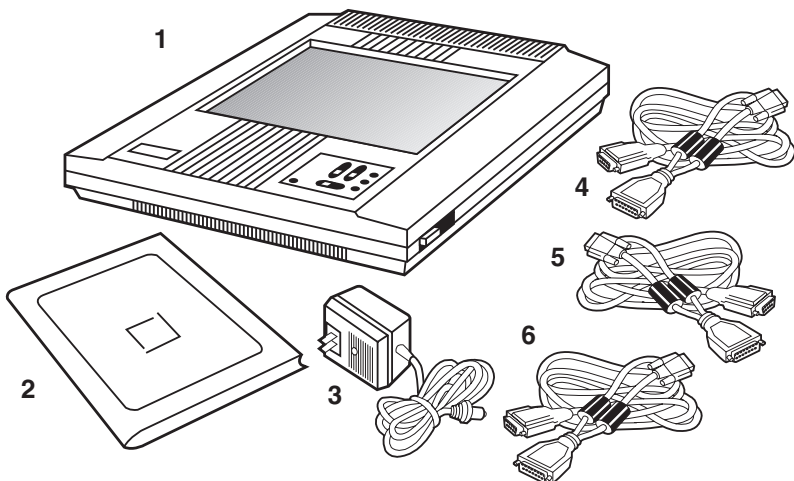

Fig. 2-2. The Projection Panel and Included Components.

## 2.3 General Guidelines

Follow these guidelines when you use the Projection Panel.

- Be sure the Projection Panel is on whenever the overhead projector is turned on.

### CAUTION

**If the Projection Panel is not on when it is on top of an operating overhead projector, the Panel could sustain damage.**

- Do not use the Projection Panel for extended periods of time on an overhead projector known for discoloring or melting standard transparencies.
- When you use the Panel with a high-wattage projector or if you notice extreme discoloration of the Panel, periodically remove the Panel from the overhead projector to allow it to cool.
- The bottom of the Panel can become very hot to the touch after use. Be careful to let the Panel cool before lifting it.
- Do not block the Projection Panel fan or free air movement under and around the Panel. Air flows from back to front.
- Turn the overhead projector off and unplug the Projection Panel when not in use.
- Handle the Projection Panel as you would anything made of glass. Be especially careful not to drop it.
- You can easily clean the Projection Panel with standard non-abrasive glass cleaner. Apply the cleaner to the cleaning cloth and then wipe the glass surface lightly. Do not use excessive amounts of liquid or pressure on the top or bottom optical panels.
- Avoid scratching the Projection Panel surface with sharp metal objects. The top surface is made of glass or a scratch-resistant hardened polymer. If you need to clean the surface, use normal glass-cleaner solution. Do not use abrasive cleaners, solvents, or other harsh chemicals.
- Avoid leaving the Projection Panel in direct sunlight or extreme cold for extended periods of time.



## 3. Installation

### 3.1 Setup Instructions

This chapter explains the connections you must make between the three pieces of equipment you will be using—the Projection Panel, your computer, and monitor. Be sure to follow the instructions for your type of computer.

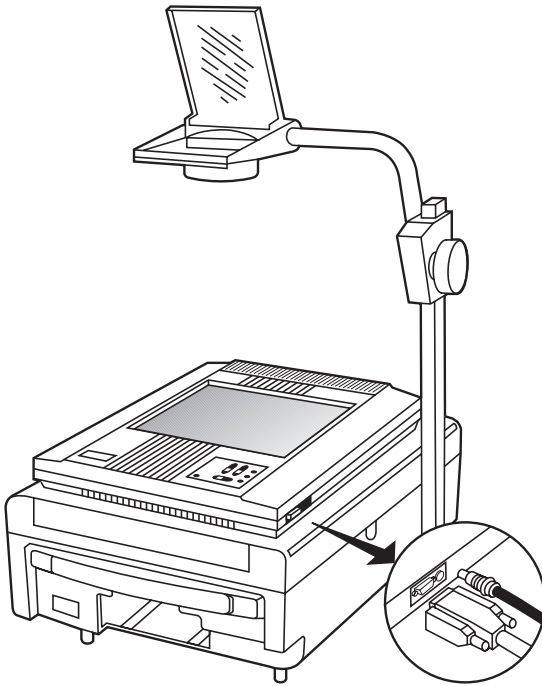

**Fig. 3-1. Projection Panel and Overhead Projector, Showing Cable Connections.**

### 3.1.1 CABLES

Three cables are supplied with the Projection Panel:

1. A Macintosh II/Macintosh LC/Apple IIGS loop-through cable
2. A VGA/MCGA loop-through cable
3. A loop-through cable for EGA, CGA, or Macintosh video

The cables that come with your Projection Panel are used to connect the computer's video port to the Projection Panel and the monitor. Each of the three cables has a 26-pin connector for the Projection Panel, a connector matching the video card and a connector for the monitor.

The Projection Panel receives the computer's signals, amplifies the signals, and sends them out to the monitor.

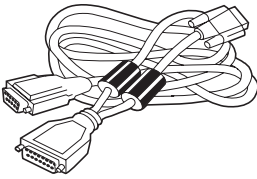

15-pin MacII

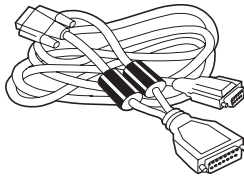

15-pin VGA

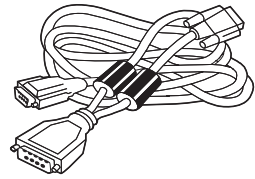

9-pin VGA

**Fig. 3-2. Cables.**

### 3.1.2 CONNECTING THE PROJECTION PANEL TO YOUR COMPUTER

You are going to make either two or three connections. You will connect the computer's graphics card to the Projection Panel, the Projection Panel to the wall outlet with the power supply, and, optionally, the Projection Panel to the computer's monitor.



The steps you need to follow are given in **Section 3.1.3**. Illustrations on the pages following the steps show the cable connections for your configuration.

### 3.1.3 SETTING UP THE PROJECTION PANEL FOR PROJECTION

To set up the Projection Panel for projection, follow these steps:

1. Set up your overhead projector and plug it into the wall outlet. Turn it on to be sure it is working properly and position it so it projects onto the screen.
2. Place the Projection Panel on the overhead projector so the connectors and controls are on the right side of the projector as you face the front of the projector.
3. Connect power to the Projection Panel, but do not connect a video signal yet. This will bring up a test pattern.

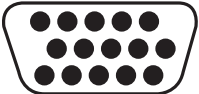
Move the Projection Panel on the projector until the lines are solid rather than rainbows. Adjust the tint for the best color saturation or the contrast for the best greyscale.

Computer	Cable	Looks like
IBM or compatible with VGA Graphics Card or IBM PS/2 with built-in VGA or MCGA Graphics	15-pin	
IBM or Compatible with EGA or CGA Graphics Card or Classic Style Macintosh	9-pin	
Macintosh II Series or Macintosh LC, Apple IIGS	15-pin	

**Fig. 3-3. Selecting the Proper “Y” Cable for Your Computer.**

Refer to **Appendix A** for additional important information on how to properly place a Projection Panel on an overhead projector.

- Follow the instructions in this table to select the proper “Y” cable for your computer:5. Connect the 26-pin end (marked LCD) of the “Y” cable to the Projection Panel.

**NOTE**

**Skip step 6 if you are connecting to a classic-style Macintosh.**

- Unplug the computer monitor cable from the graphics card. Plug the monitor to the short end (marked Monitor) of the Projection Panel cable to the computer monitor.
- Plug the long end of the Projection Panel cable (marked for the appropriate computer) to the computer’s video port.
- Tighten the thumb screws on the cable connectors to ensure proper grounding.

## 3.2 Connecting the Projection Panel to a Desktop Computer

Figure 3-4 shows how to connect the Projection Panel to typical desktop computers, which include CGA, EGA, VGA, Macintosh II, and Macintosh LC setups.

All cables are labeled (for example, LCD, Monitor, VGA, etc.) to indicate where they connect.

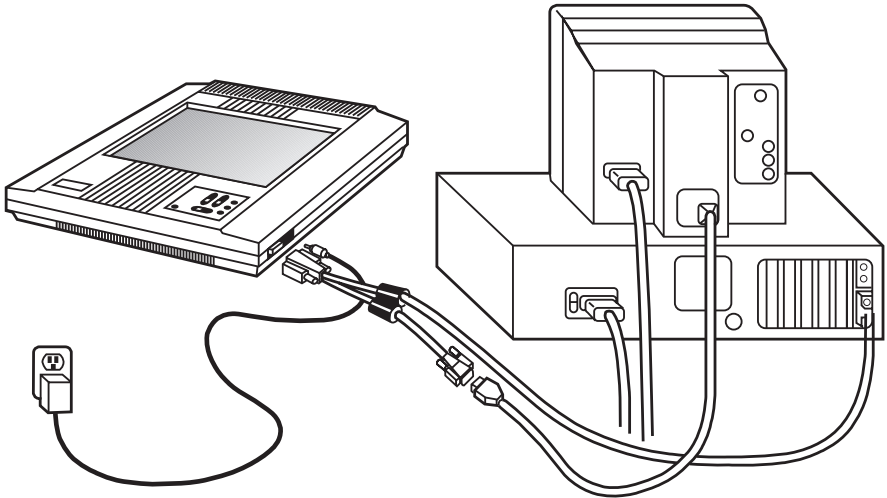
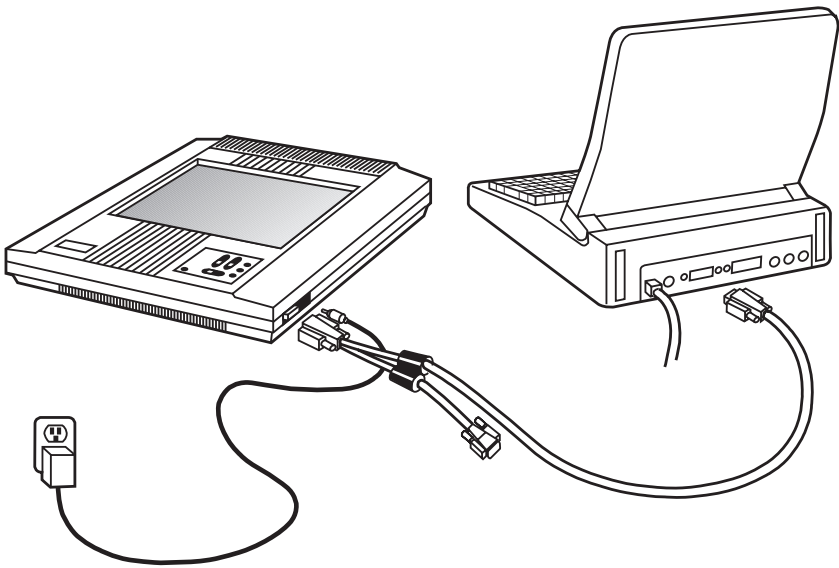

Fig. 3-4. Desktop Computer with a Y-Cable.

### 3.3 Connecting the Projection Panel to an IBM PC Compatible Laptop Computer

Figure 3-5 shows a typical laptop installation.



**Fig. 3-5. Typical Laptop Installation.**

When the external port is activated, many laptop computers automatically turn off their internal display. For more information, see **Appendix C** or your computer manual for typical laptop commands. The short end of the loop-through cable is not connected in this installation.

#### **CAUTION**

**The Projection Panel is not compatible with the Macintosh laptop. Do not attempt to connect the Projection Panel to a Macintosh laptop. Serious damage to the computer or Projection Panel could result.**

## 3.4 Connecting the Projection Panel to a Macintosh Series Computer

Figure 3-6 shows how to connect the Projection Panel to a Macintosh series computer.

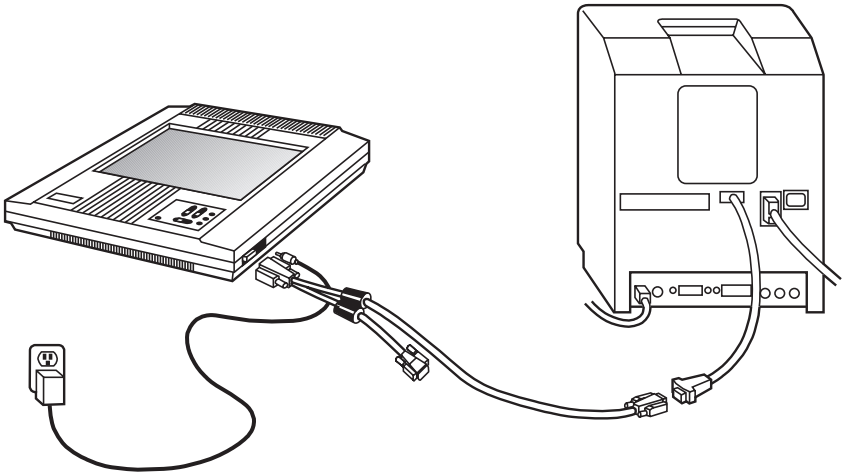

**Fig. 3-6. Macintosh Series Computer.**

Because classic-style Macintosh computers do not have a video connector, you must install an internal adapter. The Macintosh 128, 512, and Plus require an A10 adapter. The SE and SE/30 require an A20. The Macintosh Classic requires an A21. Call your dealer for more information. Note that the short end of the loop-through cable is not connected in this installation.

### NOTE

Because the SE and Plus models of the Macintosh computer only display in monochrome at a resolution of 512x342 pixels, a Real Color 16 LCD Projection Panel connected to one of these models will only project monochrome and will not fill the entire Projection Panel screen.

## 4. Operation

### 4.1 Adjusting the Projection Panel

At this point, bring up the software you want to project. You should be projecting an image on the screen. This section will show you how to adjust the Projection Panel to get clear, crisp images. You can adjust the Projection Panel using the 10-function keypad.

#### 4.1.1 CONTROL BUTTON FUNCTIONS

There are ten operating control buttons on the Projection Panel. A SHIFT button, located in the lower left corner, allows several of these buttons to have a dual function (non-shift functions are printed in gray, shift functions are in blue). Six of the buttons are combined as dual-action switches.

Some of the buttons are auto-repeat buttons; that is, pressing and holding these buttons causes them to constantly send instructions. Other buttons toggle through a fixed number of settings and require you to press the button each time to trigger the next setting.



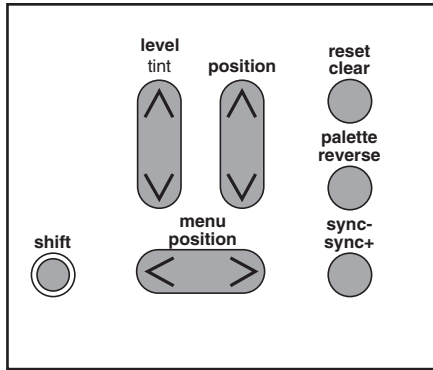

**Fig. 4-1. Projection Panel Keypad.**

**Table 4-1. Non-Shift and Shift Keys.**

<b>NON-SHIFT KEYS</b>	<b>SHIFT KEYS</b>
Tint (up/down) Contrast (up/down) Sync+ Position (up/down) Position (left/right) Clear Reverse	Level (up/down)  Sync-  Menu (toggle) Reset Palette

## 4.2 Non-Shift Control Buttons

To activate one of the non-shift buttons (printed in grey) on the operating control panel, just press the button.

### 4.2.1 TINT (TRUE COLOR)

Press the **Tint** key to adjust the color. The **Tint Up** key adds red and green to the image. Blue levels are affected by a mix of red and green.



Fig. 4-2. Tint (True Color).

### 4.2. CONTRAST (MONOICHROME)

The **Contrast** key allows the user to adjust the brightness of the displayed image for optimum viewing. **Contrast Up** increases the perceived brightness of all shades equally, while **Contrast Down** decreases the brightness of all shades equally. There are 64 contrast levels available.

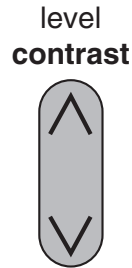

Fig. 4-3. Contrast (Monochrome).

### 4.2.3 SYNC+

The Projection Panel has been calibrated to automatically match signals sent by specific computer systems (CGA, EGA, VGA, PS/2, and Macintosh series). However, each individual video card varies slightly from others.

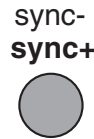

Fig. 4-4. Sync+.

Projected characters or graphics may appear to shimmer because of differences in signal outputs of some computers. Press the **Sync+** button until projected characters “lock” into position and shimmering is eliminated.

Each time **Sync+** is pushed, it fine-tunes the Projection Panel to match signals from the graphics system. **Sync+** continuously cycles forward through all 16 positions (press **sync-** to cycle back to a good sync position).

#### 4.2.4 POSITION, UP OR DOWN

Press the up or down **position** button to center the image vertically on the screen. This button auto-repeats.

**position**



**Fig. 4-5. Position, Up or Down.**

#### 4.2.5 POSITION, LEFT OR RIGHT

Press the up or down **position** button to center the image horizontally on the screen. This button auto-repeats.

**menu  
position**



**Fig. 4-6. Position, Left or Right.**

#### 4.2.6 CLEAR

Pressing the **Clear** button cleans any unwanted random patterns that may have appeared on the screen outside the image area. In some cases, positioning the image will leave a trail of data. Use the **Clear** button to remove this unwanted data.

You may also use this control to blank the screen by clearing the test pattern to all black or all yellow. Disconnect the video signal to bring up the test pattern and press **Clear**. Background color depends on the state of **Reverse**. Pressing **Clear** again will restore the screen.

reset  
clear



Fig. 4-7. Clear.

#### 4.2. REVERSE

If you wish to reverse the way you see an image, light letters on a dark background or dark letters on a light background, press the **Reverse** button. Pressing it again causes the display to return to the original image. All colors will be switched with their complements.

See **Appendix A** for more information on working with colors.

palette  
reverse



Fig. 4-8. Reverse.

#### 4.3 Shift-Activated Control Button Functions

The functions shown on the operating control panel in blue letters are activated when the **Shift** button is held down while a command button is pushed.

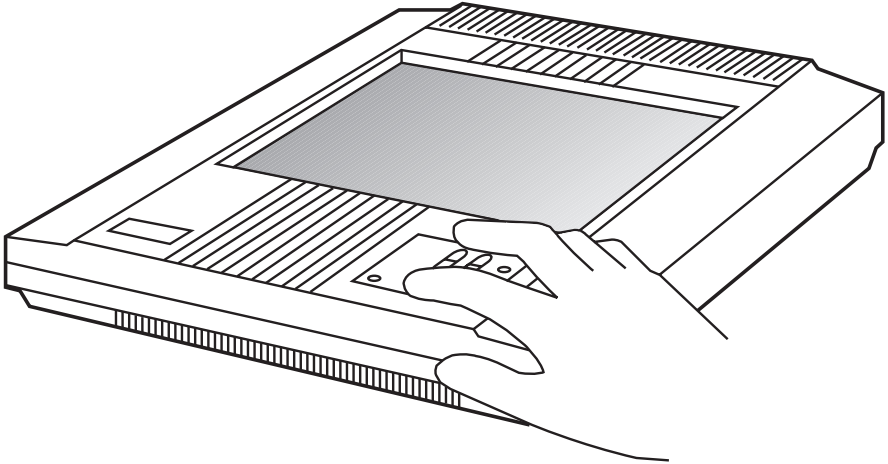

**Fig. 4-9. Holding Down Shift and Pushing a Command Button.**

**4.3.1 SYNC-**

Each time **Sync-** is pushed, it fine tunes the Projection Panel to match signals from the graphics system. **Sync-** continuously cycles backward through all 16 positions.

**4.3.2 RESET**

The master reset function, holding down the **Shift** button and pressing **Reset**, returns the display settings (Position, Sync, Palette, Reverse, and Level) for the video mode being displayed to factory defaults.

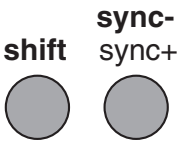

The Reset function does not affect Tracking, Text Mode, Text Slice, Tint, Contrast, or EGA mode unless the menu is showing on the screen. If the menu is displayed, all display settings and menu items, including the color bars, are reset to factory-default values.

**Fig. 4-10. Sync-.**

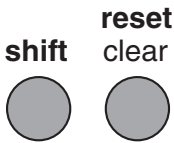

**Fig. 4-11. Reset.**

#### 4.3.3 PALETTE

Pressing the **Palette** button selects the displayed color palette size. This button allows you to switch between 8-color and 16-color displays on the Real Color Panel and select one of seven, color-to-greyscale mappings on the Monochrome panel.

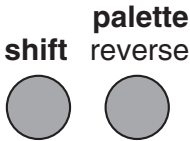

**Fig. 4-12. Palette.**

#### 4.3.4 LEVEL UP AND LEVEL DOWN

The **Level** button adjusts the color mapping to compensate for computer-to-computer differences. Just as colors look different on different monitors, there will always be some color differences between the monitor and the Projection Panel. If the color match between the monitor and the Projection Panel is not satisfactory, the level can be adjusted to change the mapping. It is important, however, to ensure that the **Tint** or **Contrast** is set correctly prior to adjusting the level.

**Level Up** or **Level Down** increases your flexibility by allowing you to choose which tones of color/greyscale will be projected.

Pressing **Level Up** increases the limits of the range of tone which will be depicted by that color. Pressing **Level Down** will cause a smaller band of tone to be depicted as a given color. There are 64 steps. The level controls operate only on analog video signals such as those from VGA, MCGA, or Macintosh II display systems.

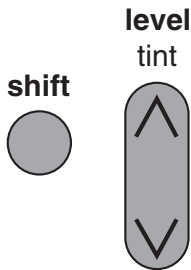

**Fig. 4-13. Level Up and Level Down.**

### 4.3.5 MENU

Pressing the **Menu** control displays the User Menu, which allows you to adjust the initial color balance and tracking, change the text mode and language, and flip the projection image. The User Menu also provides information about the video input. After you display the User Menu, use the **Position** (< >) control buttons to move within and between menu options, and the **Position** (^ or v) to change an option.

For information about the **User Menu**, see the section later in this chapter.

**Shift-Menu** (either button) moves you in or out of menu mode.

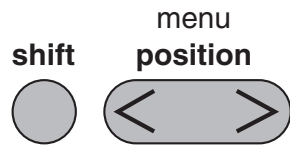

**Fig. 4-14. Menu.**

## 4.4 Using the Control Buttons to Make Adjustments

Now that you have reviewed the functions of each of the control buttons, here is the order in which you use them to achieve the best possible projected image.

1. Press the **Tint** or **Contrast** buttons up or down to change the color of your image or text for the best viewing. Tint or contrast is easiest to adjust with an image that contains large areas of different color or greyscale.
2. Move the image on the screen with the **Position Up**, **Down**, **Left**, and **Right** buttons until it is centered.
3. Focus the overhead projector until the image is crisp and clear.

**NOTE**

**The Projection Panel must be placed correctly on the overhead projector. Incorrect placement may cause the Projection Panel to project blurry or mis-converged images. For more information, see Appendix A.**

4. Press **Sync** until the image is locked in as a solid image with no shimmer or movement. This button toggles through the present settings to the specific computer graphics type. Press **Sync** until you achieve the best image.
  5. For VGA, MCGA, and Macintosh II, you may need to hold down **Shift** and press **Level Up** or **Level Down** to choose the best color matching. For best results when adjusting the level, display an image that has a wide range of colors.
- For VGA text display, you may need to adjust the Text Mode if the text characters are jagged or shimmering.
6. If your computer is one of the standard supported systems, your image should be fully adjusted at this point. However, if your computer is any other type, you may see evenly spaced fuzzy vertical lines, or text may appear to be too wide or too narrow for the screen. To correct this problem, go to the User Menu (press the **Menu** control button) and adjust the tracking.
  7. You may want to press **Reverse** to select either light characters on a dark background or dark characters on a light background. Use the setting which best suits your graphics or text.
  8. To restore factory-set default values, hold down **Shift** and press **Reset** while the menu is being displayed.

**4.5 User Menu**

Pressing the **Menu** control button displays the User Menu on your computer's monitor. The User Menu allows you to change the color balance, adjust the tracking, and control how information is displayed.



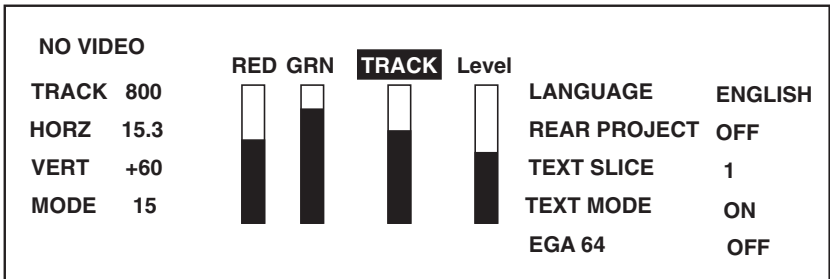

Fig. 4-15. Projection Panel Menu.

## 4.6 Moving Through the User Menu

After you display the User Menu, use the **Position** control buttons (left and right) to move within and between option columns.

These keys are auto-repeat buttons; that is, pressing and holding these buttons causes them to constantly send instructions.

**Tint/.Contrast** and **Level** buttons are still active when in Menu Mode.

## 4.7 Adjusting a Menu Option

Use the **Position Up** and **Down** control buttons to adjust menu options. These keys auto-repeat. Pressing Shift RESET when the menu is showing resets all menu items, including the color adjustments, to factory-default values.

### 4.7.1 COLOR BALANCE (TRUE COLOR ONLY)

Adjust the Tint control to get the best colors. Black and white will always have a reddish tint. If the colors still need adjustment, display the menu by pressing **Shift-Menu**. If you press **Shift-Reset** when the menu is displayed, the color balance will be reset to its factory default values. Resetting to default and slightly adjusting the Tint control may be enough to improve the colors.

If the colors still need adjustment, follow these steps and use the red and green adjustments to fine-tune the panel:

1. Move the green bar down until you have a rich red and a solid black.
2. Move the red bar down until you have a rich, true green. If cyan turns green, the green bar turns brown, and the white turns magenta, you have moved the bar too far down.
3. If your white is magenta-tinted, drop the red bar down a few steps until it is white, but not so far that the black turns red. White and black, however, are always going to be slightly reddish.

#### 4.7.2 EGA 64

For the True Color Panel, EGA 64 may affect the color brown on some EGA systems and some VGA systems when in EGA mode. If your brown is displaying as light red, turn on the EGA 64 setting.

For the Monochrome Panel, EGA 64 may allow you to get all 16 shades of grey instead of 15 shades.

Default value is OFF.

#### 4.7.3 TRACKING

The Tracking adjustment bar allows you to match the Projection Panel's internal clock to the different computer graphics signals. Using tracking allows the Projection Panel to project crisp images from a range of computer graphics systems. There are 64 tracking levels.

You need to adjust the tracking if the display shows evenly spaced, fuzzy vertical lines, or if the projected image is too wide or too narrow for the screen.

Move the tracking bar down (lower numbers) to make the image look narrower. Move the tracking bar up (higher numbers) to make the image look wider. The default Track value is shown with the Video Information. As you move the Tracking adjustment bar up or down, the Track value changes. Move the Tracking adjustment bar up or down until the fuzzy lines move apart on the screen or disappear, or the text fits the screen. The ideal is to have no bars visible and all the projected text or graphics on the screen.

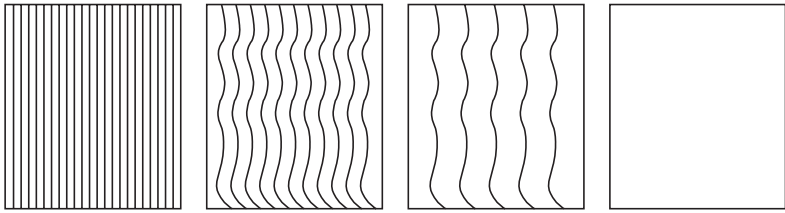

**Fig. 4-16. Tracking.**

#### **4.7.4 VIDEO/NO VIDEO**

The Video column provides information about the current video input. If video is not present, the User Menu displays “No Video,” with no Horizontal or Mode information and the test pattern or blank screen visible in the image area.

The Video information column shows the tracking setting (described previously), the horizontal sync frequency and polarity (HORZ), the vertical sync frequency and polarity (VERT), and the video mode number (MODE).

These values (except for Track) are for informational purposes and cannot be adjusted. If you are experiencing problems, be sure to write down these values before calling Technical Support.

#### **4.7.5 LANGUAGE**

Menus can be displayed in either English, French, German, Italian, or Spanish. The User Menu allows you to choose the language. The default is English.

#### **4.7.6 REAR PROJECTION**

Select ON to flip the image from left to right for rear projection screens. The default is OFF. Rear projection allows you to use a standard overhead projector without complex mirror setups for rear projection.

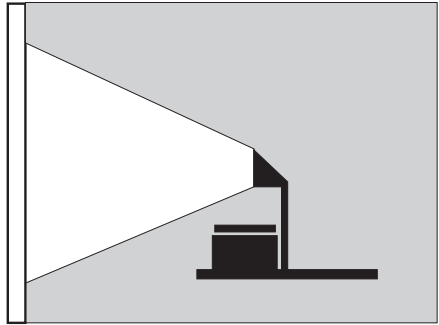

**Fig. 4-17. Rear Projection.**

#### 4.7.7 TEXT SLICE

Text Slice allows you to adjust VGA text characters to look their best. The Projection Panel discards one of seven pixels to adjust characters. Text Slice allows you to choose which of the seven pixels you want the Projection Panel to discard. Text Slice is ON for only 720 text mode (VGA text). Text Slice has no effect on characters when Text Mode is OFF. Adjust the Text Slice until your characters are solid and fully formed.

#### 4.7.8 TEXT MODE

The Projection Panel screen area is 640 pixels wide. Text that extends beyond 640 pixels may be either compressed or truncated. When text (or graphics) is compressed, it is tightly spaced to fit the display screen. Truncated text (or graphics) is not respaced to fit the display; rather, anything beyond the right edge of the screen display is not shown.

Selecting ON for the Text Mode locks VGA text to solid pixels (no shimmering). CGA graphics, however, may be compressed. Unless you regularly project CGA graphics with the Projection Panel, text mode should be set to ON.

Text Mode works only when text is present. For example, this mode works in VGA text but not in VGA graphics.

**You are now ready to begin a presentation.**

Now that the Projection Panel is properly connected and you have adjusted the image on the screen, you are ready to begin projecting your computer data and graphics.

The projected images will be live from your computer and change as you change the computer data.

## 5. Maintenance and Troubleshooting

The information in this chapter is a guide to the cleaning and maintenance of your Projection Panel, as well as to locating and solving possible problems.

### 5.1 Cleaning the Display Surface

1. Handle the Projection Panel as you would anything made of glass. Be especially careful not to drop it.

The hardened polymer surface of the Real Color 16 LCD Projection Panel (AC400A) is designed to be scratch and dent resistant. However, you should avoid scratching it with sharp metal objects. The Monochrome 16 LCD Projection Panel (AC401A) surface is made of glass, and you should follow the instructions in step 2.

2. If the surface needs cleaning, you can use any normal non-abrasive glass cleaner on it. Apply the cleaner to a cleaning cloth and then wipe the surface lightly. Do not use excessive amounts of liquid. Do not use abrasive cleaners, solvents, or other harsh chemicals.

### 5.2 Cleaning the Projection Panel Filter

The filter, which is located at the front of the Projection Panel, catches dust particles before they get into the Projection Panel. You need to routinely clean the filter. To clean the filter, follow these steps:

1. Unsnap the fan cover.

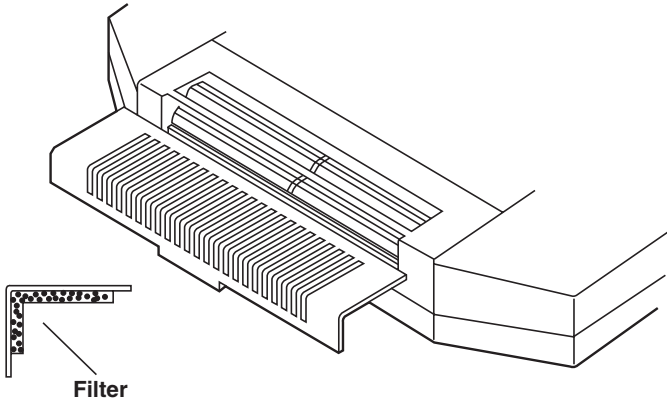

**Fig. 5-1. The Projection Panel Filter.**

2. Gently remove the filter and clean it by washing it in gentle soap. Be sure to let the filter dry completely before re-inserting it in the Projection Panel.

The frequency with which you will need to clean the filter depends on how often you use the Panel. Typically, you will need to clean the filter approximately once every three to six months or when the Projection Panel overheats from a clogged filter.

### 5.3 Troubleshooting Guide

Before calling Technical Support for assistance, attempt to solve the problem by checking this troubleshooting guide.

**Problem:** Nothing on screen.

#### **Possible Causes and Solutions:**

- You may not have any power or you may be using the wrong power supply. Check to see that the proper Projection Panel power supply is being used with the Projection Panel.

- The power supply may not be plugged into a live AC outlet. Check to ensure that the power supply is connected to the Projection Panel and to a live AC wall outlet.
- Your power supply may be plugged into a power strip that is not turned on.
- Your overhead projector may not be set up correctly. Check to see that the projector is on and plugged in properly. Also check the bulb, and make sure the overhead deflector is correctly positioned.
- Your Projection Panel may not be adjusted properly. Also, check and adjust the contrast and level control settings.

**Problem:** Color or VGA text not being projected.

### **Possible Causes and Solutions:**

- Your level control may need to be adjusted. Adjust the Projection Panel level control up or down until the text is visible.
- Your software may be displaying colors that are too similar. Set your software to increase the difference between displayed colors.

**Problem:** Image not centered on the screen.

### **Possible Causes and Solutions:**

- Adjust position to center image on screen.

**Problem:** Only the test pattern is being displayed.

### **Possible Causes and Solutions:**

- Your Projection Panel video cables may not be connected correctly. Check to see that the cable is connected to the video port on the computer's graphics card.
- Your computer graphics system may not be set up correctly. Check the following: your computer's color graphics card is turned on; your computer has a compatible graphics card; and the computer's external video card has been turned on.

**Problem:** Image is too wide or narrow for screen.

### **Possible Causes and Solutions:**

- You may need to adjust the tracking to reduce or enlarge the projected image.
- Check to see that your computer is using a compatible graphics card.
- You may be using a high-resolution display card. Make sure your computer is compatible. Change the resolution if you can.

**Problem:** Image is out of focus.

**Possible Causes and Solutions:**

- Overhead is not adjusted correctly. Adjust overhead until image is in focus.
- The surface of the Projection Panel or overhead projector may need cleaning.

**Problem:** Vertical lines or bleeding.

**Possible Causes and Solutions:**

- Adjust tint to minimize vertical lines or bleeding from around projected boxes or borders.

**Problem:** The projected colors do not match the monitor.

**Possible Causes and Solutions:**

- Adjust the level and/or tint controls. However, just as there are differences in the displays of different monitors, there will always be some differences between the computer screen and the projected image.



# A. Working With Colors (AC400A only)

### NOTE

This appendix applies only to the Real Color 16 LCD Projection Panel (AC400A).

### Convergence

Color alignment on a screen is known as convergence. Colors that are aligned correctly, pixel by pixel, will produce sharp lines on the screen. If the colors do not align correctly, objects on the screen will seem to have multi-colored shadows. Poor color convergence or misconvergence, then, creates blurred images, which can cause eye strain.

You can adjust convergence by positioning the Projection Panel on an overhead projector. To adjust the convergence, follow these steps:

1. Apply power to the Projection Panel, but do not connect a video cable to it.
2. Place the Projection Panel on your projector and turn the projector on. A test pattern consisting of a series of color bars and a line grid should appear.
3. Looking at the projection screen, move the Projection Panel around on the projector until all lines, both horizontal and vertical, are solid. (As you move the Projection Panel around, you will see the lines split apart from single dark lines to rainbow-colored lines).
4. Position the Projection Panel on the spot at which the lines are the most converged.

## B. Interface Requirements

The Projection Panel is equipped with a 26-pin connector. Table B-1 shows the pin assignments for the 26-pin connector.

**Table B-1. Pin Assignments for the 26-pin connector.**

<b>Input Pin</b>	<b>Signal Description</b>	<b>Output Pin</b>
1	Vertical sync	10
2	Horizontal sync	11
8	Blue analog	14
6	Intensity TTL	12
7	Green TTL	13
9	Red analog	15
16	Blue TTL	3
17	Red TTL	4
18	Green analog	5
20, 21	GND	
22	GND	
23	Key (TTL/analog sensor)	
24	GND	
25	GND	
26	Hercules	19

## B.1 Power Connector Polarity

The power connector on your Projection Panel uses the polarity shown in Fig. B-1.



**Fig. B-1. Power Connector Polarity.**

The Projection Panel is shipped with a 12-Volt, 1.5-Amp power supply designed to work specifically with the Projection Panel. Many portable computers and peripherals use similar-looking power supplies.

### **CAUTION**

**Do not substitute other power supplies. You could damage the Projection Panel.**

To double check, look for the label on the Projection Panel power supply.

## B.2 Screen Area

The Projection Panel's screen is 640 by 480 pixels. (Pixels are tiny rectangular dots that are turned on and off by the computer to create images.) Various computer monitors have different pixel dimensions. Depending on the computer's resolution, the images may not fill the entire screen. Fig. B-2 represents the Macintosh display. Table B-2 lists several common computer monitors and their screen areas.

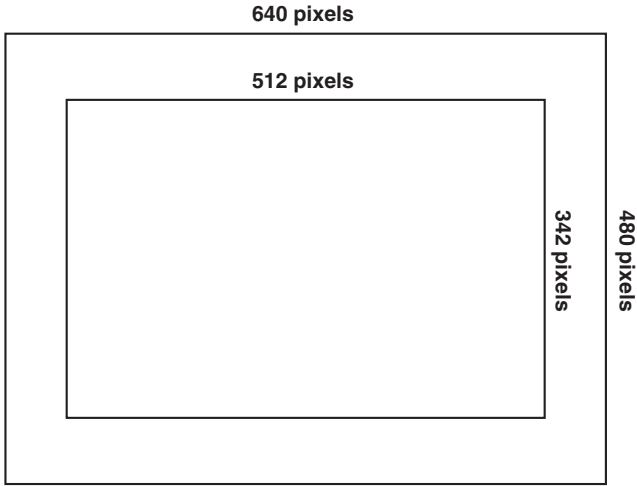

**Fig. B-2. Macintosh Display.**

**Table B-2. Common Computer Monitors and Their Screen Areas.**

<b>Computer Monitor</b>	<b>Projection Panel Screen Area</b>
AT&T, CGA	640 x 400 pixels
EGA	640 x 350 pixels
Macintosh	512 x 342 pixels
Macintosh II, VGA	640 x 480 pixels
Macintosh LC	512 x 384 pixels

## C. Special Guidelines for IBM and Compatibles

### C.1 IBM Computers with Two Display Cards

If your computer has both a color and monochrome display, you may need to turn on the color card. Because your computer will only display on one monitor at a time, you need to ensure that the color display is on when using the Projection Panel.

You can do this in a variety of ways. Some computers require special commands other than MS-DOS® commands. The best reference for finding these commands is your computer manual.

See **Section C.2** for instructions on how to setup a color or monochrome display.

For most IBM and IBM compatibles:

1. Follow the instructions for setting up the Projection Panel.
2. Insert your MS-DOS disk in drive A. (Skip this step if you have a hard drive.)
3. When the DOS prompt appears, type **MODE CO80** (CO for color, the number 80 for 80 columns).
4. The color card should be activated.

If you have a monochrome monitor and want to switch back, at the DOS prompt, type: **MODE MONO**

The Projection Panel will go off and your monochrome monitor will come on.

## C.2 Instructions for Activating Portables and Laptops

Refer to Table C-1 for commands to activate or de-activate the Projection Panel.

**Table C-1. Portable and Laptop Activation Chart.**

<b>Computer Model</b>	<b>Activate Port Command</b>	<b>De-activate Command</b>	<b>Video Standard</b>
Compaq® portable II	Ctrl Alt <	Ctrl Alt >	CGA
Compaq portable III	Ctrl Alt <	Ctrl Alt >	CGA
Compaq SLT	Ctrl Alt <	Ctrl Alt >	VGA
Compaq LTE/286	Ctrl Alt <	Ctrl Alt >	CGA
Dell® 316LT	Ctrl Alt F11	Ctrl Alt F10	VGA
Epson® LT	Switch for CRT On	Switch for LCD On	CGA
Epson 286e	Switch for CRT On	Switch for LCD On	EGA
Gridcase 1200 series	Active port	N/A	CGA
Gridcase 1400 series	Ctrl Alt Tab	Ctrl Alt Tab	VGA
Gridcase 1520	Ctrl Alt Tab	Ctrl Alt Tab	CGA
Gridcase 1530	Ctrl Alt Tab	Ctrl Alt Tab	CGA
Gridcase 1535 EXP	Ctrl Alt Tab	Ctrl Alt Tab	CGA
IBM P70 386	Active Port	N/A	VGA
Mitsubishi	Sw2 on off off off	Sw2 off on on on	EGA
Packard Bell PB286LT	Fn F10	Fn F10	EGA
Sharp® PC-5541	Switch for CRT On	Switch for LCD On	VGA
Toshiba® 1000	Fn End	Fn Home	CGA
Toshiba 1100	Ctrl Alt End	Ctrl Alt Home	CGA
Toshiba 1200, 1600	Fn End	Fn Home	CGA
Toshiba 3100	Ctrl Alt End	Ctrl Alt Home	CGA

**Table C-1 (continued). Portable and Laptop Activation Chart.**

<b>Computer Model</b>	<b>Activate Port Command</b>	<b>De-activate Command</b>	<b>Video Standard</b>
Toshiba 3100-e	Ctrl Alt End	Ctrl Alt Home	EGA
Toshiba 3100sx	Active Port	N/A	VGA
Toshiba 3200sx	Active Port	N/A	VGA
Toshiba 3200	Fn End	Fn Home	EGA
Toshiba 5100	Ctrl Alt End	Ctrl Alt Home	EGA
Toshiba 5100/100	Active Port	N/A	EGA
Toshiba 5200	Active Port	N/A	VGA
Toshiba 5100/100	Active Port	N/A	VGA
Zenith 128, 170, 180, 183, 184, Supersport	Fn F10	Fn F10	CGA
Zenith Supersport 286e	Fn F10	Fn F10	VGA
Supersport sx			
Supersport			

**Numbers**

512x342 pixels, 15  
640 by 480 pixels, 36  
640x480 pixel display, 7

**C**

CGA, 7, 10,, 18, 28

**E**

EGA, 7, 10,, 18, 21, 26

**M**

MCGA, 10, 24  
MS DOS, 38

**R**

RGB, 7

**V**

VGA, 7, 10, 13, 18, 22, 24, 26, 28





© Copyright 1993. Black Box Corporation. All rights reserved.

---

1000 Park Drive • Lawrence, PA 15055-1018 • 724-746-5500 • Fax 724-746-0746

## Free Manuals Download Website

<http://myh66.com>

<http://usermanuals.us>

<http://www.somanuals.com>

<http://www.4manuals.cc>

<http://www.manual-lib.com>

<http://www.404manual.com>

<http://www.luxmanual.com>

<http://aubethermostatmanual.com>

Golf course search by state

<http://golfingnear.com>

Email search by domain

<http://emailbydomain.com>

Auto manuals search

<http://auto.somanuals.com>

TV manuals search

<http://tv.somanuals.com>