

ServSwitch™ BRAND  
**USB Micro Extender**



## Welcome to the ServSwitch™ Family!

Thank you for purchasing a BLACK BOX® ServSwitch™ Brand USB Micro Extender model! We appreciate your business, and we think you'll appreciate the many ways that your enhanced extension system will save you money, time, and effort.

That's because our ServSwitch family is all about breaking away from the traditional, expensive model of computer management. You know, the one-size-fits-all-even-if-it-doesn't model that says, "One computer gets one user station, no more, no less." Why not a single user station (monitor, keyboard, and mouse) for multiple computers—even computers of different platforms? Why not a pair of user stations, each of which can control multiple computers? Why not multiple user stations for the same computer?

With our ServSwitch products, there's no reason why not. We carry a broad line of robust solutions for all these applications. Do you have just two PCs, and need an economical alternative to keeping two monitors, keyboards, and mice on your desk? Or do you need to share dozens of computers, including a mix of IBM® PC, RS/6000®, Apple® Macintosh®, Sun Microsystems®, and SGI™ compatibles among multiple users with different access levels? Does your switch have to sit solidly on a worktable and use regular everyday cables? Or does it have to be mounted in an equipment rack and use convenient many-to-one cables? No matter how large or small your setup is, no matter how simple or how complex, we're confident we have a ServSwitch system that's just right for you.

The ServSwitch™ family from Black Box—the one-stop answer for all your KVM-switching needs!

This manual will tell you all about your new ServSwitch™ Brand USB Micro Extender, including how to install, operate, and troubleshoot it. For an introduction to the Extender, see **Chapter 2**. The Extender product codes covered in this manual are:

**ACU4001A**

**ACU4201A**

**ACU4222A**

## Copyrights and Trademarks

©2005. All rights reserved. This information may not be reproduced in any manner without the prior written consent of the manufacturer.

Information in this document is subject to change without notice and the manufacturer shall not be liable for any direct, indirect, special, incidental or consequential damages in connection with the use of this material.

All trademark and trade names mentioned in this document are acknowledged to be the property of their respective owners.

## Disclaimer

While every precaution has been taken in the preparation of this manual, the manufacturer assumes no responsibility for errors or omissions. Neither does the manufacturer assume any liability for damages resulting from the use of the information contained herein. The manufacturer reserves the right to change the specifications, functions, or circuitry of the product without notice.

The manufacturer cannot accept liability for damage due to misuse of the product or due to any other circumstances outside the manufacturer's control (whether environmental or installation related). The manufacturer shall not be responsible for any loss, damage, or injury arising directly, indirectly, or consequently from the use of this product.

## Cautions and Notes

The following symbols are used in this guide:



**CAUTION.** This indicates an important operating instruction that should be followed to avoid any potential damage to hardware or property, loss of data, or personal injury.



*NOTE.* This indicates important information to help you make the best use of this product.

**FEDERAL COMMUNICATIONS COMMISSION  
AND CANADIAN DEPARTMENT OF COMMUNICATIONS****RADIO-FREQUENCY INTERFERENCE STATEMENTS**

This equipment generates, uses, and can radiate radio-frequency energy, and if not installed and used properly, that is, in strict accordance with the manufacturer's instructions, may cause interference to radio communication. It has been tested and found to comply with the limits for a Class A computing device in accordance with the specifications in Subpart B of Part 15 of FCC rules, which are designed to provide reasonable protection against such interference when the equipment is operated in a commercial environment. Operation of this equipment in a residential area is likely to cause interference, in which case the user at his own expense will be required to take whatever measures may be necessary to correct the interference.

Changes or modifications not expressly approved by the party responsible for compliance could void the user's authority to operate the equipment.

Shielded PC-equipment cables must be used with this equipment to maintain compliance with radio frequency energy emission regulations and ensure a suitably high level of immunity to electromagnetic disturbances.

*This digital apparatus does not exceed the Class A limits for radio noise emission from digital apparatus set out in the Radio Interference Regulation of the Canadian Department of Communications.*

*Le présent appareil numérique n'émet pas de bruits radioélectriques dépassant les limites applicables aux appareils numériques de la classe A prescrites dans le Règlement sur le brouillage radioélectrique publié par le Ministère des Communications du Canada.*

## **EUROPEAN UNION DECLARATION OF CONFORMITY**

### **WARNING!**

**This is a class A product. In a domestic environment, this product may cause radio interference, in which case the user may be required to take adequate measures.**

This product complies with the following harmonized standards:

EN55022:1998, EN55024:1998, EN61000-3-2:2001,

EN61000-3-3:2000, EN60950-1:2000

When used in environments that have high levels of electromagnetic interference or excessive power ground noise, you may experience disturbances to video and/or data transmission. If this is the case, please refer to the Troubleshooting section of the User Guide for further information, or contact Technical Support.

To maintain compliance, only use cables supplied (or recommended) for use with this product. In electrically noisy environments, the use of shielded (STP/FTP) rather than unshielded (UTP) interconnection cable is recommended.



## **NORMAS OFICIALES MEXICANAS (NOM)**

### **ELECTRICAL SAFETY STATEMENT**

#### **INSTRUCCIONES DE SEGURIDAD**

1. Todas las instrucciones de seguridad y operación deberán ser leídas antes de que el aparato eléctrico sea operado.
2. Las instrucciones de seguridad y operación deberán ser guardadas para referencia futura.
3. Todas las advertencias en el aparato eléctrico y en sus instrucciones de operación deben ser respetadas.
4. Todas las instrucciones de operación y uso deben ser seguidas.
5. El aparato eléctrico no deberá ser usado cerca del agua—por ejemplo, cerca de la tina de baño, lavabo, sótano mojado o cerca de una alberca, etc..
6. El aparato eléctrico debe ser usado únicamente con carritos o pedestals que sean recomendados por el fabricante.
7. El aparato eléctrico debe ser montado a la pared o al techo sólo como sea recomendado por el fabricante.
8. Servicio—El usuario no debe intentar dar servicio al equipo eléctrico más allá a lo descrito en las instrucciones de operación. Todo otro servicio deberá ser referido a personal de servicio calificado.
9. El aparato eléctrico debe ser situado de tal manera que su posición no interfiera su uso. La colocación del aparato eléctrico sobre una cama, sofá, alfombra o superficie similar puede bloquea la ventilación, no se debe colocar en libreros o gabinetes que impidan el flujo de aire por los orificios de ventilación.
10. El equipo eléctrico deber ser situado fuera del alcance de fuentes de calor como radiadores, registros de calor, estufas u otros aparatos (incluyendo amplificadores) que producen calor.
11. El aparato eléctrico deberá ser conectado a una fuente de poder sólo del tipo descrito en el instructivo de operación, o como se indique en el aparato.
12. Precaución debe ser tomada de tal manera que la tierra física y la polarización del equipo no sea eliminada.
13. Los cables de la fuente de poder deben ser guiados de tal manera que no sean pisados ni pellizcados por objetos colocados sobre o contra ellos, poniendo particular atención a los contactos y receptáculos donde salen del aparato.

14. El equipo eléctrico debe ser limpiado únicamente de acuerdo a las recomendaciones del fabricante.
15. En caso de existir, una antena externa deberá ser localizada lejos de las líneas de energía.
16. El cable de corriente deberá ser desconectado del cuando el equipo no sea usado por un largo periodo de tiempo.
17. Cuidado debe ser tomado de tal manera que objetos líquidos no sean derramados sobre la cubierta u orificios de ventilación.
18. Servicio por personal calificado deberá ser provisto cuando:
  - A: El cable de poder o el contacto ha sido dañado; u
  - B: Objetos han caído o líquido ha sido derramado dentro del aparato; o
  - C: El aparato ha sido expuesto a la lluvia; o
  - D: El aparato parece no operar normalmente o muestra un cambio en su desempeño; o
  - E: El aparato ha sido tirado o su cubierta ha sido dañada.

## Safety Precautions and Installation Guidelines

To ensure reliable and safe long-term operation please note the following installation guidelines:

- Do not use to link between buildings.
- Only use in dry, indoor environments.
- If the building has 3-phase AC power, try to ensure that equipment connected to the Local and Remote units is on the same phase.
- Try not to route the CATx link cable alongside power cables.
- Ensure that the system connected to the Local unit is connected to power ground.
- Ensure that the monitor connected to the Remote unit is connected to power ground and does not use an isolated power supply.
- The Remote unit and any power supplies can get warm. Do not situate them in an enclosed space without any airflow.
- Do not place the power supply directly on top of the Remote unit.
- Do not obscure the Remote unit's ventilation holes.
- This product is not suitable for use in isolated medical environments.



**To safeguard against personal injury and avoid possible damage to equipment or property, please observe the following:**

- **Only use power supplies originally supplied with the product or manufacturer-approved replacements. Do not attempt to dismantle or repair any power supply. Do not use a power supply if it appears to be defective or has a damaged case.**
- **Connect all power supplies to grounded outlets. In each case, ensure that the ground connection is maintained from the outlet socket through to the power supply's AC power input.**
- **Do not attempt to modify or repair this product, or make a connection from the CATx link interface (RJ45) to any other products, especially telecommunications or network equipment.**



# Contents

<b>1. Quick Setup</b>	<b>9</b>
<b>2. Overview</b>	<b>10</b>
2.1 Introduction	10
2.2 Glossary	10
2.3 Features	12
2.4 Product Range	13
2.5 Compatibility	14
2.6 How to Use This Guide	15
<b>3. Installation</b>	<b>16</b>
3.1 Package Contents	16
3.2 Interconnection Cable Requirements	17
3.3 Remote Unit Installation	18
3.4 Local Unit Installation	21
<b>4. Troubleshooting</b>	<b>24</b>
4.1 Video	24
4.2 USB	25
4.3 Audio	26
4.4 Serial	26
4.5 General Questions	27
<b>Appendix A: Example Applications</b>	<b>28</b>
<b>Appendix B: Rack Mount Options</b>	<b>32</b>
<b>Appendix C: Audio/Serial Ports</b>	<b>33</b>
<b>Appendix D: Calling Black Box</b>	<b>35</b>
<b>Appendix E: Specifications</b>	<b>36</b>

# 1. Quick Setup

This section briefly describes how to install your USB Micro extender system. Unless you are an experienced user, we recommend that you follow the full procedures described in the rest of this manual.

## Set Video Distance DIP Switches

Set DIP switches on base of Remote Unit to position for Interconnect cable length:

15-75ft (5-25m)	OFF (default)
75ft-150ft (25-50m)	ON

*DIP Switch 1:* Primary Interconnect (channel 1)

*DIP Switch 2:* Interconnect 2 (ACU4201A & ACU4222A only)

See **Setting the Cable Length DIP Switches** on page 18.

## Connect Remote Unit and devices

Connect Remote Unit to monitor, USB and audio/serial devices (if present). Connect 5V power supply.

See **Connecting the Remote Unit** on page 19.

## Connect Local Unit to CPU

Connect Local Unit to CPU video, USB and Audio/Serial ports (if used).

Connect Local monitor(s) to video output(s) on Local Unit.

**Note.** If you intend to connect the Local Unit to an external USB hub, ensure that it is self-powered. If not, you will need an additional 5V PSU for the Local Unit (not supplied).

See **Local Unit Installation** on page 21.

## Connect Local and Remote Units

Connect extender units with up to 150ft (50m) of compatible CATx interconnect cable.

See **Interconnection Cable Requirements** on page 17.

## Power Up

Power up the CPU.

Switch on the Remote Unit power supply.

Auto-adjust flat panel monitors

Use LEDs on Interconnect ports to check operation (see pages 20 and 23).

## 2. Overview

### 2.1 Introduction

The ServSwitch™ Brand USB Micro Extender Series enables high-resolution video, USB, stereo audio, and serial port signals to be communicated up to 150ft (50m) over Category 5, 5e, 6 or higher (CATx) cable.

A basic USB extension system comprises a *Local* unit (transmitter) and a *Remote* unit (receiver). The Local unit connects directly to the computer (or a USB Hub) using the supplied cable(s). The user *console* (consisting of monitor, keyboard, mouse and other devices) attaches to the Remote unit. All Local Units in the USB Micro Extender Series have video output ports, allowing a second user console at the CPU (using further CPU/Hub ports). The Remote and Local units communicate video and data information along the connecting CATx cable (see Figure 1).

Within the product range, models are available with:

- Audio and serial transmission: bi-directional stereo audio (16-bit digitized) and transparent serial COM port (to 19.2Kbps).
- Multiple video channels: single and dual heads.

### 2.2 Glossary

The following terms are used in this guide:

<b><i>CATx</i></b>	Any Category 5, 5e, 6 or higher cable.
<b><i>PSU</i></b>	Desktop power supply.
<b><i>KVM</i></b>	Keyboard, Video and Mouse.
<b><i>Console</i></b>	A keyboard, monitor, and mouse, plus optional USB/serial/audio devices.
<b><i>Dual Access</i></b>	A system allowing connection of Local and Remote user consoles.
<b><i>Single Head</i></b>	An extender system that supports one monitor.
<b><i>Dual Head</i></b>	An extender system that supports two monitors.

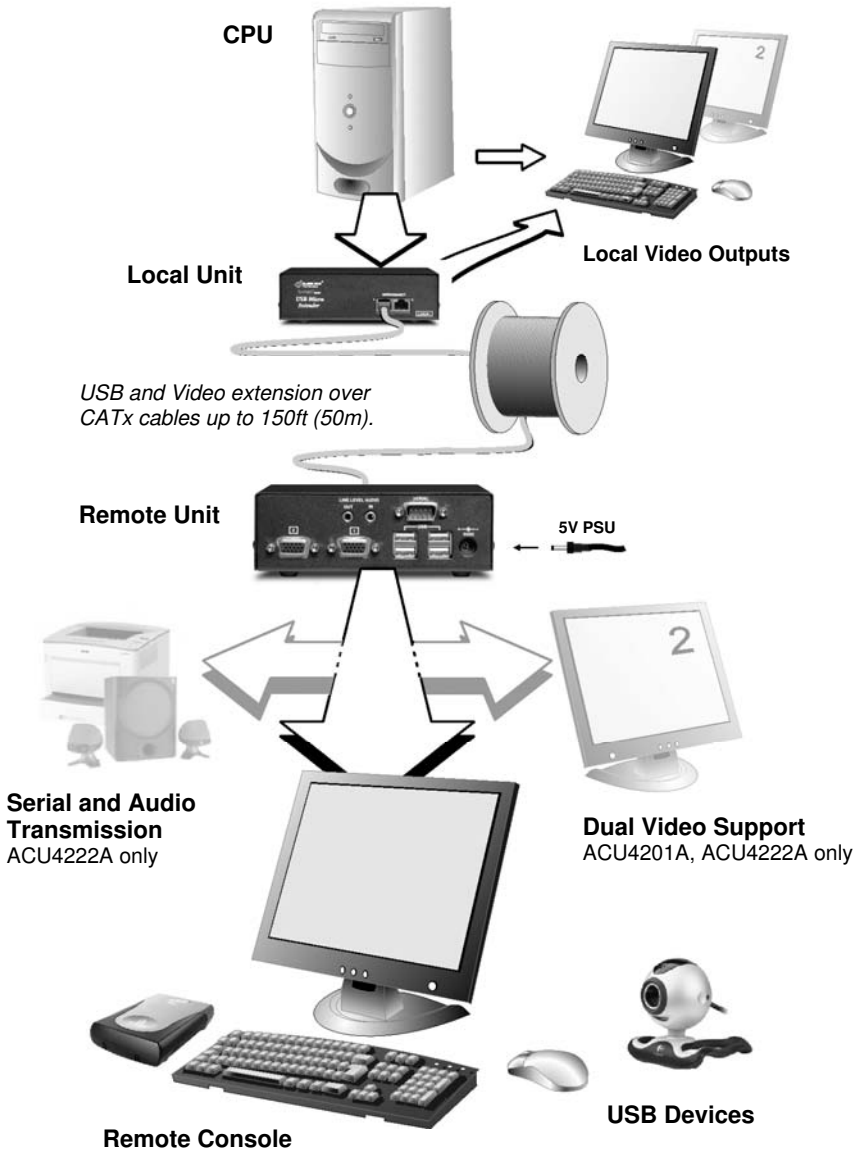

Figure 1 USB Micro Extender System

## 2.3 Features

The ServSwitch™ Brand USB Micro Extender Series offers the following features:

- **Transparent USB 2.0 Extension (low/full speed only)**  
Transparently extends most USB peripherals.  
Remote unit has integral 4-port USB hub.
- **Supports high video resolutions for use with TFT displays**  
1600x1200@75Hz over 150ft (50m)
- **Emulated VESA DDC (Display Data Channel)**  
Extender Local Unit emulates a universal monitor  
Ensures maximum compatibility with multi-head graphics cards  
DDC emulation on all video channels
- **Local Video Output**  
Local video output on all video channels  
Allows dual-access operation when a local USB keyboard and mouse are connected directly to the CPU (or via a hub)
- **Single and Dual-Head Video Support**  
One CATx cable required per channel
- **Transparent serial port (on certain models)**  
Enables any serial device to be extended (up to 19.2K Baud). The serial port may be used to extend one device (requiring handshaking lines), or up to three simple serial devices (no handshaking).
- **Bi-directional stereo audio support (on certain models)**  
16-bit digitized high-quality, low-noise audio extension.
- **Local unit powered by USB**  
Local unit takes power directly from USB connection. Optional 5V PSU may be connected for video only applications or when USB power is insufficient.
- **External PSU Overvoltage Protection**  
Remote or Local unit will not operate if an incorrect (>5V) PSU is connected.
- **Status indicator LEDs on each RJ45 port**
- **Small footprint chassis**
- **Rack mount option**  
Plate available to mount three units across 1U.
- **Surge protection on each RJ45 port**
- **CPU cables included**

## 2.4 Product Range

There are three products in the range:

---

### *Single Video Channel Kit (Standard)*

---

ACU4001A	Single Video Channel, Transparent USB Local Unit + Remote Unit
----------	---

---

### *Dual Video Channel Kit (Standard)*

---

ACU4201A	Dual Video Channels, Transparent USB Local Unit + Remote Unit (Dual Video)
----------	---

---

### *Dual Video Channel Kit (Audio)*

---

ACU4222A	Dual Video Channels, Transparent USB, Serial, Stereo Audio Local Unit + Remote Unit (Dual Video)
----------	--

---

## 2.5 Compatibility

### Interface Compatibility

- **USB:** Transparent USB 2.0 Compliant link (Low/Full speed only)  
Extender appears as a self-powered USB hub to the CPU.  
Remote Unit contains integral USB hub with 4-ports. The extender will operate through USB 2.0 Host Controllers. However, the speed will be restricted to that of a USB 1.1 hub (12Mb/s).



*Any device that absolutely requires the high-speed mode of USB 2.0 will not be compatible with the USB Micro Extender.*

- **Audio:** Input and output are line-level. Amplified speakers are required. A microphone may be directly connected to the Remote unit (optional pre-amplification).
- **Serial:** Transparent up to 19.2K Baud (38.4K operation may be possible with some devices). The following serial signals are extended: TX, RX, RTS, CTS, DTR, DSR. In rare cases, a wiring adaptor may be required to transfer RI and DCD.
- **Video:** VGA to UXGA. Separate or composite sync.  
Emulated DDC for each video channel. Local Unit reports as monitor capable of all resolutions and refresh rates normally used with this product. For non-standard resolutions, choose the monitor manually through the operating system, and set to ignore DDC.

### Extender Compatibility

ServSwitch™ Brand USB Micro Extenders are not compatible with existing ServSwitch™ standalone and rack hub CAT5 extenders. Consult Technical Support for information about compatibility with other ServSwitch™ products.

## 2.6 How to Use This Guide

This guide describes the installation and configuration of the ServSwitch™ Brand USB Micro Extender Series. Although the connection and operation of the system is relatively straightforward, you should consider the following before getting started:

### Connection & Compatibility

Each Extender kit contains all the cables required to connect the Local unit to your PC or KVM switch. The Remote monitor(s), USB devices and any audio and serial equipment connects directly to the Remote unit.

For information about connection and installation, see **Installation**, page 16.

### Interconnection Cable

You will need CATx (any category 5, 5e, 6 or higher) cable, terminated with RJ45 plugs, to connect the Local and Remote units (see **Interconnection Cable Requirements**, page 17).

### Adjusting Video

Video signals can become distorted when transmitted over CATx cables. To get the best from your extender system, it is *essential* that you:

- Set the Cable Length DIP switches on the Remote unit correctly (see **Setting the Cable Length DIP Switches** on page 18).
- Use low skew CATx cable.



## 3. Installation

For first-time users, we recommend that you carry out a test placement, confined to a single room, before commencing full installation. This will allow you to identify and solve any cabling problems, and experiment with the USB extender system more conveniently.

### 3.1 Package Contents

You should receive the following items in your extender package. If anything is missing, please refer to Appendix F to obtain Technical Support.

- Extender Remote unit.
- 5-VDC universal power supply for Remote unit.
- Extender Local unit.
- USB/Video CPU cable (1.0m) with USB connector and VGA video (HD15 M-F) connector.
- CPU video cable (1.0m) with VGA video (HD15 M-F) connector.  
*Models: ACU4201A and ACU4222A only.*
- Serial cable (DB9 M-F connectors, 1:1 connections).  
*Models: ACU4222A only.*
- Two stereo audio cables (3.5mm stereo plugs).  
*Model: ACU4222A only.*
- IEC AC Power Cord.
- User Guide.

## 3.2 Interconnection Cable Requirements

To connect the Local and Remote units you will need CATx (any category 5, 5e, 6 or higher) cable terminated with RJ45 plugs.

Interconnect cables must be solid-core type. Stranded patch cable will give poor results over longer distances. The pairing of the cable and pinning of its connectors should normally be in accordance with EIA-568B (see below).

One CATx cable is required for each video channel.

- The *Primary* interconnect cable connects INTERCONNECT Port 1 on the Local and Remote units. This carries the main video channel and USB data.
- The *Secondary* interconnect cable connects to INTERCONNECT Port 2 on the Local and Remote units. This carries the additional video channel on dual-head units and/or audio/serial data.



**Technical Note:** *Although suitable for use with UTP cable, it is recommended that shielded STP/FTP cable is used with this product if possible, especially in electrically noisy environments. When shielded cable is used, it is most important to ensure that shield connectivity is maintained between the Extender units.*

### Cable Pinning/Pairing

The following table illustrates which RJ45 connector pins the extenders use for various signals. It also details the standard EIA-568B wiring scheme that is recommended for most installations.

Looking into the RJ45 socket on a Remote unit, Pin 1 is on the right and Pin 8 on the left.

<i>Pin</i>	<i>Color (EIA-568B)</i>	<i>Signal</i>
1 2	White/Orange Orange/White	Blue Video
3 6	White/Green Green/White	Green Video
4 5	Blue/White White/Blue	Red Video
7 8	White/Brown Brown/White	Data

EIA-568A wiring can also be used. Contact Technical Support for details.

### 3.3 Remote Unit Installation

#### Setting the Cable Length DIP Switches

If your application uses CATx cable less than 25m in length, you can continue to the next section.

Micro Extender Remote units incorporate video equalization circuitry, allowing you to compensate for the loss in image quality that occurs when video signals are transmitted along CATx cables. At the factory, Remote units are configured to optimize the video signals for Interconnect cables up to 75ft (25m) in length.

If you intend to use cables of 75-150ft (25-50m) in length:

1. Locate the DIP switches on the underside of the Remote unit. DIP switch 1 is used for video channel 1, DIP switch 2 for video channel 2.
2. Set the DIP Switches as follows:

<i>Interconnect Cable Length (ft)</i>	<i>Interconnect Cable Length (m)</i>	<i>DIP Switch Position</i>
15 – 75	5 – 25	OFF (default)
75 – 150	25 – 50	ON

If you are carrying out a test placement prior to final installation, set the DIP switch to the position appropriate to the test cable's length. When your tests are complete, set the DIP switch to the position appropriate for the CATx cable length used in the full installation.



**Technical Note:** *The video compensation does not adjust skew. Although skew (color separation) can be an issue on some CATx cables, it would not normally be observed on cables <150ft (50m). Even so, we still recommend the use of low skew cables with USB Micro Extenders. You can test for skew by viewing the online test card at:*

[http://www.blackbox.com/tech\\_support/ts\\_upgrades/ts\\_ss.html](http://www.blackbox.com/tech_support/ts_upgrades/ts_ss.html)

## Connecting the Remote Unit

To install a Remote unit:

1. Connect your monitor, USB and other devices to the Remote unit as shown in Figure 2 (single and dual-head units).



*If additional USB hubs are attached to the extender, the maximum extension distance could be reduced (due to the delay imposed by each hub). For each connected hub, you may lose up to 30ft (10m) of extension distance. Note: any USB device to which additional USB peripherals may be attached is a USB hub (e.g. an Apple® USB keyboard).*

2. If appropriate, connect audio equipment and serial devices. Connect the audio cables as follows:

<i>RemoteUnit</i>	<i>Audio Device</i>
Audio Out	Speakers
Audio In (MIC)	Microphone

See **Appendix C: Audio/Serial Ports**, page 33 for further information.

3. Connect the Primary CATx cable to the INTERCONNECT (1) socket on the front of the Remote unit. For dual head systems, connect an additional CATx cable to INTERCONNECT (2) (see Figure 3).
4. Connect the 5V power supply to power the unit.



**Only use the power supply originally supplied with this equipment or a manufacturer approved replacement.**

5. If you are using a flat panel TFT monitor, **you must adjust the clock and/or phase**, either manually or by using auto-adjust. Refer to the manual supplied with your monitor.

# SERVSWITCH™ BRAND USB MICRO EXTENDER FAMILY

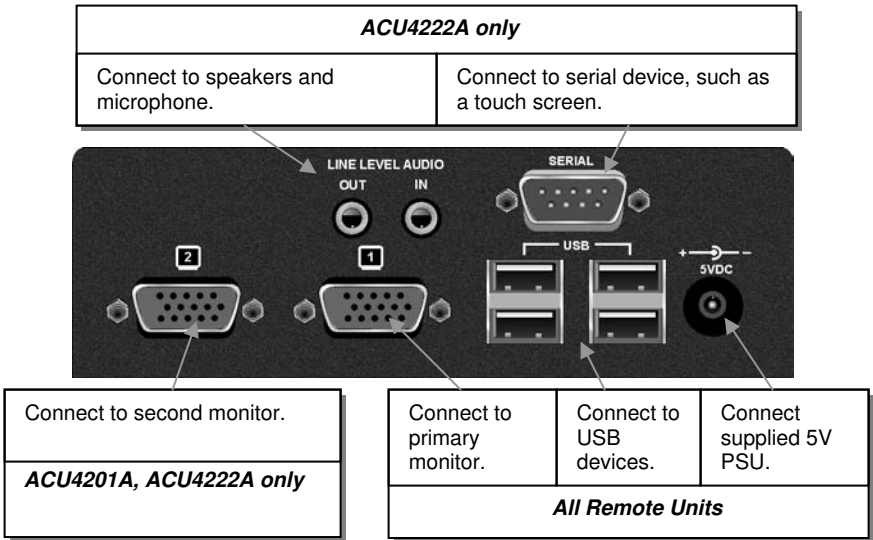

**Figure 2 Remote Unit – rear view**

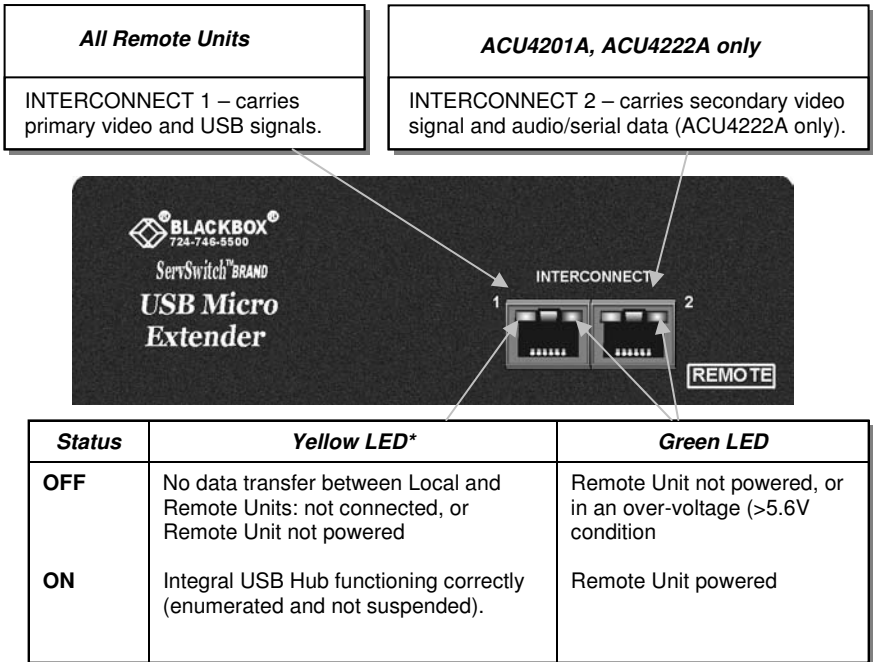

\* Yellow LED active on primary INTERCONNECT socket (Channel 1) only

**Figure 3 Remote Unit - front view**

### 3.4 Local Unit Installation

To install a Local unit:

1. It is recommended that the PC and other devices are switched off before connection.
2. Using the supplied CPU video/USB cable, connect the Local unit to the CPU as shown in Figure 4.



*We recommend that the Local Unit is connected directly to a CPU USB port (Root Hub). If the Local Unit has to be connected through an external hub, you should ensure the hub is self-powered (not bus powered), or connect a 5V PSU (500mA) to the Local Unit.*

3. If you want local access to the CPU, connect the video output(s) on the Local unit to suitable monitors. Connect a USB mouse and a USB keyboard directly to other USB ports on the CPU or a connected hub.
4. If you have an audio and serial enabled system, connect the audio cables between the computer and Local unit as follows:

<i>Computer</i>	<i>Local Unit</i>
Audio Out (green)	Audio In
Audio In/Microphone (pink/blue)	Audio Out

5. If appropriate, connect the supplied serial cable between the serial port on the computer and the Local unit.
6. For single video units, connect the CATx cable to the INTERCONNECT socket on the front of the Local unit. For dual-head systems, connect the CATx cables from the Remote unit to the corresponding INTERCONNECT ports (1&2) on the Local unit (see Figure 5).
7. Power up the PC.



*The Local unit normally takes power through the USB connection. In video only applications, or when the USB interface has limited power (from a bus-powered hub, for example), an external 5V PSU may be required. The power LED will indicate if an external PSU is required (see page 23).*

*Please contact Technical Support to obtain a suitable power supply.*

# SERVSWITCH™ BRAND USB MICRO EXTENDER FAMILY

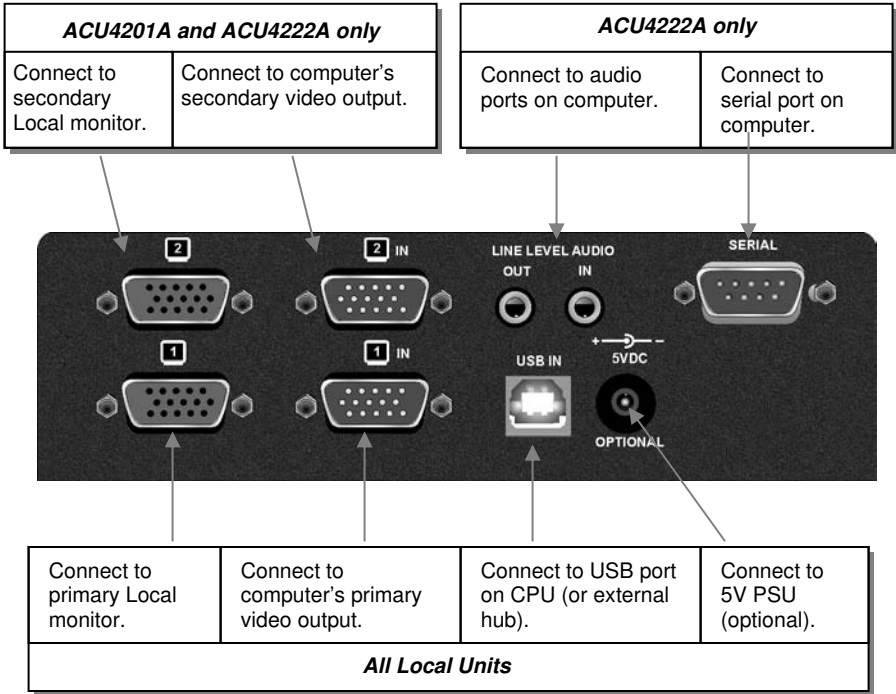

**Figure 4** Local Unit - rear view

<i>All Models</i>	<i>ACU4201A and ACU4222A only</i>
INTERCONNECT 1 – carries primary video and USB signals. Connect to CATx cable from INTERCONNECT 1 port on Remote Unit.	INTERCONNECT 2 – carries secondary video and audio/serial data (ACU4222A only). Connect to CATx cable from INTERCONNECT 2 port on Remote Unit.

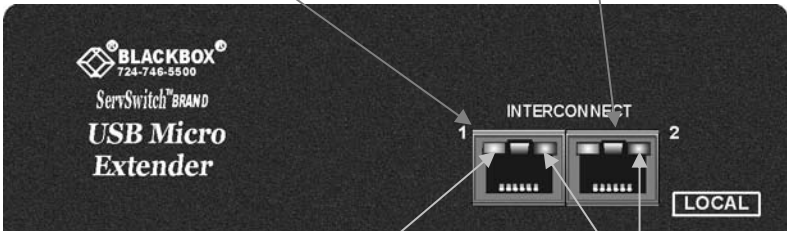

<i>Status</i>	<i>Yellow LED*</i>	<i>Green LED</i>
<b>OFF</b>	No data transfer between Local and Remote units: not connected, or Remote Unit not powered.	Local Unit not powered, or in an over-voltage (>5.6V) or under-voltage (<4.3V) condition.
<b>ON</b>	Powered Remote unit found.	Local Unit powered correctly.

\* Yellow LED active on primary INTERCONNECT socket (Channel 1) only

**Figure 5**                      **Local Unit – front view**



## 4. Troubleshooting

### 4.1 Video

---

***The image is not sharp, or is badly smeared.***

Check that the cable length DIP switch is correct for the length of your Interconnect cable (see page 18).

Check the Interconnect cable between the Remote and Local units. Is it of the recommended type (see page 17)? Is it intact along its entire length and securely connected at both ends? Is it wired correctly?

Ensure that all video connections throughout the system are attached securely.

Are you using an LCD panel? You must adjust its clock and/or phase either manually or using auto-adjust.

---

***Colors appear to be separated and there are colored borders on text and icons.***

Check the Interconnect cable between the Remote and Local units. Is it of the recommended type (see page 17)? Is it intact along its entire length and securely connected at both ends? Is it wired correctly?

Are you using low skew cable? You can test for skew by viewing the online test card at: [http://www.blackbox.com/tech\\_support/ts\\_upgrades/ts\\_ss.html](http://www.blackbox.com/tech_support/ts_upgrades/ts_ss.html)

---

***I only need video extension – not USB - but I can't get a picture.***

Have you powered the Local unit? The Local unit gets its power from the CPU through the USB connection and it will not operate without it. Use an external 5V PSU as described on page 21.

---

***The monitor sometimes goes blank for a second or two.***

Check that the interconnect cable is not routed near power lines or other sources of electrical interference. Use shielded STP/FTP cable instead of UTP cable and ensure the shield connection is maintained between the Extender units.

Check system grounding.

If this is a persistent problem, contact Technical Support.

---

***Jitter is evident on video.***

Adjust the clock and/or phase on your flat-panel. Contact Technical Support if this fails to improve the situation.

Are you testing a system using a coiled drum of CATx cable? Try uncoiling the cable. If this solves the video jitter, you should not have a problem after full installation.

---

---

***I can't select the video mode I need.***

For non-standard resolutions, choose the monitor manually through the operating system, and set to ignore DDC. Contact Technical Support if you have problems selecting your required graphics mode.

---

***Can the extender be used with RGB video?***

Yes.

## **4.2 USB**

---

***Why does the Extender stop working when I attach a USB hub to the Remote unit?***

If additional USB hubs are attached to the extender, the maximum extension distance will be reduced (due to the delay imposed by each hub). For each connected hub, you may lose up to 10m of extension distance. Any USB device to which additional USB peripherals may be attached is a USB hub (e.g. an Apple® USB keyboard).

---

***Will the USB Micro Extender work with USB 2.0?***

The extender will operate perfectly through USB 2.0 Host Controllers. However, the speed will be restricted to that of a USB 1.1 hub (12Mb/s). Devices that are USB 2.0 compliant will operate if they are backwards compatible with USB 1.1. If you have a device that demands the high-speed mode of USB 2.0 then it will not be compatible with the USB Micro Extender.

---

***Is the USB Micro Extender compatible with all USB devices?***

This product range extends the distance at which USB peripherals may be operated by making full use of the bus timeout period allowed by the USB protocol. The extender should be compatible with the majority (but not all) of CPU USB Host Controllers and USB peripherals on the market.

---

***Extended USB devices are unstable and 'drop out'.***

Check that the interconnect cable is not routed near power lines or other sources of electrical interference. Use shielded STP/FTP cable instead of UTP cable and ensure the shield connection is maintained between the Extender units. Check system grounding.

The extension distance is too great for your CPU/USB device combination. Try reducing the interconnection cable length if possible.

---

***Some of my USB devices do not operate over the full range.***

The maximum extension range is nominally 150ft (50m). In practice, the maximum distance achievable may be between 120ft (40m) and 180ft (60m) depending on your system and USB devices. Adding external USB hubs may decrease the maximum extension distance by up to 30ft (10m) for each hub added. Adding bus-powered hubs in front of the Local Unit is not recommended.

## 4.3 Audio

---

*The audio is very quiet.*

The audio I/O is line-level and requires amplified speakers and connection to devices providing line-level I/O.

---

*The audio is loud but distorted.*

Check that the audio input is not greater than line level (4V peak-to-peak). The USB Micro Extender accepts line-level audio input only.

---

*The microphone output is barely audible.*

See **Appendix C: Audio/Serial Ports**, page 33.

## 4.4 Serial

---

*My serial device does not function.*

The extender supports serial devices at data rates not exceeding 19.2K Baud (although 38.4K operation might be possible with certain equipment).

Check the type of flow control used by the device and CPU. The extender supports RTS, CTS, DTR, and DSR. Some systems may require a wiring adapter to transfer RI and DCD.

Attach the device directly to the serial port on the PC and test whether the problem is a PC or extender problem.

Some serial devices cannot be hot-plugged. Try connecting the device to a powered Remote unit prior to booting the system.

## 4.5 General Questions

---

### *The green power LED is not lit when I connect my Local Unit to my USB hub.*

Local Units normally take power from the USB connection to the computer. Local Units may require an external 5V PSU:

- If the CPU/hub cannot provide sufficient power through the USB connection.
- For video only applications.

Contact Technical Support for details of a suitable PSU.

---

### *Is it possible to use a cable length longer than 150ft (50m)?*

The maximum extension distance is nominally 150ft (50m). Some systems may extend up to 180ft (60m) and others only 120ft (40m). Once the system range limit is reached, USB operation will cease or become erratic. For maximum extension distance, avoid connecting additional USB hubs to the system.

---

### *Which interconnection cable is best?*

In electrically 'quiet' environments, UTP cable will give the best quality video over long distances because it has less capacitance per unit length. However, it is more prone to electrical noise and interference. In environments where this is likely to be a problem, use STP/FTP cable, ensuring that the shield connection is maintained between the Extender units.

---

### *Can I use CATx patch cables?*

Yes, but to ensure maximum data integrity, use as few as possible. The maximum patch cable length at each end of the link should be limited to 9ft (3m).

---

### *Can the extender system be used between buildings?*

No. Ground loops could damage the extender system and attached equipment.

---

### *Can multiple Local/Remote Units be used by swapping the interconnection cable?*

Local units provide a transparent USB link, so it is possible to swap or switch the Local-Remote interconnection to create a matrix-switch system. Please call Technical Support before deploying such a system.

---

### *Can the extender be connected into our network?*

**Absolutely not.** Regardless of the cable similarities, the data signals and voltages used by the extender are different to those used by Ethernet and other types of networks. Connecting the extender to a LAN hub, switch, repeater, or other network device, or exposing it to the signal levels present on network data lines may damage the extender and other devices.

---

## Appendix A: Example Applications

This section illustrates three specific applications using USB Micro Extender units:

- Simple system using ACU4001A to provide remote console with extended USB keyboard, mouse and printer (Figure 6). Audio extended by USB using USB-to-Audio converter at the Remote Unit (not included).
- Dual-monitor consoles with serial and audio extension (Figure 7). Analog audio extended without USB conversion using Interconnect 2 and monitor 2 at Remote console is a serial touch screen. Uses ACU4222A.
- ACU4222A configured for home entertainment system with extension of USB devices (remote control, game pad, keyboard and mouse) and video (Figure 8). Use of USB Micro Extender allows clutter and noise of CPU to be removed from viewing area.

For more specific information about these, or any other complex applications, please discuss suitable extension architecture with Technical Support.

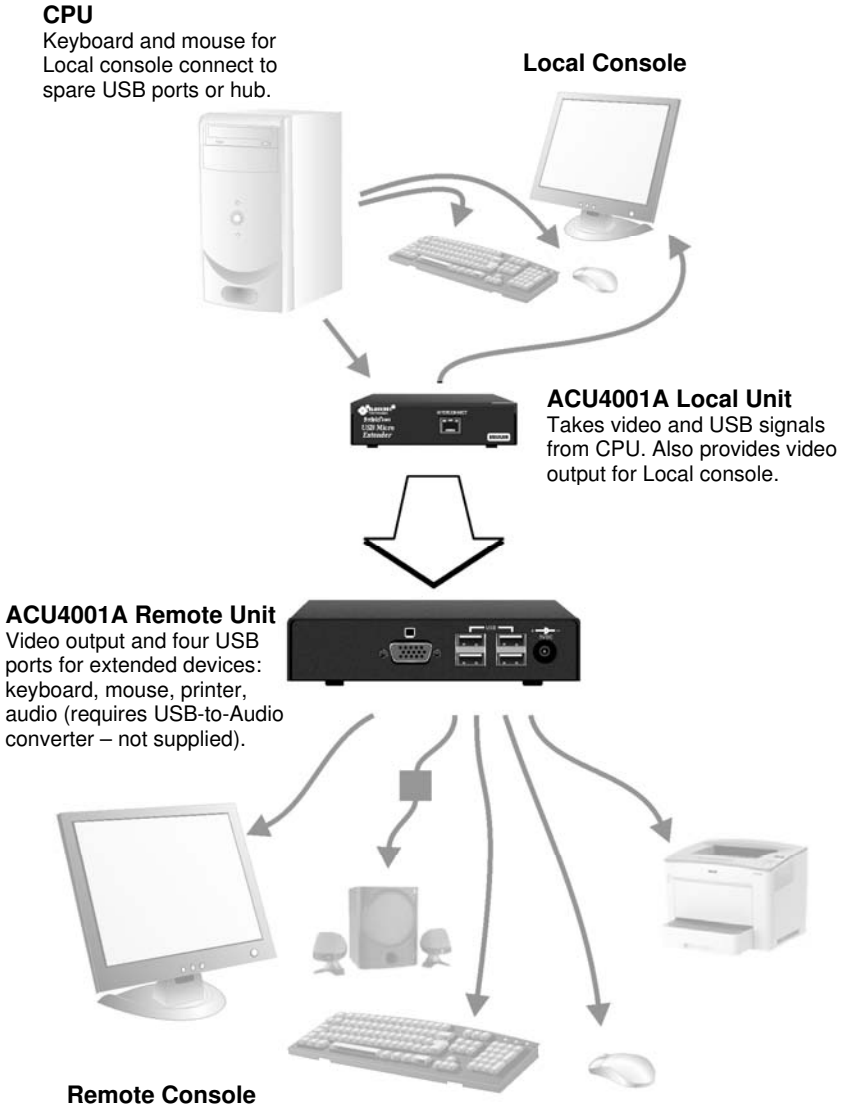

**Figure 6**

**Single monitor consoles with audio extension using USB-to-Audio converter (not supplied)**

# SERVSWITCH™ BRAND USB MICRO EXTENDER FAMILY

### CPU

Keyboard and mouse for Local console connect to spare USB ports or hub.

### Local Console

Dual monitor console.

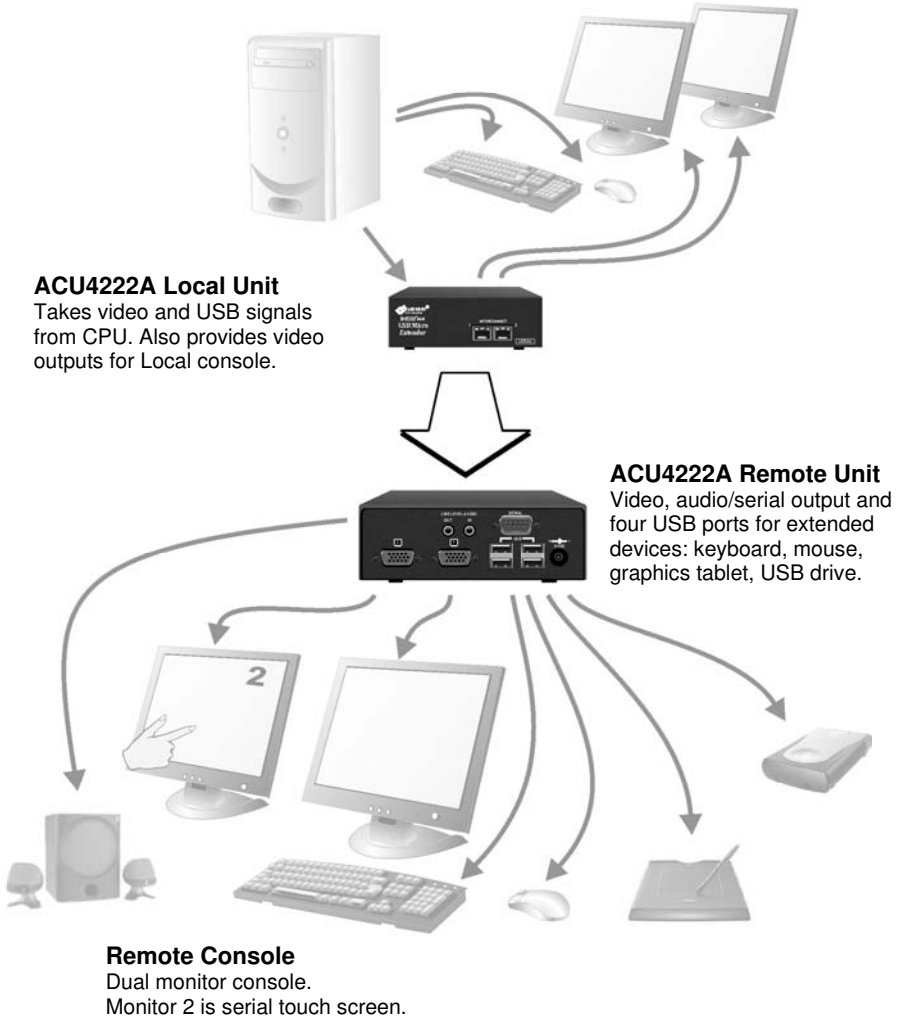
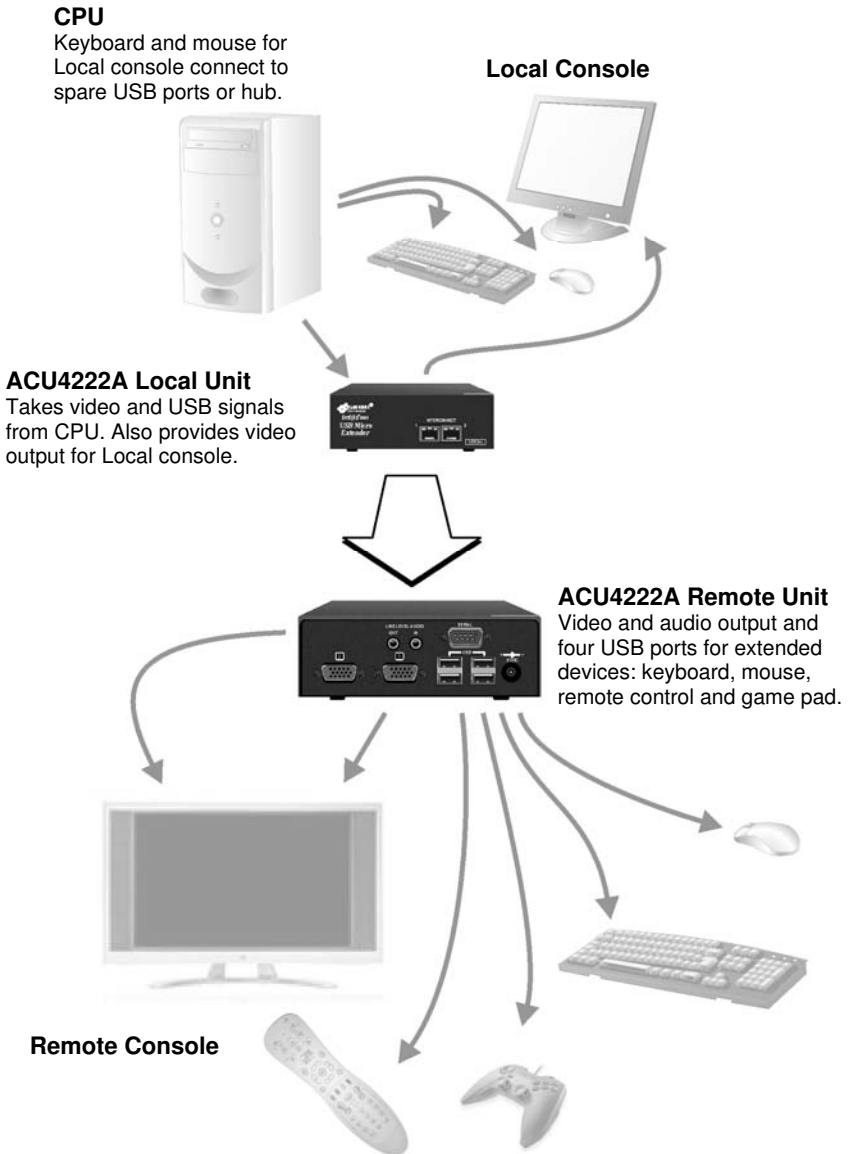

Figure 7

Dual-monitor consoles with serial and audio extension



**Figure 8** Home entertainment system



## Appendix B: Rack Mount Options

All USB Micro Extender units can be mounted in a 19" rack in any combination using the mounting kit: RMK19U-X3

### RMK19U-X3 Mounting Kit

This mounting kit allows you to mount up to three units across 1U. It contains one rack plate and M3 countersunk mounting screws.

To mount a unit:

1. Remove the feet from the extender unit.
2. Align the holes on the base plate with the vacant screw holes on the base of the extender unit.
3. Fasten the base of the unit to the plate of the mounting kit using the supplied screws.

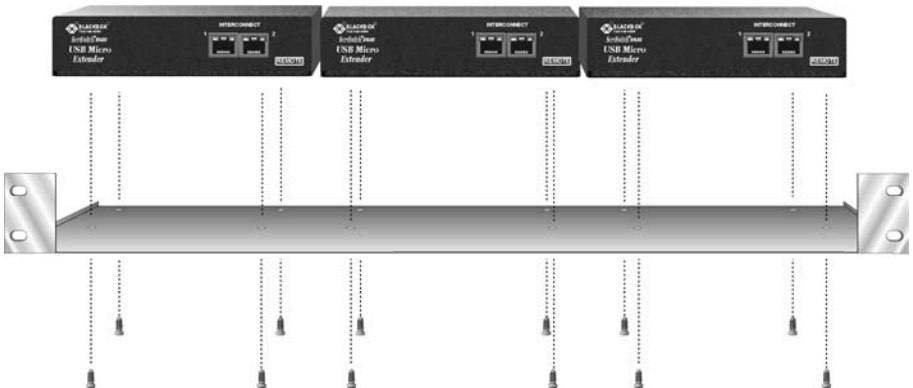

**Figure 9** RMK19U-X3 Mounting Kit

# Appendix C: Audio/Serial Ports

## Operation & Multi-Port Configuration

This appendix describes audio & serial interface operation for ACU4222A.

This extender allows bi-directional stereo audio and a full-duplex serial data to be sent across the secondary CATx interconnection cable.

## Serial Interface - Set Up and Operation

No setting up or user adjustments are required.

The Remote unit's serial port is wired as DTE - the same as that on a PC. To connect a serial printer or other DTE (rather than DCE device) to the Remote unit, you will need a Null-Modem crossover cable between the Remote unit and the printer. Select Xon/Xoff software flow control on the printer and PC.

A serial touch screen may be plugged directly into the Remote unit.

## Serial Interface – Handling Multiple Serial Devices

The extender's serial interface transmits/receives six signals (3 signals in each direction).

Normally, four of these signals are used for hardware handshaking (in addition to TX & RX). However, because each handshaking line can support signals up to 19,200 Baud it is possible to configure the serial interface to handle up to three simple 2-wire (Tx/Rx only) serial links.

To do this, you will need to construct a custom breakout cable. Please contact Technical Support for further information.

## Audio Interface - Set Up and Operation

The audio interface is line-level and is designed to take the output from a sound card (or other line-level) source and be connected to a set of powered speakers at the other end of the link.

Stereo audio may be transmitted either way across the link (simultaneously).

No setup is required unless a microphone is connected to the Remote unit.

Connect the extender as follows:

- Take the line-level output from your sound card (green connector) and connect to 'Line In' on the Local unit.
- Connect 'Line Out' on the Remote unit to a set of powered speakers.

## Audio Interface – Using a Microphone

A microphone may be plugged into the 'Line In' connector on the Remote unit.

There are two ways of setting up a microphone:

- The Local unit's 'Line Out' connection should normally be wired to the microphone input (Pink) on your sound card. The sound card should then be set up to provide additional amplification (+17dB). This is the preferred connection method.
- Alternatively, the Remote unit itself can provide microphone amplification. To set this, open up the Remote unit and locate the jumper labeled 'MIC' on the daughter board. Connect this jumper across the pins. The Local unit's 'Line Out' connection should then be wired to 'Line In' (Blue) on your sound card.

If your microphone is already amplified, follow the second method but **DO NOT** install the amplification jumper in the Remote unit.

## Appendix D: Calling Black Box

If you determine that your USB Micro Extender is malfunctioning, *do not attempt to alter or repair it*. It contains no user-serviceable parts. Contact Black Box Technical Support at 724-746-5500.

Before you do, make a record of the history of the problem. We will be able to provide more efficient and accurate assistance if you have a complete description, including:

- The firmware-revision level printed on the bottom of the Extender (very important, especially for keyboard and mouse problems); The USB Micro Extender's firmware revision level:  
**Version Number Format: xxSyy/zz**  
**xx** is the hardware revision number  
**yy** is the firmware revision number  
**zz** is the auxiliary revision number.
- The nature and duration of the problem.
- When the problem occurs.
- The components involved in the problem—that is, what type of computers, what type of keyboard, brand of mouse, make and model of monitor, type and make of CATx cable, etc.
- Any particular application that, when used, appears to create the problem or make it worse.
- The results of any testing you've already done.

To solve some problems, it might be necessary to upgrade the Extender's firmware. If this turns out to be the case for your difficulty, our Technical Support technicians will arrange for you to receive the new firmware and will tell you how to install it.

### Shipping and Packaging

If you need to transport or ship your USB Micro Extender:

- Package it carefully. We recommend that you use the original container.
- If you are shipping it for repair, please include the Remote Unit's external power supply. If you are returning it, please include everything you received with it. Before you ship the Extender back to Black Box for repair or return, contact us to get a Return Authorization (RA) number.

## Appendix E: Specifications

### Video

<b>Maximum Resolution</b>	1600x1200@75Hz over 150ft (50m) Operation at higher resolutions/refresh rates may be possible at shorter distances
<b>Video Compatibility</b>	VGA to UXGA, RGB
<b>Video I/O</b>	0.7V P-P
<b>Video Compensation</b>	2-stage
<b>Video Coupling</b>	DC
<b>Sync I/O</b>	Separate/Composite TTL Level Sync Polarity is preserved
<b>VESA DDC</b>	Emulated DDC for each video channel (all standard modes).
<b>Video Input Connectors</b>	HD15 (Male)
<b>Video Output Connectors</b>	HD15 (Female)

### USB

<b>USB Compatibility</b>	Transparent USB 2.0 compliant link (low/full speed only) Extender appears as a self-powered USB 1.1 hub to the CPU. Remote unit contains integral USB 1.1 hub with 4 ports.
<b>Extension Limits</b>	150ft (50m) nominal Maximum distance achievable may vary between 120ft (40m) and 180ft (60m) depending on system. Adding external USB hubs may decrease the maximum extension distance by up to 30ft (10m) for each hub added. Adding bus-powered hubs in front of the Local Unit is not recommended.
<b>Local Unit Connector</b>	USB B Socket
<b>Remote Unit Connectors</b>	4 x USB A Sockets

## Serial Interface

<i>Max Baud Rate Supported</i>	19.2K Baud
<i>Serial Data Format</i>	Transparent
<i>Signals Transferred</i>	TX, RX, RTS, CTS, DTR, DSR
<i>Local Unit Connector</i>	DB9 Female (DCE)
<i>Remote Unit Connector</i>	DB9 Male (DTE)

## Audio Interface

<i>Description</i>	Bi-directional stereo audio link
<i>Transmission method</i>	Digitized virtually CD quality audio (16-bit, 38.4kHz)
<i>Signal levels</i>	Line level (4 Volts Pk-Pk maximum)
<i>Input Impedance</i>	47k $\Omega$
<i>Local Unit Connectors</i>	2x3.5mm stereo jack socket (Line In & Line Out)
<i>Remote Unit connectors</i>	2x3.5mm stereo jack socket (Line/Mic In & Line Out)
<i>Microphone Support</i>	Microphone may be connected to Remote Unit Pullup resistor provides bias for condenser microphone Option to set microphone amplification to +17dB

## Power Requirements

<i>Local Unit</i>	5V at up to 275mA supplied by USB port External PSU may also be connected to 2.1mm DC Jack (Center Positive) Over Voltage Protection: >5.6V Under Voltage Protection: <4.3V
<i>Remote Unit</i>	5V Regulated, 20W, PSU included (certified to all relevant safety standards) Universal IEC Input Connector: 2.1mm DC Jack (Center Positive) Remote unit takes 250mA, remainder available for connected USB devices. Over Voltage Protection: >5.6V

# SERVSWITCH™ BRAND USB MICRO EXTENDER FAMILY

## *Size and Shipping Weight*

---

<i>ACU4001A</i>	Local Unit: 4.7"x4.3"x1.1" (120x110x29mm) Remote Unit: 5.4"x3.9"x1.1" (138x98x29mm) Shipping Weight: 3.3lb (1.5kg)
<i>ACU4201A</i>	Local Unit: 4.7"x4.3"x1.7" (120x110x44mm) (1U) Remote Unit: 5.4"x3.9"x1.1" (138x98x29mm) Shipping Weight: 3.7lb (1.7kg)
<i>ACU4222A</i>	Local Unit: 5.9"x4.3"x1.7" (145x110x44mm) (1U) Remote Unit: 5.4"x3.9"x1.7" (138x98x44mm) (1U) Shipping Weight: 6.6lb (2.0kg)

---

## *Environmental*

---

<i>Operating Temperature</i>	32 to 104°F (0 to 40 °C)
<i>Storage Temperature</i>	-22 to 149°F (-30 to 65 °C)
<i>Relative Humidity</i>	5-90% non-condensing
<i>Chassis Construction</i>	Fully shielded. Black painted steel

---

# NOTES



# NOTES

## Free Manuals Download Website

<http://myh66.com>

<http://usermanuals.us>

<http://www.somanuals.com>

<http://www.4manuals.cc>

<http://www.manual-lib.com>

<http://www.404manual.com>

<http://www.luxmanual.com>

<http://aubethermostatmanual.com>

Golf course search by state

<http://golfingnear.com>

Email search by domain

<http://emailbydomain.com>

Auto manuals search

<http://auto.somanuals.com>

TV manuals search

<http://tv.somanuals.com>