

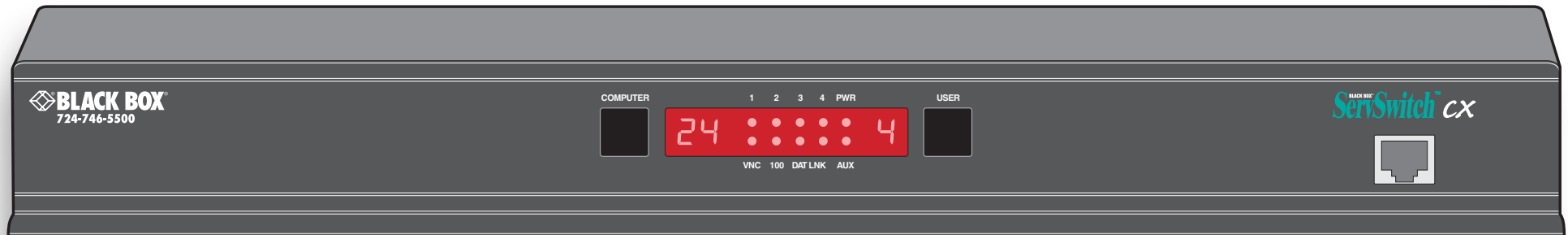

ServSwitch™ CX

USER GUIDE



**CUSTOMER
SUPPORT
INFORMATION**

Order **toll-free** in the U.S.: Call **877-877-BBOX** (outside U.S. call **724-746-5500**)
FREE technical support 24 hours a day, 7 days a week: Call **724-746-5500** or fax **724-746-0746**
Mailing address: **Black Box Corporation**, 1000 Park Drive, Lawrence, PA 15055-1018
Web site: www.blackbox.com • E-mail: info@blackbox.com

CONTENTS

Contents



Introduction

ServSwitch CX features - front and rear.....	5
What's in the box.....	6
What you may additionally need.....	6

Installation

Mounting.....	7
Connections.....	8
Local user.....	9
Remote user (via CX Remote extender).....	10
Global user (IP network port).....	11
Server system (via SAM).....	12
Modem/ISDN port.....	13
Power in connection.....	14
Power control port.....	15
Cascading multiple units.....	16
How cascade connections operate.....	17
Addressing servers in a cascade.....	18
Connecting ServSwitch CX units in cascade.....	19
Using cascaded servers.....	20
Testing specific links to cascaded servers.....	20
Multiple video head connections.....	21

Configuration

Overall initial configuration.....	22
Configuration menus.....	23
Configuration menus layout.....	24
General security and configuration steps.....	24
Registering users (edit user list).....	25
Registering servers (edit computer list).....	26
Video compensation.....	27
Server video compensation.....	28
Remote user video compensation.....	29
Remote user skew adjustment.....	30
Autoscanning.....	32
Saving and restoring configuration settings.....	33
What to do if the ADMIN password has been forgotten...	34
Hot plugging and mouse restoration.....	35
Initial IP configuration.....	36
IP configuration by global user.....	37
Encryption settings.....	38
Networking issues.....	39
Positioning ServSwitch CX with IP in the network.....	39
Placing ServSwitch CX with IP behind a router or firewall	40
Placing ServSwitch CX with IP alongside the firewall....	42
Power switching configuration.....	43
The KVMADMIN utility.....	44
Performing upgrades.....	45
Upgrading ServSwitch CX models and SAMs.....	45
Upgrading ServSwitch CX with IP models.....	47

INSTALLATION



CONFIGURATION

OPERATION

FURTHER INFORMATION

INDEX

Operation

The front panel controls	48
ServSwitch CX models	48
ServSwitch CX with IP models	48
Accessing the ServSwitch CX.....	48
Local and remote user access.....	49
Selecting a server	49
Logging in and out	52
Selecting cascaded servers.....	52
The confirmation box	52
The reminder banner.....	53
Routing status	53
Power switching (via configuration menu).....	54
User preferences and functions	54
Global user access.....	55
Global user access via VNC viewer	56
Global user access via web browser.....	57
Using the viewer window	58
The menu bar	58
When using the viewer window	58
Mouse pointers.....	59
Configure.....	59
Auto calibrate 	60
Re-synchronise mouse 	60
Access mode - shared/private	60
Power switching (via viewer).....	60
Controls.....	61
Access via dial up (modem or ISDN) link.....	64
If you need to enter a port number.....	64
Viewer encryption settings.....	65
Supported web browsers.....	65

Further information

Getting assistance.....	66
Troubleshooting	66
Appendix 1 – Configuration menus	67
Functions	68
User Preferences	69
Global Preferences.....	70
Setup Options	72
Advanced Options	74
Configure IP port	75
Unit Configuration.....	75
Network Configuration	76
Modem Configuration.....	77
Reset Configuration	77
Clearing IP access control	78
Appendix 2 - Configuration pages via viewer	79
User accounts	80
Unit configuration	81
Advanced unit configuration	82
Time & date configuration.....	83
Network configuration.....	84
Setting IP access control.....	85
Serial port configuration.....	86
Host configuration.....	87
Port Direct	88
Logging and status	89



INSTALLATION

CONFIGURATION

OPERATION

FURTHER INFORMATION

INDEX

Appendix 3 - VNC viewer connection options	90
Colour/Encoding	90
Inputs	91
Scaling	92
Misc	92
Identities	93
Load / Save	93
Appendix 4 - VNC viewer window options	94
Encoding and colour level	95
Appendix 5 - Browser viewer options	95
Inputs	95
Security	95
Misc	95
Appendix 6 – Addresses, masks and ports	96
IP addresses	96
Net masks	96
Net masks - the binary explanation	97
Calculating the mask for IP access control	98
Ports	99
Security issues with ports	99

Appendix 7 – Cable and connector specifications	100
RS232 serial mouse to PS/2 converter cable	100
RS232 serial flash upgrade cable	100
ServSwitch CX to power switch cable	100
Power switch to power switch daisy chain cable	100
Multi-head synchronisation cable	101
Appendix 8 – Hotkey sequence codes	102
Permissible key presses	102
Creating macro sequences	102
Appendix 9 – Supported video modes	103
Safety information	104
End user licence agreement	105
Radio Frequency Energy	106
FCC requirements for telephone-line equipment	107
Certification notice for equipment used in Canada	107
Normas Oficiales Mexicanas (NOM) electrical safety statement	108
Instrucciones de seguridad	108
BlackBox subsidiary contact details	113

Index



INSTALLATION

CONFIGURATION

OPERATION

FURTHER
INFORMATION

INDEX

Introduction



Thank you for choosing the ServSwitch CX series from Black Box. Each of the four models have been designed to take full advantage of CATx structured cabling (*where x means category 5, 5e or 6*) to provide high quality linking plus ultimate flexibility for installers and operators alike.

At its heart the ServSwitch CX is a tried and trusted digital KVM + audio switch with 16 or 24 ports. In its simplest form, the ServSwitch CX allows up to four users to maintain full control over multiple host systems.

This description, however, is far from sufficient to tell you that those four users can easily be situated up to 300m (980 feet) from the unit, using ServSwitch CX Remote extenders. It also does not tell you that, thanks to our unique SAM (Server Access Module) technology, the host systems can themselves be up to 50m (160 feet) from the unit. In both cases CATx structured cabling provides neat, easy-to-manage and cost effective linking. The 16- or 24- ports of the standard units are by no means the limit. By cascading one or more ServSwitch CX units you can easily control up to 512 host servers.

The ServSwitch CX with IP variants introduce true global control for the multiple host systems. Up to four global users can share access to a server from anywhere via an IP network/internet connection using a Real VNC client application. A modem/ISDN port provides an alternative backup connection should the network link suffer a failure. Optional power switch control allows you to remotely perform a hard reset on any host system, no matter how badly it has locked up. Finally, to ensure that only authorised operators are given such power, the ServSwitch CX with IP units feature enterprise grade security.

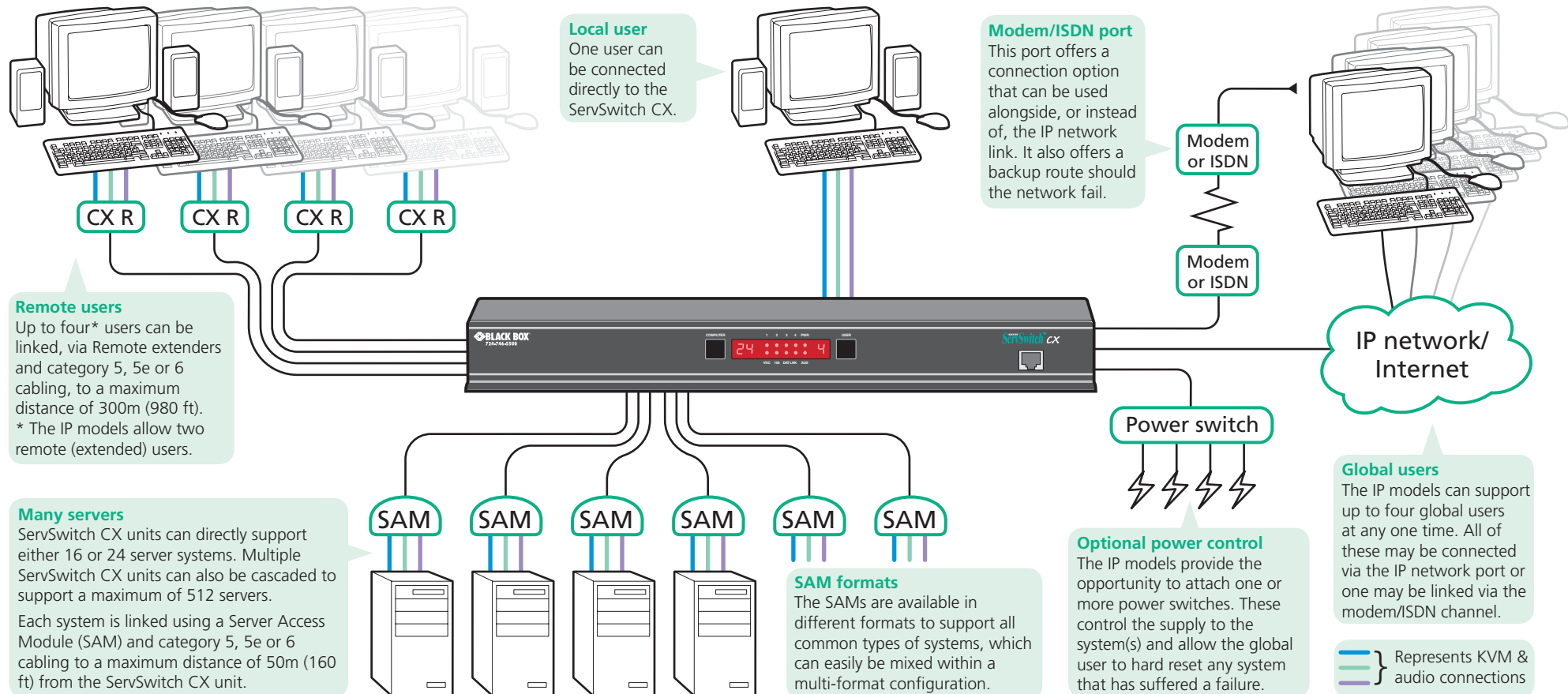

- INSTALLATION
- CONFIGURATION
- OPERATION
- FURTHER INFORMATION
- INDEX

ServSwitch CX features - front and rear

The ServSwitch CX units pack a great deal of functionality into a compact space. All models occupy a single 1U rack space and provide most of their connectors at the rear face. The smart front face features the IP network port and the operation indicators.

Front panel buttons

The COMPUTER and USER buttons allow the local user to select the required combination. Adjacent numeric displays show the current selection. Keyboard, mouse and menu-based switching techniques are also available.

IP network port (CX with IP only)

The port by which global users are linked to the ServSwitch CX unit. This intelligent Ethernet port can automatically sense whether it is attached to a 10Mb or 100Mb network.

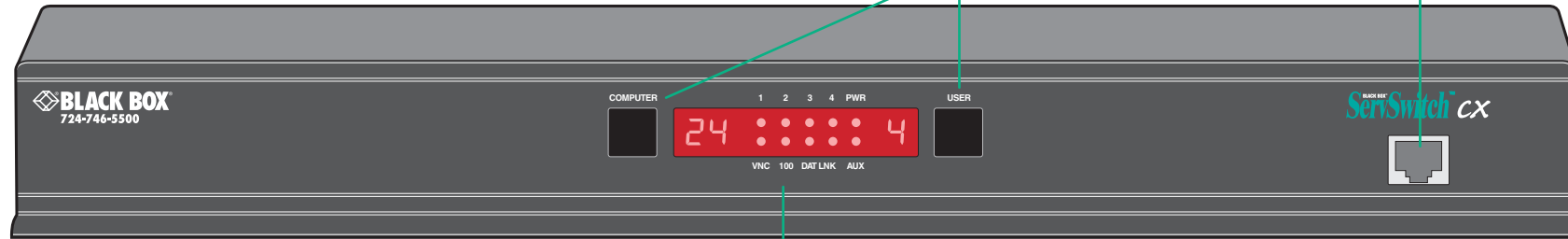

Indicators

The front panel indicators clearly show key aspects of operation (CX and CX with IP models differ):

- **VNC** Indicates that a global user is connected and active.
- **100** Indicates the Ethernet network speed (10/100Mbps).
- **DAT** Network activity indication.
- **LNK** Network link present.
- **PWR** Power input indicator.
- **AUX** Auxilliary power input indicator.
- **1-4** Indicates activity on the four user ports.

Note: The VNC, 100, DAT & LNK indicators are present on ServSwitch CX with IP models only. On non-IP models each user port has an upper (mouse activity) and lower (keyboard activity) indicator.

Power control port

Optionally use this port to control one or more power switches. These allow the remote user to take full control of the server system(s).

Upgrade port

This port is used to update (when necessary) the internal firmware of the ServSwitch CX unit.

Modem port (IP models only)

Optionally use this port to attach either a standard modem or an ISDN adapter. This feature provides an alternative, direct-dial, remote link into the ServSwitch CX with IP models.

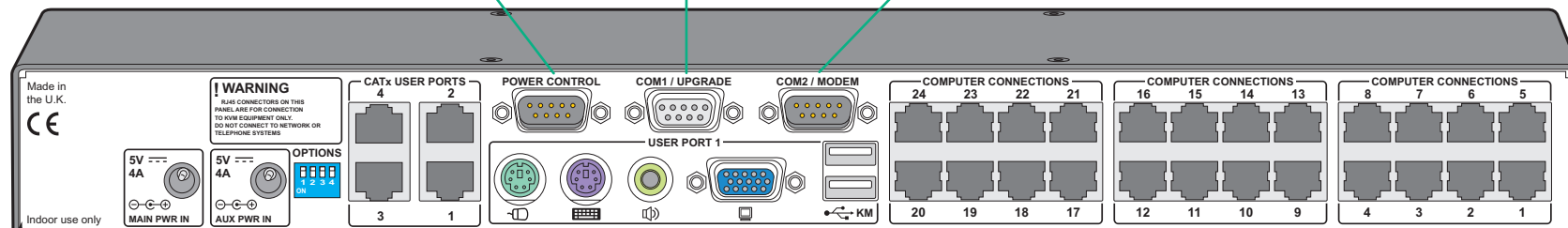

Dual power inputs

The primary and optional auxiliary power supplies connect here.

Remote user ports

Up to four remote users can be connected, using optional ServSwitch CX Remote extenders and standard category 5, 5e or 6 cabling, a maximum distance of 300m (1000ft) from the ServSwitch CX unit. CX with IP models provide two remote user ports.

Local user port

Connect a keyboard and mouse (either PS/2-style or USB), plus a video monitor and optional speakers to these connectors. These allow you to perform the initial configuration of the ServSwitch CX. Additionally, you can use these to locally control the connected server(s).

Server ports

Each server connects to one of these ports via standard category 5, 5e or 6 cabling. At the other end of the cabling a SAM (Server Access Module) is used to provide the necessary keyboard, video, mouse and optional speaker connections.



INSTALLATION

CONFIGURATION

OPERATION

FURTHER INFORMATION

INDEX

What's in the box

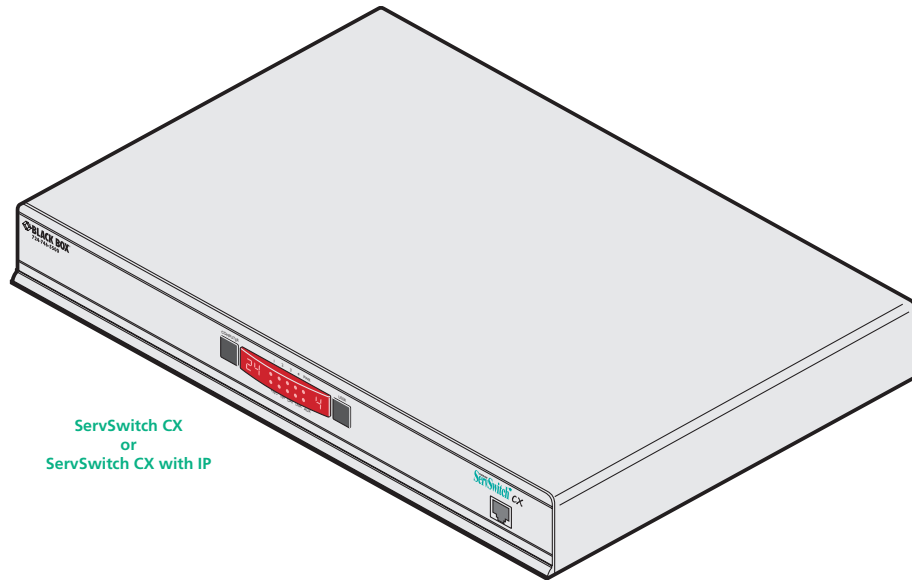

ServSwitch CX
or
ServSwitch CX with IP

ServSwitch CX

KV0416A-R2 – 16 server connections, 1 local console connection, 4 remote user connections
KV0424A-R2 – 24 server connections, 1 local console connection, 4 remote user connections

ServSwitch CX with IP

KV1416A-R2 – 16 server connections, 1 local console connection, 1 IP connection, 2 remote user connections
KV1424A-R2 – 24 server connections, 1 local console connection, 1 IP connection, 2 remote user connections

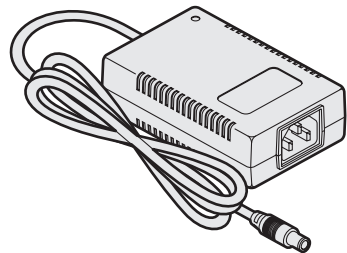

30W power
adapter and
country-specific
power lead

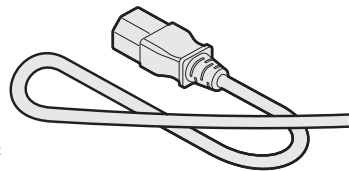

Four self-adhesive
rubber feet

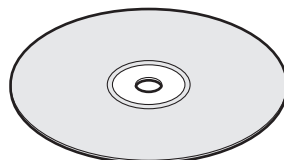

CD-ROM

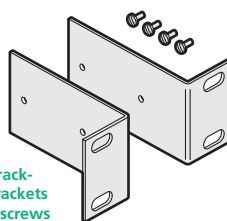

Two 19" rack-
mount brackets
and four screws

What you may additionally need

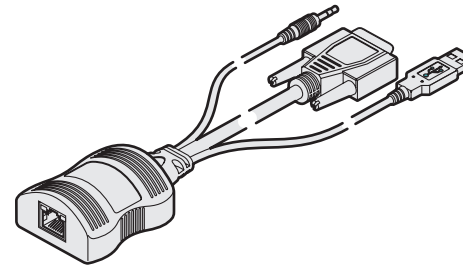

Server Access Modules

One required per connected server. There are five different formats, depending on the required server connections:

PS/2-style

Connectors: Analog video, PS/2-style keyboard and PS/2-style mouse.

Part number: KV1400A

PS/2-style with audio

Connectors: Analog video, PS/2-style keyboard, PS/2-style mouse and 3.5mm audio jack.

Part number: KV1402A

USB

Connectors: Analog video and USB keyboard/mouse.

Part number: KV1401A

USB with audio

Connectors: Analog video, USB keyboard/mouse and 3.5mm audio jack.

Part number: KV1403A

Sun with audio

Connectors: Analog video, Sun keyboard/mouse and 3.5mm audio jack.

Part number: KV1404A

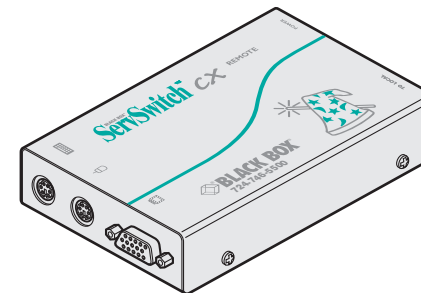

ServSwitch CX Remote extenders

One required per remote user. Three different versions are available - the ServSwitch CX Remote AS/R has audio and video skew circuitry to overcome extreme video degradation problems. The ServSwitch CX Remote A/R lacks the skew circuitry and the ServSwitch CX Remote /R does not have skew circuitry or audio. Each ServSwitch CX remote module is supplied with its own power adapter and country-specific power lead.

ServSwitch CX Remote /R

Connectors: Analog video, PS/2-style keyboard and PS/2-style mouse.

Part number: KV04-REM

ServSwitch CX Remote A/R

Connectors: Analog video, PS/2-style keyboard and PS/2-style mouse and 3.5mm audio jack.

Part number: KV04A-REM

ServSwitch CX Remote AS/R

Connectors: Analog video, PS/2-style keyboard and PS/2-style mouse and 3.5mm audio jack.

Includes additional skew compensation features.

Part number: KV04AS-REM

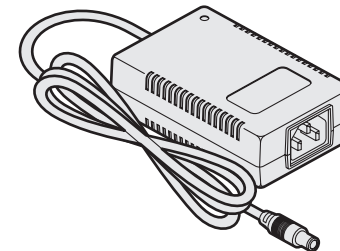

Optional auxiliary power adapter

(supplied with country-specific power lead)
Call Black Box for details.

Slave power switches for connection to ServSwitch CX with IP or master power switch

Part number: PSE508SA (not available in North America)

Master power switch for connection to ServSwitch CX with IP or standalone Ethernet operation

Part number: PSE508MA (not available in North America)



INSTALLATION

CONFIGURATION

OPERATION

FURTHER
INFORMATION

INDEX

Installation



Mounting

The ServSwitch CX units offer two main mounting methods:

- Supplied four self-adhesive rubber feet
- Supplied rack brackets

Connections

Note: The ServSwitch CX units and their power supplies generate heat when in operation and will become warm to the touch. Do not enclose them or place them in locations where air cannot circulate to cool the equipment. Do not operate the equipment in ambient temperatures exceeding 40 degrees Centigrade. Do not place the products in contact with equipment whose surface temperature exceeds 40 degrees Centigrade.

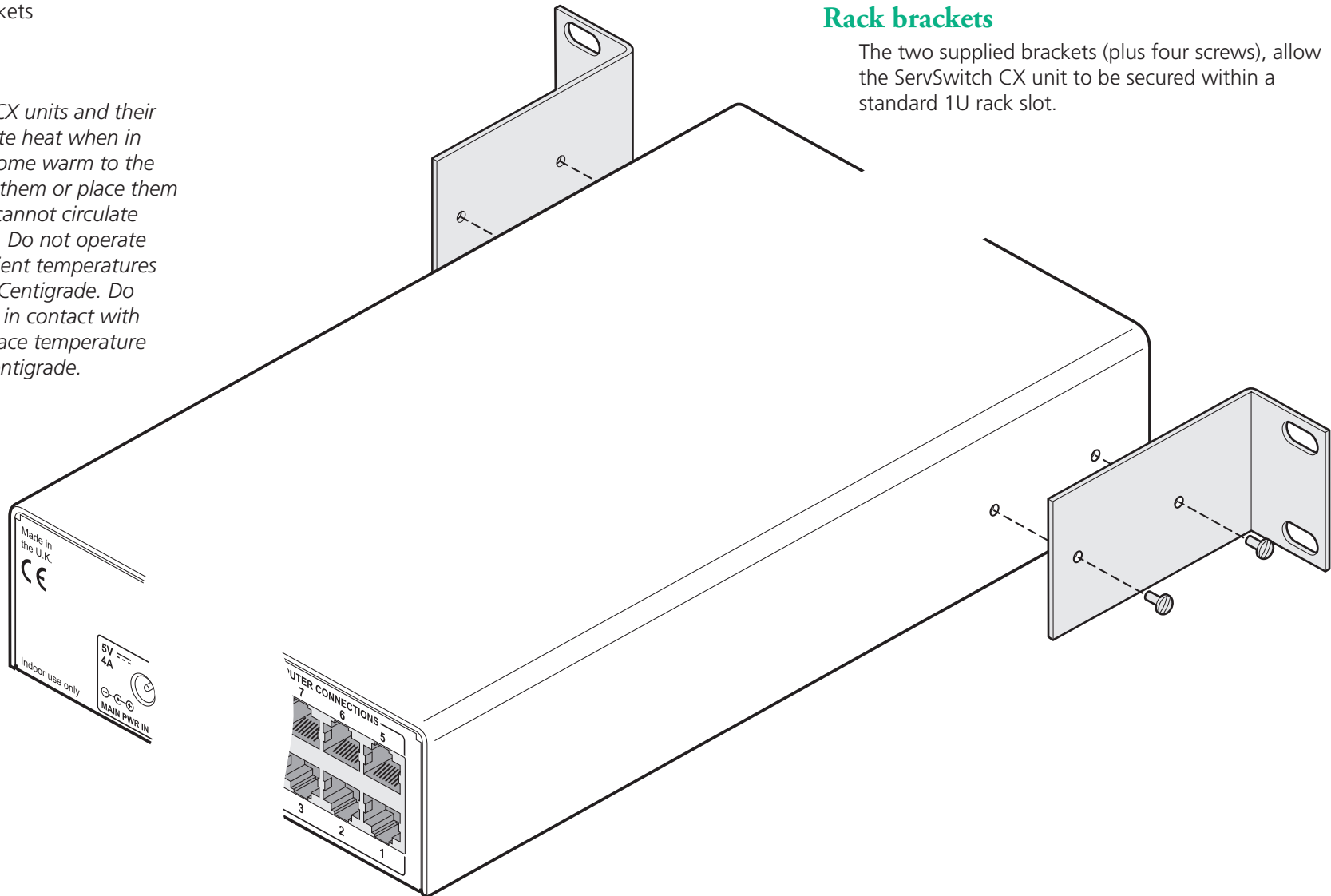

Rack brackets

The two supplied brackets (plus four screws), allow the ServSwitch CX unit to be secured within a standard 1U rack slot.

Connections

The ServSwitch CX and CX with IP units provide a great deal of flexibility in their configurations. This chapter details the various connections that can be made to achieve the required installation.

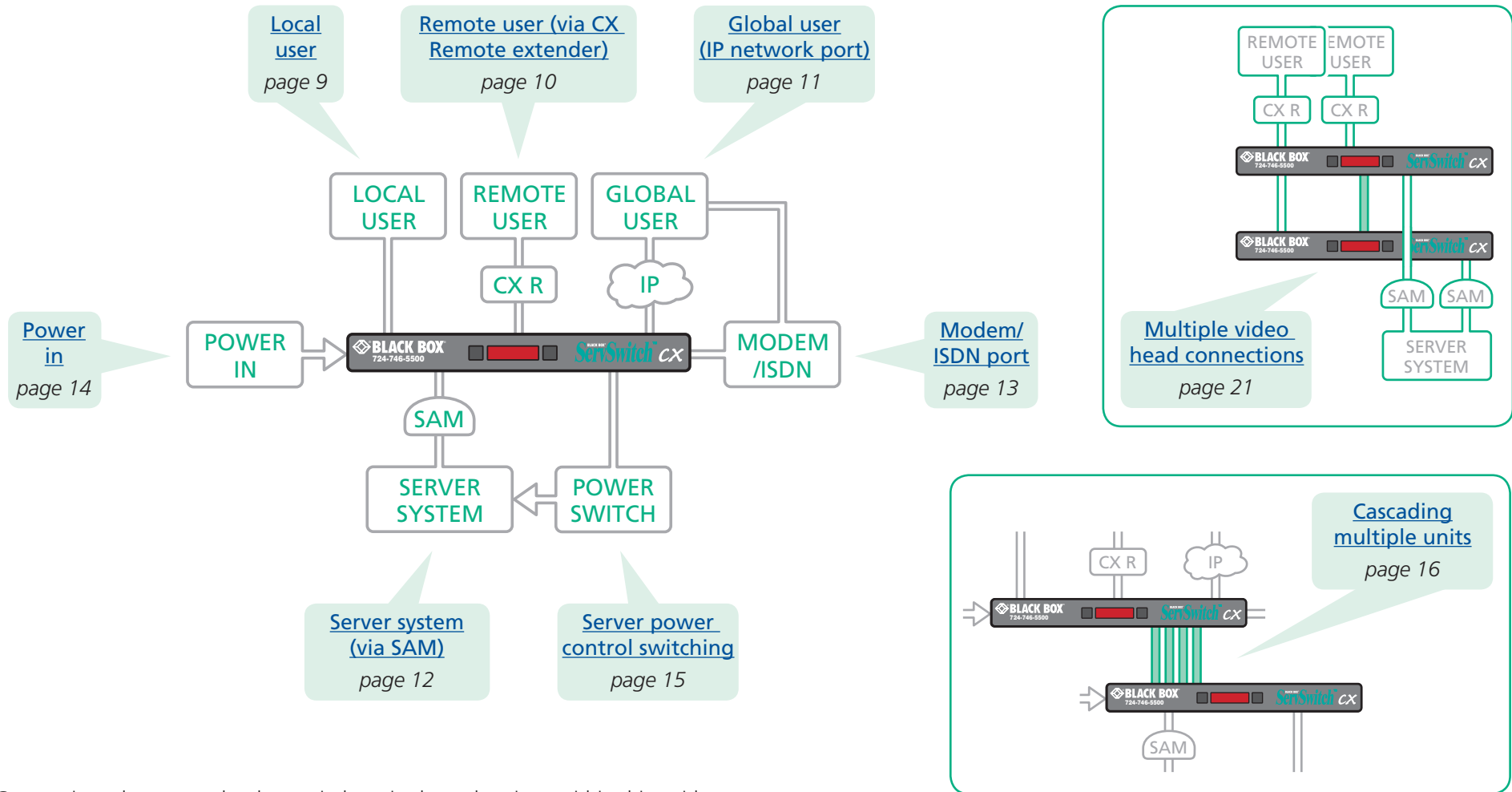

Connections do not need to be carried out in the order given within this guide, however, where possible connect the *power in* as a final step.

- INSTALLATION
- CONFIGURATION
- OPERATION
- FURTHER INFORMATION
- INDEX

Local user

A locally connected video monitor, keyboard (and mouse) are required during the initial configuration. These are also useful during normal use to allow quick local control of any connected server systems. The ServSwitch CX unit can directly support either PS/2 or USB style keyboards and mice. An audio port is also provided for locally connected speakers, if required.

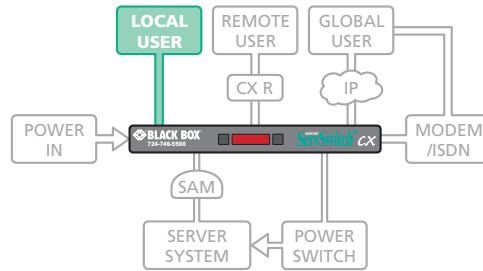

To connect the local user port

- 1 Position a suitable video monitor, keyboard, mouse (and speakers, if required) in the vicinity of the ServSwitch CX unit such that their cables will easily reach.
- 2 Attach the video monitor, keyboard, mouse (and speaker) connectors to the sockets, collectively labelled as USER PORT 1, at the rear of the ServSwitch CX unit.

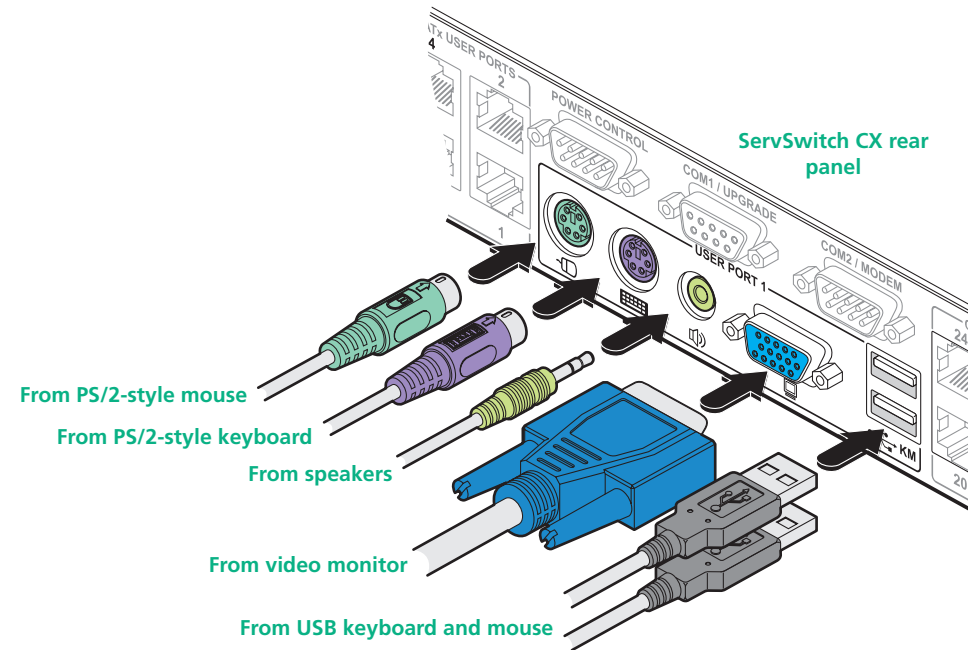

Note: The keyboard and mouse can be either PS/2-style or USB respectively, as required. The two different connection types can even be mixed. Recognition of the type used is automatic and requires no extra settings to be made.



Remote user (via CX Remote extender)

Up to four users can be placed a maximum of 300 metres (980 feet) from the ServSwitch CX unit. Remote users are connected via a ServSwitch CX Remote extender module and suitable category 5, 5e or 6 cabling (with no crossover). The ServSwitch CX with IP models provide two remote user ports.

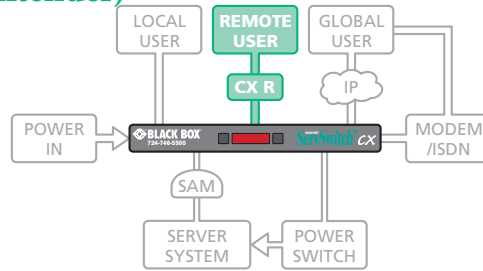

Cable lengths for remote user locations

The maximum length of cable between a remote user and the ServSwitch CX unit can be up to 300 metres (980 feet). However, bear in mind that the overall distance between any remote user and any server system must not exceed 300 metres (980 feet).

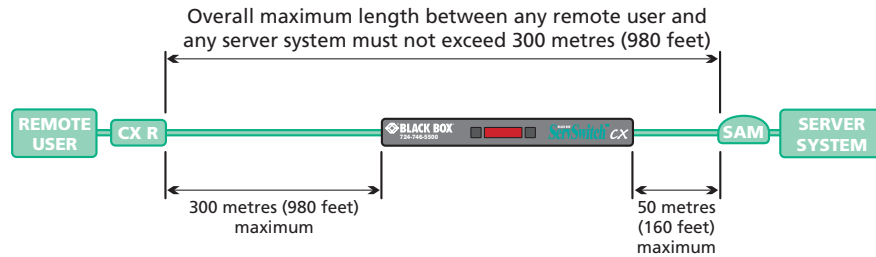

In situations where any server system will be placed a significant distance from the ServSwitch CX unit, ensure that the distance to any remote user is similar less than 300 metres (980 feet).

To connect a remote user

- 1 Place a ServSwitch CX Remote extender unit adjacent to the remote user location.
- 2 Attach the video monitor, keyboard, mouse, power adapter (and speaker) connectors to the sockets of the ServSwitch CX Remote module.

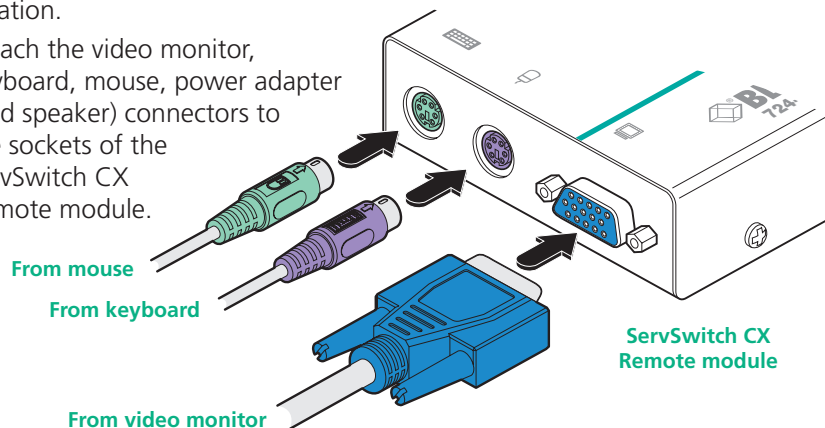

- 3 Lay a suitable length of category 5, 5e or 6 cabling between the ServSwitch CX Remote module and the ServSwitch CX unit. Please refer to the section *Cable lengths for remote user locations* opposite.
- 4 Attach the connector of the cable run to the socket of the ServSwitch CX remote.

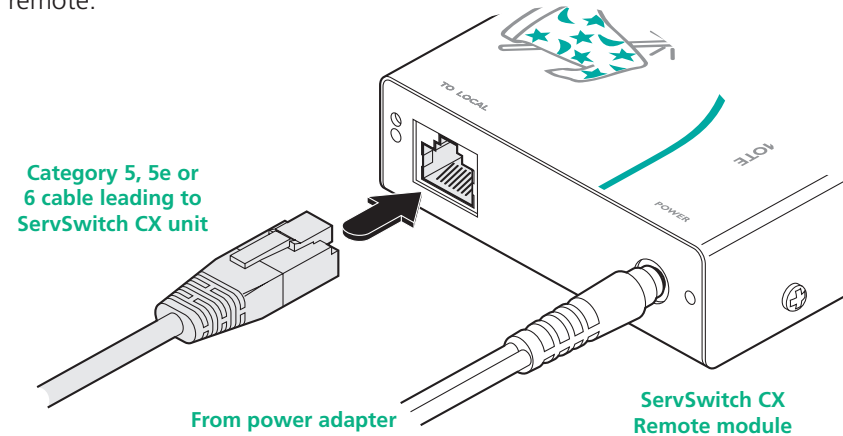

- 5 At the other end of the cable run, attach the cable connector to one of the sockets labelled CATx USER PORTS on the rear panel of the ServSwitch CX unit.

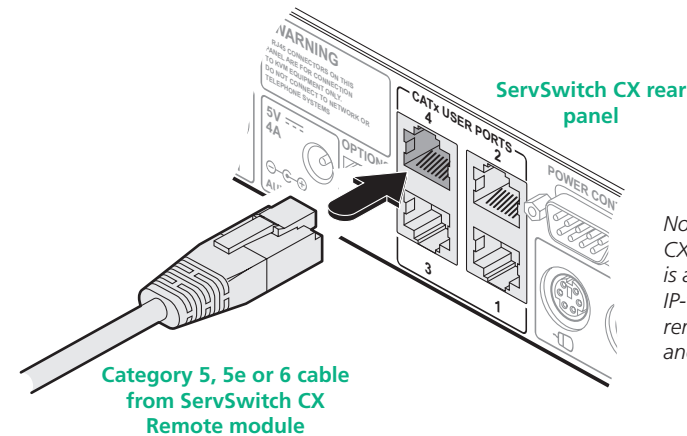

Note: The ServSwitch CX model shown here is a non-IP version. The IP-version provides only remote user ports 3 and 4.

- 6 Where necessary, use the in-built video compensation feature of the ServSwitch CX remote module to eliminate any effects caused by the cable run. However, ensure that the links between the servers and the ServSwitch CX have been compensated first. See [remote user video compensation](#) for details.



Global user (IP network port)

The ServSwitch CX with IP models provide an autosensing Ethernet IP port that can operate at 10 or 100Mbps, according to the network speed. The ServSwitch CX with IP models are designed to reside quite easily at any part of your network:

- They can be placed within the local network, behind any firewall/router connections to the Internet, or
- They can be placed externally to the local network, on a separate sub-network or with an open Internet connection.

Wherever in the network a ServSwitch CX with IP is situated, you will need to determine certain configuration issues such as address allocation and/or firewall adjustment to allow correct operation. Please refer to [Networking issues](#) within the Configuration chapter for more details.

IMPORTANT: When a ServSwitch CX with IP is accessible from the public Internet or dial up connection, you must ensure that sufficient [security measures](#) are employed.

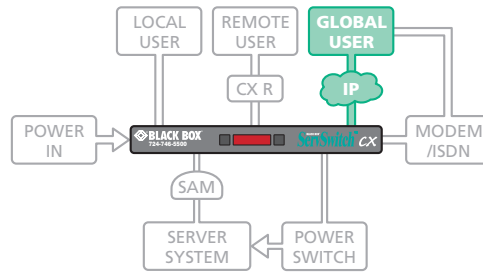

To connect the Global user (IP network) port

- 1 Depending upon where in the network the ServSwitch CX with IP is being connected, run a category 5, 5e or 6 link cable from the appropriate hub or router to the ServSwitch CX with IP unit.
- 2 Connect the plug of the link cable into the IP port on the front panel of the ServSwitch CX with IP unit.

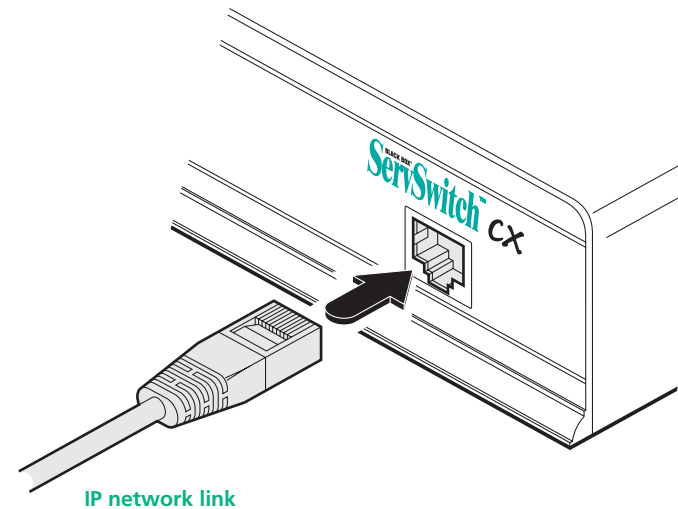

- 3 Configure the network settings as appropriate to the position of the ServSwitch CX with IP within the network - see [Networking issues](#) for details.



Server system (via SAM)

Each server system is connected to the ServSwitch CX unit via a Server Access Module (SAM) and standard category 5, 5e or 6 cabling. SAMs are available in various formats to suit differing server system types and their particular connector styles.

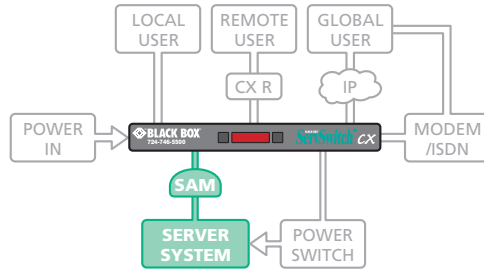

To connect a server system

- 1 Ensure that power is disconnected from the ServSwitch CX unit and the server to be connected.
(Note: If it is not possible to switch off devices prior to connection, then a 'Hot plug' procedure is available – see the [Hot plugging and mouse restoration](#) section for more details).
- 2 Locate the required SAM (there are five types available) and attach its video, keyboard and mouse (PS/2-style, USB or Sun) and optional audio connectors to the relevant sockets on the server system.

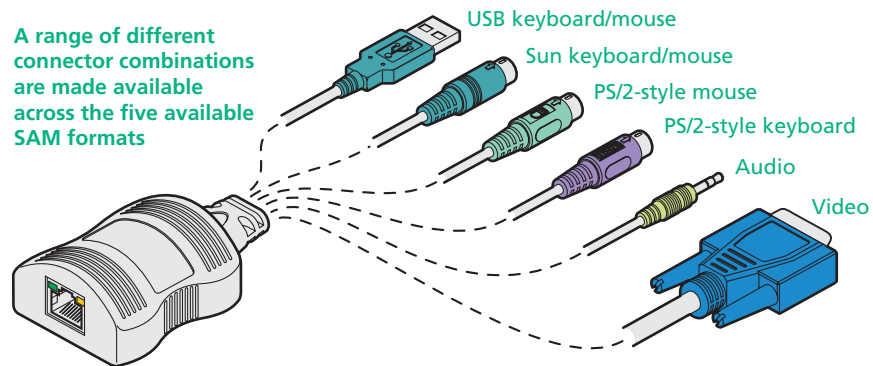

- 3 Lay a suitable length of category 5, 5e or 6 cabling between the server system and the ServSwitch CX unit. The maximum length of the cable can be up to 50 metres (160 feet), however, bear in mind that the overall distance between any remote user and any server must not exceed 300 metres (980 feet).

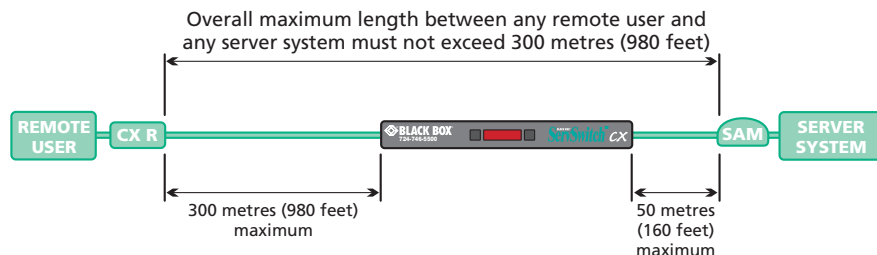

- 4 Attach the connector of the cable run to the socket of the SAM.

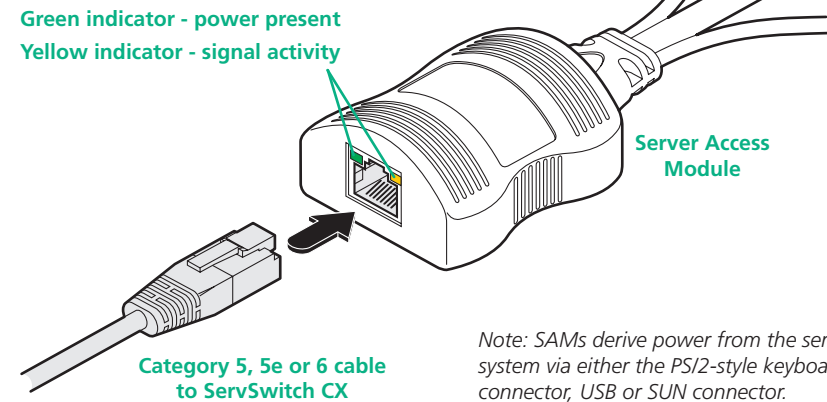

- 5 At the other end of the cable run, attach the cable connector to one of the sockets labelled COMPUTER CONNECTIONS on the rear panel of the ServSwitch CX unit.

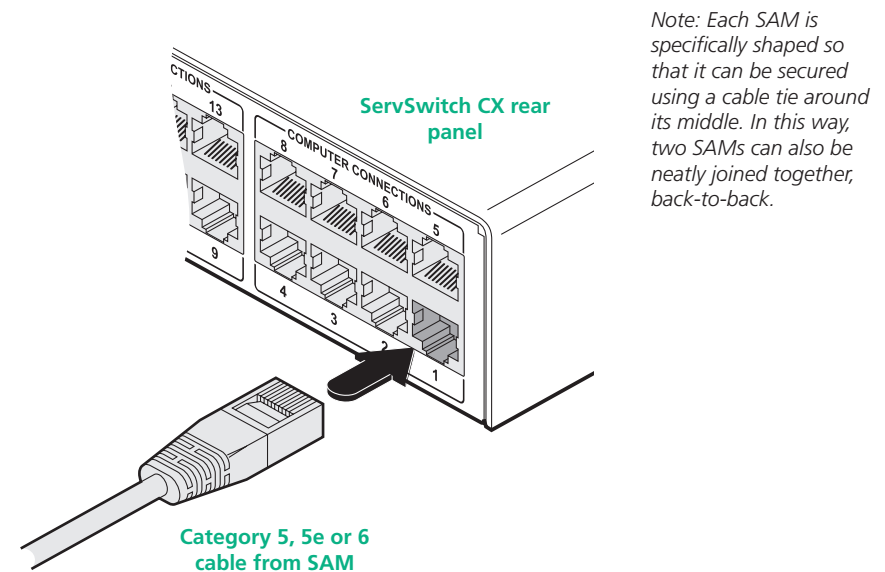

- 6 Where necessary use the in-built video compensation feature of the ServSwitch CX unit to eliminate any effects caused by the cable run. See [Server video compensation](#) for details.



INSTALLATION

CONFIGURATION

OPERATION

FURTHER INFORMATION

INDEX

Modem/ISDN port

The ServSwitch CX with IP models provide a serial port to allow you to connect either a modem or ISDN terminal adapter. This can be used as a primary, secondary or backup access port for global users, as best suits your overall configuration.

IMPORTANT: When the ServSwitch CX with IP is accessible from the public Internet or dial up connection, you must ensure that sufficient [security measures](#) are employed.

Note: On non-IP models, the COM2/MODEM port is reserved for the support of future features.

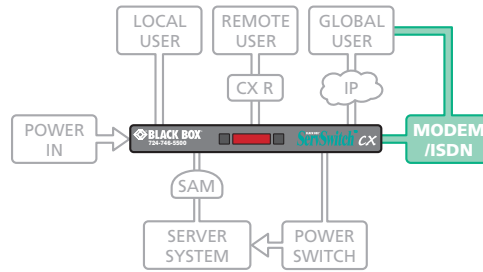

To connect a modem or ISDN adapter

- 1 If possible, disconnect power from the ServSwitch CX with IP and the modem or ISDN adapter.
- 2 Connect a suitable serial modem (non-crossover) cable to the serial port on the modem/ISDN adapter.
- 3 Connect the other end of the serial cable to the port labelled COM1 at the rear of the ServSwitch CX with IP.

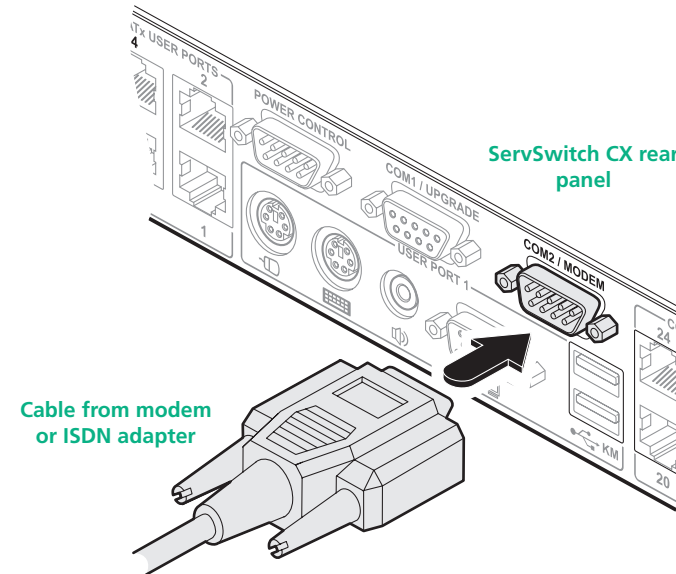

Note: The default serial port speed is 115200 and a standard Hayes-compatible auto-answer string is sent during startup. The default startup string is 'ATZHS0=1'. Both the serial port speed and startup string settings can easily be altered during configuration - see [Initial IP configuration](#) for more details. The other serial settings are fixed at: No parity, 8 bit word and 1 stop bit.



Power in connection

The ServSwitch CX unit is supplied with a single 30W power adapter which is sufficient to supply any configuration of the unit. All ServSwitch CX units have two power input sockets to allow auxiliary (redundant) power adapters to be connected. There are no on/off switches, so operation begins as soon as a power adapter is connected.

Note: ServSwitch CX units require a heavy duty power adapter at either or both power input connectors. Use only the adapter supplied with the unit or available separately from Black Box. Do not use the standard 10W adapters that are supplied with other Black Box products, such as the ServSwitch CX Remote module.

To connect the power supply

- 1 Attach the output lead from the power adapter to the MAIN PWR IN socket on the rear panel of the ServSwitch CX.

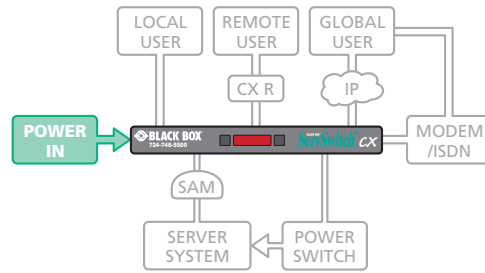
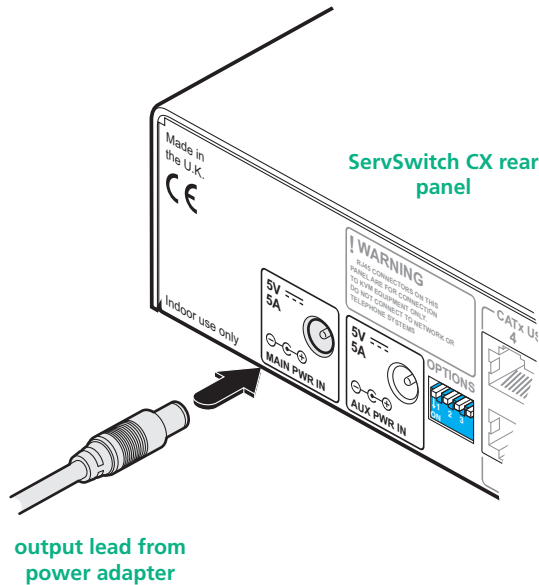

- 2 Connect the IEC connector of the supplied country-specific power lead to the socket of the power adapter.

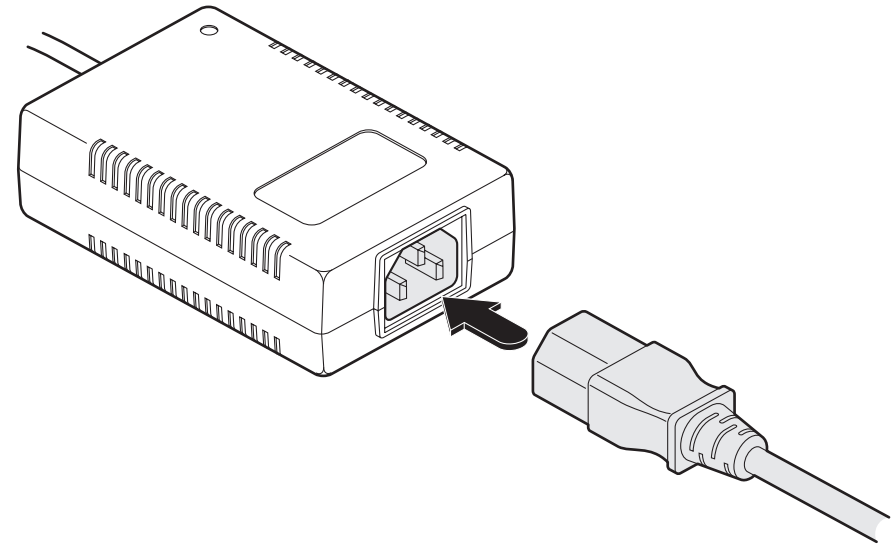

- 3 Connect the power lead to a nearby main supply socket.
- 4 Repeat steps 1 to 3 for the auxiliary power adapter (using the AUX PWR IN socket), if a backup supply is required.

Note: Both the ServSwitch CX and its power supply generate heat when in operation and will become warm to the touch. Do not enclose them or place them locations where air cannot circulate to cool the equipment. Do not operate the equipment in ambient temperatures exceeding 40 degrees Centigrade. Do not place the products in contact with equipment whose surface temperature exceeds 40 degrees Centigrade. Using two power supplies will ensure that each power supply takes less load and run at a correspondingly cooler temperature.



Power control port

The ServSwitch CX with IP models provide a serial port for connection to one or more optional power control units. This allows you to control the mains power being supplied to the connected server(s) so that an authorised user can, if necessary, perform a complete remote cold reboot on a failed server.

The control connector of the first power switch is attached, via serial cable, to the rear panel of the ServSwitch CX with IP. Any additional power switches are then attached via a 'daisy-chain' arrangement to the first power switch. Each power switch box is then given a unique address and access to each power port (8 ports on each power switch box) is gained using a combination of the switch box address and the port number.

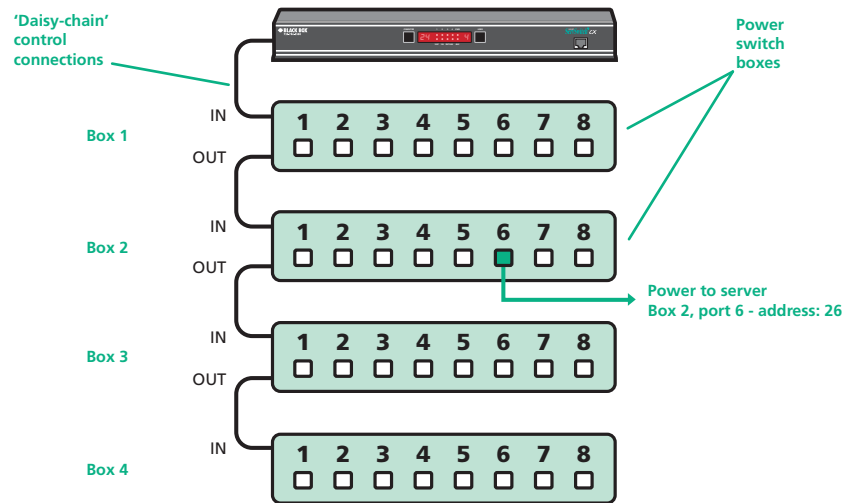

The power ports are connected to the power inputs of each server system and the power switch box(es) are then connected to a mains power supply.

IMPORTANT: Power switching devices have a maximum current rating. It is essential to ensure that the total current drawn by the equipment connected to the power switching device does not exceed the current rating of the power switching device. You must also ensure that the current drawn from any mains socket does not exceed the current rating of the mains socket.

Setting up, configuring and using power switching requires three main steps:

- Connect and address the switch boxes ⇔
- [Configure the power strings](#)
- Operate power switching [via configuration menu](#) or [via viewer](#)

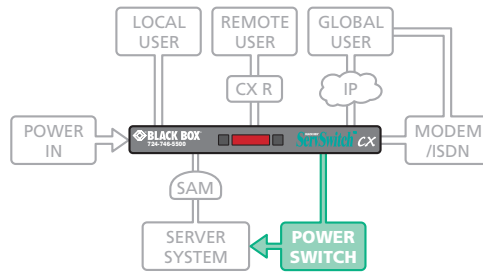

To connect and address the switch boxes

Note: The ServSwitch CX with IP unit can be powered on during this procedure, however, the switch boxes should be switched off.

- 1 Mount up to four switch boxes in positions where they are close to the server systems that they will control and not too distant from the ServSwitch CX with IP unit (preferably within 2.5 metres).
- 2 Use a serial cable with an RJ9 and a 9-pin D-type connector (see [Appendix 7](#) for specification). Attach the RJ9 plug to the socket marked IN on the first switch box. Attach the other end to the socket marked POWER CONTROL on the ServSwitch CX with IP.

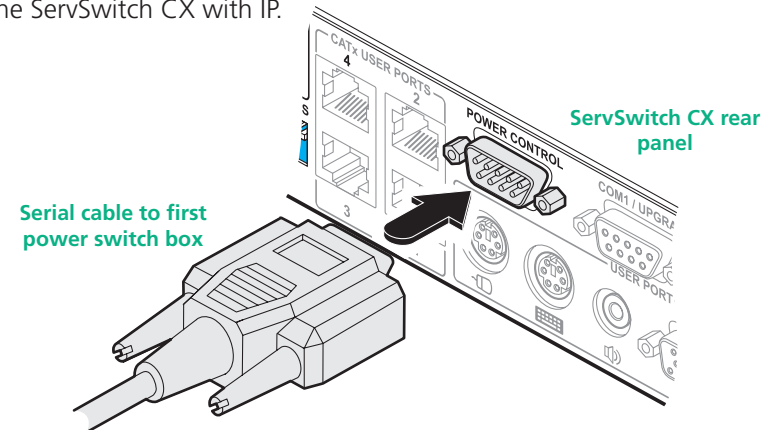

- 3 For each of the remaining switch boxes (if used), use a serial cable with RJ9 connectors at both ends (see [Appendix 7](#) for specification). Attach one end to the socket marked OUT of the previous box and the other end to the socket marked IN of the next box.

- 4 Set the addressing switches on each switch box using the two micro switches marked 'Slct' on the front panel. The box connected directly to the ServSwitch CX with IP is Box 1 and so on, down the daisy-chain line to Box 4 at the end.

Box	Switch 1	Switch 2
1	Off	Off
2	On	Off
3	Off	On
4	On	On

Off = switch upwards
On = switch downwards
Switch 1 is on the left side

- 5 Attach IEC to IEC power leads between each port and the power input socket of each server system that requires power switching. Carefully note to which power ports, on which boxes, each server system is connected. If server systems have multiple power inputs, then each input must be connected via separate ports, which can be on the same, or different boxes.

- 6 Connect each box to a suitable mains power input.

Now proceed to the configuration stage covered in the [Power switching configuration](#) section within the Configuration chapter.



Cascading multiple units

The ServSwitch CX (with IP) units support up to sixteen or twenty four *directly* connected server systems, however, this is by no means the limit. Thanks to an intelligent communication system, called **Port Direct**, many more server systems can be controlled by connecting other ServSwitch CX units. The combination of units can be arranged up to three levels deep forming a tree, or *cascade* arrangement, with server systems situated at any level within that cascade tree.

The maximum number of server systems that can be controlled within a cascade installation depends upon the ServSwitch CX unit placed at the top level. If the top level unit is a non-IP version, a maximum of 512 server systems can be controlled. However, if the top level unit is a ServSwitch CX with IP, the maximum number of servers drops to 128. This is due to the extra burden placed on the unit's memory of administering global (IP) users.

See also

- [How cascade connections operate](#)
- [Addressing servers in a cascade](#)
- [Connecting ServSwitch CX units in cascade](#)
- [Testing specific links to cascaded servers](#)

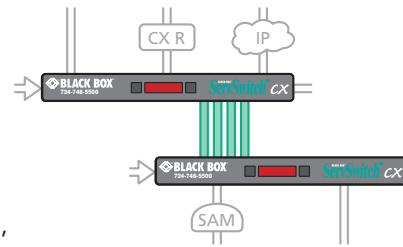

The cascade tree

The diagram shows how multiple ServSwitch CX units can be cascaded up to three levels. Server systems can be connected at any level. Up to four users (local, remote or global) can simultaneously access server systems situated around the cascade tree.

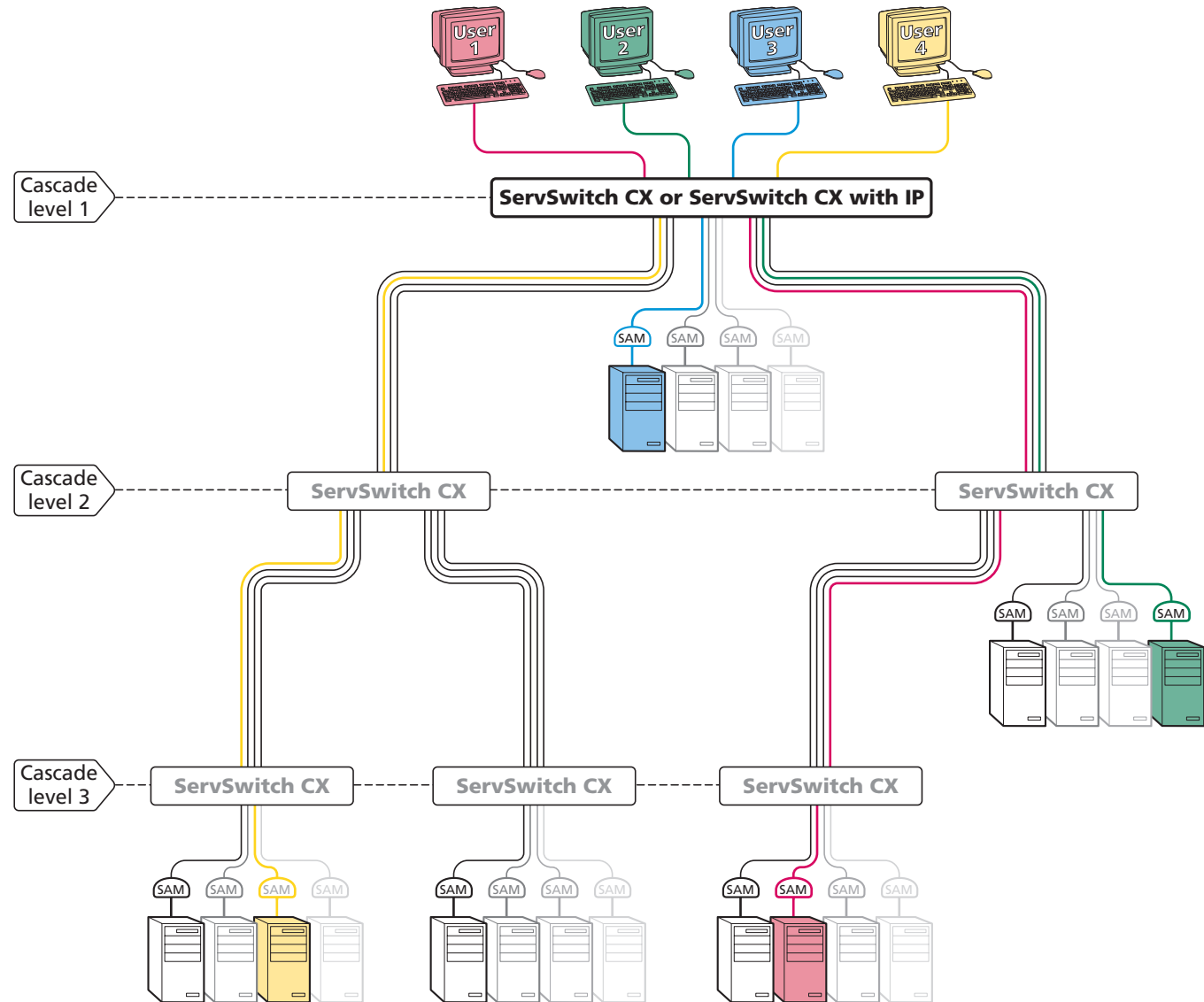



How cascade connections operate

The method for cascading ServSwitch CX units is straightforward and requires no hardware settings or lengthy configuration process. This is due to the [Port Direct](#) communication system that allows them to locate each other and share information.

The method of linking ServSwitch CX units is the same regardless of the cascade level, or number of devices attached. Put simply:

- A single cascade link is made by connecting a **COMPUTER CONNECTIONS** socket of one unit to a **CATx USER PORTS** socket of the unit below it.

Such a single link would allow just one user from the higher ServSwitch CX unit to access any of the server systems attached to the lower one. However, a single link can cause a bottleneck for multi-user systems and cause port numbering problems, so the minimum permissible group link between ServSwitch CX units is a triple (quad cascade links are recommended). These allow three or four users to simultaneously access server systems situated anywhere within the cascade tree.

When triple or quad cascade links are made between units, each ServSwitch CX will automatically recognise the links and treat them accordingly. The links within a triple or quad group will then be allocated to users according to their general availability in that group, not as specific individual lines. To do this, each link group has an access number, which is determined by the ports to which they are connected on the switch.

For instance, a quad group connected to server ports 1, 2, 3 and 4 of a ServSwitch CX unit would always be known as 41, the next quad group connected to ports 5 to 8 would always carry the number 42, and so on. The diagram here summarises the ports to which triple and quad groups must be connected and the resulting group numbers attained in the positions here ⇨

The central purpose of the link group system is that each user can use a unique address to locate a particular server. However, as with the Internet, the route to get there could be slightly different each time. This avoids any route blocking that could easily be caused by other users occupying any specific link lines.

Note: Triple and quad link groups may be mixed on one unit providing the differing link groups lie within appropriate port boundaries shown opposite - see [Tips for successful cascading](#) for more details.

Port boundaries and numbering for triple link groups (sixteen port models use groups 31 to 35 only)

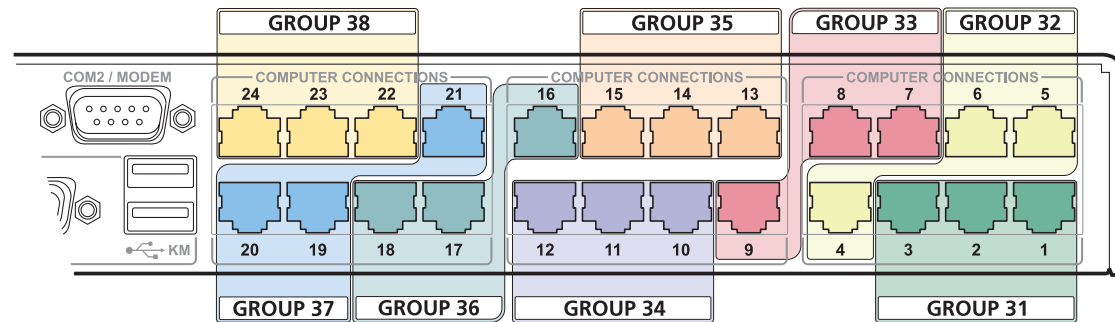

Port boundaries and numbering for quad link groups (sixteen port models use groups 41 to 44 only)

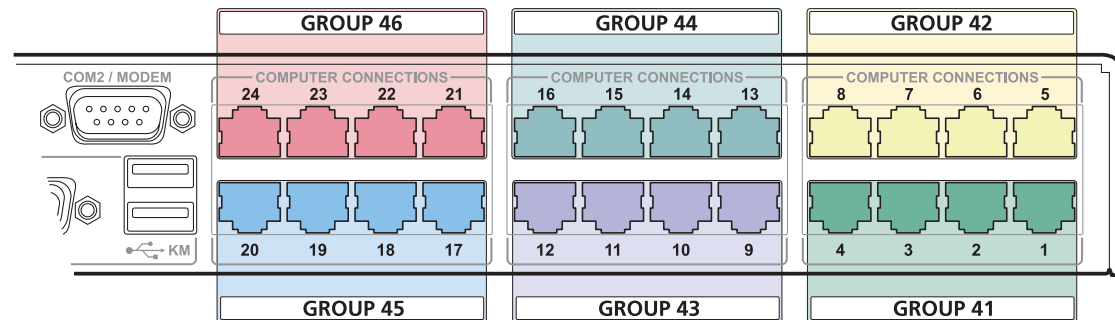

See also

- [Addressing servers in a cascade](#)
- [Connecting ServSwitch CX units in cascade](#)
- [Testing specific links to cascaded servers](#)

Addressing servers in a cascade

The addressing format used by the ServSwitch CX units incorporates the various [group numbers](#) along with a final specific port number to which a required server is attached. In the diagram given here, a portion of the previous cascade diagram indicates how the routes to particular servers are formed and addressed.

Each cascade level requires two digits, hence the server marked in red requires a unique address with six digits because it is at cascade level 3, compared to the blue server at level 2 with its four digit unique address. A server connected directly to the ServSwitch CX at the top level would simply have a two digit port number.

The group at level 2 is numbered 41 because it is a quad group, connected to ports 1, 2, 3 and 4 on the ServSwitch CX. If it was connected to ports 5, 6, 7 and 8, then the group number would be 42 and the overall address for the red server would be 43 42 02.

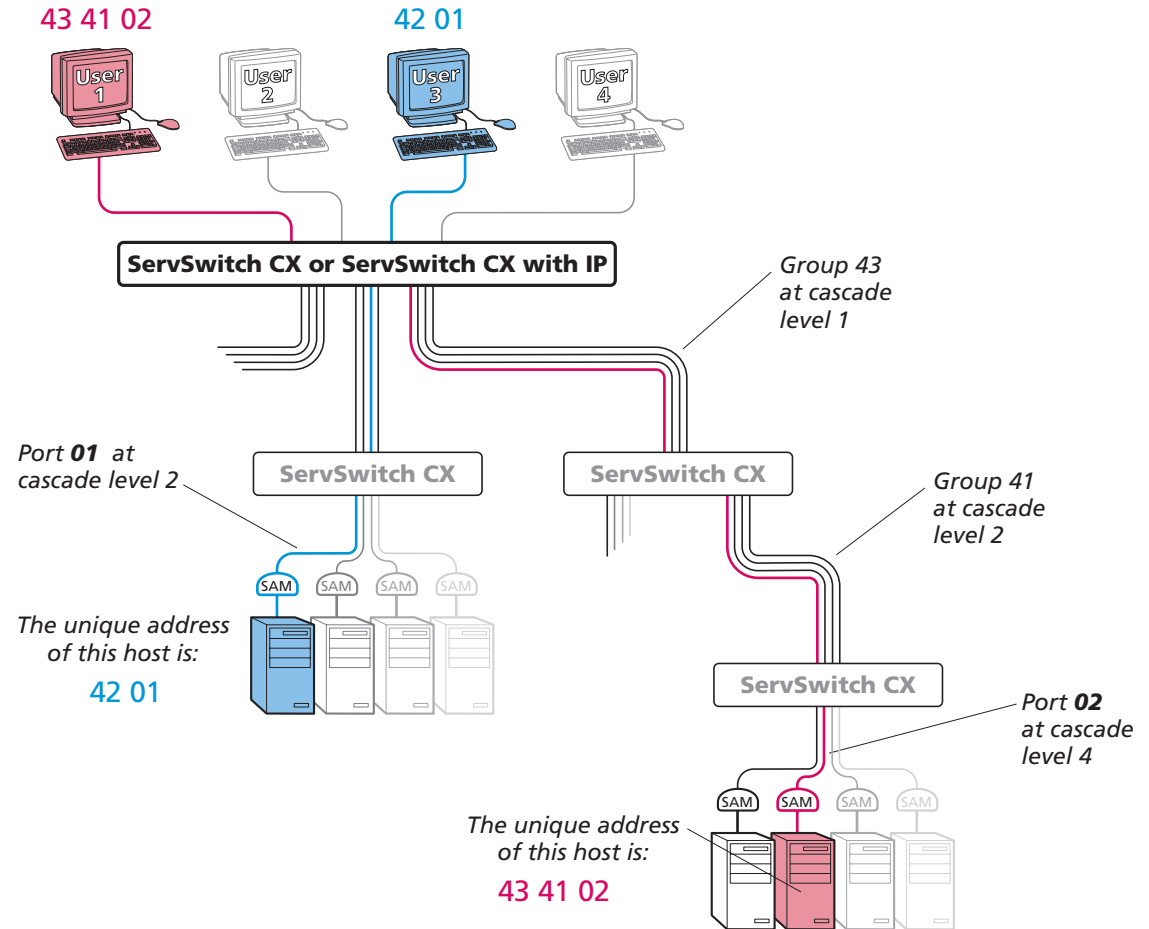

See also

- [Connecting ServSwitch CX units in cascade](#)
- [Testing specific links to cascaded servers](#)





Connecting ServSwitch CX units in cascade

Please consider the following when making cascade connections between ServSwitch CX units.

Tips for successful cascading

- The maximum number of levels for a cascade is three.
- The maximum number of server systems that can be controlled within a cascade installation depends upon the ServSwitch CX unit placed at the top level. If the top level unit is a non-IP version, a maximum of 512 server systems can be controlled. However, if the top level unit is a ServSwitch CX with IP, the maximum number of servers drops to 128. This is due to the extra burden placed on the unit's memory of administering global (IP) users.
- The number of links between units (three or four) determines the number of users that can simultaneously access the servers situated further down the tree. Link groups of one and two links should not be used.
- Ensure that cascade links (within a group) between units are approximately the same length.
- Triple and quad link groups may be mixed on one unit providing the links lie within the appropriate port boundaries designated in the [Group numbering diagram](#).
- ServSwitch CX *with IP* models can only be used at the top level of the cascade tree because they have only two CATx USER PORTS sockets and the minimum number of links required for a cascade group is three.
- For each cascade link, use a standard category 5, 5e or 6 twisted-pair cable, terminated at each end with an RJ45 connector. There must be no crossover connections within the cable, i.e. do not use patch cables. The cascade link cables can be up to 50m (160 feet) in length. However, remember that the overall length between any remote user (via a ServSwitch CX Remote extender) and any server (via a SAM) must not exceed 300m (980 feet) - that figure includes the cascade link cables. Ensure that each of the links within a cascade group all conform to the same length.
- The procedure given opposite may be carried out in any order but for clarity the instruction will begin at the higher level ServSwitch CX unit (here called the *upper unit*), i.e. the one that is being fed into by a unit at the cascade level below (here called the *lower unit*). The procedure remains the same regardless of exactly which cascade levels are being connected. The basic rule is that each link is made by connecting a COMPUTER CONNECTIONS port of the upper switch to a CATx USER PORTS of the lower switch.

See also

- [Testing specific links to cascaded servers](#)

To connect units in cascade

1 Ensure that power is disconnected from the ServSwitch CX and all other units to be connected.

2 Connect one end of each cascade link cable to an appropriate COMPUTER CONNECTIONS port on the rear panel of the upper unit. Refer to the [Group numbering diagram](#) for the correct link group boundaries.

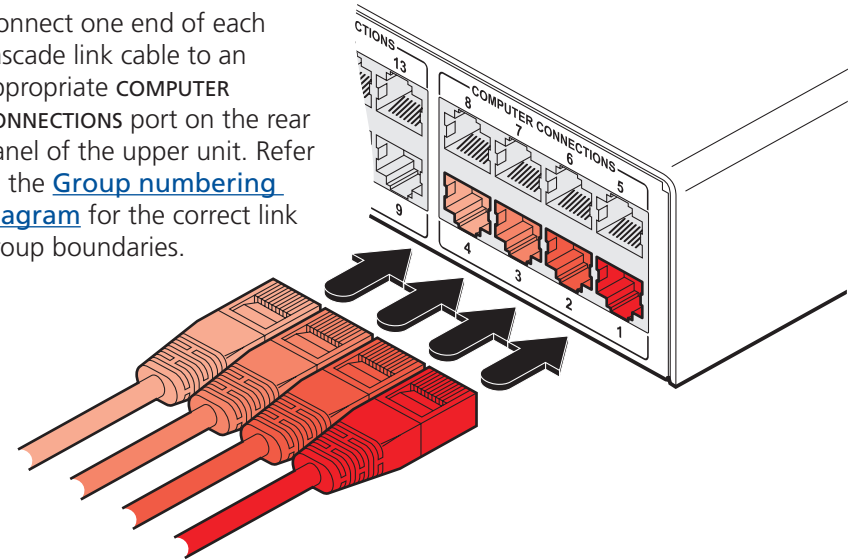

3 Connect the other end of the cascade link cable to one of the CATx USER PORTS sockets on the rear panel of the lower unit. Due to the way in which ports within a link group are dynamically allocated, it is not usually important exactly which user port is connected to each server port of the upper unit.

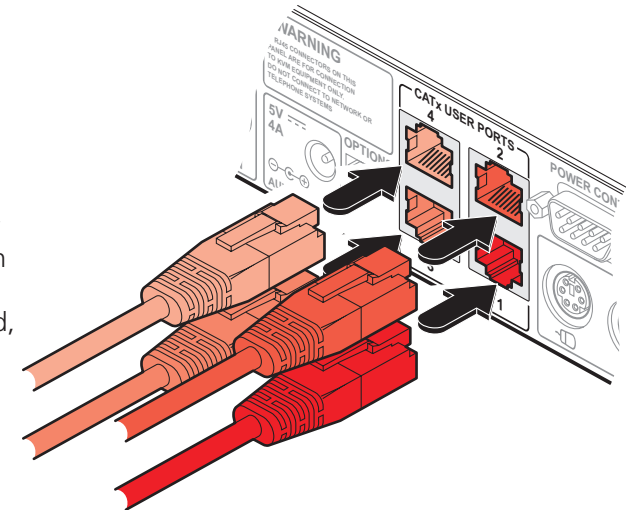

4 Repeat steps 2 and 3 for each of the links within the group, adhering to the [Group numbering diagram](#) for the correct link group boundaries on the COMPUTER CONNECTIONS ports of the upper switch.

Once the ServSwitch CX units and servers have been connected, you can edit their names to make it much easier to locate them. See the [To create/edit server names](#) section in the Configuration chapter for more details.





Using cascaded servers





In use, cascaded servers can be accessed using exactly the same methods as for those connected directly to the ServSwitch CX. However, by far the easiest way is to use the on screen menu. This is because it displays the server names and does not require any knowledge of port addresses, some of which (as discussed above) can be up to six digits long. See the [Selecting cascaded servers](#) section in the Operation chapter for more details.



Testing specific links to cascaded servers

As mentioned previously, the best and most efficient way to access cascaded servers is by using the on screen menu and via non-specific routes through the link groups. However, during configuration or troubleshooting, it may be useful to test specific routes to servers in order to verify the various strands of each link group. By using specific port addresses for each unit, rather than link group numbers, you can precisely navigate a route through any part of the system.

To test a specific link

- 1 Simultaneously press and hold  and .

*Note:  and  are the standard hotkeys and can be **altered** to avoid clashes with other devices or software. If you change the hotkeys, remember to use the new ones in place of  and  when following these instructions.*

- 2 While still holding  and , in sequence, press and release the full address of the required server – remember to use specific port numbers, not link group addresses, e.g. 061802, *not* 424502.
- 3 When the last digit has been entered, release all keys.

Multiple video head connections

Two or more ServSwitch CX units can be connected together so that they operate in a synchronised manner. Synchronised operation is useful for applications that require multiple video signals to be switched together. This type of operation is usually required where each server is fitted with multiple video cards or video cards with multiple video heads. Whenever a ServSwitch CX channel is switched, it sends an RS232 command out on its serial interface (marked COM1/UPGRADE on the rear panel). A ServSwitch CX will switch its channel if it receives the same command on its serial interface. Consequently, by linking the serial interfaces, a master unit may be made to automatically switch one or more slave units as shown in the diagram.

It should be noted that the synchronisation cable deliberately does not have the transmit pin of the Slave End connector linked to the receive pin of the Master End connector. To do so would cause the Slave unit to be able to switch the Master unit. This would setup an endless cyclical switching sequence that would prevent the ServSwitch CX devices from operating correctly. For more details about the serial synchronisation cables, see [Appendix 7](#).

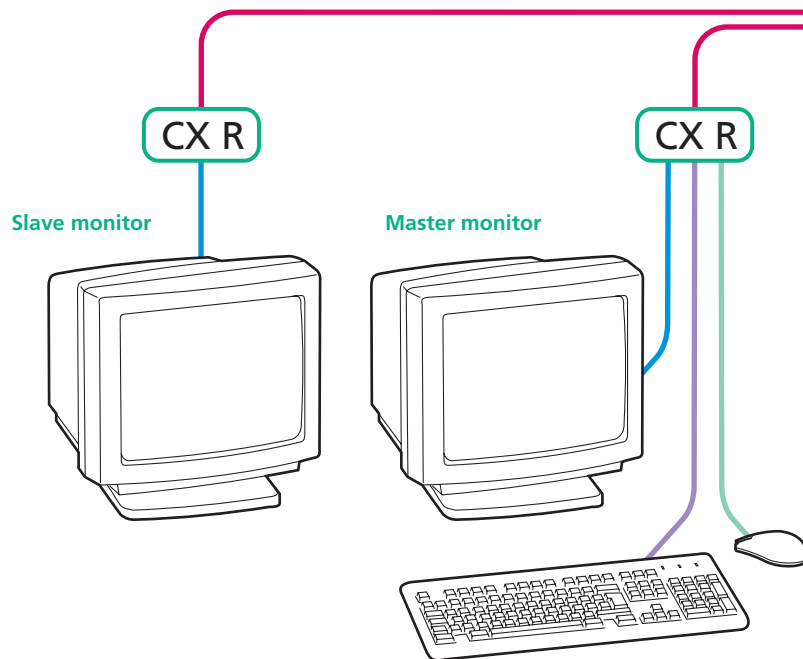
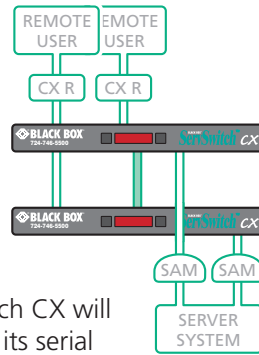

Notes

It is recommended that the second SAM in each pair is a USB-type and that it is plugged to a vacant USB port on the host server to derive its power.

Pairs of SAMs can be strapped back-to-back with cable ties to create a tidy installation.

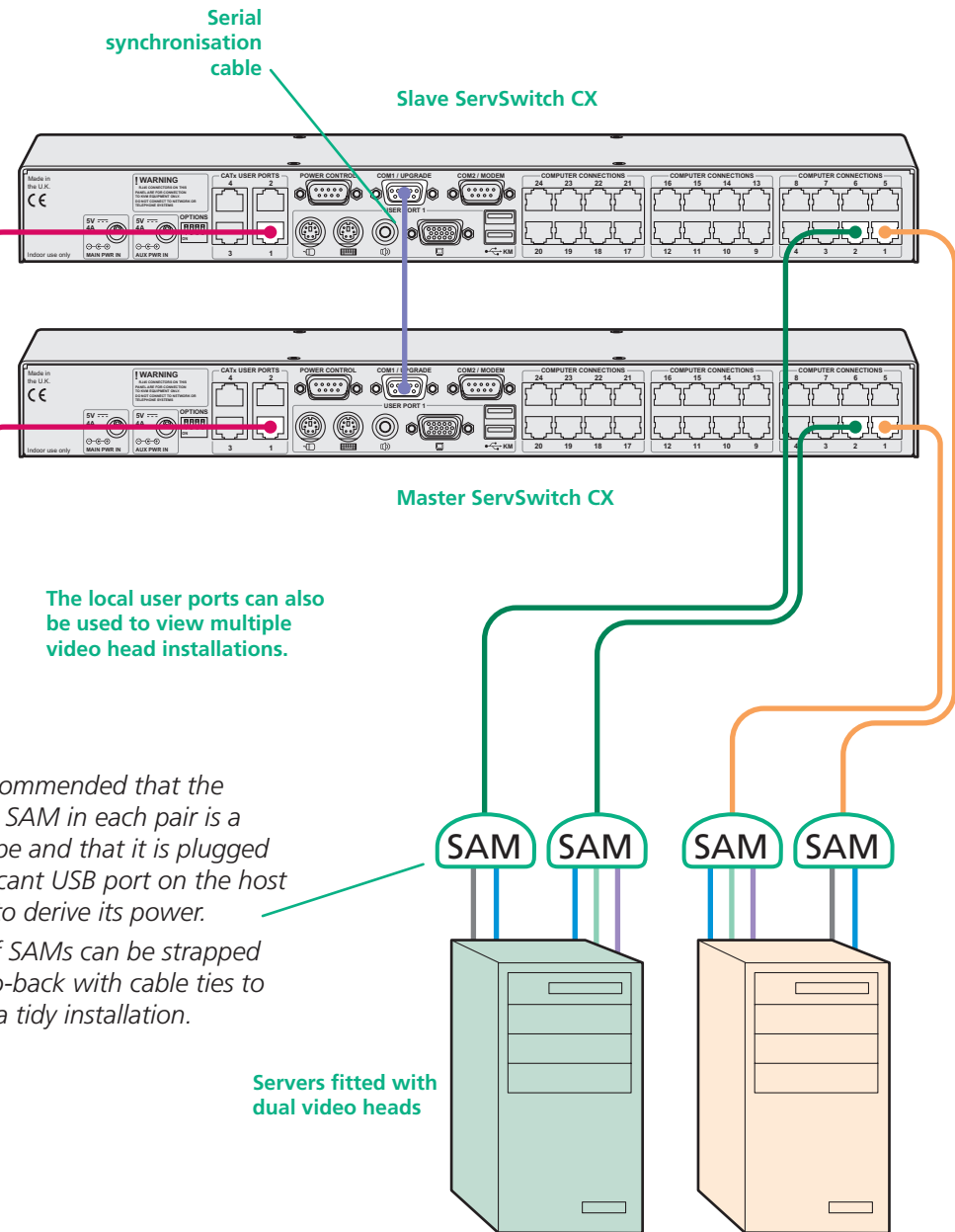

The local user ports can also be used to view multiple video head installations.

Servers fitted with dual video heads



INSTALLATION

CONFIGURATION

OPERATION

FURTHER INFORMATION

INDEX

Configuration



Almost all configuration and operational aspects of the ServSwitch CX units are controlled via [on-screen menu](#) displays.

Overall initial configuration

When setting up a new installation, the following stages are recommended:

1 [Enable the general 'Security' option.](#)

With security disabled (default setting), all users attached to the ServSwitch CX have full and unrestricted access to all servers and all ServSwitch CX settings. In larger installations, you are strongly recommended to enable security and set up individual user accounts with access privileges.

2 [Create an ADMIN \(administration\) password.](#)

All ServSwitch CX units have a fixed user account that cannot be deleted, named ADMIN. This user account is the only one that is able to make important system changes. If you intend to use security, then it is important to allocate a password to the ADMIN account.

3 [Create user accounts and allocate access rights.](#)

Use the ADMIN account to add user profiles, passwords and access rights for each of the system users.

4 [Provide names for servers.](#)

When numerous servers are attached, you are strongly advised to provide names for each, to assist with recognition.

5 [Compensate video signals to account for link cable lengths](#)

The long cable links that are possible between the ServSwitch CX unit and the servers and also to the remote users can affect the quality of the video images displayed. Use the in-built compensation features to eliminate any potential video image degradation.

6 Configure the required ['Setup Options'](#) and ['Global Preferences'](#)

Use the ADMIN account to determine key ServSwitch CX settings and timing characteristics.

7 [Configure the IP settings](#)

*ServSwitch CX **with IP** models only. IP models possess a further collection of IP-related configuration options and encryption features that protect the installation from unauthorised global users - ensure that the IP security features are enabled before connecting the ServSwitch CX with IP unit to the network. The IP settings use the standard ADMIN password.*

INSTALLATION

CONFIGURATION

OPERATION

FURTHER
INFORMATION

INDEX

Configuration menus

The configuration menus allow you to determine many aspects of the ServSwitch CX capabilities. From here you can:

- Create individual user accounts and determine access rights,
- Provide names for all connected servers to allow quick recognition,
- Set individual and global settings for users,
- Run various functions, such as mouse restore operation,
- Save and load ServSwitch CX configuration settings, and more.

To access the configuration menu (local and remote users)

1 If the main menu is not already displayed, press and hold **Ctrl** **Alt** and then press **M** using a keyboard attached to a ServSwitch CX user port.

The main menu will be displayed:

The screenshot shows the SERVSWITCH CX main menu. It features a table of computer names and port numbers, a user login section, and a list of function keys. Annotations point to various elements:

Computer	Port
Computer 1	01
Computer 2	02
Computer 3	03
Computer 4	04
Computer 5	05
Computer 6	06
Computer 7	07
Computer 8	08

Below the table, the 'User port 1' section shows 'ADMIN' as the login name and 'SHARED USE' as the status. At the bottom, function keys are listed: F1-More menus, F2-Adj. Video, F3-Find, and F4-Logout.

Annotations include: 'Default names for each server port' pointing to the computer names; 'Identification of this user port' pointing to the 'ADMIN' login name; 'Your Login name' pointing to the 'ADMIN' text; 'Port numbers' pointing to the port numbers in the table; 'Connection status of this user port' pointing to 'SHARED USE'; and 'Assistance for keypress options' pointing to the function keys.

2 Press **F1** To display the Configuration Menu:

The screenshot shows the SERVSWITCH CX Configuration Menu. It lists various functions such as 'Routing status', 'User Preferences', 'Global Preferences', 'Setup Options', 'Edit Computer List', 'Edit User List', and 'Edit Autoscan List'. At the bottom, it shows function keys: F1-More menus, Enter-Select, Esc-Quit, and Firmware Version 1.02.

3 Use the **↓** and **↑** keys to highlight an option, then press **↵** to select.

Hotkeys

Note: **Ctrl** and **Alt** are the standard hotkeys and can be *altered* to avoid clashes with other devices or software. If you change the hotkeys, remember to use the new ones in place of **Ctrl** and **Alt** when following the instructions in this guide.

Security

Note: If the security option has been enabled, you will be asked for a valid user name and password before the main menu can be displayed.

The screenshot shows the SERVSWITCH CX security login screen. It has a 'User Name:' field with a cursor and a 'Password:' field. Below the fields, it says 'Port 1 login' and 'Esc-Scr Save'.

IMPORTANT: When supplied, ServSwitch CX units have their security features disabled, which means that any attached users have access to all connected servers and all ServSwitch CX settings. You are strongly recommended to *enable the 'Security' feature* and set an access password for the ADMIN account.

To access the configuration menu (global users)

Once the IP settings have been made (and the ServSwitch CX with IP unit is network connected), global users can access the configuration menu using a different method.

- 1 Use either the VNC viewer or a standard web browser to make remote contact with the ServSwitch CX with IP – see [Global user access](#) for more details.
- 2 If the username entry is not blanked out, enter 'admin' or another login username. Then enter the admin password (if no password is set, then just press **↵**). Once logged in, the ServSwitch CX with IP will show the video output from the host system (if one is connected), or otherwise a 'No Signal' message.
- 3 Click the 'Controls' button and select the 'KVM Switch menu' option. All options appropriate to the entered username will be displayed.



- INSTALLATION
- CONFIGURATION
- OPERATION
- FURTHER INFORMATION
- INDEX

Configuration menus layout

The menu options are arranged as shown here:

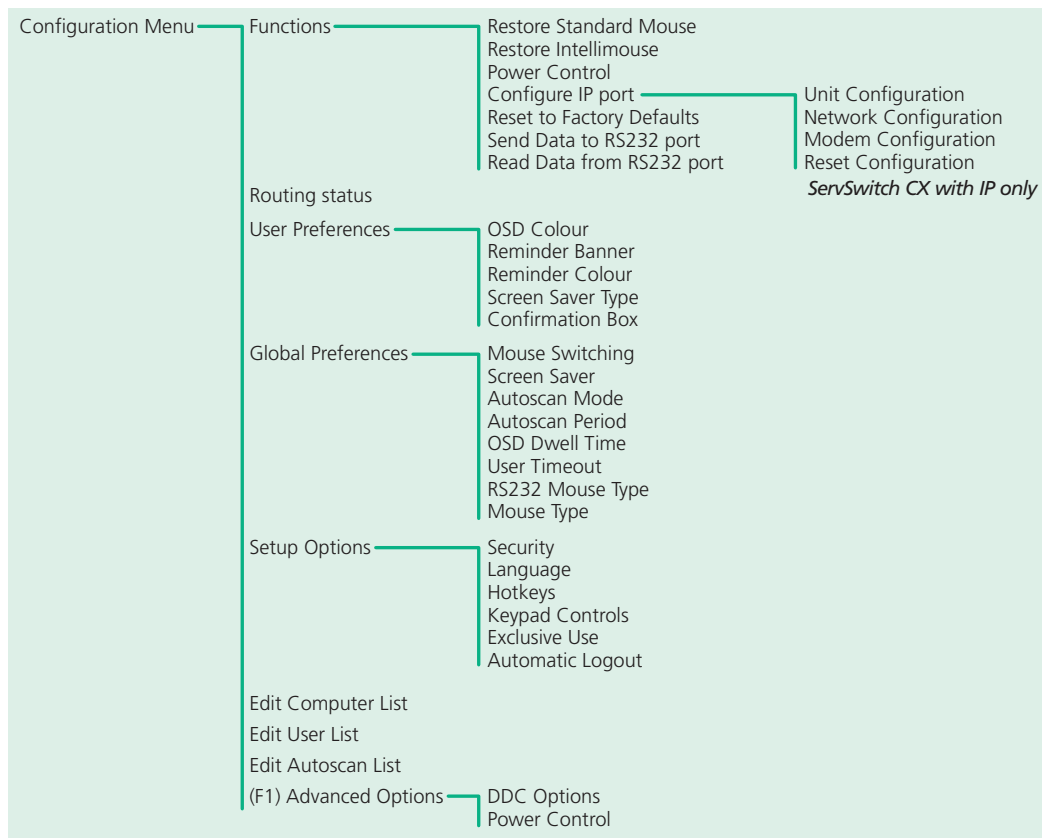

For a description of each option within the Configuration menus, see [Appendix 1](#) for more details.

General security and configuration steps



To enable general security

- 1 Display the [Configuration menu](#).
- 2 Highlight 'Setup Options' and press .
- 3 Highlight 'Security' and press to select 'ENABLED'.
- 4 Now create a new password for the ADMIN user account.

To set an ADMIN password

- 1 Display the [Configuration menu](#).
- 2 Highlight 'Edit User List' and press .
- 3 Highlight 'ADMIN' and press . Press again to accept the name 'ADMIN' without change.
- 4 Enter an appropriate password for the ADMIN user account with regard to the following:
 - The password can be up to 12 characters long.
 - The password can use letters, numerals and/or certain punctuation marks.
 - The password is not case sensitive.
- 5 Press . The 'Edit Access Rights' menu will be displayed. However, as the ADMIN account always has access to all servers, press again to save the new password.

[What to do if the ADMIN password has been forgotten.](#)

To change the hotkeys

ServSwitch CX units use and as their standard hotkeys. These can be changed if they clash with other software or hardware within the installation.

- 1 Display the [Configuration menu](#).
- 2 Highlight 'Setup Options' and press .
- 3 Highlight 'Hotkeys' and press to select the required hotkey combination. The options are: *CRTL+ALT*, *CTRL+SHIFT*, *ALT+SHIFT*, *ALT GR*, *LEFT ALT+RIGHT ALT*, *LEFT CTRL+LEFT ALT*, *RIGHT CTRL+RIGHT ALT* or *DISABLED*.
- 4 Press to return to the 'Configuration Menu'.

Registering users (edit user list)



To create/edit user accounts

- 1 Display the [Configuration menu](#). *Note: You must be logged-in as the ADMIN user.*
- 2 Highlight 'Edit User List' and press

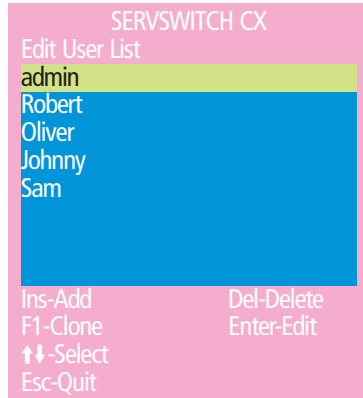

- 3 Either:
 - *Create a new account* - Press , enter a new user name and press ,
 - or
 - *Edit an existing account* - Highlight the required user name and press . Edit the name, if appropriate, and/or press .
- 4 Enter or edit the password with regard to the following:
 - The password can be up to 12 characters long.
 - The password can use letters, numerals and/or certain punctuation marks.
 - The password field can remain blank to allow open access to this account.

- 5 Press to display the 'Edit Access Rights' menu.

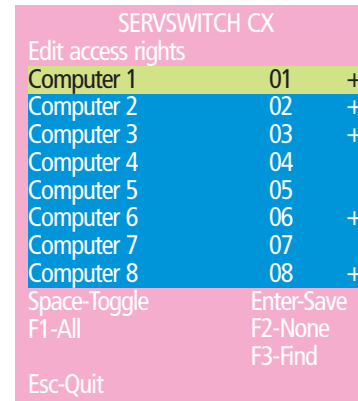

Cross markers indicate which servers will be accessible to the currently selected user. To change the permission state: Highlight a server and press the space bar.

Here you can determine which of the connected servers can be accessed by the selected user account. Only servers that show the '+' marker to the right of the menu box will be accessible to the user account.

Note: The [Port Direct](#) feature (which allows interconnected switching units to talk to one another) ensures that users without access rights to particular servers cannot move sideways to those servers via other servers.

Note: Access rights for user accounts to particular servers can also be controlled from the 'Edit Server List' menu.

- 6 Select and deselect servers as follows:
 - *Individual server* - Highlight a server name, then press to apply, or remove, a '+' marker.
 - *Access to all servers* – Press
 - *Access to no servers* – Press
- 7 When all settings have been made, press to save and exit. Press to return to the 'Configuration Menu'.

Registering servers (edit computer list)



To create/edit server entries

- 1 Display the [Configuration menu](#). Note: You must be logged-in as the ADMIN user.
- 2 Highlight 'Edit Computer List' and press

SERVSWITCH CX	
Edit Computer List	
Computer 1	01
Computer 2	02
Computer 3	03
Computer 4	04
Computer 5	05
Computer 6	06
Computer 7	20
Computer 8	414203
Ins-Add	Del-Delete
F1-Clone	Enter-Edit
↑↓-Select	F3-Find
Esc-Quit	

- 3 Either:
 - Create a new server entry – Press and enter a new name, or
 - Edit an existing server entry – Highlight a server name and press . Press (Backspace) to delete existing characters and enter the required new name (up to 16 characters).
- 4 Press and the cursor will move to the server port column on the right side. Change or enter the port address of the server as required. See the [Addressing servers in a cascade](#) section for more details.

- 5 When the port address is complete, press . The 'Edit access rights' menu will be displayed.

SERVSWITCH CX	
Edit access rights	
admin	+
Robert	+
Oliver	+
Johnny	
Sam	
Space-Toggle	Enter-Save
F1-All	F2-None
	F3-Find
Esc-Quit	

Cross markers indicate which users will be granted access to the currently selected server. To change the permission state: Highlight a user name and press the space bar.

Here you can determine which users should have access to the created/edited server. Only users that show a '+' marker to the right of the menu box will be granted access to the server.

Note: The [Port Direct](#) feature (which allows interconnected switching units to talk to one another) ensures that users without access rights to particular servers cannot move sideways to those servers via other servers.

Note: Access rights for particular user accounts to servers can also be controlled from the 'Edit User List' menu

- 6 Select and deselect users as follows:
 - Individual user - Highlight a user name, then press to apply, or remove, the '+' marker.
 - Allow access for all users – Press
 - Allow no user access (except ADMIN) – Press
- 6 When all settings have been made, press to save and exit. Press to return to the 'Configuration Menu'.

Tips when creating/editing server entries

- Avoid creating two names for the same computer port.
- When cascading to other units, do not apply individual names to any ports that are forming a link group to another switch (i.e. ports 1, 2, 3 & 4 when they form link group 41).

Video compensation

The ServSwitch CX units allow server systems to be placed up to 50m (160 feet) away and remote users to be extended by a maximum of 300m (980 feet). Such long cable lengths can affect video signals, especially when higher screen resolutions are used. In order to eliminate any video signal degradation, all ServSwitch CX units and accompanying ServSwitch CX Remote extenders provide effective software-based video compensation features.

Two main types of video compensation are provided within the ServSwitch CX installation, these are:

- **Server video compensation** - operates on video signals between each server system and the ServSwitch CX unit. See [Server video compensation](#) for details.
- **Remote user video compensation** - operates on video signals between each remote user(s) and the ServSwitch CX unit. See [Remote user video compensation](#) for details.

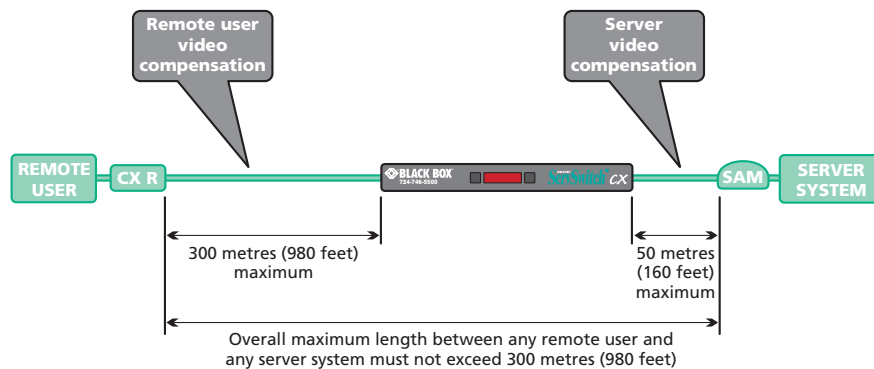

Note: For installations where both servers and remote users require video compensation, always ensure that the servers are compensated first.

- A third type of video compensation is provided by Black Box ServSwitch CX remote AS/R extender modules only. This type of compensation is called Skew adjustment and combats the effect of uneven twisted pairs within link cables. See [Remote user skew adjustment](#) for details.

It is important to note that, providing the cabling arrangements do not change, the various video compensations need to be applied only once to each server or remote user link. During operation, control of video compensation is fully automatic. Please take into account the following when configuring links:

- The ServSwitch CX stores a video compensation setting for each server which defines the level of compensation that is applied whenever the server is selected. This “server video compensation” setting is to correct for any video clarity loss due to the CATx cable between the ServSwitch CX unit and the server’s SAM.
- CATx cables below 10m (30 feet) give very little loss and so it is not normally necessary to be concerned about setting any server video compensation if short CATx cables are being used between the ServSwitch CX and the SAM for each server.
- “Server video compensation” may be setup by typing in the cable distance in the OSD or, if very fine video adjustment is desired, by observing the video picture on the local (user 1) port whilst making adjustments.
- If a cascade of switches is being used, server video compensation only needs to be applied at the master ServSwitch CX.
- “Remote user video compensation” compensates for and CATx cable loss introduced by the cable between the ServSwitch CX remote and the ServSwitch CX. The required video compensation setting does not vary as any “server video compensation” is automatically added as different servers are selected. This only needs to be setup once during installation.



Server video compensation

The video compensation for connected servers is achieved using the main menu. Although the compensation can be applied from any local, remote or global user port, it is best achieved using the local user port because this provides the most direct view of the server output. The compensation is achieved simply by registering the link cable length, however, different cables can vary in their characteristics so it is often useful to 'fine tune' the compensation by eye.

Note: CATx cables below 10m (30 feet) give very little loss and so it is not normally necessary to be concerned about setting any server video compensation if short CATx cables are being used between the ServSwitch CX and the SAM for each server.

To apply server video compensation

- 1 Place a server (connected via its SAM and category 5, 5e or 6 cable) into the highest resolution video mode at which it will be used.
- 2 If possible, use a monitor and keyboard connected to the ServSwitch CX local user port.
- 3 Display the ServSwitch CX main menu and use it to select the appropriate server.

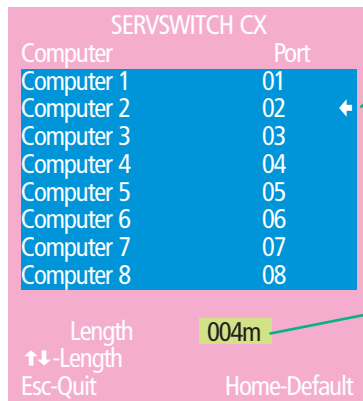

Note: You must highlight the server name and press  to select it.

- 4 Press  to access the compensation feature:



Ensure that the appropriate server is marked by the arrow - if it is not marked, the server is not correctly selected and the compensation will not be applied.

The value in the green area indicates the currently selected cable length.

- 5 Use  and  to increase or decrease the stated cable length, as required.
Note: As you adjust the Length value, check the video image for signs of under- or over- compensation, especially to the right hand side of any hard vertical edges of images.
- 6 When the correct compensation has been applied, press  to quit the screen and save the settings.



Remote user video compensation

Video compensation for each remote user is provided by their ServSwitch CX Remote modules, not by the ServSwitch CX unit itself. Using the ServSwitch CX Remote controls you can adjust the picture sharpness and brightness to improve the remote picture quality.

Note: Accurate remote user compensation relies upon visual feedback from the screen image. It is therefore vital to ensure that the video images being sent out from the ServSwitch CX are as 'true' as possible. Ensure, using the local user port, that the video images received from the servers are correctly compensated BEFORE attempting to adjust the remote user(s).

Video compensation is best carried out when viewing high contrast images with vertical edges, such as black lines on a white background. When doing so, if you notice that the screen image is 'fuzzy' or 'dark' then the image controls may not be able to solve this condition.

Note: If the high contrast images exhibit shadows with separate colours, then there may be a skew problem which requires a different image adjustment (provided only by ServSwitch CX Remote AS/R modules) - see the [Remote user skew adjustment](#) section for details.

To display a suitable high contrast image

The best way to clearly view the effect of sharpness and brightness adjustments is to display a high contrast image, with vertical edges, on the screen.

- Open a word processor, type the capital letter 'H', or 'M' and increase the point size to 72 or higher. For best results, the background should be white and the character should be black.
- A BLACK shadow on the right of the character indicates UNDER compensation.
- A WHITE shadow on the right of the character indicates OVER compensation.

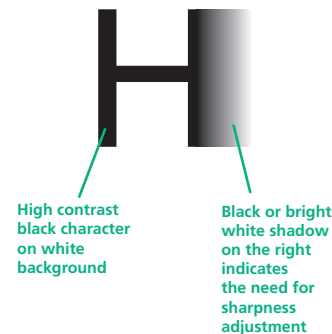

Note: The Word processor method is accurate and quick. However, for the very finest video compensation, use the latest "skew" test pattern program which shows both the skew pattern and a section of mixed size Hs (black on white and white on black).

If the image controls cannot provide a crisp image

If, after adjusting the image controls, one or more screen images remain fuzzy or have coloured shadows you may need to use the Skew adjustment feature. Please see [Remote user skew adjustment](#) for details (ServSwitch CX Remote AS/R module only).

To apply remote user video compensation

- 1 Ensure that the video image from the server to be used has been correctly compensated. See [Server video compensation](#) for details.
- 2 On the remote user keyboard (connected to an ServSwitch CX Remote extender), simultaneously, press the hotkeys (by default, **Ctrl** and **Shift**) along with **F2** to enter configuration mode.

The three keyboard indicators ('Num Lock', 'Caps Lock' and 'Scroll Lock') will now begin to flash in sequence. The speed of the sequence indicates the level of the sharpness adjustment currently applied: the slower the rate, the lower the level of sharpness being applied.

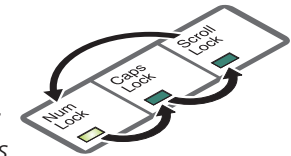

- 3 While viewing the displayed screen image, use the following keys to adjust the controls:

Sharpness: **↑** **↓** for fine adjustment, **Page Up** **Page Down** for coarse adjustment.

There are 255 sharpness levels (one coarse step jumps 10 levels).

To autoset sharpness: Press **F2** **F2** **F2** to make the module calculate and apply an automatic compensation level - you can use this as a starting point for your fine tuning.

Note: If the monitor goes blank and switches off (due to oversetting the sharpness adjustment) press the Home key to restore.

Brightness: **←** **→** for adjustment. There are 255 brightness levels.

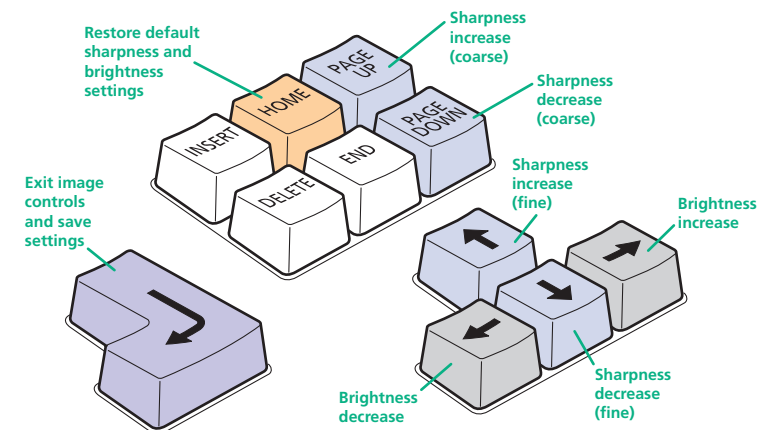

- 4 When no shadows are visible and the displayed images have crisp edges, press **F2** to exit configuration mode and permanently save all settings. The new compensation settings will be stored, even when power is removed or if a complete reset is initiated. These settings should not require further changes unless the cabling arrangements are altered.



Remote user skew adjustment

The category 5, 5e and 6 cabling supported by the ServSwitch CX consists of four pairs of wires per cable. Three of these pairs are used to convey red, green and blue video signals to the remote video monitor. Due to the slight difference in twist rate between these three pairs, the red, green and blue video signals may not arrive at precisely the same time. This is visible as separate colour shadows on high contrast screen images and is particularly apparent when using higher screen resolutions and some types of category 5e cables.

To alleviate this situation, the ServSwitch CX Remote AS/R module provides internal skew adjustment that can help to rectify the situation. The skew adjustment works by delaying or advancing the timing of any of the red, green or blue colour signals so that they are all delivered to the monitor at precisely the same time. For best results, the "skew" program supplied on the disk or obtainable from Black Box support is the most accurate way of setting skew as the red, green and blue lines are rendered exactly on the screen as single pixel wide lines. The skew.bmp test pattern can also be used but it is less accurate. Alternatively, you can create your own skew pattern using a standard image creation package, as detailed opposite.

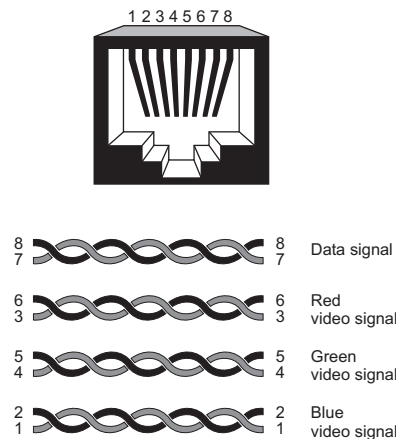

To use skew adjustment

- 1 Display a skew pattern on the appropriate server. You can either use the supplied skew pattern or create your own:

Using the supplied skew pattern

- i Insert the supplied Installation CD-ROM into the CD player of the server.
- ii Within Windows, use the *My Server* option (usually available as a desktop icon or within the Start menu) to view the contents of the CD-ROM. Double-click the **Skew** entry to display the standard test pattern. If necessary, maximise the application window so that the image fills the screen.

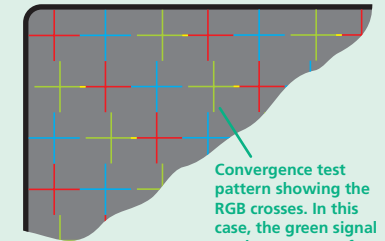

The screen will show a series of fine red, green and blue crosses which should all be in line, vertically and horizontally. Skew affects the horizontal placement of the colours and using this pattern it is much easier to discover which, if any, colours are being adversely affected by the cable link.

Creating a skew test pattern

- i Run any image creation/editing application, such as the Paint program supplied with Windows.
- ii Using the image application create three stacked horizontal rectangles (one red, one green and one blue) that fill the width of the screen.
- iii Draw a vertical black line down across the coloured bars and then repeat this vertical line at intervals along the width of the coloured bars. These lines create breaks across the colours and give you more opportunities to view the horizontal position of each colour relative to the others.

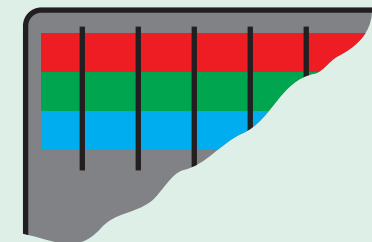

- 2 On the remote user keyboard (connected to an ServSwitch CX Remote AS/R extender), simultaneously, press the hotkeys (by default, **Ctrl** and **Shift**) along with  to enter configuration mode.

The three keyboard indicators ('Num Lock', 'Caps Lock' and 'Scroll Lock') will now begin to flash in sequence.

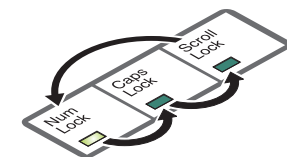

- 3 As appropriate, press either the R, G or B keyboard keys to select the appropriate colour channel. Corresponding keyboard indicators will flash rapidly to show which channel is currently selected for adjustment: Num Lock for Red, Caps Lock for Green and Scroll Lock for Blue.

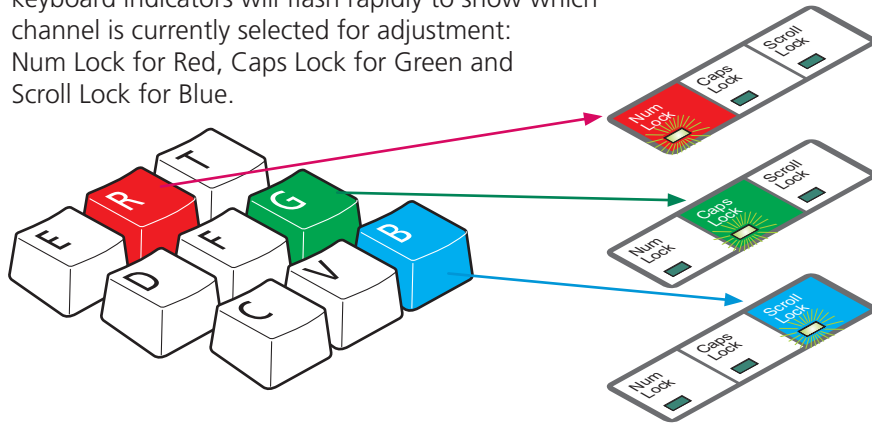

- 4 Press the ← and → keys to retard or advance the timing of the selected colour channel respectively. On screen you will see a change in the position of the selected colour crosses (or colour bars) in relation to the other two.

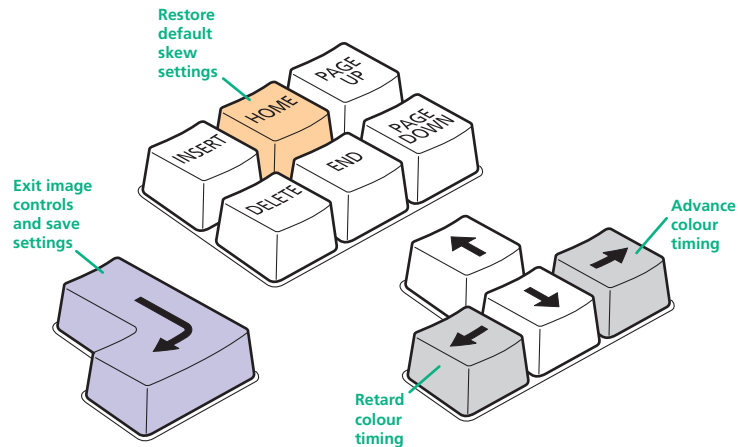

- 5 When the selected colour crosses (or colour bars) are correctly positioned, press ↵ to exit that colour channel. The keyboard indicators will return to flashing in sequence.
- 6 If required, repeat steps 3 to 5 to select and adjust any colour channel until the vertical lines of the red, green and blue crosses are all aligned.
- 7 When all colours are correctly aligned on all video channels, press ↵ to exit configuration mode and permanently save all settings.

Note: Once you have made the skew adjustments, it may be necessary to re-adjust the image controls to attain optimum screen images.

Autoscanning

The ServSwitch CX provides an autoscan mode that switches between the connected servers in sequence. This mode is useful to allow users and administrators to sample activity among the connected machines. Three scanning modes are provided:

- *Scan list* – Only servers declared within an autoscan list will be viewed. Servers connected to cascaded switches can be included in the autoscan list.
- *Active PCs* – Only computer ports where an active server is detected will be viewed. This mode avoids blank screens from being displayed and helps to prevent the viewing monitor from entering a power-down state on every scan cycle. Servers connected to cascaded switches will not be viewed in this mode.
- *All PCs* – This mode visits, in turn, each server that is connected directly to the ServSwitch CX. This mode should be used with care due to the reasons given in the warning below. Servers connected to cascaded switches will not be viewed in this mode.

The scanning mode is a global setting and hence will be the one viewed by any user who selects **Ctrl** **Alt** **A** on their keyboard. Note, however, that users will only see the scanned servers to which they have access rights. Hence, if two users (with various access rights) simultaneously view an autoscan, they will see differing results depending upon their respective permissions.

WARNING: Many monitors are fitted with automatic power saving relays that switch off after a few seconds when connected to an inactive server. If you are using such a monitor, do not set the ServSwitch CX to the scan 'ALL PCs' mode. Continual switching on and off of the monitor's relay will eventually damage the monitor. If using such a monitor in conjunction with the 'Scan List' option, ensure that all selected servers are active.

There are up to three steps that need to be configured to use autoscanning ⇨

- *Select the autoscan mode:* Scan List, Active PCs or All PCs.
- *Select the autoscan period.* This is the time that is spent viewing each server. This step also enables and disables the autoscan feature.
- *Define the autoscan list.* This step is only required when the Scan List option is selected and allows you to select which servers will be scanned.

To select an autoscan mode

- 1 Display the [Configuration menu](#). *Note: You must be logged-in as the ADMIN user.*
- 2 Highlight 'Global Preferences' and press **↓**.
- 3 Highlight 'Autoscan Mode' and press **Space** until the required option is displayed: SCAN LIST, ACTIVE PCs or ALL PCs.

To select an autoscan period

- 1 Display the [Configuration menu](#). *Note: You must be logged-in as the ADMIN user.*
- 2 Highlight 'Global Preferences' and press **↓**.
- 3 Highlight 'Autoscan Period' and press **Space** until the required time to view each server is displayed, ranging from 2 seconds to 5 minutes.

To define an autoscan list

Note: This stage is required only when the 'Scan List' autoscan mode is selected.

- 1 Display the [Configuration menu](#). *Note: You must be logged-in as the ADMIN user.*
- 2 Highlight 'Edit Autoscan List' and press **↓**. A list of all connected servers will be displayed. Only servers that show a '+' marker to the right of the menu box will be autoscanned.
- 3 Select and deselect servers to scan as follows:
 - Individual server - Highlight a server name, then press **Space** to apply, or remove, the '+' marker.
 - Mark all servers for scanning – Press **F1**.
 - Unmark all servers – Press **F2**.
- 4 When all settings have been made, press **↓** to save and exit. Press **Esc** to return to the 'Configuration Menu'.

To view autoscan

- At one of the user ports, press **Ctrl** **Alt** **A**.

*Note: **Ctrl** and **Alt** are the standard hotkeys and can be [altered](#) to avoid clashes with other devices or software. If you change the hotkeys, remember to use the new ones in place of **Ctrl** and **Alt** when following these instructions.*



Saving and restoring configuration settings



The ServSwitch CX can store up to 512 server names and 16 sets of user access rights (ServSwitch CX with IP models support a maximum of 128 servers). Particularly in cascaded configurations, manually re-entering all server names, port numbers and access rights can be a lengthy process. Therefore, the ServSwitch CX provides a method to save and, if required, restore configuration settings using one of its serial ports. Further to this, the saved file can be opened and edited within a spreadsheet and then restored back to the ServSwitch CX – a useful way to make multiple setup changes.

Note: You must be logged-in as the ADMIN user for this procedure.

Preparations for configuration save/load

- Contact Black Box support and obtain the files XPREAD.EXE and XPWRITE.EXE.
- Connect the serial port on the rear panel of the ServSwitch CX, labelled COM1/UPGRADE, to a serial port on your server using the optional serial flash upgrade cable available from Black Box. See [Appendix 7](#) for pin-out specifications.

To save configuration settings

- 1 Run the program XPREAD.EXE on the server that is connected to the ServSwitch CX's serial port. Follow the instructions given by the program.
- 2 Using one of the ServSwitch CX user ports, display the [Configuration menu](#). *Note: You must be logged-in as the ADMIN user.*
- 3 Highlight 'Functions' and press .
- 4 Highlight 'Send Data to RS232 port' and press .
- 5 The ServSwitch CX will send the configuration data to your server. The XPREAD program will store the data in a file named 'XPRODATA.CSV' that will be created in the same directory where the XPREAD program was started - Ensure that you have sufficient rights to write to this directory.

To edit the configuration settings

The saved XPRODATA.CSV file can be opened using a spreadsheet program such as Microsoft® Excel®. The format of a typical file is shown below. You will see that the server names (rows) are tabulated against the user profiles (columns):



USERS		ADMIN	Alan	Jim	Sue	Test
PASSWORDS		password	letmein	hello	logmein	Test
ServerS	PORT					
Admin PC	2103	1	1	1	1	
Alan's System	2102	1	1	1		
Comms Server	3	1		1		
Comms PC	4	1	1	1	1	
Gateway 1	8	1				
Gateway 2	5	1				
Test System	15	1	1			
Web Browser	9	1		1		1

Hints for editing

- To grant a user access to a server, enter the value '1' in the box that is common to the server's row and the user's column.
- To deny access, leave the box blank.
- To add extra users, add additional columns (up to 16 users).
- To add extra servers, add additional rows (up to 512 [128 for IP models]).
- The ADMIN user will always be granted access to all servers regardless of the values entered.

To restore configuration settings

Note: Ensure that the server is connected to the ServSwitch CX as discussed earlier in the 'Preparations' sub section.

- 1 Copy the program XPWRITE and XPRODATA.CSV into the same directory on the server connected to the ServSwitch CX's serial port.
- 2 Run the program XPWRITE.EXE and follow the instructions given by the program.
- 3 Using one of the ServSwitch CX user ports, display the [Configuration menu](#). *Note: You must be logged-in as the ADMIN user.*
- 4 Highlight 'Functions' and press .
- 5 Highlight 'Read Data from RS232 port' and press .
- 6 The ServSwitch CX should then receive the configuration data from the server and load the new menu names and access rights into the menu.



What to do if the ADMIN password has been forgotten

If the ADMIN password becomes mislaid or forgotten, you will not be able to access the ServSwitch CX to add or edit users and server names. This situation may be resolved by performing a complete reset to return the ServSwitch CX or CX with IP to its factory default state.

IMPORTANT: A complete reset erases all the user names and server names that you have setup.

Slightly different procedures are used to reset the ServSwitch CX and the ServSwitch CX with IP, as detailed here.

To reset ServSwitch CX models

- 1 Remove all power inputs from the ServSwitch CX unit.
- 2 Move switch **3** on the rear panel down to the ON position.
- 3 Press and hold the front panel **USER** and **COMPUTER** buttons while you re-apply power. On the local user port, a screen menu will indicate that the unit has been reset and will prompt you to power down and return the switch to its normal position.
- 4 As directed, remove power and move switch **3** up to its OFF position.
- 5 Power up and configure the unit in the normal manner.

To reset the ServSwitch CX with IP models

- 1 Remove all power inputs from the ServSwitch CX with IP unit.
- 2 Move switch **2** on the rear panel down to the ON position.
- 3 Re-apply power to the unit. On the local user port, a screen menu will provide two options.
- 4 Using the local keyboard or mouse, select the 'Reset Configuration' option. A warning screen will be displayed, select the **RESET** option and press . The unit will reset and then prompt you to work through the [initial IP configuration screens](#).
- 5 After you have completed the initial IP configuration, remove power and move switch **2** up to its OFF position.



INSTALLATION

CONFIGURATION

OPERATION

FURTHER
INFORMATION

INDEX

Hot plugging and mouse restoration

It is strongly recommended that you switch off a server before attempting to connect it to the ServSwitch CX. However, if this is not possible then you need to 'hot plug' the server while it is still running. There is not normally a danger of damage to the server, however, when mouse communications are interrupted, often they fail to re-initialise when reconnected. The ServSwitch CX provides a feature to reinstate mouse communications once the necessary connections have been made.

There are two main types of data formats used by current PC mice, these are the older 'PS/2' or 'standard mouse' format and the more recent 'IntelliMouse®' format introduced by Microsoft. These use slightly different data arrangements and it is important to know which type was being used before you hot-plugged the server to the ServSwitch CX. The previous setting depends both on the type of mouse and the type of driver, as various combinations of PS/2 and IntelliMouse are possible. Using the incorrect restore function may produce unpredictable results and require the server to be re-booted.

Which restore setting do I use?

The general rule is that unless both the mouse *and* the driver are *both* IntelliMouse compatible then you need to restore the mouse as 'PS/2'. An IntelliMouse can operate in either mode, whereas a PS/2 mouse cannot.



Recognising an IntelliMouse-style mouse

The IntelliMouse format was introduced to support, among other features, the scroll wheel function. If the mouse has a scroll wheel, then it is likely to support the IntelliMouse format. If it is a Microsoft-branded mouse, then it will usually state that it is an IntelliMouse on its underside label.

Recognising an IntelliMouse driver

Before hot plugging to the ServSwitch CX (or afterwards using only keyboard control), access the Windows Control Panel of the server and select either the *Mouse* option (on Windows NT, 2000 and XP) or the *System* option (on Windows 95, 98, ME). Look for the name of the driver, which will usually include the words *PS/2* or *IntelliMouse*.

To restore mouse operation when hot plugging:

- 1 Using a suitable SAM (Server Access Module) and category 5, 5e or 6 link cabling, carefully make the connections between the keyboard, monitor, mouse (and audio) sockets of the server and the required ServSwitch CX port.
- 2 [Select the port](#) of the newly connected server and then display the [Configuration menu](#).
- 3 Highlight 'Functions' and press .
- 4 As appropriate, highlight one of the following options:
 - *Restore Standard Mouse* – if PS/2 mode is required, or
 - *Restore IntelliMouse* – if IntelliMouse mode is required.Then press .
- 5 Move the mouse a short distance and check for appropriate on-screen cursor movement. If the mouse cursor darts erratically around the screen, then cease moving the mouse. This is an indication that the chosen restore function is incorrect. Try again using the other restore function.

Note: The restore functions predict the likely mouse resolution settings but may not restore the exact speed or sensitivity settings that were originally set.



Initial IP configuration

IP models of the ServSwitch CX family possess a further collection of configuration options related specifically to IP networking. It is important that the options are correctly set up for your installation BEFORE being connected to an open IP network.

To configure IP-specific settings

- 1 From a local user port (for security reasons, the IP configuration option cannot be accessed from remote user ports), log on as 'admin' user.
- 2 Press **Ctrl** **Alt** **M** (hotkeys can be changed).
- 3 Press **F1** to select 'More menus'.
- 4 Select 'Functions' and then select 'Configure IP port'.

- If the unit is being configured for the first time or following a reset, the unit will display the first of five screens, as shown opposite ⇒

- If the unit has been previously IP-configured it will display the *IP Configuration* menu, as shown below ⇓

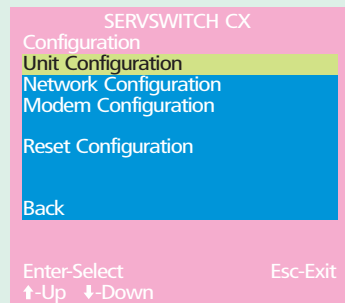

See [Configure IP port](#) for details.

Note: Screen 5 of 5 is displayed while the secure keys are being generated.

To use the initial IP-configuration sequence

Set the options in each screen and then select *Next* to proceed.

1		<p>Admin password Enter a password of at least six characters that has a mix of letters and numerals. The background colour provides an indication of password suitability and is initially red to indicate that the password is not sufficient. When a password with reasonable strength has been entered it will change to green.</p> <p>Time and Date Set these correctly as all entries in the activity log are time stamped using them.</p> <p>Encryption See Encryption settings for a description of the issues and the settings.</p>
2		<p>Use DHCP/IP address/Net Mask/Gateway You need to either set the DHCP option to 'Yes' or manually enter a valid IP address, Net mask and Gateway. See Networking issues for more details.</p> <p>VNC and HTTP ports These should remain set to 5900 and 80, respectively, unless they clash with an existing setup within the network. See Networking issues for more details.</p>
3		<p>Modem/ISDN port details The default items here are perfectly adequate for the majority of modem and ISDN terminal adapter installations.</p> <p>The Server IP and Client IP addresses are used to form an isolated two-device PPP network connection via the dial up link. Their settings are not related to any other 'real' network settings within the ServSwitch CX with IP unit.</p>
4		<p>Secure keys generation With every mouse move and keypress, the single dash will move across the screen (unless the same key is pressed repeatedly). Periodically, a new star character will be added to the bar as the random data are accepted as part of the new encryption key. When the bar is full, the final encryption keys for your ServSwitch CX with IP will be created – this process takes roughly 30 to 40 seconds. Once the secure keys have been calculated the ServSwitch CX with IP will show the IP configuration menu.</p>



INSTALLATION

CONFIGURATION

OPERATION

FURTHER INFORMATION

INDEX

IP configuration by global user



Once the basic IP-related features have been configured using the ServSwitch CX with IP configuration menus, further changes can be made by authorised global users via the VNC interface. There are two main ways to use the VNC interface to access the ServSwitch CX with IP unit:

- [The VNC viewer](#) – a small application supplied on the CD-ROM or downloadable from the RealVNC website or even downloadable from the ServSwitch CX with IP itself.

or

- [A standard browser that supports Java](#) – When a web browser makes contact, the ServSwitch CX with IP provides the option to download a Java application to it. This allows a viewer window to be opened and operation to commence just as it would with the VNC viewer application.

To configure IP details from a global user location

- 1 Use either the VNC viewer or a standard web browser to make remote contact with the ServSwitch CX with IP – see [Global user connections](#) for more details.
- 2 If the username entry is not blanked out, enter 'admin'. Then enter the admin password (if no password is set, then just press ). Once logged in, the ServSwitch CX with IP will show the video output from the host system (if one is connected), or otherwise a 'No Signal' message.
- 3 Click the Configure button in the top right hand corner of the window to display the main configuration page 



User Accounts
Allows you to create and manage up to sixteen separate user accounts, each with separate access permissions.

Unit Configuration
Allows you to alter both basic and fundamental settings within the ServSwitch CX with IP.

Time & Date Configuration
Allows you to configure all aspects relating to time keeping within the ServSwitch CX with IP unit.

Network Configuration
Here you can alter any of the existing network settings plus you can take advantage of the IP access control feature that lets you to specifically include or exclude certain addresses or networks.

Serial Port Configuration
Lets you setup or alter the details concerning the modem and power control serial ports.

Host Configuration
Allows you to configure user access, hot key switching and power control codes for up to 128 host systems that may be connected to the ServSwitch CX with IP via other cascaded units.

Logging and Status
Provides various details about the user activity on the ServSwitch CX with IP.

Shaded items signify options that are not available via the standard configuration menus.

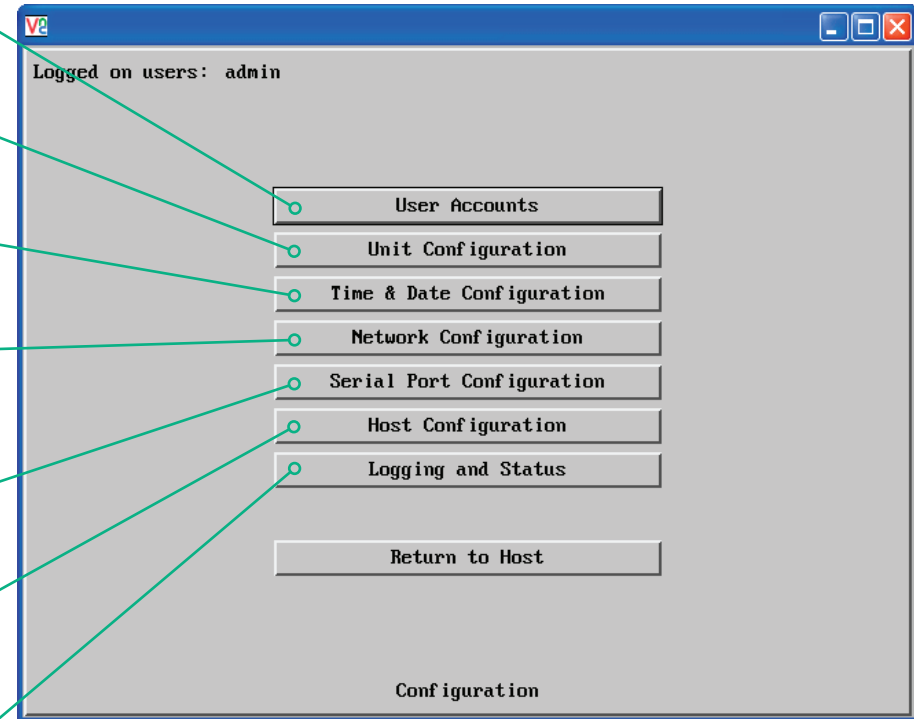

For more information about each page, please see [Appendix 2 - Configuration pages via viewer](#) in the 'Further information' chapter.



INSTALLATION

CONFIGURATION

OPERATION

FURTHER INFORMATION

INDEX

Encryption settings

The ServSwitch CX with IP offers a great deal of flexibility in its configuration and this extends equally to its encryption settings that are used to prevent unauthorised interception of signals. Due to the variety of situations in which the ServSwitch CX with IP might be used and the range of viewer applications that need to view it, a number of settings are available. The encryption settings to use depend upon how the potential global users will operate.

Important factors to consider when setting these options might be:

- Do all global user connections and operations require encryption?
- Will some global users be using older VNC viewer versions?

ServSwitch CX with IP encryption settings

The ServSwitch CX with IP configuration menu offers three encryption settings:

- **Always on** - This setting will force all viewers to use encryption. *Note: This setting will preclude any VNC viewer versions that do not support encryption.*
- **Prefer off** - This setting does not enforce encryption unless a viewer specifically requests it. If a viewer has its 'Let server choose' setting, then an un-encrypted link will be set up.
- **Prefer on** - This setting generally enforces encryption unless an earlier viewer version is unable to support it, in which case the link will be un-encrypted. If a viewer has its 'Let server choose' setting, then the link will be encrypted.

Viewer encryption settings

The web browser viewers and VNC viewers (of level 4.0b5S or higher) offer four encryption settings:

- **Always on** - This setting will ensure that the link is encrypted, regardless of the ServSwitch CX with IP encryption setting.
- **Let server choose** - This setting will follow the configuration of the ServSwitch CX with IP. If the ServSwitch CX with IP has 'Always on' or 'Prefer on' set, then the link will be encrypted. If the 'Prefer off' setting is selected at the ServSwitch CX with IP, then the link will not be encrypted.
- **Prefer off** - This setting will configure an un-encrypted link if the ServSwitch CX with IP will allow it, otherwise it will be encrypted.
- **Prefer on** - If the ServSwitch CX with IP allows it, this setting will configure an encrypted link, otherwise it will be un-encrypted.



INSTALLATION

CONFIGURATION

OPERATION

FURTHER INFORMATION

INDEX

Networking issues

Thanks to its robust security the ServSwitch CX with IP offers you great flexibility in how it integrates into an existing network structure. The ServSwitch CX with IP is designed to reside either on an internal network, behind a firewall/router or alternatively with its own direct Internet connection.



Positioning ServSwitch CX with IP in the network

Every network setup is different and great care needs to be taken when introducing a powerful device such as the ServSwitch CX with IP into an existing configuration. A common cause of potential problems can be in clashes with firewall configurations. For this reason the ServSwitch CX with IP is designed to be intelligent, flexible and secure. With the minimum of effort it can reside either behind the firewall or alongside with its own separate Internet connection.

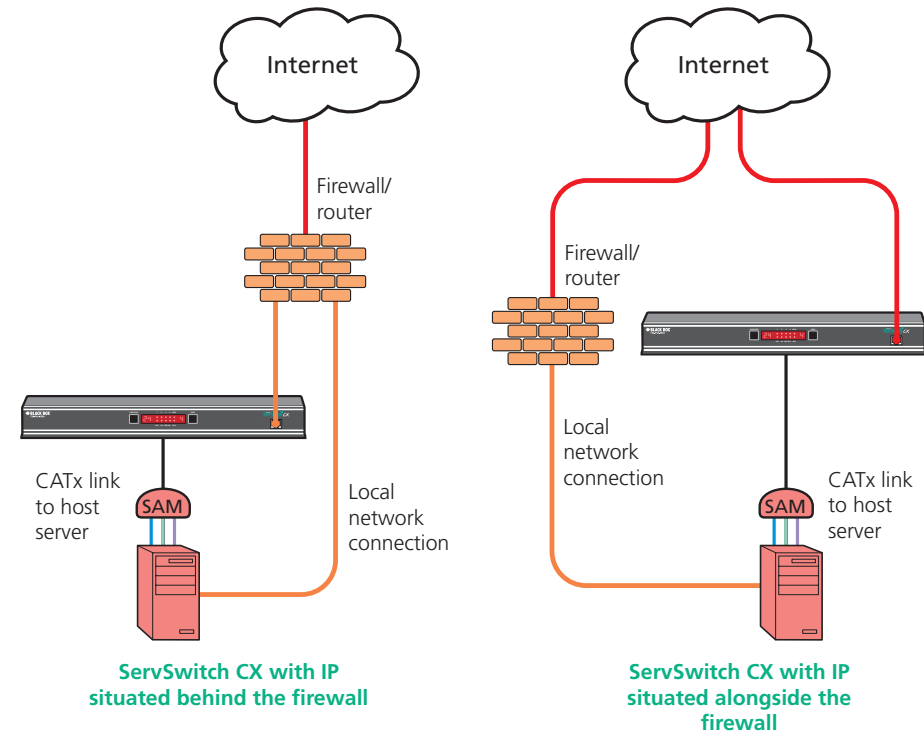

IMPORTANT: When the ServSwitch CX with IP is accessible from the public Internet or dial up connection, you must ensure that sufficient [security measures](#) are employed.

INSTALLATION

CONFIGURATION

OPERATION

FURTHER INFORMATION

INDEX

Placing ServSwitch CX with IP behind a router or firewall

A possible point of contention between the ServSwitch CX with IP and a firewall can occasionally arise over the use of IP ports. Every port through the firewall represents a potential point of attack from outside and so it is advisable to minimise the number of open ports. The ServSwitch CX with IP usually uses two separate port numbers, however, these are easily changeable and can even be combined into a single port.

IMPORTANT: The correct configuration of routers and firewalls requires advanced networking skills and intimate knowledge of the particular network. Black Box cannot provide specific advice on how to configure your network devices and strongly recommend that such tasks are carried out by a qualified professional.

Port settings

As standard, the ServSwitch CX with IP uses two [ports](#) to support its two types of viewer:

- **Port 80** for users making contact with a web browser, and
- **Port 5900** for those using the VNC viewer.

When these port numbers are used, VNC viewers and web browsers will locate the ServSwitch CX with IP correctly using only its network address. The firewall/router must be informed to transfer any traffic requesting these port numbers through to the ServSwitch CX with IP.

When a web server is also on the local network

Port 80 is the standard port used by web (HTTP) servers. If the ServSwitch CX with IP is situated within a local network that also includes a web server or any other device serving port 80 then, if you want to use the web browser interface from outside the local network environment, the HTTP port number of the ServSwitch CX with IP may need to be changed.

When you change the HTTP port to anything other than 80, then each remote browser user will need to specify the port address as well as the IP address. For instance, if you set the HTTP port to '8000' and the IP address is '192.168.47.10' then browser users will need to enter:

http://192.168.47.10:8000

(Note the single colon that separates the IP address and the port number).

The firewall/router would also need to be informed to transfer all traffic to the new port number through to the ServSwitch CX with IP.

If you need to change the VNC port number

If you change the VNC port to anything other than 5900, then each VNC viewer user will need to specify the port address as well as the IP address. For instance, if you set the VNC port to '11590' and the IP address is '192.168.47.10' then VNC viewer users will need to enter:

192.168.47.10::11590

(Note the *double* colons that separate the IP address and port number).

The firewall/router would also need to be informed to transfer all traffic to the new port number through to the ServSwitch CX with IP.

Addressing

When the ServSwitch CX with IP is situated within the local network, you will need to give it an appropriate local IP address, IP network mask and default gateway. This is achieved most easily using the DHCP server option which will apply these details automatically. If a DHCP server is not available on the network, then these details need to be applied manually in accordance with the network administrator.

The firewall/router must then be informed to route incoming requests to port 5900 or port 80 (if available) through to the local address being used by the ServSwitch CX with IP.

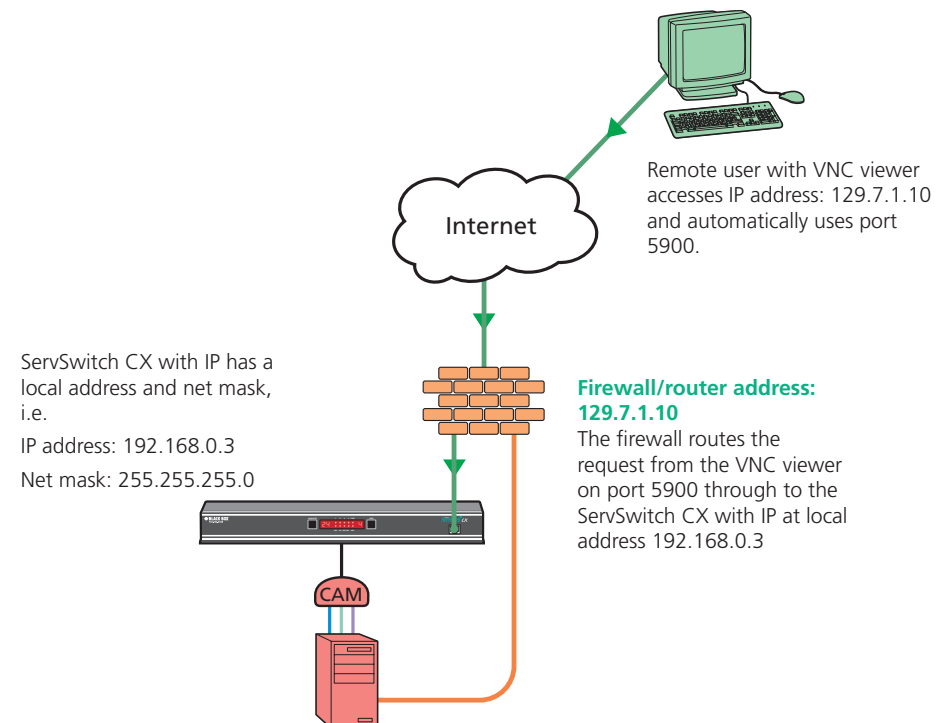

INSTALLATION

CONFIGURATION

OPERATION

FURTHER INFORMATION

INDEX



To discover a DHCP-allocated IP address

Once a DHCP server has allocated an IP address, you will need to know it in order to access the ServSwitch CX with IP via a network connection. To discover the allocated IP address:

- 1 In network section of either the [standard configuration menus](#) or the [configuration pages via viewer](#), set the 'Use DHCP' option to 'Yes' and select 'Save'. Once the page is saved, the ServSwitch CX with IP will contact the DHCP server and obtain a new address.
- 2 Re-enter the same 'Network configuration' screen where the new IP address and network mask should be displayed.

DNS addressing

As with any other network device, you can arrange for your ServSwitch CX with IP to be accessible using a name, rather than an IP address. This can be achieved in two main ways:

- For small networks that do not have a DNS (Domain Name System) server, edit the 'hosts' files on the appropriate remote systems. Using the hosts file, you can manually link the ServSwitch CX with IP address to the required name.
- For larger networks, declare the IP address and required name to the DNS server of your local network.

The actual steps required to achieve either of these options are beyond the scope of this document.

INSTALLATION

CONFIGURATION

OPERATION

FURTHER
INFORMATION

INDEX



Placing ServSwitch CX with IP alongside the firewall

ServSwitch CX with IP is built from the ground-up to be secure. It employs a sophisticated 128bit public/private key system that has been rigorously analysed and found to be highly secure (a security white paper is available upon request). Therefore, you can position the ServSwitch CX with IP alongside the firewall and control hosts that are also IP connected within the local network.

IMPORTANT: If you make the ServSwitch CX with IP accessible from the public Internet or from a modem, care should be taken to ensure that the maximum security available is activated. You are strongly advised to enable encryption and use a strong password. Security may be further improved by restricting client IP addresses, using a non-standard port number for access or limiting remote access to dial up connections only.

Ensuring sufficient security

The security capabilities offered by the ServSwitch CX with IP are only truly effective when they are correctly used. An open or weak password or unencrypted link can cause security loopholes and opportunities for potential intruders. For network links in general and direct Internet connections in particular, you should carefully consider and implement the following:

- Ensure that encryption is enabled.
By [standard configuration menu](#) or by [configuration page via viewer](#).
- Ensure that you have selected secure passwords with at least 8 characters and a mixture of upper and lower case and numeric characters.
By [configuration page via viewer](#).
- Reserve the admin password for administration use only and use a non-admin user profile for day-to-day access.
- Use the latest Secure VNC viewer (this has more in-built security than is available with the Java viewer). To [download the viewer](#).
- Use non-standard [port numbers](#).
- Restrict the range of IP addresses that are allowed to access the ServSwitch CX with IP to only those that you will need to use. To [restrict IP access](#).
- Do NOT Force VNC protocol 3.3. [Configuration page via viewer](#).
- Add a further level of inherent security by restricting access only via modem or ISDN dialup.
- Ensure that the server accessing the ServSwitch CX with IP is clean of viruses and spyware and has up-to-date firewall and anti-virus software loaded that is appropriately configured.
- Avoid accessing the ServSwitch CX with IP from public servers.

Security can be further improved by using the following suggestions:

- Place the ServSwitch CX with IP behind a firewall and use the port numbers to route the VNC network traffic to an internal IP address.
- Review the activity log from time to time to check for unauthorised use.
- Lock your server consoles after they have been used.

A security white paper that gives further details is available upon request.

Ports

In this configuration there should be no constraints on the port numbers because the ServSwitch CX with IP will probably be the only device at that IP address. Therefore, maintain the HTTP port as 80 and the VNC port as 5900.

Addressing

When the ServSwitch CX with IP is situated alongside the firewall, it will require a public static IP address (i.e. one provided by your Internet service provider).

More addressing information:

[Discover DHCP-allocated addresses](#)

[DNS addressing](#)

INSTALLATION

CONFIGURATION

OPERATION

FURTHER INFORMATION

INDEX

Power switching configuration

Power switch configuration comprises two main steps:

- Configure the POWER CONTROL serial port to the same speed as used by the power switch box(es), either [via configuration menu](#) or [via configuration page](#).
- Configure power ON and OFF strings for each relevant host server.

For each power port there needs to be a valid 'Power ON string' and similarly an appropriate 'Power OFF string'. In each case, the strings are a short sequence of characters that combine a port address and a power on or off value.

If a particular server has more than one power input (and thus requires an equivalent number of power ports to control them), collections of strings can be combined to switch all of the required ports together as a group.

To configure the power sequences for each host server

- 1 Using VNC viewer or a browser, log on as the 'admin' user.
- 2 Click the 'Configure' button in the top right corner.
- 3 Click the 'Host configuration' option.
- 4 Click a host entry to display a Host configuration dialog:

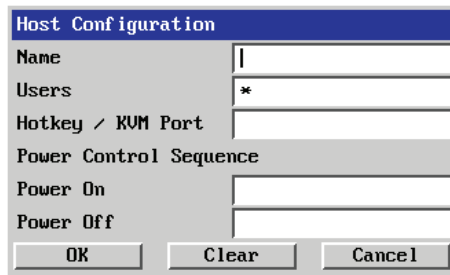

- 5 If necessary, configure other parameters (Name, Users, Hot Keys - [MORE](#)).
- 6 Enter the **Power control sequences** in the Power On and Power Off fields ⇒
- 7 Click OK to close the dialog and then click the Save button in the main Host Configuration window to store the details.

Power control sequences

Note: The settings given below are for the EPS-S8 power switch - other power switches may require different settings. Please refer to your power switch documentation for details about codes required by other power switches.

The structure of each power sequence (OFF and ON) is as follows:

$Pxy=z\backslash0D$

Where:

- x** is the switch box number,
- y** is the power port number,
- z** is '0' for OFF or '1' for ON, and
- \0D** represents Enter (or Carriage return).

Example 1

To switch ON port 5 of switch box 2, the code would be as follows:

- Power sequence: `P25=1\0D`

Example 2

To switch OFF port 8 of switch box 3, the code would be as follows:

- Power sequence: `P38=0\0D`

For details about operating this feature, see [Power switching \(via configuration menu\)](#) or [Power switching \(via viewer\)](#) within the Operation chapter.

To control two or more ports simultaneously

You can control up to four power ports using a single sequence. This is done using the same command structure as shown above, plus a delay command, for each port. Immediately following a port command, insert the characters '*' before the next port command, and so on up to four ports. For instance, to switch on ports 1 and 2 in the first power switch, the command line would be:

`P11=1\0D*P12=1\0D`



The KVMADMIN utility

Particularly useful for complex ServSwitch CX configurations and the control of remote installations, KVMADMIN is a powerful administration tool.

KVMADMIN is based upon the successful VNC viewer and uses the same security system. Rather than a graphical interface usch as the standard viewer, KVMADMIN uses command line control to provide the following administration facilities:

- Discover and adjust the ServSwitch CX configuration, including host systems,
- Save and restore the ServSwitch CX configuration,
- Set user names and passwords,
- Download the event log,
- Set custom video modes.

The use of KVMADMIN is strictly limited to the 'admin' user and for security purposes it is not possible to retrieve user names or passwords from the ServSwitch CX.

To use KVMADMIN you require the IP address and admin password of the ServSwitch CX unit. The command line is as follows:

```
kvmadmin <command> <ip address> [<parameters>]
```

where *<command>* is one of the following:

- *-setconfig <config-file>*
- *-getconfig <config-file>*
- *-setusers <csv-file>*
- *-getlog <log-file>*
- *-gethosts <csv-file>*
- *-sethosts <csv-file>*
- *-setmodes <csv-file>*

For instance, the command line:

```
kvmadmin -getconfig kvm1.cfg 192.168.2.1
```

... downloads the current configuration from the ServSwitch CX unit at the given address and stores it in the local file *kvm1.cfg*.

Whereas the command line:

```
kvmadmin -setusers users.csv 192.168.2.1
```

... configures the usernames and passwords for the same unit from the local file *users.csv*.

For more information about KVMADMIN, please refer to the user notes supplied with the utility.



INSTALLATION

CONFIGURATION

OPERATION

FURTHER INFORMATION

INDEX

Performing upgrades

The ServSwitch CX and CX with IP units are fully reconfigurable via flash upgrades, as are the individual Server Access Modules that are used to link all host servers. The ServSwitch CX with IP models operate in a slightly different manner to the non-IP models and so are upgraded differently:

- ServSwitch CX models and Server Access Modules require a Windows-based system to be linked via the COM1/UPGRADE port.
- [ServSwitch CX with IP models](#) are upgraded via IP link and require a network-connected Windows-based server system.

Upgrading ServSwitch CX models and SAMs

The KVM Firmware Uploader utility is available from Black Box support and allows you to check the current revision of the ServSwitch CX unit firmware as well as every Server Access Module connected to it.

Items required to use the upgrade utility

- Optional serial upgrade cable available from Black Box (see [Appendix 7](#) for pin-out specifications).
- A Windows-based upgrade system with an RS232 serial port.
- The latest version of the KVM Firmware Uploader and firmware files for the ServSwitch CX - available from Black Box support.

To use the KVM Firmware Uploader utility

1 - Obtain and run the KVM Firmware Uploader.

Download the latest ServSwitch CX KVM Firmware Uploader from Black Box and install it on a Windows-based upgrade server that will be connected to the ServSwitch CX unit. The files are supplied as a compressed ZIP file. Decompress the ZIP file with an appropriate tool such as WinZip (www.winzip.com) and copy all contained files to the same folder on the upgrade server.

2 - Power off the ServSwitch CX and select flash upgrade mode

Remove the power supply plug(s) from the rear panel of the ServSwitch CX and move option switch 1 on the back of the ServSwitch CX to the ON position (down).

3 - Connect the upgrade server to the ServSwitch CX

Connect the upgrade server to the COM1/UPGRADE port on the rear panel of the ServSwitch CX unit using the optional upgrade cable. You do not need to set the serial baud rate and protocol because the upgrade program will do this automatically.

4 - Power on the ServSwitch CX

Attach the power adapter to the ServSwitch CX. The USER display should now show  which indicates that the ServSwitch CX is ready to be upgraded.

5 - Run the KVM Firmware Uploader utility

From that folder, select the KVMUploader icon to run the upgrade utility. The KVM Firmware Uploader dialog will be displayed:

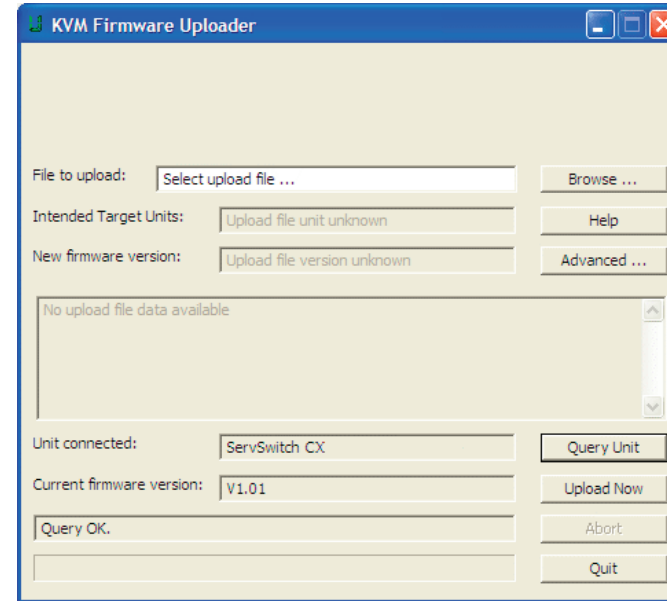

6 - Query the ServSwitch CX unit

Click the *Query Unit* button to confirm that communication is possible with the ServSwitch CX and to establish the firmware details of the main unit and all connected SAMs.

Note: The server to which each SAM is connected must be powered before the respective SAM can be accessed.

Note: ServSwitch CX units in lower levels of cascade links (and their respective SAMs) cannot be queried or upgraded while remaining in the cascade arrangement.

If the application cannot contact the ServSwitch CX, recheck the connection cable and click the *Advanced...* button to check that the correct serial port is being used. Change the serial port within the *Advanced* section, if necessary.



continued



The results of the unit query will be displayed in the Device/Dongle Selection dialog:

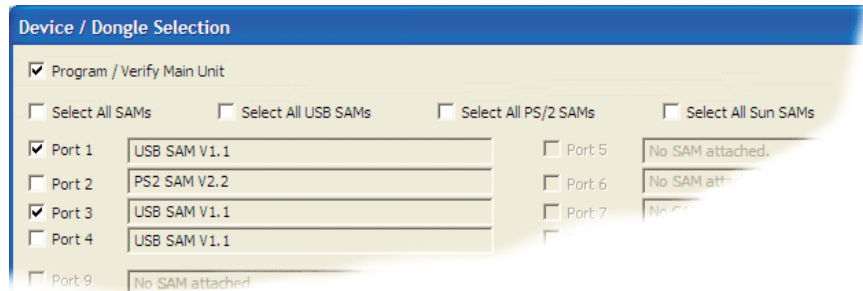

The type and firmware revision of each discovered SAM will be displayed alongside the port number to which it is connected.

7 - Select the items to be upgraded

Using the Device/Dongle Selection dialog you can determine which items should receive a firmware upgrade:

- Use the *Program / Verify Main Unit* option to include or exclude the ServSwitch CX unit itself.
- Use the *Select All SAMs* option to upgrade every discovered SAM.
- Use the *Select All USB / PS2 / Sun SAMs* options to upgrade only SAMs of a certain type.
- Use the individual port options to select particular SAM devices to upgrade.

When the required options have been selected, click OK.

Note: Approximate upgrade times are: ServSwitch CX unit = 4½ minutes; each selected SAM = 20 seconds.

8 - Select the upgrade file to be used

From the main KVM Firmware Uploader dialog, click the *Browse...* button and select the upgrade file that is appropriate to your ServSwitch CX unit:

ServSwitch CX 16 port: AVIP_16_Vxxx

ServSwitch CX 24 port: AVIP_24_Vxxx

where Vxxx is the upgrade file version number.

The upgrade file details will be displayed within the dialog.

IMPORTANT: Check that the 'Intended Target Units' field matches the 'Unit Connected' field. If these fields do not match then you may have an incorrect upgrade file, check with Black Box support before proceeding. Check also that the 'New firmware version' is greater than the 'Current firmware version'.

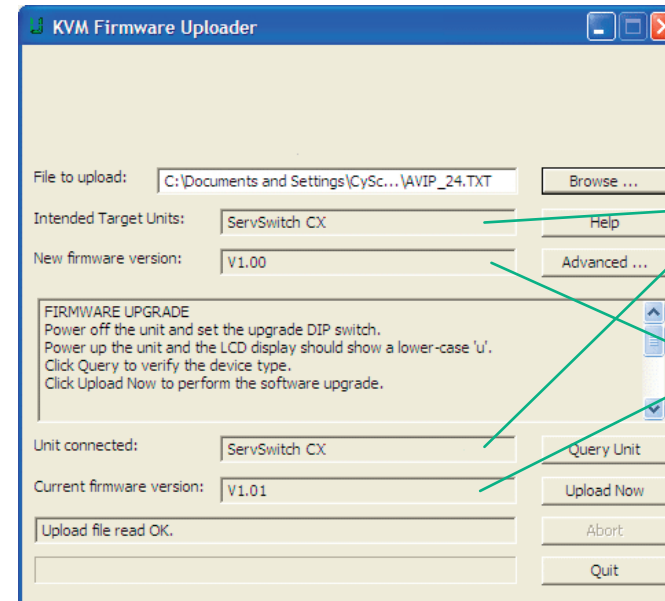

Check that the 'Intended Target Units' field matches the 'Unit Connected' field.

Check also that the 'New firmware version' is greater than the 'Current firmware version'.

9 - Commence the upgrade

To begin the upgrade process, click the *Upload Now* button. The progress will be shown within the dialog. Should you decide not to continue with the upload at any stage, click the *Abort* button; response to this is usually immediate, however, during an erase command, the upload will not be aborted until the erase is complete (this may take a few seconds).

10 - Change option switch 1 to the OFF position and cycle the power

Click switch 1 on the rear of the ServSwitch CX to the OFF position and disconnect the power. When the power is re-applied the ServSwitch CX will operate using the new firmware.

Issues to consider when performing flash upgrades

The upgrade program rewrites the ServSwitch CX firmware code. If the upgrade process is interrupted then the ServSwitch CX will have invalid code and will not be able to operate. It is therefore good practice to ensure that the upgrade process is always fully completed. A partial or failed upgrade may be rectified by performing another upgrade. If the upgrade process is interrupted accidentally then you should immediately repeat the upgrade process without moving switch 1 from the upgrade (ON) position. Switch 1 forces the ServSwitch CX into flash upgrade mode and prevents the upgraded code from being run. Running faulty or partially upgraded code may have unpredictable results and may damage your ServSwitch CX or computing equipment.

WARNING: Running faulty or partially upgraded code may have unpredictable results and may damage your ServSwitch CX or computing equipment.

Upgrading ServSwitch CX with IP models

The ServSwitch CX with IP models are upgraded via global connection (through the IP network port). Upgrades are digitally signed using a secure key. This prevents unauthorised or altered firmware images being downloaded into the ServSwitch CX with IP.

To upgrade ServSwitch CX with IP models

- 1 Download the latest firmware revision for the ServSwitch CX with IP from Black Box support and decompress the download file. View the decompressed files and make a note of the name and location of the *.bin* file that was part of the download file collection.
- 2 Make a [global connection](#) to the ServSwitch CX with IP unit and login as the admin user.
- 2 Once logged in, click the *Configure* button in the top right corner of the window.
- 3 Click the *Unit Configuration* button.
- 4 Click the *Advanced Unit Configuration* button.
- 5 Click the *Upgrade Firmware* button. The following dialog will be displayed:

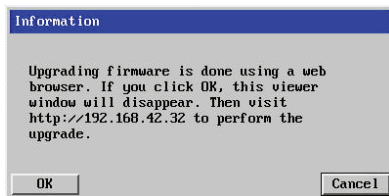

- 6 Click OK. The ServSwitch CX with IP is now ready to accept the upgrade files. Open your browser and log into the ServSwitch CX with IP using the IP address that was confirmed in the dialog. Once connected, the ServSwitch CX with IP will offer the following screen:



- 7 Click the *Browse* button and locate the *.bin* upgrade file that you downloaded earlier. The ServSwitch CX with IP will show the following screen:



- 8 Select which portion of the ServSwitch CX with IP that you wish to upgrade. Tick both options to upgrade the complete unit. When ready, click the *Perform upgrade* button. The upgrade will take place and its progress will be shown on screen.



Operation



The front panel controls

ServSwitch CX models

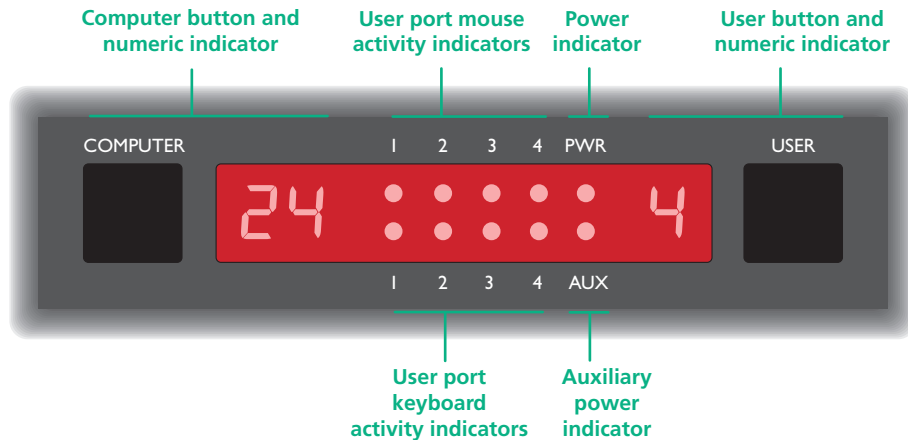

ServSwitch CX with IP models

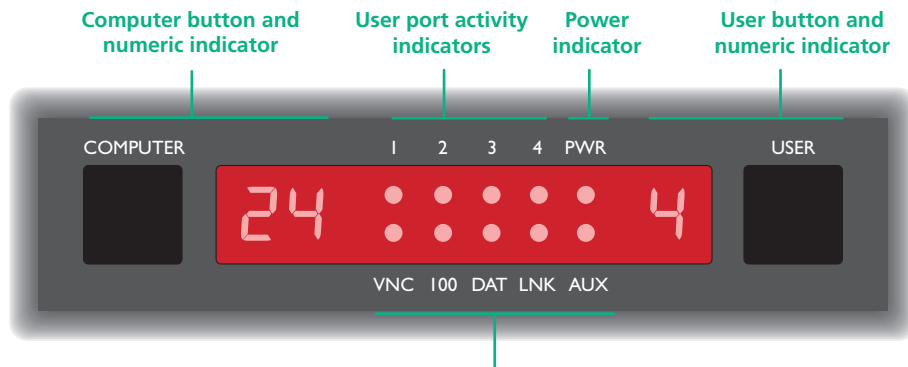

Indicators

- **VNC** Indicates that a global user is connected and active.
- **100** Indicates the Ethernet network speed (10/100Mbps).
- **DAT** Network activity indication.
- **LNK** Network link present.
- **AUX** Auxiliary power input indicator.

COMPUTER button and numeric indicator

These items allow you to select any one of the ServSwitch CX server ports. As you press the **COMPUTER** button, the adjacent number will increment to the next available server channel. The server port selected will then be connected to the current user port.

USER button and numeric indicator

These items allow you to select any one of the ServSwitch CX user ports. As you press the **USER** button, the adjacent number will increment to the next available user port. At the same time, as each user port number is displayed, the server channel that is currently associated with that port will be indicated by the Server indicator.

Accessing the ServSwitch CX

The ServSwitch CX and CX with IP offer three main ways to gain access:

- [Local user access](#),
- [Remote user access](#) via a ServSwitch CX Remote extender, or
- [Global user access](#) via IP network link or direct dial up.

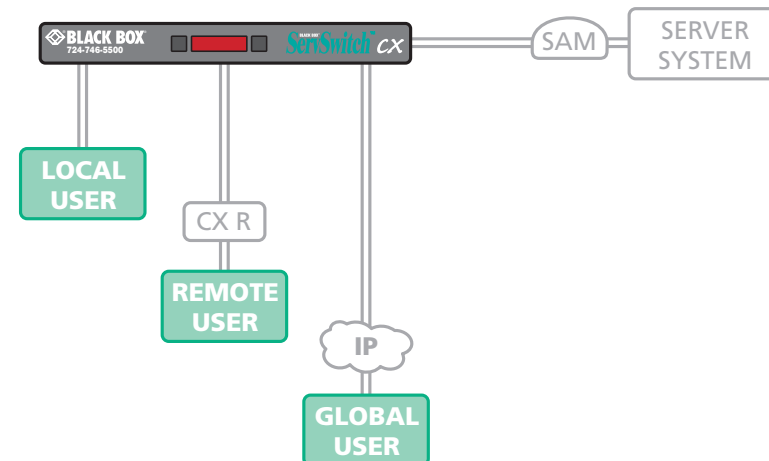

Local and remote user access

Local users (directly connected) and remote users (via a ServSwitch CX Remote extender) gain access to the ServSwitch CX unit in exactly the same way. [Global users](#), linking via a special viewer, are handled in a different manner.

To gain access as a local or remote user:

- 1 From a local or remote keyboard, press any key to display the login prompt:



If the above login prompt is not displayed, you are either already logged in to the ServSwitch CX unit, or the security features have not been implemented. In such cases see 'To view this menu at any time' below.

- 2 Enter your username and password. Providing you have the correct permissions, the screen will display the main menu, showing you a list of servers for which you have permission to access:

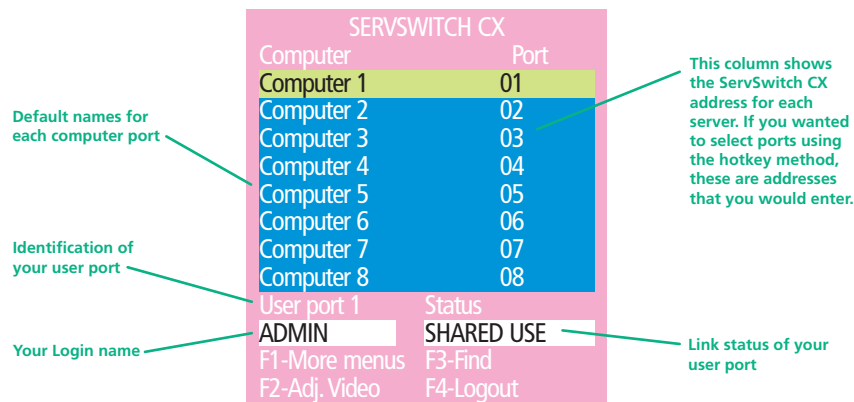

To view this menu at any time: Press and hold the hotkeys (usually **Ctrl** and **Alt**), then press **M** and finally release all three keys.

*Note: The **Ctrl** and **Alt** keys when pressed in combination are called 'hotkeys' and they signal to the ServSwitch CX that you wish to control it, rather than the host server. However, if these particular hotkeys clash with another device or program, then your administrator may change them to a different combination. If the **Ctrl Alt M** combination fails to work, then please contact your system administrator for details.*

Selecting a server

There are four main ways for local and remote users to select a specific server channel:

- *Using the front panel controls* (discussed below) – this is a straightforward method, if the ServSwitch CX is nearby.
- [Using hotkeys](#) – this is a good method if you continually access a small number of servers.
- [Using the on-screen menu](#) – this is the best method when there are many connected servers.
- [Using mouse buttons](#) – this is a good method for cycling between a small number of servers.

For all methods (if the [confirmation box option](#) is enabled), when the required port is selected, a pop up message will be displayed to confirm the server name or number, and its status. Alternatively, an error message explaining why a connection is not possible (press **Esc** to cancel the latter type of message).

To avoid the 'hall of mirrors' effect

IMPORTANT: Never configure a system so that your viewer is viewing itself.

When controlling a host server via the local user port or a remote user port, if the host server is networked it is possible to make the VNC viewer or a browser to create a link back to itself via the global (IP) capabilities of the unit. This will set up a 'hall of mirrors' effect, where the server is viewing itself into infinity.

While technically possible, the ServSwitch CX with IP unit is not designed to withstand this treatment and could sustain damage.

To select a server using the front panel controls

Note: It is possible for the front panel controls to be limited to selecting only the on screen menu or a blank screen. If this is the case please use a different switching method or contact your system administrator for details.

- 1 Press the **USER** button until the adjacent numeric indicator displays the port number to which you are connected.
- 2 Press the **COMPUTER** button until the adjacent numeric indicator shows the required server channel number.

Note: If security has been enabled then only server channels to which the current user port has permission will be displayed.

As well as the 16 (or 24) standard server ports, there are also two additional special ports that appear after the last port, either 16 or 24:

- This port provides no video signal so that a connected power saving monitor will be prompted to enter into its power saving mode.
- This port connects the current user port to the on-screen menu.





To select a server using hotkeys

- 1 Simultaneously press and hold **Ctrl** and **Alt**.

*Note: The **Ctrl** and **Alt** keys when pressed in combination are called 'hotkeys' and they signal to the ServSwitch CX that you wish to control it, rather than the server. However, if these particular hotkeys clash with another device or program, then your administrator may change them to a different combination. If the **Ctrl** **Alt** combination fails to work, then please contact the system administrator for details.*

- 2 While still holding **Ctrl** and **Alt**, press the first numeral of the required port address, then:
 - If the port address is a single character, release all of the keys.
 - If the port address is two or more characters, release the first numeral key and press the second – repeat this procedure until all of the port address numerals have been entered, then release **Ctrl** and **Alt**.

Note: The numbers on your keyboard's numeric keypad are not valid, use only the numeral keys above the QWERTY section.

Note: The numbers on your keyboard's numeric keypad are not valid, use only the numeral keys above the QWERTY section.

Note: If your user port does not have authorisation to view the selected port then an 'Insufficient user rights' messages will be displayed.

Standard hotkeys

The range of hotkey combinations are as follows:

*Note: If your hotkeys have been changed, substitute them for **Ctrl** and **Alt** in the examples given here.*

Ctrl **Alt** **1**

Selects port 1

Ctrl **Alt** **2**

Selects port 2

•

•

•

•

Ctrl **Alt** **1** then **0**

Selects port 10

•

•

Ctrl **Alt** **2** then **4**

Selects port 24

*Note: When entering multiple digit addresses as above or for even longer cascaded servers, keep **Ctrl** and **Alt** pressed down until all other numbers have been entered.*

Ctrl **Alt** **Tab**

Selects the next available port

Ctrl **Alt** **A**

Selects autoscan mode where each (authorised) port is displayed for a period determined by the administrator. To cancel autoscan mode, simply select any fixed channel using any of the suggested methods.

Ctrl **Alt** **0**

Switches off the video signal – this will cause a power saving monitor to enter its standby mode. To awaken the monitor, simply select any fixed channel using any of the suggested methods.

Ctrl **Alt** **L**

Logs out the current user (if security is enabled) or selects port 0 to disable the video signal (if security is disabled).

Ctrl **Alt** & **↓**, **↑**, **←** or **→**

Moves the currently displayed on-screen menu around the screen.



To select a server using the on-screen menu

- 1 Select the on-screen menu in one of three ways:
 - By simultaneously pressing and then releasing .
 - By pressing the middle and right buttons of a three button mouse, or
Note: The mouse switching option is usable only if the 'Mouse Switching' option is enabled. See [Global preferences](#) for more details.
 - By selecting port using the front panel buttons (see previous).

At this point, depending on the security settings and the current log in situation, one of two things will be displayed, either the login screen, or the Selection menu:

The login screen - here you enter a valid User Name and Password – see [Logging in and out](#) for more details. When you do so, the ServSwitch CX selection menu will be displayed:

The Selection Menu – here you can select servers by name.

- 2 Use the and keys (or the scroll wheel of an IntelliMouse) to highlight the required server name. Alternatively (for large configurations), press to perform an alphabetical search for a particular port name.

Note: If security has been enabled then only servers to which the current user port has permission will be displayed.

- 3 Select the highlighted port in one of three ways:
 - *Shared use* - press - This *standard* method allows other users to view the same server port. Control of the port is given to one user at a time, on a first-come, first-served basis and is relinquished after a certain period of inactivity.
 - *Exclusive use* - press – This mode prevents any other user from viewing or controlling the server port until you either select another server or log off. This mode should be used with care – it can also be blocked as an option by the administrator.
 - *Video Only* - press – This mode displays the video picture of the port, but prevents keyboard or mouse activity from controlling the server.

To select a server using mouse buttons

Note: This procedure works only with three-button or IntelliMouse devices and only if the 'Mouse Switching' option has been enabled by your administrator.

- 1 Hold down the middle button (or scroll wheel) of the mouse.
- 2 Click the left mouse button to select the next server port. When the correct port is reached, release the middle button.

Note: If security has been enabled then only servers to which you have permission will be displayed.

To select a server using mouse buttons – Advanced method

- 1 Select the on-screen menu by pressing the middle and right buttons of a three button mouse.
- 2 Use the scroll wheel to highlight the required server port.
- 3 Then, select either:
 - *Shared Use* - press the left mouse button - This *standard* method allows other users to view the same server port. Control of the port is given to one user at a time, on a first-come, first-served basis and is relinquished after a certain period of inactivity.
 - *Exclusive Use* - press and the left mouse button – This mode prevents any other user from viewing or controlling the server port until you either select another server or log off. This mode should be used with care – it can also be blocked as an option by the administrator.
 - *Video Only* - press and the left mouse button – This mode displays the video picture of the port, but prevents keyboard or mouse activity from controlling the server.
 - *Escape without selecting a port* – press the right mouse button.

Logging in and out

The ServSwitch CX features a straightforward security system that helps to prevent unauthorised access to some, or all connected servers.



If the security option has been selected by your administrator then you will be asked to enter a *User Name* and *Password* when you first access a user port. When you have finished using the server, it is then good practice to logout, forcing any other users to authenticate themselves prior to use.

Note: If the security option has not been enabled then no login is required.

To log in to the ServSwitch CX

- 1 If it is not already displayed, move the mouse or press any key to display the log in screen.



- 2 Enter your designated *User Name* and press .
- 3 Enter your designated *Password* and press . If both entries are correct then the selected port will be displayed.







Note: If either the User Name or Password are incorrect, the entries will be cleared to allow another attempt.

To log out from the ServSwitch CX

Either:

- Press   and  at any time to log out.

or

- 1 Select the on-screen menu in one of three ways:
 - By simultaneously pressing and then releasing   .
 - Note: The  and  hotkeys may have been changed. If the combination fails to work, then please contact the system administrator for details.*
 - By pressing the middle and right buttons of a three button mouse, or
 - By selecting port  using the front panel buttons
- 2 Press . You will be logged out and the login window will be re-displayed.

Selecting cascaded servers









The ServSwitch CX is not limited to sharing just sixteen or twenty four servers. By joining numerous ServSwitch CX products together in a tree-like or [cascade](#) arrangement, it is possible for each user port to view many more servers. Although you can use exactly the same selection methods to choose any server, you are strongly recommended to use the on screen menu method for the following reasons:

- The [on screen menu](#) – this method displays the names of each server in alphabetical order and also allows you to search for them by name, press  – a useful feature in a long list. This really is the best way to access a large number of servers.
- The [mouse method](#) – this method is fine for small numbers of servers but can take too long to reach the required server in an extensive configuration.
- The [hotkey method](#) – depending on their position within the connection structure, each server can have an address up to six digits long which can be difficult to remember and laborious to type.

The confirmation box

The ServSwitch CX provides the option of a confirmation box that is displayed on screen for three seconds after a server is selected. The confirmation box indicates the current user port and your user name, the selected server and the connection status. You can enable or disable the confirmation box, as required.

To enable/disable the confirmation box

- 1 Select the on-screen menu in one of three ways:
 - By simultaneously pressing and then releasing   .
 - By pressing the middle and right buttons of a three button mouse, or
 - By selecting port  using the front panel buttonsIf you are not already [logged in](#), do so now.
- 2 Press  to select 'More menus'.
- 3 Highlight the 'User Preferences' option and press  to select.
- 4 Highlight the 'Confirmation Box' option and press  to select 'ENABLED' or 'DISABLED', as required.
- 5 Press  to save the settings. Press  twice more to return to the server port and view your changes.



The reminder banner

As many server screen layouts can appear very similar, the ServSwitch CX provides a reminder banner option that indicates which server port you are currently viewing. The banner is usually displayed at the top of the screen, using blue lettering and transparent background. You can:

- Move the banner
- Change the banner colours, and/or
- Disable the banner

To move the reminder banner

1 While viewing a server port, press and hold **Ctrl** and **Alt**.

*Note: The **Ctrl** and **Alt** hotkeys may have been changed. If the combination fails to work, then please contact the system administrator for details.*

2 Press the **↓**, **↑**, **←** and **→** keys to move the banner to the required position.

To change banner colours or disable the banner

1 Select the on-screen menu in one of three ways:

- By simultaneously pressing and then releasing **Ctrl** **Alt** **M**.
- By pressing the middle and right buttons of a three button mouse, or
- By selecting port **0** using the front panel buttons

If you are not already [logged in](#), do so now.

2 Press **F1** to select 'More menus'.

3 Highlight the 'User Preferences' option and press **↓** to select.

4 Select the required option:

- To disable the banner – highlight 'Reminder Banner' and press **Space** until 'DISABLED' is shown.
- To change colours – highlight 'Reminder Colour' and press **Space** until the desired colour combination is displayed.

5 Press **Esc** to save the settings. Press **Esc** twice more to return to the server port and view your changes.

Routing status

On occasions it may be useful to know which servers are being accessed, in which modes and by whom. The most common reason for this would be if you were denied access to a server port and needed to find out if another user has selected 'Exclusive' access. For this purpose the ServSwitch CX provides the very handy Routing status feature which provides an 'at a glance' view of all current user connections.

To use the Routing status feature

1 Select the on-screen menu in one of three ways:

- By simultaneously pressing and then releasing **Ctrl** **Alt** **M**.

*Note: The **Ctrl** and **Alt** hotkeys may have been changed. If the combination fails to work, then please contact the system administrator for details.*

- By pressing the middle and right buttons of a three button mouse, or
- By selecting port **0** using the front panel buttons

If you are not already [logged in](#), do so now.

2 Press **F1** to select 'More menus'.

3 Use **↓** or your mouse scroll wheel to highlight the 'Routing status' option.

4 Press **↓** or the left mouse button to select. The Routing status screen will be displayed:

Routing Status	
User 1	: ADMIN
Computer	: Internet Gateway
Port: 01	EXCLUSIVE USE
User 2	: SAM
Computer	: Technical Server
Port: 16	SHARED USE
User 3	: NO USER
Computer	:
Port: 00	NOT CONNECTED
User 4	: NO USER
Computer	:
Port: 00	NOT CONNECTED
Esc-Quit	

Here you can instantly see which server ports are being accessed and by whom. The screen will be displayed for ten seconds.







Power switching (via configuration menu)

When used in conjunction with optional power switch boxes, the ServSwitch CX with IP allows you complete remote control over the connected servers. The primary function of the power switching option is to remotely power down and reset servers that are failing to respond.

To switch a server on or off

1 Select the on-screen menu in one of three ways:

- By simultaneously pressing and then releasing   .

Note: The  and  hotkeys may have been changed. If the combination fails to work, then please contact the system administrator for details.

- By pressing the middle and right buttons of a three button mouse, or
- By selecting port  using the front panel buttons

If you are not already [logged in](#), do so now.

2 Switch to the server port that needs to be switched on or off.



Note: If the server is still responding, try to shut it down normally before attempting a power switch operation.

3 Display again the on screen menu and press  to select 'More menus'.

4 The 'Functions' option should be highlighted, press .

5 Highlight 'Power Control' and press .

6 Highlight either 'Switch Server ON' or 'Switch Server OFF' as necessary and press . A warning message with two options will be displayed:

7 Press  to confirm or  to confirm and exit. The latter option clears the menu so that, if required, you can be ready to enter any escape sequences that are needed by the server (to access its BIOS setup area), during the bootup sequence.

User preferences and functions

In addition to customising the reminder banner as described earlier, you can also:

- Change the colour of the on screen menu,
- Select the screen saver style,
- Restore mouse operation, or
- Perform power control functions.

All of these options are discussed within [Appendix 1](#).



INSTALLATION

CONFIGURATION

OPERATION

FURTHER
INFORMATION

INDEX

Global user access

Global users access the ServSwitch CX with IP using a viewer and a link. There are two types of viewer and two types of link, which can be used in any combination.

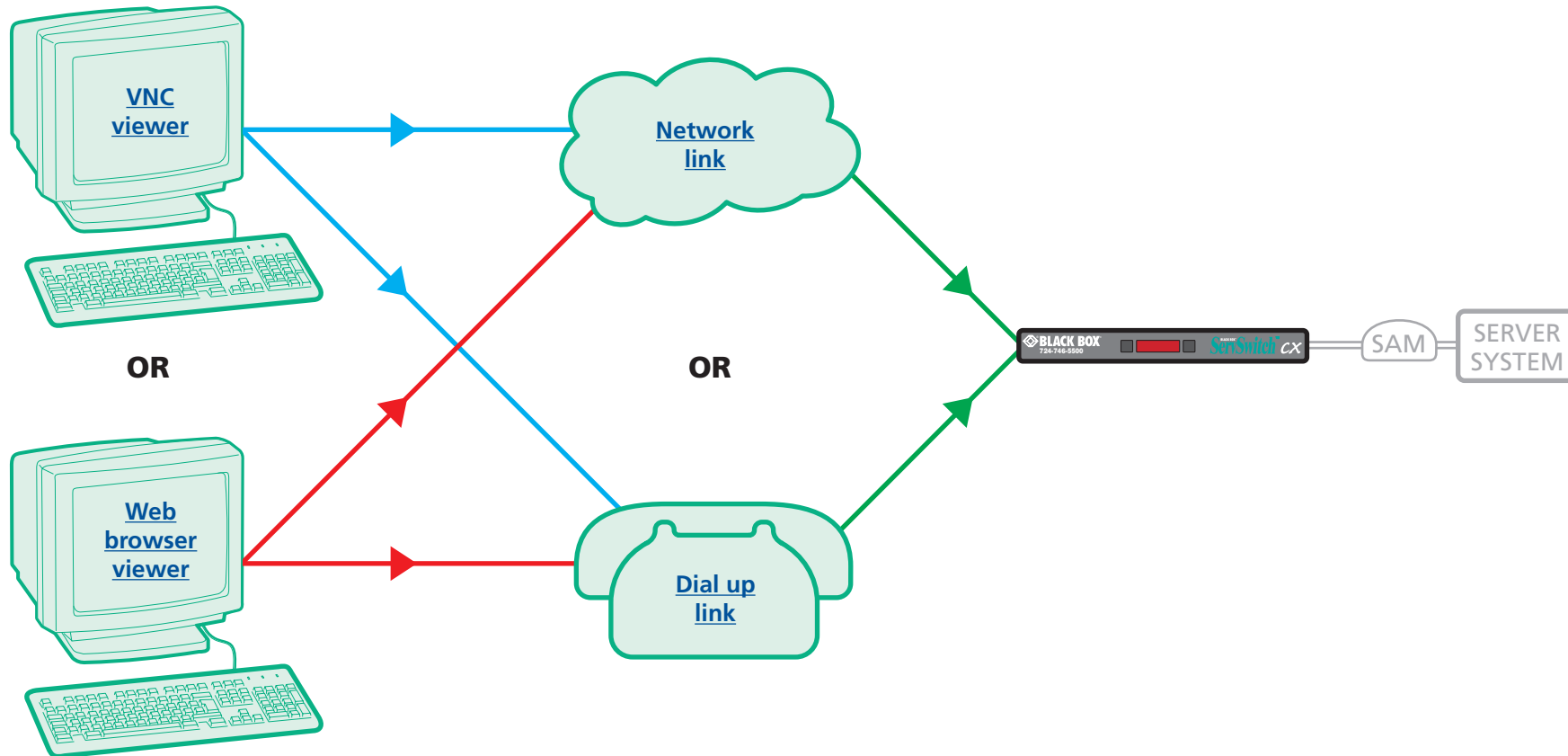

INSTALLATION

CONFIGURATION

OPERATION

FURTHER INFORMATION

INDEX

Global user access via VNC viewer

The VNC viewer is a compact application that runs on your IP-connected 'global' system and allows you to view and use the ServSwitch CX and its host server(s). VNC viewer is readily available from a number of different sources:

- from the ServSwitch CX installation CD
- from the ServSwitch CX itself
- from the [RealVNC website](#)

To access via the VNC viewer

1 Locate and select the VNC viewer icon ⇒



- [If you are using a dial up link.](#)

A connection details dialog will be displayed:

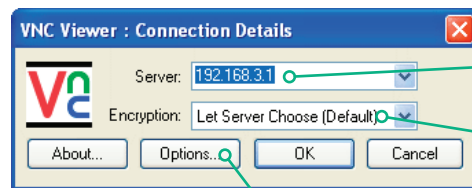

Enter the ServSwitch CX address here and click OK

If required, select the encryption mode - [MORE \[+\]](#)

Options button

Provides a range of viewer and connection settings - [MORE \[+\]](#)

2 In the 'Server:' entry, type the address of the ServSwitch CX as follows:

v.w.x.y

where v.w.x.y is the IP network address, for example 192.168.0.3

- [If you have been asked to also enter a port number.](#)

3 Click the OK button. Depending on the options selected, you may need to confirm certain items. A connection attempt will be made and if successful, an authentication dialog will be displayed:

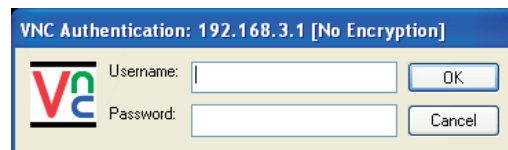

4 Enter your username and password. The [viewer window](#) should now open and show the current host server. *Note: If the Username entry is blanked out then only admin user account is currently defined and only a password is required.*

Downloading VNC viewer from the ServSwitch CX with IP

The ServSwitch CX has the ability to distribute its own VNC viewer application.

To download the VNC viewer

- 1 Open your Web browser.
- 2 Enter the network address where the ServSwitch CX is situated (in the form: http://192.168.0.3) and make the link.
- 3 In the opening ServSwitch CX screen, click the link that offers to download the secure VNC viewer 'from the unit'.
- 4 Save the download file (vncviewer.exe) to your system.
- 5 Select and run the downloaded file and then connect to the ServSwitch CX using the VNC viewer application.

IMPORTANT: During login, if you see a warning message similar to the one shown here, then **stop** and do not proceed.

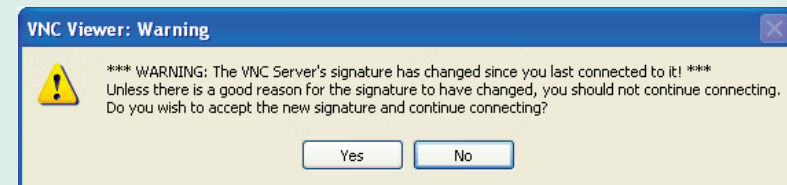

This message is displayed if a ServSwitch CX with IP unit, that your viewer has previously visited, has had a change of security keys. This is not uncommon if a unit is reset for some reason. However, it could also mean that your trusted unit is being spoofed and you may not be connecting to the system that you think you are.

Do not click the Yes button until you have checked with your administrator that the trusted ServSwitch CX with IP unit has been recently reset for some reason.



Global user access via web browser

You can use a standard Web browser ([supported versions](#)) to gain access to the ServSwitch CX with IP and its host server(s). As soon as you make contact with the ServSwitch CX with IP it will begin downloading a small Java application to your browser, which will be used only for the duration of your connection.

To access via your web browser

- 1 Launch your standard Web browser as usual.
 - [If you are using a dial up link.](#)
- 2 In the Address section, type the address of the ServSwitch CX with IP as follows:

http://v.w.x.y

where v.w.x.y is the IP network address, for example 192.168.0.3

- [If you have been asked to also enter a port number.](#)
- 3 Press . A connection attempt will be made.
 - 4 In the browser window, select the 'Connect using built-in Java VNC viewer' option to download a small application that will temporarily empower your browser (on slow connections the application download can take several tens of seconds to complete). Once complete, a connection details dialog will be displayed:

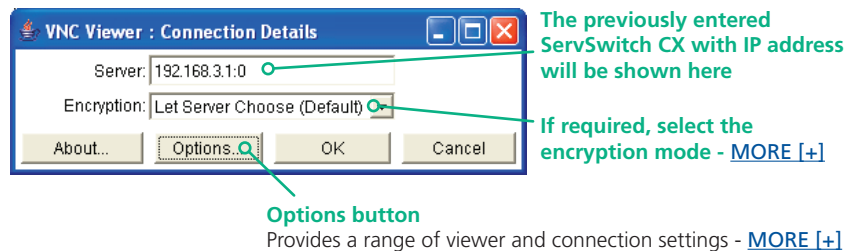

- 5 Make any necessary option/encryption changes and click the OK button to proceed. Depending on the options selected, you may need to confirm certain items.
- 6 A second connection attempt will be made and if successful, an authentication dialog will be displayed:

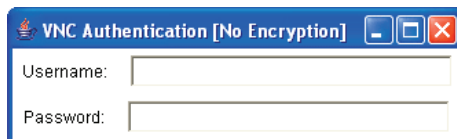

- 7 Enter your username and password. The [viewer window](#) should now open and show the current host server. *Note: If the Username entry is blanked out then only admin user account is currently defined and only a password is required.*

IMPORTANT: During login, if you see a warning message similar to the one shown here, then **stop** and do not proceed.

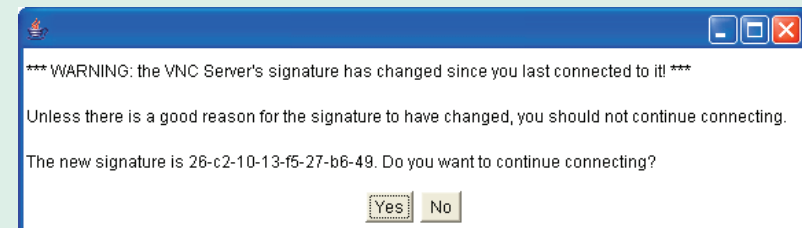

This message is displayed if a ServSwitch CX with IP unit, that your viewer has previously visited, has had a change of security keys. This is not uncommon if a unit is reset for some reason. However, it could also mean that your trusted unit is being spoofed and you may not be connecting to the system that you think you are.

Do not click the Yes button until you have checked with your administrator that the trusted ServSwitch CX with IP unit has been recently reset for some reason.



Using the viewer window

The viewer window gives you the ability to view and control the ServSwitch CX with IP and its host server(s). Its operation is almost identical regardless of whether you used the VNC viewer or your Web browser to display it.

The menu bar

The viewer window presents a menu bar similar to that shown below. Certain items within the toolbar are displayed depending upon your access permissions and/or the ServSwitch CX with IP configuration.

Viewer options

(VNC viewer only) Click the VNC icon to view the viewer window options.

Ctrl Alt Del

Sends the Ctrl Alt Del sequence to the current host server.

Controls

Displays a menu of options concerning keyboard, video and mouse operation.

Power

Click to access the power on/off options for the current host server.

Dialogue area

Indicates your username and the host system that you are currently viewing. This area can also display other messages.

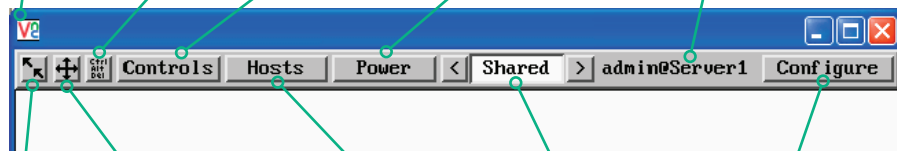

Re-sync mouse

Ensures that the mouse pointer which you move and the mouse pointer on the host system are correctly synchronised.

Auto calibrate

Determines the optimum video and/or mouse settings for the currently selected host server. This button will flash red when a new host screen is encountered. Click this button when you first visit a new screen.

Hosts

Click to display a list of servers. Choose an entry to connect to that host server.

Access mode

Allows you to choose between Shared and Private access modes.

Configure

This option is only available to the admin user and provides access to the main configuration menus.

When using the viewer window

What is the best screen resolution to use?

The best resolution for your server is one that is larger than the screen of the host server that you are viewing. This will allow you to see everything without scrolling around. Alternatively, the VNC viewer can be set to scale the image to fit your screen, but remember that some pixel dithering effect will be seen when scaling is used.

How do I navigate around a larger screen?

If the screen that you are viewing has a larger resolution than your viewing window you will need to scroll around to see all items. The viewer window allows you to 'bump scroll' (only in full screen mode). This means that when your mouse cursor bumps against the edge of the screen, the screen image will scroll across automatically.

How do I escape from full screen mode?

Press the F8 button. This button is changeable but is most often set to F8.

Why is the button flashing red?

This happens when a new host screen is viewed (that has not been viewed before). Click the  button to perform an auto calibration for the screen and the mouse. See [Auto calibrate](#) for important information about this feature.

How do I change between host servers?

The best way to change between host servers is to click the 'Hosts' button and then select the required server by name. See [Host selection](#).

How do I remove traces of moved items from the screen?

When you move an item or window across the screen, sometimes it can leave unsightly trails. These are called *artifacts* and can be particularly prevalent when the connection speed is low. To remove artifacts, click the 'Controls' button and select the 'Refresh screen' option. See [Controls](#).

How do I make the most of a slow connection?

The VNC viewer is slightly better suited to slower connections than the browser viewer because it offers more options. Click the [Options](#) button of the VNC viewer when entering the ServSwitch CX with IP address during log on.

Adjust the Threshold setting

Ensure that the video [Threshold setting](#) is set higher than the automatic setting suggests. Tweak this setting manually to ensure the best setting.

Fewer colours

Select the [Low \(64 colours\)](#) mode. The Very low option offers hardly any improvement and looks a lot worse.

Rate limit mouse events

When selected, this mode greatly reduces the mouse movement data that are sent to the host server. When you move the local mouse, the remote cursor will catch up roughly once per second.



Mouse pointers

Both viewers provide a double mouse cursor to help overcome any delays caused by slow connections. When you move your mouse you will see two mouse cursors, a local one that responds immediately to your movements and a second, slower moving, cursor that represents the current mouse position at the host.

For the browser viewer, the local cursor is a typical arrow:

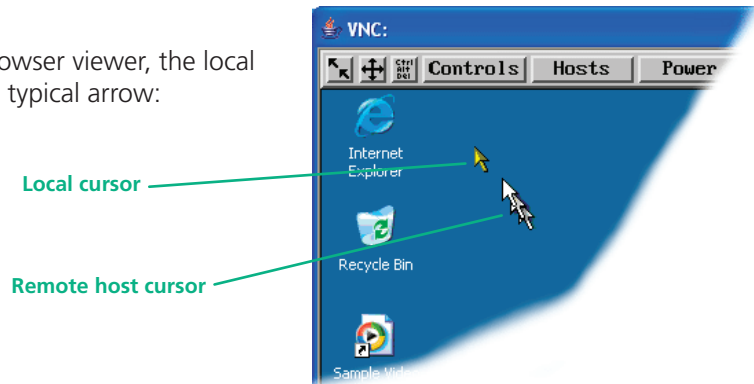

For the VNC viewer, the local cursor is a dot:

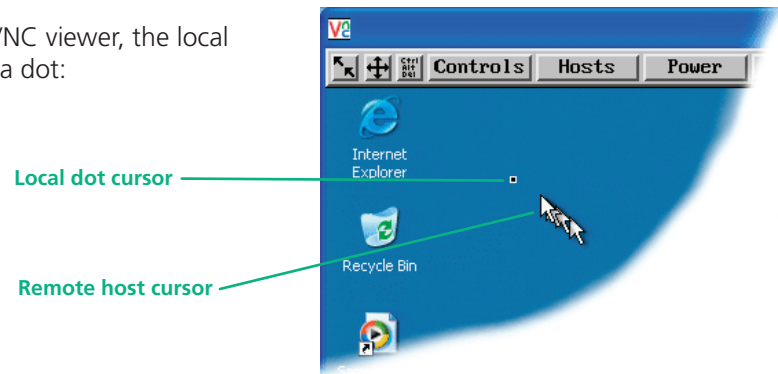

Additionally, for fast network connections, the VNC viewer also provides a single mouse mode. See [Controls - Single Mouse](#) for details.

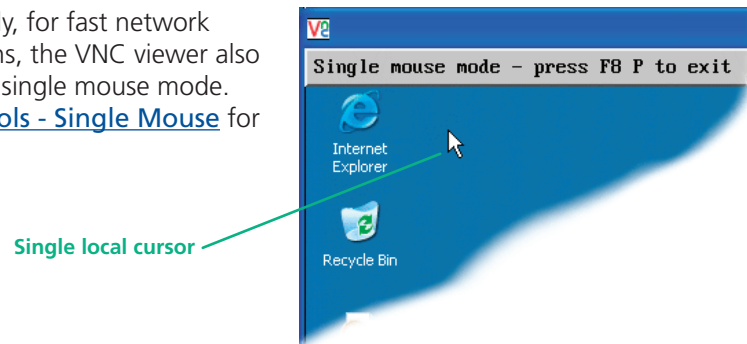

Host selection

The Hosts button on the menu bar provides the quickest and most efficient way to switch between host servers. This is because the button is close at hand, but also because the screen calibration details for each host are reused when this method of switching is used. The alternative is to use [hotkey combinations](#) or the ServSwitch CX with IP [on-screen menu](#).

Note: The Hosts button is displayed only when the switching details for two or more servers have been declared within the configuration section by the admin user.

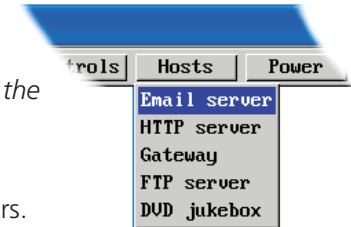

To select a host

- 1 Click the Hosts button to display a list of servers.
- 2 Click the required server name to view and control it.

See [Appendix 2 - Host configuration](#) for details about programming new hosts into the ServSwitch CX with IP ('admin' user status required).

Configure

This option is displayed only when you are logged on as the 'admin' user. When selected it provides access to a wide range of ServSwitch CX with IP settings.

See [Appendix 2 - Configuration pages via viewer](#) for more details.





Auto calibrate

When you visit a host server for the very first time, your viewer needs to determine the optimum video and mouse settings for that particular server. The button will remind you to click it by flashing red when a new server screen is encountered. Performing this step is important because it can help to decrease unnecessary video information being sent across the link, thus improving overall performance.

Once this has been done, providing you use the 'Hosts' button to switch between host servers, the video settings for each machine will be re-used.

Note: When performing an auto calibration, ensure that the screen image is static (no moving images) and also try to remove any on-screen displays generated by KVM switches (such as host names or menus). This is because they can affect the calibration process and result in a lower overall performance level. For mouse calibration, ensure that there are no application windows located around the upper left corner of the screen. This is because as the mouse calibration takes place, the cursor may change (to match the application as it skims across the window) and this may confuse the calculation. Also ensure that the host server does not have the mouse cursor trails option enabled.

To auto calibrate the screen and/or mouse

- 1 Use the Hosts button to select the required server.
- 2 Click the  button to display the Calibrate options dialog:
- 3 Click the required action.

A progress indicator will be displayed while the necessary calculations are made.

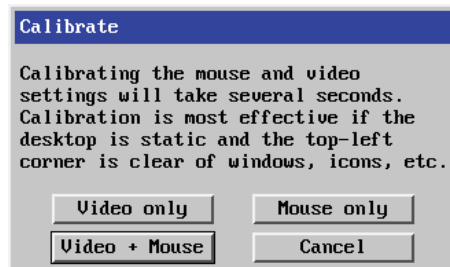

Upon completion an information dialog will explain the results:

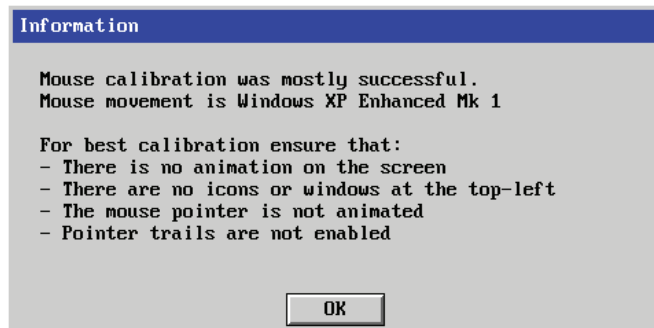

Re-synchronise mouse

If you find that your local mouse pointer and that of the host are not correctly synchronised, use this feature to re-align their movements. This operation is also selectable from the Controls menu.

To re-synchronise the mouse

- 1 Use the Hosts button to select the required server.
- 2 Click the  button and then click OK in the subsequent pop-up message.
Note: If you find that this doesn't work, you may need to perform a mouse calibration again.

Access mode - shared/private

Up to five users can be simultaneously logged-on (four global users plus one local or remote user) and during normal operation, all are able to see the same view of the currently selected host. If you need to perform a sensitive task that should not be viewed by other users, you can change the access mode to Private. This action blanks the viewer window for all other logged on users.

Note: For the courtesy of other users, this mode should be used sparingly. The admin user has the ability to overrule the private setting.

To change the access mode

- 1 Click one of the arrow buttons adjacent to the Shared/Private indicator.



Power switching (via viewer)

When configured (and where you have access rights) this option allows you to control the mains power input to the currently selected host server.

Note: This option is generally used to power cycle remote systems that have failed to respond. Before switching a system off, ensure that all attempts have first been made to power it down through normal means.

To switch a system on or off

- 1 Use the Hosts button to select the required server.
- 2 Click the Power button and then select the Switch on or Switch off option, as appropriate.

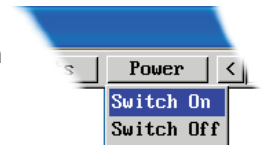

Controls

When clicked, this button reveals a menu of options concerned with keyboard, video and mouse operation.

Single Mouse Mode

This mode is for fast network connections where the cursor response is sufficient to provide instant visual feedback on the remote screen. When enabled, the cursor is 'captured' within the viewer window until you use the 'escape' hot keys.

To quit from single mouse mode, press F8 and then P. Alternatively, enable and use the mouse button escape sequences - see [Advanced unit configuration](#) for details.

The single mouse mode does not require calibration.

Resync Mouse

This option has the same effect as the  button on the menu bar and resynchronises the local and remote mouse pointers.

Refresh Screen

This option refreshes the whole screen image to remove any artifacts from moved screen items. This is useful when using very low refresh rates on slow speed communication links.

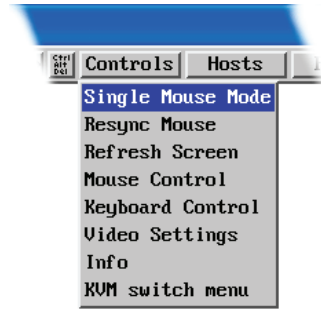

Mouse Control

This option displays a mouse control dialog and is useful when the remote cursor is failing to respond correctly to your mouse movements, even after using the Resync mouse option.

The mouse control dialog allows you to control the remote mouse cursor using a selection of buttons that you click with your local mouse.

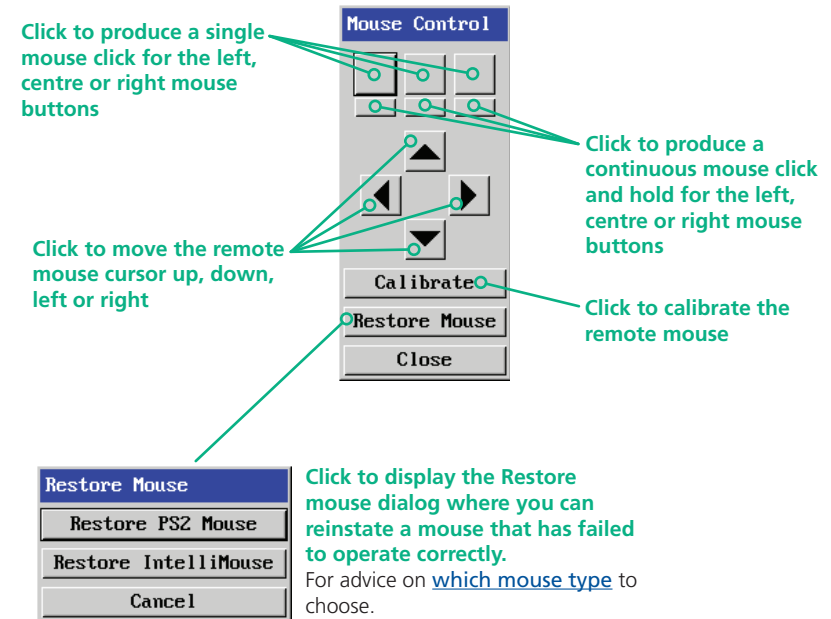

Keyboard Control

This option displays a keyboard control dialog and is useful for sending keyboard combinations (to the host) that are needed regularly or that are trapped by the ServSwitch CX with IP.

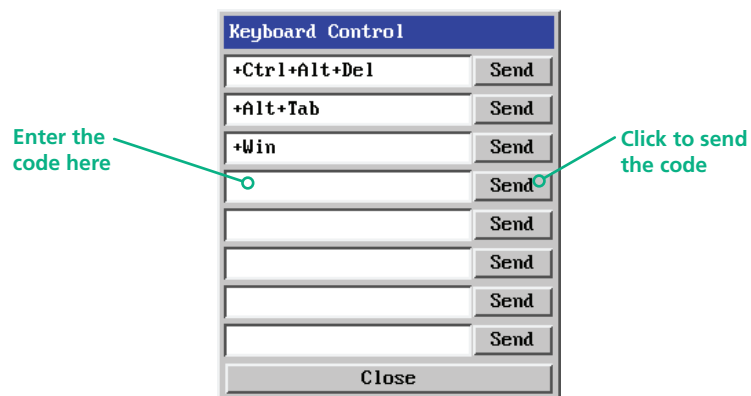

When entering codes:

- + means press down the key that follows
- means release the key that follows
- +– means press down and release the key that follows
- * means wait 250ms (note: if a number immediately follows the asterisk, then the delay will equal the number, in milliseconds)

It is automatically assumed that all keys specified will be released at the end, so there is need to specify -Ctrl or -Alt if these keys are to be released together.

See [Appendix 8](#) for a list of key sequence codes that can be used.

Examples:

'Ctrl + Alt 12' would be expressed as: +Ctrl+ Alt+1–1+2

+N means press the 'N' key

+Scroll means press the Scroll lock key

+Space means press the space key

Video Settings

see [next page](#)

Info

When selected, this option displays an information dialog showing the current logged on users, the current host, its video mode and its mouse motion details.

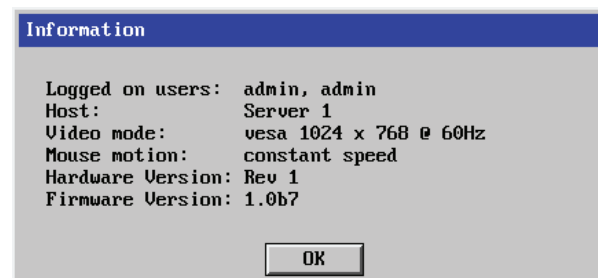

KVM switch menu

This option displays the ServSwitch CX main menu and provides access to the same options presented to local and remote users. The only option that cannot be accessed is *Configure IP port*. For details of the other options available, please refer to [Appendix 1 - Configuration menus](#).

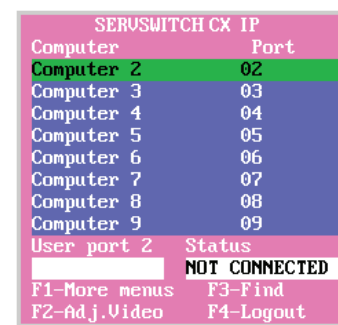

INSTALLATION

CONFIGURATION

OPERATION

FURTHER INFORMATION

INDEX



Video Settings

This dialog provides access to all of the key video settings that determine image quality and link performance.

Threshold

The threshold is effectively a noise filter that differentiates between valid video signals and background noise or interference. This has the effect of reducing unnecessary video signals between the ServSwitch CX and the remote system, thus improving performance.

Phase

The phase setting adjusts the alignment of the host video output and the remote system video display to achieve the sharpest image.

Horizontal Position

Determines the horizontal position of the host screen image within the viewer window.

Vertical Position

Determines the vertical position of the host screen image within the viewer window.

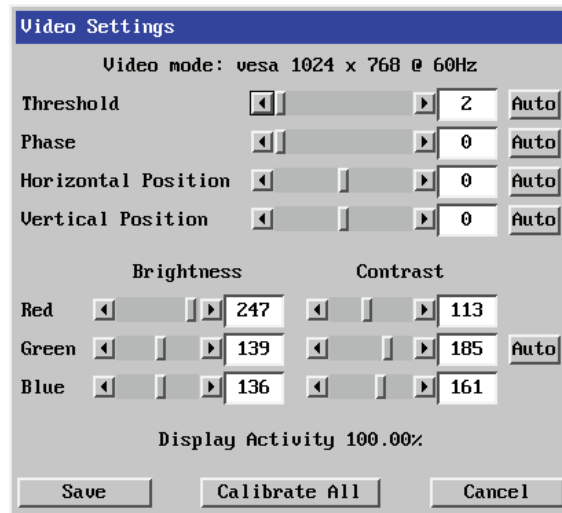

Brightness & Contrast

The red, green and blue constituents of the brightness and contrast can be set individually. Alternatively, use the Auto button on the right side to automatically optimise these for the current host and connection speed.

Calibrate All

Click to determine the optimum settings for all aspects of video the video connection from the host system.

Display activity

Indicates the level of video activity currently in progress.

Using automatic configurations

- Every setting can be individually subjected to an automatic configuration (click the appropriate 'Auto' button) or can also be manually adjusted.
- Use the 'Calibrate All' button to automatically determine the optimum settings for all items.

Note: Before using the 'Calibrate All' option, if possible, remove on-screen display (OSD) elements generated by the ServSwitch CX with IP or any other connected KVM switches (such as a host name label or menu). These OSD elements use different video rates to those of the host system(s) and can affect the setting of the automatic threshold value. ServSwitch CX with IP uses an improved calculation procedure to filter out the effect of these elements. However, best results are obtained when the screen contains only host system information.

Note: To maximise performance, the threshold level is automatically increased by 50% when a slow link is detected.

Note: When the ServSwitch CX with IP is used with one or more other switches, the threshold needs to be higher than 32 due to the significant amounts of 'noise' that these switches introduce. The ServSwitch CX with IP configuration should detect such noise and adjust the threshold accordingly.

Setting the Threshold manually

Occasionally it can be useful to manually adjust the Threshold setting, in order to achieve a setting that best suits your particular requirements.

- 1 Use the 'Calibrate All' function to ensure that all other settings are optimised.
- 2 Click the Threshold left arrow button to decrement the setting by one and observe the 'Display Activity' indicator.
- 3 Repeat step 2 until the Display Activity indicator suddenly rises to a much higher level (i.e. 50%). This will mean that you have reached the noise boundary. At this point, increment the Threshold value by 2 or 3 points to achieve an optimum setting.

Access via dial up (modem or ISDN) link

When you gain access via modem or ISDN link, the ServSwitch CX with IP uses standard network protocols to create a private two-device network. This approach ensures consistency and allows you to use exactly the same VNC viewer or browser to view the host servers. This is achieved using PPP (Point to Point Protocol) and means that you need to use a dial-up networking method to initiate the connection. Such software is standard with operating systems such as Windows, Linux and Mac OS.

To initiate a dial up link

- 1 Using a system that has a modem or ISDN adapter installed, locate the dial-up networking option on your system. Please refer to your system documentation for more information.
- 2 Using the dial-up networking option, enter the telephone/ISDN number where the ServSwitch CX with IP can be contacted.
- 3 Initiate the call and when the link is made, continue with either the standard [VNC viewer](#) or [browser connection](#).

Note: For the viewer network connection address, you must use the IP address that the admin user has set as the Server address (or PPP server IP address) within the Modem configuration screen.

If you need to enter a port number

Usually, when you make a network connection to the ServSwitch CX with IP (either using the VNC viewer or a Web browser) you simply enter the IP address, i.e. 192.168.0.3. However, if a special configuration is necessary, then you may be asked to specify a port number as well as the IP address.

[What is a port?](#)

To enter a port number in a Web browser

- 1 Enter the required IP address in the usual Address box, i.e. http://192.168.0.3
- 2 At the end of the IP address, add a single colon (:) and then enter the port number (in this example, the required port number is 8000), i.e. http://192.168.0.3:8000
- 3 Continue with the standard [Web browser instructions](#).

To enter a port number in VNC viewer

- 1 Enter the required IP address in the usual 'Server' box, i.e. http://192.168.0.3
- 2 At the end of the IP address, add two colons (::) and then enter the port number (in this example, the required port number is 8000), i.e. http://192.168.0.3::8000
- 3 Continue with the standard [VNC viewer instructions](#).



Viewer encryption settings

The web browser viewers and VNC viewers (of level 4.0b55 or higher) offer four encryption options. The resulting actions of certain options depend upon how the ServSwitch CX with IP to which you are connecting is configured:

- **Always on** - This setting will ensure that the link is encrypted, regardless of the ServSwitch CX with IP encryption setting.
- **Let server choose** - This setting will follow the configuration of the ServSwitch CX with IP. If the ServSwitch CX with IP has a preference to encrypt the link, then it will be so, otherwise the link will not be encrypted.
- **Prefer off** - This setting will configure an un-encrypted link if the ServSwitch CX with IP will allow it, otherwise it will be encrypted.
- **Prefer on** - If the ServSwitch CX with IP allows it, this setting will configure an encrypted link, otherwise it will be un-encrypted.

Whenever encryption does take place, the viewer will first need to create the necessary secure key before the connection process can continue.

Supported web browsers

The following web browsers have been tested and found to work correctly with ServSwitch CX.

Windows

- Internet Explorer 5.50 and above,
with Microsoft [Java] Virtual Machine (release 5.50).
with Java Runtime Environment 1.3 or above.

Linux

- Netscape 4.61 and above,
with Java Runtime Environment 1.1 or above.
- Opera,
with Java Runtime Environment 1.1 or above.



INSTALLATION

CONFIGURATION

OPERATION

FURTHER
INFORMATION

INDEX

Further information



This chapter contains a variety of information, including the following:

- Getting assistance - see below
- Troubleshooting - see right
- Appendices
 - Appendix 1 - [Configuration menus](#)
 - Appendix 2 - [Configuration pages via viewer](#)
 - Appendix 3 - [VNC viewer connection options](#)
 - Appendix 4 - [VNC viewer window options](#)
 - Appendix 5 - [Browser viewer options](#)
 - Appendix 6 - [Addresses, masks and ports](#)
 - Appendix 7 - [Cable specifications](#)
 - Appendix 8 - [Hotkey sequence codes](#)
 - Appendix 9 - [Supported video modes](#)
- [Safety information](#)
- [Warranty](#)
- [End user licence agreement](#)
- [Radio frequency energy statements](#)

Getting assistance

If you are still experiencing problems after checking the list of solutions in the Troubleshooting section then we provide a number of other solutions:

- Email in the US: techsupport@blackbox.com
in the UK: techhelp@blackbox.co.uk
- Phone in the US: **724-746-5500**
in the UK: **+44 (0)118 965 6000**

Troubleshooting

Global network users are unable to contact the ServSwitch CX with IP

- Check that the correct address is being used by the remote users.
- Check the [network settings](#). Check that the users network address has not been excluded in the [IP access control section](#).
- If the ServSwitch CX with IP is situated behind a firewall, check that the relevant ports are being allowed [through the firewall](#) and are being correctly routed.
- Check the [front panel indicators](#), the LNK indicator should be on. If the network link is a 100Mbps connection, the 100 indicator should also be on.

The remote cursor is not correctly responding to my mouse movements

- [Recalibrate the mouse](#). When doing so, ensure that the host system does not have mouse cursor trails enabled and that the top left corner of the screen is clear of application windows.

When logging on using VNC viewer, I cannot enter a username

- Either, the VNC viewer is an old version ([download a new one](#)) or only the admin user has been configured on the ServSwitch CX with IP.

INSTALLATION

CONFIGURATION

OPERATION

FURTHER INFORMATION





INDEX

Appendix 1 – Configuration menus

The ServSwitch CX configuration menus allow a range of settings to be made both to the installation as a whole and to parts of the system accessed by each user.

To access the configuration menus





1 Select the on-screen main menu in one of three ways:

- By simultaneously pressing and then releasing   .
- By pressing the middle and right buttons of a three button mouse, or
- By selecting **Server**  using the front panel buttons.

If you are not already logged in, do so now. [What to do if the ADMIN password has been forgotten.](#)

2 Press  to select 'More menu'.

3 Use the following keys:

-  and  to highlight required options.
-  to change option values.
-  to quit and save the changes.

The full set of options are only available to the Admin user. All other users will see a subset of these.

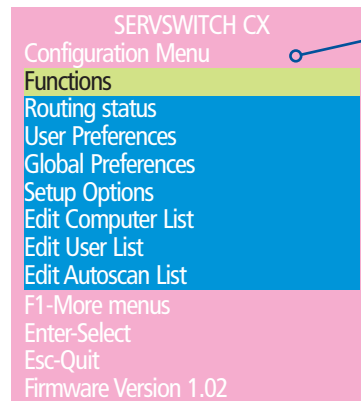

The following items and menus are available in the Configuration menu:

- [Functions](#)
- [Routing status](#)
- [User Preferences](#)
- [Global Preferences](#)
- [Setup Options](#)
- [Edit Server List](#)
- [Edit User List](#)
- [Edit Autoscan List](#)
- [Advanced Options](#) (F1-More menus)

Additionally, a further important menu is located as an option within the *Functions* menu of ServSwitch CX with IP models:

- [Configure IP port](#)



Functions

The Functions menu contains a collection of procedures that affect various aspects of ServSwitch CX operation. Only the Admin user is granted access to all functions, other users are offered only the following options:

- *Restore Standard Mouse*,
- *Restore Intellimouse*,
- *Power control* - only servers to which a user has access rights can be switched.

To get here

- 1 From a local, remote or global keyboard, log on as a standard (limited options) or 'admin' user.
- 2 Press **Ctrl** **Alt** **M** (hotkeys can change).
- 3 Press **F1** to select 'More menus'.
- 4 Select 'Functions'.

Restore Standard Mouse

This option is used to resume standard mouse operation if it has ceased to operate, for instance, if it has been connected without rebooting the ServSwitch CX. See [Hot plugging and mouse restoration](#) for more details.

Restore Intellimouse

This option is used to resume Microsoft Intellimouse operation if it has ceased to operate, for instance, if it has been connected without rebooting the ServSwitch CX. See [Hot plugging and mouse restoration](#) for more details.

Configure IP port

ServSwitch CX with IP models only. Displays a sub menu containing options related specifically to IP network and modem/ISDN port features. See [Configure IP port](#) for details.

Reset to Factory Defaults

Returns all key settings within the ServSwitch CX to their original states.

WARNING: This function will clear all server and user lists that are stored within the ServSwitch CX.

When this option is selected, you must press **F8** to confirm the action. The internal data will be rewritten and a completion message displayed after a short period.

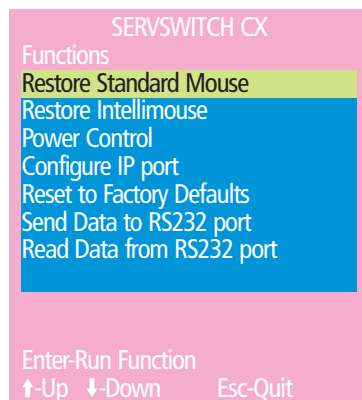

Power Control

The options within this section are usable only when the ServSwitch CX is used in conjunction with one or more external power switch units. For more details see: power switching [connections](#), [configuration](#), [operation \(via menu\)](#) or [operation \(via viewer\)](#)

Switch Server ON

Select this option to power on one or more servers.

Switch Server OFF

Select this option to power off one or more servers.

Edit Power ON String

Select this option to alter the special codes that are sent from the ServSwitch CX to the connected power switch(es) in order to switch servers on.

Edit Power OFF String

Select this option to alter the special codes that are sent from the ServSwitch CX to the connected power switch(es) in order to switch servers off.

Send Data to RS232 port

This option is used to save ServSwitch CX configuration information to a specially connected server. A temporary link must be made using the COM1/ UPGRADE port at the rear of the ServSwitch CX and the server must run a custom routine available from Black Box. The resulting download file can be optionally edited (using Microsoft Excel) and/or reloaded into the ServSwitch CX. This option is especially useful in complex cascade arrangements where many servers are attached. See [Saving and restoring configuration settings](#) for more details.

Read Data from RS232 port

This option is used to reload configuration information into the ServSwitch CX from a specially connected server. See above for more details.



INSTALLATION

CONFIGURATION

OPERATION

FURTHER INFORMATION

INDEX

User Preferences

The User Preferences are system operating parameters that are independently selectable for each user and affect only their screen.

To get here

- 1 From a local, remote or global keyboard, log on as a standard or 'admin' user.
- 2 Press **Ctrl** **Alt** **M** (hotkeys can change).
- 3 Press **F1** to select 'More menus'.
- 4 Select 'User Preferences'.

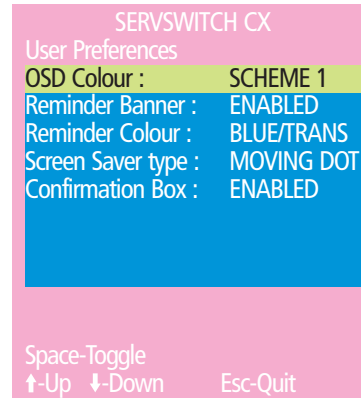

OSD Colour

Settings: SCHEME 1, SCHEME 2, SCHEME 3

As you toggle between these options you will see the colour of the menu change to show the selected scheme. The menu schemes have been specially chosen to provide a high contrast with the colours that you would normally see on a server screen.

Reminder Banner

Settings: ENABLED, DISABLED

When the reminder banner is enabled, the name of the currently selected server will appear in a small reminder banner. This is normally located at the top of the screen in a central position but may be moved as required (see [To move the reminder banner](#)).

Reminder Colour

Settings: BLUE/TRANS, PINK/TRANS, BLUE/WHITE, WHITE/RED

You may select the colour of the reminder banner. The BLUE/TRANS and PINK/TRANS select blue or pink text with a transparent background. The BLUE/WHITE and WHITE/RED settings select blue and white text on solid white and red backgrounds.

Screen Saver Type

Settings: BLANK, MOVING DOT

You may select the type of screen saver. If you select BLANK then the screen will blank completely. If you select MOVING DOT then a moving dot will be displayed on a blank background. The dot regularly changes colour and bounces off the sides of the screen in a zigzag pattern.

Confirmation Box

Settings: DISABLED, ENABLED

When enabled, a confirmation box is displayed on screen for three seconds after a server is selected. The confirmation box indicates the current user port and user name, the selected server and the connection status.



INSTALLATION

CONFIGURATION

OPERATION

FURTHER
INFORMATION

INDEX

Global Preferences

Global preferences are available only to the Admin user and allow settings to be made that affect all users attached to the ServSwitch CX.

To get here

- 1 From a local, remote or global keyboard, log on as 'admin' user.
- 2 Press **Ctrl** **Alt** **M** (hotkeys can change).
- 3 Press **F1** to select 'More menus'.
- 4 Select 'Global Preferences'.

Mouse Switching

Settings: *ENABLED, DISABLED*

The server channel can be switched using a three button mouse or IntelliMouse. Pressing the central button or wheel button together with the left hand mouse button will cause the ServSwitch CX to switch to the next available server. When mouse switching is enabled the central mouse button or wheel mouse button is allocated to control the ServSwitch CX and is not therefore available for use by server applications. If you want to use the central mouse button within your applications you will need to disable mouse switching. The rotation action of an IntelliMouse wheel is not affected and is always available to the server application.

Screen Saver

Settings: *DISABLED; 2, 5, 7, 10,15, 20 & 30 MINUTES*

To avoid burning out the phosphor on CRT monitor screens, the ServSwitch CX can be set to blank the screen after no keyboard or mouse activity has been detected for a selected timeout period. If preferred, the user can blank the screen manually by selecting channel '0' using the keyboard hotkeys or by pressing ESC from the login screen.

SERVSWITCH CX	
Global Preferences	
Mouse Switching :	ENABLED
Screen Saver :	DISABLED
Autoscan Mode :	SCAN LIST
Autoscan Period :	5 SECONDS
OSD Dwell Time :	2 SECONDS
User Timeout :	2 SECONDS
RS232 Mouse Type :	INTELLIMSE
Mouse Type :	LOGITECH
Space-Toggle	
↑-Up ↓-Down	Esc-Quit

Autoscan Mode

Settings: *SCAN LIST, ACTIVE PCs, ALL PCs*

The ServSwitch CX supports an autoscan mode that automatically scans between the connected servers in sequence. There are three autoscan modes. In the first mode the ServSwitch CX will scan all the named servers that are defined in the autoscan list (SCAN LIST). The servers defined in the scan list may be connected to cascaded ServSwitch CX units. If you wish to scan the ports on the current ServSwitch CX then you may select ALL the available servers or just the available servers that are currently powered on (the ACTIVE servers). Scanning just the active servers avoids blank screens from being displayed and stops the monitor from going into a power down state on every scan cycle.

WARNING - Many modern monitors are fitted with automatic power save relays and will switch off after a few seconds if connected to an inactive PC. If you are using such a monitor you must not set the ServSwitch CX to scan ALL ports. Constant switching on and off of your monitor's relay will eventually damage your monitor. If you are using the SCAN LIST option then you should ensure that all the servers are active if you are using one of these monitors.

If you choose to use the SCAN LIST option then you may define the servers to be scanned in the following manner.

To define the autoscan list

Note: *Ensure that you are [logged in](#) as the ADMIN user.*

- 1 From the main on-screen menu press F1 for MORE MENUS.
- 2 Select EDIT AUTOSCAN LIST from the menu. A list of defined servers will appear. Servers affixed with a '+' will be autoscanned during the autoscan cycle. To add/remove a server to/from the autoscan list, move the selection bar over the server name and press SPACE BAR. To add all named servers press F1. To remove all named servers press F2.
- 3 When all the servers that you wish to scan are affixed with a '+', press RETURN or ENTER to save the selections. The selected servers will be autoscanned in alphabetical order when you activate autoscan mode (when the SCAN LIST option is selected).

Autoscan Period

Settings: *DISABLED; 2, 5, 7, 15, 30 SECONDS, 1, 5 MINUTES*

The autoscan time defines the length of time that the ServSwitch CX will display video (and play audio) from an autoscanned server before changing to the next server. If the DISABLED setting is chosen then no autoscan functions will be available.



Global Preferences (continued)

OSD Dwell Time

Settings: 1, 2, 3, 5, 10 SECONDS

After a successful server channel change the ServSwitch CX will display a confirmation message for a few seconds. The length of time that this confirmation message dwells on the screen may be changed.

User Timeout

Settings: 1, 2, 5, 10, 30 SECONDS, 1, 5, 10 MINUTES

When two users are connected to the same server only one can have access at any one time. When no keyboard or mouse data has been received from the active user port for the user timeout period, the ServSwitch CX will allow other users to access the server. The new port then becomes the active port until it too times out. To avoid confusion between users it is desirable to set the timeout period to be sufficiently long so that user's work is not needlessly interrupted by other users and sufficiently short to ensure good overall system efficiency. The user timeout value also controls the timeout between the local port and remote (extended) user port 1.

RS232 Mouse Type

Settings: INTELLIMOUSE, 2 BUTTON, 3 BUTTON

This setting controls the type of RS232 mouse that the ServSwitch CX reports to servers. All the necessary conversions are dealt with automatically by the ServSwitch CX. The IntelliMouse setting sends four byte mouse reports to the servers and is therefore very slightly more sluggish than the others that send three byte mouse reports. RS232 mice are almost always more sluggish than PS/2 types because the data rate is much slower.

Mouse Type

Settings: LOGITECH, MICROSOFT

This setting determines how the mouse type is reported to each connected PC. Some Logitech mouse drivers are unable to handle the more advanced features of Microsoft Intellimouse Explorer type mice, so the LOGITECH setting here reports a more basic mouse type.



INSTALLATION

CONFIGURATION

OPERATION

FURTHER
INFORMATION

INDEX

Setup Options

Setup options are available only to the Admin user and consist of key settings that are normally made only during the initial installation stage.

To get here

- 1 From a local, remote or global keyboard, log on as 'admin' user.
- 2 Press **Ctrl** **Alt** **M** (hotkeys can change).
- 3 Press **F1** to select 'More menus'.
- 4 Select 'Global Preferences'.

SERVSWITCH CX	
Setup Options	
Security :	ENABLED
Language :	ENGLISH
Hotkeys :	CTRL+ALT
Keypads Controls :	ENABLED
Exclusive Use :	ALLOWED
Automatic Logout :	DISABLED

Space-Toggle
↑-Up ↓-Down Esc-Quit

Security

Settings: *DISABLED, ENABLED*

With security disabled there is no requirement for users to log-in to the system. All users have full access to all the connected servers and full administration rights. With security enabled, users are required to log-in to the ServSwitch CX. Each user is allocated access rights to servers by the system administrator and they are only able to see the servers that they have access to on their on-screen menu.

Language

Settings: *ENGLISH, FRENCH, GERMAN, SWEDISH*

This option specifies the language that is used for the on-screen menu and the keyboard layout that is assumed for the keyboard. When the French option is selected the keyboard is assumed to have an AZERTY format. When the English, German and Swedish options are selected the keyboard is assumed to have a QWERTY format. The new language settings are enabled when you quit from the SETUP OPTIONS menu. The language option only affects the way that the ServSwitch CX interprets the keyboard keys, it does not affect the way that the servers interpret the keyboard. It is advisable to avoid setting a language that you do not understand as all the menus will change to use the new language and you may have difficulty reselecting your original language.

Hotkeys

Settings: *CRTL+ALT, CTRL+SHIFT, ALT+SHIFT, ALT GR, L+R ALT, L CTRL+ALT, R CTRL+ALT, DISABLED*

The keyboard hotkeys are special combinations of keys that, when used together with certain keyboard "command keys", perform special ServSwitch CX functions. For example, pressing the hotkeys together with the "M" key will cause the on-screen menu to be displayed on your monitor. Other hotkey combinations allow you to query which server you are connected to and to move the on-screen menu around the screen. You can also use the hotkeys together with the port number to select a particular connected server.

Keypads Controls

Settings: *ENABLED, DISABLED*

The key controls on the front of the ServSwitch CX may be disabled so that it is only possible to select the special channels "o" (on-screen menu) and "0" (no server channels selected).

Exclusive Use

Settings: *ALLOWED, DISABLED*

In normal operation, the ServSwitch CX will allow two or more users to share access to a server. In this mode, the server's video picture will be displayed on all the users' monitors but only one user may have active control of the server's keyboard and mouse at any one time. The ServSwitch CX detects an active user by checking for keyboard and mouse data.

A user becomes inactive if no keyboard or mouse data has been received by the ServSwitch CX for a specified timeout period. Whilst one user is active all the other users that are connected to the same server will see a "video only" message displayed on their screen. There may be situations where particular users wish to control and view a server in private with exclusive use. The ServSwitch CX has the facility to allow users to select exclusive use of servers, however, this facility should be used with care.

Users that have selected exclusive access are never timed out by the ServSwitch CX and so all other users are effectively "locked out" until the exclusive user switches to another server or logs out. This could potentially be very irritating if a user has selected exclusive use and has then left their desk without logging out. This would prevent other users from working on the server until they SAME back. Consequently the system administrator can disable all exclusive use so that all connections are shared.



Setup Options (continued)

Automatic Logout

Settings: *DISABLED, ENABLED*

The ServSwitch CX enables you to restrict access to your servers on a login basis. If a user forgets to logout when they have finished accessing the ServSwitch CX then the user console may unintentionally be left with full access to all the servers. The ServSwitch CX can be set to automatically logout unattended user consoles when the screen saver kicks in. This reduces the risk of security problems by preventing user consoles remaining in a permanent “logged-in” state when there is no keyboard or mouse activity. The automatic logout feature is only enabled when the screen saver feature is active (i.e. not disabled).



INSTALLATION

CONFIGURATION

OPERATION

FURTHER
INFORMATION

INDEX

Advanced Options

Advanced options are available only to the Admin user and consist of settings that are related to specialist areas such as power control and DDC.

To get here

- 1 From a local, remote or global keyboard, log on as 'admin' user.
- 2 Press **Ctrl** **Alt** **M** (hotkeys can change).
- 3 Press **F1** to select 'More menus'.
- 4 Select 'Global Preferences'.

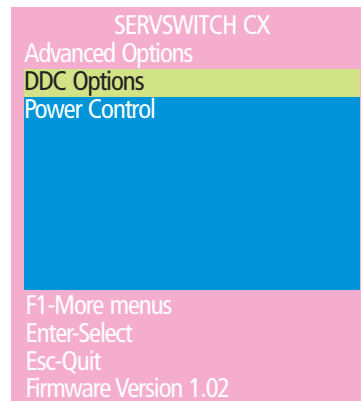

DDC Options

The options within this section are related to the Display Data Channel features supported by the ServSwitch CX. DDC is an industry standard format that allows server systems to be informed of the capabilities of the video monitor connected to them.

DDC Source

Settings: *AUTO, LOCAL, DEFAULT*

Determines which user port monitor should be interrogated to discover its capabilities. *AUTO* begins with the local user port and if it fails, it uses a set of default values. The *LOCAL* setting forces the unit to interrogate only the local monitor and *DEFAULT* uses only the pre-programmed settings.

DDC Refresh

Settings: *AT START, DISABLED*

AT START sets the ServSwitch CX to read DDC information from the selected source at power up. When *DISABLED*, no new DDC data is sought and existing information is used. When viewing this menu, press F8 to discover DDC information from the chosen source immediately.

Power Control

The options within this section are concerned with the operation of the **POWER CONTROL** port when used to command optional system power control units.

Baud Rate

Settings: *1200, 2400, 4800, 9600, 19200, 38400, 57600, 115200*

Configures the communication speed of the **POWER CONTROL** port and must match the speed used by the connected power switch(es). *Note: The PSE508SA and PSE508MA (not available in North America) power switches supplied by Black Box require a setting of 9600.*

Format

Settings: *NONE.8.1, ODD.8.1, EVEN.8.1, NONE.8.2, NONE.7.2, ODD.7.2, EVEN.7.2*

Configures the data format used by the serial port and must match the format used by the connected power switch(es). The *NONE/ODD/EVEN* portion relates to the parity checking; the *7/8* value is the size of the data byte and the *1/2* value determines the stop bit(s) used after each data byte.



INSTALLATION

CONFIGURATION

OPERATION

FURTHER INFORMATION

INDEX

Configure IP port

Available only on ServSwitch CX with IP models, the IP port configuration menu allows you to determine settings that relate directly to the global (IP) user aspects of the unit:

- **Unit Configuration**
IP admin password, encryption settings, etc.
- **Network Configuration**
IP address, net mask, VNC port, etc.
- **Modem Configuration**
Baud rate, initialisation string, etc.
- **Reset Configuration**
Completely resets the IP portion of the ServSwitch CX with IP unit.

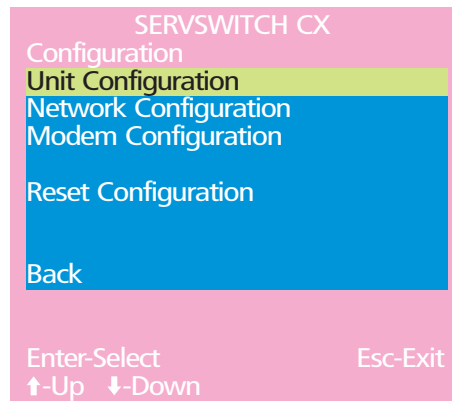

To get here

- 1 From a local or remote (not accessible from a global keyboard), log on as the 'admin' user.
- 2 Press **Ctrl** **Alt** **M** (hotkeys can change).
- 3 Press **F1** to select 'More menus'.
- 4 Select 'Functions'.
- 5 Select 'Configure IP port'.

Unit Configuration

This page provides access to a selection of both basic and fundamental settings for the ServSwitch CX with IP.

Keyboard

Use the arrow buttons to match the keyboard layout expected by the host system.

Admin Pwd

Enter the password that will be used to gain administrator access to the ServSwitch CX with IP. There can only be one admin user and only that user is given access to the configuration menus. The admin password background will be red until a reasonably secure password has been entered, although this is only advisory as any password or no password may be entered.

Unit Name

The name entered here will be displayed on the local menus and the remote VNC/browser windows.

Time and Date

Use the left and right arrow keys to select the correct time and date. The time entry uses the 24 hour clock notation. The internal real time clock will continue to run for roughly one week without power to the unit, after that it will be lost and require resetting. Use the up and down arrow keys to move between each of the sections within the time and date entries.

Encryption

Three options are available: Always on, prefer off, prefer on. The one to choose depends on the specific details of your installation - see [Encryption settings](#) for details. The use of encryption imposes a slight performance overhead of roughly 10% but is highly secure against third party intrusion.

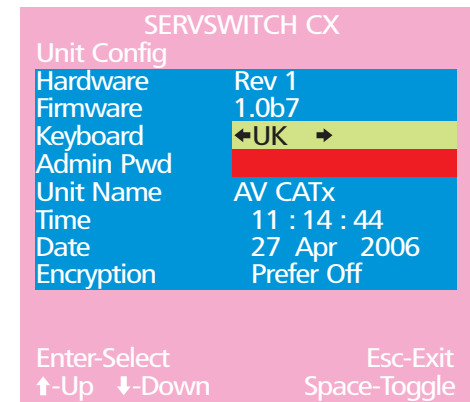

INSTALLATION

CONFIGURATION

OPERATION

FURTHER INFORMATION

INDEX

Network Configuration

This page allows you to configure the various aspects of the IP port and its relationship with the local network.

Mac Addr

Media Access Control address – this is the unique and unchangeable code that was hard coded within your ServSwitch CX with IP unit when it was built. It consists of six 2-digit hexadecimal (base 16) numbers separated by colons. A section of the MAC address identifies the manufacturer, while the remainder is effectively the unique electronic serial number of your particular unit.

Use DHCP

DHCP is an acronym for 'Dynamic Host Configuration Protocol'. Its function is particularly useful when connecting to medium size or larger networks, such as the Internet. When this option is selected, your ServSwitch CX with IP will attempt to locate a DHCP server on the network. If such a server is located, it will supply three things to the ServSwitch CX with IP: an IP address, an IP network mask (also known as a Subnet mask) and a Gateway address. These are not usually granted permanently, but on a 'lease' basis for a fixed amount of time or for as long as the ServSwitch CX with IP remains connected and switched on. [Discover allocations](#).

IP Address

This is the identity of the ServSwitch CX with IP within a network. The IP address can be thought of as the telephone number of the ServSwitch CX with IP. Unlike the MAC address, the IP address can be altered to suit the network to which it is connected. It can either be entered manually or configured automatically using the DHCP option. When the DHCP option is enabled, this entry is unavailable.

SERVSWITCH CX	
Network Config	
Mac Addr	00:0F:58:40:07:FE
Use DHCP	No
IP Address	192.168.42.25
Net Mask	255.255.255.0
Gateway	192.168.0.1
VNC Port	5900
HTTP Port	80
Clear IP Access Control	

Enter-Select Esc-Exit
↑-Up ↓-Down Space-Toggle

Net Mask

Also often called the 'subnet-mask', this value is used alongside the IP address to help define a smaller collection (or subnet) of devices on a network. In this way a distinction is made between locally connected devices and ones that are reachable elsewhere, such as on the wider Internet. This process helps to reduce overall traffic on the network and hence speed up connections in general.

Gateway

This is the address of the device that links the local network (to which the ServSwitch CX with IP is connected) to another network such as the Internet. Usually this is a network switch or router and it will be used whenever a device to be contacted lies outside the local network.

VNC Port

This is the logical link through which communications with a remote VNC viewer will be channelled (see [What is a port?](#)). The default setting is 5900 which is a widely recognised port number for use by VNC software. However, in certain circumstances it may be advantageous to alter this number - see [Security issues with ports](#) for more details.

Note: The VNC port and HTTP port can be set to the same port number in order to simplify router and firewall configuration. If this is done then the ServSwitch CX with IP will "listen" for both types of traffic on the single port.

HTTP Port

This is the logical link through which communications with a remote web browser will be channelled. The default setting of 80 is an established standard for web (HTTP – HyperText Transfer Protocol) traffic though this can be changed to suit your local network requirements.

Clear IP Access Control

This option removes all entries from the IP access control feature within the ServSwitch CX with IP. The IP access control feature (configurable by a global admin user) allows certain network address ranges to be denied access to the ServSwitch CX with IP. If set incorrectly, it is possible to exclude all network users and so this option provides an emergency recovery point.



Modem Configuration

This page allows you to configure the COM1 serial port located at the rear of the ServSwitch CX with IP.

Server IP / Client IP

When a user dials into the ServSwitch CX with IP via a modem or ISDN adapter, the ServSwitch CX with IP sets up a temporary two-device network using PPP (Point to Point Protocol). For this purpose, both devices must have 'dummy' IP addresses so that they can communicate correctly. These two addresses can be almost anything expressed in the quad octet format (i.e. 192.168.3.1.). However, it is advisable not to make them the same as the real IP addresses used by either the remote system or the ServSwitch CX.

Baud Rate

This option configures the speed of the serial connection between the ServSwitch CX with IP and a connected modem or ISDN terminal adapter. The default setting is 115200. The other communication settings are fixed as: No parity, 8 bit word, 1 stop bit.

Init String

The codes entered here are used to prepare the connected modem or ISDN terminal adapter for use with the ServSwitch CX with IP. The default code is a Hayes-compatible string to configure auto answer mode and would be understood by the vast majority of modem/ISDN devices. The code is sent when the ServSwitch CX with IP is first switched on or whenever the Initialize button is clicked.

Initialize Port

When selected, this option sends the characters entered in the 'Init string' field to the connected modem or ISDN terminal adapter.

Restore Defaults

When selected, this option resets the 'Baud rate' and 'Init string' values to their original default settings.

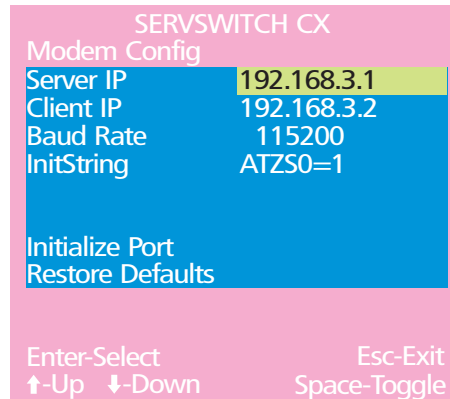

Reset Configuration

This option allows you to completely reset the IP portion of the ServSwitch CX with IP unit.

WARNING: This process will remove all network and modem/ISDN settings and return the unit to use its original state. A complete reconfiguration will be required before the IP features of the unit can be used.

To reset the ServSwitch CX with IP configuration

- 1 With the *Reset Configuration* option highlighted, press .
- 2 Access the Configure IP port option to view the initial IP configuration screens. See [Initial IP configuration](#) for details.



Clearing IP access control

This option removes all entries from the IP access control feature within the ServSwitch CX with IP.

What is IP access control?

The IP access control feature (configurable by a remote admin user) allows certain network address ranges to be denied access to the ServSwitch CX with IP. If set incorrectly, it is possible to exclude all network users and so this option provides an emergency recovery point.

To clear IP access control

- 1 From a local or remote (not accessible from a global keyboard), log on as the 'admin' user.
- 2 Press **Ctrl** **Alt** **M** (hotkeys can change).
- 3 Press **F1** to select 'More menus'.
- 4 Select 'Functions'.
- 5 Select 'Configure IP port'.
- 6 Highlight the 'Clear IP access control' option and press **Enter**.

```
SERVSWITCH CX
Network Config
Mac Addr      00:0F:58:40:07:FE
Use DHCP      No
IP Address    192.168.42.25
Net Mask      255.255.255.0
Gateway       192.168.0.1
VNC Port      5900
HTTP Port     80
Clear IP Access Control

Enter-Select      Esc-Exit
↑-Up ↓-Down      Space-Toggle
```



INSTALLATION

CONFIGURATION

OPERATION

FURTHER INFORMATION

INDEX

Appendix 2 - Configuration pages via viewer

This section covers the configuration pages that are available to global admin users, using either the VNC viewer or the browser methods of access.

To access the remote configuration pages

- 1 Make a [global connection](#) to the ServSwitch CX with IP unit and login as the admin user.
- 2 Once logged in, click the Configure button in the top right corner of the window.

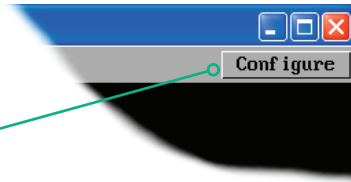

Main configuration page

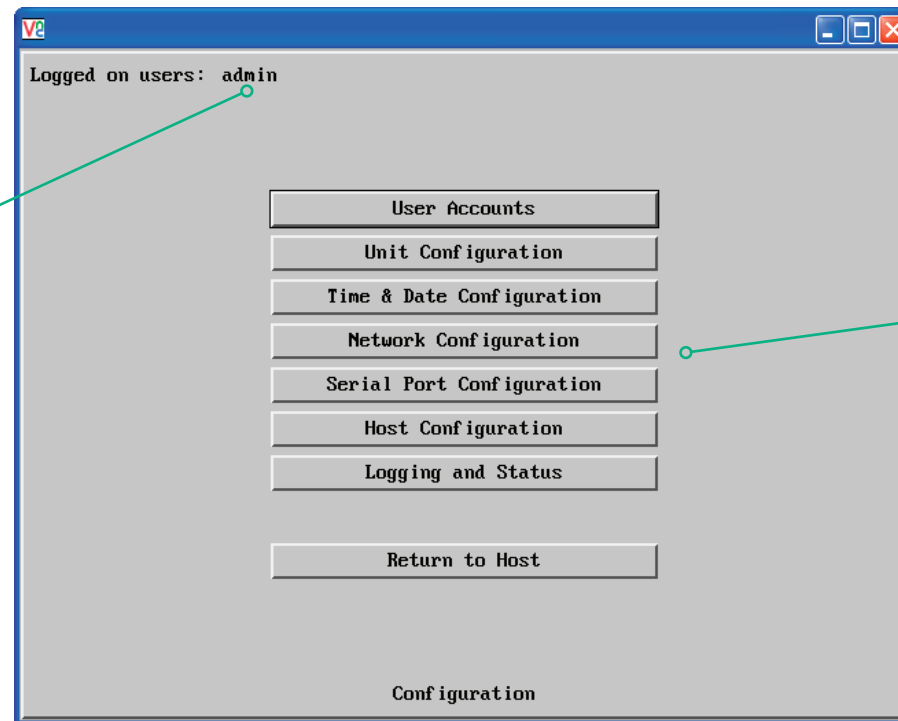

Logged on users

Indicates the current users irrespective of whether they are connected locally, remotely, by modem/ISDN or via a network.

Click the required option

- [User Accounts](#)
- [Unit Configuration](#)
- [Time & Date Configuration](#)
- [Network Configuration](#)
- [Serial Port Configuration](#)
- [Host Configuration](#)
- [Logging and Status](#)



INSTALLATION

CONFIGURATION

OPERATION

FURTHER INFORMATION

INDEX

User accounts

This page allows you to manage up to sixteen separate accounts.

The first of the sixteen accounts is the admin account and is the only account with access rights to the configuration menus. The user name and access rights are fixed for the admin account, the only change possible for this account is the password.

There are fifteen user account positions.

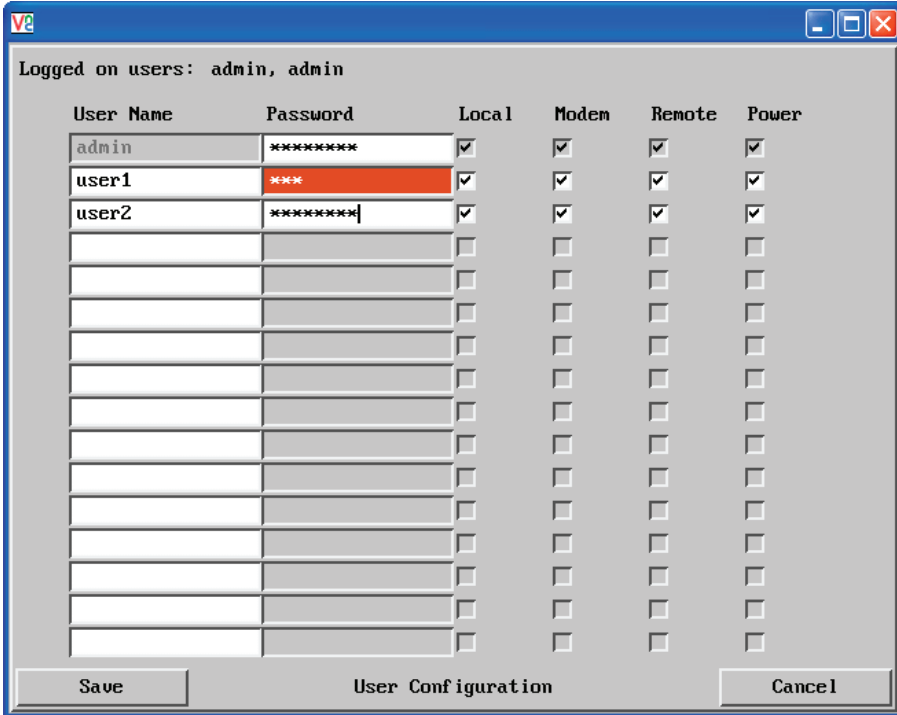

The screenshot shows a 'User Configuration' dialog box with a table of user accounts. The table has columns for User Name, Password, Local, Modem, Remote, and Power. The 'admin' user is highlighted in red. The 'user1' and 'user2' users have their passwords masked with asterisks. The 'Local', 'Modem', 'Remote', and 'Power' columns have checkboxes for each user.

User Name	Password	Local	Modem	Remote	Power
admin	*****	<input checked="" type="checkbox"/>	<input checked="" type="checkbox"/>	<input checked="" type="checkbox"/>	<input checked="" type="checkbox"/>
user1	***	<input checked="" type="checkbox"/>	<input checked="" type="checkbox"/>	<input checked="" type="checkbox"/>	<input checked="" type="checkbox"/>
user2	*****	<input checked="" type="checkbox"/>	<input checked="" type="checkbox"/>	<input checked="" type="checkbox"/>	<input checked="" type="checkbox"/>
		<input type="checkbox"/>	<input type="checkbox"/>	<input type="checkbox"/>	<input type="checkbox"/>
		<input type="checkbox"/>	<input type="checkbox"/>	<input type="checkbox"/>	<input type="checkbox"/>
		<input type="checkbox"/>	<input type="checkbox"/>	<input type="checkbox"/>	<input type="checkbox"/>
		<input type="checkbox"/>	<input type="checkbox"/>	<input type="checkbox"/>	<input type="checkbox"/>
		<input type="checkbox"/>	<input type="checkbox"/>	<input type="checkbox"/>	<input type="checkbox"/>
		<input type="checkbox"/>	<input type="checkbox"/>	<input type="checkbox"/>	<input type="checkbox"/>
		<input type="checkbox"/>	<input type="checkbox"/>	<input type="checkbox"/>	<input type="checkbox"/>
		<input type="checkbox"/>	<input type="checkbox"/>	<input type="checkbox"/>	<input type="checkbox"/>
		<input type="checkbox"/>	<input type="checkbox"/>	<input type="checkbox"/>	<input type="checkbox"/>
		<input type="checkbox"/>	<input type="checkbox"/>	<input type="checkbox"/>	<input type="checkbox"/>
		<input type="checkbox"/>	<input type="checkbox"/>	<input type="checkbox"/>	<input type="checkbox"/>
		<input type="checkbox"/>	<input type="checkbox"/>	<input type="checkbox"/>	<input type="checkbox"/>

To create a new account

- 1 Enter the required User Name to activate that position (the Password and access tick box positions will become editable).
- 2 Optionally enter a password for the user account.
- 3 Tick/untick the Local, Modem, Remote and Power options that are appropriate to the user.
- 4 Click the Save button to register your changes.

To get here

- 1 Using VNC viewer or a browser, log on as the 'admin' user.
- 2 Click the 'Configure' button in the top right corner.
- 3 Click the 'User Accounts' option.

User Name

All user names must consist of lower case characters or numbers only. No symbols or upper case characters are permissible. The user name can be between 1 and 16 characters in length.

Password

Passwords are case sensitive and can include certain keyboard symbols. The password can be between 1 and 16 characters in length. It is important to note, however, that the password background remains shaded in amber while the ServSwitch CX with IP considers your entered password to be too easy to guess. A suitable password is best constructed using a mixture of more than 6 letters, numbers and punctuation characters.

Local

When ticked, the selected user can gain access using the local KVM console directly connected to the ServSwitch CX with IP unit.

Modem

When ticked, the selected user can gain access via a modem or ISDN link (requires external modem/ISDN equipment to be connected to the ServSwitch CX with IP unit).

Remote

When ticked, the selected user can gain access via an IP network link, such as a local intranet or the wider Internet (depending on how the ServSwitch CX with IP is connected).

Power

When ticked, the selected user will be permitted to control the power input to host systems (requires optional power control switch unit(s) to be fitted).



Unit configuration

This page provides access to a selection of both basic and advanced settings for the ServSwitch CX with IP. Many of the settings displayed here are also accessible through the on-screen menu.

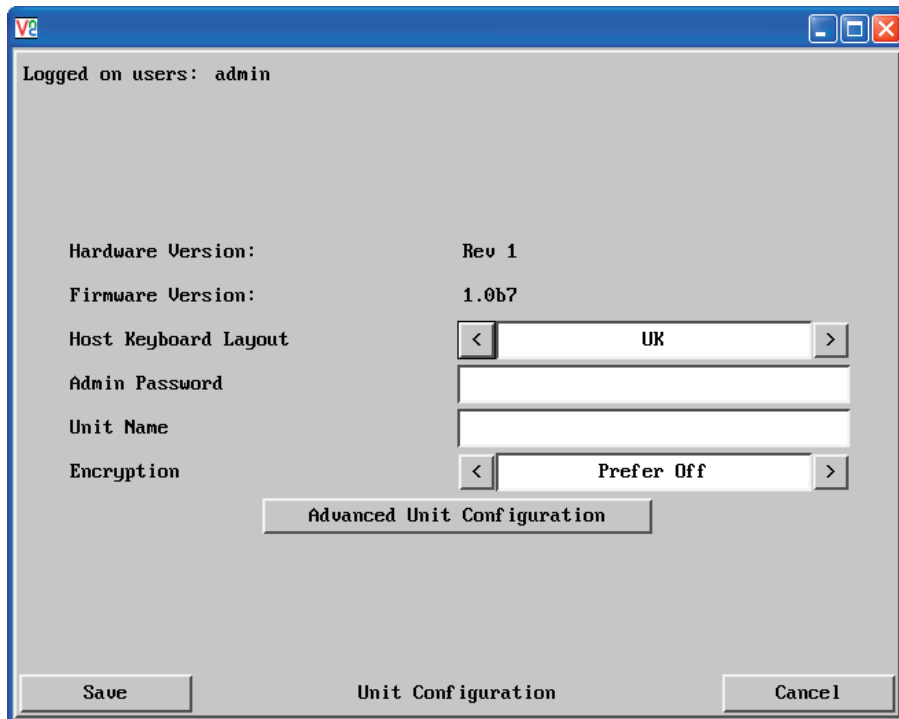

The screenshot shows a window titled "Unit Configuration" with a blue title bar. At the top left, it says "Logged on users: admin". Below this, there are several configuration fields:

- Hardware Version: Rev 1
- Firmware Version: 1.0b7
- Host Keyboard Layout: A dropdown menu showing "UK" with left and right arrow buttons.
- Admin Password: An empty text input field.
- Unit Name: An empty text input field.
- Encryption: A dropdown menu showing "Prefer Off" with left and right arrow buttons.

At the bottom of the window, there are three buttons: "Save", "Unit Configuration", and "Cancel".

Hardware Version

Indicates the version of the electronic circuitry within the ServSwitch CX with IP unit.

Firmware Version

Indicates the version of the hardwired software within the ServSwitch CX with IP flash memory. This may be updated using the [flash upgrade procedure](#).

Host Keyboard Layout

Use the arrow buttons to match the keyboard layout expected by the host system.

Admin Password

Enter the password that will be used to gain administrator access to the ServSwitch CX with IP. There can only be one admin user and only that user is given access to the configuration menus.

To get here

- 1 Using VNC viewer or a browser, log on as the 'admin' user.
- 2 Click the 'Configure' button in the top right corner.
- 3 Click the 'Unit configuration' option.

Unit Name

The name entered here will be displayed on the local menus and the remote VNC viewer/browser windows.

Encryption

Three options are available: Always on, prefer off, prefer on. The one to choose depends on the specific details of your installation - see [Encryption settings](#) for details. The use of encryption imposes a slight performance overhead of roughly 10% but is highly secure against third party intrusion.

[Advanced Unit Configuration](#)



INSTALLATION

CONFIGURATION

OPERATION

FURTHER
INFORMATION

INDEX

Advanced unit configuration

Click this button to display advanced options that do not normally require alteration.

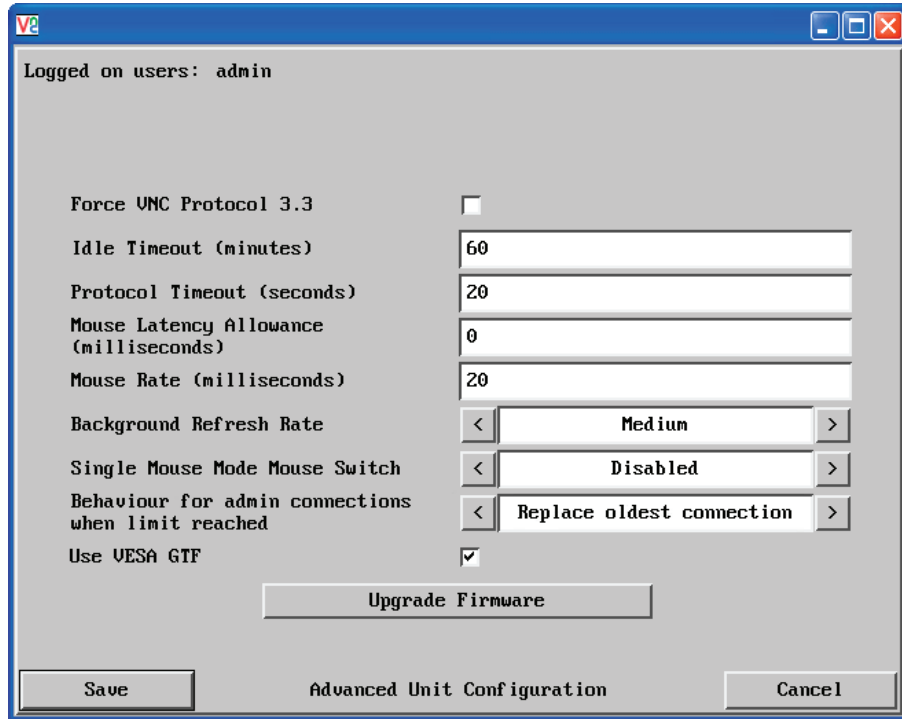

To get here

- 1 Using VNC viewer or a browser, log on as the 'admin' user.
- 2 Click the 'Configure' button in the top right corner.
- 3 Click the 'Unit configuration' option.
- 4 Click the 'Advanced unit configuration' option.

Force VNC Protocol 3.3

IMPORTANT: The use of this option is not recommended. Protocol 3.3 is a legacy version that does not offer any encryption.

Idle Timeout

Determines the period of inactivity on a global connection before the user is logged out. The idle timeout period can be set to any time span, expressed in minutes.

Note: The [Screensaver](#) option serves a similar purpose for local connections.

Protocol Timeout

Sets the time period by which responses should have been received to outgoing data packets. If the stated period is exceeded, then a connection is considered lost and terminated.

Mouse Latency Allowance

This option is used during calibration to account for latency delays (caused as signals pass through a device) introduced by some KVM switches from alternative manufacturers.

During calibration, the ServSwitch CX waits for 40ms after each mouse movement before sampling the next. If a KVM device adds a significant delay to the flow of data, the calibration process can be lengthened or may fail entirely. The value entered here is added to (or subtracted from) the default 40ms sampling time.

Note: You can enter negative values (down to -40) in order to speed up the calibration process when using fast KVM switches. Use this option with caution as it can adversely affect the calibration process.

Mouse Rate

Defines the rate at which mouse movement data are transmitted to the system. The default option is 20ms, which equates to 50 mouse events per second. This default rate can prove too fast when passed through certain connected KVM switches from alternative manufacturers. In such cases, data are discarded causing the local and remote mouse pointers to drift apart. If this effect is encountered, increase the mouse rate to around 30ms (data are then sent at a slower rate of 33 times per second).

Background Refresh Rate

Use the arrow keys to alter the refresh rate for screen images via remote links. This allows you to tailor the screen refresh to suit the network or modem connection speeds. The options are: Slow, Medium, Fast or Disabled. When the disabled option is selected, the remote users will need to manually refresh the screen.

Note: When a low connection speed is detected, the background refresh is automatically disabled, regardless of the settings of this option.

Single Mouse Mode Mouse Switch

Allows you to select the mouse button combination that can be used to exit from single mouse mode (when active).

Behaviour for admin connections when limit reached

Determines what should occur when four global connections already exist and a fifth, administrator connection attempt is made. Options are: *Replace oldest connection*, *Replace newest connection* and *Don't replace*. Only non-administrator connections can be terminated in this way.

Use VESA GTF

When ticked, the VESA Generalized Timing Formula will be used to help determine the correct input video resolution and timing details. See [Appendix 9](#) for a list of all supported video modes.

Upgrade firmware

Places the unit into upgrade mode. See [Upgrading ServSwitch CX with IP models](#).



Time & date configuration

This page allows you to configure all aspects relating to time and date within the ServSwitch CX with IP unit.

Logged on users: admin

Time And Date

Timezone specifier (e.g. EST5)

Use NTP

NTP Server IP address

Set Time from NTP Server

Save Time & Date Configuration Cancel

Time and Date

Use the arrow buttons to set the correct current time.

Use NTP

When this option is selected, the ServSwitch CX will synchronise its internal clocks using information from the (Network Time Protocol) server listed in the *NTP Server IP address* field.

NTP Server IP address

Optionally enter the IP address for a known Network Time Protocol server.

Set Time from NTP Server

Click to immediately use the time and date information from the listed NTP server.

Timezone specifier

Optionally enter a recognised timezone specifier related to the current position of the ServSwitch CX with IP unit. When an NTP server is used, the specifier will be used to provide the correct real time.

The timezone specifier takes the following form:

std offset dst [offset], start[/time], end[/time]

The *std* and *offset* specify the standard time zone, such as GMT and 0, or CET and -1, or EST and 5, respectively.

The *dst* string and [*offset*] specify the name and offset for the corresponding Daylight Saving Time zone; if the *offset* is omitted, it defaults to one hour ahead of standard time.

The remainder of the specification describes when Daylight Saving Time is in effect. The *start* field is when Daylight Saving Time goes into effect and the *end* field is when the change is made back to standard time. The most common format used for the daylight saving time is: *mm.w.d*

Where: *m* specifies the month and must be between 1 and 12. The day *d* must be between 0 (Sunday) and 6. The week *w* must be between 1 and 5; week 1 is the first week in which day *d* occurs, and week 5 specifies the *last d* day in the month.

The *time* fields specify when, in the local time currently in effect, the change to the other time occurs. If omitted, the default is 02:00:00.

Typical examples are:

UK:	GMT0BST,M3.5.0/1,M10.5.0/2
Central Europe:	CET-1CEST,M3.5.0/2,M10.5.0/3
US Eastern (2006):	EST5EDT,M4.1.0/2,M10.5.0/2
US Pacific (2006):	PST8PDT,M4.1.0/2,M10.5.0/2
US Eastern (from 2007):	EST5EDT,M3.2.0/2,M11.1.0/2
US Pacific (from 2007):	PST5PDT,M3.2.0/2,M11.1.0/2

For further details

- For details of timezone specifier formats, please refer to: http://www.gnu.org/software/libc/manual/html_node/TZ-Variable.html
- For details of the Network Time Protocol (main RFC number: 1305; the SNTP subset used as the basis for the ServSwitch CX with IP: 4330) <http://www.ietf.org/rfc.html>



Network configuration

This page allows you to configure the various aspects of the IP port and its relationship with the local network.

Logged on users: admin

MAC address: 00:0F:58:40:07:FE

Use DHCP

IP Address 192.168.0.4

IP Network Mask 255.255.255.0

IP Gateway 192.168.0.1

UNC Port 5900

HTTP Port (0=disabled) 80

IP Access Control

Add Remove Up Down Edit

+0.0.0.0/0.0.0.0

Save Network Configuration Cancel

MAC address

Media Access Control address – this is the unique and unchangeable code that was hard coded within your ServSwitch CX with IP unit when it was built. It consists of six 2-digit hexadecimal (base 16) numbers separated by colons. A section of the MAC address identifies the manufacturer, while the remainder is effectively the unique electronic serial number of your particular unit.

Use DHCP

DHCP is an acronym for 'Dynamic Host Configuration Protocol'. Its function is particularly useful when connecting to medium size or larger networks, such as the Internet. When this option is selected, your ServSwitch CX with IP will attempt to locate a DHCP server on the network. If such a server is located, it will supply three things to the ServSwitch CX with IP: an IP address, an IP network mask (also known as a Subnet mask) and a Gateway address. These are not usually granted permanently, but on a 'lease' basis for a fixed amount of time or for as long as the ServSwitch CX with IP remains connected and switched on. [Discover allocations](#).

To get here

- 1 Using VNC viewer or a browser, log on as the 'admin' user.
- 2 Click the 'Configure' button in the top right corner.
- 3 Click the 'Network configuration' option.

IP Address

This is the identity of the ServSwitch CX with IP within a network. The [IP address](#) can be thought of as the telephone number of the ServSwitch CX with IP. Unlike the MAC address, the IP address can be altered to suit the network to which it is connected. It can either be entered manually or configured automatically using the DHCP option. When the DHCP option is enabled, this entry is greyed out.

IP Network Mask

Also often called the [subnet-mask](#), this value is used alongside the IP address to help define a smaller collection (or subnet) of devices on a network. In this way a distinction is made between locally connected devices and ones that are reachable elsewhere, such as on the wider Internet. This process helps to reduce overall traffic on the network and hence speed up connections in general.

IP Gateway

This is the address of the device that links the local network (to which the ServSwitch CX with IP is connected) to another network such as the wider Internet. Usually the actual gateway is a network switch or router and it will be used whenever a required address lies outside the current network.

VNC Port

This is the logical link through which communications with a remote VNC viewer will be channelled (see [What is a port?](#)). The default setting is 5900 which is a widely recognised port number for use by VNC software. However, in certain circumstances it may be advantageous to alter this number - see 'Security issues with ports' for more details.

HTTP Port

This is the logical link through which communications with a remote web browser will be channelled (see [What is a port?](#)). The default setting of 80 is an established standard for web (HTTP – HyperText Transfer Protocol) traffic though this can be changed to suit your local network requirements.

IP Access Control

This section allows you to optionally specify ranges of addresses which will or won't be granted access to the ServSwitch CX with IP. If this option is left unchanged, then the default entry of '+0.0.0.0/0.0.0.0' ensures that access from all IP addresses will be permitted. See [Setting IP access control](#) for details.





Setting IP access control

The golden rule with this feature is 'Include before you exclude' or to put it another way 'Arrange *allowed* addresses in the list *before* the *denied* addresses'.

This is because the positions of entries in the list are vitally important. Once a range of addresses is denied access, it is not possible to make exceptions for particular addresses within that range. For instance, if the range of addresses from A to F are denied access first, then the address C could not be granted access lower down the list. Address C needs to be placed in the list before the denied range.

IMPORTANT: This feature should be configured with extreme caution as it is possible to deny access to everyone. If such an error occurs, see [Clearing IP access control](#) for details about how to regain access.

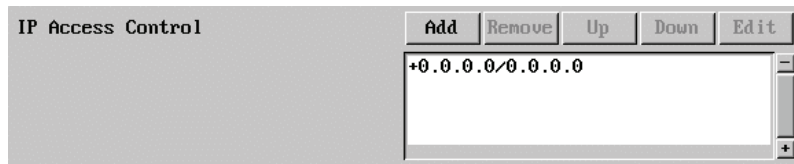

In the list, access control addresses prefixed by '+' are allow entries while those prefixed by '-' are deny entries.

To get here

- 1 Using VNC viewer or a browser, log on as the 'admin' user.
- 2 Click the 'Configure' button in the top right corner.
- 3 Click the 'Network configuration' option.

To define a new IP access control entry

- 1 Click the Add button to display a popup dialog:

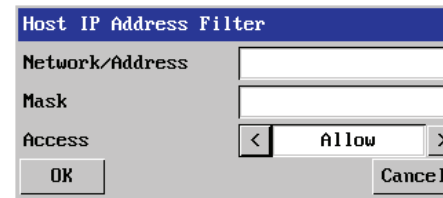

Network/Address

Enter the network address that is to be allowed or denied access. If a range of addresses is being specified then specify any one of the addresses within the range and use the Mask entry to indicate the size of the range.

Mask

Enter an IP network mask that indicates the range of addresses that are to be allowed or denied access. For instance, if only a single specified IP address were to be required, the mask entry would be 255.255.255.255 in order to specify a single location. See [Calculating the mask for IP access control](#) for details.

Access

Use the arrow buttons to select either 'Allow' or 'Deny' as appropriate.

- 2 Enter the base [network address](#), the [mask](#) and select the appropriate access setting.
- 3 Click the OK button.

To reorder access control entries

IMPORTANT: When reordering, ensure that any specific allowed addresses are listed higher in the list than any denied addresses. Take care not to invoke any deny access settings that would exclude valid users.

- 1 In the access control list, click on the entry to be moved.
- 2 Click the Up or Down buttons as appropriate.

To edit/remove access control entries

- 1 In the access control list, click on the appropriate entry.
- 2 Click either the Edit or Remove button as appropriate.

Serial port configuration

This page provides all access to settings concerned with the two serial ports (modem and power control) that are situated at the rear of the ServSwitch CX with IP unit.

The screenshot shows a window titled "Serial Configuration" with a status bar at the top indicating "Logged on users: admin". The window is divided into two main sections: "Modem Port" and "Power Control Port".

Modem Port settings:

- PPP Server IP Address: 192.168.3.1
- PPP Client IP Address: 192.168.3.2
- Baud Rate: 115200
- Initialization Sequence: ATZS0=1

Buttons for "Initialize" and "Restore Defaults" are located below the Modem Port settings.

Power Control Port settings:

- Baud Rate: 9600

Buttons for "Save" and "Cancel" are located at the bottom of the window.

To get here

- 1 Using VNC viewer or a browser, log on as the 'admin' user.
- 2 Click the 'Configure' button in the top right corner.
- 3 Click the 'Serial port configuration' option.

Modem port

PPP Server IP Address / PPP Client IP Address

When a user dials into the ServSwitch CX with IP via a modem or ISDN adapter, the ServSwitch CX with IP sets up a temporary two-device network using PPP (Point to Point Protocol). For this purpose, both devices must have 'dummy' IP addresses so that they can communicate correctly. These two addresses can be almost anything expressed in the quad octet format (i.e. 192.168.3.1.). However, it is advisable not to make them the same as the real IP addresses used by either the remote system or the ServSwitch CX with IP.

Baud Rate

This option configures the speed of the serial connection between the ServSwitch CX with IP and a connected modem or ISDN terminal adapter. The default setting is 115200. The other communication settings are fixed as: No parity, 8 bit word, 1 stop bit.

Initialization Sequence

The codes entered here are used to prepare the connected modem or ISDN terminal adapter for use with the ServSwitch CX with IP. The default code is a Hayes-compatible string to configure auto answer mode and would be understood by the vast majority of modem/ISDN devices. The code is sent when the ServSwitch CX with IP is first switched on or whenever the Initialize button is clicked.

Initialise

When clicked, this option sends the characters entered in the Initialization sequence field to the connected modem or ISDN terminal adapter.

Restore Defaults

When clicked, this option resets the Baud rate and Initialization sequence values to their original default settings.

Power control port

Baud Rate

This option configures the speed of the serial connection between the ServSwitch CX with IP and a connected power control unit. The default setting is 9600 as used by the majority of power units. The other communication settings are fixed as: No parity, 8 bit word, 1 stop bit.



Host configuration

This page provides the opportunity to configure various details for each of the host systems that may be connected to the ServSwitch CX with IP via one or more KVM switch units. There are 128 entries, each of which can be configured with a name, the permitted users, the hot key combinations required to switch to it and, if required, appropriate power control commands.

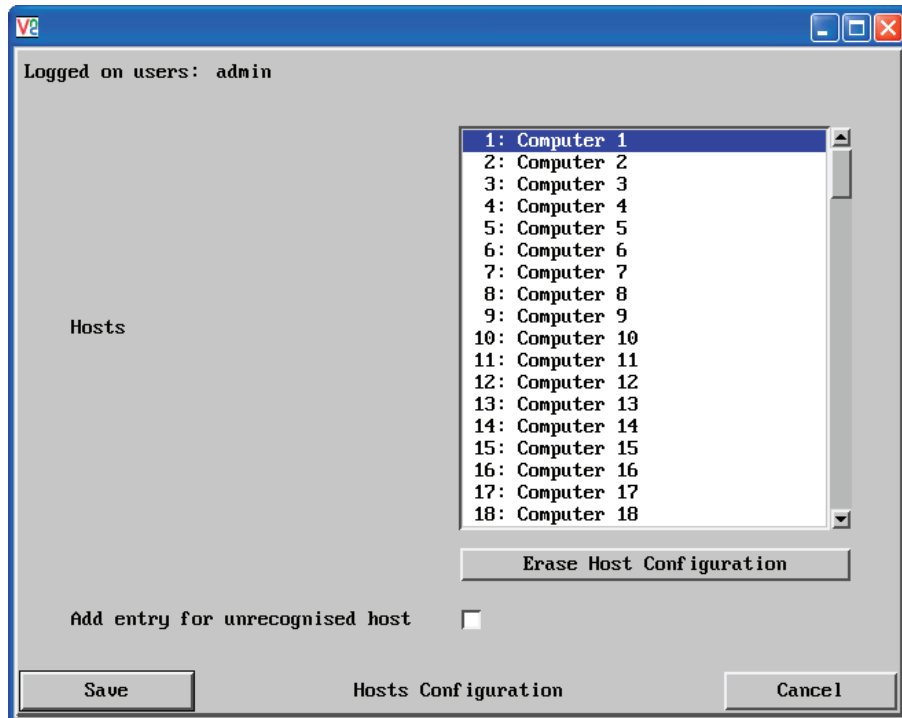

Add entry for unrecognised host

When selected, any systems visited that are not specified in the Hosts list, will be added to the list. Use with care when visiting complex cascaded systems.

Erase Host Configuration

Removes all hosts from the list.

To get here

- 1 Using VNC viewer or a browser, log on as the 'admin' user.
- 2 Click the 'Configure' button in the top right corner.
- 3 Click the 'Host configuration' option.

To create a new host entry

- 1 Click one of the host entries to reveal a Host configuration dialog.

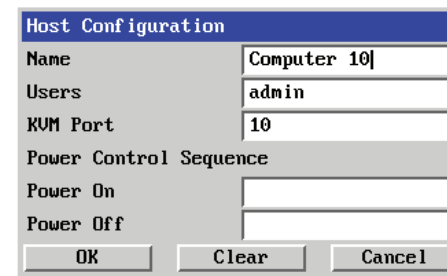

Name

Enter the name that will be displayed in the viewer window when you click the Host button.

Users

Select the users that will be permitted to connect to this host. Either enter * to allow all users or a list of users separated by commas (e.g. admin, nigel, andy, steve).

KVM Port

Declare the Port Direct address that will link with the required host system. See [Port Direct](#) for details.

A list of valid hotkey codes are given in [Appendix 8](#).

Power On

Enter the code required to make an attached power control unit apply power to the selected host. See [Power switching configuration](#) for details.

Power Off

Enter the code required to make an attached power control unit remove power from the selected host. See [Power switching configuration](#) for details.

- 2 Enter the required information in each field.
- 3 Click the OK button.



Port Direct

Port Direct is totally transparent communication system that allows supporting devices to communicate with each other. Using the keyboard connections that link each device, Port Direct allows:

- A controlling device to provide address details of the required port, the user's name and access rights, mouse calibration and video mode information.
- A controlled device to confirm the address and other details of the current port.

Such communication simplifies both the configuration and selection of systems, especially within a complex cascade structure. Port Direct also allows the ServSwitch CX *Hosts* option to directly control the connected switching devices (such as other ServSwitch CX units in cascade) and then apply the appropriate video capture and mouse scaling settings. Port Direct provides excellent security control to prevent users from accessing systems for which they do not access rights ('sideways movement') because each unit is fully informed of each user's precise access rights.

Port/host addressing using Port Direct

When adding new servers to the Hosts list, the option '*Add entry for unrecognised host*' is provided to automatically add new entries if a port is visited that does not already have a matching host entry. This is a useful option for simple configurations, but should be used with care when complex cascades of units are being used as it may lead to more host entries being added than are strictly necessary.

Additionally, you can specify the port number of the required system using the same format as if controlling the KVM switch directly. Port numbers MUST be entered within square brackets and can be specified to a maximum of four cascaded levels.

Examples

- [16]** selects port 16 and is equivalent to the hotkey sequence +CTRL+ALT+1+6
- [4105]** selects port 5 on ServSwitch CX unit that is cascaded through port group 41 (see [cascade port numbering](#)).



INSTALLATION

CONFIGURATION

OPERATION

FURTHER
INFORMATION

INDEX

Logging and status

This screen provides various details about the user activity on the ServSwitch CX with IP unit.

The screenshot shows a window titled 'Logging and Status' with a list of log entries and several control buttons. The log entries are as follows:

```
01 Jan 00 01:32:40 UTC Logoff admin, 192.168.0.2
01 Jan 00 01:35:47 UTC accepted: 192.168.0.2::1244
01 Jan 00 01:35:48 UTC Logon admin, 192.168.0.2, no auth
01 Jan 00 01:35:50 UTC Switch to host Computer 2
01 Jan 00 01:35:53 UTC Switch to host Server 1
01 Jan 00 01:37:18 UTC Logoff admin, local
01 Jan 00 01:37:18 UTC Logon failure admin, local, password
01 Jan 00 01:37:22 UTC Logon admin, local, no auth
01 Jan 00 01:37:45 UTC closed: 192.168.0.2::1244 (Client does not support desk
01 Jan 00 01:37:45 UTC Logoff admin, 192.168.0.2
01 Jan 00 01:38:05 UTC accepted: 192.168.0.2::1245
01 Jan 00 01:38:06 UTC Logon admin, 192.168.0.2, no auth
01 Jan 00 01:42:51 UTC Access mode private, admin, 192.168.0.2
01 Jan 00 01:42:57 UTC Access mode shared, admin, 192.168.0.2
01 Jan 00 01:43:04 UTC Access mode private, admin, 192.168.0.2
01 Jan 00 02:36:54 UTC closed: 192.168.0.2::1245 (Disconnection by client)
01 Jan 00 02:36:54 UTC Access mode shared, admin, 192.168.0.2
01 Jan 00 02:36:54 UTC Logoff admin, 192.168.0.2
01 Jan 00 02:37:02 UTC accepted: 192.168.0.2::1274
01 Jan 00 02:37:03 UTC Logon admin, 192.168.0.2, no auth
```

Control buttons include 'Clear Log', 'Refresh', 'Save', and 'Cancel'. A text field for 'Syslog Server IP Address' is also present. The window title is 'Logged on users: admin'.

Annotations for the screenshot:

- Date and time the event occurred
- Type of event, user name and access method or remote IP address
- Click to clear all log entries
- Click to refresh the list
- Optionally enter an IP address to which the status log should be sent
- Click to return to the main menu

To copy and paste the log

You can copy the information listed within the log and paste it into another application.

- 1 While viewing the log screen, press Ctrl and C, to copy the data into the clipboard.
- 2 In a text application (i.e. Word, WordPad, Notepad) press Ctrl and V, or right mouse click and 'Paste'.

Syslog Server IP Address

Logging information can optionally be sent, as it occurs, to a separate system using the standard Syslog protocol. Enter the IP address of a suitable system in the field provided.

For further details

- For details of the Syslog protocol (RFC number: 3164) <http://www.ietf.org/rfc.html>

To get here

- 1 Using VNC viewer or a browser, log on as the 'admin' user.
- 2 Click the 'Configure' button in the top right corner.
- 3 Click the 'Logging and status' option.



Appendix 3 - VNC viewer connection options

When you are connecting to the ServSwitch CX with IP using the VNC viewer, a number of options are available.

Click here to access the options

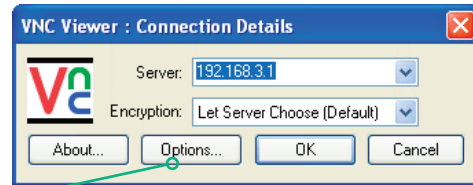

There are six tabbed pages of options:

- Colour/Encoding
- [Inputs](#)
- [Scaling](#)
- [Misc](#)
- [Identities](#)
- [Load/Save](#)

IMPORTANT: If you make any changes to the options given here and wish to retain them for successive connection sessions, you must save the changes. To do this, change to the 'Load/Save' tab and click the 'Save' button within the 'Default' section.

Colour/Encoding

Auto select

When ticked, this option will examine the speed of your connection to the ServSwitch CX with IP and apply the most suitable encoding method. This option is suggested for the majority of installations.

Preferred encoding

There are three manually selectable encoding methods which are accessible when the Auto select option is unticked.

- **ZRLE** – This is a highly compressed method that is best suited to slow modem connections.
- **Hextile** – This method offers better performance than the ZRLE when used over a high speed network because there is no need for the ServSwitch CX with IP to spend time highly compressing the data.
- **Raw** – This is a primitive, uncompressed method that is mainly used for technical support issues. You are recommended not to use this method.

Colour level

This section allows you to select the most appropriate colour level for the speed of the connection to the ServSwitch CX with IP. Where the connection speed is slow or inconsistent there will be a necessary compromise between screen response and colour depth.

- **Full** – This mode is suitable only for fast network connections and will pass on the maximum colour depth being used by the host system.
- **Medium (256 colours)** – This mode reduces the host system output to a 256 colour mode and is more suitable for ISDN and fast modem connections.
- **Low (64 colours)** – This mode is suitable for slower modem connections and reduces the host system output to 64 colours.
- **Very low (8 colours)** – This mode provides very rudimentary picture quality and hardly any speed advantage over the 64 colour setting. You are recommended not to use this mode.

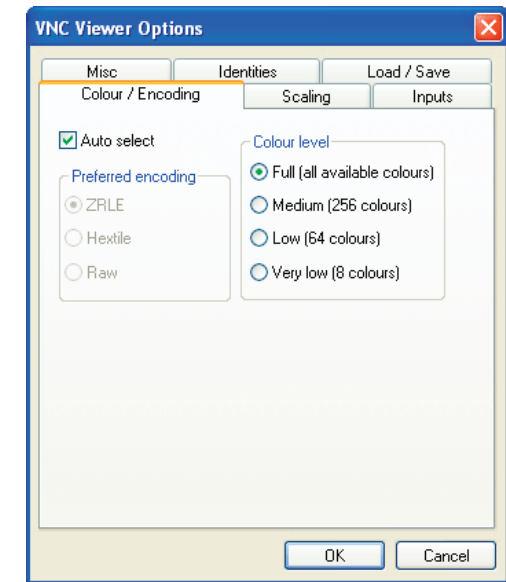

Inputs

Enable all inputs

When selected, allows keyboard, mouse and clipboard data to be transferred between server and viewer systems.

Disable all inputs (view-only mode)

When selected, prevents control data being passed between server and viewer. Viewer can display the server output, but cannot control it.

Customise

Allows you to select which data can be transferred between server and viewer.

Send pointer events to server

When un-ticked, the VNC viewer will not send mouse movement or click data to the ServSwitch CX with IP or host system.

Send keyboard events to server

When un-ticked, the VNC viewer will not send keyboard information to the ServSwitch CX with IP or host system.

Send clipboard changes to server

This feature is restricted to software server versions of VNC and has no effect on ServSwitch CX with IP installations.

Accept clipboard changes from server

This feature is restricted to software server versions of VNC and has no effect on ServSwitch CX with IP installations, except for retrieving the activity log as described in the logging and status section.

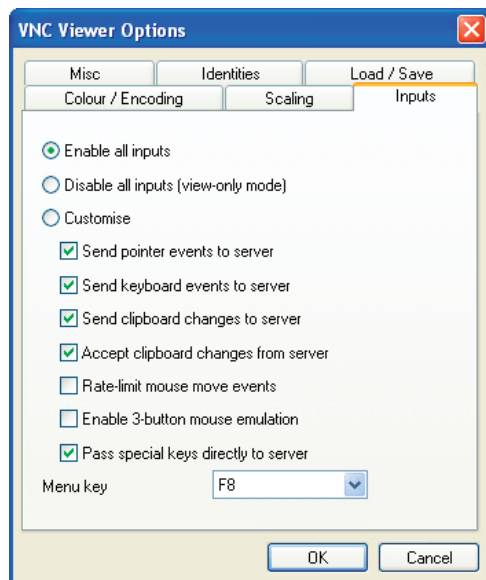

Rate-limit mouse move events

When ticked, this feature reduces the mouse movement information that is sent to the ServSwitch CX with IP and host system. This is useful for slow connections and you will notice that the remote cursor will catch up with the local cursor roughly once every second.

Enable 3-button mouse emulation

This feature allows you to use a 2-button mouse to emulate the middle button of a 3-button mouse. When enabled, press the left and right mouse buttons simultaneously to create a middle button action. You are advised to generally use a 3-button mouse.

Pass special keys directly to server

When ticked, 'special' keys (the Windows key, the Print Screen key, Alt+Tab, Alt+Escape and Ctrl+Escape) are passed directly to the ServSwitch CX with IP rather than being interpreted locally.

Menu key

This feature allows you to select which function key is used to display the VNC viewer options menu. The menu key is only way to exit from the full screen viewer mode.

IMPORTANT: If you make any changes to the options given here and wish to retain them for successive connection sessions, you must save the changes. To do this, change to the 'Load/Save' tab and click the 'Save' button within the 'Default' section.



Scaling

No Scaling

No attempt is made to make the screen image fit the viewer window. You may need to scroll horizontally and/or vertically to view all parts of the screen image.

Scale to Window Size

Adjusts the server screen image to suit the size of the viewer window.

Custom Size

Adjusts the server screen image according to the Width and Height settings in the adjacent fields. A drop box to the right of the fields allows you to define the image size by percentage or by pixels, as required.

Preserve Aspect Ratio

When ticked, maintains a consistent ratio between the horizontal and vertical dimensions of the screen image.

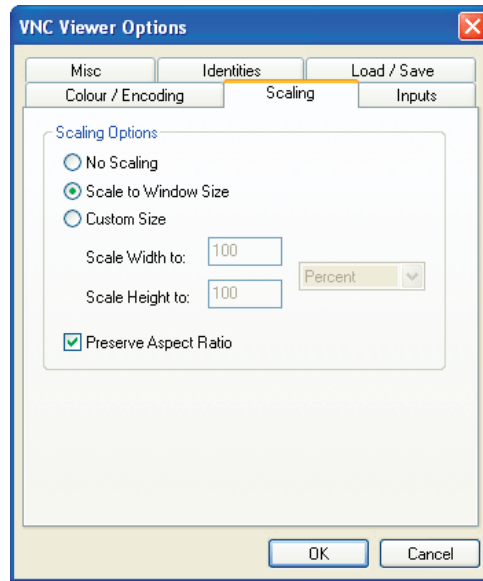

Misc

Shared connection (do not disconnect other viewers)

This option does not apply to ServSwitch CX with IP connections.

Full screen mode

When ticked, the VNC viewer will launch in full screen mode. Use the menu key (usually F8) to exit from full screen mode.

Render cursor locally

This option does not currently apply to ServSwitch CX with IP connections.

Allow dynamic desktop resizing

When ticked, the viewer window will be automatically resized whenever the host system's screen resolution is altered.

Only use protocol version 3.3

This option does not apply to ServSwitch CX with IP connections.

Beep when requested to by the server

When ticked, your local system will beep in response to any error beeps emitted by the ServSwitch CX with IP.

Offer to automatically reconnect

When ticked, the viewer will offer to restore a lost connection with the server.

Try Single Sign-On if server allows it

This option does not apply to ServSwitch CX with IP connections.

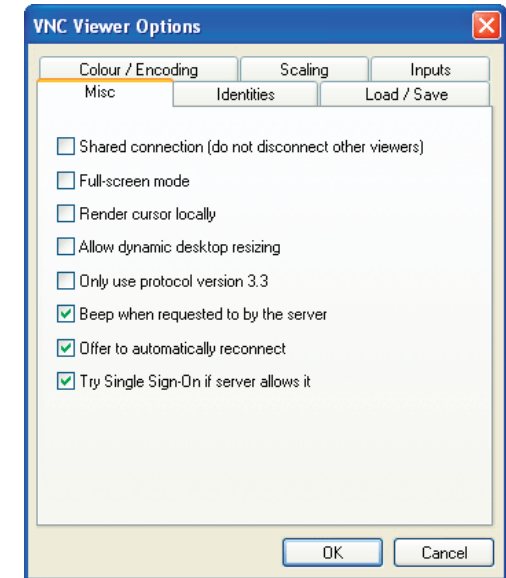

IMPORTANT: If you make any changes to the options given here and wish to retain them for successive connection sessions, you must save the changes. To do this, change to the 'Load/Save' tab and click the 'Save' button within the 'Default' section.



Identities

This feature helps your VNC viewer to confirm that a revisited ServSwitch CX with IP is genuine and not another device masquerading as a ServSwitch CX with IP. The list given will retain the identities of all visited units (that have full security enabled).

When you first make a secure connection to the ServSwitch CX with IP, the security information for that ServSwitch CX with IP unit is cached within this Identities tab (i.e. the "identity" is known). The next time that you connect to the ServSwitch CX with IP, its identity is checked against the stored version. If a mismatch is found between the current and the stored identities then a warning will be issued to you.

If an existing ServSwitch CX with IP is fully reconfigured then it will need to be issued with a new identity. In this case the previous identity, listed in this tab, should be removed so that a new identity can be created on the next connection.

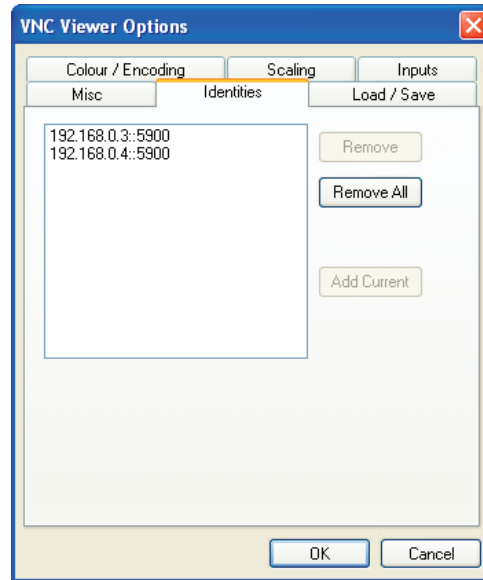

Load / Save

Configuration File - Reload

Allows you to load a configuration file saved from this, or another viewer.

Configuration File - Save

Allows you to save the current settings so that they can be copied from one viewer to another.

Configuration File - Save As...

Allows you to save the current settings under a new name so that they can be copied from one viewer to another.

Defaults - Reload

When clicked, all connection options are returned to the default settings that are currently saved.

Defaults - Save

When clicked, saves the current connection options as the default set that will be used in all subsequent VNC connections.

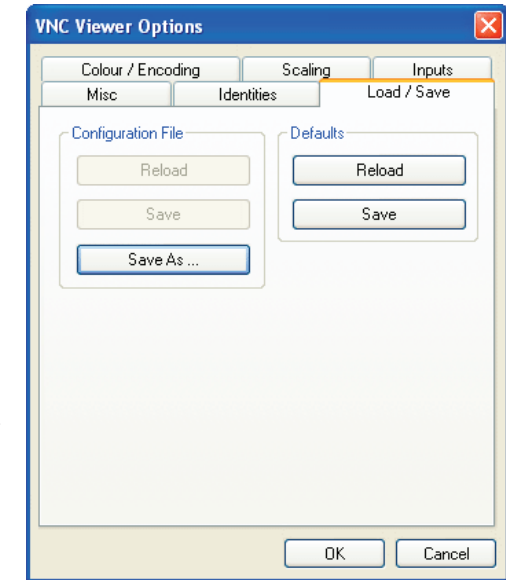

Appendix 4 - VNC viewer window options

Click the VNC icon in the top left corner of the viewer window (or press F8) to display the window options:

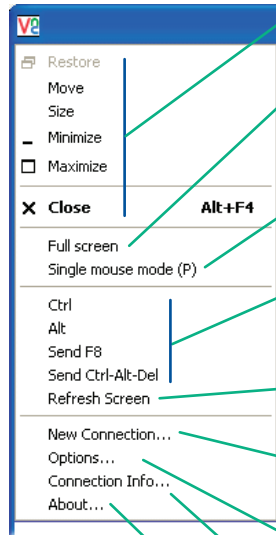

- **Standard window control items**
- **Full screen**
Expands the VNC viewer window to fill the whole screen with no visible window edges or toolbar. Press F8 to re-display this menu.
- **Single mouse mode (P)**
Used for fast network connections where a second, "predictor" cursor is not required.
- **Ctrl, Alt, Send F8, Send Ctrl-Alt-Del**
Sends the selected keypress(es) to the ServSwitch CX with IP and host server. This is necessary because certain keys and key combinations are trapped by the VNC viewer.
- **Refresh Screen**
Requests data from the server for a complete redraw of the screen image, not just the items that change.
- **New connection...**
Displays the connection dialog so that you can log on to a different ServSwitch CX or VNC server location.
- **Options...**
Displays the full range of connection options - see [Appendix 3](#) for more details.
- **Connection info...**
Displays various connection and display details.
- **About...**
Displays information about your VNC viewer.

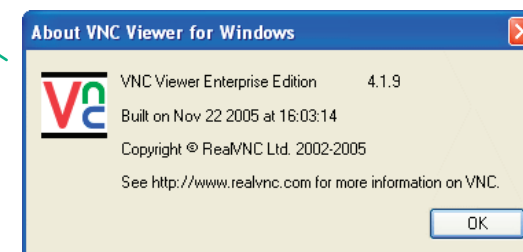
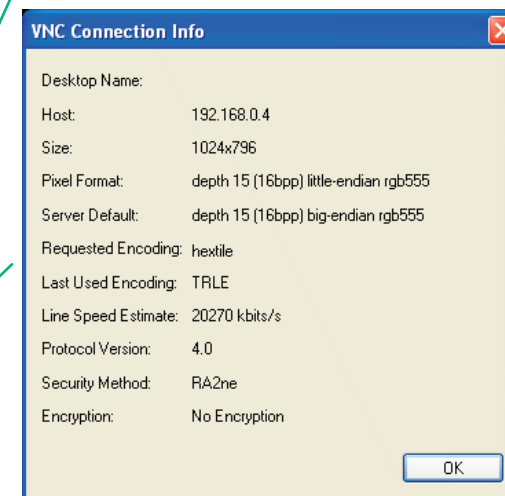
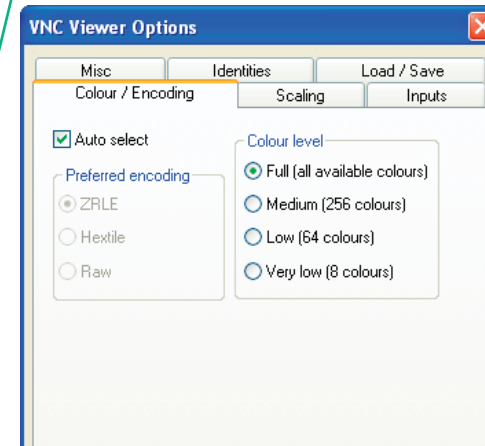
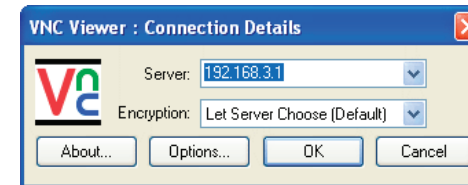

INSTALLATION

CONFIGURATION

OPERATION

FURTHER INFORMATION

INDEX

Appendix 5 - Browser viewer options

When you are connecting to the ServSwitch CX with IP using a Web browser, a number of options are available.

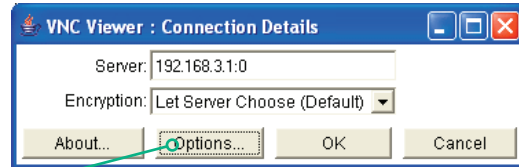

Click here to access the options

There are four options pages:

Encoding and colour level

Auto select

When ticked, this option will examine the speed of your connection to the ServSwitch CX with IP and apply the most suitable encoding method. This option is suggested for the majority of installations.

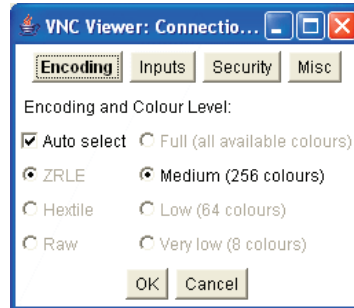

Preferred encoding

There are three manually selectable encoding methods which are accessible when the Auto select option is unticked.

- **ZRLE** – This is a highly compressed method that is best suited to slow modem connections.
- **Hextile** – This method offers better performance than the ZRLE when used over a high speed network because there is no need for the ServSwitch CX to spend time highly compressing the data.
- **Raw** – This is a primitive, uncompressed method that is mainly used for technical support issues. You are recommended not to use this method.

Colour level

The colour level is fixed at Medium (256 colours) for almost all browsers.

Inputs

View only (ignore mouse & keyboard)

When ticked, the viewer will not send keyboard or mouse information to the ServSwitch CX with IP or host server.

Accept clipboard from server

This feature is restricted to software server versions of VNC and has no effect on ServSwitch CX with IP installations.

Send clipboard to server

This feature is restricted to software server versions of VNC and has no effect on ServSwitch CX with IP installations.

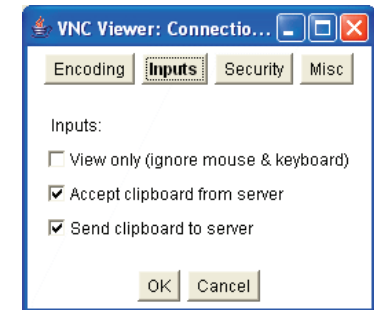

Security

512 bits (low security)

Selects the lowest level of encoding for communications between the browser and the ServSwitch CX with IP.

1024 bits (medium security)

Selects the middle level of encoding for communications between the browser and the ServSwitch CX with IP.

2048 bits (high security)

Selects the highest level of encoding for communications between the browser and the ServSwitch CX with IP.

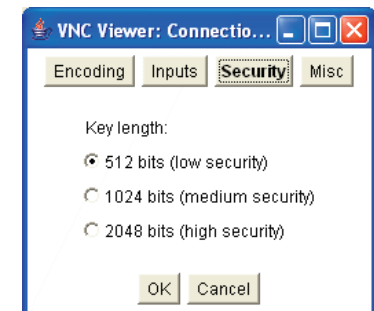

Misc

Shared (don't disconnect other viewers)

This feature is restricted to software server versions of VNC and has no effect on ServSwitch CX with IP installations.

Render cursor locally

This feature is restricted to software server versions of VNC and has no effect on ServSwitch CX with IP installations.

Fast CopyRect

This feature is restricted to software server versions of VNC and has no effect on ServSwitch CX with IP installations.

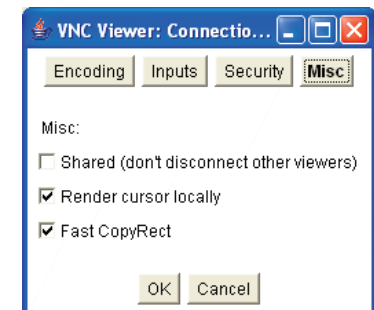

Appendix 6 – Addresses, masks and ports

IP address, network masks and ports are all closely linked in the quest for one device to find another across disparate network links.

IP addresses

As a rough analogy, consider how you use the telephone system. The phone number for Black Box in the US is **1-724-746-5500**. This number consists of three distinct parts:

- **1** connects from another country to the US,
- **724** connects into Pennsylvania,
- **746** selects the telephone exchange in Lawrence, and
- **5500** is the unique code for Black Box within Lawrence.

The important parts of the whole number depend on where you are. If you were based in the same local area as Black Box in the US, there would be no point in dialling out of the US, or even out of the area. The only part of the whole number that you are interested in is the final part: **5500**.

In a similar way to the various parts of the telephone number, the four sections (or *Octets*) of every IP address have different meanings or “weights”. Consider the following typical IP address:

192.168.142.154

192 is the most global part of the number (akin to the *1* of the phone number) and **154** is the most local (similar to the *5500* unique local code of the phone number).

When two network devices communicate with each other, they always “dial the whole number” regardless of their respective locations in a network. However, they still need to know whether the other device is local to them or not, and this is where the net mask comes into play.

Net masks

The net mask (or sub-net mask) informs a device as to its own position within a network. From this it can determine whether any other device is within the same local network or is situated further afield.

Taking the telephone number analogy given in the IP address section, in order to use the telephone system efficiently, it is vital for you to know your location relative to the person you are calling. In this way you avoid dialling unnecessary numbers.

When one network device needs to talk to another, the first thing that it will do is a quick calculation using its own IP address, the other device’s IP address and its own net mask. Suppose a device with address **192.168.142.154** and net mask **255.255.255.0** needed to communicate with a device at address **192.168.142.22**. The sending device would perform several calculations:

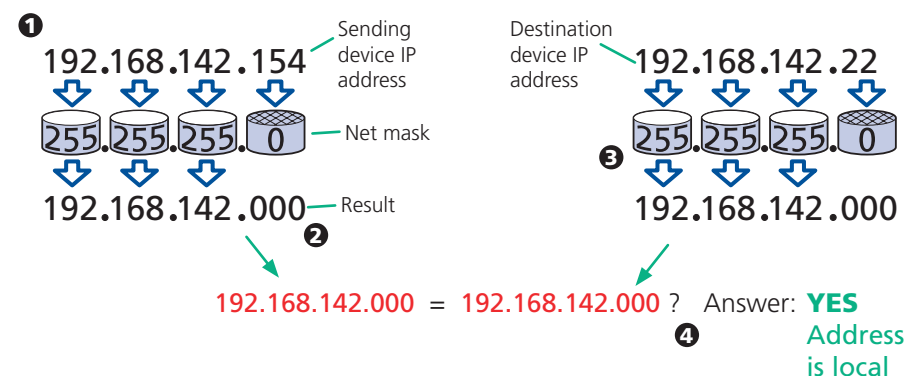

- 1** The net mask is used to determine the local and global parts of the sender’s IP address. Where there is 255 in the mask, the corresponding address slips through, where there is a 0, it is blocked.
- 2** Where the net mask was 0, the corresponding part of the result is also zero - this section is now known to be the local part of the IP address.
- 3** The same process is carried out for the destination address, again using the sender’s net mask. Now the local parts of both addresses have been equalised to zero, because their values are not important in determining whether they are both in the same local network.
- 4** The results of the two net mask operations are now compared, if they match, the destination is local. If not, then the sender will still use the same full destination IP address but will also flag the message to go via the local network gateway and out into the wider world.

The reason for doing this? It makes the network, as a whole, much more efficient. If every message for every recipient was shoved straight out onto the Internet, the whole thing would grind to a halt within seconds. Net masks keep local traffic just that - local.

[Want to know more?](#)





Net masks - the binary explanation

To really understand the operation of a net mask it is necessary to delve deeper into the life blood of servers – *binary*; this is native digital, where everything is either a 1 (one) or 0 (zero), on or off, yes or no.

The net mask operation described on the [previous page](#) is known as a ‘bit-wise AND function’. The example of 255.255.255.0 is handy because the last octet is completely zero and is “clean” for illustrative purposes. However, actual net mask calculations are carried out, not on whole decimal numbers, but bit by bit on binary numbers, hence the term ‘bit-wise’. In a real local network, a net mask might be 255.255.255.240. Such an example would no longer be quite so clear, until you look at the net mask in its binary form:

11111111.11111111.11111111.11110000

In this case, the four zeroes at the end of the net mask indicate that the local part of the address is formed by only the last four bits. If you use the diagram from the previous example and insert the new net mask, it will have the following effect on the final result:

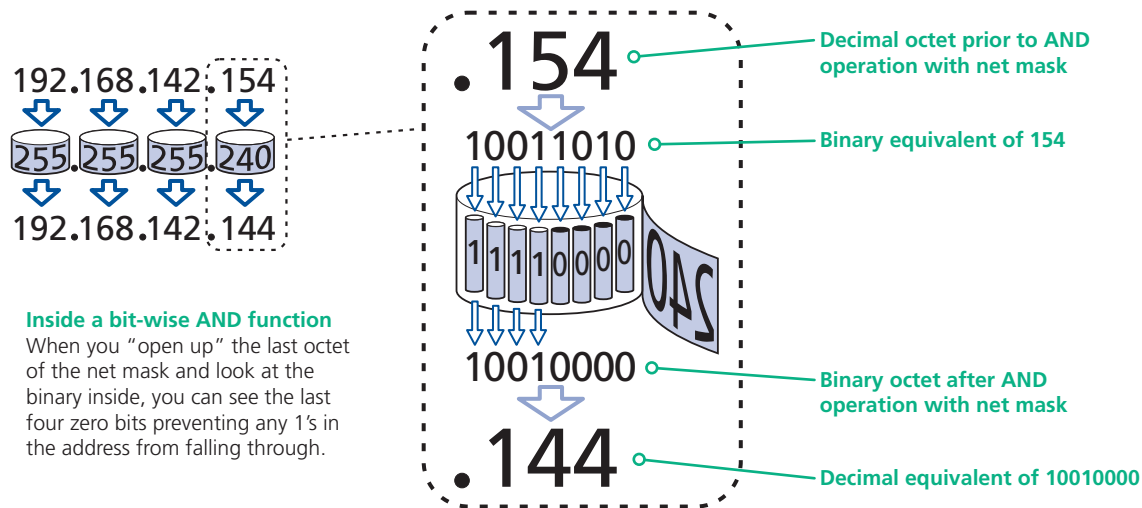

Inside a bit-wise AND function

When you “open up” the last octet of the net mask and look at the binary inside, you can see the last four zero bits preventing any 1’s in the address from falling through.

Thus, when 154 is *bit-wise ANDed* with 240, the result is 144. Likewise, any local address from 192.168.142.144 through to 192.168.142.159 would produce exactly the same result when combined with this net mask, hence they would all be local addresses. However, any difference in the upper three octets or the upper four bits of the last octet would slip through the mask and the address would be flagged as not being local.

INSTALLATION

CONFIGURATION

OPERATION

FURTHER INFORMATION

INDEX



Calculating the mask for IP access control

The IP access control function uses a standard IP address and a net mask notation to specify both single locations and ranges of addresses. In order to use this function correctly, you need to calculate the mask so that it accurately encompasses the required address(es).

Single locations

Some of the simplest addresses to allow or deny are single locations. In this case you enter the required IP address into the 'Network/Address' field and simply enter the 'Mask' as **255.255.255.255** (*255 used throughout the mask means that every bit of the address will be compared and so there can only be one unique address to match the one stated in the 'Network/Address' field*).

All locations

The other easy setting to make is ALL addresses, using the mask **0.0.0.0**. As standard, the IP access control section includes the entry: **+0.0.0.0/0.0.0.0**. The purpose of this entry is to *include* all IP addresses. It is possible to similarly *exclude* all addresses, however, take great care not to do this as you instantly render all network access void. There is a [recovery procedure](#) should this occur.

Address ranges

Although you can define ranges of addresses, due to the way that the mask operates, there are certain restrictions on the particular ranges that can be set. For any given address you can encompass neighbouring addresses in blocks of either 2, 4, 8, 16, 32, 64, 128, etc. and these must fall on particular boundaries. For instance, if you wanted to define the local address range:

192.168.142.67 to **192.168.142.93**

The closest single block to cover the range would be the 32 addresses from:

192.168.142.64 to **192.168.142.95**.

The mask needed to accomplish this would be: **255.255.255.224**

When you look at the mask in binary, the picture becomes a little clearer. The above mask has the form: **11111111.11111111.11111111.11100000**

Ignoring the initial three octets, the final six zeroes of the mask would ensure that the 32 addresses from .64 (01000000) to .95 (01011111) would all be treated in the same manner. See [Net masks - the binary explanation](#) for details.

When defining a mask, the important rule to remember is:

There must be no 'ones' to the right of a 'zero'.

For instance, (ignoring the first three octets) you could not use a mask that had **11100110** because this would affect intermittent addresses within a range in an impractical manner. The same rule applies across the octets. For example, if you have zeroes in the third octet, then all of the fourth octet must be zeroes.

The permissible mask values (for all octets) are as follows:

Mask octet	Binary	Number of addresses encompassed
255	11111111	1 address
254	11111110	2 addresses
252	11111100	4 addresses
248	11111000	8 addresses
240	11110000	16 addresses
224	11100000	32 addresses
192	11000000	64 addresses
128	10000000	128 addresses
0	00000000	256 addresses

If the access control range that you need to define is not possible using one address and one mask, then you could break it down into two or more entries. Each of these entries could then use smaller ranges (of differing sizes) that, when combined with the other entries, cover the range that you require.

For instance, to accurately encompass the range in the earlier example:

192.168.142.67 to **192.168.142.93**

You would need to define the following six address and mask combinations in the IP access control section:

Network/address entry	Mask entry	
192.168.142.67	255.255.255.255	defines 1 address (.67)
192.168.142.68	255.255.255.252	defines 4 addresses (.68 to .71)
192.168.142.72	255.255.255.248	defines 8 addresses (.72 to .79)
192.168.142.80	255.255.255.248	defines 8 addresses (.80 to .87)
192.168.142.88	255.255.255.252	defines 4 addresses (.88 to .92)
192.168.142.93	255.255.255.255	defines 1 address (.93)

Ports

If you accept the analogy of [IP addresses](#) being rather like telephone numbers, then think of ports as extension numbers. In a company of any size, you generally wouldn't expect the accounts department to share the same telephone with the technical department. Although their calls may all be related to the same company, they concern very different aspects of that company.

It is the same with IP network connections. Although you have only one network link into your server and only one IP address (phone number), you are probably performing many different tasks through that one link, often at the same time. Thus, when you browse the web your outgoing requests and the incoming information are all channelled through port 80. When you send an email, it travels through port 25 and when you transfer files you are, without knowing it, using port 20.

At the "border crossing" between the wider Internet and every local network attached to it, there is a router that is usually combined with a firewall. One of its main tasks is to direct incoming traffic to the correct place within its local network. A key piece of information to help it do this is the port number:

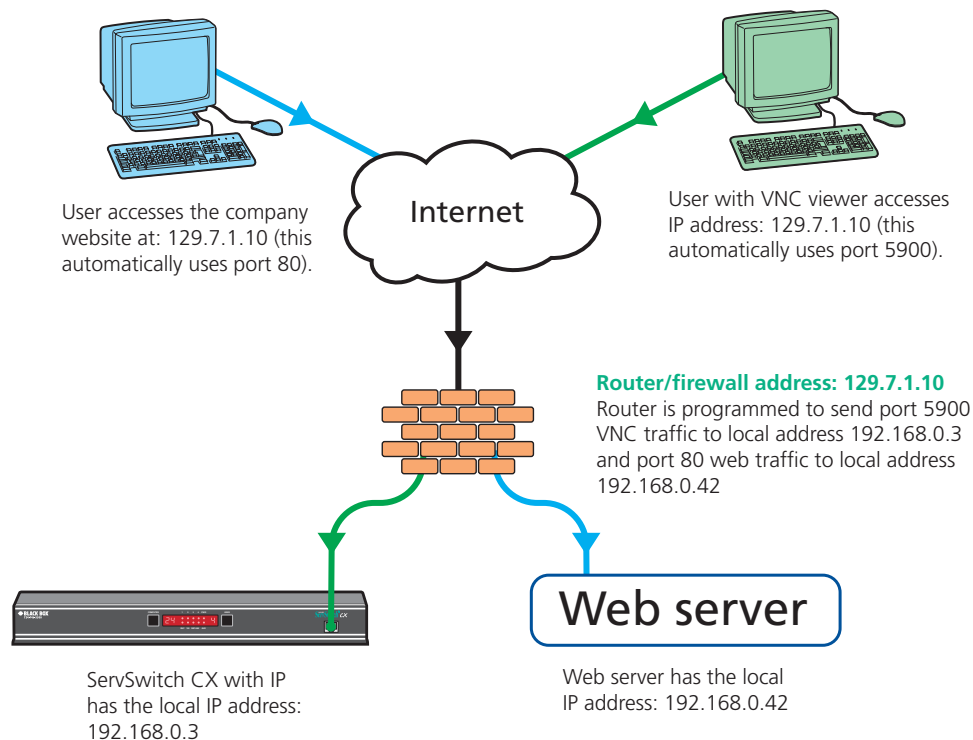

Security issues with ports

The settings of port numbers become important when the ServSwitch CX with IP is situated behind a network firewall. In order for a remote VNC viewer or web browser to make contact with your ServSwitch CX with IP, it is necessary for the firewall to allow communication through a particular numbered port to occur.

One specific function of firewalls is to restrict access to ports in order to prevent malicious attackers using them as a route into your network. Every new port that is opened offers a new possibility for hackers and so the number of accessible ports is purposefully kept to a minimum. In such cases, it may be advantageous to change one or both ServSwitch CX with IP ports to use the same number. The other alternative is to place the ServSwitch CX with IP unit outside the firewall and take full advantage of its secure operation features – see [Networking issues](#) for details.

IMPORTANT: The correct configuration of routers and firewalls requires advanced networking skills and intimate knowledge of the particular network. Black Box cannot provide specific advice on how to configure your network devices and strongly recommend that such tasks are carried out by a qualified professional.



INSTALLATION

CONFIGURATION

OPERATION

FURTHER INFORMATION

INDEX

Appendix 7 – Cable and connector specifications

RS232 serial mouse to PS/2 converter cable

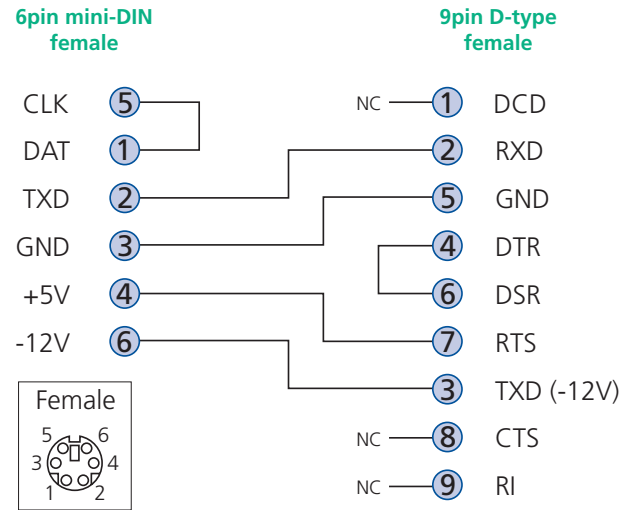

RS232 serial flash upgrade cable

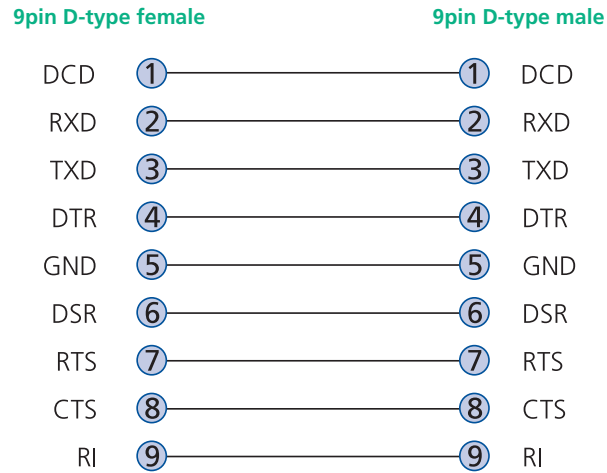

ServSwitch CX to power switch cable

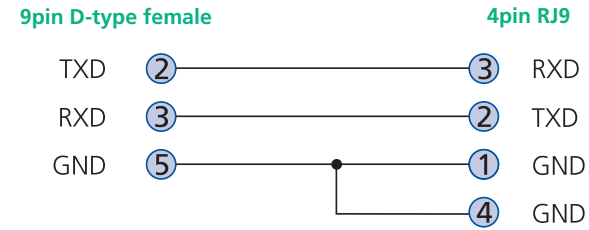

Power switch to power switch daisy chain cable

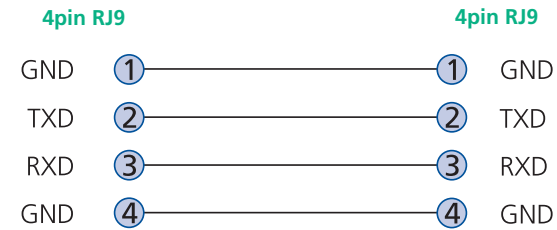

INSTALLATION

CONFIGURATION

OPERATION

FURTHER INFORMATION

INDEX

Multi-head synchronisation cable

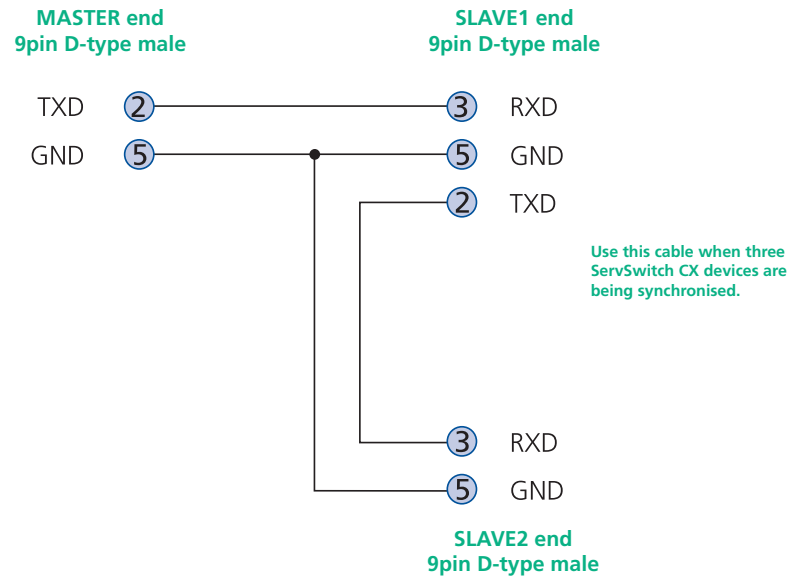
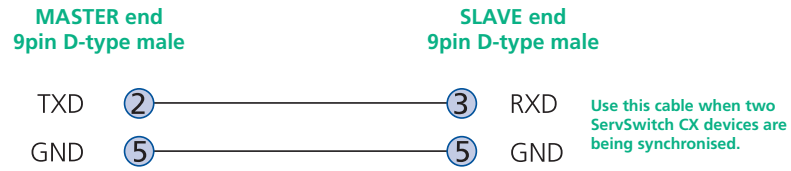

INSTALLATION

CONFIGURATION

OPERATION

FURTHER INFORMATION

INDEX



Appendix 8 – Hotkey sequence codes

These codes are used when defining hotkey switching sequences (macros) for host servers and allow you to include almost any of the special keys on the keyboard.

Permissible key presses

Main control keys (see 'Using abbreviations')

Backspace | Tab | Return | Enter | Ctrl | Alt | Win | Shift | LShift | RShift
LCtrl | RCtrl | LAlt | AltGr | RAlt | LWin | RWin | Menu | Escape | Space
CapsLock | NumLock | PrintScreen | Scrolllock

Math operand keys (see 'Using abbreviations')

Add (Plus) | Subtract (Minus) | Multiply

Central control keys (see 'Using abbreviations')

Insert | Delete | Home | End | PageUp | PageDown
Up | Down | Left | Right | Print | Pause

Keypad keys (see 'Using abbreviations')

KP_Insert | KP_Delete | KP_Home | KP_End | KP_PageUp
KP_PageDown | KP_Up | KP_Down | KP_Left | KP_Right | KP_Enter
KP_Add | KP_Subtract | KP_Divide | KP_Multiply
KP_0 to KP_9

Function keys

F1 | F2 | F3 | F4 | F5 | F6 | F7 | F8 | F9 | F10 | F11 | F12

ASCII characters

All characters can be entered using their ASCII codes, from 32 to 126 (i.e. A,B,C, ... 1,2,3 etc.) with the exception of the special characters '+', '-', '+-' and '*' which have special meanings, as explained below.

Codes with special meanings

- + means press down the key that follows
- means release the key that follows
- +– means press down and release the key that follows
- * means wait 250ms (note: if a number immediately follows the asterisk, then the delay will equal the number, in milliseconds)

Note: Hotkey sequences are not case sensitive.

Creating macro sequences

Hot key macro sequences can be up to 256 characters long. All keys are assumed to be released at the end of a line, however, you can also determine that a key is pressed and released within a sequence. Any of the following three examples will send a command that emulates and a press and release of the Scroll Lock key:

```
+SCROLL-SCROLL
+-SCROLL
+SCROLL-
```

Example:

```
+-SCROLL+-SCROLL+1+ENTER
```

Press and release scroll twice, press 1 then enter then release all keys (equivalent definition is +SCROLL-SCROLL+SCROLL-SCROLL+1+ENTER-1-ENTER)

Using abbreviations

To reduce the length of the key definitions, any unique abbreviation for a key can be used. For example: "scroll", "scr" and even "sc" all provide an identifiable match for "ScrollLock" whereas "en" could not be used because it might mean "Enter" or "End" ("ent" would be suitable for "Enter").

Note: Hotkey sequences and abbreviations are not case sensitive.

For information about where to enter these codes, please see the sections [Host configuration](#) or [Keyboard control](#).

Appendix 9 – Supported video modes

The following video modes are supported and can be automatically configured by the ServSwitch CX units. If a recognised video mode cannot be found, the ServSwitch CX will gradually change some of the key parameters to discover whether a video lock can be achieved. Support for VESA GTF (Generalized Timing Formula) is available and can be enabled via the [Advanced Unit Configuration](#) screen.

The half width video modes capture every other pixel. These are not generally recommended for normal use but may be used for emergency access to high resolution, high frequency system screens. Half width screens can be expanded to normal width using the scaling features of the viewer.

vesa 720 x 400 @ 85Hz	vesa 720 x 400 @ 70Hz*
vesa 640 x 480 @ 60Hz	sun 1152 x 900 @ 66Hz
vesa 640 x 480 @ 72Hz	sun 1152 x 900 @ 76Hz
vesa 640 x 480 @ 75Hz	sun 1280 x 1024 @ 67Hz
vesa 640 x 480 @ 85Hz	apple 640 x 480 @ 67Hz
vesa 800 x 600 @ 56Hz	apple 832 x 624 @ 75Hz
vesa 800 x 600 @ 60Hz	apple 1152 x 870 @ 75Hz
vesa 800 x 600 @ 72Hz	1900 x 1200 @ 60Hz**
vesa 800 x 600 @ 75Hz	
vesa 800 x 600 @ 85Hz	
vesa 1024 x 768 @ 60Hz	
vesa 1024 x 768 @ 70Hz	
vesa 1024 x 768 @ 75Hz	
vesa 1024 x 768 @ 85Hz	
vesa 1152 x 864 @ 75Hz	
vesa 1280 x 960 @ 60Hz	
vesa 1280 x 1024 @ 60Hz	
vesa 1280 x 1024 @ 75Hz	
vesa 1600 x 1200 @ 60Hz	
vesa 1600 x 1200 @ 65Hz half-width	
vesa 1600 x 1200 @ 70Hz half-width	
vesa 1600 x 1200 @ 75Hz half-width	
vesa 1600 x 1200 @ 85Hz half-width	

* Not actually a VESA mode but a common DOS/BIOS mode

** May also work on some systems when the operating temperature of the ServSwitch CX is controlled.



INSTALLATION

CONFIGURATION

OPERATION

FURTHER
INFORMATION

INDEX

Safety information

- For use in dry, oil free indoor environments only.
- Both the ServSwitch CX and its power supply generate heat when in operation and will become warm to the touch. Do not enclose them or place them locations where air cannot circulate to cool the equipment. Do not operate the equipment in ambient temperatures exceeding 40 degrees Centigrade. Do not place the products in contact with equipment whose surface temperature exceeds 40 degrees Centigrade.
- Warning - live parts contained within power adapter.
- No user serviceable parts within power adapter - do not dismantle.
- Plug the power adapter into a socket outlet close to the module that it is powering.
- Replace the power adapter with a manufacturer approved type only.
- Do not use the power adapter if the power adapter case becomes damaged, cracked or broken or if you suspect that it is not operating properly.
- If you use a power extension cord with the ServSwitch CX, make sure the total ampere rating of the devices plugged into the extension cord does not exceed the cord's ampere rating. Also, make sure that the total ampere rating of all the devices plugged into the wall outlet does not exceed the wall outlet's ampere rating.
- Do not attempt to service the ServSwitch CX yourself.

Safety considerations when using power switches with ServSwitch CX

- Follow the manufacturer's instructions when setting up and using power switching products.
- Always ensure that the total ampere rating of the devices plugged into the power switching product does not exceed the power switching product's ampere rating. Also, make sure that the total ampere rating of all the devices plugged into the wall outlet does not exceed the wall outlet's ampere rating.

General Public License (Linux)

The ServSwitch CX runs an embedded version of the Linux operating system, licensed under the GNU General Public License. To obtain the source code for the open-source components of the system visit:

<http://www.realvnc.com/products/WizardIP/gpl.html>



INSTALLATION

CONFIGURATION

OPERATION

FURTHER
INFORMATION

INDEX

End user licence agreement

PLEASE READ THIS AGREEMENT CAREFULLY. THIS AGREEMENT CONCERNS ENHANCED VNC VIEWER SOFTWARE (“the SOFTWARE”) FOR USE WITH THE ServSwitch CX PRODUCT (“the PRODUCT”). THE SOFTWARE IS PROVIDED TO ENABLE YOU TO OPERATE THE PRODUCT. BY USING ALL OR ANY PORTION OF THE SOFTWARE YOU ACCEPT ALL THE TERMS AND CONDITIONS OF THIS AGREEMENT. IF YOU DO NOT ACCEPT ALL THE TERMS AND CONDITIONS OF THIS AGREEMENT THEN DO NOT USE THE SOFTWARE. BY USING ANY UPDATED VERSION OF THE SOFTWARE WHICH MAY BE MADE AVAILABLE, YOU ACCEPT THAT THE TERMS OF THIS AGREEMENT APPLY TO SUCH UPDATED SOFTWARE.

1. Intellectual Property Rights

The Software and its structure and algorithms are protected by copyright and other intellectual property laws, and all intellectual property rights in them belong to RealVNC Limited (“RealVNC”), a United Kingdom Limited Company, or are licensed to it. You may not reproduce, publish, transmit, modify, create derivative works from, publicly display the Software or part thereof. Copying or storing or using the Software other than as permitted in Clause 2 is expressly prohibited unless you obtain prior written permission from RealVNC.

2. Permitted and Prohibited Uses

- 2.1 During the term of this Agreement and as long as you comply with the terms of this agreement, you may use the Software only with the Product for your personal use or for the internal use of your business. You may make as many copies of the Software as you require for your own internal business purposes only and for archival purposes. You are expressly prohibited from distributing the Software in any format, in whole or in part, for sale, or for commercial use or for any unlawful purpose.
- 2.2 You may not rent, lease or otherwise transfer the Software or allow it to be copied. Unless permitted by law, you may not reverse engineer, decompile or disassemble the Software.

3. Warranty

REALVNC DOES NOT WARRANT ANY RESULTS OBTAINED USING THE SOFTWARE. TO THE EXTENT PERMITTED BY LAW, REALVNC DISCLAIMS ALL OTHER WARRANTIES ON THE SOFTWARE, EITHER EXPRESS OR IMPLIED, INCLUDING BUT NOT LIMITED TO THE IMPLIED WARRANTIES OF MERCHANTABILITY, NON-INFRINGEMENT OF THIRD PARTY RIGHTS AND FITNESS FOR PARTICULAR PURPOSE.

4. Limitation on Liability

UNDER NO CIRCUMSTANCES SHALL REALVNC BE LIABLE FOR ANY CONSEQUENTIAL INDIRECT OR INCIDENTAL DAMAGES WHATSOEVER INCLUDING LOST PROFITS OR SAVINGS ARISING OUT OF THE USE OF THE SOFTWARE, THE SERVICE OR THE INFORMATION, RELIANCE ON THE DATA PRODUCED OR INABILITY TO USE THE SOFTWARE, THE SERVICE OR THE INFORMATION EVEN IF REALVNC HAS BEEN ADVISED OF THE POSSIBILITY OF SUCH DAMAGES. BECAUSE SOME STATES AND COUNTRIES DO NOT ALLOW THE EXCLUSION OR LIMITATION OF LIABILITY FOR CONSEQUENTIAL OR INCIDENTAL DAMAGES, THE ABOVE LIMITATION MAY NOT APPLY TO YOU. NOTHING IN THIS AGREEMENT LIMITS LIABILITY FOR DEATH OR PERSONAL INJURY ARISING FROM A PARTY’S NEGLIGENCE OR FROM FRAUDULENT MISREPRESENTATION ON THE PART OF A PARTY

5. Export Control

The United States and other countries control the export of Software and information. You are responsible for compliance with the laws of your local jurisdiction regarding the import, export or re-export of the Software, and agree to comply with such restrictions and not to export or re-export the Software where this is prohibited. By downloading the Software, you are agreeing that you are not a person or entity to which such export is prohibited.

6. Term and Termination

This licence shall continue in force unless and until it is terminated by RealVNC by e-mail notice to you, if it reasonably believes that you have breached a material term of this Agreement

In the case above, you must delete and destroy all copies of the Software in your possession and control and overwrite any electronic memory or storage locations containing the Software.

7. General Terms

- 7.1 The construction, validity and performance of this Agreement shall be governed in all respects by English law, and the Parties agree to submit to the exclusive jurisdiction of the English courts.
- 7.2 If any provision of this agreement is found to be invalid by any court having competent jurisdiction, the invalidity of such provision shall not affect the validity of the remaining provisions of this agreement, which shall remain in full force and effect.
- 7.3 No waiver of any term of this agreement shall be deemed a further or continuing waiver of such term or any other term.
- 7.4 This agreement constitutes the entire agreement between you and RealVNC.



INSTALLATION

CONFIGURATION

OPERATION

FURTHER INFORMATION

INDEX

Radio Frequency Energy

A Category 5 (or better) twisted pair cable must be used to connect the units in order to maintain compliance with radio frequency energy emission regulations and ensure a suitably high level of immunity to electromagnetic disturbances.

All other interface cables used with this equipment must be shielded in order to maintain compliance with radio frequency energy emission regulations and ensure a suitably high level of immunity to electromagnetic disturbances.

European EMC directive 89/336/EEC

This equipment has been tested and found to comply with the limits for a class A computing device in accordance with the specifications in the European standard EN55022. These limits are designed to provide reasonable protection against harmful interference. This equipment generates, uses and can radiate radio frequency energy and if not installed and used in accordance with the instructions may cause harmful interference to radio or television reception. However, there is no guarantee that harmful interference will not occur in a particular installation. If this equipment does cause interference to radio or television reception, which can be determined by turning the equipment on and off, the user is encouraged to correct the interference with one or more of the following measures: (a) Reorient or relocate the receiving antenna. (b) Increase the separation between the equipment and the receiver. (c) Connect the equipment to an outlet on a circuit different from that to which the receiver is connected. (d) Consult the supplier or an experienced radio/TV technician for help.

FCC Compliance Statement (United States)

This equipment generates, uses and can radiate radio frequency energy and if not installed and used properly, that is, in strict accordance with the manufacturer's instructions, may cause interference to radio communication. It has been tested and found to comply with the limits for a class A computing device in accordance with the specifications in Subpart J of part 15 of FCC rules, which are designed to provide reasonable protection against such interference when the equipment is operated in a commercial environment. Operation of this equipment in a residential area may cause interference, in which case the user at his own expense will be required to take whatever measures may be necessary to correct the interference. Changes or modifications not expressly approved by the manufacturer could void the user's authority to operate the equipment.

Canadian Department of Communications RFI statement

This equipment does not exceed the class A limits for radio noise emissions from digital apparatus set out in the radio interference regulations of the Canadian Department of Communications.

Le présent appareil numérique n'émet pas de bruits radioélectriques dépassant les limites applicables aux appareils numériques de la classe A prescrites dans le règlement sur le brouillage radioélectriques publié par le ministère des Communications du Canada.



INSTALLATION

CONFIGURATION

OPERATION

FURTHER
INFORMATION

INDEX

FCC requirements for telephone-line equipment

- 1 The Federal Communications Commission (FCC) has established rules which permit this device to be directly connected to the telephone network with standardized jacks. This equipment should not be used on party lines or coin lines.
- 2 If this device is malfunctioning, it may also be causing harm to the telephone network; this device should be disconnected until the source of the problem can be determined and until the repair has been made. If this is not done, the telephone company may temporarily disconnect service.
- 3 If you have problems with your telephone equipment after installing this device, disconnect this device from the line to see if it is causing the problem. If it is, contact your supplier or an authorized agent.
- 4 The telephone company may make changes in its technical operations and procedures. If any such changes affect the compatibility or use of this device, the telephone company is required to give adequate notice of the changes.
- 5 If the telephone company requests information on what equipment is connected to their lines, inform them of:
 - a The telephone number that this unit is connected to.
 - b The ringer equivalence number.
 - c The USOC jack required: RJ-11C.
 - d The FCC registration number.Items (b) and (d) can be found on the unit's FCC label. The ringer equivalence number (REN) is used to determine how many devices can be connected to your telephone line. In most areas, the sum of the RENs of all devices on any one line should not exceed five (5.0). If too many devices are attached, they may not ring properly.
- 6 In the event of an equipment malfunction, all repairs should be performed by your supplier or an authorized agent. It is the responsibility of users requiring service to report the need for service to the supplier or to an authorized agent.

Certification notice for equipment used in Canada

The Canadian Department of Communications label identifies certified equipment. This certification means that the equipment meets certain telecommunications-network protective, operation, and safety requirements.

The Department does not guarantee the equipment will operate to the user's satisfaction.

Before installing this equipment, users should ensure that it is permissible to be connected to the facilities of the local telecommunications company.

The equipment must also be installed using an acceptable method of connection. In some cases, the company's inside wiring associated with a single-line individual service may be extended by means of a certified connector assembly (extension cord). The customer should be aware that compliance with the above conditions may not prevent degradation of service in some situations.

Repairs to certified equipment should be made by an authorized Canadian maintenance facility—in this case, your supplier. Any repairs or alterations made by the user to this equipment, or equipment malfunctions, may give the telecommunications company cause to request the user to disconnect the equipment.

Users should ensure for their own protection that the electrical ground connections of the power utility, telephone lines, and internal metallic water pipe system, if present, are connected together. This precaution may be particularly important in rural areas.

CAUTION:

Users should not attempt to make such connections themselves, but should contact the appropriate electric inspection authority, or electrician, as appropriate.

The LOAD NUMBER (LN) assigned to each terminal device denotes the percentage of the total load to be connected to a telephone loop which is used by the device, to prevent overloading. The termination on a loop may consist of any combination of devices, subject only to the requirement that the total of the load numbers of all the devices does not exceed 100.



INSTALLATION

CONFIGURATION

OPERATION

FURTHER INFORMATION

INDEX

Normas Oficiales Mexicanas (NOM) electrical safety statement



Instrucciones de seguridad

- 1 Todas las instrucciones de seguridad y operación deberán ser leídas antes de que el aparato eléctrico sea operado.
- 2 Las instrucciones de seguridad y operación deberán ser guardadas para referencia futura.
- 3 Todas las advertencias en el aparato eléctrico y en sus instrucciones de operación deben ser respetadas.
- 4 Todas las instrucciones de operación y uso deben ser seguidas.
- 5 El aparato eléctrico no deberá ser usado cerca del agua—por ejemplo, cerca de la tina de baño, lavabo, sótano mojado o cerca de una alberca, etc.
- 6 El aparato eléctrico debe ser usado únicamente con carritos o pedestales que sean recomendados por el fabricante.
- 7 El aparato eléctrico debe ser montado a la pared o al techo sólo como sea recomendado por el fabricante.
- 8 Servicio—El usuario no debe intentar dar servicio al equipo eléctrico más allá a lo descrito en las instrucciones de operación. Todo otro servicio deberá ser referido a personal de servicio calificado.
- 9 El aparato eléctrico debe ser situado de tal manera que su posición no interfiera su uso. La colocación del aparato eléctrico sobre una cama, sofá, alfombra o superficie similar puede bloquea la ventilación, no se debe colocar en libreros o gabinetes que impidan el flujo de aire por los orificios de ventilación.
- 10 El equipo eléctrico deber ser situado fuera del alcance de fuentes de calor como radiadores, registros de calor, estufas u otros aparatos (incluyendo amplificadores) que producen calor.
- 11 El aparato eléctrico deberá ser conectado a una fuente de poder sólo del tipo descrito en el instructivo de operación, o como se indique en el aparato.
- 12 Precaución debe ser tomada de tal manera que la tierra física y la polarización del equipo no sea eliminada.
- 13 Los cables de la fuente de poder deben ser guiados de tal manera que no sean pisados ni pellizcados por objetos colocados sobre o contra ellos, poniendo particular atención a los contactos y receptáculos donde salen del aparato.
- 14 El equipo eléctrico debe ser limpiado únicamente de acuerdo a las recomendaciones del fabricante.
- 15 En caso de existir, una antena externa deberá ser localizada lejos de las líneas de energía.
- 16 El cable de corriente deberá ser desconectado del cuando el equipo no sea usado por un largo periodo de tiempo.
- 17 Cuidado debe ser tomado de tal manera que objetos líquidos no sean derramados sobre la cubierta u orificios de ventilación.
- 18 Servicio por personal calificado deberá ser provisto cuando:
 - A: El cable de poder o el contacto ha sido dañado; u
 - B: Objetos han caído o líquido ha sido derramado dentro del aparato; o
 - C: El aparato ha sido expuesto a la lluvia; o
 - D: El aparato parece no operar normalmente o muestra un cambio en su desempeño; o
 - E: El aparato ha sido tirado o su cubierta ha sido dañada.

INSTALLATION

CONFIGURATION

OPERATION

FURTHER INFORMATION

INDEX



© 2007 Black Box Corporation
All trademarks are acknowledged.

Black Box Corporation,
1000 Park Drive,
Lawrence,
PA 15055-1018,
United States of America
Tel: +1-724-746-5500
Fax: +1-724-746-0746

INSTALLATION

CONFIGURATION

OPERATION

FURTHER
INFORMATION

INDEX

Documentation by:  **CORPORATE
TEXT &
DESIGN** www.ctxd.com

Index



A

Access
 local and remote users 49
 via dial up link 64
Access control
 configuration 85
 mask calculation 98
Access mode
 shared & private 60
Account
 creation for users 80
Address
 explanation 96
Addressing
 cascaded computers 18
 DNS 41
 network issues 40
 power switch boxes 15
ADMIN
 forgotten password 34
 password 24
Admin password
 initial setup 36
 local setting 75
Advanced options 74
Advanced unit configuration
 82
Artifacts
 on screen 58
Autoscanning 32
Auto calibrate 60
Auto select 90,95

B

Baud rate 74
 local setting 77
 remote setting 86
Binary
 net masks 97
Brackets
 fitting 7
Browser
 connection 57
 viewer options 95
C
Cable lengths
 to computers 12
 to remote users 10
Cable specifications 100
Calibrate
 mouse 60
 screen 60
Calibrate all
 video settings 63
Cascade
 groups 17
Cascaded computers
 selecting 52
 selection 52
Cascade connections
 addressing 18
 how they work 17
 introduction 16
 testing 20
 tips for success 19
Clear IP access control 78
 local setting 76
Client IP
 local setting 77

Colour level 90
COM1
 baud rate 86
 connection 13
COM2
 baud rate 86
Compensation
 for computer links 27
 for remote user links 29
Computer
 name editing 26
 ports 5
 registering 26
 selecting 49
Computer system
 connection 12
Configuration 22
 initial IP 37
 menus 23,67
 overall steps 22
 pages 79
 saving and restoring 33
Configure IP port 75
Confirmation box 52
Connections 8
 computer system 12
 global user 11
 host computer 9
 ISDN 13
 keyboard 9
 local user 9
 modem 13
 multiple video head 21
 network port 11
 power control 15
 power supply 14
 remote user 10
Server Access Module 12

Connector specifications 100
Controls
 viewer options 61
Control menus
 for remote connection 58
Control strings
 power switching 43
CX R extender 10

D

Daisy chain cable 100
Date
 local setting 75
DDC
 options 74
DHCP
 discovering allocations 41
 during initial setup 36
 local setting 76
 remote setting 84
Dial up
 connection 64
DNS addressing 41

E

Encryption
 key 36
 settings 38
 viewer 65
End user licence 105
Extender
 remote user 10

F

Firewall 40
Firmware
 current version 81
 upgrade 45
Force encryption 75
Format
 power control port 74
Front panel
 controls 48
 controls and indicators 48
Full screen mode
 escape from (F8) 58
Functions 68,74,75

G

Gateway
 local setting 76
 remote setting 84
Global preferences 70,74
Global user
 access 55
 connection 11

H

Hextile 90,95
Hosts
 changing between 58,59
 configuration 87
Host configuration 87
Host selection 59
Host server
 connecting 9
 connection 12
 power switching setup 43

INSTALLATION

CONFIGURATION

OPERATION

FURTHER
INFORMATION

INDEX

Hotkeys
 changing 24
 selecting computers 50
 Hotkey sequences 88
 codes and macros 102
 Hot plugging 35
 HTTP port
 initial setup 36
 local setting 76
 remote setting 84
 when altered 40

I

Identities
 VNC Viewer 93
 Indicators 5,48
 Initialise button 86
 Initialize port
 local setting 77
 Initial configuration 22
 Init string
 local setting 77
 IntelliMouse 35
 IP access control 84,85
 calculating mask 98
 clearing 78
 IP address
 explanation 96
 local setting 76
 remote setting 84
 IP gateway 84
 IP network mask 84
 IP network port 5
 connecting 11
 IP port
 connection 11
 initial configuration 36
 IP port configuration
 configuration via viewer 37
 ISDN
 connecting 13
 dial up link 64

K

Keyboard codes
 sending 62
 Keyboard layout
 local setting 75
 remote setting 81
 KVMADMIN utility 44

L

Local connection 49
 Local network
 connection 39
 Local user
 connection 9
 port 5
 Logging 89
 Logging in and out
 section 52
 Log on 56

M

MAC address 76,83,84
 Mask
 explanation 96
 for IP access control 98
 Menu bar
 viewer window 58
 Menu key
 changing 91
 Modem
 connecting 13
 dial up link 64
 port 5
 Modem configuration 77
 Mounting 7
 Mouse
 calibration 60
 control 61
 pointers 59
 restoration 35
 resync 60,61
 Multiple video head
 connections 21

N

Networking issues 39
 Network configuration 76,84
 Network port
 connecting 11
 connection 11
 Net mask 76
 explanation 96

O

Operation 48

P

Parts
 supplied and extra 6
 Password
 admin 24
 admin - setting 75
 forgotten 34
 initial setup 36
 remote logon 56
 setting for users 80
 Port number
 entering 64
 Power control
 connection 15
 options 74
 Power control port 5
 connecting 15
 Power strings
 for switching 43
 Power supply
 connecting 14
 part number 6
 Power switching
 addressing 15
 configuration 43
 connection 15
 control sequences 43
 on & off select 60
 user permissions 80
 via viewer 60

PPP client IP address 86
 PPP server IP address 86
 Preferred encoding 90
 Private
 access mode 60

R

Raw 90,95
 Refresh screen 61
 Reminder banner 53
 Remote configuration
 advanced unit configuration
 82
 host configuration 87
 logging and status 89
 network configuration 84
 serial port configuration 86
 setting IP access control 85
 unit configuration 81
 user accounts 80
 Remote user
 cable lengths 10
 connection 10
 ports 5
 Reset configuration 77
 Restore Defaults
 local setting 77
 Resync mouse 61
 RJ9 connector 15
 Router 40
 Routing status 53

S

Safety information 104
 SAM
 connection 12
 Scaling
 VNC Viewer 92
 Screen
 best resolution 58
 calibration 60
 navigation 58
 refresh 61

Screensaver
 local setting 75
 Security
 enabling 24
 ensuring 42
 general steps 24
 Selecting
 cascaded computers 52
 computers 49
 with front panel 49
 with hotkeys 50
 with mouse buttons 51
 with on-screen menu 51
 Serial port
 modem connection 13
 Serial port configuration 86
 Server
 configuration 87
 Server Access Module
 connection 12
 Server IP
 local setting 77
 Setup options 68,72
 Shared
 access mode 60
 Single mouse mode 59,61
 Skew adjustment 30
 Slow connections
 optimising for 58
 Supplied items 6
 Syslog 89

T

Testing
 links to cascaded computers
 20
 Threshold
 adjustment 63
 Time
 local setting 75
 Time & date configuration 83
 Troubleshooting 66



U

Unit Configuration 75,81

Unit name

local setting 75

remote setting 81

Upgrade

firmware 45

Username

remote logon 56

User accounts 80

User list

editing 25

User preferences 72

Use DHCP

local setting 76

V

Video compensation 27

Video modes 103

Video settings 62

Viewer window 58

VNC port

initial setup 36

local setting 76

remote setting 84

when altered 40

VNC viewer

connection 56

connection options 90

download 56

window options 94

W

Warranty 104

Web browser

connection 57

viewer options 95

Z

ZRLE 90,95



INSTALLATION

CONFIGURATION

OPERATION

FURTHER
INFORMATION

INDEX

BlackBox subsidiary contact details



Country	Web Site/Email	Phone	Fax
United States	www.blackbox.com	724-746-5500	724-746-0746
Austria	www.black-box.at support@black-box.at	+43 1 256 98 56	+43 1 256 98 56
Belgium	www.blackbox.be support.nederlands@blackbox.be support.french@blackbox.be support.english@blackbox.be	+32 2 725 85 50	+32 2 725 92 12
Denmark	www.blackbox.dk support@blackbox.dk	+45 56 63 30 10	+45 56 65 08 05
Finland	www.blackbox.fi tuki@blackbox.fi	+35 201 888 800	+35 201 888 808
France	www.blackbox.fr tech@blackbox.fr	+33 1 45 606 717	+33 1 45 606 747
Germany	www.black-box.de techsupp@black-box.de	+49 811 5541 110	+49 811 5541 499
Italy	www.blackbox.it supporto.tecnico@blackbox.it	+39 02 27 404 700	+39 02 27 400 219
Netherlands	www.blackbox.nl techsupport@blackbox.nl	+31 30 241 7799	+31 30 241 4746
Norway	www.blackboxnorge.no support@blackboxnorge.no	+47 55 300 710	+47 55 300 701
Spain	www.blackbox.es tecnico@blackbox.es	+34 9162590732	+34 916239784
Sweden	www.blackboxab.se support@blackboxab.se	+46 8 44 55 890	+46 08 38 04 30
Switzerland	www.black-box.ch support@black-box.ch	+41 55 451 70 71	+41 55 451 70 75
UK	www.blackbox.co.uk techhelp@blackbox.co.uk	+44 118 965 6000	+44 118 965 6001
Ireland	www.blackbox.co.uk techhelp@blackbox.co.uk	+353 1 662 2466	+353 1 662 2477

INSTALLATION

CONFIGURATION

OPERATION

FURTHER
INFORMATION

INDEX

Free Manuals Download Website

<http://myh66.com>

<http://usermanuals.us>

<http://www.somanuals.com>

<http://www.4manuals.cc>

<http://www.manual-lib.com>

<http://www.404manual.com>

<http://www.luxmanual.com>

<http://aubethermostatmanual.com>

Golf course search by state

<http://golfingnear.com>

Email search by domain

<http://emailbydomain.com>

Auto manuals search

<http://auto.somanuals.com>

TV manuals search

<http://tv.somanuals.com>