

October 2002
LB1350A
LB1351A

Unmanaged (LB1350A) and Managed (LB1351A) MultiLink Media Converter

User and Installation Guide



**CUSTOMER
SUPPORT
INFORMATION**

Order **toll-free** in the U.S. 24 hours, 7 A.M. Monday to midnight Friday: **877-877-BBOX**
FREE technical support, 24 hours a day, 7 days a week: Call **724-746-5500**
or fax **724-746-0746**
Mail order: **Black Box Corporation**, 1000 Park Drive, Lawrence, PA 15055-1018
Web site: **www.blackbox.com** • E-mail: **info@blackbox.com**

**FEDERAL COMMUNICATIONS COMMISSION
AND
CANADIAN DEPARTMENT OF COMMUNICATIONS
RADIO FREQUENCY INTERFERENCE STATEMENTS**

This equipment generates, uses, and can radiate radio frequency energy and if not installed and used properly, that is, in strict accordance with the manufacturer's instructions, may cause interference to radio communication. It has been tested and found to comply with the limits for a Class A computing device in accordance with the specifications in Subpart B of Part 15 of FCC rules, which are designed to provide reasonable protection against such interference when the equipment is operated in a commercial environment. Operation of this equipment in a residential area is likely to cause interference, in which case the user at his own expense will be required to take whatever measures may be necessary to correct the interference.

Changes or modifications not expressly approved by the party responsible for compliance could void the user's authority to operate the equipment.

This digital apparatus does not exceed the Class A limits for radio noise emission from digital apparatus set out in the Radio Interference Regulation of the Canadian Department of Communications.

Le présent appareil numérique n'émet pas de bruits radioélectriques dépassant les limites applicables aux appareils numériques de la classe A prescrites dans le Règlement sur le brouillage radioélectrique publié par le ministère des Communications du Canada.

Normas Oficiales Mexicanas (NOM)

Electrical Safety Statement

INSTRUCCIONES DE SEGURIDAD

1. Todas las instrucciones de seguridad y operación deberán ser leídas antes de que el aparato eléctrico sea operado.
2. Las instrucciones de seguridad y operación deberán ser guardadas para referencia futura.
3. Todas las advertencias en el aparato eléctrico y en sus instrucciones de operación deben ser respetadas.
4. Todas las instrucciones de operación y uso deben ser seguidas.
5. El aparato eléctrico no deberá ser usado cerca del agua—por ejemplo, cerca de la tina de baño, lavabo, sótano mojado o cerca de una alberca, etc.
6. El aparato eléctrico debe ser usado únicamente con carritos o pedestales que sean recomendados por el fabricante.
7. El aparato eléctrico debe ser montado a la pared o al techo sólo como sea recomendado por el fabricante.
8. Servicio—El usuario no debe intentar dar servicio al equipo eléctrico más allá a lo descrito en las instrucciones de operación. Todo otro servicio deberá ser referido a personal de servicio calificado.
9. El aparato eléctrico debe ser situado de tal manera que su posición no interfiera su uso. La colocación del aparato eléctrico sobre una cama, sofá, alfombra o superficie similar puede bloquea la ventilación, no se debe colocar en libreros o gabinetes que impidan el flujo de aire por los orificios de ventilación.
10. El equipo eléctrico deber ser situado fuera del alcance de fuentes de calor como radiadores, registros de calor, estufas u otros aparatos (incluyendo amplificadores) que producen calor.
11. El aparato eléctrico deberá ser conectado a una fuente de poder sólo del tipo descrito en el instructivo de operación, o como se indique en el aparato.
12. Precaución debe ser tomada de tal manera que la tierra física y la polarización del equipo no sea eliminada.
13. Los cables de la fuente de poder deben ser guiados de tal manera que no sean pisados ni pellizcados por objetos colocados sobre o contra ellos, poniendo particular atención a los contactos y receptáculos donde salen del aparato.
14. El equipo eléctrico debe ser limpiado únicamente de acuerdo a las recomendaciones del fabricante.
15. En caso de existir, una antena externa deberá ser localizada lejos de las líneas de energía.
16. El cable de corriente deberá ser desconectado del cuando el equipo no sea usado por un largo periodo de tiempo.
17. Cuidado debe ser tomado de tal manera que objetos líquidos no sean derramados sobre la cubierta u orificios de ventilación.
18. Servicio por personal calificado deberá ser provisto cuando:
 - A: El cable de poder o el contacto ha sido dañado; u
 - B: Objetos han caído o líquido ha sido derramado dentro del aparato; o
 - C: El aparato ha sido expuesto a la lluvia; o
 - D: El aparato parece no operar normalmente o muestra un cambio en su desempeño; o
 - E: El aparato ha sido tirado o su cubierta ha sido dañada

Table of contents

1.	Overview	page 5
2.	Planning the network with Black Box® LB1350A/LB1351A	page 5
3.	Content of the shipping container	page 7
4.	Product general description	page 8
5.	Preferred Port	page 9
6.	Far-End-Fault (FEF)	page 10
7.	Parts identification	page 11
8.	Installation	page 12
9.	Power connection	page 12
10.	F/O cabling connection	page 13
11.	Twisted Pair cable connection	page 13
12.	Configuration switches	page 14
13.	Management Black Box® LB1351A	page 14
14.	Advanced Features	page 15
15.	Troubleshooting	page 16
16.	Specifications	page 18
Appendix-A: Managing the Black Box® LB1351A		page 19-37
Back Cover page		page 40

**Thank you for purchasing this Black Box®
LB1350A/LB1351A quality converter. We hope
that this guide will help you to obtain the best
results from the device while minimizing
installation time.**

*If you still need help installing or troubleshooting the Black Box®
LB1350A/LB1351A converter after reading the detailed information in this
guide, please call Black Box Technical Support at 724-746-5500*

**Note: unless where indicated otherwise, in this guide, Black Box®LB1350A/LB1351A
applies also to Black Box®LB1350A/LB1351A/SC, Black Box®LB1350A/LB1351A/ST,
BlackBox®LB1350A/LB1351A/SM15 and Black Box®LB1350A/LB1351A/SM40**

TRADEMARKS

*HP and OpenView are registered trademarks of Hewlett-Packard.
UL is a registered trademark of Underwriters Laboratories Incorporated. Any other trademarks mentioned
in this manual are acknowledged to be the property of the trademark owners.*

1 - OVERVIEW

A media-converter may be defined as a device connecting two active network components point-to-point over a media that is different from the ports of at least one of these devices.

An ideal media-converter should be a transparent element in the network, and its ports may be considered as integral parts of the devices interconnected by it. The IEEE802.3u standard defines network span in terms of distances and bit times.

Conventional 100Base-TX/100Base-FX media-converters are based on repeater technology, and they form a part of the collision domain created by the interconnected devices. Therefore, the delay they introduce in the network severely affects the allowed distances. Furthermore, if two class II repeaters (i.e., 2 hubs) are already present in the same collision domain, then the use of a conventional converter is not allowed as the repeater count may - in such case - exceed the limits. In all other cases, meticulous PDV (Path Delay Value) must be performed prior to establishing the possible distances for both the fiber optic (F/O) and copper segments.

The Black Box®LB1350A/LB1351A family implements a non-repeater, full re-timing approach. It creates a Buffered Media Domain (BMD) over the F/O link, thereby eliminating all the above mentioned limitations.

The BMD created by two Black Box®LB1350A/LB1351A devices always operates at maximum performance - 100Mbps/Full Duplex - while interconnected devices may operate at different rates and modes. This provides full flexibility when planning a network.

The Black Box®LB1350A/LB1351A provides 4 (3) TP ports sharing conversion to one FO port, with the TP ports buffered and VLAN protected between themselves, making the device an ideal and most economical solution for both FTTH (Fiber-To-The-Home) and FTTD (Fiber-To-The-Desk) applications.

2- Planning your Network with Black Box®LB1350A/LB1351A

Below you will find a FTTD configuration. The drawing demonstrates the versatility of the device in terms of interconnecting – trouble-free – other devices.

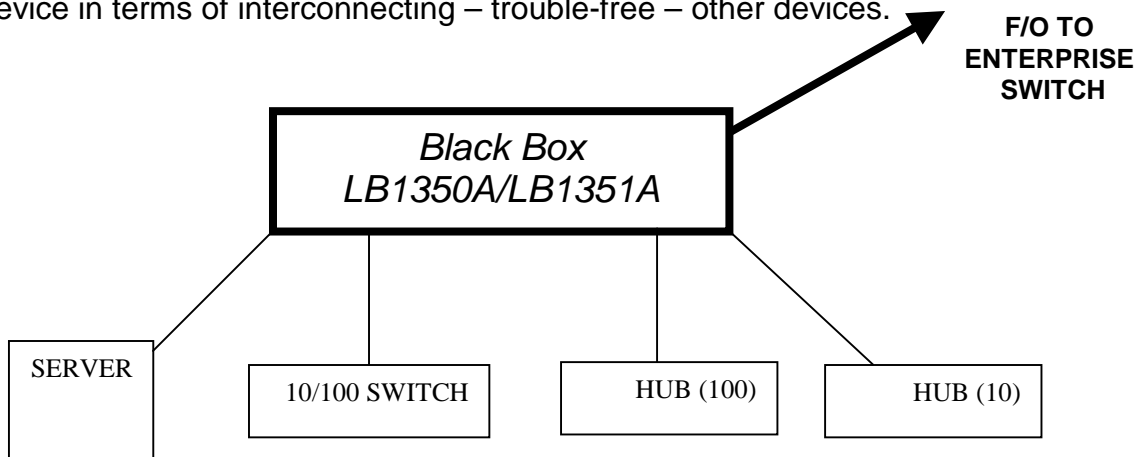

In a typical Fiber –to –the - Home (FTTH) application

A Black Box®LB1350A/LB1351A will be deployed in a home or building and connected by fiber to access switch.

It may be deployed on a floor of an apartment (office) building and 4(3) apartments (offices) may be connected to it's copper ports without the need to verify the type of the network (device) within the apartment (office). Also a HUB or Switch can be connected to any TP port according to the required network configuration.

Black Box®LB1350A/LB1351A

Note: RJ-45 port No. 4 is a preferred port with enhanced functionality – see section 5. As each of the Black Box®LB1350A/LB1351A RJ-45 port 4(3) supports: full auto-negotiation, auto-polarity and auto-cross, you can simply connect any device to any port by using a standard straight or crossed cable. In particular, you can connect 10Mbps or 100Mbps devices as well as HDX/FDX devices.

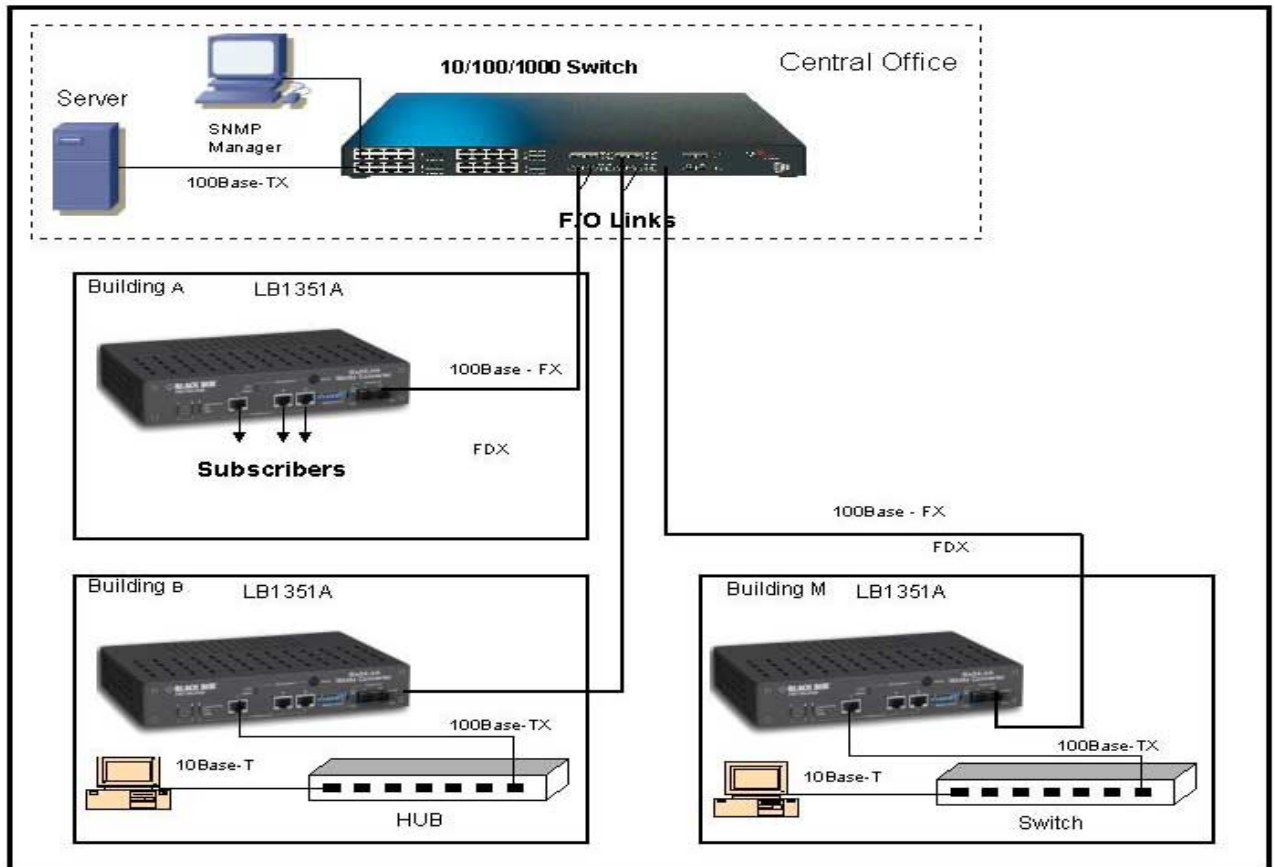

Black Box®LB1350A/LB1351A

The Black Box®LB1350A/LB1351A will not only convert signals from copper to fiber but also from 10 to 100Mbps and HDX to FDX, thus ensuring maximal distance over the optical link.

All you need to take care of is the Speed and Duplex mode balance across the network: if one of the local devices is HDX only capable you should force the corresponding remote device to HDX as well to avoid buffer overflow. Same applies to devices with 10Mbps capability only.

Disregarding the interconnected device F/O link will always operate at 100Mbps and FDX (you may force it to HDX as well, if needed)

3 - CONTENTS OF THE SHIPPING CONTAINER

The contents of the Black Box®LB1350A/LB1351A shipping container are as follows:

- One converter Black Box®LB1350A or Black Box® LB1351A
- One AC power cord (excluding shipment to certain countries)
- Four plastic “feet”
- Management serial cable for Black Box® (LB1351A only)



4. PRODUCT GENERAL DESCRIPTION

The Black Box®LB1350A/LB1351A may be offered in the following pre-configured versions :

LB1350A-SC	Multiple 100Base-TX to single 100Base-FX Local Traffic Aggregator with four RJ-45 (switched, VLAN) ports and duplex SC connectors, Multi-mode - 2km,internal PS
LB1350A-ST	Multiple 100Base-TX to single 100Base-FX Local Traffic Aggregator with four RJ-45 (switched, VLAN) ports and duplex ST connectors, Multi-mode - 2km, internal PS
LB1350A-SM15	Multiple 100Base-TX to single 100Base-FX Local Traffic Aggregator with four RJ-45 (switched, VLAN) ports and duplex SC connectors, SINGLE-mode - 15km,internal PS
LB1350A-SM40	Multiple 100Base-TX to single 100Base-FX Local Traffic Aggregator with four RJ-45 (switched, VLAN) ports and duplex SC connectors, SINGLE-mode - 40km,internal PS
LB1351A-SC	Multiple 100Base-TX to single 100Base-FX Local Traffic Aggregator with 3 RJ-45 (switched, VLAN) ports and duplex SC connectors, Multi-mode - 2km, internal PS, SNMP Managed
LB1351A-ST	Multiple 100Base-TX to single 100Base-FX Local Traffic Aggregator with 3 RJ-45 (switched, VLAN) ports and duplex SC connectors, Multi -mode - 2km, internal PS, SNMP Managed
LB1351A-SM15	Multiple 100Base-TX to single 100Base-FX Local Traffic Aggregator with 3 RJ-45 (switched, VLAN) ports and duplex SC connectors, SINGLE-mode - 15km, internal PS, SNMP Managed
LB1351A-SM40	Multiple 100Base-TX to single 100Base-FX Local Traffic Aggregator with 3 RJ-45 (switched, VLAN) ports and duplex SC connectors, SINGLE-mode - 40km, internal PS, SNMP Managed

Feature Summary

- 10Base-T, 100Base-TX and 100Base-FX modes of operation
- Supports FEF feature (Far-End-Fault) to test Link integrity.
- Comprehensive LED support :Indicators for Link, Activity (Tx, Rx) , FDX, 100M, Power status and Link Test
- Hardware based 10/100, Full/Half, Flow control ,Auto-Negotiation, Auto-cross.
- Wire speed reception and transmission
- Supports 1K Mac addresses
- Automatic address learning and address aging (aging period is 300s)
- **Frame length range : 64 ÷ 1536 bytes**
Vlan tag frames are thus supported and can pass thru the converter
- Desktop , shelf ,wall mount installation, or directly in a half 19" rack.
- Port based VLAN
- **VLAN Tagging support and Per port based priority, 802.1p and TOS port based priority schemes (Black Box® LB1351A) only**
- **Extensive in-band SNMP management (Black Box® LB1351A)**

General Description

The Black Box®LB1350A/LB1351A is a shared and buffered media converter. It converts 100Base-FX signals received on its F/O interface in 10/100Base-TX signals and distributes them to 4(3) copper (shielded RJ-45) ports. Each of these ports is buffered; furthermore, factory set VLAN forms groups each including one copper port and the common F/O port, providing the users with basic security (no connection between the users). This architecture allows 4(3) users to share one F/O link with dramatic (up to 75%) savings.

The copper ports are auto-negotiating and will automatically adapt themselves to the capacity of the users for highest performance (will negotiate 10/100 and FDX/HDX). Nevertheless, in some cases it may be necessary to force certain operating modes.

For this purpose, all copper ports may be (individually) forced to 10Mbps/FDX operation and port #4(3) (the preferred port) may be forced to any desired combination (altogether 4 combinations) of HDX/FDX and 10/100.

Full front panel diagnostics provide information on the operation mode of every port.

The F/O port is configured by default to FDX but if desired may be set to HDX as well. However it is essential to remember that when in HDX, the F/O link maximal distance drops to 412m or less.

The Black Box®LB1350A/LB1351A is available with a variety of multi-mode and single-mode interfaces with distance ranging from 2km to 40km.

The Black Box®LB1350A/LB1351A is packaged in a rugged “half rack” enclosure allowing elegant and safe deployment in a variety of environments: desktop, 2 units on a 19” rack-shelf or within a standard “half 19” rack (optional brackets required).

Its internal, high-power auto-range switching power supply ensures easy, safe and error-free deployment and enhanced MTBF.

The managed version – Black Box® LB1351A – provides full in-band SNMP manageability (both monitoring and control) - see Appendix A (pages 19-37)

Port priority schemes are also a part of the management.

5. PREFERRED PORT

TP port #4 of the Black Box®LB1350A (or #3 of the Black Box® LB1351A) provides additional functionalities comparing to the other copper ports.

Full operation mode selection

While all the TP ports provide auto-negotiation and forced 10Mbps/FDX operation, this preferred port may be set via the front panel DIP switches to force all possible operation mode options: 10/HDX, 10/FDX, 100HDX and 100FDX. See section 12 for detailed Dip switches setting (page 14).

Recommendation: use the preferred port for connection of the most critical or heavy traffic user of the four, even if you do not implement the special features described above

6. Far End Fault Signaling (FEF) feature

When the device detects F/O Link Loss (receive side) it automatically sends a Far End Fault signal to the remote device. If such device is another Black Box®LB1350A/LB1351A or any device which supports such feature – then it will indicate F/O Link Loss as well. By activating TEST mode (by TEST switch - #8 MODE SETUP Dip switches on the front panel) **this function may be disabled** .The picture below depicts this functionality.

Black Box®LB1350A/LB1351A

If there is a fault in the outgoing path and the remote device is FEF compliant (see below) then the F/O LINK LED will go OFF on both the local and remote devices. In this way we avoid the possibility of having a FX Link ON indication at one end while, in reality one of the data path is disrupted.

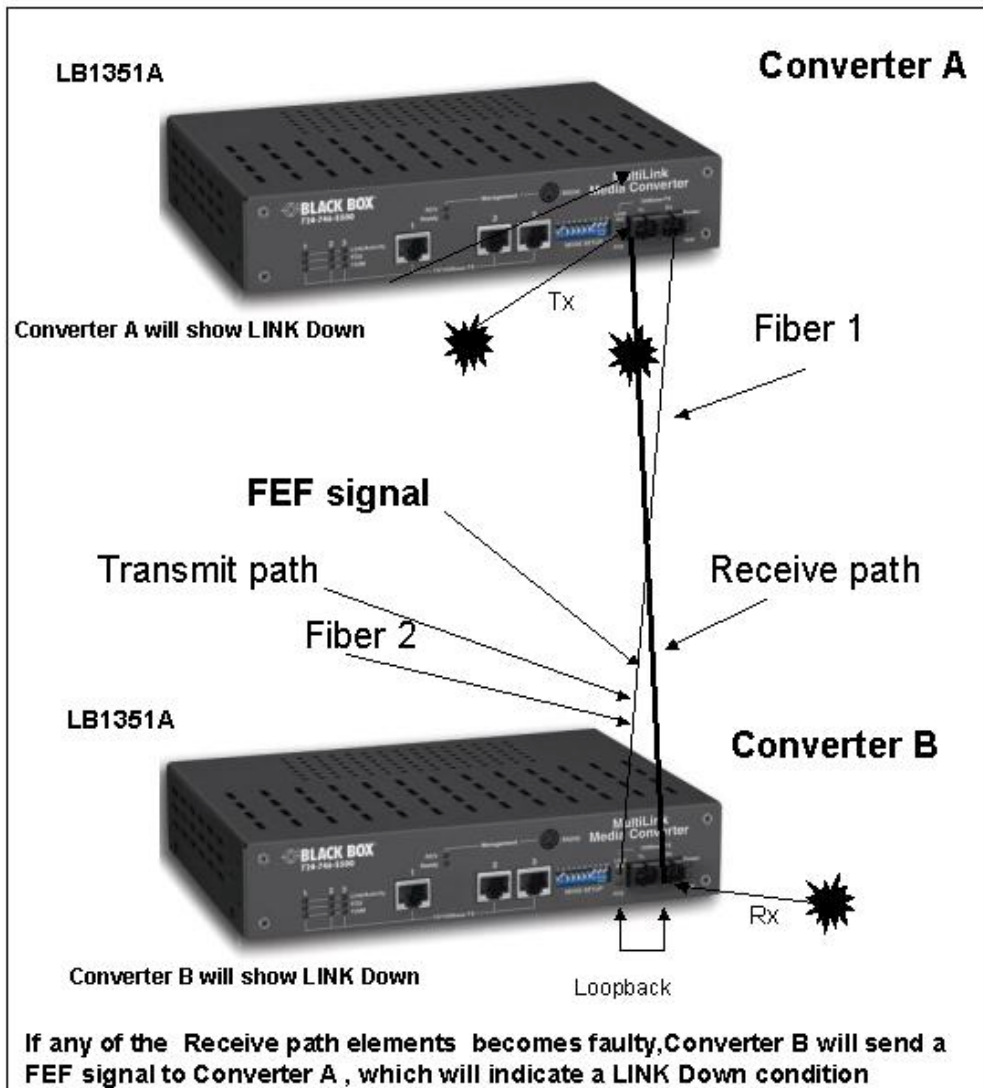

7 - PARTS IDENTIFICATION

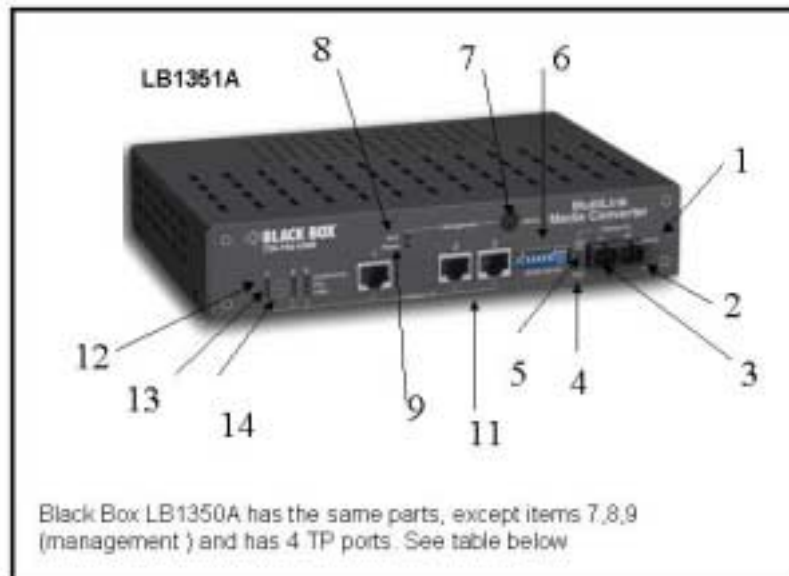

	Black Box®LB1350A	Black Box®LB1351A	COMMENTS
1	Power ON LED	Power ON LED	
2	TEST mode LED	TEST mode LED	Linked to DIP switch #8
3	Duplex SC connector	Duplex SC connector	
4	F/O FDX mode LED	F/O FDX mode LED	
5	F/O Link/Activity	F/O Link/Activity	Lit steady – LINK ON; blinking - receive
6	Mode Setup (DIP) switches	Mode Setup (DIP) switches	See section 12 for details (page 16)
7	N/A	Mini DIN RS-232 connector	
8	N/A	Receive LED	Management activity
9	N/A	Ready LED	Management module OK
10	RJ-45 ports 1 to 4	N/A	
11	N/A	RJ-45 ports 1 to 3	
12	Link/Activity ports 1- 4 LED	Link/Activity ports 1- 3 LED	Lit steady – LINK ON; blinking - receive
13	Full Duplex ports 1-4 LED	Full Duplex ports 1-3 LED	Lit when FDX detected or forced
14	100Mbps ports 1-4 LED	100Mbps ports 1-3 LED	Lit when 100Mbps detected or forced

NOTE: All Duplex mode LEDs – blinking indicates collisions on respective port (in HDX mode only)

8 - INSTALLATION

For Half-Rack Mount installation:

Use the optional bracket kit, affix it to the unit. Then use 4 standard bolts and nuts (not supplied), and fasten well to the rack.

Make sure to leave a gap of at least 2-3cm above the unit.

For wall mount installation

Three suitable holes on the back of the Black Box® LB1350A/LB1351A permit wall mount Installation either horizontally (preferred) or vertically.

Two holes are 188mm apart for horizontal wall mount installation, for vertical wall mount installation the two holes are 107mm apart.

Use two suitable screws having heads diameter less than 8mm

For Desktop use: Affix the supplied plastic “feet” (after peeling off the adhesive protecting sheet) to the bottom of the devices, with each “foot” approximately 1 cm from each edge.

Place the device horizontally on a hard, clean surface (desk, shelf, etc.), leaving free space around it for natural ventilation. Avoid putting the device on other active, heat generating equipment and avoid putting such devices on the Black Box®LB1350A/LB1351A

19” Rack installation

Use a standard flat shelf, install it in the rack and place one or two Black Box®LB1350A/LB1351A side by side on the shelf. Make sure to leave a gap of at least 2-3cm above the unit.

9 - POWER CONNECTION

CAUTION: When connecting a device to an AC) power outlet, always first connect the cord to the device, and ensure that it is securely fastened. Only afterward connect the cord to the wall outlet .Make sure to use grounded (3 way) outlets.

For each country Black Box provides with the product an appropriate power supply cord which is safety approved in accordance with such country's National Electric Code

Black Box®LB1350A/LB1351A

Connect AC line voltage at the rear of the converter, using the included power cord. The Black Box®LB1350A/LB1351A will accept any line voltage from 100 to 240 VAC, 50-60 Hz.



There is no ON/OFF switch on the device. When the power is connected to the device, the device is ON. This will be indicated by the POWER LED ON.

Important: following any connection or setup change (sections 10, 11, 12 below) you **must** reset the device by either using S9 or by disconnecting power and reconnecting it after few seconds

10 - FIBER OPTIC CONNECTION

The Black Box®LB1350A/LB1351A is equipped with either a pair of SC-type connectors (MM or SM models) or ST connectors (MM models only)

Do not remove the protective covers on the fiber connectors until you are ready to connect the fiber optic cables. Power should be connected before attaching the fiber optic cables. When dealing with fiber optic cables, it is essential to ensure that the TX at one end of the link is connected to the RX at the other end of the link. Some duplex fiber optic cables are color coded to help monitor the direction of data transmission. If the fibers are not coded, special attention must be paid to ensure a proper connection.

	<p>CAUTION <i>Radiation emitted from a fiber optic connector may be hazardous to human vision. Therefore, the following rules must be strictly observed</i></p>
	<p><i>All single-mode (SM) models are CLASS I LASER PRODUCTS And must be handled with special care When not in use, keep the fiber optic connector closed using its protective cover.</i></p>
	<p><i>Never stare directly into the fiber optic connector of a powered device or into the end of a fiber connected to it.</i></p>

11 - TWISTED PAIR CABLE CONNECTION

As each of the Black Box®LB1350A/LB1351A RJ-45 4(3) ports supports: full auto-negotiation, auto-polarity and auto-cross, you can simply connect any device to any port by using a standard straight or crossed cable. You may need to force an operation mode other than auto-negotiation; refer to section 12 (" Configuration Switches " page 14).

Use a shielded Cable Type 5 or higher grade, up to 100m (330ft) long to ensure proper operation at 100Mbps.

On Black Box®LB1350A/LB1351A with the Auto-Cross feature, the RJ45 port has the intelligence to sense the type of cable which has been connected to it and will automatically configure itself to either MDI or MDI-X mode of operation.

12 – CONFIGURATION SWITCHES

The Black Box®LB1350A/LB1351A) is equipped with an array of 10 DIP switches marked “MODE SETUP” that facilitate the proper setting of the device and individual ports. See section 7 (“ Parts Identification ” page 11)

Shaded areas indicate factory default setting.

Use a small tool (pen tip or a tiny flat-head screwdriver) to set the switches.

Switch No.	Function	Up Position	Down Position	Comments
1	TP port #1 operation mode	10Mbps/FDX (forced)	Auto-negotiation	
2	TP port #2 operation mode	10Mbps/FDX (forced)	Auto-negotiation	Not Connected in Black Box® LB1351A
3	TP port #3 operation mode	10Mbps/FDX (forced)	Auto-negotiation	TP Port #2 in Black Box® LB1351A
4	TP port #4 operation mode	Disable A/N	Auto-negotiation	TP Port #3 in Black Box® LB1351A .The port is in Auto-Negotiation mode by default
5	TP port #4 Speed	10Mbps	100Mbps	
6	TP port #4 Duplex mode	Half	Full	
7	F/O port Duplex mode	Half	Full	
8	Far End Fault	Disabled (Test)	Enabled (Normal)	See section 6
9	Reset	Normal operation mode	Reset	Reset momentarily (move down then up) following any setup change
10	VLAN ports default setting	Disable	Enable	By default each TP port with the F/O port forms a separate security VLAN. In LB1351A, the internal management port is also included in each VLAN.

13 – MANAGEMENT (Black Box® LB1351A)

The Black Box® LB1351A is a SNMP managed device. Main features are:

- Out-of-Band with any terminal emulation program (RS232 port, front panel)
- In – Band management.
- Supported MIBs : MIB II (RFC1213 and RFC1215), RFC2474 and private MIBs.
- The Black Box® /LB1351A converters may be managed from any SNMP management station running popular management platforms (e.g. HP OpenView, SNMPc, etc)

Refer to Appendix-A “**Managing the Black Box® LB1351A**” (pages 19-37) of this guide for the complete setup management procedures)

14. ADVANCED Features: Port Priority Schemes

The **Black Box® LB1351A** (only) can determine priority through three different means.

The first method is a simple per port priority, the second is via the 802.1p frame tag and the third is by viewing the DSCP (TOS) field in the Ipv4 header. Two priority levels are deployed (High and Low)

Per Port Priority

General priority can be specified on a per port basis. In this type of priority all traffic from the specified input port is considered high priority .

This can be useful in IP phone applications mixed with other data types . The IP phone traffic would be high priority .

802.1p Port Priority

This method works well when used with ports that have mixed data and media flows. The 802.1p priority tag (3 bits) are used to determine frame priority. The inbound port examines the priority field in the tag and determines the high or low priority.

VLAN tagging and priority. When frames are sent across the network, there needs to be a way of indicating to which VLAN the frame belongs. This info is added to the Ethernet frame in the form of a **tag header**.

Ethernet Frame Tag Header consists of a Tag protocol identifier (TPID) and Tag control information (TCI)

Ethernet frame :

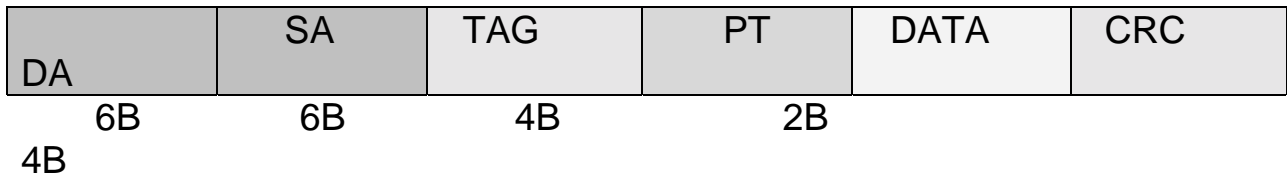

Tag Header

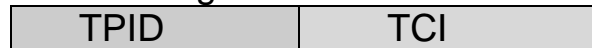

TPID is the tag protocol identifier which indicated that a tag header is following and the TCI contains the User priority, canonical format indicator (CFI) and the VLAN ID

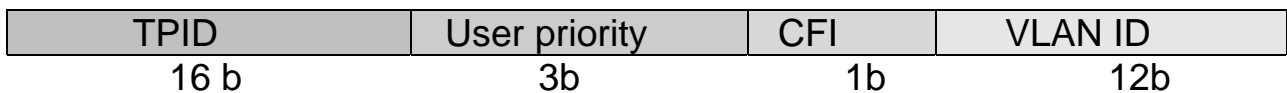

User priority is a 3 bit field which allows priority information to be encoded in the frame. 8 levels of priority are allowed, where zero is the lowest and 7 is the highest priority.(this field is used by 802.1p)

CFI : indicates presence/absence of RIF (routing info field) in the 802.3/Ethernet frames.

The VLAN ID is used uniquely to identify the VLAN to which the frame belongs. There can be a maximum of 4096 VLANs.

DSCP Port Priority

This is another per frame way to determine **outbound priority**.

The DSCP (Differentiated Services Code Point – RFC 2474) method uses the TOS

field in the IP header to determine high or low priority on a per code point basis. Each fully decoded code point can have either a high or low priority.

The most significant 6 bits of the TOS field are fully decoded into 64 possibilities,(up to 64 distinct behaviors) and the resulted singular code is compared against the corresponding bit in the DSCP register. (in Black Box® LB1351A unit)

Black Box®LB1350A/LB1351A

If the register bit is a 1, the priority is high and if 0, the priority is low.

Thus the DSCP value classifies the packet service level.

When more than one scheme is enabled, priority conflicts are resolved by the following order : 802.1p based priority overrides port based priority and TOS based priority overrides 802.1p based priority

15- TROUBLESHOOTING

Problem	Indication	Corrective Action
No power	Power LED not lit	Check that the power supply cable is firmly connected to the device and the wall power socket.
		Check that the AC input power source is between 100 and 240VAC.
Network problems	No communication on network	On the “mode setup switches”, check that S9 is in the UP position. (converter normal operation mode)
		Reset the device using S9
Any problem related to port 4 (3) or F/O port		Set device to TEST mode (S8 Down), reset device (S9).If problem not solved remain in TEST mode and perform troubleshooting.
TP link not working	Link LED not lit	On the “mode setup switch” move S9 to the DOWN position, and move it back to the UP position after one second.
		Check that the connected device is working properly at 100Mbps or 10Mbps.
		Check that the connection cable is well connected at both ends.
TP link not working at 100M when Black Box®LB1350A LB1351A connected to 100Mbps or 10/100Mps device	Both Link LED and 100BaseTX LED not lit	On the “setup mode switches”, check that respective switches S1 thru S4 are in down position (Auto-Negotiation mode)
		Interchange between the suspected port and another port 1 thru 4
		Check that the connected device is working properly at 100Mbps.
		Check the interconnection between the Black Box®LB1350A LB1351A and the device.
		Use for suspected link the preferred port and force it to 100Mbps (S4 up, S5 down)
TP link not working at 10M when the Black Box®LB1350A LB1351A connected to 10M device (copper side).	Link LED not lit	If suspected port is 1 thru 3, move respective switch (S1 thru S3) to up position , if port 4 – move S4 up and S5 up
		Reset the device using S9
		Check that the connected device is working properly at 10Mbps

Black Box®LB1350A/LB1351A

Problem	Indication	Corrective Action
		Check the interconnection between the Black Box®LB1350A LB1351A and the device.
Black Box®LB1350A or LB1351A not recognizing full duplex	FDX LED not lit	Verify that connected device is FDX capable and set to FDX properly. If HDX then the indication is correct and you have to setup the S7 Dip switch accordingly
		Check the interconnection between the Black Box®LB1350A/LB1351A and the device.
Fiber link not working	Link LED (100BaseFX) not lit	Check that the receive fiber is properly connected to the transmit port of the remote fiber device AND the transmit port to the receive port of the remote device.
	Remote device reports LINK DOWN	Change to TEST mode (S8 UP) and verify with remote operator to establish whether incoming or outgoing paths failed
		Check that the fiber optic power is higher than -30 dBm on the receive fiber connector at the Black Box®LB1350A /LB1351A end.
		Check that remote device's receive port is properly connected to the transmit fiber optic port of the Black Box®LB1350A /LB1351A
		Verify FDX mode of the F/O port (S7 Down) ; reset device by S9
No Link-Up after failure	F/O LED OFF	Disable FEF: Dip switch # 8 in Up position (section 12 page 14)
Improper network traffic	Runt and late collision	Reset the device using S9
		Check configuration (section 12) on the "mode setup switches".
		Check that both ends of F/O link are set to same mode (Half Duplex OR Full Duplex).
		Check that both sides of UTP connection are in same mode (10Mbps Half duplex OR 10Mbps full duplex OR 100Mbps Half duplex OR 100Mbps full duplex).

If the problem persists after carrying out the above procedure, do the following: replace the installed Black Box®LB1350A LB1351A, with another similar device and re-perform the requested setup. If that has solved the problem, send the faulty Black Box®LB1350A/LB1351A for repair. If the problem still persists, there is probably some sort of general network failure. Call Black Box Technical Support (Call 724-746-5500).

16.Specifications

Standard Compliance

IEEE 802.3u, IEEE802.1p, 100Base-TX, 100Base-FX, 10Base-T, FDX flow control, HDX back pressure flow control . Supported MIBs: MIB II (RFC1213,RFC1215), RFC2474 (DSCP) and private MIBs.

Vlan tagging support, (Black Box® LB1351A)

Conversion Method :BMD (Buffered Media Domain), four (three) ports share one F/O link

100BaseTX ports x 4 (3)
<ul style="list-style-type: none"> • Shielded RJ-45 connector • Half/full duplex support via auto-negotiation or manual (preferred port) • 100m over UTP/STP 100ohm cat.5 cable • Auto-polarity correction • MDI/ MDI-X auto crossover support • 10BaseT - Dip switches selection

100Base-FX port
<ul style="list-style-type: none"> • 1310nm multi-mode, SC (ST optional) connectors. Optional Single Mode • Distance: 2000m (6500ft) when used in pairs (15/40/ km in s/m) • Output power: -18dBm multi-mode single-mode: - 16 / -11 dBm respectively • Input sensitivity: • multi-mode: -32dbm • single mode: -30/-33 dBm respectively • Far End Fault Signaling. • Full/half duplex dip switch selection

Diagnostics
<ul style="list-style-type: none"> • F/O port: Link/Activity, FDX • Each TP port: Link/Activity, FDX,100Mbps • Power , Test LED (lit = FEF disabled, off = FEF enabled)

Controls
F/O port: HDX/FDX
TP ports 1-3(2): a/n-10M
TP port 4(3): a/n enable/disable, force 10/100/ force HDX/FDX
System: Reset, link test (enable / disable Far-End- Fault)

Environmental /Physical	
Power supply:	
Black Box®LB1350A/LB1351A	100 ÷ 240 VAC, 50 ÷ 60 Hz
• Power consumption:	15W max.
• Storage temperature:	-20°÷+ 80°C
• Operating Temperature	0°÷+ 45°C (32-113° F)
• Humidity:	10 ÷ 90% non-condensing
• Safety:	UL 1950): 1955, EN60950
• Emissions:	FCC part 15 subpart A, class A, VCCI Class ICES 003 : 1997, Class A, EMC Directive 89 / 336/EEC
Dimensions and weight	223x44x150mm (WxHxD) 600gram

Specifications subject to change without prior notice

Appendix-A : Managing the Black Box® LB1351A

1.Preface

This appendix provides you with the necessary information for managing the Black Box® LB1351A Traffic Aggregator (monitor and control).

In order to start managing your Black Box® LB1351A you need to setup the management module parameters (**section 2**). In addition you will need to set proper network connection (**section 3**) and to install the attached MIB file (**section 4**).

After the management parameters are set, you can manage the Black Box® LB1351A in either of two ways: using **SNMP** (through a standard management station – **section 5**) and using a **Terminal** (**section 6**).

2.Setting Up Management Parameters

Terminal connection

Have available a PC equipped with any terminal emulation program (any ASCII terminal).

Use the supplied control cable to connect the converter to the PC: connect the miniDIN end of the cable to the RS232 port on the converter and the other end to an available DB9 (male) connector on the PC.

Configure the terminal emulation program as follows:

- baud rate: 9600
- parity: none
- start bits: 1
- stop bits: 1
- flow control: none

Start the terminal emulation then reset the device.

Startup screen

After a few seconds you will get the start up screen (figure 2-1).

Note: the parameters appearing in the figures are just examples. Set them to the values you need.

At this point, you should immediately press any key in order to get to the management configuration procedure. You will get a notification that will enable you to modify the current settings by typing 'm' (or 'M').

At this stage you will be prompted with a series of questions regarding the management parameters configuration. The configuration procedure screen is shown here in figure 2-2. Default value for each parameter appears in braces. If you do not wish to change a certain parameter, simply hit 'Return'.The different parameters are explained in detail in figure 2-2. Default value for each parameter appears in braces.If you do not need to change a certain parameter, simply hit "Return ".The different parameters are explained in details in figure 2-2.

Management card configuration-----
NETWORK PARAMETERS:-----
IP address on LAN is 192.168.1.99

CONSOLE PARAMETERS:

console channel will use a baud rate of 9600

BOARD PARAMETERS:

Processor : MPC850, Running at 50Mhz
Board Info : Management Board
Board memory : FLASH : 4Mbytes
 SDRAM : 4Mbytes
Board's Ethernet hardware address : 0:A0:D2:2F:80:82

To change any of this, press any key within 5 seconds

Figure 2-1 – management parameters setup screen

When configuration is complete, the startup screen will appear with the new parameters. If you still want to change any other parameters, type 'M' to modify. Otherwise type 'C' to continue. Configuration parameters will now be saved and the system will initialize (figure 2-3).

(M)odify any of this or (C)ontinue? [M] m

For each of the following questions, you can press <Return> to select the value shown in braces, or you can enter a new value.

NETWORK PARAMETERS:

Do you want a LAN interface? [Y]
This board's LAN IP address(0.0.0.0 = RARP)? [192.168.1.99]
Use a subnet mask for the LAN interface? [N] y
Subnet mask for LAN (0 for none)? [0.0.0.0]
Should there be a default gateway for packet routing? [N] y
What is its IP address? [0.0.0.0]

CONSOLE PARAMETERS:

Baud rate for serial channels [9600]

ETHERNET PARAMETERS:

Do you want to change the board's Ethernet address? [N] y

Byte 0 must be 00

What should byte 1 be? [A0]
What should byte 2 be? [D2]
What should byte 3 be? [2F]
What should byte 4 be? [80]
What should byte 5 be? [82]

SNMP PARAMETERS:

Get community [public]
Set community [private]
Trap destination [192.168.1.15]
Trap community [trap]
System name [FibroLAN]
System location [Israel]
System Contact [Shamir]
How long (in seconds) should CPU delay before starting up? [5]**Figure 2-2 – management parameters configuration**

Network parameters

- **IP address:** specify here the IP address you wish to assign the management module. This parameter must be set correctly (according to your network) in order to remotely control and monitor your device from a management station.
- **Subnet mask:** specify the required subnet mask to use within the network.
- **Default gateway:** specify the default gateway to be used by the management module where applicable.

Console parameters

- **Baud rate:** set the baud rate of communication between the Black Box® LB1351A and the terminal. It is recommended to leave this setting at default (9600baud).

SNMP parameters

- **Get community:** specify the get community string for the device.
- **Set community:** specify the set community string for the device.
- **Trap destination:** specify the IP address of the remote manager that will receive the traps sent by the Black Box® LB1351A.
- **Trap community:** specify the trap community string for the device.
- **System name:** specify a name that identifies the device.
- **System location:** specify the physical location of the device. Setting this parameter properly helps to monitor the network and maintain order within it.
- **Contact name:** specify the person (most likely system or network administrator) that is responsible for managing and/or handling the converter.
- **Start up delay:** specify how many seconds the management module should wait between the appearance of the start-up screen and the system initialization. During this time it is possible to change the management parameters configuration.

```
Updating parameter storage. This may take a while...Done
Initialization...
```

Figure 2-3 – configuration complete; initialization

Your Black Box® LB1351A is now ready to be managed. The Ready LED should now be lit steady.

Disconnect the control cable and store it properly (unless you wish to manage the Black Box® LB1351A through a terminal).

3. Network Connection

One of the conditions that have to be met before you're able to manage the Black Box® LB1351A is to have the device connected to a network (IP).

This connection is achieved through the Fiber-Optic port of the device. Naturally, this port has to be connected to a network, on which the management station resides. Please note that all management traffic is in-band, along with normal traffic.

At this point your Black Box® LB1351A is ready to be managed by any Network Manager running on the network. In order to obtain full management functionality over the Black Box® LB1351A, you should install the MIB file and define the Black Box® LB1351A object in the management application (see next section).

Important: if you wish to manage the device (and/or other devices in the network) by connecting the management station directly to one of the device's RJ-45 ports, you **MUST** disable per port VLAN first (switch # 10 to UP position)!

4. Configuring the Management Station

Before you can begin to fully manage the Black Box® LB1351A from a management station using SNMP, you need to load and compile the MIB file(s), included with the management module, onto the management station.

In order to accomplish this you need to perform two steps:

Copy the MIB file, supplied with the module, to the default directory that contains all other MIB files (varies between management software packages).

In your management application, add the new MIB to the already existing list of MIBs and recompile them.

After MIB installation you should define a new managed object for the Black Box® LB1351A according to the SNMP parameters you have previously set. The way to define this object varies from one management application to another.

You have now completed all the necessary preparations required to fully monitoring and controlling the Black Box® LB1351A from any management station on the network.

5.Managing the Black Box® LB1351A

You can monitor and control the Black Box® LB1351A Traffic Aggregator using SNMP with a management station. This station must have a management application and it should be connected to the device (via the network).

After the device and management station are connected and running you will be able to manage your device through the SNMP management application.

Use the management application to view the device's general information (figure 5-1) or the MIB tree for detailed status (figure 5-2). In order to monitor the device's status you should open the following branch of the tree:

```
enterprises/fibrolan/fibrolanSNMP/fibrolanAggregator/flAggrLta31m
```

Through the various parameters given within the Black Box® LB1351A's MIB, you can view the complete device status and the ports' status and you can configure most of these parameters.

The Black Box® LB1351A is a fully featured traffic aggregator that provides advanced capabilities such as VLAN tag insertion and stripping and an advanced set of priority schemes. These features are explained in details later on in the '**Managing with a terminal**' section. All settings are also accessible through SNMP and their meaning is the same (so the complete detailed explanation about each parameter is found only in the terminal section).

Note: some configuration changes (mainly port connection and disconnection) require a few seconds to take effect.

6. Managing with a Terminal

The first option for managing the Black Box® LB1351A Traffic Aggregator is by using a terminal emulation program. In order to do this you will need a PC (or a terminal) with a terminal emulation program.

Connect the **serial cable** supplied with the Black Box® LB1351A between the device (miniDIN side) and a serial port on the PC with the terminal emulation (on the DB9 side). Start the emulation program and reset the device (recommended).

After system initialization you will get to the device's main menu.

The main menu

This menu contains a header with the software version, the model of the device (LB1351A) and the vendor Black Box.

Following is a two-option menu. See figure 6-1.

Selecting option 1 will invoke the device's status menu, while option 2 will bring up the device control menu.

```
*****
*
* Software version: v1.0
* Version date: 16/10/02
*
* Vendor: Black Box
* Model: LB1351A
*
*****

1. Device status
2. Device control
Select (1-2):
```

figure 6-1 - main menu

The device status menu

This menu contains two options: 1 for basic status and 2 for advanced status. Figure 6-2 shows the menu. Figures 6-3 and 6-4 show the basic and advanced status respectively.

```
Device status:
=====
1. Basic status
2. Advanced status
0. Main menu
Select (0-2):
```

figure 6-2 - device status menu

```

Basic ports' status:
# Type Link Duplex AutoNego Rate Connected
=====
1 TP Off FDX Disabled 100M Yes
2 TP Off n/a Enabled n/a Yes
3 TP Off n/a Enabled n/a Yes
4 FO Off FDX ---- 100M Yes
=====

Basic device status:
-----
VLAN: enabled
Temperature: 39C
    
```

figure 6-3 - basic status

Basic status

This status includes the basic ports' status and the basic device status.

Basic port's status gives the following data about each port:

- Port number
- Interface type (TP/FO)
- Link status (On/Off)
- Duplex mode (FDX/HDX)
- Auto-Negotiation mode (enabled/disabled)
- Data rate (10/100M)
- Connection mode (connected/disconnected)

The **basic device status** includes:

- VLAN mode (enabled/disabled)
- Device's temperature (in centigrade)

```

Advanced ports' status:
# Type Tag: Insert Strip VID | Priority: Port 802.1p TOS User
=====
1 TP No No 0 | No No No 0
2 TP No No 0 | No No No 0
3 TP No No 0 | No No No 0
4 FO No No 0 | No No No 0
  Mgmt No Yes 222 | No No No 0
=====

Advanced device status:
-----
Test: Off
Priority ratio: Always high
Broadcast: Allow 25% broadcasts
DSCP (63 <- 0): 0x00-00-00-00-00-00-00-00
User priority: code: 0 1 2 3 4 5 6 7
                prio: LO LO LO LO HI HI HI HI
    
```

figure 6-4 - advanced status

Advanced status

A port's advanced status includes, in addition to its number and type:

- Tag insertion mode (Yes/No)
- Tag stripping mode (Yes/No)
- Port's VID (0-4095)
- Port based priority (Yes/No)
- 802.1p based priority (Yes/No)
- TOS based priority (Yes/No)
- Port's user priority (0-7)

When tag insertion is enabled on a port it means that any untagged frames coming out that port will be tagged. The inserted tag will include the ingress port's VID and user priority. For example, if port 1's VID is set to 100 and its priority is set to 4 and the FO port's tag insertion is on, then any untagged frame coming on port 1 and going out the FO port will carry a tag with VID 100 and priority 4.

When tag stripping is enabled, any tagged frame coming on the port, will lose its tag. Default values are all 0s or No.

The Black Box® LB1351A supports 2 levels of traffic priority: high and low. The different priority settings enable or disable 3 different types of priority schemes: port based, 802.1p based and Type Of Service (TOS) based, dealing with DSCP (Diff Serve Code Points) field values.

When more than one scheme is enabled, priority conflicts are resolved by the following order: 802.1p based priority overrides port based priority and TOS based priority overrides 802.1p based priority. Default values are all No.

Please note that the advanced port settings apply to management traffic as well. Management can be thought of as a virtual, internal port.

The **device's advanced status** consists of:

- Test mode (FEF disable/enable)
- Priority ratio (always hi/10:1/5:1/2:1)
- Broadcast protection (allow 25/12/6/3%)
- DSCP codes (64 bits)
- User priority classification (7 priority codes, set as high or low priority)

The test mode is used mainly for maintenance purposes and its meaning is that the FEF function is disabled (when Test is On). Default value is Test Off.

The priority ration setting controls the priority traffic flow ratio. If for example, set to always hi, all high priority frames will be forwarded before low priority ones. At 10:1, after every 10 high priority frames, a single low priority frame will be forwarded and so on. Default value is always hi.

The broadcast protection indicates the relative amount of broadcast traffic that will be forwarded by the Black Box® LB1351A, starting at 25% maximum and down to 3% minimum. Default value is 25%.

The DSCP codes are represented as a series of 8 bytes, corresponding to 64 bits. These bits correspond, in turn, to 64 different DSCP codes. If you wish, for instance, to set code 45 as high priority, then bit 45 in this series needs to be set to '1' (this is done through the control menus, described later). Default values are all 0s (meaning all codes are low priority).

The user priority codes are used in conjunction with the 802.1p based priority scheme. For example, if a tagged frame arrives with a priority code of 6, the Black Box® LB1351A will look priority code 6 to see if it is set as high or low priority and handle the frame accordingly. **Default values are low priority for codes 0-3 and high priority for codes 4-7.**

The device control menu

The device control menu, shown in figure 6-5, enables the user to change the different settings and configuration of the Black Box® LB1351A

```
Device control:
=====
1. TP port 1 control
2. TP port 2 control
3. TP port 3 control
4. FO port 4 control
5. Device reset
6. Basic device control
7. Advanced device control
8. Management control
0. return to main menu
Select (0-8):
```

figure 6-5 – device control menu

Options 1 through 4 will invoke the corresponding port's control menu. Option 5 will result in a device reset (which will return the relevant configuration settings to the switches position). Options 6 and 7 will bring up the device control menu, respectively and the eighth option will get you to the management virtual port's settings.

All control functions are located in the same tables of the device's MIB sub-tree as their corresponding status. The only exception is the management control functions, which reside in the same table as the advanced device status.

Port control menus

The port control menu, as shown in figure 6-6, provides the user with two options: 1 for basic control and 2 for advanced control. The figures below show the menus for TP port 1. The menus are identical for TP ports 2 and 3 and almost the same as in FO port 4, the only difference being the exclusion of the data rate and auto-negotiation mode changes (not available for this port).

```
TP port 1 control:
=====
1. Basic control
2. Advanced Control
0. Back to control menu.
Select (0-2):
```

figure 6-6 – port control menu

Basic port control

The basic port control menu, shown in figure 6-7, is composed of the following options:

- Auto - Negotiation mode change
- Data rate change
- Duplex mode change
- Port disconnection
- Port connection
- Device reset

```
TP port 1 basic control:
=====
1. Change Auto-Negotiation
2. Change 10M/100M
3. Change duplex mode
4. Disconnect port
5. Connect port
6. Reset device
0. Back to port control menu
Select (0-6):
```

figure 6-7 – basic port control menu

Selecting any of these options will result in the appropriate action. The configuration changes require about a second to take effect. When you change the port's setup, it will be restored the next time the device is powered on.

Please note that the port can only be disconnected when the VLAN mode is 'enabled'.

Note that for the FO port the only two options will be the duplex mode change and the device reset.

Advanced port control

The advanced port control menu, shown in figure 6-8, is composed of the following options:

- Set tag insertion mode (enable/disable)
- Set tag stripping mode (enable/disable)
- Set the port's VLAN ID (0-4095)
- Set port based priority mode (enable/disable)
- Set 802.1p based priority mode (enable/disable)
- Set TOS based priority mode (enable/disable)
- Set the port's user priority (0-7)

```
TP port 1 advanced control:
=====
1. Enable/Disable tag insertion
2. Enable/Disable tag stripping
3. Set VLAN ID
4. Enable/Disable port priority
5. Enable/Disable 802.1p priority
6. Enable/Disable TOS priority
7. Set user priority
0. Back to port control menu
Select (0-7):
```

figure 6-8 – advanced port control menu

If you wish to change the port's VID or its user priority, you will be prompted for the desired values. Illegal values will not be accepted and will be rewarded with an 'Invalid value!' error message.

Setting any of the other options will cause the device to prompt the user for enabling (1) or disabling (0) the feature.

Please note that the VLAN related features (namely, tagging options) would take effect when the VLAN mode is 'enabled'.

Detailed information regarding these options can be found in the advanced status section.

Basic device control

The basic device control menu, illustrated in figure 6-9, enables you either to reset the device (1) or to change its VLAN mode (2).

```
Basic device control:
=====
1. Reset device
2. Change VLAN mode
0. Back to control menu
Select (0-2):
```

figure 6-9 – basic device control menu

Advanced device control

You will find the advanced device control menu (figure 6-10) providing you with the following options:

- Test mode changing (On/Off)
- Binding or splitting ports 1 and 2
- Binding or splitting ports 1, 2 and 3
- Set the high/low traffic priority ratio
- Set the broadcast protection mode
- Set the DSCP codes
- Set the 802.1p priority classification
- Restore the device default settings

```
Device advanced control:
=====
1. Change Test mode
2. Bind/Split ports 1 & 2
3. Bind/Split ports 1, 2 & 3
4. Set hi/low priority ratio
5. Set broadcast protection
6. Set DSCP codes
7. Set priority classification
8. Restore device defaults
0. Back to control menu
Select (0-8):
```

figure 6-10 – advanced device control menu

Changing the device's Test mode will enable or disable its FEF function (Test off/Test on, respectively). Please note that during normal operation this should be set to Test off (FEF enabled).

When you choose to bind/split ports (options 2 and 3), you will be prompted whether you wish to bind or split the ports. Binding the ports means they will reside in the same port based VLAN, resulting in the ability to directly communicate with each other (assuming no other factors, such as different tagging setup, interfere). Splitting the ports will undo this operation. **This option can only take effect when the VLAN mode is 'enabled'.**

Selecting option 4 will prompt the user with the priority ratio mode selection menu (figure 6-11)

```
Hi/Low priority ratio:
1. Always Hi first
2. Transmit at 10:1 ratio
3. Transmit at 5:1 ratio
4. Transmit at 2:1 ratio
0. Skip without changing
Select (0-4):
```

figure 6-11 – priority ratio mode select

Choosing to set the broadcast protection mode will prompt the user for the desired setting (figure 6-12).

```
Broadcast protection:  
1. Allow 25% broadcast frames  
2. Allow 12% broadcast frames  
3. Allow 6% broadcast frames  
4. Allow 3% broadcast frames  
0. Skip without changing  
Select (0-4):
```

figure 6-12 – broadcast protection mode select

If you wish to change the DSCP codes or the 802.1p priority classification you will be prompted for the DSCP code or priority code and the corresponding value, as shown in figures 6-13 and 6-14, respectively.

```
DSCP configuration:  
Select DSCP code (0-63) or 64 to skip: 28  
  
Select hi(1) or low(0) priority for DSCP 28: 1
```

figure 6-13 – DSCP configuration change

```
802.1p user priority classification:  
Select priority code (0-7) or 8 to skip: 3  
  
Select hi(1) or low(0) priority for priority 3: 1
```

figure 6-14 – 802.1p priority classification change

Choosing the last option (8) of the advanced device control menu will cause the device to return to its default settings and restart. This may require a few seconds to complete. The default values are given in the status section. It is recommended to reset the device after this operation.

Management control menu

The management control menu (figure 6-15) provides the same options as other advanced port priority menus. These settings apply to in-bound and out-bound management traffic going through the 'virtual management port'. Consider them as if they apply the same way as they do with any other port.

```
Management control:  
=====  
1. Enable/Disable tag insertion  
2. Enable/Disable tag stripping  
3. Set VLAN ID  
4. Enable/Disable priority  
5. Enable/Disable 802.1p priority  
6. Enable/Disable TOS priority  
7. Set user priority  
0. Back to port control menu  
Select (0-7):
```

figure 6-15 – management control menu

Note that changing some settings (such as the VLAN ID) may cause management traffic to be stopped, thus disconnecting the management station from the device. Please note that the VLAN related features (namely, tagging options) would take effect when the VLAN mode is 'enabled'.

7.Managing with SNMP

When you wish to manage the Black Box® LB1351A with SNMP using a management station, you should have the relevant MIB file (“**bbLB1351A.mib**”) installed and compiled on any standard management application.

Once you have the appropriate network connection for managing the device you can start getting the device parameters’ status and changing its settings.

Note that the meaning of each parameter is the same as its corresponding one in the menus. You can therefore find the detailed explanations regarding these parameters in the previous (terminal) section.

Note that viewing a parameter and setting its value is done in the same place in the table (the method for setting might differ from one management application to another).

System info

Figure 7-1 shows the basic, MIB standard, system info table. It is accessible through the standard’s MIB system info table.

Descr	BlackBox LB1351A
ObjectID	FIBROLAN-MIB1-LTA31MIBAggrLta31m
UpTime	0 days 00:01:47.00
Contact	Shamir
Name	
Location	IL
Services	79

figure 7-1 – system info

Basic device configuration

Basic device configuration table is located under **f1Lta31mDevice/f1Lta31mDeviceBasic** in the device’s MIB sub-tree. The table is shown in figure 7-2.

Temperature	31
ResetMode	running
VlanMode	off
TestMode	off
PortBinding	none
Defaults	running

figure 7-2 – basic device configuration

Please note that the Test mode setting appears in this table, unlike the menus system in which it appears under advanced device status/control.

Advanced device configuration

Advanced device configuration table is located under `filLta31mDevice/filLta31mDeviceAdvanced` in the device's MIB sub-tree. The table is shown in figure 7-3.

Parameter	Value
TagInsert	disable
TagStrip	enable
TagVid	100
PortPriority	disable
8021pPriority	disable
TosPriority	disable
UserPriority	0
filLta31mDevicePriorityTrafficRatio	alwaysHi
filLta31mDeviceBroadcastProtection	allow25pct

figure 7-3 – advanced device configuration

please note that the management configuration (i.e. tagging and priority options) is found in this table as well.

In addition to the above table, there are two more tables under this MIB branch: the DSCP settings table (figure 7-4) and the user priority settings table (figure 7-5).

Index	5	6	7	8	9	10
Value	low	low	low	low	low	low

figure 7-4 – DSCP configuration

each entry in the DSCP table corresponds to a DSCP code (0-63) and its value is either high or low priority.

Index	Value
0	low
1	low
2	low
3	low
4	high
5	high
6	high
7	high

figure 7-5 – user priority configuration

each entry in the user priority table corresponds to 802.1p priority classification code (0-7) and its value is either high or low priority.

Basic port configuration

Basic port configuration table is located under `f1Lta31mPorts/f1Lta31mPortBasic` in the device's MIB sub-tree. The table is shown in figure 7-6.

	1	2	3	4
BasicIndex	1	2	3	4
IfType	tp	tp	tp	fo
LinkStatus	on	off	off	off
DuplexMode	fdx	n-a	n-a	fdx
SpeedMode	s100Mbps	n-a	n-a	s100Mbps
AutoNegoMode	enable	enable	enable	disable
ConnectMode	connected	connected	connected	connected

figure 7-6 – basic port configuration

Advanced port configuration

Advanced port configuration table is located under `fLLta31mPorts/fLLta31mPortAdvanced` in the device's MIB sub-tree. The table is shown in figure 7-7.

AdvancedIndex	1	2	3	4
TagInsert	disable	disable	disable	enable
TagStrip	disable	disable	disable	disable
TagVid	0	0	0	0
Priority	disable	disable	disable	disable
8021pPriority	disable	disable	disable	disable
TosPriority	disable	disable	disable	disable
UserPriority	0	0	0	0

figure 7-7 – advanced port configuration

SNMP traps

The management application also allows you to receive traps sent by the device (figure 7-8). Traps are sent by the Black Box® LB1351A after every configuration change. In addition traps will be sent to alert of the following events:

- System up (cold start)
- Temperature (when exceeds 65⁰C for more than 1 minute)
- TP link down
- FO link down
- TP link up (after at least 10 seconds down)
- FO link up (after at least 10 seconds down)
- Device reset (management initiated)

* traps for configuration changes will specify the initiator of the change (either local user or remote manager) where applicable.

Troubleshooting

Symptom	Probable Cause	Remedy
Ready LED doesn't turn on	Device is not powered up	Check the power cable connection inside the box.
Configuration menu isn't readable or doesn't appear at all	Problem with serial cable or terminal	Check the serial cable and the settings of the terminal.
No SNMP response from the manager	Wrong IP address settings	Check the IP address on the configuration menu. Try to use the "ping" command. If there is no ping answer try to check the Ethernet cable (you can check the Link LED).
No traps	Trap destination IP address not configured properly	Check for the manager's IP address in the trap destination on the configuration menu.
Device doesn't appear in the MIB browser	MIB file not installed properly	Make sure you have copied the MIB file to the proper location in the manager station; make sure the MIBs are compiled with the new file.



This document and the information contained herein are proprietary to the manufacturer and are furnished to the recipient for use in operating, maintaining and repairing manufacturer equipment.

The information within may not be utilized for any purpose except as stated herein, and may not be disclosed to third parties without the written permission from the manufacturer.

The manufacturer reserves the right to make changes to any technical specifications in order to improve reliability, function and design.

EUROPEAN UNION DECLARATION OF CONFORMITY



*This equipment complies with the requirements of the European
EMC Directive 89 / 336 / EEC*



© Copyright 2002. Black Box Corporation. All rights reserved.

1000 Park Drive

Lawrence, PA 15055-1018 724-746-5500

Fax 724-746-0746

Free Manuals Download Website

<http://myh66.com>

<http://usermanuals.us>

<http://www.somanuals.com>

<http://www.4manuals.cc>

<http://www.manual-lib.com>

<http://www.404manual.com>

<http://www.luxmanual.com>

<http://aubethermostatmanual.com>

Golf course search by state

<http://golfingnear.com>

Email search by domain

<http://emailbydomain.com>

Auto manuals search

<http://auto.somanuals.com>

TV manuals search

<http://tv.somanuals.com>