

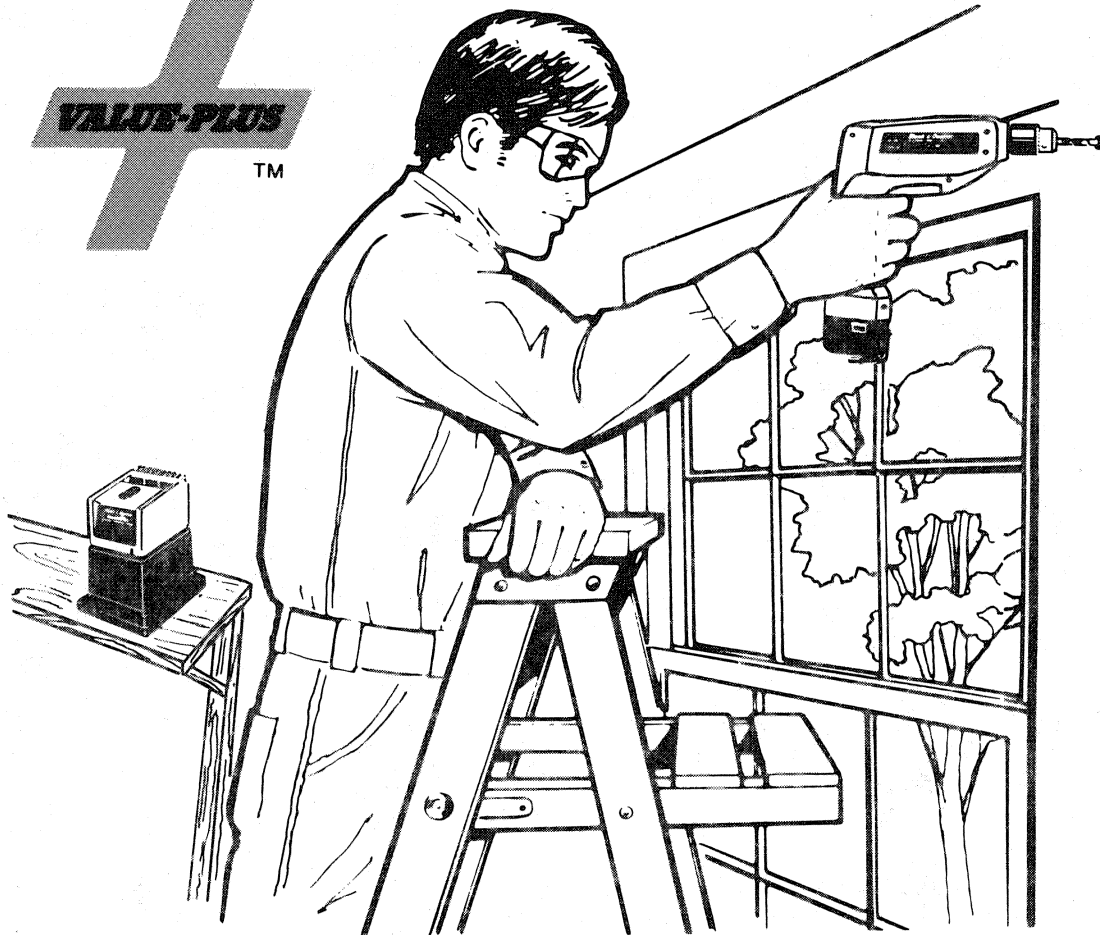

Black & Decker

OWNER'S MANUAL



Your new CORDLESS Drill is as versatile as any corded $\frac{1}{4}$ " or $\frac{3}{8}$ " Drill. It offers the ultimate in convenience and electrical safety. You can forget the electric outlet, and forget the cord. You can take your Cordless Drill anywhere and use it in a wide variety of applications.

For safe and efficient operation of this

Drill, please read all safety rules and instructions carefully.

Don't forget to send in the owner's registration card.

THANK YOU for buying BLACK & DECKER!

*Trademark of The Black & Decker Mfg. Co.

IMPORTANT

To assure product SAFETY and RELIABILITY, repairs, maintenance and adjustment, (including brush inspection and replacement) should be performed by Black & Decker Service Centers or other qualified service organizations, always using Black & Decker replacement parts.

The Chuck on this Drill is non-removable. If damaged return to an authorized Black & Decker Service Center.

9023/9024
3/8" REVERSING
CORDLESS DRILL
& 1 HOUR
FAST CHARGER

IMPORTANT SAFETY INSTRUCTIONS (FOR ALL TOOLS)

WARNING: When using Electric Tools, basic safety precautions should always be followed to reduce the risk of fire, electric shock, and personal injury, including the following:

READ ALL INSTRUCTIONS

1. **KEEP WORK AREA CLEAN.** Cluttered areas and benches invite injuries.
2. **CONSIDER WORK AREA ENVIRONMENT.** Don't expose power tools to rain. Don't use power tools in damp or wet locations. Keep work area well lit.
3. **GUARD AGAINST ELECTRIC SHOCK.** Prevent body contact with grounded surfaces. For example: pipes, radiators, ranges, refrigerator enclosures.
4. **KEEP CHILDREN AWAY.** All visitors should be kept away from work area. Do not let visitors contact tool or extension cord.
5. **STORE IDLE TOOLS.** When not in use, tools should be stored in dry, and high or locked-up place — out of reach of children.
6. **DON'T FORCE TOOL.** It will do the job better and safer at the rate for which it was intended.
7. **USE RIGHT TOOL.** Don't force small tool or attachment to do the job of a heavy-duty tool. Don't use tool for purpose not intended, for example, don't use circular saw for cutting tree limbs or logs.
8. **DRESS PROPERLY.** Do not wear loose clothing or jewelry. They can be caught in moving parts. Rubber gloves and non-skid footwear are recommended when working outdoors. Wear protective hair covering to contain long hair.
9. **USE SAFETY GLASSES.** Also use face or dustmask if cutting operation is dusty.
10. **DON'T ABUSE CORD.** Never carry tool by cord or yank it to disconnect from receptacle. Keep cord from heat, oil, and sharp edges.
11. **SECURE WORK.** Use clamps or a vise to hold work. It's safer than using your hand and frees both hands to operate tool.
12. **DON'T OVERREACH.** Keep proper footing and balance at all times.
13. **MAINTAIN TOOLS WITH CARE.** Keep tools sharp and clean for better and safe performance. Follow instructions for lubricating and changing accessories. Inspect tool cords periodically and if damaged have repaired by authorized service facility. Inspect extension cords periodically and replace if damaged. Keep handles dry, clean, and free from oil and grease.
14. **DISCONNECT TOOLS.** When not in use, before servicing, and when changing accessories, such as blades, bits, cutters.
15. **REMOVE ADJUSTING KEYS AND WRENCHES.** Form habit of checking to see that keys and adjusting wrenches are removed from tool before turning it on.
16. **AVOID UNINTENTIONAL STARTING.** Don't carry plugged-in tool with finger on switch. Be sure switch is off when plugging in.
17. **OUTDOOR USE EXTENSION CORDS.** When tool is used outdoors, use only extension cords intended for use outdoors and so marked.
18. **STAY ALERT.** Watch what you are doing. Use common sense. Do not operate tool when you are tired.
19. **CHECK DAMAGED PARTS.** Before further use of the tool, a guard or other part that is damaged should be carefully checked to determine that it will operate properly and perform its intended function. Check for alignment of moving parts, binding of moving parts, breakage of parts, mounting, and any other conditions that may affect its operation. A guard or other part that is damaged should be properly repaired or replaced by an authorized service center unless otherwise indicated elsewhere in this instruction manual. Have defective switches replaced by authorized service centers. Do not use tool if switch does not turn it on and off.
20. **DO NOT OPERATE** portable electric tools near flammable liquids or in gaseous or explosive atmospheres. Motors in these tools normally spark, and the sparks might ignite fumes.

SAVE THESE SAFETY RULES FOR FUTURE USE.

DRILL SAFETY RULES

1. Be aware that this tool is always in an operating condition, because it does not have to be plugged into an electrical outlet.
2. When drilling into walls, floors or wherever "live" electrical wires may be encountered, **DO NOT TOUCH THE CHUCK OR ANY FRONT METAL PARTS OF THE DRILL!** Hold the Drill only by the plastic handle to prevent electric shock if you drill into a "live" wire.

IMPORTANT CHARGER AND POWER PACK SAFETY INSTRUCTIONS

1. **SAVE THESE INSTRUCTIONS**—This manual contains important safety and operating instructions for 1 Hour Fast Charger Model 138097.
2. Before using Power Pack charger, read all instructions and cautionary markings on (1) Power Pack charger, (2) Power Pack, and (3) product using Power Pack.
3. The Charger and Power Pack are specifically designed to work together. **DO NOT** attempt to charge any other cordless tool or battery pack with this Charger. **DO NOT** attempt to charge the Power Pack with any other Charger than the one shown in this manual.
4. Do not expose charger to rain or snow.
5. Use of an attachment not recommended or sold by Black & Decker may result in a risk of fire, electric shock, or injury to persons.
6. To reduce risk of damage to electric plug and cord, pull by plug rather than cord when disconnecting charger.
7. Make sure charger cord is located so that it will not be stepped on, tripped over, or otherwise subjected to damage or stress.
8. An extension cord should not be used unless absolutely necessary. Use of improper extension cord could result in a risk of fire and electric shock. If extension cord must be used, make sure:
 - a. That pins on plug of extension cord are the same number, size, and shape as those of plug on charger;
 - b. That extension cord is properly wired and in good electrical condition; and
 - c. That wire size is large enough for AC ampere rating of charger as specified in Table 1.

TABLE 1
RECOMMENDED MINIMUM AWG SIZE FOR
EXTENSION CORDS FOR BATTERY CHARGERS

AC Input Rating Amperes*		AWG Size of Cord			
Equal to or greater than	but less than	Length of Cord, Feet			
		25	50	100	150
0	2	18	18	18	16
2	3	18	18	16	14
3	4	18	18	16	14

* If the input of a charger is given in watts rather than in amperes, the corresponding ampere rating is to be determined by dividing the wattage rating by the voltage rating—for example:

$$\frac{125.0 \text{ watts}}{125 \text{ volts}} = 1.0 \text{ amperes}$$

9. Do not operate charger with damaged cord or plug—replace them immediately.
10. Do not operate charger if it has been damaged in any way; take it to a qualified Black & Decker Service Center.
11. Do not disassemble charger; take it to a qualified Black & Decker Service Center when service or repair is required. Incorrect reassembly may result in a risk of electrical shock or fire.

12. To reduce risk of electric shock, unplug charger from outlet before cleaning. Turning off controls will not reduce this risk.
13. NEVER attempt to connect 2 Chargers together.
14. DO NOT store the Tool and Power Pack in locations where the temperature may reach or exceed 120°F (such as outside sheds or metal buildings in summer).
15. DO NOT Charge Power Pack when it or air temperature is BELOW +40°F or ABOVE +105°. **This is very important.**
16. DO NOT incinerate the Power Pack even if it is severely damaged or is completely worn out. The Power Pack can explode in a fire.
A small leakage of liquid from the power pack cells may occur under extreme usage or temperature conditions. This does not indicate a failure.
However, if the outer seal is broken and this leakage gets on your skin:
 - a. Wash quickly with soap and water.
 - b. Neutralize with a mild acid such as lemon juice or vinegar.
 - c. If battery liquid gets into your eyes, flush them with clean water for a minimum of 10 minutes and seek immediate medical attention.
(Medical note: The liquid is a 25-35% solution of potassium hydroxide.)
17. The charger is designed to operate on standard household electrical power (120 volts AC only). Do not attempt to use it on any other voltage!
18. Do not attempt to open the power pack housing.

CHARGING THE POWER PACK

THE BATTERIES IN YOUR NEW POWER PACK ARE NOT FULLY CHARGED! First read Safety Rules above. Then follow charging notes and procedures on page 5 and 6.

IMPORTANT CHARGING NOTES

1. Longest life and best performance can be obtained if the Power Pack is charged when the air temperature is about +75°F. DO NOT charge the Power pack in an air temperature below +40°F or above +105°F. This is important and will prevent serious damage to the batteries.
2. When you charge your power pack for the first time, or after prolonged storage, it will only accept about an 80% charge. However, after several charge and discharge cycles, the batteries will come up to full capacity.
3. While charging, the metal fins on the rear of the Charger will become warm to touch. This is a normal condition, and does not indicate a problem.
4. If the Power Pack does not charge properly — (1) Check current at receptacle by plugging in a lamp or other appliance, (2) Check to see if receptacle is connected to a light switch which turns power off when you turn out the lights.
If the receptacle and temperature are o.k., and you do not get proper charging, take or send the tool and charger to your local Service Center. See "TOOLS, ELECTRIC" in yellow pages.
5. The Power Pack should be recharged when it fails to produce sufficient power on jobs which were easily done previously. DO NOT CONTINUE to use under these conditions. Repeat the charging procedure.
6. If, after repeated use, your Power Pack does not take a full charge, and produces operating times less than normal, it may not be caused by faulty or worn out batteries. If you use the Power Pack repeatedly for only a few minutes and then charge it, the batteries will build up a resistance to taking a full charge. This resistance results in reduced operating time.

The batteries can be restored to their original power and life by fully charging and then completely using up the charge several times. This will recondition the batteries to deliver maximum performance.

REMOVING THE POWER PACK FROM TOOL

1. Move Switch Control Button to the rear of its slot to lock Trigger Switch "OFF" (see Figure 1) before removing the Power Pack.
2. Depress the Latch Buttons simultaneously on end cap and pull away from Drill Handle. End cap will be held to drill by hinge straps (see Figure 2).
3. Remove the Power Pack from drill by pulling straight out. Do not twist.

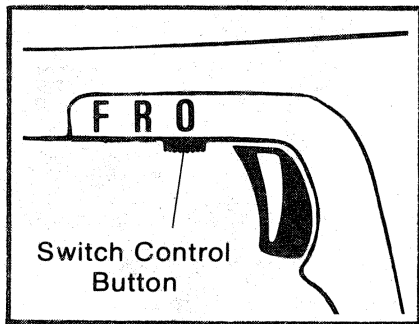

Figure 1

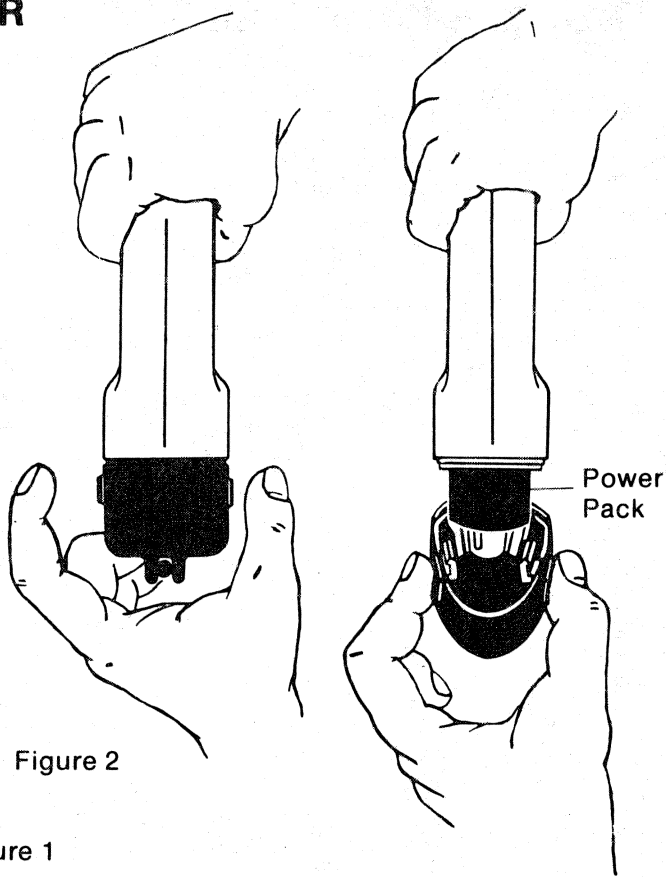

Figure 2

1 HOUR ELECTRONIC FAST CHARGER

This charger will charge Power Pack part number 138030/98016 in one hour.

CHARGING PROCEDURE

1. Plug in the Charger.
2. Place the Power Pack in the Charger as shown in Figure 3. Note that the groove in the Power Pack should be oriented to match key in charger.
3. The indicator light will start to blink slowly.
4. In about one hour, the indicator light will stop blinking and remain continuously on. Charging is complete and your Power Pack is ready for use.
5. The indicator light will remain on as long as the Power Pack is left in the Charger. There will be an automatic maintenance charge to keep your Power Pack in a fully charged condition. The indicator light will go out when the Power Pack is removed from the Charger.
6. The indicator light may stay on momentarily after the battery pack is removed from the charger. Always wait for the indicator light to go out before inserting another pack.

INDICATOR LIGHT OPERATION

CHARGING	1 1/2 sec. on — 1 1/2 sec. off
FAULTY POWER PACK	1/2 sec. on — 1/2 sec. off
FULLY CHARGED	CONTINUOUS ON

TROUBLE SHOOTING

1. If the indicator light *does not come on* when the Power Pack is inserted into the Charger:
 - a. Be sure the Power Pack is inserted in the proper direction;
 - b. Check your outlet as defined in Note 4 of "Important Charging Notes" (page 4);
 - c. Try a second Pack if one is available.

If your second Power Pack charges o.k., your first Power Pack is defective. Have the Power Pack checked at your local B&D Service Center.

2. If the indicator light *starts blinking fast* after charging has started, your Power Pack is defective. Have the Power Pack checked at your local B&D Service Center.
3. If you feel that the Power Pack does not fully charge, recharge the Power Pack. Be sure the charger indicator light is out before inserting the Power Pack into the Charger. Watch to be sure light starts to blink slowly.

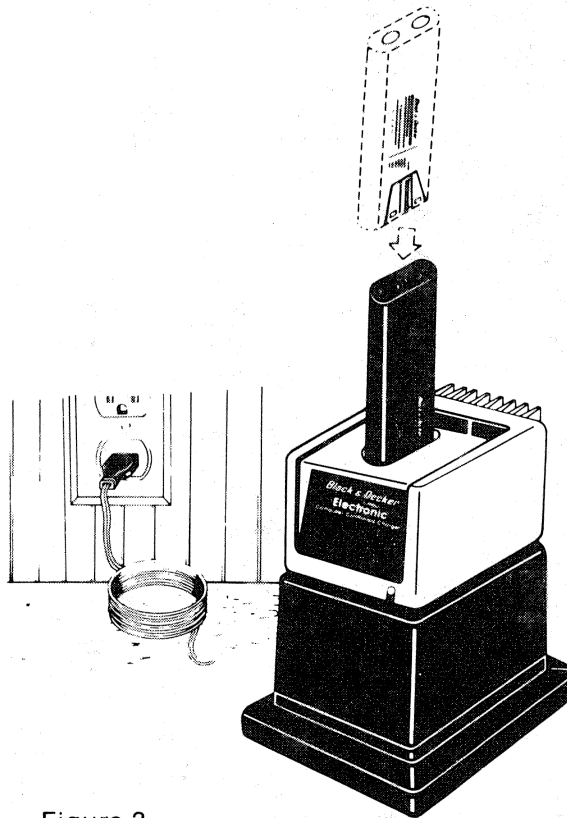

Figure 3

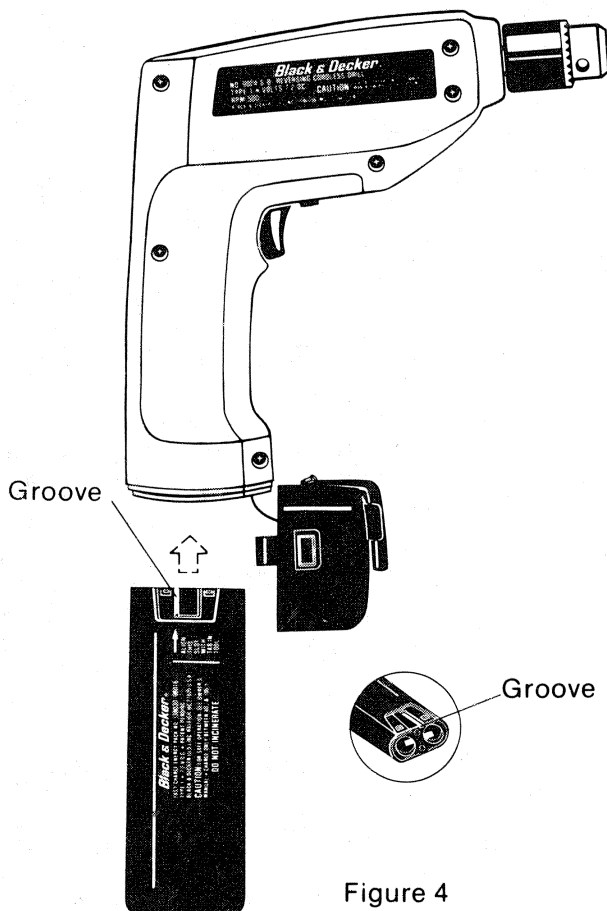

Figure 4

REPLACING THE POWER PACK INTO TOOL HANDLE

Insert Power Pack into handle of drill; the slot groove in the Power Pack should be located toward the side of the drill that has the screws, as shown in Figure 4. If drill and Power Pack will not assemble remove Power Pack and reorient so slot groove in pack will match key in handle.

NOTE: The side of the power pack with the groove is the side with the label on it.

TRIGGER SWITCH & CONTROL SWITCH

The Drill is turned "ON" and "OFF" by pulling and releasing the Trigger Switch. However the trigger can be locked "OFF" by positioning the Control Switch Button at the end of its slot (Figure 5). This position should be used to prevent the Trigger from being accidentally turned on, when attaching or removing the Power Pack, when attaching or changing accessories, or when cleaning the Drill.

SCREW DRIVING

For driving fasteners, the Control Switch Button should be in the "Forward" position (Figure 6).

Use the "Middle" position (Figure 7) for removing fasteners. When moving from FORWARD to REVERSE, or vice versa, always release the trigger first.

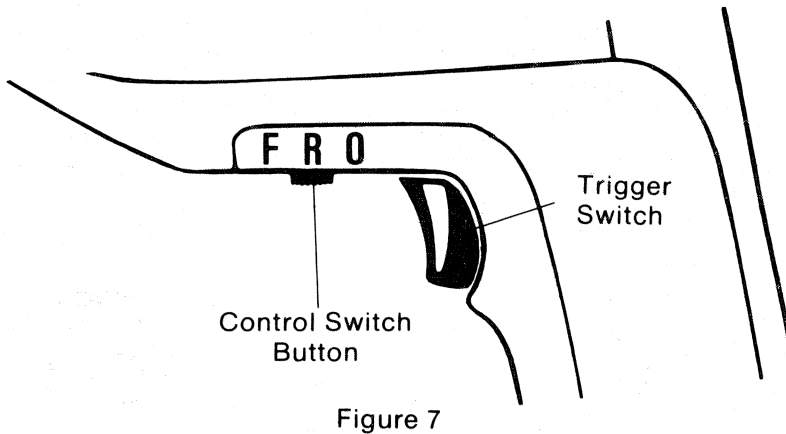
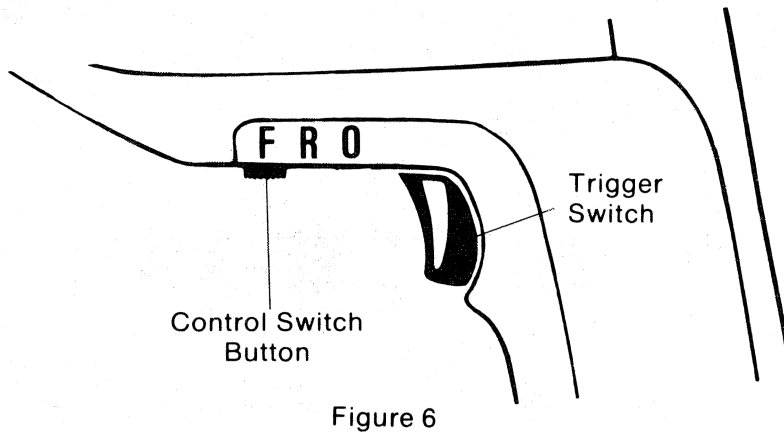
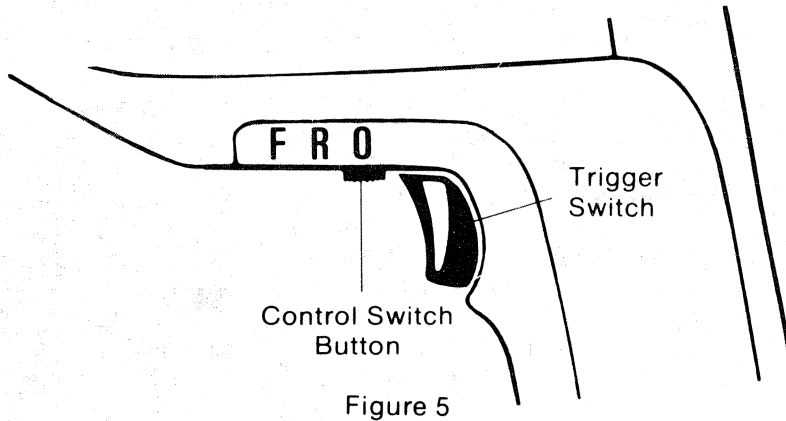

CHUCK & KEY

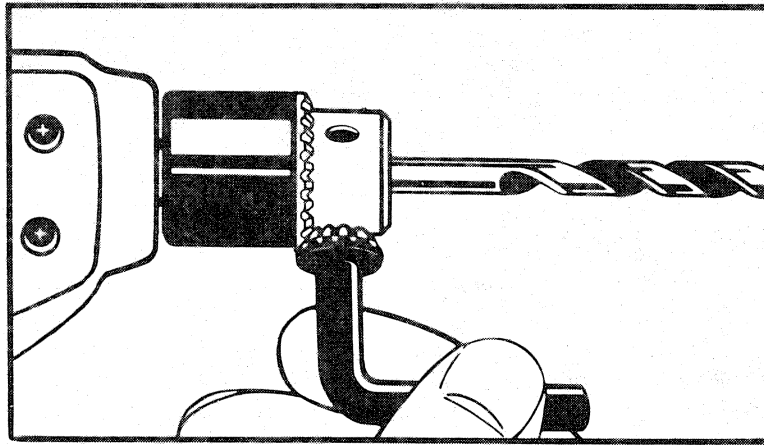

Figure 8

Turn Chuck Key counterclockwise to open chuck jaws. Place bit in chuck as far as it will go. Tighten chuck collar by hand. **Place chuck key in each of the three holes, and tighten in clockwise direction** (Figure 8). It's important to tighten chuck with all three holes to prevent bit slippage. To release bit, turn chuck key counterclockwise in just one hole, then loosen chuck by hand. **THE CHUCK ON THIS DRILL IS NON-REMOVABLE. IF DAMAGED RETURN TO AN AUTHORIZED BLACK & DECKER SERVICE CENTER.**

When not in use, the chuck key can be stored in the end of the handle. To remove the key, pull it firmly upward out of its holding socket. To replace key, push key's handle firmly and completely down into the holding socket (Figure 9).

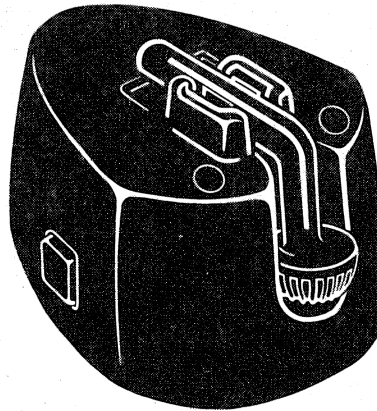

Figure 9

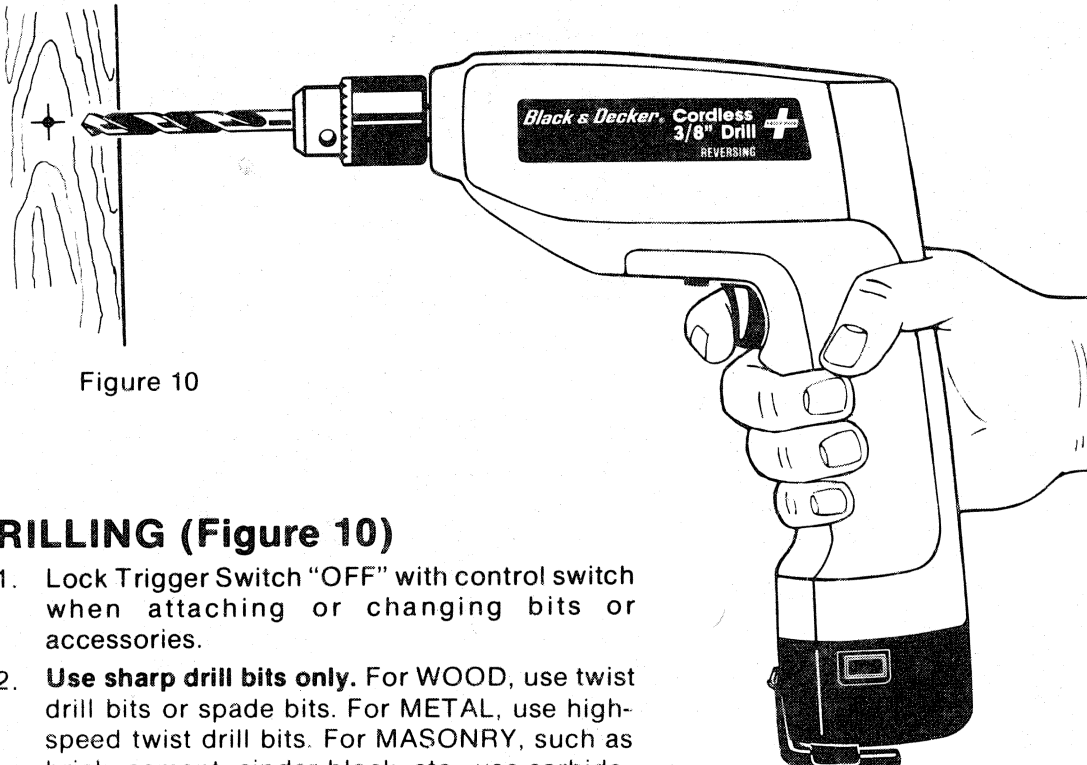

Figure 10

DRILLING (Figure 10)

1. Lock Trigger Switch "OFF" with control switch when attaching or changing bits or accessories.
2. **Use sharp drill bits only.** For WOOD, use twist drill bits or spade bits. For METAL, use high-speed twist drill bits. For MASONRY, such as brick, cement, cinder block, etc., use carbide-tipped bits.

3. Be sure the material to be drilled is anchored or clamped firmly. If drilling thin material, use a wood "back-up" block to prevent damage to material.
4. Center-punch an indentation at the point to be drilled. This will overcome tendency of bit to slip around on a smooth surface. Place the tip of bit in indentation and turn motor "ON."
5. Always apply pressure in a straight line with the bit. Use enough pressure to keep drill biting, but do not push hard enough to stall motor or deflect bit. To minimize stalling on breaking through the material, reduce pressure on drill and ease the bit through last part of hole.
6. Hold drill firmly to control the twisting action of the drill.

DRILLING IN WOOD

Holes in wood can be made with the same twist drill bits used for metal or with spade bits. These bits should be sharp and should be pulled out frequently when drilling to clear chips from the flutes. Work that is apt to splinter should be backed up with a block of wood. Let up on the pressure just before the tip cuts through, to obtain a good clean hole.

DRILLING IN METAL

Use a cutting lubricant when drilling ferrous metals. The exceptions are iron and brass which should be drilled dry. The cutting lubricants that work best are sulphurized cutting oil or lard oil, bacon grease will also serve the purpose.

CLEANING & LUBRICATION

Use only mild soap and a damp cloth to clean the tool. Many household cleaners contain chemicals which could seriously damage the plastic. Also, do not use gasoline, turpentine, lacquer or paint thinner, dry cleaning fluids or similar products. Never let any liquid get inside the tool; never immerse any part of the tool into a liquid.

Self lubricating bearings are used in the tool and periodic relubrication is not required. However, it is recommended that, once a year, you take or send the tool to a B&D Service Center for a thorough cleaning, inspection and lubrication of the gear case.

DRILL STORAGE

1. The best storage place is one that is cool and dry—away from direct sunlight, heating pipes and ducts, furnaces, etc.
2. Best storage temperature is approximately +75°F. Do not store where temperatures may go below +40°F or above +105°F. Avoid storage in outside metal buildings or automobile trunks where the temperature could go above +105°F in summer, as this could damage the batteries.
3. Long storage will not harm the Drill, Batteries, or Charger. Under the proper conditions they can be stored for 3-5 years or more without harm.
4. When storing Drill move Control Switch Button to the rear end of its slot to LOCK Trigger Switch "OFF" (Figure 11). This will prevent accidental battery discharge.

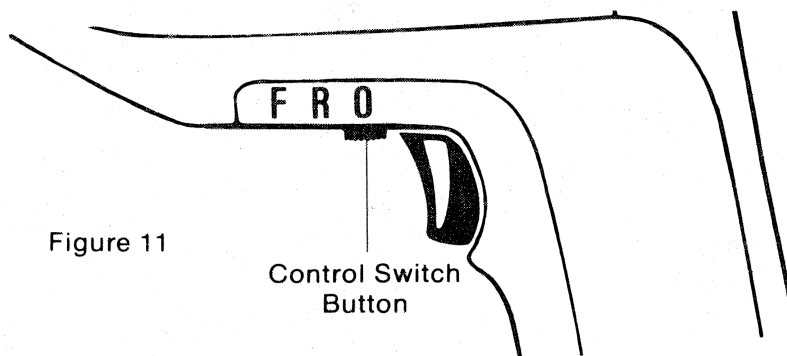

ORDERING REPLACEMENT POWER PACKS

Your 1 Hour Electronic Charger will charge only Power Pack No. 138030/98016. Contact your local Black & Decker Service Center or place where you purchased your drill to obtain a new Power Pack.

ACCESSORIES

Recommended accessories for use with your Drill are listed below and in Black & Decker catalogs. (CAUTION: The use of any other accessory might be hazardous). All types of Bits, Screw Driving Attachments and Rotary Files & Rasps are available from your B&D Distributor or local B&D Service Center. If any advice or assistance is needed, please write B&D Customer Service, 500 Hanover Pike, Hampstead, Md. 21074.

For safety in use, the following accessories should be used only in the sizes specified below:

BITS, METAL DRILLING—Up to 3/8"

BITS, MASONRY DRILLING—Up to 3/8"

SPADE BITS—Up to 1"

We strongly recommend that your first purchase be the No. U-2106 Safety Glasses which should be worn when using all drill accessories.

The end cap has two storage areas for screwdriver bits as shown in Figure 12. (Bits not supplied.)

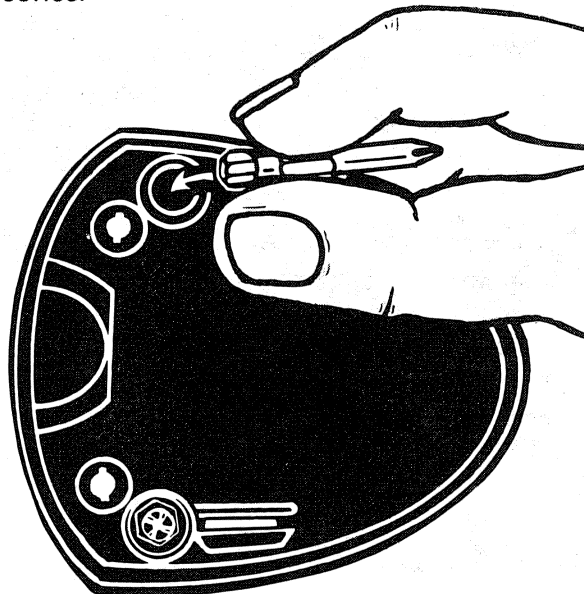

Figure 12

HOME USE WARRANTY (A FULL TWO YEAR WARRANTY)

Black & Decker warrants this product for two years against any defects that are due to faulty material or workmanship. Please return the complete unit, transportation prepaid, to the seller (if a participating retailer) for free replacement (proof of purchase may be required). The unit may also be returned to a Black & Decker Service Center or Authorized Service Station, listed under "Tools Electric" in the yellow pages for free replacement or repair at our option. This warranty does not apply to accessories. This warranty gives you specific legal rights and you may have other rights which vary from state to state. Should you have any questions, contact your nearest Black & Decker Service Center Manager.

BLACK & DECKER (U.S.) INC.
Consumer Power Tools Division • 3012 Highwoods Blvd.
Raleigh, NC 27625, U.S.A.

Form No. 740978

(JAN82-CO)

Printed in U.S.A.

Free Manuals Download Website

<http://myh66.com>

<http://usermanuals.us>

<http://www.somanuals.com>

<http://www.4manuals.cc>

<http://www.manual-lib.com>

<http://www.404manual.com>

<http://www.luxmanual.com>

<http://aubethermostatmanual.com>

Golf course search by state

<http://golfingnear.com>

Email search by domain

<http://emailbydomain.com>

Auto manuals search

<http://auto.somanuals.com>

TV manuals search

<http://tv.somanuals.com>