

BLACK & DECKER®

POWER MONITOR INSTRUCTION MANUAL

Catalog Number
EM100B



**Thank you for choosing Black & Decker!
Go to www.BlackandDecker.com/NewOwner
to register your new product.**

**BEFORE RETURNING THIS PRODUCT
FOR ANY REASON, PLEASE CALL
1-800-544-6986**

*Before you call, have the Catalog No. and date code available. In most cases,
a Black & Decker representative can resolve the problem over the phone.
If you have a suggestion or comment, give us a call. Your feedback is vital to Black & Decker.*

SAVE THIS INSTRUCTION MANUAL FOR FUTURE REFERENCE.

Welcome

The Black & Decker Power Monitor helps you conserve electricity by showing you how much you use, and what it costs, as you use it. This feedback will help you take steps to reduce your consumption and save money.

The Power Monitor will show you:

- Your current electricity usage
- The usage of a single electric appliance
- Your accumulated electricity usage over any time period
- Your estimated monthly usage
- The temperature at your meter, to encourage checking your POWER MONITOR

And when you program the Power Monitor with your electricity billing rates, it will show you:

- Your electricity cost per hour
- The cost to use a single electric appliance
- Your accumulated electricity cost over an hour, a day, or any time period
- Your estimated monthly bill

This Instruction Manual explains how to get your Power Monitor ready for use.

Before starting, please read the safety precautions below and please read all of the instructions in this Instruction Manual.

Important Safety Precautions

Install your Power Monitor Meter Sensor on a dry day and take all necessary safety precautions, particularly if you need to use a ladder for installing the Meter Sensor. In addition, please read and follow the safety instructions below at all times.

- Do not immerse either Power Monitor unit in any liquid.
- Do not drop or cause any sudden impact to either Power Monitor unit.
- If disposing of the Power Monitor, do so in accordance with your local waste disposal regulations.

⚠ WARNING: Batteries can explode, or leak, and can cause injury or fire.

To reduce this risk:

- Carefully follow all instructions and warnings on the battery label and package.
- Always insert batteries correctly with regard to polarity (+ and -) marked on the battery and the equipment.
- Do not short battery terminals.
- Do not charge batteries.
- Do not mix old and new batteries. Replace all of them at the same time with new batteries of the same brand and type.
- Remove dead batteries immediately and follow local codes for disposal.
- Do not dispose of batteries in fire.
- Keep batteries out of reach of children.
- Transporting batteries can possibly cause fires if the battery terminals inadvertently come in contact with conductive materials such as keys, coins, hand tools, etc. The US Department of Transportation Hazardous Material Regulations (HMR) actually prohibits transporting batteries in commerce or on airplanes (i.e. packed in suitcases and carry on luggage. UNLESS they are properly protected from short circuits. So when transporting individual batteries, make sure that the battery terminals are protected and well insulated from materials that could contact them and cause a short circuit.

Liquid Crystal Display (First Aid Measures)

- If liquid crystal comes in contact with your skin:
Wash area completely with plenty of water. Remove contaminated clothing.
- If liquid crystal gets into your eye:
Flush the affected eye with clean water and then seek medical attention.
- If liquid crystal is swallowed:
Flush your mouth thoroughly with water. Drink large quantities of water and induce vomiting. Then seek medical attention.
- Read all the instructions carefully before using your Power Monitor.

CONTENTS

| | |
|--|-------|
| 01 Before You Begin | |
| Verify the Contents of the Box | 4 |
| You Will Also Need | 4 |
| Attach Digital Display Stand | 5 |
| Install Batteries | 5 |
| 02 Understanding Your Power Monitor | |
| Knowing the Meter Sensor | 6 |
| Knowing the Digital Display | 6 |
| 03 Installing Your Meter Sensor | |
| Determine Your Electric Meter Type | 7 |
| Type 1 Electromechanical | |
| A. Record Power Factor | 8 |
| B. Prepare Meter Sensor | 8 |
| C. Install Meter Sensor | 9 |
| Type 2 Electronic w/ Optical Port on Face | |
| A. Record Power Factor | 10 |
| B. Prepare Meter Sensor | 11 |
| C. Install Meter Sensor | 12 |
| Type 3 Electronic w/ Optical Port on Top | |
| A. Record Power Factor | 13 |
| B. Prepare Meter Sensor | 13-14 |
| C. Install Meter Sensor | 15-16 |
| 04 Synchronize Meter Sensor and Digital Display | 16 |
| 05 Determine Billing Mode and Billing Rate | |
| Determine Your Billing Rate | 17 |
| Flat Rate | 18-19 |
| Tiered Rate | 20-22 |
| Time-of-Use Rate | 23-26 |
| 06 Program Digital Display – Time, Day, Temperature, Power Factor, Billing Mode | 27-28 |
| 07 Program Digital Display – Flat Rate Billing | 29 |
| 08 Program Digital Display – Tiered Rate Billing | 30-31 |
| 09 Program Digital Display – Time-of-Use Rate Billing | 32-33 |
| 10 Using Your Power Monitor | |
| Overview | 33 |
| Cost View | 34 |
| Power View | 35 |
| Single Appliance Monitoring | 36 |
| 11 Troubleshooting | 38-41 |
| 12 How Electricity is Measured | 42 |
| 13 Technical Specifications / Warranty | 42-44 |

01 BEFORE YOU BEGIN**Verify the contents of the box.**

Verify that your package contains all of the components shown below. If any item is missing, please call 1-800-544-6986.



1 Rubber Shim

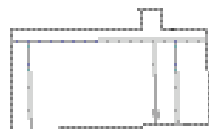

1 Clear Alignment Template

3 Instruction Manuals
(English, Spanish and French)

Digital Display

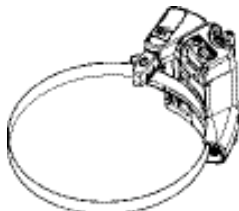
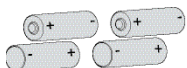

Digital Display Stand

Meter Sensor
(with clamping strap)**You will also need:**

- Four (4) AA batteries (not included)
Do not use rechargeable batteries
Use lithium batteries in the sensor for best performance in freezing temperatures (below 32°F, 0°C)

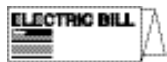

- Copy of your Electricity Bill



- 1 large Flat Head Screwdriver (not included)

- A clean damp cloth (not included)

01 BEFORE YOU BEGIN**Digital Display Stand**

The Digital Display can be mounted to a wall using the keyhole hanger in the back, or it can stand alone using the plastic stand.

To attach the stand to the Digital Display, insert the plastic tabs into the square recesses on the lower back of the Digital Display as shown. Once all four tabs are in the recesses, push up on the stand to lock it in place.

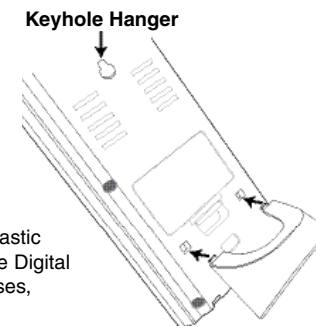
**Install Digital Display Batteries**

Remove the battery compartment cover on the back of the Digital Display, insert two AA batteries (not included) in the proper orientation, and replace the battery compartment cover.

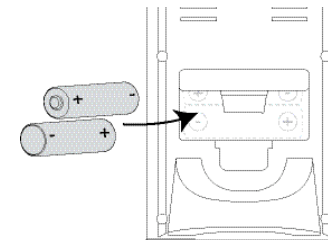
**Install Meter Sensor Batteries**

Using a large Flat Head Screwdriver, loosen the slotted screw and open the Meter Sensor battery compartment cover. Insert two AA batteries (not included) in the orientation indicated, then close the battery compartment cover and tighten the screw until snug.

About 10 seconds after installing the batteries, the status indicator will light up solid red, and the sensor will look for a signal from a meter. If the sensor is not installed on a meter within 20 minutes, the status light will blink rapidly. This is normal, and you can press the RESET button to restart the search if your installation is interrupted.

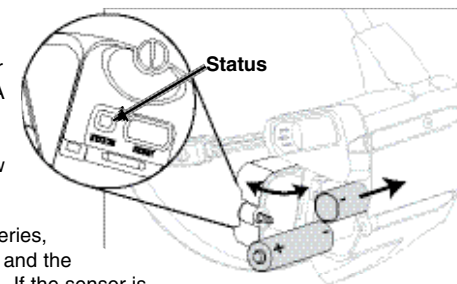

Make sure that the battery closest to the Sensor Arm goes in with its positive end (+) facing inward. Refer to (+) and (-) markings on the circuit board.

02 UNDERSTANDING YOUR POWER MONITOR

Knowing the Meter Sensor

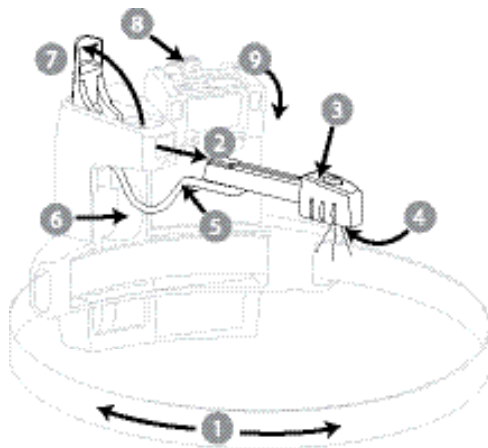

- 1 Clamping Strap
- 2 Sensor Arm (extended)
- 3 Sensor Head
- 4 Sensor LEDs
- 5 Wire
- 6 Wire Cavity
- 7 Sensor Arm Latch Cover
- 8 Battery Compartment Latch
- 9 Battery Compartment Cover

Knowing the Digital Display

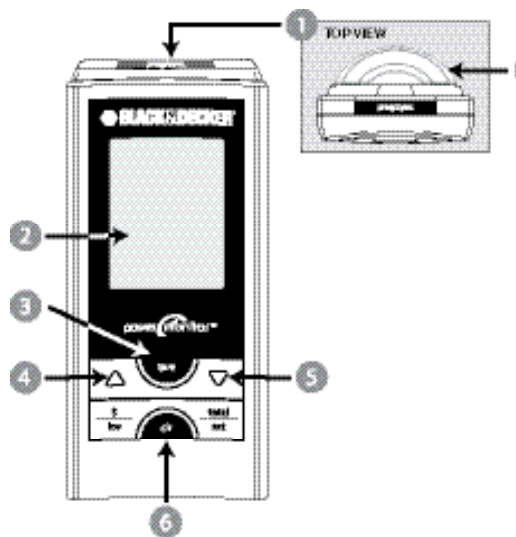

- 1 prog/sync Button
- 2 Screen
- 3 tare Button
- 4 Increase Button
- 5 Decrease Button
- 6 clr Button
- 7 Display Stand

6

03 INSTALLING YOUR METER SENSOR

Go to your electric meter and take the following items with you:

- This Manual
- Meter Sensor
- Digital Display
- Rubber Shim
- A clean damp cloth
- 1 large Flat Head screwdriver
- Clear Alignment Template (if you have a Type 3 meter)
- A pen or pencil

Determine your electric meter type

In order to configure your Meter Sensor and program your Digital Display properly, you must first determine what type of electric meter you have.

There are three types of electric meters:



TYPE 1—Electromechanical

This type of meter has dials and a spinning disk.
Note – If your meter has dials, but the spinning disk is not visible from the front of the meter, call the Black & Decker Help Line at 1-800-544-6986.

If this is your meter type, proceed to the next page.

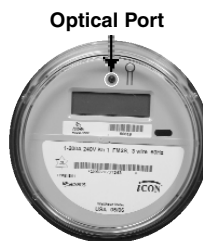

Optical Port

TYPE 2—Electronic with optical port on the face

The optical port looks like an LED, and may appear anywhere on the face. Some meters have two ports.

If this is your meter type, proceed to page 10.

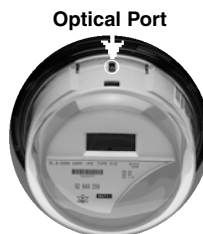

Optical Port

TYPE 3—Electronic with optical port on the top

The optical port looks like a clear plastic cylinder that protrudes from the top of the electric meter.

If this is your meter type, proceed to page 13.

7

03 INSTALLING YOUR METER SENSOR TYPE 1—ELECTROMECHANICAL

A. Record Your Meter's Power Factor

Find your meter's Power Factor on the face of the meter. Look for a number preceded by the letters Kh. This number is usually 7.2 for an electromechanical meter. Write this number in the box below. You will need it later (in section 06) when you program your Digital Display.

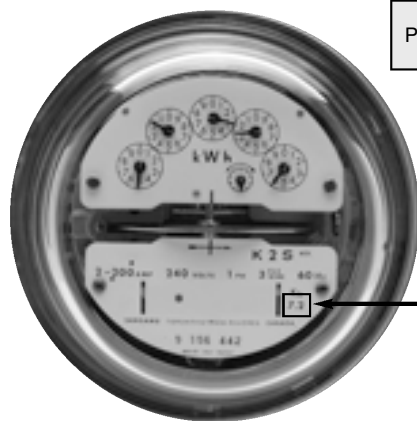

Power Factor = (usually 7.2 Kh)

B. Prepare Your Meter Sensor

Make sure the batteries are installed in the Meter Sensor (and the STATUS Indicator is flashing).

1. Open the Sensor Arm Latch Cover by pulling upward.
2. Extend the Sensor Arm to its full length by pulling on it gently, but firmly. If you accidentally pull it out completely, push it back into the casing.
3. Close the Sensor Arm Latch Cover.

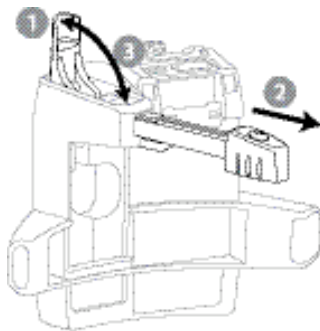

8

03 INSTALLING YOUR METER SENSOR TYPE 1—ELECTROMECHANICAL

C. Install Your Meter Sensor

1. Wipe the meter dome clean with the damp cloth.
2. Fit the Meter Sensor over your utility meter as shown, so that the Sensor Head sits as close as possible to the front of the glass dome.
3. Tighten the clamping strap until the Meter Sensor is snug, but can move just enough to allow for slight adjustments.
4. Position the Sensor Arm as shown to the right.

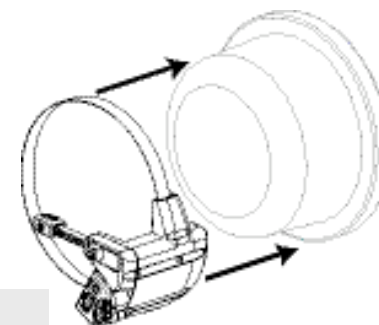

Note: The Sensor Arm must be in line with the disc (use the line of the Sensor Arm as a reference) and the Sensor LEDs must be centered from side-to-side.

5. Press the RESET button. Within 10 seconds, the STATUS indicator will light solid red while the Meter Sensor looks for a signal from the meter.
6. When you have positioned the sensor arm correctly, the red STATUS indicator will flash whenever the black stripe on the meter wheel passes by. You may need to wait for several revolutions before seeing the indicator flash.



NOTE: To maximize battery life, the indicator stops flashing after about two minutes.

7. Tighten the clamp just enough so that the Meter Sensor cannot move.

Installation is complete! Go to page 16 Section 4.

9

03 INSTALLING YOUR METER SENSOR TYPE 2—ELECTRONIC WITH OPTICAL PORT ON FACE

A. Record Your Meter's Power Factor

Find and record your meter's Power Factor. On the face of the meter, look for a number preceded by the letters Kh, Ks, or Kt. This number is usually 1.0 for an electronic meter. If your meter lists more than one of these numbers, look for the smallest number. Write this number in the box below. You will need it later (in section 06) when you program your Digital Display.

Power Factor = (usually 1.0 Kh)

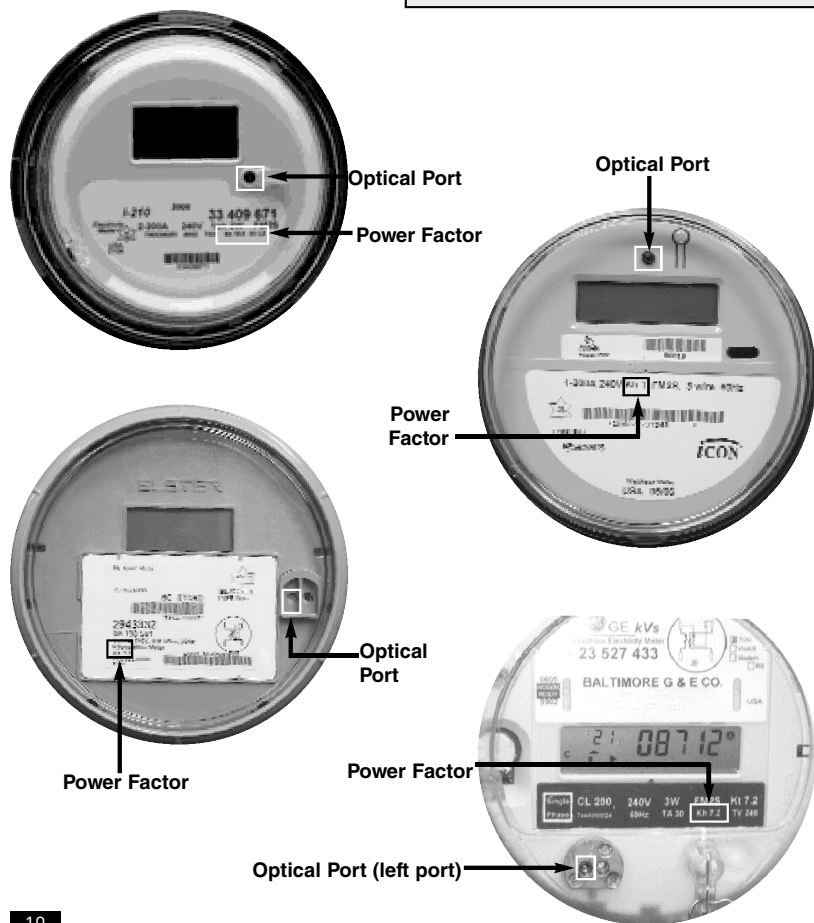

03 INSTALLING YOUR METER SENSOR TYPE 2—ELECTRONIC WITH OPTICAL PORT ON FACE

B. Prepare Your Meter Sensor

Make sure the batteries are installed in the Meter Sensor.

1. Pull the Sensor Arm Latch Cover upward to open it.
2. Verify that the Sensor Arm is pushed in as far as it will go into the body of the Meter Sensor.
3. Close the Sensor Arm Latch Cover.
4. Verify that the Sensor Arm is fully pushed in.

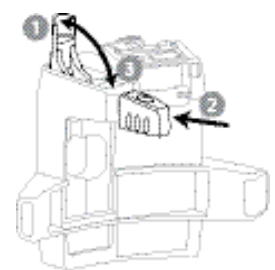

Note: If the optical port is closer than 1.5 inches to the edge of the glass housing, you will need to add a rubber shim to the Sensor. If the port is farther than 1.5 inches from the edge, you can skip steps 5-7.

5. Peel off the adhesive backing from the shim.
6. Position the shim on the underside of the Meter Sensor with the adhesive side down.
7. Press the shim in place onto the underside of the Meter Sensor body.

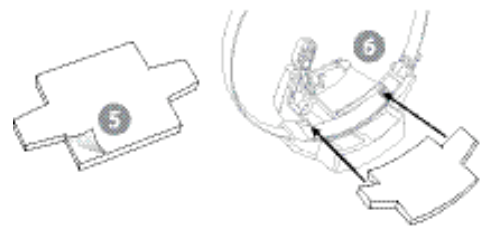
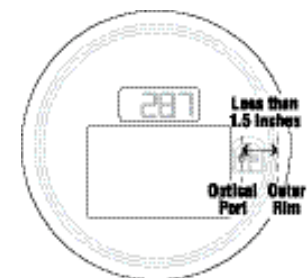

Ruler



03 INSTALLING YOUR METER SENSOR TYPE 2—ELECTRONIC WITH OPTICAL PORT ON FACE

C. Install Your Meter Sensor

1. Wipe the meter dome clean with the damp cloth.
2. Fit the Meter Sensor over your utility meter as shown, so that the Sensor Head sits as close as possible to the front of the glass dome.
3. Tighten the clamp until the Meter Sensor is snug, but can move just enough to allow for slight adjustments.
4. Position the Sensor Arm as shown to the right:

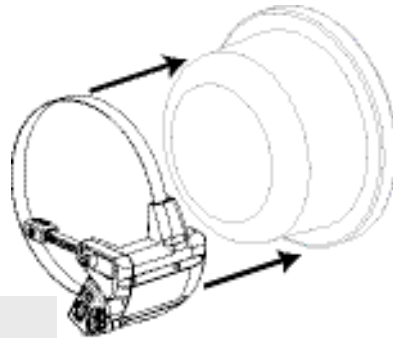

Note: The LED at the end of the Sensor Arm must be positioned directly over the optical port on the meter.

Note: If your electric meter has two optical ports, align the sensor with the one on the left.

5. Press the RESET button. The STATUS Indicator will light solid red while the Meter Sensor looks for a signal from the meter.
6. When you have positioned the Sensor Head correctly, the red STATUS Indicator starts flashing regularly, indicating that the Sensor has detected the signal from your meter. Within one minute, in addition to the regular flashing, you should see an extra flash now and then, depending on your rate of electricity consumption. These extra flashes are normal, and indicate that the Sensor is reading the meter's output correctly.



Status Light Indicator

- NOTE:** To maximize battery life, the indicator stops flashing after about two minutes.
7. Tighten the clamp just enough so that the Meter Sensor cannot move.



Installation is complete! Go to Section 4.

03 INSTALLING YOUR METER SENSOR TYPE 3—ELECTRONIC WITH OPTICAL PORT ON TOP

A. Record Your Meter's Power Factor

Find and record your meter's Power Factor. On the face of the meter, look for a number preceded by the letters Kh, Ks, or Kt. This number is usually 1.0 for an electronic meter. If your meter lists more than one of these numbers, look for the smallest number. Write this number in the box below. You will need it later (in section 06) when you program your Digital Display.

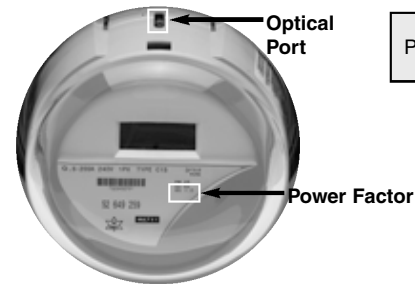

Power Factor = (usually 1.0 Kh)

B. Prepare Your Meter Sensor

Make sure the batteries are installed in the Meter Sensor. For this type of meter, you need to reconfigure the Sensor.

1. Use a flat-head screwdriver to open the clamping strap all the way until it opens. Remove the strap from the Sensor body.
2. Pull the Sensor Arm Latch Cover up to unlock the arm as shown (2).
3. Pull the Sensor Arm completely out of the body until it is completely detached, connected only by the wire (3). You may need to pull hard.

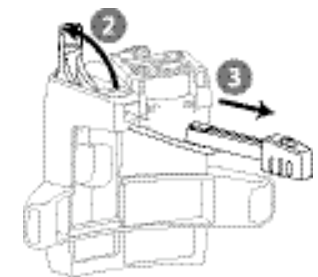
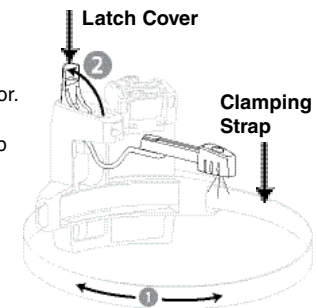

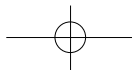

4. Turn the Sensor Arm so that the two Sensor LEDs are visible (4). They need to be able to see the Optical Port on the meter.

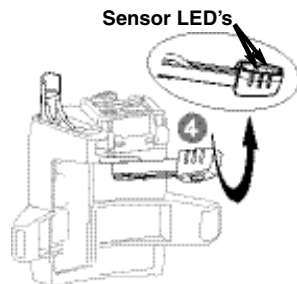

5. Push the smaller end of the Sensor Arm upwards through the latch opening and press the Sensor Arm firmly into the cavity (5).

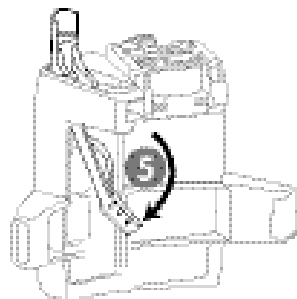

6. Slide the Sensor Arm as far down as it will go into the bottom cavity of the body. If necessary, use a dull pointed object, such as a ballpoint pen, to push it all the way down (6). The two Sensor LEDs must be visible.
7. Tuck the wire into the side cavity (7).
8. Close the latch (8).
9. Rethread the clamping strap into the sensor housing and reattach the ends. Turn the screw as you feed in the end to reattach it.

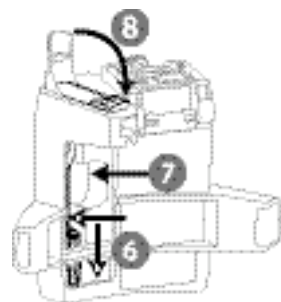

03 INSTALLING YOUR METER SENSOR TYPE 3—ELECTRONIC WITH OPTICAL PORT ON TOP

C. Install Your Meter Sensor

The objective of this step is to align the Sensor LEDs directly over the optical port on the meter.

- Stand directly in front of your electric meter, at a height where you can see the optical port. The optical port itself looks like a small protruding pipe in the center of the top portion of the electric meter. Carefully wipe the meter dome clean with the damp cloth.
- Peel the adhesive backing off of the template. Hold the template with the protruding tab facing you and the arrow pointing away from you.
- Stick the template onto the meter with the arrow pointing at, but not covering the optical port. You can peel the template off the glass and realign it if necessary.
- Align the edges of the sensor with the white side lines on the template. Slide the Meter Sensor over the glass dome as far as it will go.
- Tighten the clamp until the Meter Sensor is snug, but can move just enough to allow for adjustments.
- Open the Sensor Arm Latch Cover and look down the opening. You'll see a vertical plastic tab painted white on the inside of the Sensor body.
- Look through the opening and confirm that the tip of the white plastic tab on the Sensor is lined up with the arrow line on the template. Adjust the position of the sensor if necessary.
- Press the RESET button. Within 10 seconds, the STATUS indicator will light solid red while the Meter Sensor looks for a signal from the meter. When the Sensor is correctly aligned, the Status indicator will blink.

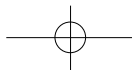
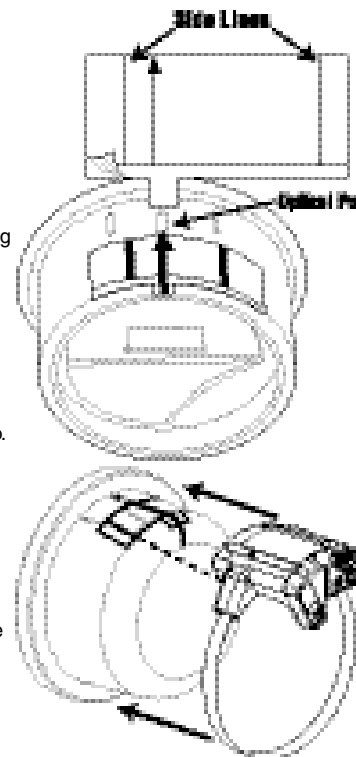

03 INSTALLING YOUR METER SENSOR TYPE 3—ELECTRONIC WITH OPTICAL PORT ON TOP

- You may need to slide the Sensor toward you until the Sensor LEDs are directly over the optical port on the meter.
If the STATUS indicator does not begin to blink within one minute, continue to reposition the Sensor until you have proper alignment.

NOTE: To maximize battery life, the indicator stops flashing after about two minutes.

- When the STATUS light begins to blink, tighten the clamping strap tight so the sensor cannot move. Close the latch.

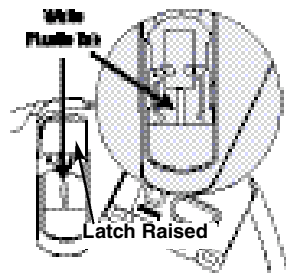

Installation is complete! Go to Section 4, Synchronize Meter Sensor.

The data appearing on your screen is an accurate measure of your electricity consumption. To see an accurate measure of your electricity cost, follow the next section to program your billing rates.

If numbers are not appearing on your screen after 2 minutes, go to section 11, Troubleshooting and Q&A.

Now, you can go indoors and, referring to your electric bill, program your billing rates into the Digital Display.







If there is a problem, please read the Troubleshooting section in this Instruction Manual.

04 SYNCHRONIZE METER SENSOR AND DIGITAL DISPLAY

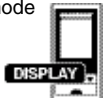

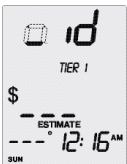
The prog/sync button on top of the Digital Display is used to enter Program Mode and to enter data for each programming step.

The Reset Button is located on the front of the Meter Sensor, adjacent to the Status Indicator.

| STEP | ACTION/PRESS | DISPLAY |
|---|---|---|
| Put Digital Display into ID mode  |  Press and hold until you hear two (2) beeps. | Beep! Beep!  |
| Reset Meter Sensor  |  Digital Display will beep. | Beep!  <i>Data will appear within two (2) minutes.</i> |

05 DETERMINE BILLING MODE AND BILLING RATE

In order to display the cost of your electricity, you need to program the Digital Display with information from your electricity bill.

There are three ways you may be billed for electricity:

- Flat Rate. See example on page 18**
You are charged the same amount per kilowatt-hour (kWh) no matter how much you use or what time of day you use it.
- Tiered Rates. See example on page 20**
You are charged one rate for an initial number of kilowatt-hours, then a higher rate if you exceed that threshold. There may be several thresholds.
- Time-of-Use Rates. See example on page 23**
You are charged a different rate depending on the time of day. There may be two rates (on-peak and off-peak) or three rates (on-peak, mid-peak, and off-peak).

Get a recent electric bill and determine how you are charged. Then, go to the appropriate page and fill out the form with your billing information. This will make it easier to program your Power Monitor.

05 DETERMINE BILLING MODE AND BILLING RATE

Flat Rate Billing – Example

Note: Rates can differ in winter and summer.

| Electric Bill | | | |
|---|------------------|----------------------------|-----------------|
| Electric Details | | Non-Summer Rates in Effect | |
| Residential – Schedule R | | | |
| Billing Period: Feb 27, 2008 - Mar 28, 2008 | | Days Billed: 30 | |
| Meter read on March 28 | | | |
| Current Reading | Previous Reading | kWh Used | |
| 6181 | - 4896 | = | 1435 |
| Electric Supply | 1435 kWh | x .10672000 | 153.14 |
| Electric Delivery Service | | | |
| Customer Charge | | | 7.50 |
| Distribution charge | 1435 kWh | x .02517000 | 36.12 |
| RSP Chg/Misc Credit | 1435 kWh | x .00218000 | 3.18 |
| State/Local Taxes & Surcharges | | | |
| MD Universal Svc Prog | | | .37 |
| State Surcharge | 1435 kWh | x .00014600 | .21 |
| Franchise Tax | 1435 kWh | x .00062000 | .89 |
| Total Electric Amount | | | \$201.36 |

The sum of these rates is your total cost per kilowatt-hour (kWh). In this example, add them to get a total rate of \$0.1348 per kilowatt-hour. Then multiply by 100 to convert to 13.48 c/kWh

RECORD YOUR BILLING RATE HERE

Billing Rate: = c/kWh

05 DETERMINE BILLING MODE AND BILLING RATE

Flat Rate Billing – Determine Your Billing Rate

Now refer to your own electric bill. Find your billing rate. If applicable, add fees and taxes to your base rate to obtain an accurate total billing rate, as shown in the example.

If your rate is in dollars per kilowatt-hour (\$/kWh), you will need to multiply by 100 to convert it to cents per kilowatt-hour (¢/kWh).

RECORD YOUR BILLING RATE HERE

Billing Rate: = ¢/kWh

Go to Section 6, Program Digital Display.

05 DETERMINE BILLING MODE AND BILLING RATE

Tiered Rate Billing – Example

If you have tiered billing, you are charged an initial rate for an initial amount of power, or tier; then a higher rate if you exceed that initial amount. Your billing plan may have several tiers.

You will need to determine the rate and threshold for each billing tier. Refer to the example below:

Example of a three-tier billing plan

Similar information will be available from your utility; call or consult their web site if this information is not on your bill.

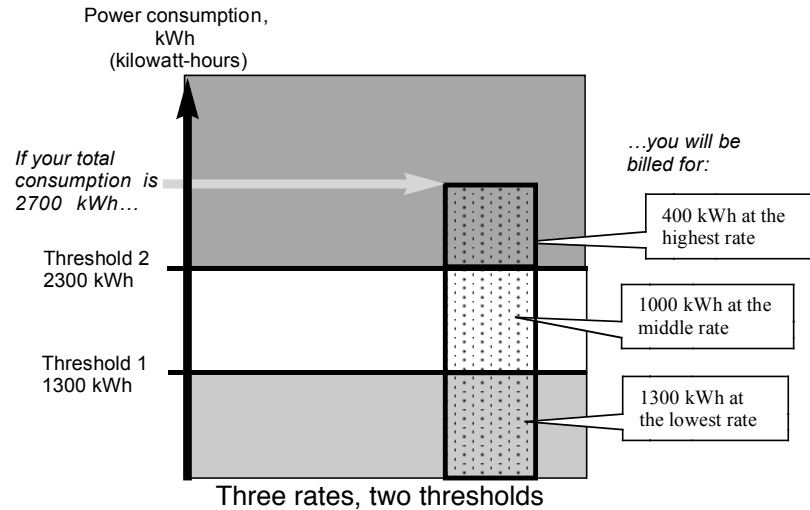

Example bill for this three-tier billing plan:

| ELECTRIC BILL | | | |
|--|------------------------------|--------------------|-----------------|
| Besides the cost of the electricity itself, your bill may have additional charges, fees, and taxes that are linked to your amount of consumption | Generation charges per kWh | 1300 kWh X \$.0500 | \$ 65 |
| | Generation charges per kWh | 1000 kWh X \$.1000 | \$100 |
| | Generation charges per kWh | 400 kWh X \$.1500 | \$ 60 |
| | Transmission charges per kWh | 1300 kWh X \$.0200 | \$ 26 |
| | Transmission charges per kWh | 1000 kWh X \$.0500 | \$ 50 |
| | Transmission charges per kWh | 400 kWh X \$.0700 | \$ 28 |
| | Public benefits fees per kWh | 1300 kWh X \$.0050 | \$ 6.50 |
| | Public benefits fees per kWh | 1000 kWh X \$.0100 | \$ 10 |
| | Public benefits fees per kWh | 400 kWh X \$.0200 | \$ 6 |
| | TOTAL CHARGES | | \$351.50 |

The lowest rate is the Tier 1 rate.
 Add all the Tier 1 charges to get a total of \$0.075/kWh.
 Multiply by 100 to get **7.5¢/kWh**.
 The Tier 1 threshold is **1300 kWh**.

The middle rate is the Tier 2 rate.
 Add all the Tier 2 charges to get a total of \$0.16/kWh.
 Multiply by 100 to get **16¢/kWh**.
 The Tier 2 threshold is 1300 kWh + 1000 kWh = **2300 kWh**.

The highest rate is the Tier 3 rate.
 Add all the Tier 3 charges to get a total of \$0.24/kWh.
 Multiply by 100 to get **24¢/kWh**.
 There is no threshold for Tier 3.

For this example, you would record your billing data in the form like this:

| RECORD YOUR BILLING RATES AND THRESHOLDS HERE | | | |
|---|--------------|----------|-----------|
| | BILLING RATE | | THRESHOLD |
| Tier 1 | 7.5 ¢/kWh | 1300 kWh | |
| Tier 2 | 16 ¢/kWh | 2300 kWh | |
| Tier 3 | 24 ¢/kWh | | |
| Tier 4 | | | |
| Tier 5 | | | |
| Tier 6 | | --- | |

05 DETERMINE BILLING MODE AND BILLING RATE

**Tiered Rate Billing
Determine Your Billing Rates and Thresholds**

Now refer to your own electric bill. Find your tiered billing rates, and the corresponding threshold(s) in kilowatt-hours (kWh). If applicable, add fees and taxes to each tiered base rate to obtain accurate total billing rates, as shown in the example.

If your rates are in dollars per kilowatt-hour (\$/kWh), you will need to multiply by 100 to convert them to cents per kilowatt-hour (¢/kWh).

Enter the Billing Rates and Thresholds from your electric bill in the table below. The POWER MONITOR allows for up to six different tiered rates.

| RECORD YOUR BILLING RATES AND THRESHOLDS HERE | | |
|---|----------------------------|--------------------------|
| | BILLING RATE | THRESHOLD |
| Tier 1 | <input type="text"/> ¢/kWh | <input type="text"/> kWh |
| Tier 2 | <input type="text"/> ¢/kWh | <input type="text"/> kWh |
| Tier 3 | <input type="text"/> ¢/kWh | <input type="text"/> kWh |
| Tier 4 | <input type="text"/> ¢/kWh | <input type="text"/> kWh |
| Tier 5 | <input type="text"/> ¢/kWh | <input type="text"/> kWh |
| Tier 6 | <input type="text"/> ¢/kWh | <input type="text"/> kWh |

Go to Section 6, Program Digital Display.

05 DETERMINE BILLING MODE AND BILLING RATE

Time-of-Use Rate Billing – Example

If you have Time of Use (TOU) billing, you are charged a different rate depending on the time of day. There may be two rates (on-peak and off-peak) or three rates (on-peak, mid-peak, and off-peak). In addition, weekends and holidays may be charged at a single rate regardless of the time of day. The Power Monitor allows the entry of up to 6 time slots.

Example of a Time-of-Use billing plan:

Similar information will be available from your utility; call or consult their web site if this information is not on your bill.

Typical Time Slots for Time-of-Use Billing

Billing Period: Boxed times need to be programmed into the Display.

Peak - Between the hours of am and pm on weekdays, excluding the National holidays listed below.

Intermediate - Between the hours of am and am, and the hours of pm and pm on weekdays, excluding the National holidays listed below.

Off-Peak - All times other than those defined for the On-Peak and Intermediate-Peak rating periods. Off-Peak rates are in effect all hours on Saturday and Sunday, and on all holidays.

05 DETERMINE BILLING MODE AND BILLING RATE

Time-of-Use Rate Billing – Example

Example bill for a three-rate Time-of-Use plan:

ELECTRIC BILL

| | | | | | | | | | | | | | | | | | | | | | | | | | | | | |
|---|---|---|--------------------|-------|--------------------|-------|-------------------|-------|--|--|--------------------|-------|--------------------|-------|-------------------|-------|--|--|--------------------|---------|--------------------|-------|-------------------|------|--|--|-----------------|--|
| Besides the cost of the electricity itself, your bill may have additional charges, fees, and taxes that are linked to your amount of consumption. | Generation charges per kWh Generation charges per kWh Generation charges per kWh Transmission charges per kWh Transmission charges per kWh Transmission charges per kWh Public benefits fees per kWh Public benefits fees per kWh Public benefits fees per kWh TOTAL CHARGES | <table border="0" style="width: 100%;"> <tr> <td>1300 kWh X \$.0500</td> <td>\$ 65</td> </tr> <tr> <td>1000 kWh X \$.1000</td> <td>\$100</td> </tr> <tr> <td>400 kWh X \$.1500</td> <td>\$ 60</td> </tr> <tr> <td colspan="2"> </td> </tr> <tr> <td>1300 kWh X \$.0200</td> <td>\$ 26</td> </tr> <tr> <td>1000 kWh X \$.0500</td> <td>\$ 50</td> </tr> <tr> <td>400 kWh X \$.0700</td> <td>\$ 28</td> </tr> <tr> <td colspan="2"> </td> </tr> <tr> <td>1300 kWh X \$.0050</td> <td>\$ 6.50</td> </tr> <tr> <td>1000 kWh X \$.0100</td> <td>\$ 10</td> </tr> <tr> <td>400 kWh X \$.0200</td> <td>\$ 6</td> </tr> <tr> <td colspan="2"> </td> </tr> <tr> <td colspan="2" style="text-align: right;">\$351.50</td> </tr> </table> | 1300 kWh X \$.0500 | \$ 65 | 1000 kWh X \$.1000 | \$100 | 400 kWh X \$.1500 | \$ 60 | | | 1300 kWh X \$.0200 | \$ 26 | 1000 kWh X \$.0500 | \$ 50 | 400 kWh X \$.0700 | \$ 28 | | | 1300 kWh X \$.0050 | \$ 6.50 | 1000 kWh X \$.0100 | \$ 10 | 400 kWh X \$.0200 | \$ 6 | | | \$351.50 | |
| 1300 kWh X \$.0500 | \$ 65 | | | | | | | | | | | | | | | | | | | | | | | | | | | |
| 1000 kWh X \$.1000 | \$100 | | | | | | | | | | | | | | | | | | | | | | | | | | | |
| 400 kWh X \$.1500 | \$ 60 | | | | | | | | | | | | | | | | | | | | | | | | | | | |
| | | | | | | | | | | | | | | | | | | | | | | | | | | | | |
| 1300 kWh X \$.0200 | \$ 26 | | | | | | | | | | | | | | | | | | | | | | | | | | | |
| 1000 kWh X \$.0500 | \$ 50 | | | | | | | | | | | | | | | | | | | | | | | | | | | |
| 400 kWh X \$.0700 | \$ 28 | | | | | | | | | | | | | | | | | | | | | | | | | | | |
| | | | | | | | | | | | | | | | | | | | | | | | | | | | | |
| 1300 kWh X \$.0050 | \$ 6.50 | | | | | | | | | | | | | | | | | | | | | | | | | | | |
| 1000 kWh X \$.0100 | \$ 10 | | | | | | | | | | | | | | | | | | | | | | | | | | | |
| 400 kWh X \$.0200 | \$ 6 | | | | | | | | | | | | | | | | | | | | | | | | | | | |
| | | | | | | | | | | | | | | | | | | | | | | | | | | | | |
| \$351.50 | | | | | | | | | | | | | | | | | | | | | | | | | | | | |

The lowest rate is the Off-Peak rate.

Add all the Off-Peak charges to get a total of \$0.075/kWh.

Multiply by 100 to get 7.5 c/kWh.

The middle rate is the Mid-Peak rate.

Add all the Mid-Peak charges to get a total of \$0.16/kWh.

Multiply by 100 to get 16 c/kWh.

The highest rate is the On-Peak rate.

Add all the On-Peak charges to get a total of \$0.24/kWh.

Multiply by 100 to get 24 c/kWh.

05 DETERMINE BILLING MODE AND BILLING RATE

Time-of-Use Rate Billing – Example

For the example, you would record your billing data as follows:

RECORD YOUR BILLING RATES AND TIME SLOTS HERE

| | | | |
|---------------|-----|-------|--|
| OFF Peak Rate | 7.5 | c/kWh | Time-of-Use billing applies to: <input checked="" type="checkbox"/> Weekdays <input type="checkbox"/> Weekends |
| MID Peak Rate | 16 | c/kWh | |
| ON Peak Rate | 24 | c/kWh | |

BILLING SCHEDULE

| SLOT | START TIME | | RATE TYPE |
|------|------------|---|---|
| 1 | 7 | <input checked="" type="checkbox"/> AM <input type="checkbox"/> PM | <input type="checkbox"/> ON PEAK <input checked="" type="checkbox"/> MID PEAK <input type="checkbox"/> OFF PEAK |
| 2 | 10 | <input checked="" type="checkbox"/> AM <input type="checkbox"/> PM | <input checked="" type="checkbox"/> ON PEAK <input type="checkbox"/> MID PEAK <input type="checkbox"/> OFF PEAK |
| 3 | 8 | <input type="checkbox"/> AM <input checked="" type="checkbox"/> PM | <input type="checkbox"/> ON PEAK <input checked="" type="checkbox"/> MID PEAK <input type="checkbox"/> OFF PEAK |
| 4 | 11 | <input type="checkbox"/> AM <input checked="" type="checkbox"/> PM | <input type="checkbox"/> ON PEAK <input type="checkbox"/> MID PEAK <input checked="" type="checkbox"/> OFF PEAK |
| 5 | - - - | <input type="checkbox"/> AM <input type="checkbox"/> PM | <input type="checkbox"/> ON PEAK <input type="checkbox"/> MID PEAK <input type="checkbox"/> OFF PEAK |
| 6 | - - - | <input type="checkbox"/> AM <input type="checkbox"/> PM | <input type="checkbox"/> ON PEAK <input type="checkbox"/> MID PEAK <input type="checkbox"/> OFF PEAK |

05 DETERMINE BILLING MODE AND BILLING RATE

Time-of-Use Rate Billing

Determine Your Billing Rates and Time Slots

Now refer to your own electric bill. Find your Time-of-Use billing rates, and the corresponding time slots. Also, determine if your Time-of-Use billing applies on weekends. If applicable, add fees and taxes to each base rate to obtain accurate total billing rates, as shown in the example.

If your rates are in dollars per kilowatt-hour (\$/kWh), you will need to multiply by 100 to convert them to cents per kilowatt-hour (¢/kWh).

Enter the Billing Rates and Time Slots from your electric bill in the table below.

The Power Monitor allows for two or three different Time-of-Use Rates and up to six different Time Slots.

| RECORD YOUR BILLING RATES AND TIME SLOTS HERE | | | |
|---|---|---|---|
| OFF Peak Rate | <input type="text"/> | ¢/kWh | Time-of-Use billing applies to: <input type="checkbox"/> Weekdays <input type="checkbox"/> Weekends |
| MID Peak Rate | <input type="text"/> | ¢/kWh | |
| ON Peak Rate | <input type="text"/> | ¢/kWh | |
| BILLING SCHEDULE | | | |
| SLOT | START TIME | RATE TYPE | |
| 1 | <input type="text"/> <input type="checkbox"/> AM <input type="checkbox"/> PM | <input type="checkbox"/> ON PEAK <input type="checkbox"/> MID PEAK | <input type="checkbox"/> OFF PEAK |
| 2 | <input type="text"/> <input type="checkbox"/> AM <input type="checkbox"/> PM | <input type="checkbox"/> ON PEAK <input type="checkbox"/> MID PEAK | <input type="checkbox"/> OFF PEAK |
| 3 | <input type="text"/> <input type="checkbox"/> AM <input type="checkbox"/> PM | <input type="checkbox"/> ON PEAK <input type="checkbox"/> MID PEAK | <input type="checkbox"/> OFF PEAK |
| 4 | <input type="text"/> <input type="checkbox"/> AM <input type="checkbox"/> PM | <input type="checkbox"/> ON PEAK <input type="checkbox"/> MID PEAK | <input type="checkbox"/> OFF PEAK |
| 5 | <input type="text"/> <input type="checkbox"/> AM <input type="checkbox"/> PM | <input type="checkbox"/> ON PEAK <input type="checkbox"/> MID PEAK | <input type="checkbox"/> OFF PEAK |
| 6 | <input type="text"/> <input type="checkbox"/> AM <input type="checkbox"/> PM | <input type="checkbox"/> ON PEAK <input type="checkbox"/> MID PEAK | <input type="checkbox"/> OFF PEAK |

Go to Section 6, Program Digital Display.

06 PROGRAM DIGITAL DISPLAY - TIME, DAY, TEMPERATURE, POWER FACTOR, BILLING MODE







The prog/sync button on top of the Digital Display is used to enter Program Mode and to enter data for each programming step.









If the Digital Display detects no activity for one minute while in Program Mode, it will automatically save your data and exit to Display Mode. Also, you can exit Program Mode at any point by holding prog/sync for three seconds.

The Δ ∇ buttons change the value on the screen. To make the numbers change faster, you can hold the button down continuously until you reach the desired number. If you enter a wrong value and accidentally save it, you can exit Program Mode. Then go back into Program Mode and step through each entry until you get to the one you need to fix. Any data you've already entered will be saved.

Follow these steps to program the Digital Display with your Power Factor (which you recorded in section 03 Installing Your Meter Sensor), your Electric Bill information, and display preferences.

| STEP | ACTION/PRESS | DISPLAY |
|---|--|--|
| Put Digital Display into Program mode |  Hold three seconds until you hear one beep. | Beep! TIER 12:00 ^{AM} |
| Set current time. Set hours and AM/PM. Set minutes. | Δ ∇  Δ ∇  | TIER 10:20 ^{PM} 10:20 ^{PM} |
| Set clock for 12 Hr (regular time) or 24 Hr (military time). | Δ ∇  | TIER 12:4r |
| Continue on the top of the next page. | | |

06 PROGRAM DIGITAL DISPLAY - TIME, DAY, TEMPERATURE, POWER FACTOR, BILLING MODE









| STEP | ACTION/PRESS | DISPLAY |
|--|--|---|
| Set day of the week. |  prog/sync |  |
| Set temperature units. |  prog/sync |  |
| Find your Power Factor (the number you recorded in section 03 Installing Your Meter Sensor). Power Factor = <input type="text"/> (usually 72 Kh) | | |
| Enter your Power Factor. Typical Power Factors are: 7.2 for electromechanical meters 1.0 for electronic meters with optical ports |  prog/sync |  |
| Enter your Billing Mode: TIER for Flat or Tiered rates 2-PEAK for Time-of-Use with two rates 3-PEAK for Time-of-Use with three rates |  prog/sync |  |

If your billing mode is Flat Rate, proceed to section 07.

If your billing mode is Tiered Rate, proceed to section 08.

If your billing mode is Time-of-Use Rate, proceed to section 09.

07 PROGRAM DIGITAL DISPLAY - FLAT RATE BILLING

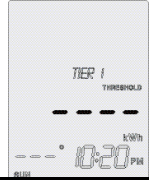
| STEP | ACTION/PRESS | DISPLAY |
|--|--|---|
| Find the Billing Rate you recorded in section 05. |  prog/sync |  |
| Enter your Billing Rate. To make the numbers change faster, you can press and hold the  or  . |  prog/sync |  |
| Do NOT enter a threshold. Press the  button until you see dashes appear on the Digital Display. |  prog/sync |  |
| Programming is complete! | | |

Go to Section 10, Using Your Power Monitor.

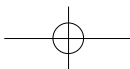

08 PROGRAM DIGITAL DISPLAY – TIERED RATE BILLING

Note: Before you begin programming your Digital Display for Tiered Rate Billing, you will need to refer to the Billing Rates and Thresholds you recorded in section 05.

| STEP | ACTION/PRESS | DISPLAY |
|---|---------------|---------|
| Enter Billing Rate for Tier 1. To make the numbers change faster, you can press and hold the or . | prog/sync | |
| Enter Threshold 1. | prog/sync | |
| Enter Billing Rate for Tier 2. | prog/sync | |
| Enter Threshold 2. | prog/sync | |
| If there is a Tier 3, enter Billing Rate for Tier 3. | prog/sync | |
| Continue on the top of the next page. | | |

08 PROGRAM DIGITAL DISPLAY – TIERED RATE BILLING

Note: Before you begin programming your Digital Display for Tiered Rate Billing, you will need to refer to the Billing Rates and Thresholds you recorded in section 05.

| STEP | ACTION/PRESS | DISPLAY |
|--|---------------|---------|
| If there is no Tier 3, Press until you see dashes. | prog/sync | |
| If you have additional tiers and thresholds, continue to enter Billing Rates for each tier and enter each threshold. | | |
| Programming is complete! | | |

Go to Section 10, Using Your Power Monitor.

09 PROGRAM DIGITAL DISPLAY – TIME-OF-USE RATE BILLING

Note: Before you begin programming your Digital Display for Time-of-Use Rate Billing, you will need to refer to the Billing Rates and Time Slots you recorded in section 05.

| STEP | ACTION/PRESS | DISPLAY |
|---|------------------------------------|---------|
| Select whether Time-of-Use Billing applies on weekends. Note: Flashing SUN and SAT indicate Time-of-Use Billing DOES NOT apply on weekends. | prog/sync | |
| Enter Off-Peak Billing Rate. To make the numbers change faster, you can press and hold the or . | prog/sync | |
| For Three Rate (3-PEAK) Billing only: Enter Mid-Peak Billing Rate. | prog/sync | |
| Enter On-Peak Billing Rate. | prog/sync | |
| Enter start time for first Time Slot. Enter hours. Then enter minutes. | prog/sync prog/sync | |
| Continue on the top of the next page. | | |

09 PROGRAM DIGITAL DISPLAY – TIME-OF-USE RATE BILLING

Note: Before you begin programming your Digital Display for Time-of-Use Rate Billing, you will need to refer to the Billing Rates and Time Slots you recorded in section 05.

| STEP | ACTION/PRESS | DISPLAY |
|--|------------------------------------|---------|
| Select which Rate Type applies to the first Time Slot. | prog/sync | |
| Enter start time for second Time Slot. Enter hours. Then enter minutes. | prog/sync prog/sync | |
| Select which Rate Type applies to the second Time Slot. | prog/sync | |
| Continue this process to enter data for all Time Slots from your billing schedule in section 05. If you have fewer than 6 time slots, hold down prog/sync to exit Program Mode. | | Beep! |
| Programming is complete! | | |

Go to Section 10, Using Your Power Monitor.

10 USING YOUR POWER MONITOR

The Power Monitor will show you:

- Your current electricity usage
- The usage of a single electric appliance
- Your accumulated electricity usage over an hour, a day, or any time period
- Your estimated monthly usage

Press the \$/kW button to cycle between Cost and Power views

Cost View

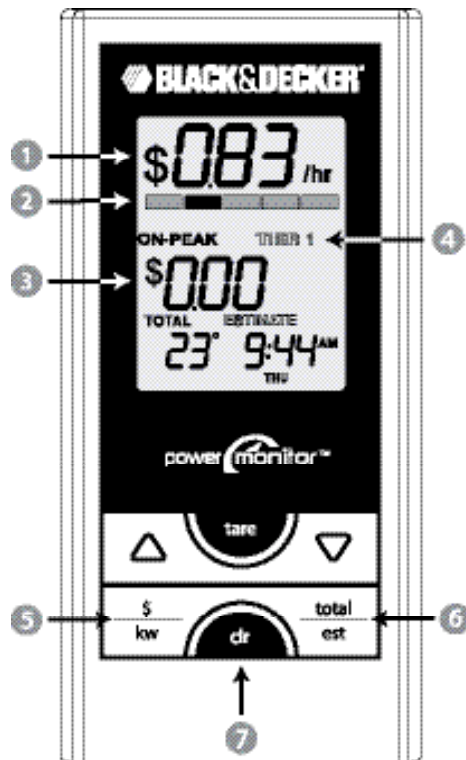

- 1 The cost per hour, updated every 30 seconds. This value changes as you turn appliances on and off.
- 2 Bars move faster as consumption increases.
- 3 Displays either the total accumulated cost since hitting clr, or an estimate of your monthly cost.
- 4 For tiered or time-of-use billing, displays the tier or time slot. Press to switch between Cost View and Power View.
- 5 Press to switch between Total Cost and Estimated Monthly Cost. The Estimated
- 6 Monthly Cost is scaled from the Total Cost.
- 7 Push and hold until the beep to clear the Total Cost.

10 USING YOUR POWER MONITOR

Press the \$/kW button to cycle between Cost and Power views

Power View

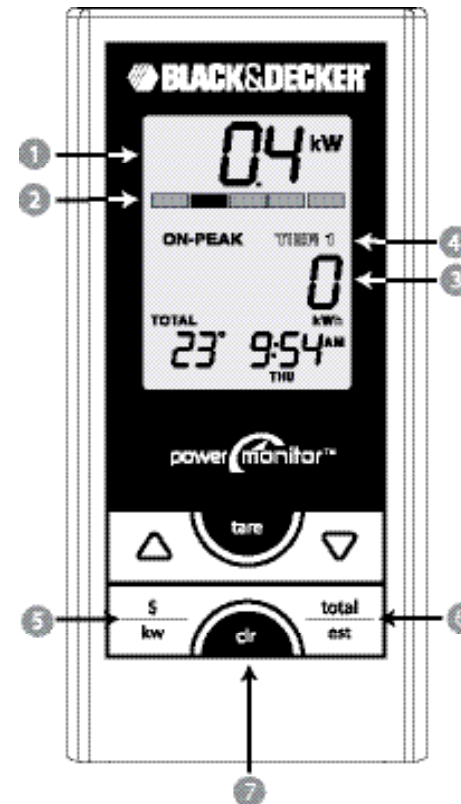



- 1 The kilowatts currently consumed, updated every 30 seconds. This value changes as you turn appliances on and off.
- 2 Bars move faster as consumption increases.
- 3 Displays either the total consumed energy since hitting clr, or an estimate of your monthly energy use in kilowatt-hours.
- 4 For tiered or time-of-use billing, displays the tier or time slot.
- 5 Press to switch between Cost View and Power View.
- 6 Press to switch between Total Consumption and Estimated Monthly Consumption. The Estimated Monthly Consumption is scaled from the Total Consumption.
- 7 Push and hold until the beep to clear the Total Consumption.

10 USING YOUR POWER MONITOR

Measure the Consumption of a Single Appliance with Tare

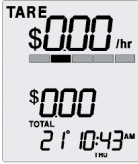
Note: Tare mode works in both Cost and Power views. Total consumption is not affected by Tare mode.

| STEP | ACTION/PRESS | DISPLAY |
|---|---|---|
| Note - If another appliance, like a sump pump or refrigerator compressor turns on while in Tare mode, your measurement will not be accurate. | | |
| Press the tare Button. |  |  |
| Turn on the appliance you wish to measure. The tare indicator is displayed in the top row and, after a few more minutes, the values displayed represent the energy currently consumed by that particular appliance. The display updates every 30 seconds. | |  |
| Press the tare button to return to normal mode. |  | |

The minimum power value the display can show is 0.1 kW (100 Watts). Therefore, you might not be able to measure the consumption of a low-power appliance, like a single light bulb.

Now, the Black & Decker Power Monitor is ready to work for you.

Feedback on your electricity consumption will help you change your energy habits, resulting in lower electricity bills. Many households have saved up to 20% off their electricity bills by using the Power Monitor (see www.blackanddecker.com for more information on these studies).

We recommend these steps after Power Monitor setup:

1. Use the TARE feature to measure the consumption of major appliances.
2. Show the device and your electricity bill to your children. Teach them how much it costs to use the dishwasher, take a long shower, or leave lights on. You will experience the greatest savings when your children learn along with you.
3. Place the Digital Display in a central location, such as the kitchen, where every member of the family will see it and keep their energy consumption top-of-mind. Checking the outside temperature is a great reason to look at it every day.
4. Make your home more energy efficient by sealing thermal leaks, adding insulation, and replacing inefficient appliances. You can learn more about energy-related home improvements from ENERGY STAR®, at www.energystar.gov

Typical power consumption for some household appliances:

| | |
|-------------------------|-------------|
| Television | 150 W |
| Microwave | 1000-2000 W |
| Toaster | 1000 W |
| Hot water heater | 4000 W |
| Central air conditioner | 2000-5000 W |

My Appliances Cost:

| | | |
|--|-------|-------|
| Air conditioner/heat pump | _____ | \$/hr |
| Electric hot water heater for bath or shower | _____ | \$/hr |
| Dishwasher (note if energy-saving mode) | _____ | \$/hr |
| Electric stove | _____ | \$/hr |
| Microwave | _____ | \$/hr |
| Coffee maker | _____ | \$/hr |
| Clothes washer | _____ | \$/hr |
| Electric clothes dryer | _____ | \$/hr |
| Dehumidifier | _____ | \$/hr |
| Humidifier | _____ | \$/hr |
| Pool pump | _____ | \$/hr |

Other Electrical Appliances:

| | | |
|-------|-------|-------|
| _____ | _____ | \$/hr |
| _____ | _____ | \$/hr |
| _____ | _____ | \$/hr |
| _____ | _____ | \$/hr |

11 TROUBLESHOOTING AND Q&A

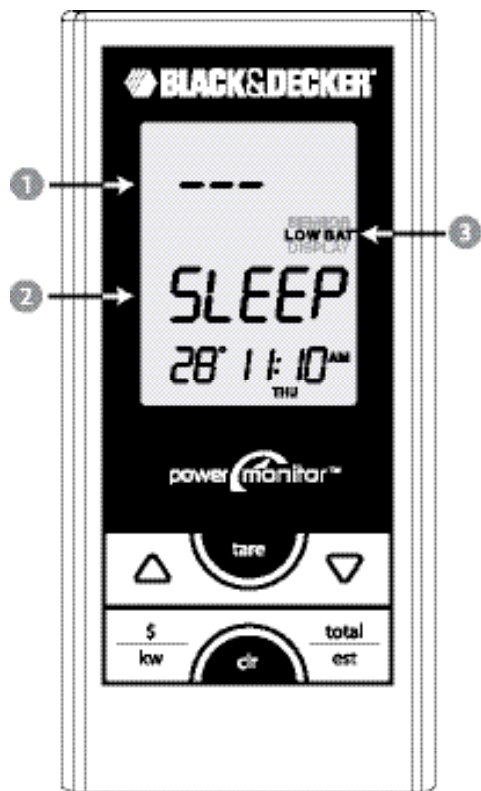

- 1 Dashes and loss of the animated bars indicate the Digital Display has lost contact with the sensor. The battery may be dead or it may be too far away.
- 2 If contact with the Meter Sensor is lost, the Digital Display goes to sleep to save battery life. Change Meter Sensor batteries or move closer to the electric meter, then press any button to wake up and try to regain contact.
- 3 Indicates batteries need to be replaced in the Meter Sensor or the Digital Display.

11 TROUBLESHOOTING AND Q&A

A. I am unsure of my electric meter type. How can I find out which type of meter I have?

The photos in section 03 of the Instruction Manual show the various kinds of electric meters that we have grouped under three types: electromechanical; electronic with optical port on face; electronic with optical port on top.

The majority of existing meters fall under one of these generic types. Determine which photo most closely matches your meter, and remember to follow the installation instructions for that meter type. Also, find the meter's Power Factor on the face of the meter and write it in the box labeled "Power Factor." The Power Factor is a number (usually 1.0 or 7.2) preceded by two letters (usually Kh or Ks or Kt). Proceed with the preparation steps in order and follow the installation instructions for that meter type.

B. After installing the Meter Sensor on my meter and pressing the RESET button, nothing happens. The red indicator does not light up.

The STATUS light in the Sensor should light up solid red within 10 seconds after pressing the RESET switch. If it does not, try these steps:

1. Confirm that the batteries are inserted in the correct orientation. + and – symbols are printed on the green circuit board inside the battery compartment.
2. Confirm that the batteries are not dead. We recommend lithium batteries for longer life in freezing conditions.
3. Confirm that the battery lid is closed and screwed down. The lid has to be fastened down for the batteries to make contact.

C. The red STATUS indicator on my Meter Sensor is flashing rapidly, and I cannot proceed with the installation as described.

The fast flashing indicates that the Meter Sensor has not received a signal from the meter, or can not see the rotating meter wheel, after 20 minutes of trying. Follow the steps in Section 3 to make sure the Sensor is properly aligned on your meter. Then press the RESET button. The indicator will turn off and light up again after 10 seconds. You can then proceed with the installation normally.

D. My Meter Sensor STATUS LED is flashing regularly, but every now and then, there is an extra flash. Is there anything wrong with my unit?

This is exactly what you should see. Electronic meters produce one single pulse every time you have consumed one watt-hour. When the Meter Sensor first detects a pulse from an electronic meter, the STATUS indicator starts flashing. Thereafter, the indicator keeps on flashing at the same frequency. In addition, it will flash once every time it reads a pulse from your meter, at intervals that vary according to your current rate of electricity consumption. This periodic irregular flashing is absolutely normal.

E. When I try to synchronize my Digital Display and Meter Sensor, the Digital Display keeps showing "id" on the screen.

This indicates that the Digital Display is in ID mode, meaning that it is searching for your Meter Sensor. Press the RESET button on the Meter Sensor. If the Digital Display remains in ID mode, move it to a location between 2 and 10 feet (60 cm to 3m) of the Meter Sensor, and then press the RESET button again.

F. The power usage shown on the Digital Display is low or does not match what it should be.

You may have entered the wrong Power Factor (Kh), which calibrates the Digital Display

11 TROUBLESHOOTING AND Q&A

to your electric meter. Use the tare feature to measure the consumption of your microwave or toaster, and compare the value on the Digital Display to the value marked on the nameplate of the appliance. If the numbers are off by a factor of 2 or more, you need to change the Power Factor. Refer to section 03 in the Instruction Manual. Go out to your electric meter and confirm the Power Factor (sometimes labeled Ks or Kt). On some larger homes, there may be a sticker on the meter indicating that your utility has changed the meter's Power Factor. Then, follow the programming instructions to enter a new value into the Digital Display.

G. The consumption information shown on my Digital Display is not correct and it jumps randomly.

Several factors can affect the accuracy of the information shown on your Digital Display and they all relate to interference. If your neighbor also has a Power Monitor system, you may be receiving their information. In this case, you need to change the Meter Sensor address and re-synchronize the Digital Display. Repeat section 04 in the Instruction Manual, but press and hold the RESET button for five (5) seconds. The Meter Sensor then selects a new address randomly on which to base the synchronization. Wireless devices, such as weather stations or old-style baby monitors and cordless phones, transmit information on frequencies similar to the Power Monitor. If you have a wireless weather station, try turning it off briefly and check to see if the Power Monitor Display returns to normal operation. If it does, then check to see if you can change the weather station's operating channel.

H. The Sensor Battery indicator shows a low battery level, but I installed fresh batteries not long ago.

Regular alkaline batteries can become exhausted very rapidly when it is extremely cold outside. If you are expecting an extended period of temperatures below 32°F (0°C), try using lithium type AA batteries in the Meter Sensor. These batteries are commonly available wherever you can buy batteries and they provide better performance in cold weather.

I. The Meter Sensor appears to have detected my meter properly, but I only see dashes (--) on my Digital Display.

This indicates that the Digital Display is not receiving transmissions from the Meter Sensor. Try these steps, in order:

1. Move the Display closer to the Sensor. The Power Monitor has a range of about 60 ft. (20 m), including transmission through an exterior wall. The range may be less if there are metal walls or beams between the Sensor and the Display. Also, the range may decrease as the batteries in the Sensor lose power, or in extremely cold weather. We recommend lithium batteries for the Sensor if the temperature falls below freezing.
2. Inspect the Meter Sensor. Make sure that the batteries are not dead, and that the Sensor is still properly aligned on the meter. Press the RESET button on the Sensor. The STATUS light should light up solid, then begin flashing slowly (once per revolution for an electro-mechanical meter). Refer to Section 3 if you need to re-align your Sensor.
3. Re-synchronize the Sensor and the Display. Bring the Display to within 2 feet of the Sensor. Press and hold the prog/sync button on the Display until you hear two beeps and the Display says "id". Then press and hold the RESET button on the Sensor for 6 seconds. When you release the RESET button, the Display should beep, and "id" will disappear. After two minutes, the Display should show data.

11 TROUBLESHOOTING AND Q&A

J. My Digital Display is showing SLEEP and dashes. What do I do?

This indicates that the Digital Display is not receiving transmissions from the Meter Sensor, and the Display has gone to sleep to save battery life. Press any button on the Display to wake it up. If the Display does not show data within two minutes, try these steps, in order:

1. Move the Display closer to the Sensor. The Power Monitor has a range of about 60 ft. (20 m), including transmission through an exterior wall. The range may be less if there are metal walls or beams between the Sensor and the Display. Also, the range may decrease as the batteries in the Sensor lose power, or in extremely cold weather. We recommend lithium batteries for the Sensor if the temperature falls below freezing.
2. Inspect the Meter Sensor. Make sure that the batteries are not dead, and that the Sensor is still properly aligned on the meter. Press the RESET button on the Sensor. The STATUS light should light up solid, then begin flashing slowly (once per revolution for an electromechanical meter). Refer to Section 3 if you need to re-align your Sensor.
3. Re-synchronize the Sensor and the Display. Bring the Display to within 2 feet of the Sensor. Press and hold the prog/sync button on the Display until you hear two beeps and the Display says "id". Then press and hold the RESET button on the Sensor for 6 seconds. When you release the RESET button, the Display should beep, and "id" will disappear. After two minutes, the Display should show data.

K. The power usage shown on my Digital Display is not updating or is unusually low.

Try turning on an electric appliance that consumes a large amount of power such as a stove or dryer. If the values on the Digital Display do not start to update within a few minutes, then the Meter Sensor is likely not aligned correctly on your utility meter. Try repeating the appropriate alignment steps described in the Instruction Manual.

L. The temperature shown on the Digital Display does not match weather reports or appears to be incorrect.

The temperature shown on the Digital Display is the ambient temperature at your utility meter; it may vary from other sources, such as TV weather reports, because of distance and other factors. Also, if your utility meter is exposed to direct sunlight during any part of the day, then the reading will be higher than normal. The reading will return to the correct value when the utility meter is in the shade.

M. My Digital Display behaves erratically and shows illogical values.

Should your Digital Display start displaying any unexpected values, reset it to the factory settings by pressing on the prog/sync and clr keys simultaneously. However, doing so will erase all your existing rate entries and you will have to follow the instructions in this Instruction Manual to set up and program your Digital Display again.

N. The total shown on my Digital Display does not match the total shown on my electricity bill.

In order for the two totals to match, you would need to clear the totals on the Digital Display on the exact day and time the utility company reads your meter. In addition, your electricity bill may include fixed fees or taxes that are not proportional to your electric usage. The total amount shown on the Power Monitor is accurate, but is really meant as a reference to indicate how much power you have consumed since you last cleared the totals. For example, if you clear the totals at the beginning of every monthly cycle, then you can use the Power Monitor to compare against your monthly budget.

12 HOW ELECTRICITY IS MEASURED

How Electricity is Measured

Power is the ability to do work. Electric power is measured in Watts (W), and for large values, in kilowatts (1000 Watts, or kW). A typical incandescent light bulb consumes 60 Watts. A typical microwave oven consumes 1 to 2 kilowatts.

Energy is power used over a period of time. Electric energy is measured in kilowatt-hours (kWh). If you leave a 60W light on for one hour, it consumes 60 Watt-hours, or 0.06 kWh. If you leave a 2 kW microwave oven on for 15 minutes, it consumes 0.5 kWh.

13 TECHNICAL SPECIFICATIONS

Power

| | |
|---------|---|
| Display | 2 AA Alkaline Batteries (LR6 or equivalent) |
| Sensor | 2 AA Alkaline Batteries (LR6 or equivalent) 2 AA Lithium Batteries for temperatures consistently below 32°F (0 °C) |

Wireless Communications

| | |
|-------------|---|
| Frequency | 433.92MHz |
| Update Rate | Approximately every 30 seconds |
| Range | Up to 60 ft. (20m) through a single external wall |

Operating Temperature Range

| | |
|---------|--|
| Display | 50°F to 113°F (10°C to 45°C) . For indoor use only |
| Sensor | -40°F to 140°F (-40°C to 60°C) |

Performance

| | |
|-------------------------------------|---|
| Minimum power measurement | 300W |
| Power Resolution | 100W |
| Cumulative Energy Measurement error | <2% for electromechanical meter <0.2% for electronic meter |

FCC INFORMATION

FCC Class B Part 15

This device complies with part 15 of the FCC Rules.

This equipment has been tested and found to comply with the limits for a Class B digital device, pursuant to part 15 of the FCC Rules. These limits are designed to provide reasonable protection against harmful interference in a residential installation. This equipment generates, uses, and can radiate radio frequency energy and, if not installed and used in accordance with the instructions, may cause harmful interference to radio communications. However, there is no guarantee that interference will not occur in a particular installation. If this equipment does cause harmful interference to radio or television reception, which can be determined by turning the equipment off and on, the user is encouraged to try to correct the interference by one or more of the following measures:

- Reorient or relocate the receiving antenna.
- Increase the separation between the equipment and receiver.
- Connect the equipment into an outlet on a circuit different from that to which the receiver is connected.
- Consult the dealer or an experienced radio/TV technician for help.

Industry Canada Certification

Operation is subject to the following two conditions:

- This device may not cause harmful interference, and
- This device must accept any interference received, including interference that may cause undesired operation.

13 TECHNICAL SPECIFICATIONS

Service Information

Black & Decker offers a full network of company-owned and authorized service locations throughout North America. All Black & Decker Service Centers are staffed with trained personnel to provide customers with efficient and reliable power tool service.

Whether you need technical advice, repair, or genuine factory replacement parts, contact the Black & Decker location nearest you.

To find your local service location, refer to the yellow page directory under "Tools—Electric" or call: 1-800-544-6986.

Full Two-Year Home Use Warranty

Black & Decker (U.S.) Inc. warrants this product for two years against any defects in material or workmanship. The defective product will be replaced or repaired at no charge in either of two ways.

The first, which will result in exchanges only, is to return the product to the retailer from whom it was purchased (provided that the store is a participating retailer). Returns should be made within the time period of the retailer's policy for exchanges (usually 30 to 90 days after the sale). Proof of purchase may be required. Please check with the retailer for their specific return policy regarding returns that are beyond the time set for exchanges. The second option is to take or send the product (prepaid) to a Black & Decker owned or authorized Service Center for repair or replacement at our option. Proof of purchase may be required. Black & Decker owned and authorized Service Centers are listed under "Tools-Electric" in the yellow pages of the phone directory and on our website www.blackanddecker.com.

This warranty does not apply to accessories. This warranty gives you specific legal rights and you may have other rights which vary from state to state. Should you have any questions, contact the manager of your nearest Black & Decker Service Center. This product is not intended for commercial use.



Imported by
Black & Decker (U.S.) Inc.,
701 E. Joppa Rd.
Towson, MD 21286 U.S.A.

See 'Tools-
Electric'
- Yellow Pages -
for Service & Sales



Catalog Number EM100B Part No. 90539499 Rev. 1 JUN. 2008
Copyright 2008 Black & Decker (US) Inc. Printed in China

Free Manuals Download Website

<http://myh66.com>

<http://usermanuals.us>

<http://www.somanuals.com>

<http://www.4manuals.cc>

<http://www.manual-lib.com>

<http://www.404manual.com>

<http://www.luxmanual.com>

<http://aubethermostatmanual.com>

Golf course search by state

<http://golfingnear.com>

Email search by domain

<http://emailbydomain.com>

Auto manuals search

<http://auto.somanuals.com>

TV manuals search

<http://tv.somanuals.com>