



Owner's Manual for the Vehicle.
With a quick reference guide
for your convenience.



X5 4.4i

Congratulations, and thank you for choosing a BMW.

Thorough familiarity with your vehicle will provide you with enhanced control and security when you drive it. We therefore have this request:

Please take the time to read this Owner's Manual and familiarize yourself with the information that we have compiled for you before starting off in your new vehicle. It contains important data and instructions intended to assist you in gaining maximum use and satisfaction from the unique range of technical features on your BMW. The manual also contains information on care and maintenance designed to enhance operating safety and contribute to maintaining the value of your BMW throughout an extended service life.

This Owner's Manual should be considered a permanent part of this vehicle. It should stay with the vehicle when sold to provide the next owner with important operating, safety and maintenance information.

This manual is supplemented by a Service and Warranty Information Booklet (US models) or a Warranty and Service Guide Booklet (Canadian models). We recommend that you read this publication thoroughly.

Your BMW is covered by the following warranties:

- New Vehicle Limited Warranty
- Limited Warranty Rust Perforation
- Federal Emissions System Defect Warranty
- Federal Emissions Performance Warranty
- California Emission Control System Limited Warranty

Detailed information about these warranties is listed in the Service and Warranty Information Booklet (US models) or in the Warranty and Service Guide Booklet (Canadian models).

We wish you an enjoyable driving experience.

BMW AG

Notes on the Owner's Manual

We have made every effort to ensure that you are able to find what you need in this Owner's Manual as quickly as possible. The fastest way to find certain topics is by using the detailed index at the end. If you desire an initial overview of your vehicle, this can be found in the first chapter. The detailed list of contents that directly follows the summary of contents is intended to stimulate your curiosity regarding your BMW and to encourage you to read the manual.

Should you wish to sell your BMW at some time in the future, please remember to hand over the Owner's Manual to the new owner; it is part of the vehicle.

If you have any questions, an authorized BMW center will be glad to advise you.

Symbols used



These sections contain vital information – please read the accompanying text passages carefully, both for your own safety and to prevent damage to your BMW. ◀



These passages contain information on special and unique features of your vehicle. ◀



Indicates special information on recycling. ◀

◀ Indicates the end of a note.

* Indicates special equipment, country-specific equipment and optional extras.



Alerts you to functions which can be adjusted by your authorized BMW center ("Car Memory" or "Key Memory"). Refer to page [55](#). ◀

The individual vehicle

On buying your BMW, you have decided in favor of a model with individualized equipment and features. This Owner's Manual describes all models and equipment that BMW offers within the same group.

We hope you will understand that equipment and features are included that you might not have chosen for your vehicle. Any differences can easily be identified, since all optional accessories and special equipment are marked with an asterisk *.

If your BMW features equipment which is not described in this Owner's Manual (car radio or telephone, for instance), Supplementary Owner's Manuals are enclosed. We ask you to read these manuals as well.

© 1999 BMW AG
Munich, Germany
Reprinting, including excerpts,
only with the written consent of
BMW AG, Munich.
Order no. 01 41 0 155 303
US English X/1999
Printed in Germany
Printed on environmentally friendly paper
(bleached without chlorine, suitable for recycling).

Status at time of printing

BMW pursues a policy of continuous, ongoing development that is conceived to ensure that our vehicles continue to embody the highest quality and safety standards combined with advanced, state-of-the-art technology. For this reason, it is possible that the features described in this Owner's Manual could differ from those on your vehicle. Nor can errors and omissions be entirely ruled out. You are therefore asked to appreciate that no legal claims can be entertained on the basis of the data, illustrations or descriptions in this manual.

For your own safety



Use unleaded gasoline only. Fuels containing up to and including 10% Ethanol or other oxygenates with up to 2.8% oxygen by weight (that is, 15% MTBE or 3% methanol plus an equivalent amount of co-solvent) will not void the applicable warranties respecting defects in materials or workmanship. Field experience has indicated significant differences in fuel quality (volatility, composition, additives, etc.) among gasolines offered for sale in the United States and Canada. The use of poor quality fuels may result in driveability, starting and stalling problems especially under certain environmental conditions such as high ambient temperature and high altitude. Should you encounter driveability problems which you suspect could be related to the fuel you are using, we recommend that you respond by switching to a recognized high-quality brand. Failure to comply with these recommendations may result in unscheduled maintenance. Follow the relevant safety rules when you are handling gasoline. ◀



Important safety information.

For your own safety, use genuine parts and accessories approved by BMW.

When you purchase accessories tested and approved by BMW and Original BMW Parts, you simultaneously acquire the assurance that they have been thoroughly tested by BMW to ensure optimum performance when installed on your vehicle.

BMW warrants these parts to be free from defects in material and workmanship.

BMW will not accept any liability for damage resulting from installation of parts and accessories not approved by BMW.

BMW cannot test every product from other manufacturers to verify if it can be used on a BMW safely and without risk to either the vehicle, its operation, or its occupants.

Original BMW Parts, BMW Accessories and other products approved by BMW, together with professional advice on using these items, are available from all BMW centers.

Installation and operation of non-BMW approved accessories such as alarms, radios, amplifiers, radar detectors, wheels, suspension components, brake dust shields, telephones (including operation of any portable cellular phone from within the vehicle without using an externally mounted antenna) or transceiver equipment (for instance, CBs, walkie-talkie, ham radio or similar accessories) may cause extensive damage to the vehicle, compromise its safety, interfere with the vehicle's electrical system or affect the validity of the BMW Limited Warranty. See your authorized BMW center for additional information. ◀



Maintenance, replacement, or repair of the emission control devices and systems may be performed by any automotive repair establishment or individual using any certified automotive part. ◀

Symbol on vehicle parts



Indicates that you should consult the relevant section of this Owner's Manual for information on a particular part or assembly.

The following applies only to vehicles owned and operated in the US.

REPORTING SAFETY DEFECTS

If you believe that your vehicle has a defect that could cause a crash or could cause injury or death, you should immediately inform the National Highway Traffic Safety Administration (NHTSA) in addition to notifying BMW of North America, Inc., P.O. Box 1227, Westwood, New Jersey 07675-1227, Telephone (201) 307-4000.

If NHTSA receives similar complaints, it may open an investigation, and if it finds that a safety defect exists in a group of vehicles, it may order a recall and remedy campaign. However, NHTSA cannot become involved in individual problems between you, your dealer, or BMW of North America, Inc.

To contact NHTSA, you may either call the Auto Safety Hotline toll-free at 1-800-424-9393 (or 366-0123 in Washington, D.C. area) or write to: NHTSA, U.S. Department of Transportation, Washington, D.C. 20590. You can also obtain other information about motor vehicle safety from the Hotline.



Overview

Controls and features

Operation, care
and maintenance

Owner service procedures

Advanced technology

Technical data

Index



Contents

Overview

Cockpit	16
Instrument cluster	18
Indicator and warning lamps	22
Multifunction steering wheel	26
Sports steering wheel	27
Hazard warning flashers	28
Warning triangle	28
First-aid kit	28
Refueling	29
Fuel specifications	30
Tire inflation pressure	30

Controls and features

Locks and security systems:	
Keys	34
Electronic vehicle immobilizer	35
Central locking system	36
Opening and closing	
– from the outside	36
Using the key	36
Using the remote control	37
Opening and closing	
– from the inside	40
Liftgate	41
Tailgate	41
Alarm system	43
Electric power windows	45
Sliding/Tilt sunroof with glass moonroof	46
Adjustments:	
Seats	48
Steering wheel	51
Mirrors	52
Seat, mirror and steering wheel memory	54
Car Memory, Key Memory	55
Passenger safety systems:	
Safety belts	56
Airbags	57
Child restraints	60
Child seat security	61
Child-safety locks	62

Driving:

Steering/Ignition lock	63
Starting the engine	64
Switching off the engine	65
Parking brake	65
Automatic transmission with Steptronic	66
Turn signal indicator/Headlamp flasher	69
Washer/Wiper system/Rain sensor	69
Rear window defroster	71
Cruise control	72

Everything under control:

Odometer, outside temperature display	74
Tachometer	75
Energy control	75
Fuel gauge	75
Coolant temperature gauge	76
Service Interval Display	76
Check Control	77
Onboard computer	80

Technology for safety and driving convenience:

Park Distance Control (PDC)	82
Dynamic Stability Control (DSC)	83
Hill Descent Control (HDC)	84

- Controls and features**
- Lamps:**
 - Side lamps/Low beams [86](#)
 - Instrument lightning [86](#)
 - High beams/Parking lamps [87](#)
 - Fog lamps [87](#)
 - Interior lamps [87](#)
 - Reading lamps [88](#)
 - Controlling the climate for pleasant driving:**
 - Automatic climate control [90](#)
 - Seat heating [96](#)
 - Steering wheel heating [96](#)
 - Roller sun blind [97](#)
 - Independent ventilation system [97](#)
 - Cabin convenience:**
 - BMW Universal Transmitter [98](#)
 - Glove compartment [101](#)
 - Storage compartments [101](#)
 - Cellular phone [102](#)
 - Cup holders [102](#)
 - Ashtray, front [103](#)
 - Cigarette lighter [103](#)
 - Ashtray, rear [104](#)
 - Loading and transporting:**
 - Ski bag [105](#)
 - Cargo area
 - Fold the rear backrests down [107](#)
 - Cargo area cover [107](#)
 - Partition net [108](#)
 - Cover panels in the cargo area [109](#)
 - Power outlets [110](#)
 - Pull-out cargo floor [111](#)
 - Cargo loading [112](#)
 - Roof-mounted luggage rack [113](#)
 - Operation, care and maintenance**
 - Special operating instructions:**
 - Break-in procedures [116](#)
 - Driving your BMW X5 [117](#)
 - General driving notes [118](#)
 - Catalytic converter [118](#)
 - Antilock Brake System (ABS) [119](#)
 - Disc brakes [122](#)
 - Brake system [123](#)
 - Winter operation [123](#)
 - Power steering [125](#)
 - Level control system [125](#)
 - Cellular phone [126](#)
 - Radio reception [126](#)
 - Wheels and tires:**
 - Tire inflation pressure [127](#)
 - Tire condition [127](#)
 - Tire replacement [128](#)
 - Tire rotation [129](#)
 - Wheel and tire combinations [130](#)
 - Winter tires [131](#)
 - Snow chains [131](#)
 - Approved wheel and tire specifications [132](#)

Contents

Operation, care and maintenance

Under the hood:

- Hood [133](#)
- Engine compartment [134](#)
- Washer fluid [136](#)
- Washer nozzles [136](#)
- Engine oil [137](#)
- Coolant [140](#)
- Brake fluid [141](#)
- Vehicle Identification No. [141](#)

Care and maintenance:

- The BMW Maintenance System [142](#)
- Caring for your vehicle [143](#)
- Airbags [148](#)
- Vehicle storage [148](#)

Laws and regulations:

- Technical modifications [149](#)
- OBD interface socket [150](#)

Owner service procedures

Replacement procedures:

- Onboard tool kit [154](#)
- Wiper blades [154](#)
- Lamps and bulbs [155](#)
- Changing a wheel [160](#)
- Battery [165](#)
- Fuses [167](#)

In case of electrical malfunction:

- Fuel filler door [168](#)
- Sliding/Tilt sunroof [168](#)
- Liftgate [168](#)
- Tailgate [169](#)

Assistance, giving and receiving:

- Jump-starting [170](#)
- Towing the vehicle [171](#)

Advanced technology

- Airbags [176](#)
- Adaptive Transmission Control (ATC) [176](#)
- Four-wheel drive [177](#)
- Dynamic Stability Control (DSC) [177](#)
- Radio reception [178](#)
- Safety belt tensioner [178](#)
- DSP sound system [179](#)
- Rearview mirrors with automatic dimmer [179](#)
- Rain sensor [180](#)
- Integrated rear suspension [180](#)
- Level control system [181](#)
- Xenon lamps [181](#)

Technical data

Engine specifications 184
Dimensions 185
Weights 186
Capacities 187
Electrical system 188
Drive belts 188

Index

Everything from A to Z 192
Owner service procedures 198





Cockpit 16
 Instrument cluster 18
 Indicator and warning lamps 22
 Multifunction steering wheel 26
 Sports steering wheel 27
 Hazard warning flashers 28
 Warning triangle 28
 First-aid kit 28
 Refueling 29
 Fuel specifications 30
 Tire inflation pressure 30

Overview

Controls and features

Operation, care and maintenance

Owner service procedures

Advanced technology

Technical data

Index

16 Cockpit

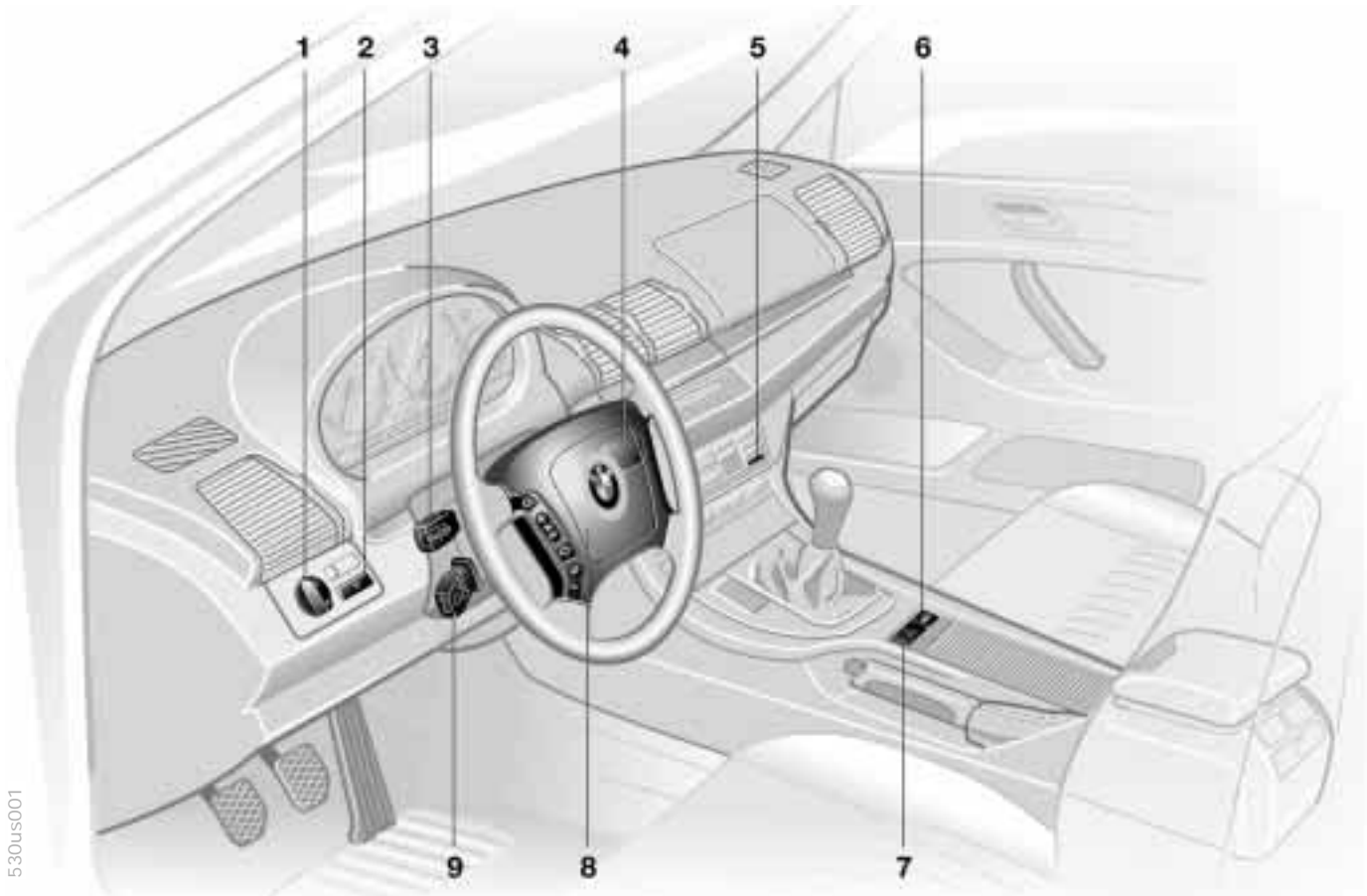

530us001

Cockpit

- 1 Parking lamps/Low beams [86](#)
- 2 Fog lamps [87](#)
- 3 ▷ Turn signal indicator [69](#)
 - ▷ Parking lamp [87](#)
 - ▷ High beam [87](#)
 - ▷ Headlamp flasher [69](#)
 - ▷ Onboard computer [80](#)
- 4 Wiper/Washer system [69](#)
- 5 Rear window defroster [71](#)
- 6 Central locking system [36](#)
- 7 Hazard warning flashers [28](#)
- 8 Horn [26](#)
- 9 Adjusting steering wheel [51](#)

18 Instrument cluster



530us002

Instrument cluster

There are two versions, depending on the equipment on your vehicle.

- 1 Fuel gauge with indicator lamp for fuel reserve [75](#)
- 2 Indicator lamp for turn signal indicator [24](#)
- 3 Speedometer
- 4 Indicator lamp for high beams [24](#)
- 5 Tachometer and Energy Control [75](#)
- 6 Engine coolant thermometer with "Coolant temperature too high" indicator [76](#)
- 7 Indicator and warning lamps (clockwise) for:
 - ▷ Parking brake/Brake hydraulic system, Dynamic Brake Control (DBC) [22, 24](#)
 - ▷ Antilock Brake System (ABS) [23](#)
 - ▷ Brake pads [24](#)
 - ▷ Airbags [23](#)
 - ▷ Automatic transmission [24](#)
 - ▷ Please fasten safety belts [23](#)
 - ▷ Cruise control [25](#)
- 8 Selector lever and program display for automatic transmission [66](#)
- 9 Service Interval Display [76](#)
- 10 Onboard computer display – Operation via the turn signal lever: Refer to page [80](#):
 - ▷ Outside temperature
 - ▷ Average fuel consumption
 - ▷ Cruising range
 - ▷ Average speed
- 11 Indicator lamp for Dynamic Stability Control (DSC) [24](#)
- 12 Indicator lamp for level control system [24](#)
- 13 Odometer and trip odometer [74](#)
- 14 Indicator for Check Control [77](#)
- 15 Reset button for trip odometer [74](#)
- 16 Indicator and warning lamps (clockwise) for:
 - ▷ Fog lamps [25](#)
 - ▷ Battery charge current [22](#)
 - ▷ Engine oil level/Engine oil pressure [24, 22](#)
 - ▷ Engine Power Control [24](#)
 - ▷ Service Engine Soon [24](#)

20 Instrument cluster*

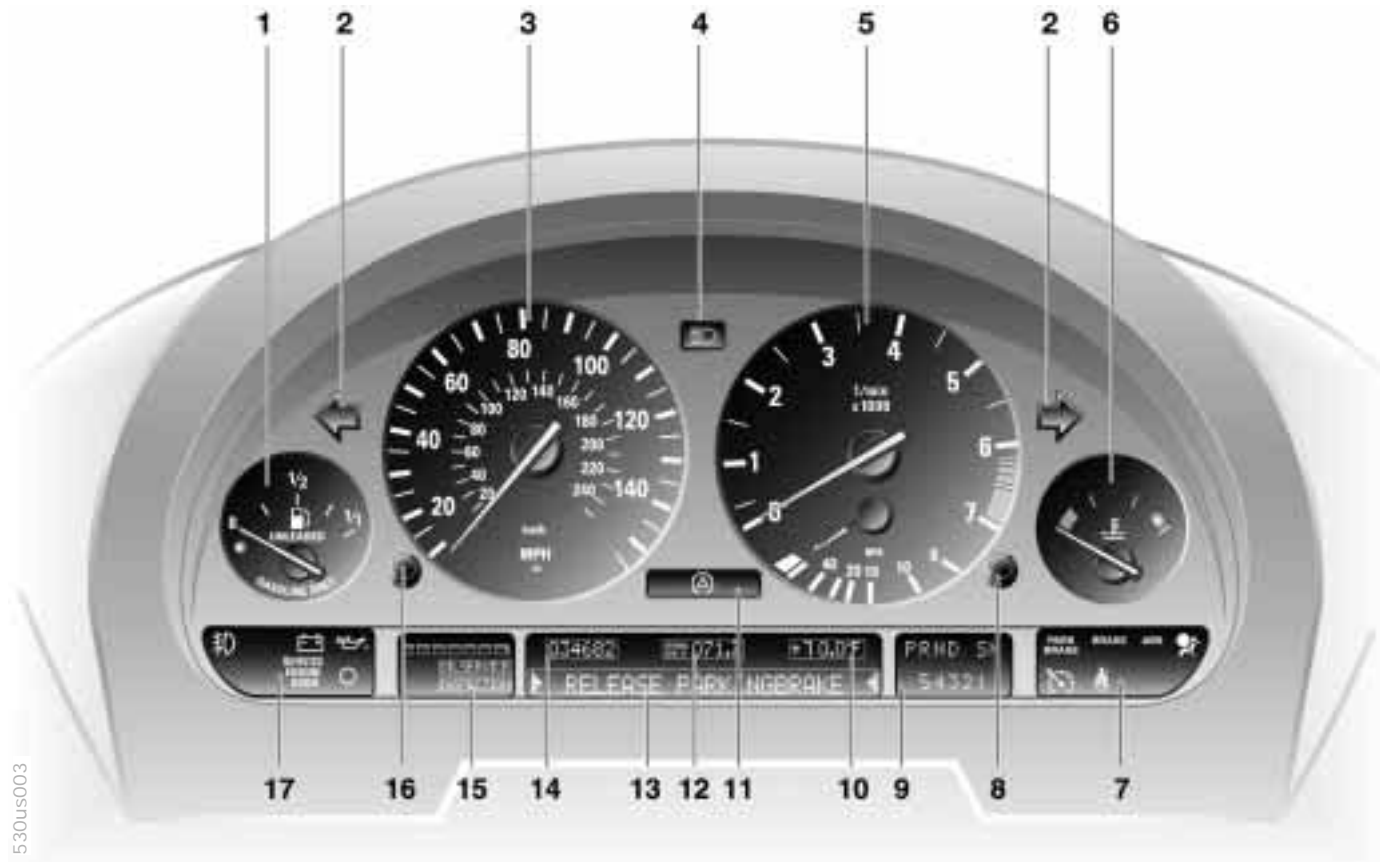

530us003

Instrument cluster*

There are two versions, depending on the equipment on your vehicle

- 1 Fuel gauge with indicator lamp for fuel reserve [75](#)
- 2 Indicator lamp for turn signal indicator [25](#)
- 3 Speedometer
- 4 Indicator lamp for high beams [25](#)
- 5 Tachometer and Energy Control [75](#)
- 6 Engine coolant temperature gauge [76](#)
- 7 Indicator and warning lamps (clockwise) for:
 - ▷ Parking brake [23](#)
 - ▷ Brake hydraulic system/Dynamic Brake Control (DBC) [22, 24](#)
 - ▷ Antilock Brake System (ABS) [23](#)
 - ▷ Airbags [23](#)
 - ▷ Please fasten safety belts [23](#)
 - ▷ Cruise control [25](#)
- 8 CHECK button [77](#)
- 9 Selector lever and program display for automatic transmission [66](#)
- 10 Outside temperature display [74](#)
- 11 Indicator lamp for Dynamic Stability Control (DSC) [24](#)
- 12 Trip odometer [74](#)
- 13 Indicator for Check Control* [77](#)
- 14 Odometer [74](#)
- 15 Service Interval Display [76](#)
- 16 Reset button for trip odometer [74](#)
- 17 Indicator and warning lamps (clockwise) for:
 - ▷ Fog lamps [25](#)
 - ▷ Battery charge current [22](#)
 - ▷ Engine oil pressure [22](#)
 - ▷ Service Engine Soon [24](#)

22 Indicator and warning lamps

Technology that monitors itself

Many of the systems of your BMW monitor themselves automatically, both during engine starts and while you are driving. Indicator and warning lamps that are identified by "●" are tested for proper functioning whenever the ignition key is turned. They each light up once for different periods of time.

If a fault should occur in one of these systems, the corresponding lamp does not go out after the engine is started or it lights up while the vehicle is moving. You will see how to react to this below.

Red: stop immediately



Battery charge current ●
The battery is no longer being charged. There is a malfunction of the alternator V-belt or in the charging circuit of the alternator. Please contact the nearest BMW center.



If the V-belt is defective, do not continue driving. The engine could be damaged due to overheating. If the V-belt is defective, increased steering effort is also required. ◀



Engine oil pressure ●
Stop the vehicle immediately and switch off the engine. Check the engine oil level; top up as required. If the oil level is correct: please contact the nearest BMW center.



Do not continue driving. The engine could be damaged because of inadequate lubrication. ◀



**Parking brake*/
Brake hydraulic system ●**
Comes on when you engage the parking brake.
For additional information: refer to page 65.

Comes on although the parking brake is released: have the brake fluid level checked. Before continuing your journey, be sure to read the notes on pages 123 and 141.

Also comes on in the Check Control with the message "CHECK BRAKE LININGS."



**Parking brake warning lamp*/
Brake hydraulic system for
Canadian models.**

Indicator and warning lamps

Yellow: stop immediately



Engine oil level

Comes on while driving: Stop the vehicle immediately and switch off the engine. The oil level is at the absolute minimum.

For additional information: refer to page [137](#).



Do not drive the vehicle until you have topped up the engine oil. If you do, the engine could be damaged because of inadequate lubrication. ◀

Red or yellow: continue to drive; drive cautiously



If the brake warning lamp comes on red together with the yellow warning lamps for ABS and DSC:



ABS, CBC, DSC, DBC, EBV and HDC have failed. Continue to drive; drive cautiously and defensively and avoid full brake applications.



Have the system checked by the nearest BMW center.

For additional information: refer to pages [83](#) and [121](#).

If all all three warning lamps come on yellow:

ABS, CBC, DSC, DBC and HDC have failed. Continue to drive; drive cautiously and defensively and avoid full brake applications.

Have the system checked by your authorized BMW center as soon as possible.



Warning lamps for Canadian models.



Red: an important reminder



Parking brake*

Comes on when you engage the parking brake.

For additional information: refer to page [65](#).



Parking brake warning lamp* for Canadian models.



Please fasten safety belts ●

Together with an acoustic signal or a message* in the Check Control. Comes on until the safety belts are fastened.

For additional information on safety belts: refer to page [56](#).



Airbags ●

Please have the system inspected by your authorized BMW center.

For additional information: refer to page [57](#).

24 Indicator and warning lamps

Yellow: check as soon as possible



Engine oil level

Comes on after the engine has been shut off: check the engine oil level.

For additional information: refer to page [137](#).



Automatic transmission*

Because of a malfunction, the automatic transmission shifts only in the emergency program. Please consult the nearest authorized BMW center.

For additional information: refer to page [68](#).



Brake pads* ●

Have the brake pads checked.

For additional information: refer to page [123](#).



Dynamic Brake Control (DBC) ●

Fault in the DBC system. Please have the system inspected by your authorized BMW center.

For additional information: refer to page [120](#).



Warning lamp, Dynamic Brake Control (DBC) for Canadian models



Level control system* ●

The level control system is inactive. Please consult the nearest authorized BMW center.

For additional information: refer to page [125](#).



Dynamic Stability Control (DSC) ●

DSC has been switched off with the button; the traction intervention system is still active.

In the event of a malfunction the indicator lamp comes on continuously and can't be switched off with the button: DSC and HDC are inactive. Please have the system checked by the nearest BMW center.

For additional information: refer to pages [83](#) and [85](#).



Engine Power Control*

There is a malfunction in the Engine Power Control. When braking, higher brake application pressure may be necessary and brake pedal travel may be significantly longer. Please have the system inspected by your authorized BMW center.



Service Engine Soon ●

If the indicator lamp comes on either continuously or intermittently, this indicates a fault in the emissions-related electronic systems. Although the vehicle remains operational, you should have the systems checked by your BMW center at the earliest possible opportunity.

For additional information: refer to page [150](#).



Warning lamp, Service Engine Soon for Canadian models

Indicator and warning lamps

Green: for your information



Turn signal indicator
Flashes when the turn signals are operated. Rapid flashing indicates a system malfunction.

For additional information: refer to page [69](#).



Cruise control
Comes on when the cruise control is activated: available for operation via the multifunction steering wheel.

For additional information: refer to page [72](#).



Fog lamps
Lights up whenever you switch on the fog lamps.

For additional information: refer to page [87](#).

Blue: for your information



High beam
Lights up when the high beams are on or the headlamp flasher is actuated.

For additional information: refer to pages [69](#) and [87](#).

26 Multifunction steering wheel

The controls integrated in the multifunction steering wheel (MFL) are provided so that you can operate a number of accessories quickly and without being distracted from traffic conditions. You may operate:

- ▷ selected radio functions,
- ▷ recirculated air control of the air condition system
or
- ▷ the steering wheel heating,
- ▷ the cruise control and
- ▷ selected cellular phone functions.

 In order to operate a system via the MFL, the corresponding system controls must be activated. ◀

The illustration shows the maximum possible number of controls, corresponding to a full range of optional equipment. Refer to the individual accessory manuals for more detailed descriptions.



- 1 Telephone: receive a call, initiate dialing, terminate a call.
- 2 Radio/Telephone: select.
- 3 Radio/Telephone: scan backward or scan station keys or scroll in the phone listings.
- 4 Radio/Telephone: volume.
- 5 Radio/Telephone: scan forward or scan station keys or scroll in the phone listings.
- 6 Horn: the entire surface.
- 7 Cruise control: activate stored setting (resume).
- 8 Cruise control: store and accelerate (+); decelerate and store (-).
- 9 Cruise control: activate/interrupt/deactivate.
- 10 Recirculated air mode and AUC or steering wheel heating: activate and deactivate.

Sports steering wheel*

The controls integrated in the sports steering wheel (not released at this time) are provided so that you can operate a number of accessories quickly and without being distracted from traffic conditions. You may operate:

- ▷ selected radio functions,
- ▷ the cruise control and
- ▷ selected cellular phone functions.

 In order to operate a system via the sport steering wheel, the corresponding system controls must be activated. ◀

Refer to the individual accessory manuals for more detailed descriptions.



- | | |
|---|---|
| <ol style="list-style-type: none"> 1 Radio/Telephone: select. 2 Telephone: receive a call, initiate dialing, terminate a call. 3 Radio/Telephone: volume. 4 Radio/Telephone: scan backward or scan station keys or scroll in the phone listings. 5 Radio/Telephone: scan forward or scan station keys or scroll in the phone listings. | <ol style="list-style-type: none"> 6 Horn: the entire surface. 7 Cruise control: activate stored setting (resume). 8 Cruise control: store and accelerate (+); decelerate and store (-). 9 Cruise control: activate/interrupt/deactivate. |
|---|---|



The button flashes intermittently when the hazard warning flashers are on.

To help you locate the switch in an emergency, the button is also illuminated whenever the vehicle's lamps are on.



- 1 Open the cover on the left in the cargo area: lift the handle on the cover.
- 2 Pull the tab of the retaining strap (arrow) and remove the hazard warning triangle from the support bracket.
- 3 To install: slide the hazard warning triangle into the support bracket and press on the retaining strap.

 Comply with legal requirements which cover the availability of a hazard warning triangle in the vehicle. ◀



The first-aid kit is located under the front passenger's seat.

To open: pull the handle and fold the cover down.

To close: fold the cover up.

 Some of the articles in the first-aid kit may be used within a limited time only. For this reason, check the expiration dates of each of the items regularly, and replace any whose expiration dates have passed. You can acquire replacements in any drugstore or pharmacy. Comply with legal requirements that cover availability of a first-aid kit in the vehicle. ◀

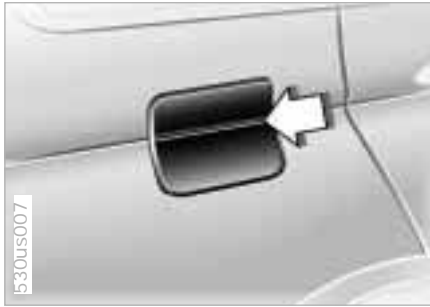

Fuel filler door

 Before filling the tank, shut off the engine. If you do not, fuel cannot be filled into the tank and the "Service Engine Soon" lamp may come on. ◀

To open the filler door, press on the front edge.

To unlock the fuel filler door if the central locking system malfunctions, refer to page [168](#).

 When handling fuels, comply with all of the applicable safety precautions and regulations pertaining to fuels. Never carry spare fuel containers in your vehicle. Whether empty or full, these containers can leak, cause an explosion, or lead to fire in the event of a collision. ◀



Simple and environmentally friendly

 Open the filler cap carefully to prevent fuel from spraying out. Fuel spray may cause injury. Do not top off. Topping off may cause fuel spillage. ◀

Keep the filler cap in the bracket attached to the fuel filler door.

When refueling, insert the filler nozzle completely into the filler pipe. Pulling the nozzle out of the pipe during refueling

- ▷ results in premature pump shutoff
- ▷ and will reduce the effect of the vapor recovery system on the pump.

If the filler nozzle is used correctly, the fuel tank is full when it shuts off for the first time.

Tank capacity: refer to page [187](#)

 Close the fuel cap carefully after refueling. A loose or missing cap will activate the Check Engine lamp. ◀

30 Fuel specifications

The engine uses lead-free gasoline only. However, you can refuel with different fuel qualities since the engine is equipped with knock sensors.

In order to achieve rated values for engine performance and fuel consumption:

- ▷ Super lead-free premium gasoline (91 AKI).

AKI = Anti Knock Index

The minimum fuel quality is:

- ▷ Regular lead-free gasoline (87 AKI). Because of the engine's design, you should refuel with this gasoline only as an exception.

 Do not use leaded fuels. The use of leaded fuels will cause permanent damage to the system's oxygen sensor and the catalytic converter. ◀

Tire inflation pressure



You will find tire inflation pressures on the inside door pillar.

Check tire pressures

All pressure specifications are indicated in psi (kilopascal) for tires at ambient temperature (refer also to the next page).



Check tire inflation pressures regularly – at least every two weeks and before beginning a longer trip. Incorrect tire pressure can otherwise lead to tire damage and accidents. Check the tire inflation pressure of the spare wheel. Inflate the spare tire to the highest inflation of any tire on your vehicle. ◀

Comply with tire approval specifications

The inflation pressures in the table apply to tires from BMW-approved manufacturers. Your BMW center is familiar with these pressures. Higher pressures may be specified for tires from other manufacturers. You will find a list of approved tires beginning on page [132](#). Your vehicle is equipped with tires that not only meet US standards, but also European standards. We recommend the exclusive use of BMW approved tires.

Tire inflation pressure

BMW	Tires All pressure specifications in the table are indicated in psi (kilopascal) with cold tires (cold = ambient temperature)	
X5	All sizes	32 (220) 32 (220) 36 (250) 39 (270)

- Overview
- Controls
- Car care
- Repairs
- Technology
- Data
- Index

Locks and security systems:

- Keys [34](#)
- Electronic vehicle immobilizer [35](#)
- Central locking system [36](#)
- Opening and closing
 - from the outside [36](#)
- Using the key [36](#)
- Using the remote control [37](#)
- Opening and closing
 - from the inside [40](#)
- Liftgate [41](#)
- Tailgate [41](#)
- Alarm system [43](#)
- Electric power windows [45](#)
- Sliding/Tilt sunroof with glass moonroof [46](#)

Adjustments:

- Seats [48](#)
- Steering wheel [51](#)
- Mirrors [52](#)
- Seat, mirror and steering wheel memory [54](#)
- Car Memory, Key Memory [55](#)

Passenger safety systems:

- Safety belts [56](#)
- Airbags [57](#)
- Child restraints [60](#)
- Child seat security [61](#)
- Child-safety locks [62](#)

Driving:

- Steering/Ignition lock [63](#)
- Starting the engine [64](#)
- Switching off the engine [65](#)
- Parking brake [65](#)
- Automatic transmission with Steptronic [66](#)
- Turn signal indicator/Headlamp flasher [69](#)
- Washer/Wiper system/Rain sensor [69](#)
- Rear window defroster [71](#)
- Cruise control [72](#)

Everything under control:

- Odometer, outside temperature display [74](#)
- Tachometer [75](#)
- Energy control [75](#)
- Fuel gauge [75](#)
- Coolant temperature gauge [76](#)
- Service Interval Display [76](#)
- Check Control [77](#)
- Onboard computer [80](#)

Technology for safety and**driving convenience:**

- Park Distance Control (PDC) [82](#)
- Dynamic Stability Control (DSC) [83](#)
- Hill Descent Control (HDC) [84](#)

Lamps:

- Side lamps/Low beams 86
- Instrument lightning 86
- High beams/Parking lamps 87
- Fog lamps 87
- Interior lamps 87
- Reading lamps 88

Controlling the climate for pleasant driving:

- Automatic climate control 90
- Seat heating 96
- Steering wheel heating 96
- Roller sun blind 97
- Independent ventilation system 97

Cabin convenience:

- BMW Universal Transmitter 98
- Glove compartment 101
- Storage compartments 101
- Cellular phone 102
- Cup holders 102
- Glasses compartment 102
- Ashtray, front 103
- Cigarette lighter 103
- Ashtray, rear 104

Loading and transporting:

- Ski bag 105
- Cargo area
 - Fold the rear backrests down 107
 - Cargo area cover 107
 - Partition net 108
 - Cover panels in the cargo area 109
 - Power outlets 110
 - Pull-out cargo floor 111
- Cargo loading 112
- Roof-mounted luggage rack 113

Overview**Controls and features****Operation, care and maintenance****Owner service procedures****Advanced technology****Technical data****Index**

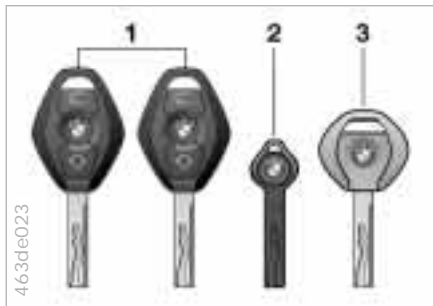

1 The master keys with remote control determine the functions of the Key Memory. Refer to page [55](#).

 There is an extended-life battery in every master key which is charged automatically in the steering lock as you drive.

For this reason, if you have a master key that is otherwise not used, use that key approximately once every year while driving for an extended period. This will charge the battery. Refer also to page [37](#). ◀

2 Spare key for storage in a safe place, such as in your wallet. This key is not intended for continuous use.

3 Door and ignition key

The lock for the glove compartment cannot be operated with this key. This is recommended for valet parking, for instance.

Replacement keys

Replacement keys are available exclusively through your authorized BMW center. Since the keys belong to a security system, your BMW center is obligated to ensure that a person requesting a key is authorized to do so (refer to "Electronic vehicle immobilizer" on the following page).

 If possible, take all of the master keys that belong to the vehicle with you when you pick up your replacement key. Whenever you receive a new replacement key, turn that key to position 2 in the ignition lock once (ignition switched on) and then back. This allows the electronic vehicle immobilizer to "learn" the new key. ◀

Electronic vehicle immobilizer



The key to security

Your BMW is equipped with a passive anti-theft system. This electronic immobilization system is designed to reduce the susceptibility of the vehicle to theft by making it impossible to start the engine using any means other than the special keys furnished with the vehicle. Your BMW center can cancel the electronic system authorization for individual keys (in the event of loss, for instance). A deactivated key can no longer be used to start the engine.

How the electronics work

At the heart of this system is an electronic chip that is integrated into the key. The lock mechanism itself is actually a dual-function device, simultaneously serving as a communications interface designed to allow the security system to maintain a continuous stream of variable, vehicle-specific signals with the electronic circuitry in the key. The system will not release the ignition, fuel injection and starter unless it recognizes an "authorized" key.

 Force applied to the key can damage the integrated electronic circuitry. A damaged key can no longer be used to start the engine. ◀

The concept

The central locking system is ready for operation as soon as you close the front doors. The system engages and releases the locks on the

- ▷ doors
- ▷ liftgate
- ▷ fuel filler door.

The central locking system can be operated

- ▷ from outside via the driver's door lock as well as via the remote control.
- ▷ from inside via the button for the central locking system.

If the system is locked from inside, the fuel filler door remains unlocked. Refer to page 40.

When the system is actuated from outside of the vehicle, the anti-theft protection is actuated simultaneously. The alarm system is also activated or deactivated.

In the event of an accident, the central locking system unlocks automatically (only those doors which were not locked separately with the safety lock buttons). Refer to page 40. In addition, the hazard warning flashers and interior lamps come on.

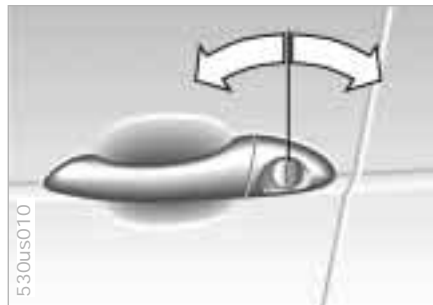
**Using the key**

One turn of the key in the driver's door lock unlocks the driver's door only. Turning the key a second time unlocks all of the remaining doors, the tailgate and the fuel filler door.



You can have an acknowledgment signal set to confirm that the vehicle is correctly closed. ◀

Convenience operation

You can also operate the windows and sliding/tilt sunroof via the door lock.

- ▷ To open: with the door closed, turn the key to the "Unlock" position and hold it.
- ▷ To close: with the door closed, turn the key to the "Lock" position and hold it.



Watch during the closing process to be sure that no one is inadvertently injured. Releasing the key stops the operation. ◀

Manual operation

(in the event of an electrical malfunction)

Turn the key to the extreme left or right to unlock/lock the door.

Opening and closing – from the outside

Using the remote control

The remote control makes opening and locking the doors of your vehicle very convenient. Furthermore, it provides three additional functions that you can only execute by means of the remote control:

- ▷ Switch on the interior lamps
With this function, you can also "search for" your vehicle – when parked in an underground garage, for instance.
- ▷ Open the liftgate
The liftgate will open slightly, regardless of whether it was previously locked or unlocked.
- ▷ Panic Mode
In case of danger, you can trigger an alarm.

When the vehicle is unlocked, the anti-theft protection is deactivated and the alarm system is disarmed; when the vehicle is locked, the systems are activated or armed.

The interior lamps are switched on when the vehicle is unlocked.

 You can have an acknowledgment signal set to confirm that the vehicle is correctly closed. ◀



Master keys

Keys with remote control are master keys. Refer to page 34.

 Children might be able to lock the doors from the inside. For this reason, always take the vehicle's keys with you so that the vehicle can be opened again from the outside at any time. ◀

 Master keys that are used repeatedly are always ready for operation since the battery in the key is charged automatically in the steering lock as you drive.

If it is no longer possible to lock the vehicle via the remote control, the battery is discharged. Use this key while driving for an extended period in order to charge the battery. Refer also to page 34.

To prevent unauthorized use of the remote control, surrender only the door and ignition key 3 or the spare key 2 (refer to page 34) when leaving the vehicle for valet parking, for example. In the event of a system malfunction, please contact your authorized BMW center. You can also obtain replacement keys there. ◀

38 Opening and closing – from the outside



To unlock

Press button 1.

Press the button once to unlock the driver's door only; press a second time to unlock all remaining doors as well as the tailgate and fuel filler door.

Convenience opening mode

Press and hold button 1. The power windows and sliding/tilt sunroof are opened.



To lock and secure:

Press button 2.



To switch on the interior lamps

After locking the vehicle, press button 2 again.

Deactivate the tilt sensor alarm system and interior motion sensor

Press button 2 a second time immediately after locking.

For additional information: refer to page [43](#).

Opening and closing – from the outside



To open the liftgate

Press button 3.

 Before and after a trip, be sure that the liftgate was not opened unintentionally. ◀

Panic Mode

By pressing and holding button 3 for more than two seconds, you can trigger the alarm system if there is an impending danger (the alarm system must be armed).

To switch off the alarm: press button 1.

System interference

The remote control system's functioning may be affected by other units or equipment operating in the immediate vicinity of your vehicle.

If this should occur, you can unlock and lock the vehicle via the door lock with a master key.

For US owners only

The transmitter and receiver units comply with part 15 of the FCC (Federal Communication Commission) regulations. Operation is governed by the following:

FCC ID: LX8EWS
LX8FZVS
LX8FZVE

Compliance statement:

This device complies with part 15 of the FCC Rules. Operation is subject to the following two conditions:

- ▷ This device may not cause harmful interference, and
- ▷ this device must accept any interference received, including interference that may cause undesired operation.

 Any unauthorized modifications or changes to these devices could void the user's authority to operate this equipment. ◀

40 Opening and closing – from the inside



You can operate the central locking system with this button (arrow) when the driver's door is closed. The doors and liftgate are unlocked or locked only. However, the antitheft alarm system is not activated. Also, the fuel filler door remains unlocked to allow refueling.

 If only the driver's door was unlocked from the outside and you press the button

- ▷ all other doors, the liftgate and the fuel filler door will be unlocked when the driver's door is opened.
- ▷ the driver's door will be locked again when it is closed. ◀

To unlock and open the doors

- ▷ Either unlock the doors together with the button for the central locking system and then pull the door handle above the armrest or
- ▷ pull the release handle for each door twice: the first pull unlocks the door, and the second one opens it.

To engage the locks

- ▷ Use the central locking button to lock all of the doors simultaneously, or
- ▷ press down the individual door lock buttons. The fuel filler door remains unlocked. As an added design feature to prevent the driver from being inadvertently locked out of the vehicle, the driver's door lock button will not engage as long as the door is open.



When the vehicle is moving, do not lock the doors with the safety lock buttons. Doors locked in this manner would not open automatically in the event of an accident.

Children might be able to lock the doors from the inside. For this reason, you should always remove the key and take it with you to be sure that you will be able to unlock the vehicle from the outside at all times. ◀



To open from the outside

Press the button (arrow): the liftgate opens slightly.

Manual operation

(in the event of an electrical malfunction)

Refer to page [168](#).



Opening from inside the vehicle

Press this button to open the liftgate when the vehicle is stationary.



If pointed or sharp-edged objects could strike the rear window while driving, be sure to provide protection around all edges. If you do not do this, the heating conductors of the rear window could be damaged. ◀

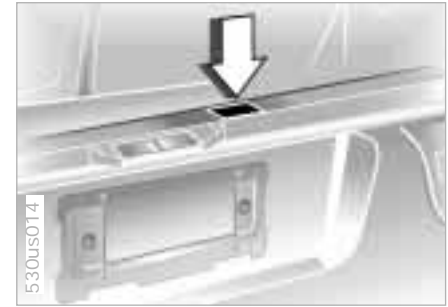

Press the button:

You can fold the tailgate down.



When opened, the tailgate can accept loads of up to 440 lbs (200 kg). When the vehicle is parked, you may utilize the tailgate as a seat or as a loading platform for luggage or recreation gear, for example. ◀

Manual operation

(in the event of an electrical malfunction)

Refer to page [169](#).

42 Liftgate

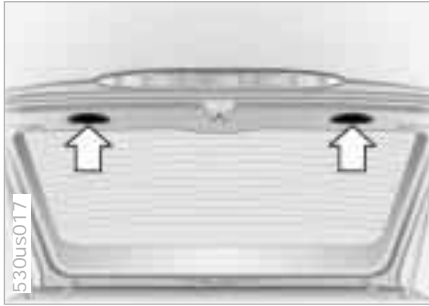

To close

You can pull the liftgate down by placing both hands in the handle recesses (arrows).

 To avoid injuries, be sure that the travel path of the liftgate is clear when it is closed, as with all closing procedures. ◀

 When the liftgate is open, the dimension from the ground to the upper edge is more than 6.5 feet (two meters). Please keep this in mind when opening the liftgate (in a garage, for example). ◀

 Operate the vehicle only when both gates are completely closed. Otherwise, exhaust fumes could penetrate the interior of the vehicle. Should it be absolutely necessary to operate the vehicle with an open gate:

- ▷ Close all windows. Shut the sliding/tilt sunroof.
- ▷ Increase the air supply for automatic climate control to a high level. Refer to page [93](#). ◀

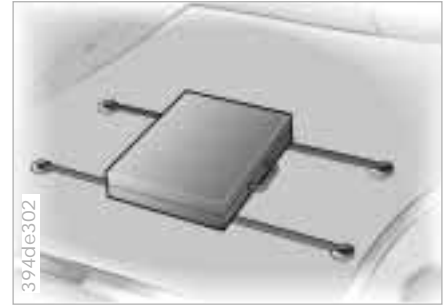

Luggage straps

Use the retaining straps on the cargo area floor to secure smaller items of luggage.

Movement is reduced when objects are placed on the straps.

The lashing eyes located at the corners of the cargo area provide you with a convenient means of attaching luggage nets* or flexible straps for securing suitcases and luggage.

Refer also to "Cargo loading" on page [112](#).

Alarm system

The concept

The vehicle alarm system responds:

- ▷ When a door, the hood, or the liftgate is opened.
- ▷ To movement inside the vehicle (interior motion sensor).
- ▷ To variations in the vehicle tilt sensor such as occur during attempts to steal the wheels or tow the vehicle.
- ▷ To interruption of battery voltage.

The system responds to unauthorized vehicle entry and attempted theft by simultaneously activating the following:

- ▷ Sounding an acoustical alarm for 30 seconds.
- ▷ The hazard warning flashers are activated for approx. five minutes.
- ▷ The high beams flash on and off in the same rhythm.

To activate and deactivate the alarm system

When the vehicle is locked or unlocked with the key or the remote control, the alarm system is also simultaneously armed or disarmed.

The interior motion sensor is activated approx. 30 seconds after you have finished locking the vehicle.

The system indicates that it has been correctly armed by switching on the hazard flashers for a single cycle and by emitting an acoustical signal.

 You can have different acknowledgment signals set to confirm system arming and disarming. ◀

You can still open the liftgate after the system has been armed by pressing button 3 of the remote control. Refer to page 39. When you close the liftgate, the system is secured again.



Indicator lamp displays

- ▷ The indicator lamp below the interior rearview mirror flashes continuously: the system is armed.
- ▷ The indicator lamp flashes during arming: a door(s), the hood or liftgate are not completely closed. Even if you do not close the alerted area, the system begins to monitor the remaining areas, and the indicator lamp flashes continuously after 10 seconds. However, the interior motion sensor is not activated.
- ▷ If the indicator lamp goes out when the system is disarmed: no manipulation or attempted intrusions have been detected in the period since the system was armed.

44 Alarm system

- ▷ If the indicator lamp flashes for 10 seconds when the system is disarmed: an attempted entry has been detected in the period since the system was armed.

Following triggering of an alarm, the indicator lamp will flash continuously.

Avoiding unintentional alarms

The tilt alarm sensor and interior motion sensor may be switched off at the same time. To prevent a false alarm from being triggered (in garages with elevator ramps, for instance), or when the vehicle is transported by trailer or train:

Actuate the lock (= arm the system) twice; in other words, press button 2 of the remote control twice in succession (refer to page 38). You may also actuate the locks twice with the key (refer to page 36).

The indicator lamp lights up briefly and then flashes continuously. The tilt alarm sensor and the interior motion sensor are deactivated as long as the system is armed.



Interior motion sensor

The illustration depicts the transmitter and receiver of the interior motion sensor.

In order for the interior motion sensor to function properly, the windows and sliding/tilt sunroof must be completely closed.

However, be sure to deactivate the interior motion sensor (see the previous column) when you wish to leave the windows or sliding/tilt sunroof open.

Electric power windows



Open and close windows

From ignition key position 1:

- ▷ Press the switch until you feel resistance:
The window continues to move as long as you continue to hold the switch.
- ▷ Press the switch beyond the resistance point:
The window moves downward automatically. Touch the switch again to stop the opening movement.

You can close the windows in the same manner by pulling the switch.

After the ignition has been switched off:

- ▷ You can still operate the windows as long as neither of the front doors has been opened. To open the windows, press the switch beyond the resistance point.

 Remove the key from the ignition when you leave the vehicle so that children cannot operate the power windows and possibly injure themselves. ◀

For the convenience mode via the door lock or the remote control, refer to page [36](#) or page [38](#).

Safety feature

A contact strip is integrated into the inner side of each of the upper window frame sections. If pressure is exerted against this contact strip while a window is being raised, the system will respond by stopping the window and then retracting it a small distance.

 Despite this safety feature, be extremely careful that the closing path of the window is not obstructed whenever it is closed. Otherwise, an object might not touch the contact strip in some situations (with very thin objects, for instance).

You can override this safety feature by pressing the switch beyond the resistance point and holding it. Because the power windows are sealed at high pressure to prevent wind noise when closed, a powerful motor is required for efficient closing. When closing the windows, always ensure that they are not obstructed in any way. Unsupervised use of these systems can result in serious personal injury. Remove the ignition key to deactivate the electric power windows whenever you leave the vehicle. Never leave the keys in the vehicle with unsupervised children. Never place anything that could obstruct the driver's vision on or next to the windows. ◀



Safety switch

With the safety switch, you can prevent the rear windows from being opened or closed via the switch in the rear passenger area (by children, for example). You can also prevent adjustments of the power rear-seat backrests from the rear passenger area (refer to page 51).

 Press the safety switch whenever children are riding in the rear of the vehicle. Careless use of the power windows can lead to injury. ◀

 To prevent injuries, exercise care when closing the sliding/tilt sunroof and keep it in your field of vision until it is shut. Before leaving the vehicle, switch off the electric sunroof mechanism by taking out the ignition key. Do not leave children unattended in the vehicle with access to vehicle keys. Use of the key can result in starting of the engine and operation of vehicle systems such as the power sunroof, etc. Unsupervised use of these systems can result in serious personal injury. ◀

You can avoid pressure or drafts in the passenger compartment when the sunroof is open or lifted by opening the air vents in the dashboard and increasing the air supply as required. Refer to pages 93.

If the sunroof is completely open, air disturbances may be caused in the vehicle when you are driving at higher speeds. Close the roof as far as is necessary until this natural phenomenon ceases.

For the convenience mode via the door lock or the remote control, refer to page 36 or 38.



Lifting – Opening – Closing

With the ignition key in position 1 or higher, press the switch or slide it in the desired direction until you feel resistance.

The headliner insert slides back somewhat when you raise the sunroof. When the sunroof is opened, the headliner retracts with it. The headliner will then automatically remain in its retracted position, but can be repositioned as desired.

After the ignition has been switched off, you can still operate the sliding/tilt sunroof as long as neither of the front doors has been opened.

Automatic* opening and closing

Press the switch past the resistance point and then release it.

Other automatic operations are:

- ▷ With the sunroof open, press the switch briefly toward "Lift:" the sunroof automatically extends to its fully raised position.
- ▷ With the sunroof raised, hold the control switch toward "Open" until the roof has reached the desired position.

Pressing the switch again briefly stops the motion.

Safety feature

If the sliding/tilt sunroof encounters resistance at a point roughly past the middle of its travel when it is closing, the closing cycle is interrupted and the sliding/tilt sunroof will open again slightly.



Despite this safety feature, be extremely careful that the closing path of the sunroof is not obstructed whenever it is closed. Otherwise, triggering the closing-force limitation may not be ensured in some situations (with very thin objects, for instance). You can disable this safety feature by pressing the switch beyond the pressure point and holding it. ◀



Power loss or malfunction

After interruptions in the electrical supply (when the battery is disconnected, for instance), the sunroof may only lift. To reinitialize the mechanism:

- 1 Raise the sliding/tilt sunroof fully.
- 2 Press and hold the switch for approximately twenty seconds.
- 3 In the event of an electrical malfunction, you can also operate the sliding/tilt sunroof manually. Refer to page 168.

For maximum safety when adjusting the seat position, please observe the following:

 Never try to adjust your seat while driving the vehicle. The seat could respond with unexpected movement, and the ensuing loss of vehicle control could lead to an accident. Be sure that the safety belt remains firmly against your body at all times. In the event of a frontal impact, a loose lap belt could slide over your hips, leading to abdominal injury. In addition, the safety belt's restraint effectiveness is reduced if the belt is worn loosely. Never ride with the backrest reclined to an extreme angle (especially important for the front passenger to remember). If you do so, there is a risk that you will slide under the safety belt in an accident, thus reducing the protection provided by the safety belt. ◀

Correct sitting posture

To reduce strain on the spinal column, sit all the way back in the seat and rest your back fully against the backrest. The ideal sitting posture is achieved with your head extending from your spine in a straight line. For long-distance driving, you may wish to angle the backrest slightly to reduce muscular tension. You should be able to reach the highest point on the steering wheel without straightening your arms.

Power seats



- 1 Tilt angle (driver's seat only)
 - 2 Backward/Forward adjustment
 - 3 Cushion height
 - 4 Backrest angle
- Adjust the head restraint manually.

 Comply with the adjustment instructions in the preceding column. Failure to do so could result in diminished personal safety. ◀

Lumbar support*

Refer to the BMW comfort seat on page 49.

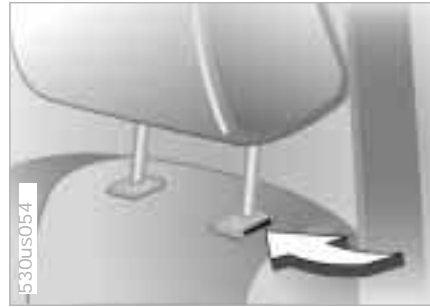
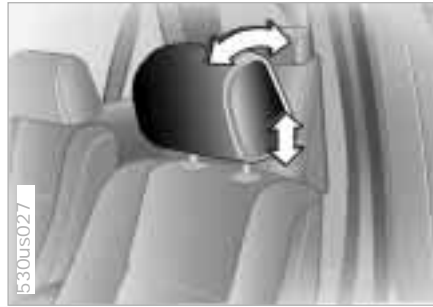

Adjustments

To adjust the angle of the front head restraints, tilt the head restraint to the desired angle.

To adjust the height of the front or rear head restraints, pull the head restraint up or push it down.

 Head restraints reduce the risk of spinal injury in the event of an accident. Adjust the head restraint so that its center is approximately level with your ears. ◀

Removal - front

- 1 Pull the head restraint upward to the stop.
- 2 Press the button (arrow) and remove the head restraint.

Installation - rear

- 1 Press the button (arrow) and insert the head restraint into the guides.
- 2 Adjust the head restraint for your personal comfort.

Removal and installation - rear

To remove the head restraint, pull it outward with a firm movement. To install it, press it down firmly.

This seat allows you to make additional adjustments for:

- 1 Lumbar support
- 2 Shoulder support
- 3 Head restraint height

 Comply with the adjustment instructions on page 48. Failure to do so could result in diminished personal safety. ◀

1 Lumbar support

You can adjust the backrest's contour for additional support in the curvature of your spine's lumbar region.

The upper hips and spinal column receive supplementary support to help you maintain a relaxed, upright posture.



- ▷ Press the front/rear of the switch:
Increase/Decrease curvature.
- ▷ Press the upper/lower end of the switch:
Increase the upper/lower curvature.

2 Shoulder support

Move the rocker switch in the direction of the arrow to adjust the tilt angle of the shoulder support.

You can use the adjustable upper backrest for supplementary support in the shoulder region. This provides a relaxed driving position and helps relieve stress on the shoulder muscles.

To obtain the optimal shoulder support position, we recommend:

Driver and front passenger:

- 1 Adjust the upper backrest section to its extreme rear position.
- 2 Adjust for the optimal seating posture as described on page 48.
- 3 Bring the upper backrest section forward until your shoulders enjoy firm support.

Front passenger's seat adjusted for relaxed traveling:

- 1 Adjust the upper backrest section to its extreme rear position.
- 2 Increase the seat cushion tilt.
- 3 Tilt the backrest slightly further.
- 4 Bring the upper backrest section forward.



Make corrections in the forward/backward adjustment of the seat to ensure that the safety belt still fits firmly against your body. If you do not do this, the protection provided by the safety belt may be reduced. ◀

3 Head restraint height

Move the switch in the desired direction.



Thigh support

Pull the lever and adjust the position of the thigh support for your personal comfort.

Power rear-seat backrests*



You can make separate adjustments of the backrest tilt angle on the right and left sides.

You can select a comfortable seating position and also increase the capacity of the cargo area by moving the backrests into their most upright position.

From the rear seats: press the corresponding switch.

 You can prevent adjustments of the power rear-seat backrest from the rear passenger area with the safety switch for the power windows (refer to page 46). ◀



From the cargo area: the switches are located on both sides of the cargo area.

Adjusting steering wheel 51



The steering wheel can be moved in any of four directions. Adjust the wheel by moving the control lever in the desired direction.

 Do not adjust the steering wheel while the vehicle is moving. If you do so, there is a risk of accident from unexpected movement. ◀

To store the steering wheel setting, refer to "Seat, mirror and steering wheel memory" on page 54.

Automatic steering wheel adjustment

In order to make it easier to get into and out of the vehicle, the steering wheel automatically moves into the top position and returns to the driving (memory) position.

This automatic feature is controlled by the position of the ignition key and by the driver's door.



Exterior mirrors

- 1 Mirror switch for 4-way adjustment
- 2 Left/Right selection switch.

You can also adjust the mirrors manually by pressing against the outer edges of their lenses.

To store the mirror settings, refer to "Seat, mirror and steering wheel memory" on page [54](#).



The mirror on the passenger's side features a lens with a more convex surface than the mirror installed on the driver's side. When estimating the distance between yourself and other traffic, bear in mind that the objects reflected in the mirror are closer than they appear. This means that estimations of the distance to following traffic should not be regarded as precise. ◀

Self-defrosting mirrors

Both mirrors are defrosted automatically when the ignition key is in position 2.



Interior rearview mirror

To reduce glare from vehicles behind you when you are driving at night, tilt the mirror by turning the button.

Lighted vanity mirror

Fold down the sun visor and slide the cover panel to the side as required.

The mirror lamps operate from ignition key position 1 and up.

Sun visors

These can be folded down toward the windshield or swiveled out against the side windows.

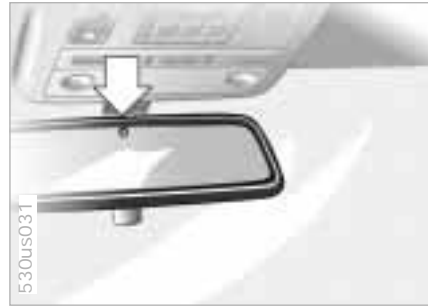

Interior and exterior rearview mirror with automatic dimmer*

By responding to the effects of ambient light and the glare from following traffic, these mirrors automatically dim through an infinitely-variable range.

The mirrors automatically revert to their clear, undimmed setting whenever you select "Reverse."

To ensure that the mirrors continue to operate properly, keep the two photo-cells on the interior mirror clean and unobstructed. One photocell (arrow) is in the mirror glass, while the other is offset somewhat on the opposite side of the mirror.

For an explanation of the electro-chromic technology used in these mirrors, refer to page 179.

54 Seat, mirror and steering wheel memory



You can store and call up three different seat, exterior mirror and steering wheel positions. The illustration shows the buttons on the seat for making these position adjustments.

The adjustment of the lumbar support is not stored in the memory.

To store

- 1 Turn the ignition key to position 1 or 2.
- 2 Adjust the desired positions for the seat, door mirror and steering wheel.
- 3 Press the MEMORY button: the indicator lamp in the button comes on.
- 4 Press memory button 1, 2 or 3, as desired: the indicator lamp goes out.

To select a stored setting

Convenience function:

- 1 Open the driver's door after unlocking the vehicle or place the ignition key in position 1.
- 2 Briefly press memory button 1, 2 or 3, as desired.

Movement stops immediately when one of the seat-adjustment or memory buttons is activated during the adjustment process.

Security function:

- 1 With the driver's door closed and the ignition key either removed or in position 0 or 2.
- 2 Maintain pressure on the desired memory button (1, 2 or 3) until the adjustment process is completed.

If you press the MEMORY button accidentally: press the button a second time – the indicator lamp goes out.



Do not call up a position from the memory while the vehicle is moving. There is a risk of accident from unexpected movement of the seat or steering wheel. ◀



Passenger side exterior mirror tilt function

(automatic curb monitor)

- 1 Move the mirror selector switch (arrow) to the "driver's mirror" position.
- 2 When the selector lever is placed in "Reverse," the passenger-side mirror tilts downward to help the driver monitor the area directly adjacent to the vehicle during parking (curbs, etc.).

You can deactivate this automatic feature by setting the mirror selection switch to the "passenger side" position.

Car Memory, Key Memory



Your BMW center can adjust your vehicle's systems in such a manner that your personalized settings are automatically called up for the seat, mirror and steering wheel positions when you unlock the vehicle with your personal remote control. ◀



If you make use of the Key Memory, be sure that the footwell behind the driver's seat is unobstructed before unlocking the vehicle. If you fail to do so, persons or objects could be injured or damaged if the seat should move backward. ◀



How the system functions

You have probably frequently wished that you could configure individual functions of your vehicles to reflect your own personal requirements. In engineering your vehicle, BMW has included several user-defined functions in the vehicle's design. Your authorized BMW center can make these settings for you.

There are settings related to the vehicle ("Car Memory") and settings related to individuals ("Key Memory"). You can configure up to four different basic positions for four different persons. The only requirement is that each person uses his or her own remote control key.

When your vehicle is unlocked with the remote control, the vehicle recognizes the individual user by means of a data exchange with the key, and makes adjustments accordingly.

In order for you to distinguish between different keys, colored decals are supplied together with the keys.

What the system can do

Your authorized BMW center can provide you with details on the capabilities of the Car Memory and Key Memory systems.

Memory functions are possible for the

- ▷ driver's seat
- ▷ steering wheel
- ▷ exterior mirrors
- ▷ automatic climate control.



You will see this symbol throughout the Owner's Manual. It is to remind you at appropriate places of the settings that are available to you. ◀

An example of Key Memory is the automatic adjustment of the driver's power seat with settings stored in the memory for the individual person when the vehicle is unlocked.

Safety belts



Fasten your safety belt at the beginning of every trip.

To fasten: make sure you hear the lock engage in the belt buckle.

To release: press the red button in the buckle. Hold the belt and guide it back into its reel.

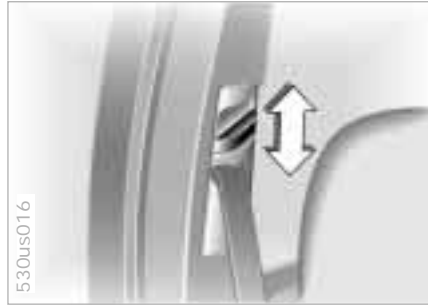

Safety belt height adjustment

You can adjust the front and rear safety belts to fit each passenger correctly with the safety belt height adjustment.

Press the button up or down as required.

Rear safety belt buckles

The two safety belt buckles which are integrated in the rear seat are for passengers sitting on the left and right. The belt buckle with the word "CENTER" is intended exclusively for a passenger sitting in the middle.

 For your safety, comply with the following instructions for wearing safety belts. If you do not, the safety belts may not be able to provide their maximum protection. The following information also applies to your passengers: never allow more than one person to wear a single safety belt. Never allow infants or small children to ride in a passenger's lap. Avoid twisting the belt while routing it firmly across the hips and shoulder. Do not allow the belt to rest against hard or fragile objects in your pockets. Never route the belt across your neck, do not run it across sharp edges and ensure that the belt does not become caught or jammed. Be sure that the safety belt fits snugly against your body at all times, and avoid wearing clothing that prevents the belt from fitting properly. Pull on the belt periodically to readjust the tension over your shoulder. In the event of a frontal impact, a loose lap belt could slide over your hips, leading to abdominal injury. In addition, the safety belt's restraint effectiveness is reduced if the belt is worn loosely. Expectant mothers should always wear their safety belts, taking care to position the lap belt against the lower hips, where it will not exert pressure against the abdominal area. ◀

Safety belts

For cleaning and care instructions, refer to "Car care" on page 146.

 If the center safety belt cannot be pulled out, the larger rear backrest section is not engaged. Refer to page 107. ◀

 If the safety belt system has been subjected to the stresses involved in an accident or otherwise damaged: have the entire safety belt system replaced by your BMW center, including the safety belt tensioner and the child restraint system*. Have the safety belt anchors checked also. ◀

Child restraint systems*

 Never install a rear-facing child restraint system in the front passenger seat. If you do so, the child could be injured in an accident when the airbag is triggered. Do not modify the child restraint system in any way. If you do so, it will not provide your child with maximum protection. ◀

Airbags

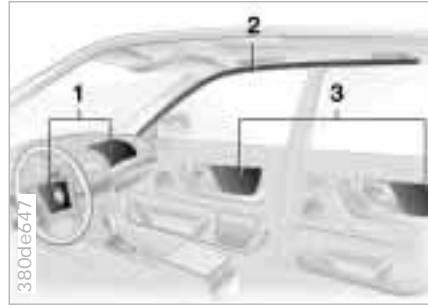

- 1 Front airbag for driver and front passenger
- 2 Side Impact Head Protection System (front and rear side*)
- 3 Side airbags (front and rear side*)

Protective effect

The front airbags supplement the three-point safety belts by providing additional protection for the front-seat occupants in the event of a severe frontal collision in which the protection afforded by the belts alone may no longer be sufficient. The head protection and side airbags help provide protection in the event of a collision from the side. Each of the side airbags is designed to help support the upper body.



 The side airbags in the rear passenger area* of your vehicle may already have been deactivated either at the time of manufacture or by a BMW center. You may have them activated if you desire to do so. Please contact your authorized BMW center for additional information. ◀

The illustration depicts schematically the primary directions of vehicle impact that initiate an airbag deployment.

Indicator lamp



The indicator lamp displays the operational status of the airbag system from ignition key position 1 and up.

System operational:

- ▷ The indicator lamp comes on briefly then goes out.

System malfunction:

- ▷ The indicator lamp fails to come on.
- ▷ The indicator lamp comes on briefly before going out and then lighting up again.

A system malfunction could prevent the system from responding to an impact occurring within its normal response range.

Please have your authorized BMW center inspect and repair the system as soon as possible.

Sitting correctly with airbags



For your safety, comply with the following instructions for the airbags. If you do not, the airbags may not be able to provide their maximum protection. All passengers in the vehicle should be aware of and comply with this information:

The airbags are supplemental restraint devices designed to provide extra protection; they are not a substitute for safety belts. Wear your safety belt at all times. The airbags will not be triggered in the event of a minor accident, a vehicle roll-over, or collisions from the rear. In these instances, the safety belt provides optimal protection.

Airbags are located under cover panels in the steering wheel, in the dashboard, in the side trim panels in the front and rear*, and in the windshield pillars and the sides of the headliner.

Adjust your seat to a position that provides maximum distance between you and the steering wheel, the instrument panel and the door while still allowing comfortable and safe access to all vehicle controls.

To avoid sustaining hand and arm injuries, always grasp the steering wheel on

the rim with the hands at the 9 and 3 o'clock positions. Do not place your hands on the center pad.

Never allow any objects to obstruct the area between the airbag and an occupant.

Do not use the cover panel above the passenger-side airbag as a storage area.

Do not apply adhesive materials to the cover panels of the airbags, cover them or modify them in any other way.

Do not install a rear-facing child restraint system in the front passenger seat of this vehicle.

Children under 13 years of age and children less than 5 feet (150 cm) tall should ride only in the rear seat.

Infants or small children should never be held on the lap of a passenger.

If your vehicle is equipped with side airbags in the rear passenger area, be sure that child restraints are mounted correctly and provided with the greatest-possible distance between the airbags in the side trim panels. Do not allow children to lean out of the child's seat in the direction of the side trim panels. If they do so, serious injuries can occur if the airbag is triggered. ◀

Airbags

 At all times, occupants should sit upright and be properly restrained (infants and small children in appropriate child restraint systems; larger children and adults using the safety belts). Never let an occupant's head rest near or on a side airbag because the inflating airbag could cause a serious or fatal injury. Please note that the word "Airbag" imprinted on the door trim panel indicates the airbag's location.

Accident research shows that the safest place for children in an automobile is in the rear seat. However, a child sitting in the rear seat and not properly restrained may place his or her head on or near the airbag, if so equipped. For example, a child – even though belted – may fall asleep with his or her head against the side airbag. It may be difficult for a driver to ensure that children in the rear seat will remain properly positioned at all times and not place their heads on or near the side airbag. Therefore, we recommend that the rear seat side airbags, if so equipped, be deactivated if children will travel in the rear seat.

The rear seat side airbags may already have been deactivated, either at the time of manufacture or by a BMW center. Labels in the rear door

opening should indicate the status of your rear seat side airbags. If you are uncertain of their status, or wish to have the airbags activated or deactivated, please contact your BMW center. ◀

Even when all these guidelines are observed, there is still a small residual risk of injuries to the face, hands and arms occurring from airbag deployment in isolated instances. The ignition and inflation noise may provoke a mild temporary hearing loss in extremely sensitive individuals.

Airbag warning information is also provided on the sun visors.

For additional information concerning the airbag system, refer to page [148](#) and [176](#).



This is the right way for a child to sit in a child restraint when rear side airbags (arrow) are provided.

Airbags



This is the right way for a larger child to sit wearing the safety belt when rear side airbags (arrow) are provided.

Child restraints*

Commercially-available child restraint systems are designed to be secured with a lap belt or with the lap belt portion of a combination lap/shoulder belt. Improperly or inadequately installed restraint systems can increase the risk of injury to children. Always read and follow the instructions that come with the system.

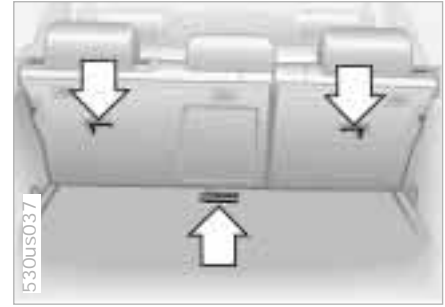

If you use a child restraint system with a tether strap, three additional tether anchorage points (refer to the arrows in the illustration) have been provided. Depending on the location selected for seating in the rear passenger area, attach the tether strap to the corresponding anchorage point to secure the child restraint system. Remove the cover first on the middle location.

If the respective seating position is fitted with a headrest lift the headrest and pass the tether strap between the headrest and the seat back.

Adjust the tether strap according to the child restraint manufacturer's instructions.

 Before installing any child restraint device or child seat, please read the following:

Never install a rear-facing child restraint system in the front passenger seat of this vehicle.

Your vehicle is equipped with an airbag supplemental restraint system for the front passenger. Because the backrest on any rear-facing child restraint system (of the kind designed for infants under 1 year and 20 lbs./9 kg) would be within the airbag's deployment range, you should never mount such a device in the front passenger seat, since the impact of the airbag against the child restraint's backrest could lead to serious or fatal injuries.

If it is necessary for a child (not an infant) to ride in the front seat, certain precautions should be taken. First, move the passenger seat as far away from the dashboard as possible. This important precaution is intended to maximize the distance between the airbag and the child. Older children should be tightly secured with a safety belt. Younger children should be secured in an appropriate forward-facing child restraint system that has first been properly secured with a safety belt. Never install a rear-facing child restraint system in the front passenger seat.

We strongly urge you to carefully read and comply with the instructions for installation and use provided by the child restraint's manufacturer whenever you use such a device.

Be sure that all occupants (of all ages) remain properly and securely restrained at all times. ◀

All rear seating positions in your vehicle meet the recommendations of SAE J1819, an industry-recommended practice for securing child restraint systems in motor vehicles.



All of the rear belt retractors and the front passenger's safety belt can be locked for mounting and securing child restraint systems.

Information regarding this is located near the buckle latch of each safety belt.

To lock the belt

Pull the entire length of the belt from the belt retractor. Allow the reel to retract the belt somewhat and engage the buckle, then tighten the belt against the child restraint system. The retraction mechanism is now locked.

62 Child seat security

To release the belt

Release the buckle, remove the child-restraint device and allow the belt retractor to reel the belt completely in.



Slide the safety lever on the rear doors downward:

The door can now be opened from the outside only.

Steering/Ignition lock

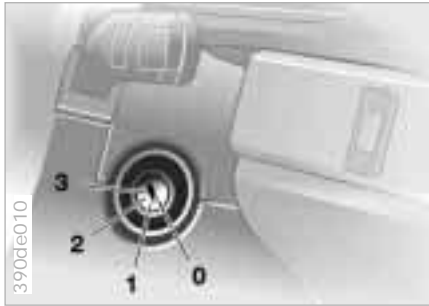

0 Steering lock engaged

The key can only be inserted and removed in this position.

After removing the key, turn the steering wheel slightly to the left or right until you hear the lock engage.

An acoustic warning is sounded when you fail to remove the ignition key after opening the driver's door.



Do not move the selector lever from the "Park" position until the engine is running (ignition key in position 2).

In order to turn the key to position 0 or to remove it, first move the selector lever to the "Park" position (Interlock). ◀

1 Steering lock disengaged

You will find that it is often easier to turn the ignition key from position 0 to position 1 when you move the steering wheel slightly to help disengage the lock.

2 Ignition on

All electrical equipment and accessories are available for use.

3 Starting the engine

64 Starting the engine

Before starting

- ▷ Engage the parking brake.
- ▷ Be sure that the selector lever is in "Park" position.



Do not allow the engine to run in enclosed spaces. The exhaust gases contain carbon monoxide, an odorless and colorless, but highly toxic gas. Breathing the exhaust gases poses an extreme health risk, and can lead to unconsciousness and death. Do not leave the vehicle unattended with the engine running. An unattended vehicle with a running engine represents a potential safety hazard. ◀

Do not press the accelerator pedal while starting the engine.



Your BMW is equipped with the convenience starting feature. Simply turn the key to position 3 (starter) and then release it immediately. The starter continues to operate automatically.

The automatic starting mode will not operate if the battery voltage is low. The engine can be started by means of jump-starting (refer to page 170). ◀

Do not allow the engine to warm up by leaving it running while the vehicle remains stationary. Instead, begin to drive immediately at a moderate engine speed.

Should the engine fail to start on the first attempt (if it is very hot or cold, for instance):

- ▷ Press the accelerator pedal halfway down while the starter is engaged.

Engine idle speed is controlled by the engine computer system. Increased speeds at startup are normal and should decrease as the engine warms up. If engine speed does not decrease, service is required.

To prevent the battery from discharging, always deactivate electrical devices that are not in use. Switch the ignition off when the vehicle is not being driven.

Switching off the engine

Turn the ignition key to position 1 or 0.

⚠ Never remove the ignition key while the vehicle is rolling. If you did so, the ignition lock would engage when the steering wheel is turned. Always remove the ignition key and engage the steering lock before leaving the vehicle. Always engage the parking brake and place the selector lever in "Park" when parking on slopes and inclined surfaces. ◀

The vehicle must be stationary and the selector lever in "Park" before you can remove the ignition key.

Parking brake



To engage

The lever engages automatically and the "PARK BRAKE" or "BRAKE" (in Canada "P") indicator lamp comes on in the instrument cluster in ignition key position 2. Refer to pages [22](#) and [23](#).

To release

Pull up slightly on the lever, press the button and lower the lever.

The parking brake is primarily designed to prevent the vehicle from rolling while parked. It operates against the rear wheels.

⚠ If, in exceptional circumstances, it should be necessary to engage the parking brake while the vehicle is in motion, do not pull it with excessive pressure. Keep your thumb pressed against the release button while carefully pulling up the lever to apply moderate pressure.

Excessive pressure can lead to over-braking and loss of traction (fishtailing) at the rear axle.

The brake lamps do not come on when the parking brake is applied.

Always engage the parking brake and place the selector lever in "Park" when parking on slopes and inclined surfaces. ◀

To avoid corrosion, apply the parking brake lightly from time to time when coasting to a standstill (at a traffic signal, for instance), provided that it is safe to do so.

Automatic transmission with Steptronic



You can drive as with a normal automatic transmission. In addition, you can also shift manually.

When you move the selector lever from the "D" position to the left into the M/S range, the performance-oriented shift programs of the automatic transmission are engaged. As soon as you briefly touch the selector lever in the "+" or "-" direction, Steptronic changes the gear. The manual mode is engaged. When you wish to use the automatic transmission mode again, move the selector lever to the right into the "D" position.

The automatic transmission of your BMW is equipped with Adaptive Transmission Control (ATC), a system which reacts with precision to your individual driving style and the driving conditions.

To achieve this, different shift programs are automatically engaged.

For additional details concerning the ATC, please refer to the chapter describing "Advanced technology" on page 176.

Selector lever positions

P R N D M/S

The transmission range display varies according to the equipment of your vehicle (refer to the illustrations).

Starting the engine

The engine can only be started in selector lever positions P ("Park") or N ("Neutral").

Range selection

A detent prevents inadvertent shifts to the "Reverse" or "Park" selector lever positions. To disengage the detent, press the button on the front side of the shift knob (arrow).



While the vehicle is stationary and before shifting out of "Park" or "Neutral," depress the footbrake in order to disengage the selector lever's lock mechanism (Shiftlock). Hold the footbrake down until starting off. The vehicle will otherwise "creep" when a drive position is engaged. ◀

Automatic transmission with Steptronic



If you leave the vehicle with the engine running, move the selector lever to the "Park" or "Neutral" position and apply the parking brake. If you fail to do this, the vehicle could move. Do not leave the vehicle unattended with the engine running. An unattended vehicle with a running engine represents a potential safety hazard. ◀

P – Park

Select "Park" only when the vehicle is completely stopped. The transmission locks to prevent the rear wheels from turning.

R – Reverse

Select "Reverse" only when the vehicle is completely stopped. When you select "Reverse", the backup lamps will turn on automatically when the ignition key is in position 2.

N – Neutral

Select "Neutral" only if your journey is interrupted for a longer period.

D – Drive (automatic shift program)

This position is designed for driving under all normal operating conditions. All forward gears are available.

"Kickdown"

In the "Kickdown" mode, you achieve maximum performance. Depress the accelerator pedal past the increased resistance point at the full-throttle position.



M/S Manual mode and Sport Program

When you change from D to M/S, the Sport Program is activated. This is indicated by "D S" in the gear selection display. The Sport Program is designed for performance-oriented driving.

With the first brief touch, the automatic transmission shifts from the Sport Program to the manual mode. When you move the selector lever forward in the "+" direction, the transmission shifts up. When the lever is moved back in the "-" direction, the transmission shifts down. Depending on the equipment version, 1 to 5 or M1 to M5 is indicated in the transmission range display.

Upshifts or downshifts will only be carried out by the ATC at appropriate engine speeds and road speeds. If the

engine speed is too high, for instance, the downshift will not be executed. The gear selected will appear briefly in the instrument cluster followed by the current gear.

 If you are driving in the manual mode and wish to accelerate rapidly – to pass another vehicle, for example – shift down manually or with the kickdown function. ◀

You can only change from M/S to selector lever positions "P," "R" and "N" via the "D" position.

In the following situations, the Steptronic "thinks" for you in the manual mode:

- ▷ In order to prevent engine overspeeding, the transmission shifts automatically to the next higher gear shortly before the RPM cutoff point.
- ▷ At low speeds, the transmission shifts down automatically – you do not have to act.
- ▷ In the "Kickdown" mode, the transmission shifts down to the lowest possible gear based on the engine speed.
- ▷ Depending on the situation – when driving in adverse winter conditions, for example – you may also start out in 2nd or 3rd gear.

Electronic transmission control module



If the indicator lamp comes on or the message "TRANS.FAIL-SAFE PROG" appears in the Check Control*, there is a fault in the transmission system.

Bring the vehicle to a stop. Move the transmission selector lever to "P." Set the parking brake and turn the engine off (ignition key to position 0).

Wait a few seconds, then start the engine.

If the indicator lamp goes out after a few seconds, normal transmission performance has been restored. You may continue to drive as usual. If the indicator lamp does not go out, you can place the selector lever in all positions. However, the vehicle will now only drive forward with limited gear selection.

If this should occur, avoid extreme engine loads and consult the nearest authorized BMW center.



Do not work in the engine compartment when a drive gear (forward or reverse) is engaged. If you do this, the vehicle could move. ◀

Information on jump-starting, tow-starting and towing begins on page [170](#).



- 1 High beams (blue indicator)
- 2 Headlamp flasher (blue indicator)
- 3 Turn signal indicator (green indicator accompanied by periodic clicking sound from the relay).

If the indicator lamp and the clicking from the relay are both faster than normal, one of the turn indicators has failed.

To signal briefly

Press the lever up to but not beyond the detent. It then returns to the center position when released.



- 0 Wipers retracted
- 1 Intermittent wipe or rain sensor*
- 2 Normal wipe
- 3 Fast wipe
- 4 Brief wipe
- 5 Clean the windshield
- 6 Special wash program*
- 7 Rotary dial for control of the wipe interval or the sensitivity of the rain sensor*.

0 Wipers retracted (home position)

The left wiper is partially concealed by the hood. In order to bring the wipers to roughly a vertical position (this is important for changing the wiper blades or to fold the wipers out during frosty weather, for example):

- ▷ With the lever in position 1, switch off the ignition as soon as the wipers come to a stop.

If equipped with a rain sensor*:

- 1 Switch on the wipers with the lever in position 1, 2 or 4.
- 2 When the wipers are approximately vertical, switch the ignition off.

For changing the wiper blades, refer to page 154.

-  Fold the wipers back down onto the windshield before you turn the ignition key to position 1 or 2 again. If you do not, they could be damaged. ◀

1 Intermittent wipe or rain sensor*

Intermittent wipe:

You can set the wipe interval to four stages with rotary dial 7.

In addition, the wipe interval is varied automatically depending on road speed.

Rain sensor:

When the rain sensor is activated, the windshield wiper is controlled automatically, depending on the degree of wetness of the windshield (in both snow and rain). You do not have to be concerned with switching the windshield wiper on or off or adjusting the wipe interval between intermittent and full wipe. Instead, you can concentrate fully on the traffic conditions. This is especially important under adverse weather conditions.

The rain sensor is positioned on the windshield, directly in front of the interior rearview mirror.

To activate the rain sensor:

Move the lever to position 1 with the ignition key in position 1 or higher. The wipers travel once across the windshield, regardless of the weather conditions.

You can leave the lever permanently in position 1. It is then only necessary to activate the rain sensor from ignition key position 1 and up. To do this,

- ▷ turn rotary dial 7 briefly or
- ▷ clean the windshield 5 or use the special wash program 6.

To adjust the sensitivity of the rain sensor:

Turn rotary dial 7.



Turn the rain sensor off in automatic car washes. If you do not, damage may occur if the wipers switch on unintentionally. ◀

2 Normal wiper speed

The system switches automatically to intermittent operation when the vehicle is not moving (not on vehicles with the rain sensor*).

3 Fast wiper speed

The wipers operate at normal speed when the vehicle is not moving (not on vehicles with the rain sensor*).

5 Clean the windshield

The system sprays washer fluid against the windshield and activates the wipers for a brief period.

If you pull the lever only briefly, the system sprays washer fluid onto the windshield without activating the wipers.

6 Special wash program*

As at 5; there are also several additional wash cycles, and the headlamps are cleaned*.

This program is recommended after you have driven on extremely dirty roads.

Headlamp washers*

- ▷ With the Special wash program 6
- ▷ With every fifth actuation of Clean windshield 5 when the vehicle's lighting is switched on.



Do not use the washers if there is any danger that the fluid will freeze on the windshield. If you do so, your vision could be obscured. For this reason, use an antifreeze agent. Refer to page 136.

Do not use the washers when the reservoir is empty. This could cause damage to the washer pump. ◀

Windshield washer jets

The windshield washer jets are warmed automatically when the ignition key is in position 2.

Washer/Wiper system



Programming is deleted:

- ▷ Approx. 10 seconds after the lever is placed in position 0 or
- ▷ after the engine is switched off.

For changing the wiper blade, refer to page [154](#).

Rear window wiper

- 0 Retracted (home) position of the rear window wiper.
- 1 Rear window wiper in intermittent operation. When "Reverse" is selected, continuous operation is switched on automatically.
- 2 Clean the rear window.

You can also program the interval:

- ▷ Switch briefly from position 0 to position 1.
- ▷ The time until reactivation (from position 0 to 1) is the programmed interval (max. 30 seconds).

Rear window defroster 71



To activate

Press the button: as long as the indicator lamp remains on, the rear window defroster continues at high-output (rapid thaw).

After the indicator lamp goes out, the defroster continues operating at reduced power for a limited period before deactivating automatically.

To deactivate

Press the button if the indicator lamp lights up.



You can store and automatically maintain any desired vehicle speed above approx. 20 mph (30 km/h).

To activate the system

In ignition key position 1 or 2:
Press button 4, the indicator lamp in the instrument cluster comes on. You can now use the cruise control.

For the arrangement of the buttons in the Sports steering wheel*: refer to page [27](#).

To store and maintain speed or to accelerate

Press button 1 briefly:

The system registers and maintains the current vehicle speed. Every time you briefly touch the button, the speed increases by approx. 0.6 mph (1 km/h).

Press and hold button 1:

The vehicle accelerates without pressure on the accelerator pedal. When you release the button, the system registers and maintains the current speed.



If, on a downhill gradient, the engine's braking effect is not sufficient, the controlled speed can be exceeded. Speed can drop on uphill grades if the engine output is insufficient. ◀

To decelerate

Press button 2 briefly:

When cruise control is active, every briefly touch of the button reduces the speed by approx. 0.6 mph (1 km/h).

Press and hold button 2:

With the cruise control active, the system automatically reduces the throttle opening to slow the vehicle. When you release the button, the system registers and maintains the current speed.

Cruise control

To interrupt the cruise control

When the system is activated, press and hold button 4. The indicator lamp stays on. You can use the cruise control again as required.

In addition, the system is also automatically deactivated in response to the following conditions:

- ▷ When you apply pressure to the brake pedal.
- ▷ When you move the automatic transmission selector lever from "Drive" to "Neutral".
- ▷ If you exceed or fall below the programmed speed for an extended period (by depressing the accelerator, for example).

To resume the stored setting

Press button 3:

The vehicle accelerates to and maintains the last speed stored. When you turn the ignition key to position 0, the stored speed is deleted and the system is deactivated.

To deactivate the system

When the cruise control has been canceled, press button 4 again. The indicator lamp goes off and the stored speed is canceled.



Do not use cruise control on twisting roads, when high traffic density prevents driving at a constant speed, when the road surface is slick (snow, rain, ice), or when the road surface is loose (rocks or gravel, sand). ◀

74 Odometer, outside temperature display



1 Odometer

You can activate the displays shown in the illustration with the ignition key in position 0 by pressing the button in the instrument cluster (arrow).

The range of available displays varies according to your individual vehicle's equipment.

2 Trip odometer

To reset the trip odometer to zero, press the button (arrow) with the ignition key in position 1 or 2.

3 Outside temperature display

The outside temperature appears in the display panel from ignition key position 1 and higher.

You can change the units of measurement (°C/°F) by

- 1 pressing and holding down the button (arrow) with the ignition key in position 1.
- 2 and then turning the ignition key to 0.

Ice warning

If the outside temperature drops to approx. +37.5 °F (+3 °C), a signal sounds as a warning and the display flashes for a brief period.

The warning is repeated whenever the temperature climbs to at least +43 °F (+6 °C) following the last warning and then drops back to +37.5 °F (+3 °C).



The ice warning does not alter the fact that surface ice can form at temperatures above +37.5 °F (+3 °C), on bridges or shaded road surfaces, for instance. ◀

Tachometer



Do not operate the engine with the needle in the red overspeed zone of the gauge.

To protect the engine, the engine-management system automatically interrupts the fuel supply in this range; the resulting effect resembles that associated with a sudden loss of power.

Energy control



Indicates the current fuel consumption in mpg (in liters/100 km on Canadian vehicles). This allows you to see whether your current driving style is conducive to fuel economy with minimum exhaust emissions.

When the vehicle is stationary, the display goes to "Maximum" (zero on Canadian models).

Fuel gauge



When you switch on the ignition, the indicator lamp comes on briefly to confirm that the system is operational.

If the indicator lamp comes on and stays on, there are approx.

▷ 2.6 gallons (10 liters) of fuel still in the tank.

Tank capacity: refer to page [187](#).

Certain operating conditions (such as those encountered in mountainous areas) may cause the needle to fluctuate slightly.

 Please refuel early, as driving to the last drop of fuel can result in damage to the engine and/or catalytic converter. ◀

76 Coolant temperature gauge



Between the blue and red zones

Normal operating range. It is not unusual for the needle to rise as far as the edge of the red zone in response to high outside temperatures or severe operating conditions.

Checking coolant level: refer to page [140](#).

Blue

The engine is still cold. Drive at moderate engine and vehicle speeds.

Red

When you switch on the ignition, the warning lamp comes on briefly to confirm that the system is operational.

Comes on while driving and the message "COOLANT TEMPERATURE" appears in the Check-Control*: the engine is overheated. Shut off the engine immediately and allow it to cool down.

Service Interval Display



The range of available displays varies according to your individual vehicle's equipment.

Green lamps

The number of illuminated lamps decreases as the time for your next maintenance visit approaches.

Yellow lamp

This field appears together with OILSERVICE or INSPECTION.

Maintenance is due. Please contact your BMW center for an appointment.

Red lamp

The maintenance deadline has been passed.

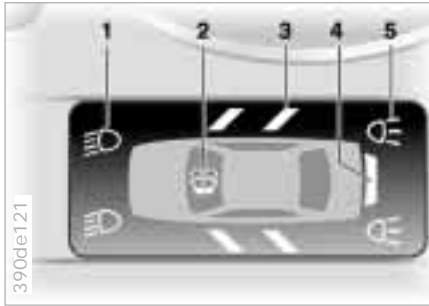

Graphic display*

The following alerts or status messages are displayed with icons from ignition key position 2 and up until the defects are corrected:

- 1 Check low beams.
- 2 Add washer fluid (goes out after approx. 1 minute).
- 3 Door open.
- 4 Tailgate open.
- 5 Check brake and tail lamps.
A defective center brake lamp is indicated by the upper symbol.

When you open the door after stopping, a warning signal sounds without a visual indicator for:

- ▷ LIGHTS ON and
- ▷ KEY IN IGNITION LOCK.

Alphanumeric display*

Text messages are used to alert the driver to system malfunctions when the ignition key is turned to position 2. The alert is accompanied by a gong.

- 1 Status report symbol
- 2 Display
- 3 CHECK button

Messages concerning system faults are differentiated based on two priorities:

Priority 1

These defects are immediately indicated by a gong and a flashing warning symbol 1. Simultaneous defects will be displayed consecutively. These status messages remain in the display until the defects are corrected. They cannot be deleted by pressing the CHECK button 3:

- ▷ RELEASE PARKINGBRAKE
- ▷ COOLANT TEMPERATURE
The coolant is overheated. Stop the vehicle immediately and switch off the engine. Refer to pages [76](#) and [140](#).
- ▷ STOP! ENGINE OILPRESS
The oil pressure is too low. Stop the vehicle immediately and switch off the engine. Refer to page [22](#).

▷ CHECK BRAKE FLUID

Indicates that brake fluid is down to approximately the minimum level. Top up the brake fluid at the next opportunity. Refer to page [141](#). Have the cause of the brake fluid loss diagnosed and corrected by your BMW center.

▷ SELFLEVEL. SUSP. INACT

Please consult the nearest authorized BMW center. Refer to page [125](#).

▷ SPEED LIMIT*

You will see this message if the programmed speed limit has been exceeded.

Priority 2

These displays appear for 20 seconds when the ignition key is turned to position 2. The warning symbols remain after the message disappears. You can call up the messages again for display by pressing the CHECK button.

▷ TRUNKLID OPEN

This message appears only at the start of a trip.

▷ DOOR OPEN

This message appears after a minimal defined road speed has been exceeded.

▷ FASTEN SEAT BELTS*

In addition to this message, an indicator lamp with the safety belt icon appears and an acoustical signal is sounded.

▷ WASHER FLUID LOW

The fluid level is too low; top up at the next opportunity. Refer to page [136](#).

▷ CHECK ENGINE OIL LEV

Add engine oil as soon as possible. Refer to page [137](#).

▷ OUTSIDE TEMP. +23 °F (-5 °C)

This display is only an example. The current temperature is displayed at outside temperatures of +37.5 °F (+3 °C) and below. Refer also to page [74](#).

▷ CHECK BRAKE LIGHTS

A lamp has failed or the electrical circuit has a fault. Refer to pages [157](#) and [158](#) or consult an authorized BMW center.

▷ CHECK LOWBEAM LIGHTS

CHECK SIDE LIGHTS

CHECK REAR LIGHTS

CHECK FRONT FOG LAMPS

CHECK LICPLATE LIGHTS

CHECK HIGHBEAM LIGHTS

CHECK BACK UP LIGHTS

Defective bulb or circuit. Refer to page [155](#) or consult an authorized BMW center.

Check Control

- ▷ TRANS. FAILSAFE PROG
Please consult the nearest authorized BMW center. Refer to page 68.
- ▷ CHECK BRAKE LININGS
Have the brake linings inspected by your BMW center. Refer to page 123.
- ▷ CHECK COOLANT LEVEL
Coolant too low, top up at the next opportunity. Refer to page 140.
- ▷ ENGINE FAILSAFE PROG
There is a fault in the engine's electronic control system. When braking, higher brake application pressure may be necessary and brake pedal travel may be significantly longer. Have the fault checked by your authorized BMW center.

Displays after completion of trip

All of the malfunctions registered during the trip appear consecutively when the key is turned to position 0.

The following displays will appear when appropriate:

- ▷ LIGHTS ON
- ▷ KEY IN IGNITION LOCK
- ▷ CHECK ENGINE OIL LEV
Add engine oil at the next opportunity (next stop for fuel). Refer to page 137.

These displays appear when you open the driver's door after parking the vehicle. A supplementary gong is also heard.

Status reports remain available for a period of approx. three minutes after the display goes out and the key is removed from the ignition. Press the CHECK button 3. If there were multiple reports, press the CHECK button repeatedly to view them all in sequence.

To check the Check Control

Press the CHECK button 3 with the ignition key in position 2: CHECK CONTROL OK appears in the display.

No malfunctions are present in the monitored systems.

Onboard computer*

You will find a description of the onboard computer in the Owner's Manual for the Radio and Information System or the Owner's Manual for the onboard monitor.



You can have the Check Control and onboard computer messages displayed in a different language. ◀



Mode selection

From ignition key position 1 and up, you can call up information from the onboard computer using the button in the turn signal lever. By pressing the button briefly in the direction of the steering column, you can call up a new function for display.

The displays appear in the following order: outside temperature, average fuel consumption, cruising range, average speed.

Starting with ignition key position 1, the last active setting is displayed.

The range of available displays varies according to your individual vehicle's equipment.

Outside temperature and average fuel consumption

You can change the units of measurement (°C/°F) for the outside temperature display by

- 1 pressing and holding the trip odometer reset button (in ignition key position 1).
- 2 and then turning the ignition key to 0.

Refer also to page 74.

Operating range and average speed

The computer bases its calculations of the cruising range on the previous driving style and conditions.

This computer ignores any time spent when the vehicle is stationary and the engine is not running in its average speed calculations.

Onboard computer

To cancel the display

If the button in the turn-signal lever is pressed briefly while the average speed is displayed, the onboard computer display can be masked out.

To restart calculations

If you continue to press the button in the turn signal lever, the average values which were just displayed for fuel consumption and speed will be recalculated from that point. The engine must be running for this calculation.

Onboard computer with alphanumeric display*

If your vehicle has Check Control with alphanumeric display, the system's onboard computer is described in the Owner's Manual for the Radio and Information System or the Owner's Manual for the onboard monitor.

The concept

The PDC assists you when you are parking. Acoustical signals inform you of the distance to an obstacle. To do this, four ultrasonic sensors in the front and rear bumpers measure the distance to the nearest object. The monitoring range for the front sensors as well as the two rear corner sensors ends approx. 2 feet (60 cm) behind the respective bumper. The center sensors in the rear have a range of approx. 5 feet (1.50 meters).

Automatic function

The system starts to operate automatically about one second after you select "Reverse" with the ignition key in position 2.



Manual activation

Press the button (arrow); the indicator lamp comes on.

After driving a distance of more than approx. 160 feet (50 meters) or exceeding a speed of approx. 20 mph (30 km/h), the system switches off and the indicator lamp goes out. Switch the system on again as required.

Manual deactivation

Press the button again.

Acoustical signals

The distance to the nearest object is indicated by a tone sounding at various intervals. As the distance between vehicle and object decreases, the intervals between the tones become shorter. A continuous tone indicates the presence of an object less than approx. 1 foot (30 cm) away.

The warning signal is canceled after approx. three seconds if you are moving parallel to a wall.

If there is a malfunction of the system: The indicator lamp flashes and a short steady signal tone is sounded

- ▷ if you activate PDC with the button.
- ▷ when you select "Reverse" for the first time after switching on the ignition.
- ▷ if a malfunction occurs while the PDC system is active.

Switch the system off and have the cause of the malfunction corrected by your BMW center.

 The PDC system does not remove the driver's personal responsibility for evaluating the distance between the vehicle and any obstacles. Even when sensors are involved, there is a blind spot in which objects cannot be detected. This applies especially in those cases where the system approaches the physical constraints of ultrasonic measurement, as occurs with tow bars and trailer couplings, and in the vicinity of thin and painted objects. Certain sources of sound, such as a loud radio, could drown out the PDC signal tone. ◀

 Keep the sensors clean and free of ice or snow in order to ensure that they continue to operate effectively. Do not apply high pressure spray to the sensors for a prolonged period of time. Maintain an adequate distance of more than 4 inches (10 cm). ◀

The concept

DSC maintains vehicle stability, even in critical driving situations.

The system optimizes vehicle stability during acceleration and when starting from a full stop, as well as optimizing traction. In addition, the system recognizes unstable vehicle conditions (understeering or oversteering, for example) and helps to keep the vehicle on a sure course by intervening via the engine and by braking intervention at the individual wheels.

The system starts up automatically each time you start the engine.

Indicator lamp



The indicator lamp in the instrument cluster goes out shortly after you switch on the ignition.

Refer to page 24.

Indicator lamp flashes:

The system is active and governs drive force and braking force.

If the indicator lamp fails to go out after the engine is started, or comes on during normal driving and stays on:

There is a system malfunction or the system was deactivated with the button. You can continue to drive the vehicle normally, but without DSC. Consult your authorized BMW center to have the system repaired.



To deactivate the system

Press the button (arrow); the indicator lamp comes on and stays on.

Traction intervention remains active; that is, braking intervention will continue. Refer also to Four-wheel drive on page 177.

In the following exceptional circumstances, it may be effective to deactivate the DSC for a short period:

- ▷ when rocking the vehicle or starting off in deep snow or on loose surfaces.
- ▷ on sandy road surfaces.
- ▷ on poor surfaces with deep ruts.
- ▷ if the wheels "churn" on muddy surfaces.
- ▷ or when driving with snow chains.

Hill Descent Control (HDC)

 As a result of the traction intervention, the brakes may be subjected to additional loads when the system is deactivated. For this reason, it is possible that the braking intervention will be disabled automatically for a brief period in order to limit brake temperature. To maintain vehicle stability, always drive with the system switched on when possible. ◀

To reactivate the system

Press the button again; the indicator lamp goes out.

 The laws of physics cannot be repealed, even with DSC. An appropriate driving style always remains the responsibility of the driver. We therefore urge you to avoid using the additional safety margin of the system as an excuse for taking risks. ◀

For additional details concerning DSC, please refer to the chapter describing "Advanced technology" on page [177](#).

The concept

HDC is a system for driving downhill on steep roads. This system reduces vehicle speed on steep downgrades, thus allowing you to maintain control of your BMW under these conditions. The vehicle moves at slightly more than walking speed without active intervention from the driver.

You can activate HDC below approx. 20 mph (35 km/h). When driving down steep roads, the vehicle reduces speed automatically down to slightly more than walking speed (approx. 5 mph/8 km/h) and then maintains this speed at a constant.

By applications of the brakes or accelerator, you can alter this speed in the range of approx. 3 mph (5 km/h) to approx. 20 mph (35 km/h). HDC is deactivated automatically if you exceed approx. 35 mph (60 km/h).



To activate the system



Press the button. The green indicator lamp illuminates.

The indicator lamp flashes when the brakes are applied automatically.

To deactivate the system

Press the button again; the indicator lamp goes out.

HDC is deactivated automatically above a road speed of approx. 35 mph (60 km/h) and when the ignition is switched off.

HDC

To use HDC

You can use HDC in every drive position.

In the event of a fault

The indicator lamp goes out in the HDC mode or does not come on when HDC is activated:

HDC is temporarily not available if brake temperature is too high.



If the DSC indicator lamp also lights up:

There is a fault in the HDC and DSC systems. Have your BMW center inspect this system as soon as possible.



Side lamps (side marker lamps)



With the switch in this position, the front, rear and side vehicle lighting is switched on. For lighting on one side for parking: refer to page [87](#).

Low beams



When the ignition is switched off and the low beams are on, only the side lamps (side marker lamps) remain on.

LIGHTS ON warning

In ignition key position 0, a buzzer sounds for a few seconds after the driver's door is opened if the headlamps have not been switched off.

On vehicles with alphanumeric Check Control*:

The reminder is given through the Check Control.

Daytime-driving lamp*

The headlamps are automatically switched on for daylight driving at ignition key position 2.



Turn the rotary dial to adjust the illumination intensity.



- 1 High beam (blue indicator lamp)
- 2 Headlamp flasher (blue indicator lamp)
- 3 Parking lamp

Parking lamp, left or right*

With the ignition key in position 0, engage the lever in the appropriate turn-signal position.



Fog lamps



A green indicator lamp appears in the instrument cluster to indicate that the front fog lamps are on.

If the high beam is switched on, the fog lamps go out.



The interior lamps operate automatically.

Switching the interior lamps on and off manually

Press the button (arrow).

If you want the interior lamps to remain off all the times, press and hold the button for approximately 3 seconds.

Press the button briefly to revert to normal operation.

The cargo area lamps function in the same manner.

The button for the interior lamps in the rear passenger area only switches these lights on and off.

88 Interior lamps

Footwell lamps

The footwell lamps are controlled in the same manner as the front interior lighting.

Front area lighting*

This lighting system in the two exterior mirrors lights the ground in the area near the two front doors. It is also controlled in the same manner as the front interior lighting, but it does not function while the vehicle is moving.

Reading lamps



Reading lamps are provided in the front and rear* near the interior lamp. They can be switched on and off with the button (arrows) next to each lamp.

 In order to prevent battery discharge, all of the lamps in the vehicle are switched off automatically approx. 15 minutes after the ignition key is turned to position 0. ◀

[Overview](#)[Controls](#)[Car care](#)[Repairs](#)[Technology](#)[Data](#)[Index](#)

90 Automatic climate control

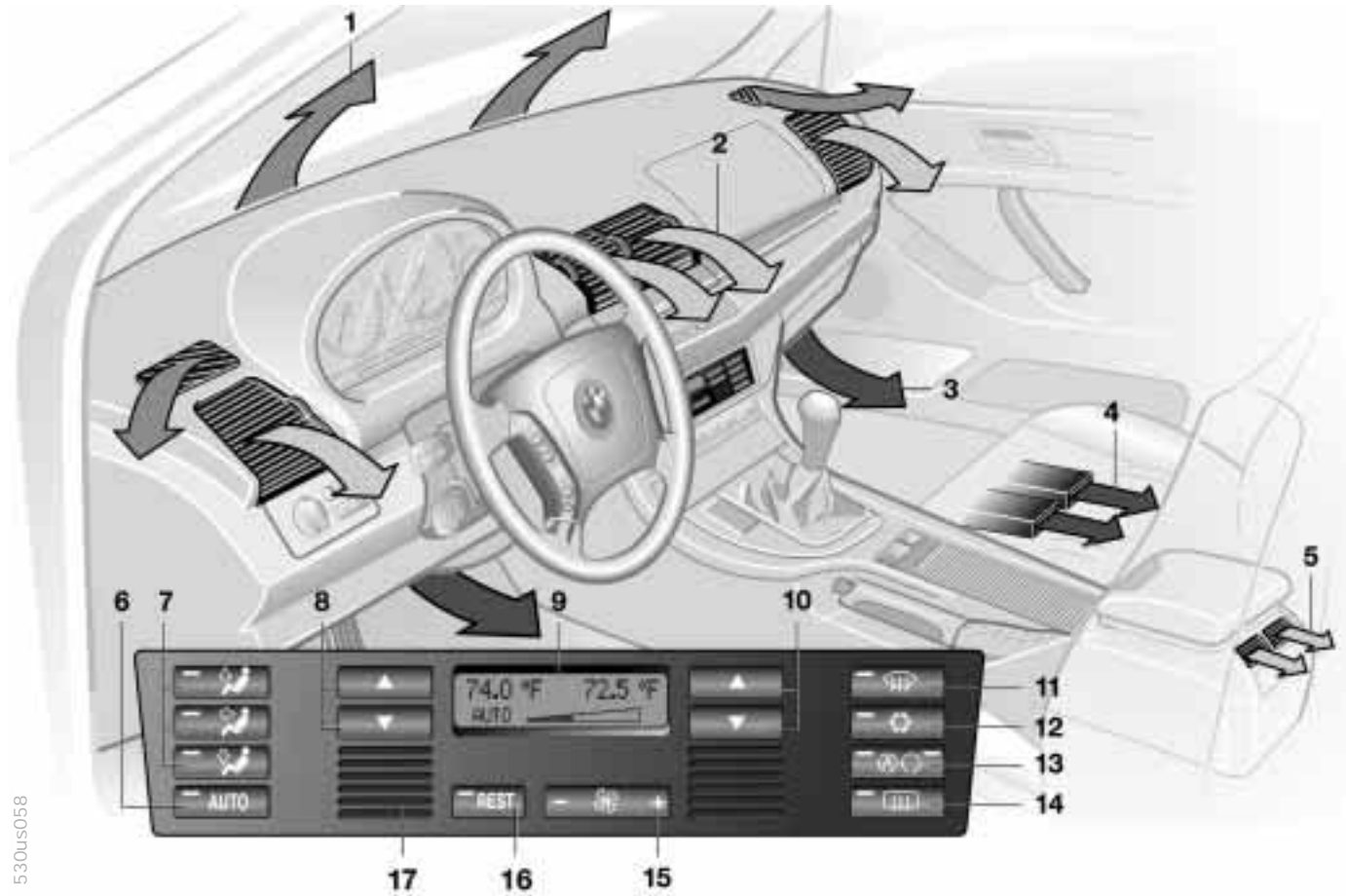

530us058

Automatic climate control

- 1 Air flow directed toward the windshield and side windows
- 2 Air flow for the upper body
The side rotary dials provide infinitely-variable regulation of the air supply, while the levers change the airflow direction. The center rotary dial controls the temperature of the air as it flows out. Refer to page [94](#)
- 3 Front footwell ventilation
- 4 Rear footwell ventilation
- 5 Air flow for the upper body in the rear seat [94](#)
- 6 Automatic air distribution [92](#)
- 7 Individual air distribution [92](#)
- 8 Temperature control – left-hand side [92](#)
- 9 Display for temperature and air supply [93](#)
- 10 Temperature control – right-hand side [92](#)
- 11 To defrost windshield and side windows [93](#)
- 12 Air conditioner [93](#)
- 13 Automatic recirculated air control (AUC) [93](#)
- 14 Rear window defroster [71](#), [94](#)
- 15 Air supply [93](#)
- 16 Residual heat mode [94](#)
- 17 Air grille for interior temperature sensor – please keep clear and unobstructed

Tips for pleasant driving

Use the automatic system (that is press AUTO button 6). Select an interior temperature that is comfortable for you – we recommend 72 °F (22 °C). When the outside temperature is above 41 °F (5 °C), you can also use the air conditioner 12. This will dry the air as well as preventing condensation on the window surfaces – if there are passengers with damp clothing, for example. Set the air outlets 2 so that the air flows past you and is not directed straight at you. Set the rotary dial between the outlets 2 for the upper body to a central position so that cooler air will help to prevent fatigue during the journey.

Detailed setting options are described for you in the following section.



Your vehicle is set in such a manner that, when you unlock the vehicle via remote control with your personalized key, your own setting for the automatic climate control is initiated. ◀

Automatic air distribution



The AUTO program assumes the adjustment of the air distribution and the air supply for you and also adapts the temperature to external influences (summer, winter) to meet preferences you can specify. This program maintains a comfortable in-car climate regardless of the season. Select an interior temperature that is comfortable for you – we recommend 72 °F (22 °C).



The selected temperature and AUTO for the air flow appear in the display 9. Refer to the overview on page 90. Open the ventilation outlets for the upper body. Switch on the air conditioner 12 in warm weather. The maximum cooling capacity is achieved when you set rotary dial 3 (refer to page 94) to cold.

Individual air distribution



You can cancel the AUTO program by selecting specific air distribution patterns for your personal comfort.



You can direct air to flow onto the windows , toward the upper body , and into the footwell .

Temperature



You can make individual temperature adjustments on the driver's side or the front passenger side. Your settings will be shown in the display 9. The displayed temperatures are reference values for the interior temperature. We recommend 72 °F (22 °C) as a comfortable setting, whether the air conditioner is operating or not. When you start the vehicle, this system ensures that the selected temperature is achieved as quickly as possible. It then maintains this temperature, regardless of the season.

Set the rotary dial 3 (refer to "Draft-free ventilation" on page 94) to a medium position to provide somewhat cooler air. This helps to promote driving without fatigue. Utilize this method of mixing air especially for making minor adjustments for personal comfort.



You can set uncontrolled heater output up to 90 °F (32 °C). Full cooling output is available from the air conditioner down to 60 °F (16 °C). ◀

Automatic climate control

Air supply



In the "AUTO" program, the air flow is controlled automatically. AUTO will appear in the display 9 (refer to the overview on page 90). Use "+" and "-" to vary the air flow. When your setting is displayed by bars, the automatic air flow is switched off. Automatic air distribution maintains its setting. You can reactivate the automatic air supply by pressing the "AUTO" button.

When you press "-" during operation at minimum blower speed all displays are canceled: the blower, heating and air conditioner are switched off. The outside air supply is closed. You can switch the system back on by pressing any button of the automatic climate control (except the REST button 16).

To defrost the windshield and door windows



This program quickly removes ice and condensation from the windshield and the side windows.

Air conditioner



The air is cooled and dehumidified and – depending on the temperature setting – warmed again when the air conditioner system is switched on. Depending on the weather, the windshield may fog over briefly when the engine is started. Use the button to switch the air conditioner off at outside temperatures below approx. 41 °F (5 °C). This will help to prevent the windows from fogging up.

If the windows fog over after switching the air conditioner off, switch it back on.



Condensation forms in the air conditioner system during operation, which then exits under the vehicle. Traces of condensed water of this kind are thus normal. ◀

Automatic recirculated air control (AUC)



If there are unpleasant odors or pollutants in the outside air, you can temporarily block the air flow from the outside. The system then recirculates the air currently within the vehicle.

Press the button repeatedly to run through the following control sequence:

- ▷ Indicator lamps off: outside air flow operational.
- ▷ Left-hand indicator lamp on – AUC mode: the system recognizes pollutants in the outside air and blocks the flow of air when necessary. The system then recirculates the air currently within the vehicle. Depending on the air quality, the automatic system then switches back and forth between outside air supply and recirculation of the air within the vehicle.
- ▷ Right-hand indicator lamp on: the flow of external air into the vehicle is completely blocked. The system then recirculates the air currently within the vehicle.

If you have a multifunction steering wheel with the button for recirculated air (refer to page 26), you can also use this button to switch between "Off" and the recirculated air mode or AUC and the recirculated air mode.

 If the windows fog over in the recirculated air mode, switch the recirculated air off and increase the air supply as required. ◀

Rear window defroster

 When the rear window defroster is activated, the indicator lamp comes on. The rear window defroster switches off automatically.

Residual heat mode

 The heat which is stored in the engine is utilized for heating the interior when the engine has been switched off (while waiting at a railroad crossing, for instance). In ignition key position 1, you can alter the settings of the automatic climate control. With the ignition key in position 0, the system automatically directs heated air to the windshield, side windows and footwells.

 This function may be activated when the outside temperature is below approx. 59 °F (15 °C), the engine is at operating temperature, and the battery is adequately charged. ◀

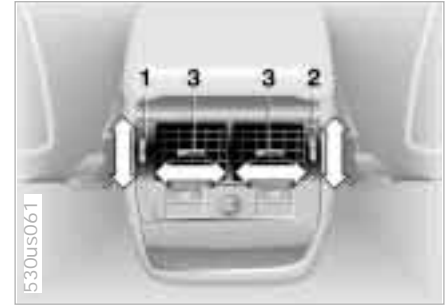

Draft-free ventilation

You can adjust the blower controls for the upper body area to select the optimum airflow rates and directions for your personal comfort:

Use rotary dials 1 to open and close the air outlets through an infinitely-variable range. You can adjust the direction of the airflow with levers 2.

Set the outlets so that the air flows past you and does not flow directly on you.

Rotary dial 3 allows you to control the temperature of the air flow from these air outlets as desired:

- ▷ Turn toward blue – colder
- ▷ Turn toward red – warmer

Rear passenger area climate control

- 1 Air supply
- 2 Temperature
- 3 Adjusting the direction of the airflow



Air supply

0 Blower off

1 Maximum blower speed

You can adjust the air supply for the air outlets through an infinitely-variable range between the "0" and "1" settings.

In the "0" setting, the blower is switched off and the supply of air through the air outlets is blocked.

Individual adjustments on the front-seat control elements influence the air supply for rear passenger area climate control.



Temperature

Passengers in the rear seating area can adjust their own temperature for the air outlets:

- ▷ Turn toward blue – colder
- ▷ Turn toward red – warmer

When you start the vehicle, this system ensures that the selected temperature is achieved as quickly as possible. It then maintains this temperature, regardless of the season.

 A temperature adjustment is only possible when the blower is switched on (not in the "0" setting). ◀

Microfilter, activated-charcoal filter

The microfilter removes dust and pollen from the incoming air. The activated-charcoal filter provides additional protection by filtering gaseous pollutants from the outside air. Your BMW center replaces this combined filter as a standard part of your scheduled maintenance. A substantial reduction in air flow indicates that the filter needs to be replaced early.



Front

The seat cushion and backrest can be heated when the ignition key is in position 2.

You can call up different heating modes by repeatedly pressing the keys.

When the three indicator lamps are illuminated, the highest heating mode is activated. One lamp indicates the lowest heating mode. The temperature is regulated with a thermostat in each mode.

You can also switch the higher heating modes off directly:
Press the button and hold it slightly longer.



Rear

The function is the same as for front seat heating. You can select between two heating modes.



Steering wheel heating functions in ignition key position 2.

Press the button (arrow) to activate or deactivate this system.

The lamp within the button lights up when the steering wheel heater is in operation.

If you have a multifunction steering wheel without steering wheel heating, the button for the recirculated air mode is in this location (refer to page 26).

Roller sun blind*

Roller sun blinds for rear side windows*

Use the strap to pull out the blinds, then hook them in the provided attachment.

Independent ventilation system*

You can use this system to ventilate the interior and lower its temperature, using the blower of the automatic climate control.

The independent ventilation system is operated via the multi-information display (MID) or the onboard monitor. Refer to the separate Owner's Manual.

You can set two different times for the system to start; it will remain active for 30 minutes. You can also turn it on and off directly. Since the system uses a substantial amount of electrical current, you should refrain from activating it twice in succession without allowing the battery to be recharged in normal operation between use.

When a preselected activation time is set, the independent ventilation system is operational at outside temperatures above 60 °F (16 °C), or by direct switch activation. It cannot be switched on when the vehicle is moving.

The air emerges via the air outlets for the upper body. Therefore, the air outlets must be open for the system to operate.

The concept

The BMW Universal Transmitter replaces up to three hand-held transmitters of different devices such as garage-door openers, alarm systems, or door locking systems. The BMW Universal Transmitter recognizes and "learns" the transmitted signal of each of the original hand-held transmitters.

The signal of an original hand-held transmitter can be programmed on one of the three channel keys. Following that, each of the devices can be actuated with the appropriately-programmed channel key. The indicator lamp flashes to confirm transmission of the signal.

If the vehicle is sold, the memory of the channel keys should be cleared as described on page 100.

 During programming and before every remote actuation of a programmed device by the BMW Universal Transmitter, check to be sure that there are no persons, animals or objects within the actuation range of the device in order to prevent possible injuries or damage. Also, comply with the safety precautions of the original hand-held transmitter. ◀



To Canadian residents:
During programming, your hand-held transmitter may automatically stop transmitting after two seconds. This may not be long enough to program the BMW Universal Transmitter. If you are programming from one of these hand-held transmitters, the Universal Transmitter's light may begin to flash in a series of double-blinks. If this occurs, continue to hold the button of the Universal Transmitter while you reactivate your hand-held transmitter. You may have to repeat this function several times while programming. ◀



Before programming, read the "User information" section on page 100. ◀

Original hand-held transmitter

If this symbol is present on the packaging or in the instructions of the original hand-held transmitter, it may be assumed that this hand-held transmitter is compatible with the BMW Universal Transmitter.

Checking for the conversion code

To determine whether the original hand-held transmitter is provided with a conversion-code system, you may either read the instructions for the original hand-held transmitter or program a channel key as described on the next page (left-hand column under "Programming").

Then press and hold the programmed channel key of the BMW Universal Transmitter. If the indicator lamp of the BMW Universal Transmitter flashes for two seconds and then comes on steadily, the original hand-held transmitter is provided with a conversion-code system. With a conversion-code system, program the channel keys as described on the next page (right-hand column under "Programming a hand-held transmitter with conversion code").



If you have additional questions, please consult your BMW center or call 1-800-355-3515. You can also visit this website www.bmwusa.com. ◀

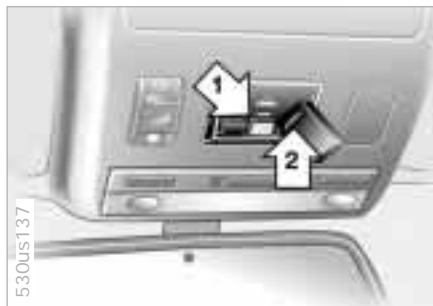

Programming

- 1 Channel keys
- 2 Indicator lamp
- 3 Receiver for programming

 Read and comply with the safety precautions on the previous page. ◀

- 1 Turn the ignition key to position 2.
- 2 For initial use: press and hold both outside keys 1 until the indicator lamp 2 flashes, and then release them. The three channel keys are cleared.

- 3 Hold the original hand-held transmitter toward the receiver 3 a maximum of 2 inches (5 cm) away.
- 4 Press the transmission key of the original hand-held transmitter (arrow 2) and the desired channel key of the Integrated Universal Remote Control (arrow 1) simultaneously. Release both keys as soon as the indicator lamp flashes rapidly.
- 5 To program other original hand-held transmitters, repeat steps 3 and 4.

The corresponding channel key is now programmed with the signal of the original hand-held transmitter.

Programming a hand-held transmitter with conversion code

 Read and comply with the safety precautions on previous page. ◀

When programming the BMW Universal Transmitter, consult the instructions for the specific device. For using the BMW Universal Transmitter with a conversion-code system, note the following supplemental programming instructions:

 A second person facilitates programming of the BMW Universal Transmitter. ◀

- 1 Program the BMW Universal Transmitter as described previously under "Programming."
- 2 Press and hold the programming key on the receiver of the device for approximately two seconds until the programming lamp on the device comes on.
- 3 Press the desired channel key of the BMW Universal Transmitter three times.

 If you have additional questions, please consult your BMW center. ◀

Clearing the channel keys



Read and comply with the safety precautions on page 98. ◀

The memory of individual channel keys cannot be deleted. However, the three channel keys can be cleared together as follows:

- ▷ Press and hold both outside keys of the BMW Universal Transmitter until the indicator lamp flashes, and then release them.

All of the channel keys are cleared.

User information

Do not use this BMW Universal Transmitter with any garage door opener that lacks safety "stop" and "reverse" features as required by federal safety standards (this includes any garage door opener model manufactured before April 1, 1982).

This device complies with Section 15 of the FCC Rules. Operation is subject to the following two conditions: as defined in the regulations, this device must not emit harmful interference, and must be shielded against interference from external sources to prevent unauthorized or inadvertent activation.

Glove compartment



To open

Pull the handle and the lamp comes on.

To close

Fold the cover up.

To lock

Use one of the master keys. A master key is also required for unlocking.

 If you turn over only your door and ignition key 3 for valet parking (refer to page 34), for example, access to the glove compartment is not possible. ◀

 To prevent injury in the event of a crash, close the glove compartment immediately after use. ◀

Rechargeable flashlight*

Located on the left-hand side of the glove compartment. Features integral overload-protection, so it can be left in its holder continuously.

 Be sure that the flashlight is switched off when it is inserted into its holder. Failure to comply with this precaution could lead to overcharging and damage. ◀

Storage compartments 101



You will find two storage compartments in the armrest between the front seats.

To open the top compartment:

Press the button (arrow 1).

You will find a cellular phone* in this compartment.

To move the armrest or open the lower compartment:

Pull the handle (arrow 2).

In this compartment, you will find a coin tray and a storage compartment* for cassettes or CDs.

You will find additional storage compartments in all of the doors as well as on the backrests of the front seats.

102 Cellular phone*

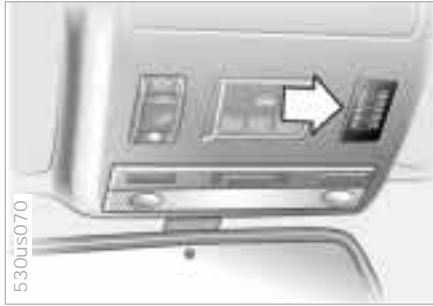

Handsfree system

On vehicles with a telephone hookup*, the handsfree speaker is positioned in the headliner.

For further information on the cellular phone, refer to the separate Owner's Manual.

Cup holders



Front

Below the sliding cover (illustration). Remove the insert which is a compartment for storing pens.

Rear

At the end of the center console under the lighter.

Press to open; push back inward to close.

Glasses compartment



Press the button to open; fold upward to close.

Ashtray, front



To open

Press briefly in the direction indicated by the arrow.

To extinguish a cigarette, tap off the ash and gently press the tip into the funnel.



To empty

Press the edge of the lid (arrow):
You can now pull the ashtray upwards for removal.

Cigarette lighter

103



Press the lighter in.

Remove the lighter as soon as it retracts.

 Hold or touch the hot cigarette lighter by the knob only. Holding or touching it in other areas could result in burns.

The cigarette lighter remains operational when the ignition key has been removed.
For this reason, do not leave unsupervised children in the vehicle. ◀

104 Cigarette lighter

Cigarette lighter socket

This socket is suitable for attaching power supplies for flashlights, car vacuum cleaners and other appliances up to a rating of approx. 200 watts at 12 volts. Avoid damage to the socket caused by inserting plugs of a different shape or size.

You will find additional power outlets in the cargo area. Refer to page [110](#).

Ashtray, rear



To open

Rotate the cover upward.

To empty

Remove the insert tray.

Lighter, rear



Press the lighter in.

Remove the lighter as soon as it retracts.

 Hold or touch the hot cigarette lighter by the knob only. Holding or touching it in other areas could result in burns.

The cigarette lighter remains operational when the ignition key has been removed.

For this reason, do not leave unsupervised children in the vehicle. ◀

Ski bag*

Designed for safe, convenient transport of 3 to 4 pairs of skis or two snowboards.

With the length of the ski bag and the additional space in the cargo area, you can store skis with a length of up to 6.8 feet (2.10 meters). Because of the tapered shape of the bag, the ski bag can only accommodate two pairs of skis with a length of 6.8 feet (2.10 meters).



Loading

- 1 Fold the center armrest outward. Loosen the trim from the upper Velcro® fastener and place it on the armrest.
- 2 Press button 1 downward and swing the cover forward.
- 3 Press the button: the cover in the cargo area is unlocked. Together with the pull-out cargo floor* (refer to page 110): pull the floor out, release the cover and slide the floor back in – the floor then conceals the cover.

106 Ski bag*

4 Extend the ski bag between the front seats. The zipper provides convenient access to the inside of the bag, and can also be left open to promote drying.

Please be sure that the skis are clean before loading them into the bag. Be careful to avoid damage from sharp edges.

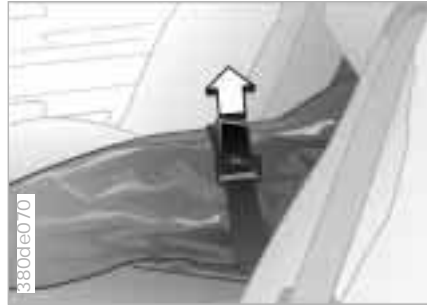

 Secure the bag's contents by tightening down the retaining strap at the buckle. ◀

To store the ski bag, perform the above steps in reverse sequence.

 If the cover is concealed in the cargo area by the pull-out cargo floor, do not fold the larger rear backrest down. If you do so, it will damage the cover. ◀



Fold the rear backrests down

Reach into the recess and pull forward (arrow).

The rear backrest is divided into two sections (one-third and two-thirds of the width of the seat). You can fold either section of the backrest down separately in order to increase the capacity of the cargo area.



When you close the backrest, be sure that the catch engages securely. The red warning indicator disappears in the recess when the retainer is locked.

The center safety belt can be retracted only when the larger backrest is engaged. ◀



Cargo area cover

Pull the cover out by the handle and hook it in the rear holders.

You can carry light objects such as articles of clothing on the cover.



Do not place heavy or hard objects on the cover. If you do so, they could pose a danger to vehicle occupants during a braking or evasive maneuver. ◀

Before you slide it back into position, place the grip in the rear fold of the cover.



When the cover is pulled out, it can be opened behind the rear-seat backrest to gain access to the cargo area from the rear seats during a trip, for example. For removing the cover: refer to the next page.



Removing the cover

- 1 Use both hands to press the cover together on both sides and slide it forward (arrow 1).
- 2 Lift the cover upward from the rear on both sides (arrow 2) and remove it.

Installation

Slide the cover into the retainers on both sides and then press it down at the rear until it engages.

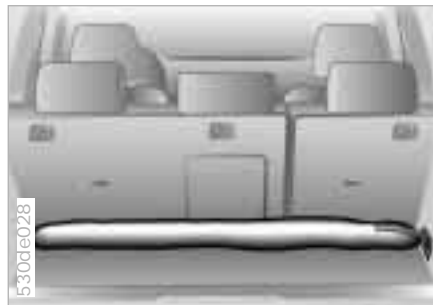

Partition net*

- 1 Remove the bag with the partition net from the vehicle by releasing the hooks from the lashing eyes on both sides.
- 2 Remove the partition net from the bag and unroll it half way.



Note how the bag with the partition net is secured in the vehicle and how the partition net is rolled up and stored in the bag so that you can return everything to its place after use. ◀

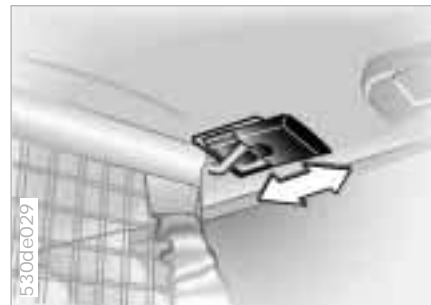

- 3 Slide back the covers on the brackets for the partition net on both sides of the roof (arrow).
- 4 Insert the curved ends of the partition net rod in the brackets on both sides.
- 5 Now you can slide the covers toward the front again (arrow).

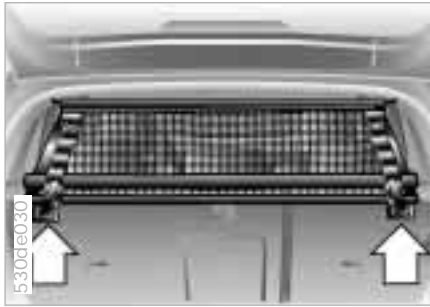

- 6 Attach the hooks on the bottom of the partition net into the eyes on both sides.

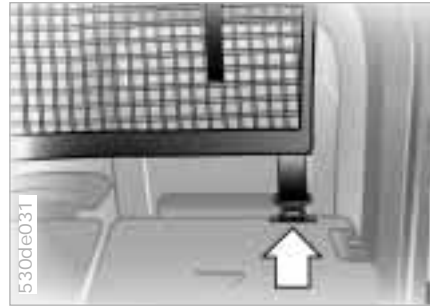

- 7 When the seatbacks are folded over, you can open the Velcro strips, completely unroll the partition net, insert it in the front brackets on the roof and attach the three hooks into the eyes. The illustration shows securing at the bottom right as an example.



Side covers

Pull the handle to open the side covers.

110 Cargo area

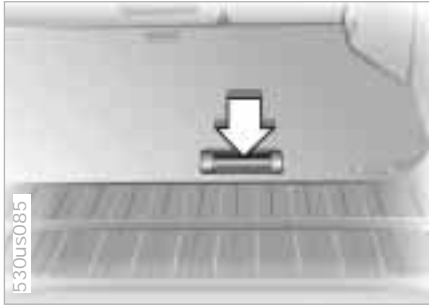

Floor cover

To release: press the recess in the handle (arrow) and raise the cover with the handle.



Fold the floor cover up

Lift up the black retainer on the lower side of the panel and hook it into the upper frame of the liftgate cutout.

Before you fold the floor cover down, return the retainer to its original position.



Power outlets

When you fold the cover cap up, you have access to additional power outlets.

You can use the power outlets for flashlights, car vacuum cleaners or other automotive appliances with up to approx. 200 watts at 12 volts. Avoid damage to the socket caused by inserting plugs of a different shape or size.

Refer also to page [104](#).

Cargo area

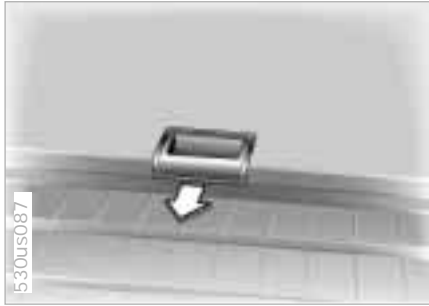

Pull-out cargo floor*

To release, pull the handle recess upward. Then pull the floor out.



Do not drive when the cargo floor is pulled out.

Do not release the cargo floor on steep grades. If you do, it could extend automatically and cause personal injuries. A load which is not properly secured could begin to slide if the floor extends automatically and then drop to the ground as a result of the rapid braking of the cargo floor at the limit stop. ◀

When it is extended, you can load the cargo floor:

- ▷ With up to 990 lbs (450 kg), distributed evenly across the entire surface.
- ▷ With up to 330 lbs (150 kg) on the rear edge.



Do not overload the cargo floor when it is extended. If you do so, it could cause damage. When you slide the cargo floor back in, do not grasp it on the bottom. If you do so, there is a risk of personal injury. ◀

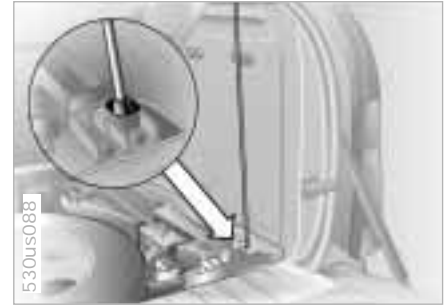

Raise the cargo floor

For access to the spare wheel or other stored items:

Swing the cargo floor up and secure it with the rod (see detail).



Stowing cargo

When transporting cargo in your BMW:

- ▷ Load heavy cargo as far forward as possible – directly behind the backrests – and as low as possible.
- ▷ Cover sharp edges and corners.
- ▷ Do not pile objects higher than the top edge of the backrest.
- ▷ Fasten the partition net* (refer to page 108) and ensure that carried items cannot pass through the partition net.
- ▷ If you are transporting very heavy loads when the rear seat is not occupied, secure the outer safety belts in the opposite buckles.

Securing the load

- ▷ Secure smaller, light pieces with the retaining straps or a luggage net*, or use elastic straps (refer to page 42).
- ▷ For large, heavy pieces, see your BMW center for load-securing devices*. The lashing eyes provided at the corners of the cargo area serve for mounting these load-securing devices.
- ▷ Read and comply with the information enclosed with the load-securing devices.



Always position and secure the load correctly. If you do not, it can endanger the passengers during braking or evasive maneuvers.

Do not exceed the permissible gross vehicle weight and the permissible axle loads (refer to page 186). If you do, the operating safety of the vehicle is no longer ensured and you are in violation of the law.

Do not carry hard or heavy objects unsecured in the passenger compartment. If you do so, they may be projected through the air during braking and evasive maneuvers, thus endangering vehicle occupants. ◀

Roof-mounted luggage rack*

Roof-mounted luggage racks raise the center of gravity of the vehicle when they are loaded. For this reason, they exercise a major effect on the vehicle's handling and steering response. You should therefore always remember not to exceed the approved roof weight, the approved gross vehicle weight or the axle weights when loading the rack. You will find the specifications under "Technical Data" on page [186](#).

Make sure that the load is not too heavy, and attempt to distribute it evenly. Always load the heaviest pieces first (on the bottom). Be sure that adequate clearance is maintained for raising the sliding/tilt sunroof, and that objects do not project into the opening path of the liftgate.

Secure the roof luggage correctly and securely to prevent it from shifting or being lost during driving (danger to following traffic).

Drive smoothly. Avoid sudden acceleration and braking maneuvers. Take corners gently.

The roof load increases the aerodynamic resistance. Increased fuel consumption is the immediate results.



Special operating instructions:

- Break-in procedures [116](#)
- Driving your BMW X5 [117](#)
- General driving notes [118](#)
- Catalytic converter [118](#)
- Antilock Brake System (ABS) [119](#)
- Disc brakes [122](#)
- Brake system [123](#)
- Winter operation [123](#)
- Power steering [125](#)
- Level control system [125](#)
- Cellular phone [126](#)
- Radio reception [126](#)

Wheels and tires:

- Tire inflation pressure [127](#)
- Tire condition [127](#)
- Tire replacement [128](#)
- Tire rotation [129](#)
- Wheel and tire combinations [130](#)
- Winter tires [131](#)
- Snow chains [131](#)
- Approved wheel and tire specifications [132](#)

Under the hood:

- Hood [133](#)
- Engine compartment [134](#)
- Washer fluid [136](#)
- Washer nozzles [136](#)
- Engine oil [137](#)
- Coolant [140](#)
- Brake fluid [141](#)
- Vehicle Identification No. [141](#)

Care and maintenance:

- The BMW Maintenance System [142](#)
- Caring for your vehicle [143](#)
- Airbags [148](#)
- Vehicle storage [148](#)

Laws and regulations:

- Technical modifications [149](#)
- OBD interface socket [150](#)

Overview**Controls and features****Operation, care and maintenance****Owner service procedures****Advanced technology****Technical data****Index**

To ensure that your vehicle provides maximum economy throughout a long service life, we request that you observe the following suggestions:

Engine and axle drive

Up to 1,200 miles (2,000 km):

Drive at varying engine speeds and road speeds, but do not exceed 4,500 rpm and a road speed of 106 mph (170 km/h) during this initial period:

Obey your local and state maximum speed limits.

Refrain from using full throttle and avoid pressing the accelerator beyond the kickdown point.

Once you have driven 1,200 miles (2,000 km), engine and vehicle speeds can gradually be increased.

You should also comply with these break-in procedures if the engine or one of the axle drives is replaced later in the course of the vehicle service life.

Tires

Due to technical factors associated with their manufacture, tires do not achieve their full traction potential until an initial break-in period has elapsed. For this reason, drive with extra care during the initial 200 miles (300 km).

Obey your local and state maximum speed limits.



When the vehicle is operated on wet or slushy roads, a wedge of water may form between the tire and the road surface. This phenomenon is referred to as aquaplaning, or hydroplaning, and can lead to partial or complete loss of traction, vehicle control and braking effectiveness. Reduce your speed on wet roads. ◀

Brake system

Approximately 300 miles (500 km) must elapse before the brake pads and rotors achieve the optimal pad-surface and wear patterns required for trouble-free operation and long service life later on.

To break in the separate parking brake drums, apply the parking brake lightly when coasting to a standstill (at a traffic signal, for instance), provided that traffic conditions allow you to do so. To avoid corrosion, repeat this procedure from time to time.



The brake lamps do not light up when the parking brake is applied. Vacuum for the brake system servo unit on your BMW is available only when the engine is running. When you move the vehicle with the engine shut off – when towing, for instance – substantially higher levels of pedal force will be required to brake the vehicle. ◀

Driving your BMW X5

Your BMW is right at home on all roads and byways – even where the pavement ends. It combines permanent four-wheel drive with the agility of a typical passenger car.

On bad roads

When you are driving on bad roads, there are a few points which you should strictly heed – for your own safety, for that of your passengers, and for the safekeeping of the vehicle:

- ▷ Familiarize yourself with the vehicle before you begin driving. Do not take risks with the vehicle under any circumstances.
- ▷ Always adapt vehicle speed to road conditions – the steeper and more uneven the road surface is, the slower the vehicle's speed should be.
- ▷ You can operate your vehicle on uphill and downhill gradients with a maximum slope of 50 %. If you intend to drive on either an uphill or downhill gradient of this steepness, check to be sure in advance that the engine oil and coolant levels are both near the "max" mark. Refer to page [137](#) and [140](#).

When driving down steep slopes, use the Hill Descent Control (HDC). Refer to page [84](#).

Starting from a full stop is possible on uphill gradients of up to 32 %.

The permitted side tilt is also 50 %.

- ▷ While driving, watch carefully for obstacles such as rocks or holes. Try to avoid these obstacles whenever possible.
- ▷ On hill crests and bumpy roads, for example, be careful to prevent the body from "bottoming" (contact between the body and the ground). The ground clearance of the vehicle is:
 - 8 inches (200 mm) with up to four passengers
 - 7 inches (180 mm) fully loaded.
- ▷ Do not drive in water that is deeper than 20 inches (50 cm). If you must drive through water up to that depth, drive at a walking speed and do not stop.

After leaving the water, press on the footbrake gently several times while driving at a low speed. The brake applications will help to dry the brakes, thus preventing a reduction in braking performance caused by the moisture.

Back onto the paved road

In recommending that you observe the following points after driving on adverse road surfaces, it is not as a "beauty treatment" for your BMW. Instead, it is intended for the maintenance of driving safety:

- ▷ Clean accumulations of dirt from the body and check the undercarriage for damage.
- ▷ Clean mud, snow, ice and other materials from the wheels and tires. Check the tires for damage.
- ▷ Check to determine whether rocks, gravel or accumulations of dirt on the brake rotors and calipers could influence braking performance. Remove all such foreign objects.
- ▷ In order to clean the brake rotors, apply the footbrake gently several times while driving at a low speed. Be sure that following traffic is not endangered by this.
- ▷ For cleaning the parking brake, apply the lever slightly at approx. 25 mph (40 km/h) and continue to drive for approx. 200 yards (200 meters), provided that traffic conditions allow you to do so.

**Brakes:**

Do not drive with your foot resting on the brake pedal. Even light but consistent pedal pressure can lead to high temperatures, brake wear and possibly even brake failure.

Aquaplaning:

When driving on wet or slushy roads, reduce vehicle speed. If you do not, a wedge of water may form between the tires and the road surface. This phenomenon is referred to as aquaplaning or hydroplaning. It is characterized by a partial or complete loss of contact between the tires and the road surface.

The ultimate results are loss of steering and braking control.

Cargo area cover:

Do not place heavy or hard objects on the cargo area cover. These objects could endanger vehicle occupants during heavy brake applications or evasive maneuvers.

Clothes hooks:

When suspending articles of clothing from the hooks, be sure that they will not obstruct the driver's vision. Do not hang heavy objects on the hooks. If you do so, they could cause personal injury during braking or evasive maneuvers. ◀

Catalytic converter

The catalytic converter reduces harmful exhaust emissions.

It is designed for use with unleaded fuel only. Even minute quantities of lead would be enough to permanently damage both the catalytic converter and the system oxygen sensor.

To ensure efficient, trouble-free engine operation and avoid potential damage:

- ▷ Be sure to comply with the scheduled maintenance requirements.
- ▷ Fill the fuel tank well before it is empty.
- ▷ When the battery is discharged, start the engine with an outside starting aid.
- ▷ Avoid other situations in which the fuel is not burned, or burns incompletely, such as engaging the starter frequently or for extended periods, or repeated start attempts in which the engine does not start (stopping and restarting an engine which is running properly does not present a problem). Never allow the engine to run with any of the spark plug cables disconnected.

 Be sure to comply with the instructions above to prevent unburned fuel from reaching the catalytic converter. Otherwise, the catalytic converter could respond by overheating, leading to serious damage. Extreme temperatures occur at the catalytic converter on this and every catalyst-equipped vehicle. Heat shields are installed adjacent to some sections of the exhaust system. Never remove these shields; do not apply undercoating to their surfaces. When driving, standing at idle, and parking the vehicle, take care to avoid contact between the exhaust system and flammable materials (grass, hay, leaves, etc.). Such contact could lead to a fire, resulting in serious personal injury and property damage. ◀

The concept

ABS enhances active safety by helping to prevent the wheels from locking under braking. This is because: locked wheels are dangerous. When the front wheels slide, the driver loses steering control over the vehicle. Traction loss at the rear wheels can cause the rear end to break into an uncontrolled skid.

With ABS, you will achieve the shortest possible braking distances under all given conditions (braking while driving straight ahead or in curves, different road surfaces).

ABS is designed to meet two essential requirements during every brake application:

- ▷ To help provide vehicle stability.
- ▷ To help retain steering and maneuvering capability on all types of road surfaces (asphalt, cement, dirt, wet surfaces, snow and ice).

Braking with ABS

The system becomes operative once the vehicle exceeds a speed of approx. 6 mph (10 km/h). The ABS is deactivated whenever the vehicle's speed drops back below approx. 4 mph (6 km/h).

To shorten the braking distance – especially on steep, poor road surfaces when driving slowly straight ahead – the system allows one or both front wheels to lock for a short time. Nevertheless, the vehicle still retains steering response since this "poor road logic" is deactivated again automatically as you steer.

If you are in a situation that requires full braking, you will exploit the full benefits of the ABS system if you apply maximum brake pressure ("panic stop"). Since the vehicle maintains steering responsiveness, you can avoid possible obstacles with a minimum of steering effort, despite the full brake application.

The ABS system's closed-loop control circuit cycles in fractions of a second. A pulsation at the brake pedal, together with the sounds associated with the hydraulic controls, tells you that the brake system is within its maximum limit range and reminds you that you

should adapt road speed to the road conditions.

On road surfaces that have a loose surface layer on a firm base with good traction (on gravel, deep sand or snow, for example), braking distances may be longer than with locked wheels. This is also true if snow chains are mounted. However, ABS continues to provide enhanced vehicle stability and steering response under these conditions.

Information for your safety

Not even ABS can suspend the laws of physics. ABS alone cannot prevent accidents when the brakes are applied without an adequate safety distance between vehicles, if the vehicle is driven with excessive speed, or if aquaplaning occurs. Responsibility for these types of situations remains in the hands (and at the feet) of the driver. You should never allow the added safety of ABS to lull you into a false sense of security, or mislead you into taking increased risks that could affect your own safety and that of others.

 Do not make any modifications to the ABS system.

Service procedures on ABS are to be performed by authorized technicians only. ◀

Cornering Brake Control (CBC)

CBC is an advanced engineering design of the ABS. When braking during cornering with high lateral acceleration, or when braking during a lane change, vehicle stability is further improved and the steering response is enhanced.

Electronic Brake Force Distribution (EBV)

EBV governs brake application pressure at the rear wheels to achieve stable brake response.

 If the EBV fails (refer to the next page), avoid full or "panic" brake applications. Full or panic brake applications can result in overbraking at the rear axle, and braking stability is no longer ensured. ◀

Dynamic Brake Control (DBC)

If you apply the brakes rapidly, this system automatically produces the maximum braking force boost and thus helps to achieve the shortest possible braking distance during "panic stops." All of the benefits of the ABS system are exploited under these circumstances.

Do not reduce the pressure on the brake pedal for the duration of the brake application. When the brake pedal is released, the DBC is deactivated.



In the event of a malfunction, the yellow warning lamp comes on. Have the system checked and repaired at your BMW center as soon as possible.



Refer to the "Information for your safety" covering the ABS system. This information also applies in general for DBC. ◀

Antilock Brake System (ABS)

In the event of a fault



If the brake warning lamp comes on red together with the yellow indicator lamps for ABS and DSC (refer to pages 22 and 24), ABS, CBC, DSC, DBC, EBV and HDC have failed. You may continue driving, but drive defensively and with extra caution. Avoid full brake applications because the vehicle could become unstable and go out of control.

Have the system checked by the nearest BMW center.

If all all three warning lamps come on yellow:

ABS, CBC, DSC, DBC and HDC have failed. The effect of the EBV Brake Force Distribution at the rear wheels, which achieves stable brake response, is largely preserved. Optimum brake force and braking stability are no longer assured. Continue to drive; drive cautiously and defensively and avoid full brake applications.

Have the system checked by your authorized BMW center as soon as possible.



Following an interruption in battery power, the ABS, CBC, DSC, DBC and HDC systems are no longer available. After you drive for only a few yards or meters or if you turn the steering wheel from stop to stop while the vehicle is stationary and the engine is running, the functions are activated again and the three warning lamps will go out. ◀



Warning lamps for Canadian models.



Disc brakes furnish optimum deceleration and braking control and greater fade resistance under heavy use.

When the vehicle is driven only occasionally, during extended periods when the vehicle is not used at all, and in operating conditions where brake applications are less frequent, there is an increased tendency for corrosion of the rotors and accumulation of contamination on the brake pads. This occurs because the minimal pressure which must be exerted by the pads to clean the rotors by brake applications is not reached.

If the brake rotors are corroded, they will tend to respond to braking with a pulsating effect which even extended application will fail to cure.

 For your own safety: use only brake pads that BMW has released for your particular vehicle model. BMW cannot evaluate non-approved brake pads to determine if they are suited for use, and therefore cannot ensure the operating safety of the vehicle if they are installed. ◀

Driving notes

When driving in wet conditions and in heavy rain, it is advisable to apply light pressure to the brake pedal every few miles (kilometers). Watch traffic conditions to ensure that this maneuver does not endanger other road users. The heat which is generated by the brake applications helps to dry the brake pads and rotors.

Maximum braking force is obtained while the wheels continue to rotate, peaking when the wheels remain on the verge of locking without actually doing so. ABS maintains this state automatically. If the ABS fails, you should revert to the staggered braking technique (refer to page 124).

Extended or steep mountain descents do not necessarily have to lead to reduced braking efficiency. Move the selector lever to the appropriate lower range in which only minimal periodic brake applications are required.

You can increase the engine's braking effect by selecting progressively lower gears, downshifting as far as 1st gear, on steep descents.

If engine braking should prove to be inadequate, you should still avoid extended, continuous braking. Instead of maintaining low to moderate pressure over an extended period of time, you should decelerate by applying more substantial pressure to the brake pedal (watch for following traffic), then releasing the pedal, then repeating the application. This staggered braking technique allows the brakes to cool in the intervals between active braking phases, preventing overheating and ensuring that full braking capacity remains available at all times.



Do not coast with the selector lever in "Neutral". Do not drive with the engine shut off. The engine provides no braking effect when the transmission is in "Neutral", and there is no power-assist for braking or steering when the engine is not running. Have brake inspections performed at an authorized BMW center only. If you do not, parts of the four-wheel drive system could be damaged. Never allow floor mats, carpets or any other objects to protrude into the area around the accelerator and brake pedals and obstruct their movement. ◀

Brake fluid level



The warning lamp for the brake hydraulic system comes on, or the CHECK BRAKE FLUID message appears in the Check Control*.

The brake fluid level is too low in the reservoir (refer to page 141).

If the brake fluid level is too low and brake pedal travel has become noticeably longer, there may be a defect in one of the brake system's hydraulic circuits.



Proceed to the nearest authorized BMW center. Higher brake application pressure may be necessary under these conditions, and brake pedal travel may be significantly longer. Please remember to adapt your driving style accordingly. ◀

The warning lamp also comes on when the CHECK BRAKE LININGS message appears in the Check Control.

Brake pads



The warning lamp for the brake pads comes on, or the CHECK BRAKE LININGS message appears in the Check Control*:

The brake pads have reached their minimum pad thickness. Proceed to the nearest authorized BMW center as soon as possible to have the pads replaced.



For your own safety: use only brake pads that BMW has released for your particular vehicle model. BMW cannot evaluate non-approved brake pads to determine if they are suited for use, and therefore cannot ensure the operating safety of the vehicle if they are installed. ◀

The onset of winter is often accompanied by rapid changes in weather. Adaptations in driving style should be accompanied by preparations on the vehicle itself to ensure that your progress through the winter remains safe and trouble-free.

Coolant

Be sure that the coolant mixture contains the year-round ratio of 50:50 water and antifreeze/corrosion protection. This mixture provides protection against freezing down to approx. -34 °F (-37 °C). Replace the coolant every four years.

Locks

BMW door lock deicer can be used to free locks if they are frozen. This deicer also contains lubricant.

After using the deicer, treatment with BMW lock barrel grease is recommended.

Rubber seals and components

In order to prevent the weather-stripping from freezing, apply BMW rubber treatment or silicone spray to the seals on the doors, hood and tailgate.



A full range of car care products is available from your BMW center. ◀

Snow chains

Mount BMW snow chains* only on tire size 235/65 R 17. Always mount chains in pairs and on the rear wheels only. Read and comply with the chain manufacturer's safety precautions. Do not exceed a maximum speed of 30 mph (50 km/h).

Starting off

When starting in deep snow or "rocking" the vehicle free, it may be advisable to deactivate the DSC system briefly. Refer to page [83](#).

Driving on low-traction road surfaces

Use smooth, gentle pressure to control the accelerator pedal and avoid excessive engine speeds. Maintain an adequate distance between yourself and the car ahead.

Braking

Winter road conditions substantially reduce the amount of traction available between the tires and the road surface. The resulting increases in braking distance are considerable and should be kept in mind at all times.

ABS is intended to prevent the wheels from locking during brake applications, thus helping to maintain vehicle stability and steering response.

If the ABS does not respond in a critical braking situation and the wheels lock: Reduce the pressure on the brake pedal until the wheels just start to roll again while still maintaining enough force to continue braking. Following that, increase pedal pressure again. Reduce the pressure as the wheels lock, then reapply pressure. Repeat this braking sequence.

This type of staggered braking will reduce the braking distance, and the vehicle still remains responsive to steering.

You can then attempt to steer around hazards after you have reduced pressure on the brake pedal.



Do not shift down on slick road surfaces if you want to decelerate. Doing so could cause the wheels to lose traction and skid, thus resulting in the loss of vehicle control. ◀

Winter operation

Skid control

Release the accelerator pedal. Countersteer carefully and attempt to regain control of the vehicle.

Parking

Place the selector lever in "Park." and apply the parking brake when parking on inclined surfaces. In order to prevent the parking brake linings from locking due to frost or corrosion, dry them by gently applying the parking brake as the vehicle is coming to a stop. Make sure that following traffic is not endangered.



The brake lamps do not light up when the parking brake is applied. ◀

Power steering

If there is a change in steering response (difficult steering, for example) or, especially on vehicles with Servotronic*, if the steering "drifts" or "floats" at increasing speeds:

Have your authorized BMW center inspect this system as soon as possible.



If the power steering fails, increased effort will be required to steer the vehicle. ◀

Level control system

125



The warning lamp for the level control system comes on, or the message LEVEL CONTROL INACTIVE appears in the Check Control*: There is a malfunction in the level control system.

Stop and inspect the vehicle. If it is riding significantly lower in the rear than in the front, or if it is sitting at an incline (left rear compared to right rear), consult the nearest authorized BMW center. Drive with appropriate caution in the meantime, especially if you are driving under poor road-surface conditions. The vehicle has reduced ground clearance or driving comfort is noticeably reduced.

Even if the attitude of the vehicle is normal, you should consult the nearest authorized BMW center if the warning lamp indicates a system fault.

Mobile communications systems (cellular phone, radio, etc.) are only allowed a power output of up to 10 Watts. Mobile communications devices not specifically designed for use in your vehicle may trigger malfunctions during vehicle operation. BMW can neither test nor assume responsibility for every individual product being offered on the market. We recommend that you consult your BMW center before purchasing any device of this kind.

To ensure that your BMW continues to provide reliable and trouble-free operation, do not use a cellular phone or other radio device with an antenna located inside the passenger compartment. The antenna should always be mounted on the outside of the vehicle.

Radio reception

The reception and sound quality obtained from mobile radios vary according to a variety of factors, including the broadcast range of the transmitter and the directional orientation of the antenna. Interference factors such as high-tension power lines, buildings and natural obstructions can all lead to unavoidable reception interference, regardless of how well the vehicle sound system is operating. Climatic factors such as intense solar radiation, fog, rain and snow can also interfere with reception.

Cellular phones without formal BMW approval can also generate interference. This phenomenon assumes the form of a low-pitched hum emanating from the speaker system.

Please refer to the Owner's Manual provided with your sound system for detailed information on its use.

Tire inflation pressure

Information for your safety

The factory-approved radial tires are matched to the vehicle and have been selected to provide optimum safety and driving comfort on your vehicle.

It is not merely the tire's service life, but also driving comfort and – above all else – driving safety which depend on the condition of the tires and the maintenance of the specified tire pressure.

Incorrect inflation pressure is a frequent cause of tire damage. It also significantly influences the roadholding ability of your BMW.

 Check tire inflation pressures – including the spare wheel – regularly, at least every two weeks and before beginning a longer trip. If this is not done, incorrect tire pressures can cause driving instability and tire damage, ultimately resulting in an accident. ◀

Tire condition



Tire tread – Tire damage

Inspect your tires frequently for tread wear, signs of damage and for foreign objects lodged in the tread. Check the tread depth.

Tread depth should not be allowed to go below 0.12 in (3 mm), even though the legally specified minimum tread depth is only 0.063 in (1.6 mm). At a tread depth of 0.063 in (1.6 mm), tread depth indicators (arrow) in the tread-groove base indicate that the legally-permissible wear limit has been reached. Below 0.12 in (3 mm) tread depth, there is an increased risk of aquaplaning, even at relatively moderate speeds and with only small amounts of water on the road.



Do not drive on a deflated (flat) tire. A flat tire greatly impairs steering and braking response, and can lead to complete loss of control over the vehicle.

Avoid overloading the vehicle so that the permitted load on the tires is not exceeded. Overloading can lead to overheating and increases the rate at which damage develops inside the tires. The ultimate result can assume the form of a sudden air loss.

Unusual vibrations encountered during normal vehicle operation can indicate tire failure or some other vehicle defect, as can variations in normal vehicle response, such as a pronounced tendency to pull to the left or right. Should this occur, respond by immediately reducing your speed and carefully proceeding to the nearest BMW center or professional tire center, or having the vehicle towed in to have it and its tires inspected.

Tire damage (up to and including blow-outs) can endanger the lives of both the vehicle occupants and other road users. ◀

Tire replacement

To maintain good handling and vehicle response, use only tires of a single tread configuration from a single manufacturer. BMW tests and approves wheel/tire combinations. Refer to page 130.

DOT Quality Grades

Treadwear

Traction AA A B C

Temperature A B C



All passenger car tires must conform to Federal Safety Requirements in addition to these grades. ◀

Treadwear

The treadwear grade is a comparative rating based on the wear rate of the tire when tested under controlled conditions on a specified government test course.

For example, a tire graded 150 would wear one and one-half (1 1/2) times as well on the government course as a tire graded 100. The relative performance of tires depends upon the actual conditions of their use, however, and may depart significantly from the norm due to variations in driving habits, service practices and differences in road characteristics and climate.

Traction

The traction grades, from highest to lowest, are AA, A, B, and C.

Those grades represent the tire's ability to stop on wet pavement as measured under controlled conditions on specified government test surfaces of asphalt and concrete. A tire marked C may have poor traction performance.



The traction grade assigned to this tire is based on straight-ahead braking traction tests, and does not include acceleration, cornering, hydroplaning, or peak traction characteristics. ◀

Temperature

The temperature grades are A (the highest), B, and C, representing the tire's resistance to the generation of heat and its ability to dissipate heat when tested under controlled conditions on a specified indoor laboratory test wheel.

Sustained high temperature can cause the material of the tire to degenerate and reduce tire life, and excessive temperature can lead to sudden tire failure. The grade C corresponds to a level of performance which all passenger car tires must meet under the Federal Mo-

tor Vehicle Safety Standard No. 109. Grades B and A represent higher levels of performance on the laboratory test wheel than the minimum required by law.



The temperature grade for this tire is established for a tire that is properly inflated and not overloaded. Excessive speed, underinflation, or excessive loading, either separately or in combination, can cause heat buildup and possible tire failure. ◀

Uniform Tire Quality Grading

Quality grades can be found where applicable on the tire sidewall between tread shoulder and maximum section width. For example:

Treadwear 200 Traction AA
Temperature A



Do not use retreaded tires, since driving safety may be impaired by their use. This is due to the possible variations in casing structures and, in some cases, to their extreme age, which can lead to a decrease in their durability. ◀

Tire replacement

Tire age

The date on which the tire was manufactured is indicated by the code on the sidewall:

DOT ... 419 indicates that the tire was manufactured in Week 41 of 1999.

BMW recommends the replacement of all tires when the tires are no more than 6 years old, even if a tire life of 10 years is possible.

Spare tires over 6 years old should be used only in case of emergency. Such a tire should be replaced by a new tire immediately, and should not be mounted together with new tires.

Tire rotation

Between the axles

The tread wear patterns at the front end differ from those at the rear – the actual patterns will vary according to individual driving conditions. In the interests of safety and maintaining optimal handling characteristics, tire rotation is not recommended.

When considering the potential economic benefits of interaxle tire rotation, you must decide whether the expense of having the tires rotated is likely to be amortized during the anticipated extension in tire life. In principle, interaxle tire rotation should be performed at short intervals, with a maximum of 3,000 miles (5,000 km). Consult your authorized BMW center for more information.

Should you decide to rotate the tires, it is essential that you comply with the following:

Rotate tires on the same side only, since braking characteristics and road grip could otherwise be adversely affected.

Following tire rotation, correct the tire inflation pressure.



If different tire sizes are mounted on the front and rear axles (refer to page 132), the wheels may not be rotated from one axle to the other. ◀

The right choice

Use only tires approved by BMW. Refer to page 132.

Due to the high speeds this vehicle can reach, the use of specific brands, specifications and sizes is mandatory. Consult any BMW center for details. Comply with all local/national regulations.



The correct wheel-tire combination affects different systems such as ABS, ATC and DSC. The function of these systems is impaired if improper wheel-tire combinations are used. For this reason, use only tires of the same brand and tread pattern. If you have mounted winter tires and must use the spare wheel following a flat tire, for example, remount the approved wheel-tire combination as soon as possible. ◀

Codes on the tires and wheels

The tire codes will aid you in selecting the correct tire.

Codes on radial tires:

Example: **235/65 R 17 104 H**

Nominal width in mm _____

Aspect ratio in % _____

Belt rating code for radial tires _____

Rim diameter in inches _____

Load rating _____

Speed rating _____

The speed rating indicates the approved maximum speed for the tire.

Summer tires:

S = up to 112 mph (180 km/h)
 T = up to 118 mph (190 km/h)
 H = up to 130 mph (210 km/h)
 V = up to 150 mph (240 km/h)
 W = up to 167 mph (270 km/h)
 Y = up to 186 mph (300 km/h)
 ZR= over 150 mph (240 km/h)

All-Season, All-Terrain and Winter tires:

Q M+S = up to 100 mph (160 km/h)
 T M+S = up to 118 mph (190 km/h)
 H M+S = up to 130 mph (210 km/h)

Codes stamped on light-alloy wheels:

7.5 J x 17 SEH2

Rim width in inches _____

Code letter for flange type _____

Symbol for full-drop center rim _____

Rim diameter in inches _____

Special Extended Hump on the 2 rim shoulders _____

Protect valve stems from dirt by using screw-on valve stem caps. Dirt in the valves frequently leads to slow leaks.

Choosing the right tire

BMW recommends special winter tires (M+S radial tires) for driving in adverse winter road conditions. While the All-Season tires with M+S designation that are mounted as standard equipment provide better winter traction than summer tires, they generally do not achieve the performance of winter tires.

For safe tracking and steering response, install winter tires made by the same manufacturer having the same tread configuration on all four wheels.

Mount only winter tires approved by BMW. Any BMW center will be glad to provide you with information for selecting the best winter tires for your particular driving conditions.

Do not exceed specified maximum speeds



Never exceed the maximum speed for which winter tires are rated.

Unprofessional attempts by laymen to service tires can lead to damage and accidents.

Have this work performed by skilled professionals only. Any BMW center has the required technical knowledge and the proper equipment and will be happy to assist you. ◀

Tire condition, tire pressure

Once winter tires wear to a tread depth below 0.16 in (4 mm), their performance under winter driving conditions deteriorates noticeably. Worn tires should therefore be replaced for safety considerations.

Comply with the specified tire inflation pressures – and be sure to have the wheel and tire assemblies balanced every time you change the tires.

Storage

Store tires in a cool, dry place, away from light whenever possible. Protect the tires against contact with oil, grease and fuel.

The use of narrow-link BMW snow chains is approved only in pairs on the rear wheels and only with tire size 235/65 R 17. Comply with all manufacturer's safety precautions when mounting the chains.

132 Approved wheel and tire specifications

Tire specifications	Light-alloy wheels
BMW X5 4.4i	
All-Season/All-Terrain	
235/65 R 17 104 H M+S	7.5J x 17 SEH2
255/55 R 18 105 H M+S	8.5J x 18 EH2
Summer	
255/55 R 18 105 V	8.5J x 18 EH2
Front: 255/50 R 19 103 V	9J x 19 EH2
Rear: 285/45 R 19 107 V	10J x 19 EH2
Winter	
235/65 R 17 104 Q/T/H M+S	7.5J x 17 SEH2

Observe the specifications for tires and wheels in the vehicle's manuals. If sizes not approved by the manufacturer are mounted, an entry in the vehicle's documents may be necessary.

Snow chains*

It is only possible to mount snow chains on the rear wheels with tire size 235/65 R 17.



The use of rims and lug bolts that do not meet the specifications of the original factory-installed equipment will affect the safe operation of your vehicle and may cause an accident and personal injury. Never mix tires of different design, such as steel-belted radials with radial bias belted or bias-ply tires, etc. Mixing tire types will adversely affect roadholding and can lead to loss of vehicle control. ◀



To unlock

Pull the lever located under the left-hand side of the instrument panel.

 Do not work on your vehicle without appropriate skills. Switch off the engine and allow it to cool down before working in the engine compartment. Always disconnect the battery before working on any electrical systems or equipment, especially when these are located within the engine compartment. Comply with all applicable instructions and warnings. Failure to work in an informed, professional manner when servicing components and materials constitutes a safety hazard for vehicle occupants and other road users. If you are not familiar with the guidelines, please have the operations performed by your authorized BMW center. ◀



To open

Pull the release handle and open the hood.

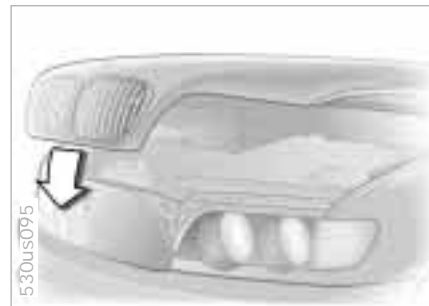

To close

Allow the hood to fall from a height of about 12 in (30 cm) so that it audibly engages.

 To avoid injuries, be sure that the travel path of the hood is clear when it is closed, as with all closing procedures. If it is determined that the hood is not completely closed while driving, stop immediately and close it securely. ◀

134 Engine compartment – BMW X5 4.4i

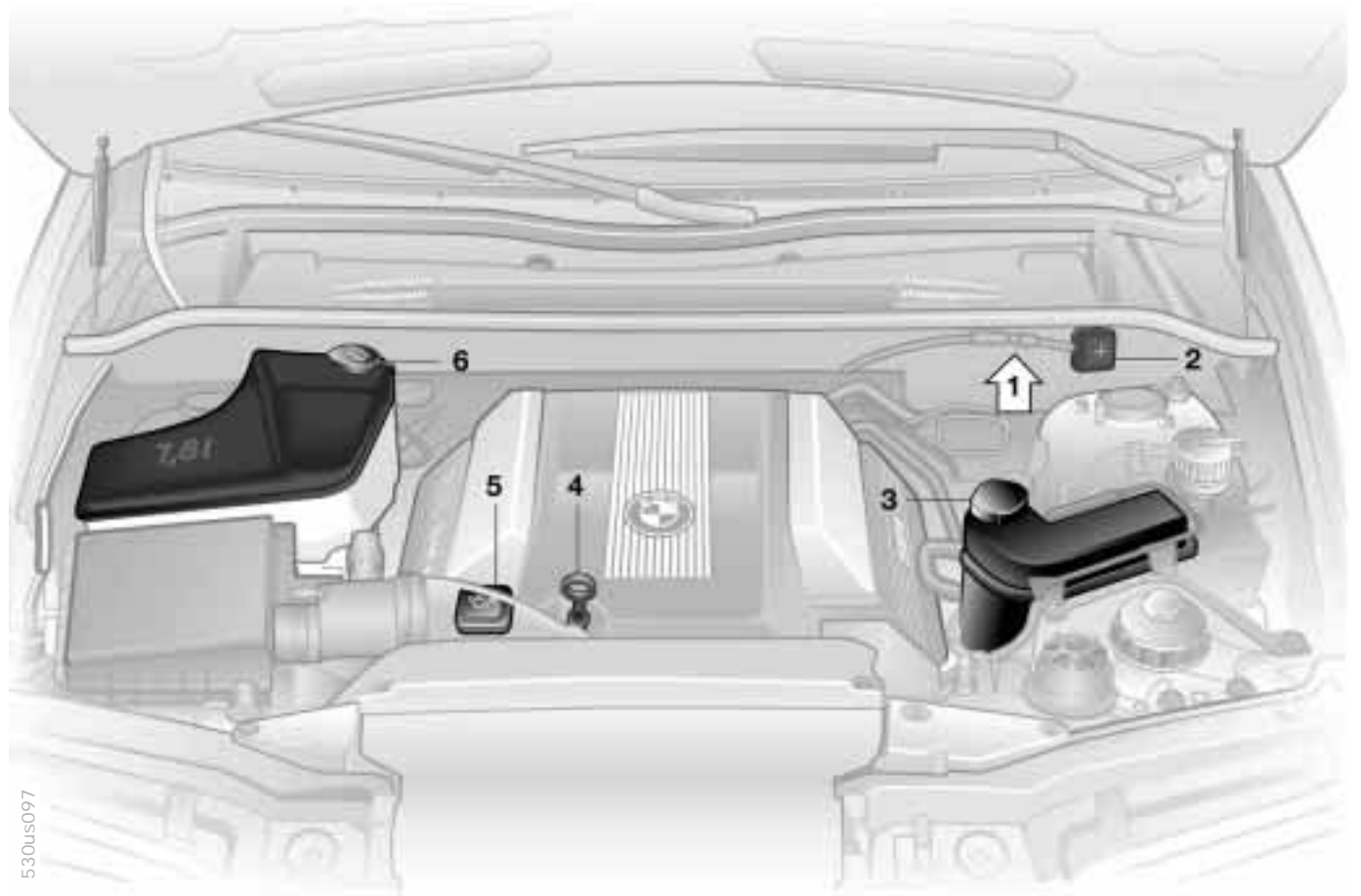

530us097

- 1 Reservoir for brake fluid
(under the microfilter
trim panel) [141](#)
- 2 Auxiliary terminal for jump
starting [170](#)
- 3 Coolant expansion tank [140](#)
- 4 Engine oil dipstick [137](#)
- 5 Engine oil filler neck [137](#)
- 6 Reservoir for windshield and
headlamp washer system* [136](#)



Headlamp* and windshield washer system

Capacity in US quarts (liters).

Approx. 8.2 (7.8)

Fill with water and – if required – with a washer antifreeze (according to manufacturer's recommendations).



It is more convenient to mix the washer fluid before adding it to the reservoir. ◀

Washer nozzles

Windshield washer

Windshield:

The nozzles are directed so as to ensure effective cleaning, even at high speeds.

Rear window:

Have this system adjusted by your BMW center as required.

Headlamp washer*

Have the nozzles adjusted by your BMW center as required.

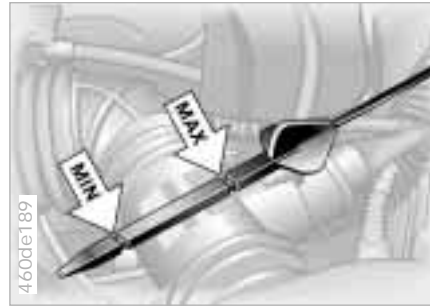

Checking oil level

- 1 Park the vehicle on a level surface.
- 2 Shut the engine off after it has reached normal operating temperature.
- 3 After approx. 5 minutes, pull the dipstick out and wipe it off with a clean lint-free cloth, paper towel, or similar material.
- 4 Push the dipstick carefully all the way into the guide tube and pull it out again.
- 5 The oil level should be in between the two graduations on the dipstick.

As with fuel economy, oil consumption is directly influenced by your driving style and vehicle operating conditions.

The oil volume between the two marks on the dipstick corresponds to approx. 1.1 US quarts (1 liter). Do not fill beyond the upper mark on the dipstick. Excess oil will damage the engine.

Adding engine oil

Wait until the level has dropped to just above the lower mark before adding oil. However, do not wait until the oil level drops below the lower mark.

 BMW engines are designed to operate without oil additives; the use of additives could lead to damage in some cases. This is also true for the automatic transmission, the transfer box, the differential, and the power steering system. ◀

Specified engine oils

The quality of the engine oil selected has critical significance for the operation and service life of an engine. Based on extensive testing, BMW recommends only certain types of engine oil. Use only approved "BMW High Performance Synthetic Oil."

If you are unable to obtain "BMW High Performance Synthetic Oil," you can add small amounts of synthetic oil in between oil changes. Use only oils with the API SH specification or higher.

 Ask your authorized BMW center for details concerning the specific "BMW High Performance Synthetic Oil" or "synthetic oils" which have been approved. ◀

You can also call BMW of North America at 1-800-831-1117 or visit this website: www.bmwusa.com to obtain this information.

Viscosity ratings

Viscosity is the oil flow rating as established in SAE classes.

The selection of the correct SAE class depends on the climatic conditions in the area where you typically drive your BMW.

 Approved oils are in SAE classes 5W-40 and 5W-30. ◀

These oils may be used for driving in all ambient temperatures.

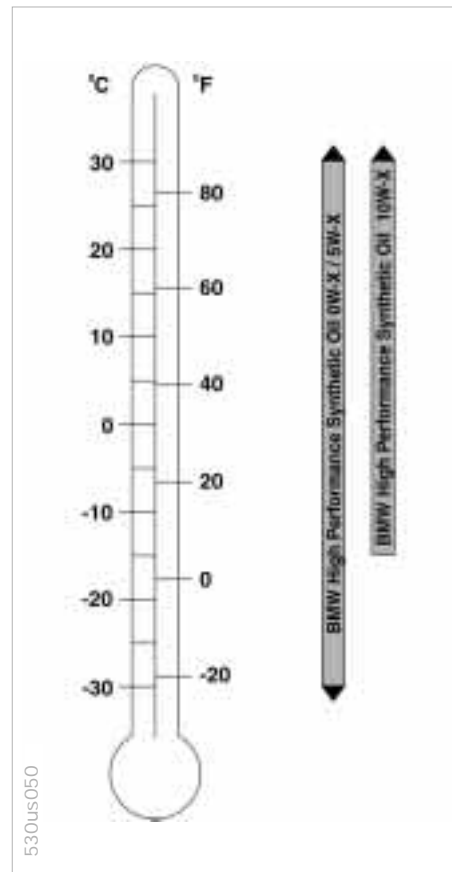

Engine oil



Comply with the applicable environmental laws regulating the disposal of used oil. ◀

Recommendation: have the oil changed by your BMW center.



Continuous exposure to used oil has caused cancer in laboratory testing. For this reason, any skin areas that come into contact with oil should be thoroughly washed with soap and water.

Always store oils, grease and similar materials so that they are inaccessible to children. Comply with warning labels and information on containers. ◀

 Do not add coolant to the cooling system when the engine is hot. If you attempt to do so, escaping coolant can cause burns.

To avoid the possibility of damage later on, never use anything other than factory-approved, nitrite and amino-free extended-duty antifreeze with corrosion inhibitor. Your authorized BMW center is familiar with the factory specifications.

Antifreeze and anticorrosion agents are hazardous to health. You should always store them in their original container and in a location which is inaccessible to children.

Extended-duty antifreeze with corrosion inhibitor contains the flammable substance ethylene-glycol. For this reason, do not spill antifreeze with corrosion inhibitor on hot engine parts. It could ignite and cause serious burns. ◀



Comply with the applicable environmental laws regulating the disposal of extended-duty antifreeze with corrosion inhibitor. ◀



Checking coolant level

Correct coolant level when the engine is cold approx. 68 °F / 20 °C:

Unscrew the cap from the expansion tank.

The coolant level is correct when the end of the red float is aligned with the upper edge of the filler opening (refer to the arrow in the illustration), or max.

0.8 in (2 cm) higher, i. e. up to the mark on the float (see also the schematic diagramm next to the cap).

Adding coolant

Wait until the engine cools before removing the cap from the expansion tank. The needle of the coolant gauge in the instrument cluster must be located in the blue zone. If it is not, there is a danger of scalding.

- 1 Start by turning the cap counter-clockwise. Pause to allow any accumulated pressure to escape, then open the cap.
- 2 If the coolant is low, slowly add coolant until the correct level is reached – do not overfill.

The coolant is a mixture of water and extended-duty antifreeze with corrosion inhibitor. Always maintain the prescribed all-season 50:50 mixture ratio for year-round protection against internal corrosion. No other additives are required.

Replace the coolant every four years.

Brake fluid



If the indicator lamp for the brake hydraulic system appears or if the CHECK BRAKE FLUID warning appears in the Check Control*: the brake fluid level is too low in the reservoir.



The brake fluid reservoir is located under the microfilter housing trim panel on the driver's side of the vehicle. For adding brake fluid or for determining and correcting the cause of brake fluid loss, consult your BMW center. Your BMW center is familiar with the specifications for factory-approved brake fluids (DOT 4).

Brake fluid loss may result in extended brake pedal travel. For this situation, refer to the notes on page [123](#).



Brake fluid is hygroscopic, that is, it absorbs moisture from the air over time.

In order to ensure the safety and reliability of the brake system, have the brake fluid changed every two years by an authorized BMW center. Refer also to the Service and Warranty Information Booklet (US models) or the Warranty and Service Guide Booklet (Canadian models).

Brake fluid is toxic and damages the vehicle's paint. You should always store it in its original container and in a location which is out of reach of children. Do not spill the fluid and do not fill the brake fluid reservoir beyond the "MAX" mark. The brake fluid could ignite upon contact with hot engine parts and cause serious burns. ◀



Comply with the applicable environmental laws regulating the disposal of brake fluid. ◀

Vehicle Identification No. 141

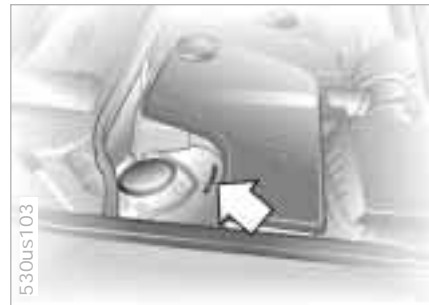

In the engine compartment, stamped on the right-hand strut dome (arrow) and on the upper edge of the instrument panel on the left-hand side.



The BMW Maintenance System has been designed as a reliable means of providing maximum driving and operating safety – and as cost-effectively as possible for you.

Please keep in mind that regular maintenance is not only necessary for the safety of your vehicle, but also plays a significant role in maintaining the resale value of the vehicle.

Service Interval Display

Advanced technology is employed to calculate the optimal maintenance intervals, which are then indicated in the Service Interval Display. Conventional systems rely solely on distance traveled to determine when service is due. The BMW maintenance system, on the

other hand, began many years ago to take the actual conditions under which the vehicle is driven into consideration. After all, different drivers can accumulate mileage in very different ways.

From the point of view of maintenance, 62,000 miles (100,000 km) accumulated in short-distance urban driving are not the equivalent of the same distance covered at moderate speeds in long-distance highway travel.

The BMW Maintenance System includes the Engine Oil Service and Inspections I and II.

Determining the maintenance intervals according to the actual loads on the vehicle covers every kind of operating situation. However, even those who drive only short distances – significantly less than 6,000 miles (10,000 km) annually – should have the engine oil changed at least every 2 years since oil deteriorates over time, regardless of use.

Service and Warranty Information Booklet (US models)/Warranty and Service Guide Booklet (Canadian models)

For additional information on maintenance intervals and procedures, please refer to the Service and Warranty Infor-

mation Booklet (US models) or the Warranty and Service Guide (Canadian models).

As a precaution against corrosion, it might be a good idea to have the body checked for damage from rocks or gravel at the same time, depending upon operating conditions.

 Have your BMW center do the maintenance and repair.

Your BMW center is always informed on the latest maintenance work and repair techniques and equipped with the required special tools. In addition, checking parts known from experience to be subject to wear is a permanent part of the maintenance specifications.

Be sure that all maintenance work is confirmed in the Service and Warranty Information Booklet (US models) or the Warranty and Service Guide (Canadian models).

These entries will constitute your proof that the vehicle has received regular maintenance. They are also required for warranty claims. ◀

Caring for your vehicle

Washing your vehicle

You can have your new BMW washed in an automatic car wash. Car wash systems that do not employ brushes are preferable.

Wipe away tough dirt and loosen and remove dead insects before washing the vehicle.

To prevent spots, avoid washing when the hood is still warm, or immediately after and during exposure to strong sunlight.

When using an automatic car wash, be sure that:

- ▷ The car wash system is suited for the dimensions of your vehicle.

 Before washing the vehicle in a car wash, fold in the exterior mirrors manually, otherwise they may be damaged on account of the width of the vehicle. ◀

- ▷ No damage will occur on vehicles with attached body accessories (such as spoilers or antennas). If you are uncertain, consult the manager of the car wash.
- ▷ The wheels and tires of your vehicle cannot be damaged by the conveyance devices of the car wash system.

- ▷ The vehicle is cleaned with minimum brush pressure, and that ample water is available for washing and rinsing.

Vehicles with rain sensor*:

Clean the windshield regularly. Wax from automatic car washes or insects, for example, can cause malfunctions in the function of the rain sensor.

 Turn the rain sensor off in automatic car washes. If you do not, damage may occur if the wipers switch on unintentionally. ◀

Parts of the vehicle that are inaccessible to the automatic washer – such as door sills, door and hood edges, etc. – should be cleaned by hand.

In the winter months, it is especially important to ensure that the vehicle is washed on a regular basis. Large quantities of dirt and road salt are difficult to remove, and they also cause damage to the vehicle.

 If spray wands or high-pressure washers are used, be sure to maintain an adequate distance between the spray source and the vehicle's surface. Inadequate distance and excessive pressure can damage or weaken the finish, making it more susceptible to

subsequent attack. In addition, moisture could penetrate to vehicle components, leading to long-term damage. ◀

-  When cleaning the headlamps, please observe the following:
 - ▷ Do not clean by wiping with a dry cloth. Never use abrasives or strong solvents to clean the covers.
 - ▷ Remove dirt and contamination (such as insects) by soaking with BMW Car Shampoo and then rinsing with plenty of water.
 - ▷ Always use a deicer spray to remove accumulated ice and snow – never use a scraper. ◀

 After washing the vehicle, apply the brakes briefly to dry them. Braking efficiency might otherwise be reduced by the moisture and the brake rotors could also be corroded. ◀

Exterior finish

To provide effective corrosion protection, multilayer paintwork is applied at the factory. Cathaphoretic immersion priming techniques are supplemented using special body-cavity protectants, with the application of specially-developed and extensively tested materials. A layer of flexible PVC is first applied to the undercarriage. Following this, a comprehensive undercoating treatment with a wax-based protectant is applied.

Regular maintenance makes an important contribution to maintaining the safety and value of your vehicle.

Increasing awareness of the effects of harmful environmental factors on vehicle finishes have led paint and vehicle manufacturers to initiate ongoing programs designed to further improve the durability of their finishes. Despite this, environmental factors that occur locally or regionally can have negative effects on the finish of your vehicle. These should guide you in determining the frequency and extent of your efforts to maintain the vehicle finish.

Depending upon material and type of impact (perforation of paint layer), physical stresses from sand, road salt, gravel, etc., can cause corrosion to start extending beneath the finish, starting at the point of impact.

Road dirt, tar spots, dead insects, animal droppings (strong alkali effect) and tree excretions (resins and pollen) all contain substances capable of causing damage when allowed to remain on the finish of your vehicle for any period of time (spots, etching, flaking, separation in the top coat).

In industrial areas, deposits from fly ash, lime, oil deposits, sulfur-dioxide in precipitation (acid rain) and other environmental pollutants will all damage the surface of the vehicle unless adequate protection is provided.

In coastal regions, high levels of atmospheric salt and humidity promote corrosion.

In tropical zones, temperatures of over 105 °F (40 °C) in the shade prevail, in addition to heavy ultraviolet radiation and high humidity. Under those conditions, light paints can reach temperatures up to 175 °F (80 °C) and dark paints up to 250 °F (120 °C).

Caring for your vehicle

Caring for the vehicle finish

Regular washing is a preventive measure against long-term effects from substances that are harmful to the vehicle's finish, especially if you drive your vehicle in areas with high levels of air pollution or aggressive natural substances (tree resins, pollen).

Nevertheless, you should immediately remove especially aggressive substances. Failure to do so can lead to changes in the paint's chemical structure or to discoloration. Gasoline spilled during refueling, oil, grease and brake fluid should always be cleaned away immediately, as should bird droppings (finish damage).

Any contamination remaining on the surface of the vehicle will be especially conspicuous after washing. Use cleaning fluid or alcohol with a clean cloth or cotton pad to remove these stains. Remove tar spots with tar remover. After cleaning, the affected areas should be waxed to ensure continued protection.

Waxing your vehicle

Protect the finish using carnauba or synthetic-based waxes only.

The best way to determine when the finish needs to be waxed is by noting when water stops beading on the surface.

You can use a glass cleaner to remove any wax or silicone that may have been left on the windows during waxing.

Paint damage

You can touch up small areas of damage with BMW spray paint or a BMW touchup stick.

The color code of your vehicle is provided on a tag on the right-hand panel under the hood and on the first page of the Service and Warranty Information Booklet.

Damage caused by flying stones, scratches, etc., must be touched up without delay to prevent rust from forming.

If corrosion has started to form in an area with paint damage, remove all rust and clean the area. Then prime the area with a BMW Primer Stick. Finally, apply the finish coat. After a few days, polish and protect the touched-in areas.

More extensive paint damage should be professionally repaired in accordance with the manufacturer's instructions. Your BMW center uses original BMW finish materials in accordance with factory repair procedures.



A full range of car-care products is available from your BMW center. ◀

Caring for your vehicle

Window care

You can use window and glass cleaner to clean inside window surfaces and mirrors without smearing and streaking. Never use polishing pastes or abrasive (quartz) cleansers on mirror lenses.

Clean the wiper blades with soapy water. The wiper blades should be replaced twice a year, before and after the cold season.



Use only wiper blades that have been approved by BMW. ◀

Caring for other vehicle components and materials

Light-alloy wheels should be treated with alloy wheel cleaner, especially during the winter months. However, do not use aggressive products containing acids, strong alkalis or abrasives. Do not use steam cleaners operating at temperatures above 140 °F (60 °C). Follow the manufacturer's instructions.

If your vehicle has chrome parts* such as window moldings, door handles or other items, clean these parts carefully with ample clean water, especially if they have an accumulation of road salt. Use chrome polish as an additional treatment.

Plastic components, vinyl upholstery, headliners, lamp lenses, the clear cover of the instrument panel and components with a sprayed dull black surface can be cleaned with water (add plastic cleaner as required). Do not allow moisture to soak through the seats or headliner. Never use solvents such as lacquer thinner, heavy-duty grease remover, fuels, etc.

Rubber components should be cleaned with water only; a rubber treatment or silicone spray may also be applied.

The safety belts should be cleaned with a mild soap and water solution without being removed from the vehicle. Never attempt chemical or dry cleaning, as damage to the belt fabric could result.

After cleaning, never allow the inertia reel to retract the belts until they are completely dry. Dirty safety belts prevent the inertia reel mechanism from retracting the strap properly, and thus constitute a safety hazard.

Heavily soiled floor carpets and mats* can be cleaned with an interior cleaner. The floor mats can be removed from the vehicle for cleaning.

Please use only a damp cloth to clean wooden fascia panels and components. Follow up by drying with a soft cloth.



A full range of car-care products is available from your BMW center. ◀

Caring for your vehicle

Leather care

The leather upholstery* used by BMW is a natural product of the highest quality, processed using state-of-the-art methods to ensure that it will maintain its high quality for years to come, provided that it is properly cared for.

Because this product is manufactured using natural materials, you must make allowance for its special characteristics as well as for the peculiarities of its use and care.

Regular periodic cleaning and care are essential, as dust and road dirt act as abrasives in the pores and creases of the material. This leads to wear spots and premature brittleness on the surface of the leather. We therefore suggest that you clean the leather with a vacuum cleaner or dust cloth at frequent intervals.

For cleaning use BMW leather cleaning foam.

Since dirt and grease gradually affect the protective surface layer of the leather, the cleaned surfaces should be treated with a BMW leather care agent. This also acts as an antistatic agent.

For protection against dampness or moisture, treat the leather with a BMW impregnating agent.

We recommend that you perform this procedure twice a year on leather exposed to normal use.

Spills should be wiped up immediately. Remove grease and oil stains without rubbing, but rather by dabbing with spot remover.

If the upholstery is to be exposed to intense sunlight or if the vehicle is to be stored for an extended period, cover all leather surfaces (or, better yet, the windows) to prevent fading.



A full range of car-care products is available from your BMW center. ◀



Cleaning agents can contain substances that are dangerous or pose health risks. For this reason, always read and comply with the warnings and danger notices on the package.

Open the doors or windows on your vehicle before cleaning the interior. Never clean your vehicle with cleaning agents (or solvents) not specifically intended for this purpose. ◀

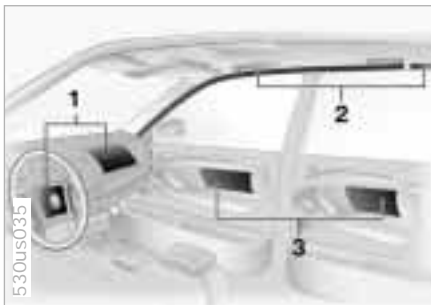

- 1 Front airbags for driver and front passenger
- 2 Side Impact Head Protection System (front and rear*)
- 3 Side airbags (front and rear*)

Important safety notices

 Do not attempt to remove the gas generators of the airbag restraint system from the vehicle. Testing and servicing are to be performed only by trained technicians. In the event of a malfunction, deactivation, or triggered actuation (as a response to an accident) of the airbag restraint system, consult your authorized BMW center for repairs or service operations.

Vehicle storage

Consult your BMW center regarding the required special procedures if you intend to store the vehicle for longer than three months.

Do not modify or tamper with either the wiring or the individual components in the airbag system. These include the padded steering wheel hub, the instrument panel, the side trim panels of the front or rear doors and the roof pillars or the sides of the headliner. Never apply adhesive materials to these components or cover or modify them in any way. Do not remove or dismantle the steering wheel yourself.

To ensure compliance with applicable safety regulations, have an authorized BMW center dispose of airbag generators.

Unprofessional attempts to service the system could lead to failure in an emergency or undesired airbag activation, either of which could result in personal injury. ◀

Technical modifications

Any authorized BMW center will be glad to inform you of the advisability, legal requirements and factory recommendations with regard to technical modifications on the vehicle. For this purpose, the BMW center will require the Vehicle Identification Number and, in some cases, also the engine number.

Light-Emitting Diodes (LEDs)

Light-emitting diodes installed behind translucent lenses serve as the light source for many of the controls and displays in your vehicle. The concept behind their operation is related to that employed for lasers, and they are formally designated as Class 1 light-emitting diodes.



Do not remove the protective lens and avoid staring directly at the unfiltered beam for extended periods (several hours), as inflammation of the iris could result. ◀

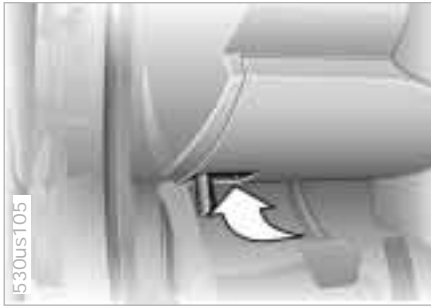

The Onboard Diagnostic (OBD) interface socket is located on the left of the driver's side at the bottom of the instrument panel and under a cover.

The cover has the letters "OBD" on it.

The purpose of the OBD system is to ensure proper operation of the emission control system for the vehicle's lifetime. The system monitors emission-related components and systems for deterioration and malfunction.



An illuminated lamp informs you of the need for service, not of the need to stop the vehicle.

However, the systems should be checked by your BMW center at the earliest possible opportunity.

Under certain conditions, the indicator will blink or flash. This indicates a rather severe level of engine misfire. When this occurs, you should reduce speed and consult the nearest BMW center as soon as possible. Severe engine misfire over only a short period of time can seriously damage emission control components, especially the catalytic converter.



Warning lamp, Service Engine Soon for Canadian models.



When the filler cap is not properly tightened, the OBD system can detect the vapor leak and the indicator will light up. If the filler cap is subsequently tightened, the indicator should go out within a few days. ◀

- Index
- Data
- Technology
- Repairs
- Car care
- Controls
- Overview



Replacement procedures:

Onboard tool kit [154](#)
Wiper blades [154](#)
Lamps and bulbs [155](#)
Changing a wheel [161](#)
Battery [165](#)
Fuses [167](#)

In case of electrical malfunction:

Fuel filler door [168](#)
Sliding/Tilt sunroof [168](#)
Liftgate [168](#)
Tailgate [169](#)

Assistance, giving and receiving:

Jump-starting [170](#)
Towing the vehicle [171](#)

Overview

Controls and features

Operation, care and maintenance

Owner service procedures

Advanced technology

Technical data

Index

Overview

Controls

Car care

Repairs

Technology

Data

Index



Under the cargo area floor in a pocket.

Wiper blades



Front

- 1 Move the wiper to a fold-out position (refer to page 69).
- 2 Lift the wiper arm and press the securing spring (arrow).
- 3 Pull the wiper blade off toward the wiper arm.
- 4 Insert the new blade and snap it into place.

 Fold the wipers back down onto the windshield before you turn the ignition key to position 1 or 2 again. If you do not, they could be damaged. ◀



Rear

- 1 Hold the wiper blade on the window and remove/unclip the wiper arm at the articulated joint (arrow).
- 2 Insert a new wiper blade and press it on/clip it into the wiper arm.

 Use only wiper blades approved by BMW. ◀

Lamps and bulbs

The lamps and bulbs are essential factors contributing to the safety of your vehicle. For this reason, follow the instructions below carefully when replacing a bulb. If you are not familiar with any of the procedures, consult your authorized BMW center.

 Do not touch the glass portion of a new bulb with your bare hands since even small amounts of impurities burn into the surface and reduce the service life of the bulb. Use a clean cloth, paper napkin, or a similar material, or hold the bulb by its metallic base. ◀

A replacement bulb set is available from your BMW center.

 Whenever working on the electrical system, switch off the electrical accessory you are working on or disconnect the cable from the negative terminal of the battery. Failure to do this could result in short circuits. To prevent injuries and damage, comply with any instructions provided by the bulb manufacturer. ◀

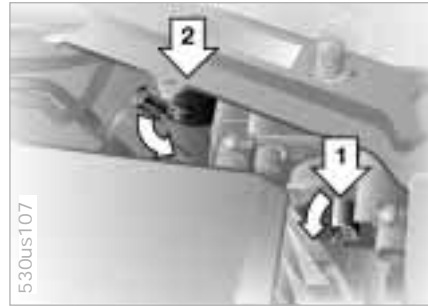

The illustration shows the right-hand engine compartment.

 For checking and adjusting headlamp aim, please contact your BMW center. ◀

1 Low beams

H7 bulb, 55 watts

 The bulb is pressurized. Therefore, wear safety glasses and protective gloves. Failure to comply with this precaution could lead to injury if the bulb is accidentally damaged during replacement. ◀

- 1 Turn the bulb holder to the left (arrow) and remove.
- 2 Remove and replace the bulb.

2 High beams

HB3 bulb, 60 watts

 The bulb is pressurized. Therefore, wear safety glasses and protective gloves. Failure to comply with this precaution could lead to injury if the bulb is accidentally damaged during replacement. ◀

- 1 Turn the bulb holder to the left and remove.
- 2 Disconnect the plug.
- 3 Plug the new bulb holder with bulb into the plug connector. Be sure that it is securely engaged.
- 4 Install in the opposite order.

 When cleaning the headlamps, please observe the following:

- ▷ Do not clean by wiping with a dry cloth (scratches). Never use abrasives or strong solvents to clean the covers.
- ▷ Remove dirt and contamination (such as insects) by soaking with BMW Car Shampoo and then rinsing with plenty of water.
- ▷ Always use a deicer spray to remove accumulated ice and snow – never use a scraper. ◀

Xenon lamps*

The operating life of these lamp units is extremely long and the likelihood of failure very low, provided that they are not switched on and off a very great number of times. If one of these bulbs should nevertheless fail, it is possible to continue driving with great caution using the fog lamps, provided traffic laws in your area do not prohibit this.

 Because of the extremely high voltages involved, any work on the lighting system should be carried out by technically-qualified personnel only. Failure to comply with this creates a risk of fatal injury. ◀

Turn signal indicator/Parking lamp (side marker lamps), front

Dual-filament bulb, 28/8 watts

Please contact a BMW center in case of a malfunction.

**Side turn signals**

5 watt bulb

- 1 Use finger pressure against the rear end of the lens (arrow) to press it forward for removal.
- 2 Press gently on the bulb and turn it to the left to remove it.

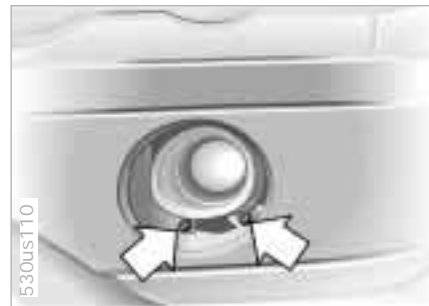
**Front fog lamps**

H1 bulb, 55 watts

 The bulb is pressurized. Therefore, wear safety glasses and protective gloves. Failure to comply with this precaution could lead to injury if the bulb is damaged during replacement. ◀

- 1 Pull the cover in front of the foglamp forward.
- 2 Loosen the two screws (arrows) and remove the foglamp.
- 3 Turn the cover cap on the rear of the foglamp to the left and remove.
- 4 Unhook the wire clamp, remove the contact base and replace the bulb.

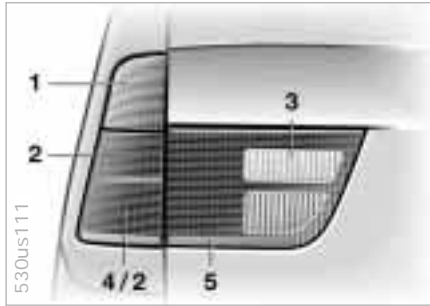

Tail lamp assembly

Tail lamp 2: 21/5 watt bulb
 Remaining bulbs: 21 watts

- | | |
|------------------------------------|-----------------|
| 1 Turn signal indicator | yellow or white |
| 2 Rear lamps/
Side marker lamps | red |
| 3 Backup lamps | white |
| 4 Brake lamps | red |
| 5 Reflector | red |



Lamps in the side panel:

- 1 Open the cover in the side panel.
- 2 Lift the side panel if necessary.
- 3 Press gently on the lamp holder and turn it to the left to remove it.
- 4 Remove the bulb.



Lamps in the tailgate:

- 1 Unclip the trim panel in the lower tailgate with a screwdriver.
- 2 Press gently on the lamp holder and turn it to the left to remove it.
- 3 Remove the bulb.

Center (high-mount) brake lamp

LED strip in the rear spoiler: please contact a BMW center in case of a malfunction.

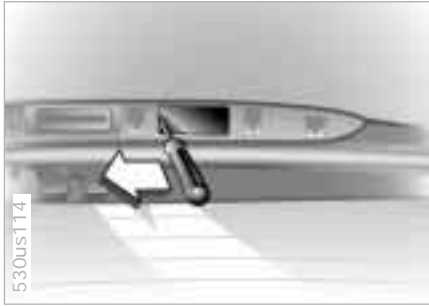

License plate lamps

5 watt bulb

- 1 Press the lamp out to the side with a screwdriver.
- 2 Remove the lamp and replace the bulb.



Interior lamps

Front and rear*

Interior lamp (6 watt bulb) with reading lamps (two 6 watt bulbs)

- 1 Press the lamp out to the side with a screwdriver.
- 2 Turn the bulb holder to the left and remove.
- 3 Remove and replace the bulb.

Rear

Interior lamp (2 x 5 watt bulb)

- 1 Press the lamp out to the front with a screwdriver.
- 2 Take off the lens and pull the lamp out of the contact tab.

Cargo area lamps

Two lamps in the trim panel of the upper tailgate:
6 watt bulbs

- 1 Apply a screwdriver in the recess to press the lens out.
- 2 Replace the bulb.

Footwell lamps, front

5 watt bulb

- 1 Press the lamp out with a screwdriver.
- 2 Replace the bulb.

Footwell lamps in the rear passenger area

5 watt bulb

- 1 Use a screwdriver to press the lens out to the side.
- 2 Replace the bulb.

Lamps and bulbs

Glove compartment lamp

5 watt bulb

- 1 Apply a screwdriver in the recess to press the lamp out.
- 2 Remove the reflector.
- 3 Replace the bulb.

Lighted vanity mirror

10 watt bulb

- 1 Remove the bulb housing. Use a screwdriver if necessary.
- 2 Replace the bulb.

Exit lamps

Lamp in the lower door trim panel:

5 watt bulb

- 1 Press the lamp out with a screwdriver.
- 2 Replace the bulb.

Front area lighting*

6 watt Xenon bulb

Please contact a BMW center in case of a malfunction.

160 Changing a wheel

 Safety measures in the event of a flat tire or wheel change:

Stop the vehicle as far as possible from passing traffic. Park on a firm, flat, surface. Switch on the hazard flashers.

Turn the steering wheel to the straight-ahead position, remove the key and engage the steering lock. Select "Park" position and engage the parking brake. All passengers should be outside the vehicle and well away from your immediate working area (behind a guardrail, for instance). If a warning triangle or portable hazard warning lamp is available, set it up on the roadside at an appropriate distance from the rear of the vehicle. Comply with all safety guidelines and regulations. Change the wheel only on a level, firm surface which is not slippery.

Avoid jacking the vehicle up on a soft or slippery surface (snow, ice, very smooth surfaces, etc.), since it could slide sideways. Position the jack on a firm support surface. Do not place wooden blocks or similar objects under the jack. If this is done, the jack might not be able to reach its full support capacity because of the limited height. Do not lie under the vehicle or start the engine when the vehicle is supported by the jack. Failure to comply with this creates a risk of fatal injury. ◀



What you will need

In order to avoid rattling noises later, note the position of the tools when you remove them and return them to their original position when you are through using them.

- ▷ Two wedges (wheel chocks)
Open the liftgate and tailgate. In the cargo area, fold up the floor cover or pull-out cargo floor (refer to page [110](#) or [111](#)). Take out the wedges (arrow) next to the spare wheel.

- ▷ Lug wrench
Is located next to the spare wheel.
- ▷ Vehicle jack
Refer to page [162](#).

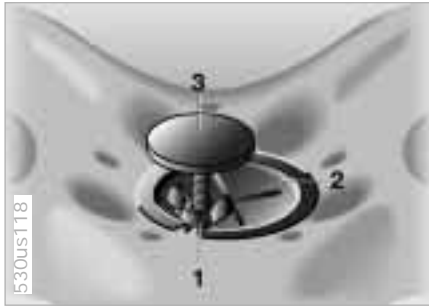

Spare wheel

- 1 Loosen the wing nut 1.
- 2 Remove the plate 2 to the side.
- 3 Unscrew the threaded rod 3 completely.



Removal aid for the spare wheel

By using this device, you do not have to lift the spare wheel out of the recess by hand.

Its task is to help you to move the wheel onto the tailgate, from where you can easily lift it off.

- 1 Close the tailgate again.
- 2 Grasp the handle of the removal aid behind the spare wheel with both hands and pull upward over the tailgate (arrow).



- 3 Hook both buckles into the latch of the tailgate (arrow); the tailgate is released.

162 Changing a wheel

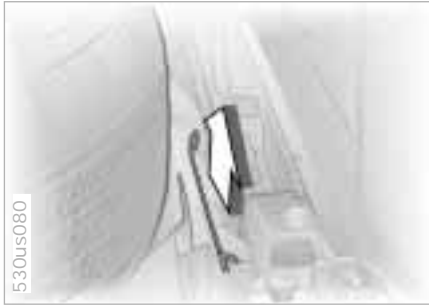

4 Remove support rod from bracket.



5 Press the tailgate down and hold it there. The spare wheel is now pulled by means of the removal aid onto the tailgate.

 Hold the tailgate in the opened position and do not allow it to retract sharply upward. If you do so, there is a risk of personal injury and vehicle damage. ◀

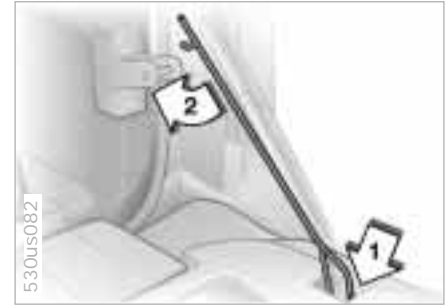

6 Insert support rod in tailgate lock and press down until it engages (arrow 1); then lock hook of rod in striker (arrow 2).

 Be sure that the support rod is locked firmly in place. If you fail to do so, it could retract sharply upward and cause personal injury and vehicle damage. ◀

7 You can now release the locked tailgate and take the spare wheel down from the tailgate. It is recommended that you leave the tailgate locked into place until you have completed the wheel change and placed the wheel with the defective tire into the removal aid.



▷ Vehicle jack

Unscrew the wing screw (arrow) and remove the jack.

When you have completed work, screw the jack all the way back down. Fold the handle back and insert it into its holder.

Procedure

- 1 Read carefully and comply with the safety precautions on page 160.
- 2 Secure the vehicle to prevent it from rolling:
Place the wedges (chocks) behind the wheels on the side opposite the side you are lifting. If the vehicle is parked on a downward slope, place the wedges securely in front of the wheels. If the wheel must be changed on a surface with a more severe slope, take additional precautions to secure the vehicle from rolling.
- 3 Loosen the lug bolts 1/2-turn.

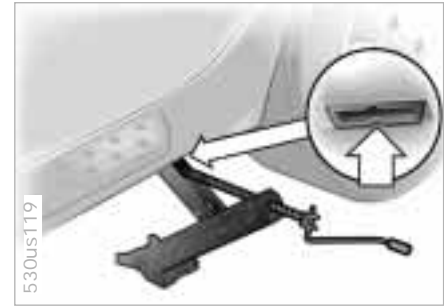

- 4 Position the jack at the jacking point closest to the flat tire so that the jack base is vertically below the jacking point and the entire surface of the head of the jack will move into the square recess of the jacking point (refer to the illustration detail) when the jack is cranked.
- 5 Jack the vehicle up until the wheel you are changing is raised from the ground.
- 6 Unscrew the lug bolts and remove the wheel.
- 7 Remove accumulations of mud or dirt from the mounting surfaces of the wheel and hub. Clean the lug bolts.
- 8 Position the spare wheel. Secure the wheel by turning at least two lug bolts into opposite bolt holes.

164 Changing a wheel

- 9 Screw in the remaining lug bolts. Tighten all the bolts securely.
- 10 Lower the jack and remove it from beneath the vehicle.
- 11 Tighten the lug bolts in a diagonal pattern.
- 12 Check and correct the tire inflation pressure at the earliest opportunity.

 The vehicle jack is designed for changing wheels only. Do not attempt to raise another vehicle model with it or to raise any load of any kind. To do so could cause accidents and personal injury.

To ensure continued safety, have the tightness of the lug bolts checked with a calibrated lug wrench [torque specification: 94 ft-lb (130 Nm)] at the earliest opportunity. ◀

Store the wheel and the tools in the order opposite that for removal. Be sure that the jack is first placed back into its original position.

 Before removing the support rod, be sure that the tailgate is held down firmly. If you fail to do so, it could retract sharply upward and cause personal injury and vehicle damage. After you remove the rod, close the tailgate carefully. Continue to hold it firmly until it is completely closed. ◀

If light-alloy wheels other than original BMW light-alloy wheels have been mounted, it may be necessary to use different lug bolts for those wheels.

Replace the defective tire as soon as possible and have the new wheel/tire balanced.



The spare wheel has a size 235/65 R 17 tire. If you have mounted tires on your vehicle with a different size, have wheels and tires of the same size and specification reinstalled as soon as possible. When the spare wheel is mounted, the maximum speed rating is 130 mph (210 km/h). ◀

Battery

Battery location

The battery is located in the floor of the vehicle below the spare wheel.

Battery care

The battery is maintenance-free, that is, the original electrolyte will normally last for the service life of the battery under moderate climatic conditions.

 For all questions that regard the battery, please consult your BMW center. Since the battery is maintenance-free, the following is for your information only. ◀

Symbols

You will find the following symbols on your vehicle battery. To avoid injury, please comply with the corresponding precautions whenever you work with or near the battery.



Before handling the battery, please read the following information:



Wear eye protection. Do not allow particles containing battery acid or lead to come into contact with your eyes, your skin, or your clothing.



Battery acid is extremely corrosive. Wear eye protection and protective gloves. Do not tip the battery. Battery acid can leak from the ventilation openings.



Do not allow children to have access to batteries and battery acid.



Never allow sparks or open flame near the battery. Do not smoke in the vicinity of the battery. Avoid sparks from electrical cables or electrical equipment. Turn the key to position 0 in the steering lock when you are disconnecting or connecting the battery. Never short-circuit the battery terminals. This creates a risk of injury from high-energy sparks.



A highly-explosive gas is generated when the battery is charged.



If you happen to get acid in your eyes, rinse thoroughly for 15 minutes with clear water.

Following that, consult a physician immediately. If you get acid spray on your skin or clothing, rinse with plenty of water. If electrolyte is accidentally swallowed, consult a physician immediately.



In order to protect the battery case from ultraviolet radiation, do not place it in direct sunlight.

A discharged battery can freeze. Store the battery in areas where temperature remains above freezing.

Charging the battery

Charge the battery in the vehicle only when the engine is not running. Use the connections provided in the engine compartment (for correct connections, refer to "Jump-starting" on page 170).



The service life specified for the battery can be achieved only if it is always kept adequately charged. Have the charge condition of the battery checked frequently if the vehicle is used primarily for driving short distances. ◀



Before performing any work on the electrical system, disconnect the cable from the negative terminal. If you do not, short circuits can create the risk of fire or personal injury. ◀

If you plan to park the vehicle longer than 4 weeks, have the battery disconnected from the vehicle's electrical system by disconnecting the cable from the negative terminal. Then have the battery charged with an appropriate battery charger.

If the vehicle will not be driven for a period longer than 12 weeks, have the battery removed, charged and store it in a clean and cool (frost-free) area. Recharge the battery at least every three months during storage. Also, recharge the battery before it is installed. If you fail to do so, it will not be serviceable. Every time the battery is discharged, especially over extended periods, its service life is reduced.



Do not disconnect the battery when the engine is running. If you do so, the ensuing voltage surge will damage the vehicle's onboard electronics.

Do not make any modifications in the wires to the positive terminal. If you do so, the protective function of the safety battery terminal is no longer ensured. Repair and disposal must be performed by trained technicians only. ◀



Return used batteries to a recycling point or your authorized BMW center. Maintain the battery in an upright position for transport and storage. Secure the battery against tilting in transit. ◀



When an electrical accessory fails to operate, switch it off and inspect the fuse.

In the glove compartment

- 1 Open the glove compartment and turn the two quick-release knobs to the left. Spare fuses and plastic tweezers are located on the fuse holder.
- 2 Use the plastic tweezers to remove the fuse for the accessory or equipment that has stopped working.
- 3 If the fuse is burned through (the metal strip will have melted and separated), replace it with a new fuse of the same ampere rating (color code).

A list of the fuses, their respective ampere ratings and the equipment in their circuits is provided below the fuse holder.

Close the fuse holder by holding the top of the cover in place and screwing the two quick-release knobs to the right.

Additional fuses are provided in the cargo area.

The fuse for continuous positive current is located in a separate fuse box in front of the spare wheel. If this fuse is defective, refer the problem to your BMW center for repair.



Do not attempt to repair a burned fuse or replace it with a fuse having a different color or amperage rating. To do this could cause a fire in the vehicle resulting from a circuit overload. ◀

If the fuse continues to burn through, have the problem corrected by a BMW center.

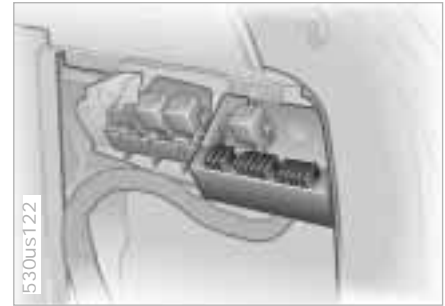

In the cargo area

Open the right cover by pulling the handle.

A list of the fuses, their respective ampere ratings and the equipment in their circuits is provided on the rear of the cover.

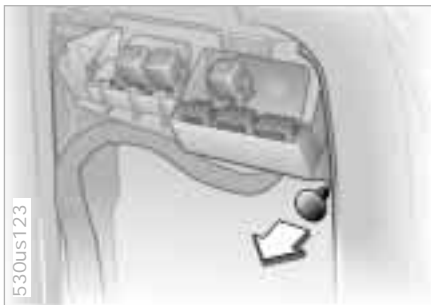

Manual release

In the event of an electrical malfunction, you can release the fuel filler door manually:

- 1 Open the cover on the right in the cargo area: lift the handle on the cover.
- 2 Pull the button with the fuel pump symbol (arrow).



Manual operation

In the event of an electrical system malfunction, you can operate the sliding/tilt sunroof manually:

- 1 Open the glasses compartment (refer to page 102).
- 2 Insert the Allen wrench from the vehicle tool kit (refer to page 154) in the opening provided and turn the sliding/tilt sunroof in the desired direction .



Manual release

In the event of an electrical malfunction, you can release the liftgate manually:

- 1 Remove the plastic plug from inside the cargo area and pull toward the interior (arrow). The liftgate will be released.
- 2 Reinstall the plug.

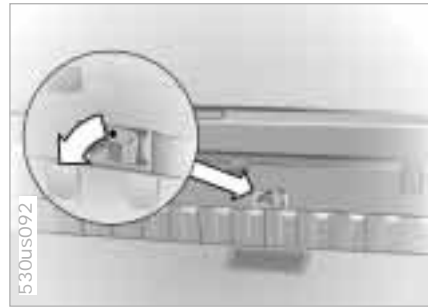
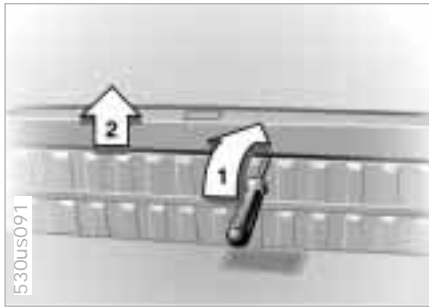

Manual release

In the event of an electrical malfunction, you can release the tailgate manually.

1 Unfasten the trim panel clip with the vehicle key or with a screwdriver (arrow 1) and remove it toward the top (arrow 2).

- 2 Using the same tool, press the latch in the direction of the arrow; the tailgate is released.
- 3 Reinstall the trim panel.

170 Jump-starting

Do not use spray starter fluids to start the engine.

If the battery is discharged, the engine can be started with the use of two jumper cables and the battery of another vehicle. Always use jumper cables with fully insulated handles on the terminal clamps.

 Do not touch the parts conducting current while the engine is running. Failure to comply with this creates a risk of fatal injury. ◀

Carefully comply with the following instructions to avoid personal injury and damage to one or both vehicles:

- 1 Be sure that the battery on the support vehicle is also rated at 12 volts, and that the capacities of the two batteries (Ah) are roughly comparable (printed on casing).
- 2 Leave your battery connected to the vehicle's electrical system.
- 3 Make sure that there is no contact between the bodywork of the two vehicles – this creates a risk of short circuits.



- 4 Start by connecting the jumper cable from the positive terminal of the support vehicle to the positive terminal connector located in your BMW's engine compartment. The cover of the auxiliary terminal for jump starting is marked with a "+" sign (refer to the illustration). To remove the cover, tip up the cap (arrow).



- 5 Then connect the negative terminals. Attach the cable to either the support vehicle's negative battery terminal (-), or to a suitable ground on its engine or bodywork. Then connect the other end of the cable to a ground on the engine or on the bodywork of the vehicle that is to be started. There is a special nut for this on the left side panel of your BMW. Refer to the arrow in the illustration.

 Follow the same sequence for connecting the jumper cables when helping other vehicles. If you do not, there is the risk of injury if sparks generate at the battery. ◀

Jump-starting

- 6 Start the engine on the support vehicle and let it run.
- 7 Start the engine on the vehicle needing the jump-start, and allow it to run as usual. If the first start attempt is not successful, wait a few minutes before another attempt in order to allow the discharged battery to recharge.
- 8 Before disconnecting the jumper cables from your BMW, turn on the rear window defroster and set the blower to the highest speed; allow the engine to run approx. 10 seconds. This will prevent a voltage surge from the voltage regulator to the electrical accessories.
- 9 Then disconnect the jumper cables in reverse sequence.

Have the battery recharged if necessary.

Towing the vehicle



Tow fitting

The screw-in tow fitting is stored beneath the cargo area floor. Carry it with you at all times. This fitting is designed for installation in the tow sockets located at the front and rear of the vehicle, and is intended for towing on paved road surfaces only. It should not be used to pull a vehicle out of deep snow, mud, sand, etc. Always observe all applicable towing laws and regulations.

Access to tow sockets

Front:

Use a screwdriver on the left or right side (arrows) to press the cover out .



Rear: pull the cover off.

 Screw the tow fittings in until they are tight. If you do not, the threads could be damaged. Do not tow the vehicle by any components of the running gear, or lash them down in any way. If you do so, the components could be damaged, leading to possible accidents. ◀

Use only a nylon towing strap to tow the vehicle, since the inherent resilience of this material helps protect both vehicles from sudden jerking movements.

 Avoid "off-center" towing. Be sure that the tow rope is pulled tightly when the towing vehicle begins to move. ◀

 The towed vehicle should always be the lighter of the two vehicles. If this is not the case, it is no longer possible to control vehicle response. ◀

Tow-starting

It is not possible to start the engine of a vehicle equipped with automatic transmission by towing or pushing.

For instructions on jump starting: refer to page 170.

Never attempt to use your vehicle to push another car. If you do so, damage to the energy-absorbing bumpers could result.

Towing

- 1 Place the selector lever in "Neutral".
- 2 Towing speed:
Max. 45 mph (70 km/h).
- 3 Towing distance:
Max. 95 miles (150 km).
- 4 Leave the ignition key at position 1 to ensure that the brake lamps, turn signals, horn and windshield wipers remain operative, and to prevent the steering lock detent from engaging.
- 5 Switch on the hazard-warning system (comply with country-specific regulations).

Find some means of identifying the vehicle in tow, for instance, place a sign or warning triangle in the rear window.

 Make sure that the ignition key remains in position 1 even when the electrical system has failed. This will prevent the steering lock from engaging. The steering and brakes are without power assist when the engine is not running. This means that increased effort is required for steering and braking. ◀

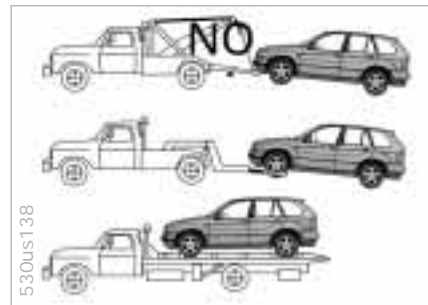

Towing with a commercial tow truck

- ▷ Do not tow with sling-type equipment.
 - ▷ Use a wheel lift or flat bed carrier.
 - ▷ Please comply with applicable towing laws.
-  Never allow passengers to ride in a towed vehicle for any reason. ◀

Towing the vehicle

Towing with a raised axle

- 1 Place the selector lever in "Neutral".
- 2 Switch off the engine.
- 3 Towing speed:
Maximum 30 mph (50 km/h).
- 4 Towing distance:
Maximum 95 miles (150 km).



Remove the rear driveshaft for longer towing distances with the front axle lifted; remove the front driveshaft for towing over longer distances with the rear axle lifted. Failure to comply with this will result in damage to the transfer box. ◀

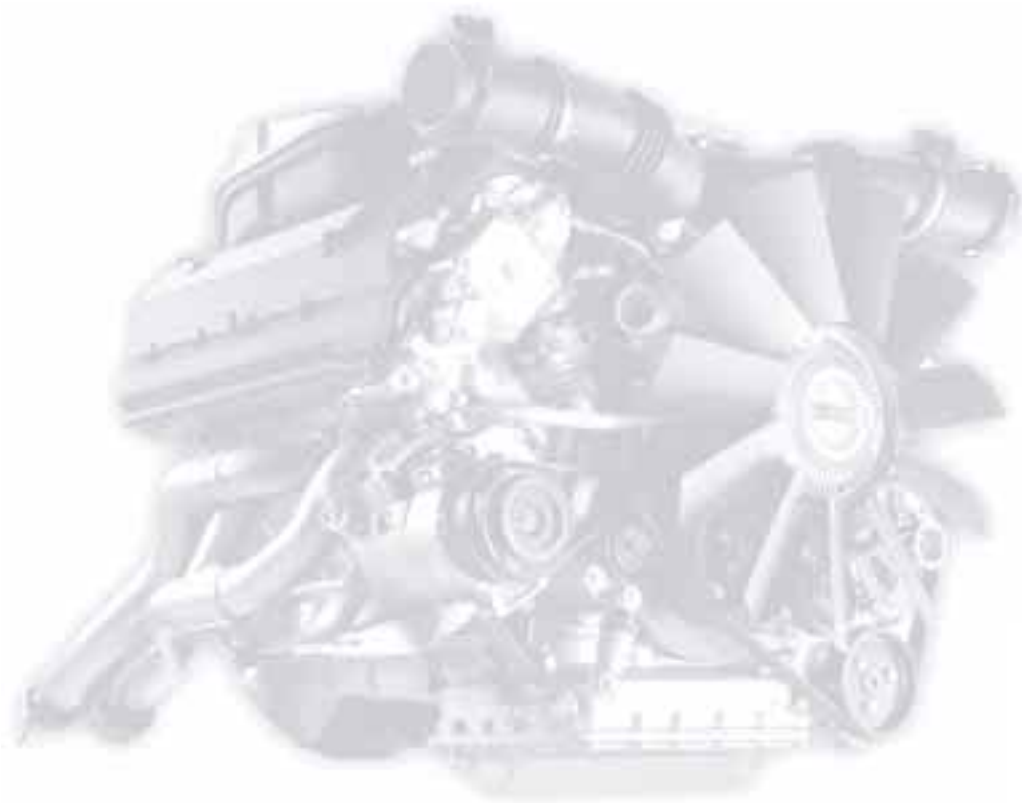



Airbags [176](#)
Adaptive Transmission Control
(ATC) [176](#)
Four-wheel drive [177](#)
Dynamic Stability Control
(DSC) [177](#)
Radio reception [178](#)
Safety belt tensioner [178](#)
DSP sound system [179](#)
Rearview mirrors with automatic
dimmer [179](#)
Rain sensor [180](#)
Integrated rear suspension [180](#)
Level control system [181](#)
Xenon lamps [181](#)

Overview

Controls and features

Operation, care and maintenance

Owner service procedures

Advanced technology

Technical data

Index

Overview

Controls

Car care

Repairs

Technology

Data

Index



Deceleration sensors continuously monitor the physical forces acting upon the vehicle. If, as the result of a frontal collision, vehicle deceleration is reached at which the protection of the safety belts alone is no longer adequate, the gas generators of the driver-side and passenger-side airbags are ignited simultaneously. However, the passenger-side airbag is only triggered if an additional sensor has recognized that the passenger seat is occupied.

In the event of a side collision, the head protection and side airbags in the front or rear* are triggered if necessary.

The airbags located under the marked covers inflate and unfold in a matter of a few milliseconds. In this process, they tear through the designed separation points of the upholstered covers or press them out.

Because the inflation process must be virtually instantaneous, it is necessarily accompanied by a certain amount of ignition and inflation noise. The gas required to inflate the airbags is not dangerous, and the associated smoke then dissipates.

The entire process is completed within fractions of a second.



Adaptive Transmission Control (ATC) uses a number of factors to calculate the gear which provides the maximum efficiency of the automatic transmission. In this process, the system monitors your personal driving style, the driving situation, the condition of the road, and the traffic conditions.

ATC recognizes your personal driving style from the positions and movements of the accelerator pedal, deceleration when braking, and lateral acceleration through curves. Four different shift characteristics – from comfort-oriented to performance-oriented – are available for selection by ATC.

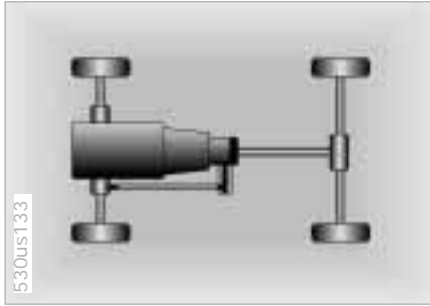

The transmission of power to the four drive wheels is provided permanently through a transfer box. The distribution of torque between the front and rear axles is 38 % to 62%.

Traditional differential locks at the front and rear axles and in the transfer box are not required. Their function is taken over by automatic braking intervention at all four wheels. These traction interventions are governed by Automatic Differential Brake (ADB), a sub-function of DSC.

If a wheel tends to slip, it is braked automatically by ADB until it once again gains traction, and drive force can be transmitted to that wheel. In addition, the drive force is distributed to the remaining wheels during this system

intervention. Engine output is also reduced if necessary.

When the DSC is deactivated, the ADB traction intervention is set for the maximum drive force. However, the engine intervention and the stability controls are no longer available. For this reason, DSC should only be deactivated in the exceptional circumstances described on page 83.

The BMW X5 is a vehicle for all types of roads. The permanent four-wheel drive provides a significant degree of vehicle stability and tractive power under all road conditions. It assists in critical situations such as driving in extreme winter conditions or on bad roads.

Precision sensors monitor the wheel speeds, the steering angle, lateral acceleration, brake pressure and the movement of the vehicle around its vertical axis.

If differences in wheel speeds occur, the system recognizes the danger of wheelspin and reduces the engine's drive torque. If necessary, the system also responds with additional braking intervention at all four wheels.

In addition, DSC permanently monitors the vehicle's current operating condition and compares it with an ideal condition that is calculated from the sensor signals. If discrepancies from this ideal condition (understeering or oversteering, for example) occur, DSC stabilizes the vehicle in fractions of a second by reducing engine power output and with the assistance of braking intervention at individual wheels. Dangerous skids are thus prevented from the very beginning.

You may need some time to become accustomed to this system intervention. However, it provides optimum drive force and vehicle stability.

The braking intervention may be accompanied by certain sounds specific to the system.

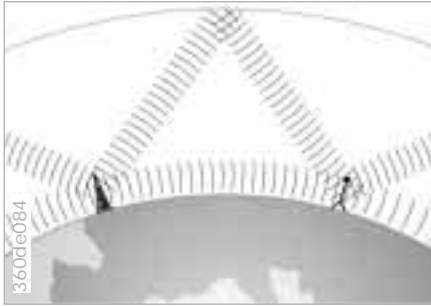

Radio waves – mediumwave, long-wave and shortwave – offer a wide range of reception, because the broadcast signals travel not only along the ground as surface waves, but also as waves bounced back to earth from the ionosphere.

Frequency-modulation (FM) provides substantially better sound quality than AM. However, because FM transmissions rely on line-of-sight broadcast waves, their effective reception range is limited.

Although numerous factors combine to impose inherent limitations on the reception quality available from mobile radios, specially designed systems can be employed to minimize their effects:

The Diversity Antenna system employs several FM antennas integrated within the rear window. An integral processor automatically selects the antenna with the best FM reception quality at any given time. Because the ongoing antenna selection process is completed within milliseconds, it remains inaudible to the radio listener.



The safety belt tensioner responds to collisions by tightening the belts to ensure that occupants remain firmly positioned in their seats. A gas-pressure system retracts the buckle assembly to tension the shoulder and lap belts within fractions of a second. This reduces the tendency to slide under the lap belt.

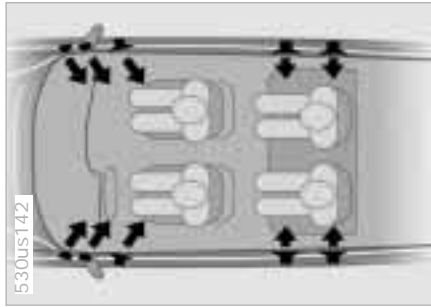

The DSP Professional premium sound system features a special amplifier combined with Digital Sound Processing (DSP) and integrated speakers to surround you with crisp, true-to-life sound reproduction. The speaker system's subwoofers, woofers, midrange speakers and tweeters furnish you with an impressively full-bodied listening experience. The individual components are oriented so as to produce the aural sensation that you would experience facing the stage in a concert hall. The system also automatically adjusts the bass and treble settings to compensate for changes in volume and vehicle speed.

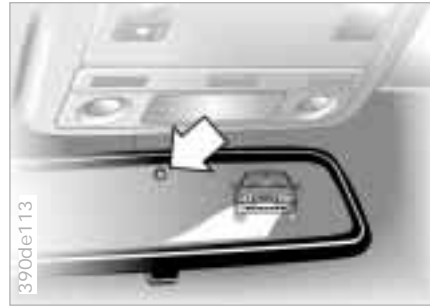

The interior and exterior rearview mirrors with automatic dimming feature reduce glare from following traffic by adapting the intensity of the reflected images to correspond to levels of light registered by the unit's sensors. The mirrors revert to their undimmed setting as soon as the light source disappears. A forward facing sensor is mounted on the front of the interior mirror housing and is designed to monitor light levels in the area forward of the vehicle. A second sensor is integrated within the mirror's glass. The electronic control system operates by comparing the respective levels of luminous intensity in front of and behind the vehicle.

The difference provides the basic parameter used to modulate an electrical current and induce chemical changes in a semisolid layer incorporated in the lenses.

The semisolid reacts chemically to this electrical current, thus providing dimming of the mirrors through an infinitely-variable range (electrochromic technology).

As a result, it is no longer necessary to dim the interior mirror manually, and the driver can concentrate completely on traffic conditions.

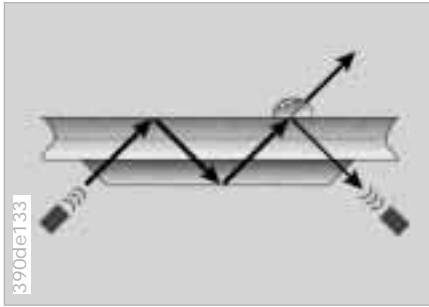

The rain sensor controls windshield wiper operation, depending on how wet the windshield is.

Infrared light is carried along the surface of the windshield in an optical conductor in such a manner that it is reflected completely when the windshield is dry. The quantity of reflected light is measured.

If the window is covered with beads of water, the amount of light that is reflected is decreased since the infrared light at the surface of the windshield can then escape. The quantity of reflected light is thus a means of gauging the degree of wetness on the windshield.

When the system is set to the "Intermittent" wiper speed, the wipers react immediately – if water is splashed onto the windshield by vehicles traveling ahead of you, for example. As a result, the rain sensor provides a contribution to driving safety and comfort.



This axle is based on the same multi-link principle as that in series-7 vehicles. The axle's kinematics and elastic kinematics are critical for wheel control – a significant prerequisite for achieving the objective of exceptional onroad handling characteristics with this vehicle concept.

In order to reduce unsprung mass, the wheel carriers and the swing arm are made of aluminum.

For an outstanding quality in acoustics and vehicle oscillation characteristics, the differential is isolated with double elasticity through a chassis sub-frame toward the vehicle body.



The level control system for the rear axle maintains constant ground clearance of your vehicle, even when carrying a load.

For this purpose, the vehicle is equipped with air springs instead of steel springs at the rear axle. With the help of two sensors, an electronic control unit calculates the height of the body at all times and, if it is required, it allows air which is generated in a compressor to flow into the air springs.

As a result of the pressure increase in the air springs, the level control system ensures not only constant ride height, but also ride comfort which is independent of the load the vehicle is carrying.

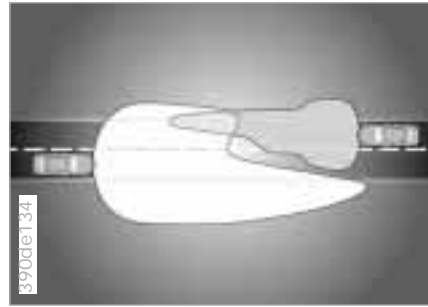

Xenon lamps illuminate the side and front areas of the vehicle with significantly more brightness and uniformity than traditional halogen lamps.

In a xenon lamp, an electric arc replaces the filament in order to generate intense illumination. A gas mixture in a quartz glass tube with metal vapor is ignited by a high electric voltage. The arc that is generated is then sustained by a lower voltage. When the lamp is turned on there is a brief period of high intensity. Maximum brightness is attained in approx. 15 seconds.

Xenon lamps provide significantly-improved visibility, especially during adverse weather conditions and driving situations (driving at night in heavy rain or through road repair areas where there are no lane markers, for instance).

Vehicles with xenon lamps are equipped with automatic headlamp range control. As a result, the highway is always optimally lighted, regardless of load conditions, and drivers in on-coming traffic are not blinded.

Xenon lamps make a significant contribution to highway safety since other highway users, or bicyclists and motorcyclists in the right lane, and pedestrians are more easily detected.

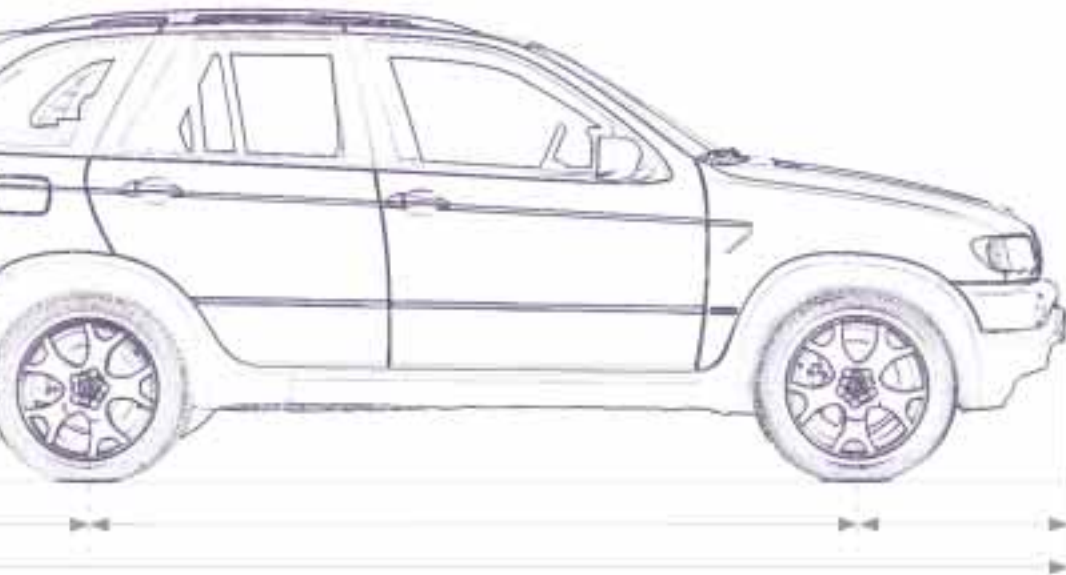

Engine specifications 184
 Dimensions 185
 Weights 186
 Capacities 187
 Electrical system 188
 Drive belts 188

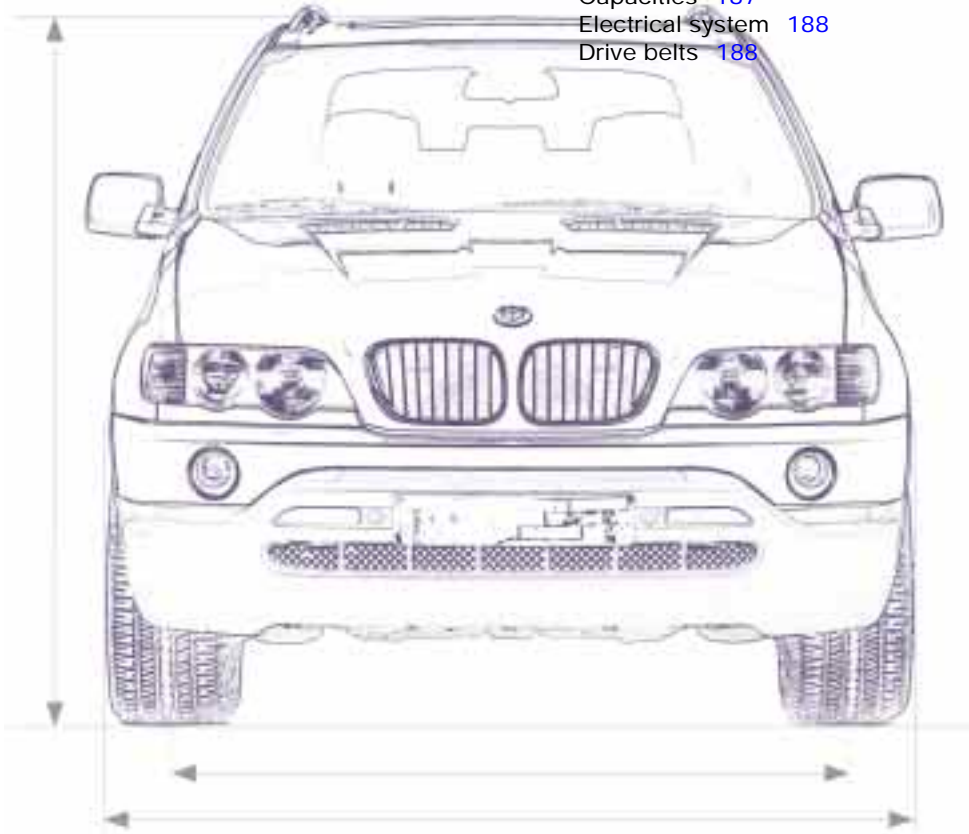

Overview

Controls and features

Operation, care
and maintenance

Owner service procedures

Advanced technology

Technical data

Index

Overview

Controls

Car care

Repairs

Technology

Data

Index

184 Engine specifications

		BMW X5 4.4i
Displacement	cu in (cm ³)	268.4 (4,398)
Number of cylinders		8
Max. output at engine speed	hp rpm	282 5,400
Maximum torque at engine speed	lb ft (Nm) rpm	324 (440) 3,600
Compression ratio		10.0
Stroke	in (mm)	3.26 (82.7)
Bore	in (mm)	3.62 (92)
Fuel-injection system	Digital-electronic engine-management system	

An engine performance test is authorized only on an appropriate chassis dynamometer.

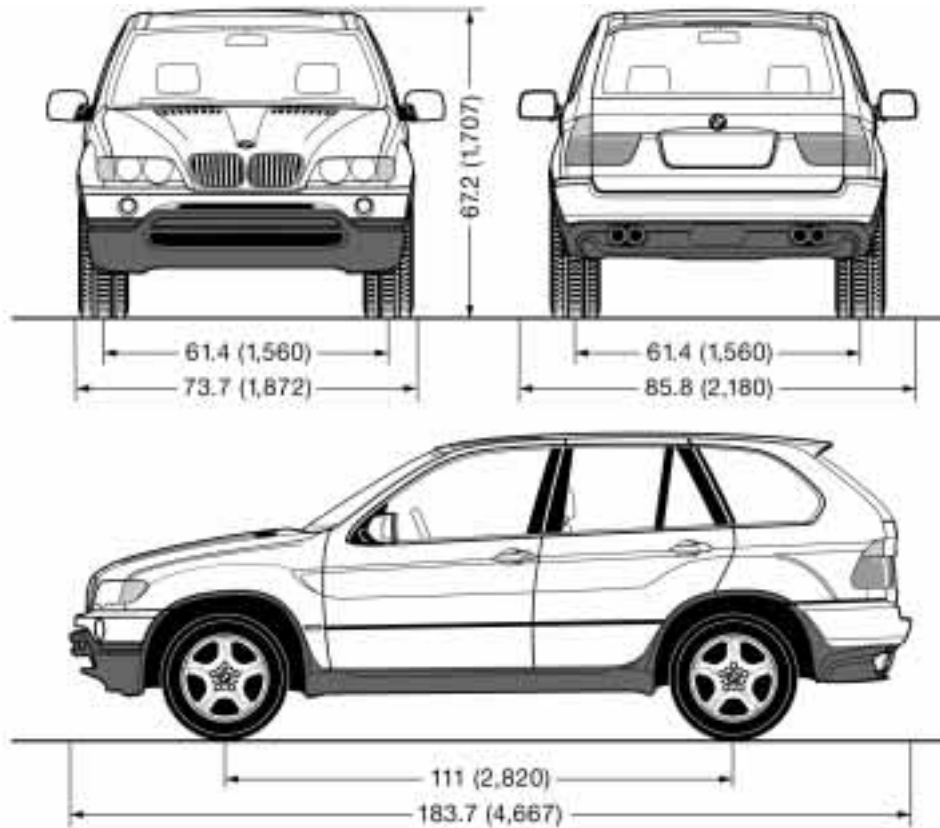

All dimensions are given in inches (mm). Min. turning circle dia.: 39.7 ft (12.1 meters)

		BMW X5 4.4i
Curb weight (with one person, ready for operation, full tank of fuel, options not included)		
with manual transmission	lbs.(kg)	-
with automatic transmission	lbs.(kg)	4,795 (2,175)
Approved gross vehicle weight		
with manual transmission	lbs.(kg)	
with automatic transmission	lbs.(kg)	5,842 (2,650)
Approved front axle weight	lbs.(kg)	2,712 (1,230)
Approved rear axle weight	lbs.(kg)	3,219 (1,460)
Approved roof load capacity	lbs.(kg)	220 (100)
Never exceed either the approved axle weights or the gross vehicle weight.		
Cargo area capacity	cu ft (l)	16.1 - 54.4 (455 - 1,540)

			Notes
Fuel tank	gal. (liters)	approx. 24.2 (approx. 92)	Fuel specification: page 30
Reserve	gal. (liters)	approx. 2.6 (approx. 10)	
Windshield washer system with headlamp washer system	quarts (liters)	approx. 8.2 (approx. 7.8)	For details: page 136
Cooling system including heater circuit	quarts (liters)	12.7 (12.0)	For details: page 140
Engine oil and filter change	quarts (liters)	8.5 (8.0)	"BMW High Performance Synthetic Oil". For details: page 138
Automatic transmission, transfer box and differential	-	-	Lifetime fluid, no fluid change required

Battery

12 V, 90 Ah

Spark plugs

NGK BKR 6 EQUIP

Bosch FGR 7 DQP

(not released at this time)

This spark ignition system meets all requirements of the Canadian Interference-Causing Equipment Regulations (ICES-2).

Drive belts

Water pump – Alternator – Power steering

V-belt 7 K x 1635

A/C compressor

V-belt 5 K x 1004



You can obtain Original BMW Parts and Accessories, as well as professional advice from your authorized BMW center. ◀

Overview

Controls

Car care

Repairs

Technology

Data

Index

A B C

P Q R

Everything from A to Z [192](#)
Owner service procedures [198](#)

Overview

Controls and features

Operation, care
and maintenance

Owner service procedures

Advanced technology

Technical data

Index

Overview

Controls

Car care

Repairs

Technology

Data

Index

Everything from A to Z

A

ABS (Antilock Brake System) [119](#)
Accessories [6](#)
Activated-charcoal filter [95](#)
Adaptive Transmission Control (ATC) [176](#)
Adding engine oil [137](#)
Adding washer fluid [136](#)
Adjusting seats [48](#)
Adjusting the steering wheel [51](#)
Adjusting the temperature [92](#)
Air conditioner [93](#)
Air distribution [92](#)
Air nozzles [90](#)
Air outlets [90](#)
Air pressure [30](#), [127](#)
Air supply [93](#)
Airbags [23](#), [57](#), [148](#), [176](#)
Alarm system [43](#)
Antennas [126](#)
Antifreeze [140](#)
Antifreeze, radiator [123](#)
Antilock Brake System (ABS) [119](#)
Anti-theft alarm system [43](#)
Anti-theft protection [37](#)
Approved gross vehicle weight [186](#)
Aquaplaning [118](#), [127](#)
Ashtray [103](#)

AUC (Automatic recirculated air control) [93](#)
Automatic car washes [143](#)
Automatic climate control [90](#)
Removing condensation from the windows [93](#)
Automatic cruise control [72](#)
Automatic curb monitor [54](#)
Automatic dimming, interior rearview mirror [53](#)
Automatic recirculated air control (AUC) [93](#)
Automatic steering wheel adjustment [52](#)
Automatic transmission with Steptronic [66](#)
Average fuel consumption [80](#)
Average speed [80](#)
Axle loads [186](#)

B

Backup lamps [67](#)
Bulb replacement [157](#)
Battery [165](#), [188](#)
Capacity [188](#)
Charge [166](#)
Discharged [170](#)
Belts [56](#)
Beverage holder [102](#)
Blower [93](#)
BMW comfort seat [50](#)

BMW High Performance Synthetic Oil [138](#)
BMW sports seat [50](#)
BMW Universal Transmitter [98](#)
Body-cavity protectant [144](#)
Brake fluid [141](#)
Brake hydraulic system [22](#)
Brake lamps, bulb replacement [157](#)
Brake pads [24](#)
Brakes [122](#)
Malfunctions [123](#)
Break-in procedures [116](#)
Bulb replacement [155](#)

C

Capacities [187](#)
Car Memory [55](#)
Car radio reception [126](#), [178](#)
Car wash [143](#)
Care, exterior [144](#)
Care, interior [146](#)
Cargo area [42](#), [107](#)
Capacity [186](#)
Opening from the inside [41](#)
Cargo area cover [107](#)
Cargo area lamps [87](#)
Cargo floor, pull-out [111](#)
Cargo loading [112](#)

Caring for the vehicle finish [145](#)
Catalytic converter [118](#)
CBC (Cornering Brake Control) [120](#)
Cellular phones [102](#), [126](#)
refer to the separate Owner's Manual
Center (high-mount) brake lamp [157](#)
Central locking system [36](#)
Button [40](#)
Changing a tire [160](#)
Changing a wheel [160](#)
Charge indicator lamp [22](#)
Check air pressure [30](#)
CHECK button [77](#)
Check Control [77](#)
Check engine oil level [137](#)
Checking tire pressure [30](#)
Child restraint systems [57](#)
Child's seat [57](#)
Child-safety locks [62](#)
Cigarette lighter [103](#)
Clean the windshield [70](#)
Climate control in the rear passenger area [94](#)
Clock, refer to the Radio or Onboard Computer Owner's Manual
Cockpit [16](#)
Code, refer to the Radio Owner's Manual [126](#)

- Cold start [64](#)
- Comfort seat [50](#)
- Compartments [101](#)
- Computer [80](#)
- Configuring the settings [55](#)
- Contamination on paintwork [144](#)
- Convenience operation of windows and sliding/tilt sunroof [36](#)
- Convenience starting feature [64](#)
- Coolant [123, 140](#)
- Coolant, antifreeze [123](#)
- Cornering Brake Control (CBC) [120](#)
- Cruise control [72](#)
- Cup holder [102](#)
- Curb weight [186](#)

- D**
- Dashboard [16](#)
- Data link connector for On-Board Diagnostics [150](#)
- Date, refer to the Radio or Onboard Computer Owner's Manual
- Daytime-driving lamp [86](#)
- DBC (Dynamic Brake Control) [24, 120](#)
- Deep water [117](#)
- Defrosting the windows [93](#)
- Digital clock, refer to the Radio or Onboard Computer Owner's Manual
- Digital sound processor [179](#)
- Dimensions [185](#)
- Dipstick, engine oil [137](#)
- Disc brakes [122](#)
- Displacement [184](#)
- Display lighting [86](#)
- Displays [18, 20](#)
- Distance warning [82](#)
- Diversity Antenna system [178](#)
- Divided rear backrest [107](#)
- Door keys [34](#)
- Door locks, care [123](#)
- Doors
 - Manual operation [36](#)
 - Remote control [38](#)
 - Unlocking and locking [36](#)
- Drive belts [188](#)
- Driving through water [117](#)
- Driving your BMW X5 [117](#)
- DSC (Dynamic Stability Control) [24, 83, 177](#)
- DSP amplifier, refer to the Radio Owner's Manual
- Dynamic Brake Control (DBC) [24, 120](#)
- Dynamic Stability Control (DSC) [24, 83, 177](#)

- E**
- EBV (Electronic Brake Force Distribution) [120](#)
- Electric power windows [45](#)
- Electrical malfunction
 - Fuel filler door [168](#)
 - Liftgate [168](#)
 - Sliding/Tilt sunroof [168](#)
 - Tailgate [169](#)
- Electrical system [188](#)
- Electronic Brake Force Distribution (EBV) [120](#)
- Electronic immobilizer [35](#)
- Elements of operation [16](#)
- Emergency operation
 - Doors [36](#)
 - Fuel filler door [168](#)
 - Sliding/Tilt sunroof [168](#)
 - Tailgate [168](#)
- Energy Control [75](#)
- Engine compartment [134](#)
- Engine coolant [140](#)
- Engine knock control [30](#)
- Engine oil consumption [137](#)
- Engine oil grades [138](#)
- Engine oil level [24](#)
- Engine oil pressure [22](#)
- Engine output [184](#)
- Engine specifications [184](#)
- Error indicators [77](#)
- Exterior finish [144](#)
- Exterior mirrors [52](#)

- F**
- Failure of an electrical accessory [167](#)
- Failure warnings [77](#)
- Filler cap cover [29](#)
- First-aid kit [28](#)
- Fittings, tow-starting and towing [171](#)
- Flashlight [101](#)
- Flat tire [127, 160](#)
- Fog lamps [87](#)
 - Bulb replacement [156](#)
- Folding rear backrest [107](#)
- Footbrake [122](#)
- Footwell lamps [88](#)
 - Bulb replacement [158](#)
- Front area lighting [88](#)
- Front fog lamps [87](#)
- Front seat adjustment [48](#)
- Frost protection, radiator [140](#)
- Fuel [30](#)
- Fuel capacity [187](#)
- Fuel display [75](#)

Everything from A to Z

Fuel filler door release after
electrical fault [168](#)
Fuel gauge [75](#)
Fuel quality [30](#)
Fuel tank capacity [187](#)
Fuses [167](#)

G

Garage-door opener [98](#)
Gasoline [30](#)
General driving notes [118](#)
Glasses compartment [102](#)
Glove compartment [101](#)
Glove compartment lamp,
bulb replacement [159](#)
Gross vehicle weight [186](#)
Ground clearance [117](#)

H

Handbrake [65](#)
Handsfree system [102](#)
Hazard warning flashers [28](#)
Hazard warning triangle [28](#)
HDC (Hill Descent
Control) [84](#)
Head restraints [49](#)
Headlamp covers,
care [143](#), [155](#)
Headlamp flasher [69](#)
Headlamp washer
system [136](#)

Headlamp washers [70](#)
Heated steering wheel [96](#)
Heating and ventilation [90](#)
Heating while stopped [94](#)
Heavy cargo [112](#)
Height [185](#)
Height adjustment, seats [48](#)
Height adjustment, steering
wheel [51](#)
HiFi system [179](#)
High beams [25](#), [87](#)
Bulb replacement [155](#)
Hill Descent Control
(HDC) [84](#)
Hood release [133](#)
Horn [26](#), [27](#)
Hydraulic Brake Assistant
refer to DBC [24](#), [120](#)

I

Ice warning [74](#)
Identification number [141](#)
Identification, tires [130](#)
Ignition key [34](#)
Ignition lock [63](#)
Independent ventilation [97](#)
Indicator lamps [22](#)
Inflation pressure [31](#), [127](#)
INSPECTION [76](#)
Instrument cluster [18](#), [20](#)
Instrument lighting [86](#)

Instrument panel [20](#)
Instruments [18](#)
Integrated rear axle [180](#)
Interference indicators [77](#)
Interference, cellular
phone [126](#)
Interior and exterior rearview
mirrors, automatic
dimming feature [53](#)
Interior lamps [87](#)
Bulb replacement [158](#)
Remote control [38](#)
Interior mirror [53](#)
Interior motion sensor [44](#)
Interior rearview mirror,
automatic dimming
feature [179](#)
Interlock [63](#)
Intermittent switch [69](#)

J

Jump-starting [170](#)

K

Key Memory [55](#)
Keys [34](#)
Keys with radio remote
control [34](#)
Kickdown [67](#)

L

Lashing eyes [42](#), [112](#)
Leather care [147](#)
Length [185](#)
Level control
system [24](#), [125](#), [181](#)
License plate lamp, bulb
replacement [158](#)
Liftgate [42](#), [168](#)
Light switch [86](#)
Light-alloy wheel [132](#)
Lighter [103](#)
Lights-on warning [86](#)
Load-securing devices [112](#)
Louvers [90](#)
Low beams [86](#)
Bulb replacement [155](#)
Low-fuel warning lamp [75](#)
Lug bolts [163](#)
Lug wrench [160](#)
Luggage net [42](#)
Luggage space [42](#)
Luggage straps [42](#)
Lumbar support [49](#)

M

M+S tires [131](#)
Maintenance [76](#), [142](#)
Manual operation
Doors [36](#)
Liftgate [168](#)
Sliding/Tilt sunroof [168](#)
Tailgate [169](#)

Master key [34](#)
Memory [54](#)
Microfilter [95](#)
MID (Multi-Information Display), refer to the Radio Owner's Manual
Mirror [52](#)
Mirror defrosting [52](#)
Mirror memory [54](#)
Mobile phones [126](#)
Modifications, technical [6](#), [149](#)
Multifunction steering wheel [26](#)
Multi-Information Display (MID), refer to the Radio Owner's Manual

N

Navigation system, refer to the separate Owner's Manual

O

OBD interface socket [150](#)
Odometer [74](#)
Oil additives [137](#)
Oil change interval, see the Service and Warranty Information Booklet (US models) or the Warranty and Service Guide Booklet (Canadian models)

Oil consumption [137](#)
Oil dipstick [137](#)
Oil grades [138](#)
Oil level, indicator lamp [23](#), [24](#)
Oil pressure, indicator lamp [22](#)
OILSERVICE [76](#)
Onboard computer [80](#)
refer also to the Onboard computer Owner's Manual
Onboard monitor refer to the separate Owner's Manual
Onboard tool kit [154](#)
Opening and closing From the inside [40](#)
From the outside [36](#)
Operating range [80](#)
Outlets, ventilation [90](#)
Output [184](#)
Outside temperature display [74](#)
Outside temperature in the onboard computer [80](#)

P

Paintwork, minor repairs [145](#)
Paintwork, waxing [145](#)
Park Distance Control (PDC) [82](#)
Parking aid [82](#)

Parking brake [23](#), [65](#)
Parking in the winter [125](#)
Parking lamps [87](#)
Passenger side mirror tilt function [54](#)
PDC (Park Distance Control) [82](#)
Playing cassettes, refer to the Radio Owner's Manual [126](#)
Playing CDs, refer to the Radio Owner's Manual [126](#)
"Please wear your safety belt" warning lamp [23](#)
Pocket flashlight [101](#)
Pollen [95](#)
Poor driving conditions [117](#)
Power rear-seat backrests [51](#)
Power seat [48](#)
Power steering [125](#)
Power windows [45](#)
Safety switch [46](#)
Pressure, tires [127](#)
Pre-warmed seats [96](#)
Pull-out cargo floor [111](#)

R

Radio reception [126](#), [178](#)
Radio, refer to the Radio Owner's Manual [126](#)
Reading lamps [88](#)
Rear backrests, folding down [107](#)
Rear lamps [157](#)
Rear passenger area climate control [94](#)
Rear seats, power [51](#)
Rear view mirror [52](#)
Rear window defroster [71](#), [94](#)
Rear window wiper [71](#)
Rear window wiper, wiper blade replacement [154](#)
Rear-seat backrest, folding down [107](#)
Rear-seat backrests, power [51](#)
Recirculated air mode [93](#)
Reclining seat [48](#)
Refueling [29](#)
Remote control [37](#)
Removing condensation from the windows [93](#)
Replacement key [34](#)
Replacement of tires [128](#)
Reservoir, washer system [136](#)
Residual heat [94](#)

Everything from A to Z

Restraint system 57
Reverse 67
Rims 130
Roof load capacity 186
Roof-mounted luggage rack 113
Rubber parts 124

S

Safety belt height adjustment 56
Safety belt tensioner 178
Safety belts 56
Safety lock buttons 40
Seat heating 96
Seat memory 54
Seat, power 48
Securing cargo 42, 112
Securing the load 112
Selector lever, automatic transmission 66
Service and Warranty Information Booklet (US models) 142
Service Interval Display 76, 142
Servotronic 125
Shiftlock 66
Shoulder support 50
Shutting off the engine 65
Side airbags 57
Side Impact Head Protection System 57

Side lamps 86
 Bulb replacement 156
Ski bag 105
Skidcontrol 125
Sliding/Tilt sunroof 46
 Closing following an electrical malfunction 168
 Convenience operation 36
 Power loss 47
 Remote control 38
Slippery roads 124
Snow chains 124, 131
Socket 104
Spare key 34
Spare tire 161
Spare wheel 161
Spark plugs 188
Speaker 102
Special wash program 70
Speed control 72
Speedometer 18, 20
Sports seat 50
Starting 64
Starting problems 64, 118, 170, 171
Steering 125
Steering wheel adjustment 51
 Automatic 52
Steering wheel heating 96
Steering wheel lock 63
Steering wheel memory 54

Steptronic 66
Storage compartments 101
Storage compartments in the cargo area 109
Storing the vehicle 148
Summer tires 130
Sun visors 53
Switching off the vehicle 65
Symbols 4
Synthetic oils 138

T

Tachometer 75
Tail lamps 157
 Bulb replacement 157
Tailgate 42
 Opening from the inside 41
 Opening from the outside 41
 Radio control operation 39
 Release following an electrical malfunction 168
Technical modifications 6, 149
Telephone hookup 102
Telephone, refer to the separate Owner's Manual
Temperature display, outside temperature 74, 80
Temperature gauge 76

Temperature layering 94
Tight support adjustment 50
Third brake lamp 157
Tilt alarm 38, 44
Tilt function, passenger side mirror 54
Timer, refer to the Radio Owner's Manual
Tire code 130
Tire damage 127
Tire inflation pressure 31, 127
Tire renewal 128
Tire rotation between front and rear 129
Tire specifications 132
Tire tread 127
Tools 154
Torque 184
Tow fittings 171
Towing 171
Tow-starting 172
Track width 185
Traction Control System refer to DSC 83
Transmission 66
Tread depth, tires 127
Trip odometer 74
Turn signal indicator 69
 Bulb replacement 156, 157
Turning circle 185

Everything from A to Z

U

- Universal Transmitter 98
- Used batteries 166

V

- Valve caps 130
- Vanity mirror 53
- Vehicle battery 165, 188
- Vehicle care, interior 146
- Vehicle Identification No. 141
- Vehicle immobilizer 35
- Vehicle jack 160, 163
- Vehicle keys 34
- Vehicle removal from service 148
- Ventilation 94
- Ventilation in the rear 94
- Ventilation while parked 97
- Ventilation, draft-free 94
- Vinyl care 146
- Viscosity 138

W

- Warm feet – cool head 94
- Warning lamps 22
- Warnings 77
- Warranty and Service Guide (Canadian models) 142
- Washer reservoir, filling 136
- Washer/Wiper system 69
- Washing your vehicle 143

- Waxing, paintwork 145
- Weights 186
- Wheelbase 185
- Wheels and tires 130, 132
- Width 185
- Windows 45
 - Convenience operation 36
 - Remote control 38
- Windshield washer nozzle adjustment 136
- Windshield washer reservoir, filling 136
- Windshield wiper 69
- Windshield wiper blade replacement 154
- Winter driving 124
- Winter operation 123
- Winter tires 130, 131
- Wiper blade replacement 154
- Wipers 69
- Work in the engine compartment 133

X

- Xenon lamps 156, 181

Owner service procedures

- A**
Adding brake fluid 141
Adding coolant 140
Adding engine oil 137
Adding washer fluid 136
Adjusting washer nozzles 136
Air pressure 30, 127
Avoiding unintentional alarms 44
- B**
Battery, discharged 170
Brakes, brake faults 123
- C**
Changing a wheel 160
Charging the battery 166
Check Control 77
Check oil level 137
Checking tire pressure 30
- D**
Deactivating the interior motion sensor 38, 44
Deactivating the tilt sensor alarm system 38, 44
Defrosting the windows 93
Difficult steering 125
Doors, manual operation 36
- E**
Electrical malfunction
Fuel filler door 168
Liftgate 168
Sliding/Tilt sunroof 168
Tailgate 169
Emergency operation
Doors 36
Fuel filler door 168
Liftgate 168
Sliding/Tilt sunroof 168
Tailgate 169
Engine oil grades 138
- F**
Failure messages 77
Failure of an electrical accessory 167
Fault displays 77
Filling the windshield washer reservoir 136
First-aid kit 28
Fittings, tow-starting and towing 171
Flat tire 160
Fog lamp, bulb replacement 156
Footwell lamps, bulb replacement 158
- G**
Glove compartment lamp, bulb replacement 158
- H**
Hazard warning flashers 28
Hazard warning triangle 28
Headlamp covers, care 143, 155
High beams, bulb replacement 155
Hood release 133
- I**
Indicator lamps 22
Interior lamps, bulb replacement 158
- J**
Jump-starting 170
- L**
Level control system, inactive 125
License plate lamps, bulb replacement 158
Liftgate
Release following an electrical malfunction 168
- Low beams, bulb replacement 155
Lug wrench 160
- M**
Maintenance 76, 142
Malfunction displays 77
Manual operation
Doors 36
Liftgate 168
Sliding/Tilt sunroof 168
Tailgate 169
- O**
Oil grades 138
Onboard tool kit 154
- P**
Pressure, tires 30, 127
- R**
Rear window wiper, wiper blade replacement 154
Releasing the fuel filler door following an electrical malfunction 168
Releasing the hood 133
Releasing the tailgate following an electrical malfunction 169

Owner service procedures

Removal aid for the spare wheel [161](#)

Removing condensation from the windows [93](#)

Replacement key [34](#)

Replacing bulbs [155](#)

Replacing fuses [167](#)

Replacing windshield wiper blades [154](#)

Reservoir, washer system [136](#)

S

Side lamps, bulb replacement [156](#)

Sliding/Tilt sunroof
Closing following an electrical malfunction [168](#)

Power loss [47](#)

Snow chains [131](#)

Spare key [34](#)

Spare tire [161](#)

Spare wheel
removal aid [161](#)

Starting assistance [170](#)

Starting problems
[64](#), [118](#), [170](#), [171](#)

T

Tailgate
Release following an electrical malfunction [169](#)

Tire damage [127](#)

Tire inflation
pressure [30](#), [127](#)

Tools [154](#)

Tow fittings [171](#)

Towing [171](#)

Tow-starting [172](#)

Turn signal indicator, bulb
replacement [156](#), [157](#)

U

Use antifreeze, radiator [140](#)

W

Warning lamps [22](#)

Warning messages [77](#)

Wiper blade
replacement [154](#)

Work in the engine
compartment [133](#)



Refueling

So that you will have important specifications available when you stop to refuel, we recommend that you supplement this table with data which apply to your vehicle.

Fuel

Designation	
AKI: minimum	
AKI: for rated performance	
AKI: for enhanced performance	

Engine oil

Quality	
---------	--

The oil volume between the two marks on the oil dipstick corresponds to approx. 1.1 US quarts (1 liter).

Tire inflation pressures

		Summer		Winter	
		Front	Rear	Front	Rear
4 persons					
5 persons or 4 plus luggage					

**We wish you an enjoyable
driving experience**



The Ultimate Driving Machine

Free Manuals Download Website

<http://myh66.com>

<http://usermanuals.us>

<http://www.somanuals.com>

<http://www.4manuals.cc>

<http://www.manual-lib.com>

<http://www.404manual.com>

<http://www.luxmanual.com>

<http://aubethermostatmanual.com>

Golf course search by state

<http://golfingnear.com>

Email search by domain

<http://emailbydomain.com>

Auto manuals search

<http://auto.somanuals.com>

TV manuals search

<http://tv.somanuals.com>