

Radio/Cassette

Lyon CC 28

Operating instructions



 **BLAUPUNKT**
Bosch Gruppe

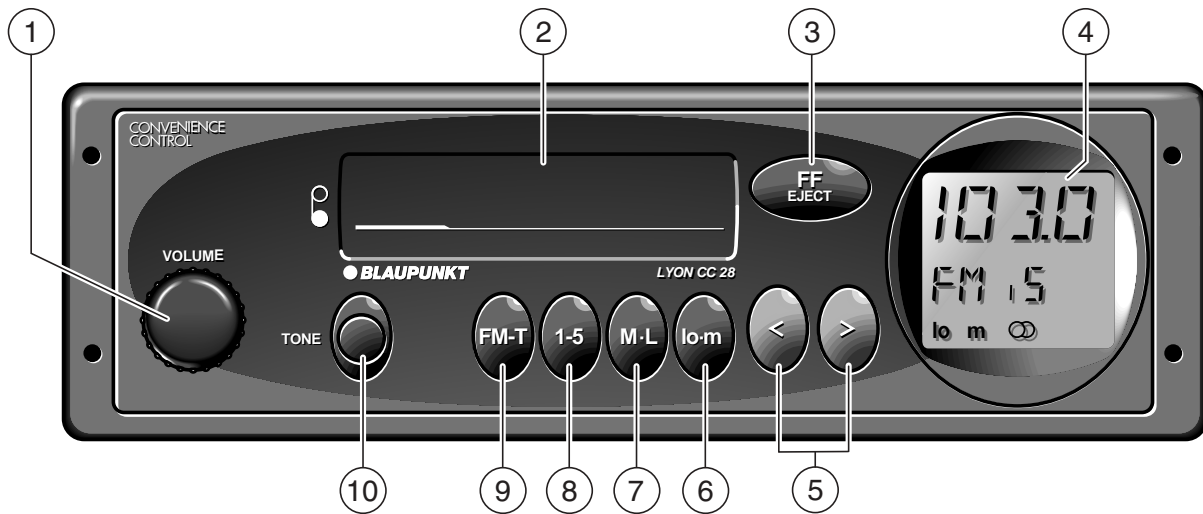

Table of Contents

Important information 10

Traffic safety 10

Installation / Hook-up 10

Radio operation 10

Select the frequency range 10

Station search 10

Manual station search 10

Adjusting station search sensitivity 10

Stereo - mono switch 10

Storing stations 11

Storing the strongest stations
automatically 11

Recalling stored stations 11

Cassette tape operation 11

Insert cassette tape 11

Remove cassette tape 11

Fast forward 11

Care of your audio equipment 12

Appendix 12

Technical data 12

Legend

① On/off

Turn knob.

On ↻

Off ↻

Adjust volume:

Turn knob.

② Cassette tape slot

③ FF - Fast forward

Start/end fast forward: press button gently.

Eject - Eject cassette tape:

Press button firmly.

④ Display for

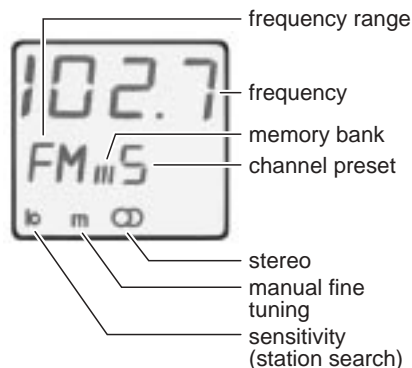

⑤ < >

Station selection

automatic or manual ("m" in display).

Switch over by pressing **lo•m** ⑥

⑥ lo•m

lo lit up in the display indicates normal sensitivity for the station search function (only FM).

lo not lit up in the display indicates high sensitivity for the station search function (only FM).

m lit up indicates manual station fine tuning.

Added feature:

Switch over from stereo to mono:

Press **lo•m** for longer than 2 seconds.

⑦ M•L

AM and long-wave (LW) switch.

Press this button repeatedly if necessary.

⑧ 1-5

For storing and recalling radio stations

⑨ FM•T (frequency modulation)

Switch for the FM memory banks I, II, III and "T" (**T**Travelstore) - for storing and recalling the six nearest, strongest station signals.

Store "T":

Press **FM•T** until the search begins in the display.

Recall "T":

Press **FM•T** until T appears in the display. Then press the station button quickly and repeatedly if necessary.

⑩ TONE

Adjust tone.

↻ more bass

↻ more treble

Important information

Traffic safety

As the driver of a motor vehicle, it is your responsibility to pay attention to the traffic situation at all times. Never use your car radio in a way that could distract you. Should the traffic situation become particularly demanding, we would advise you not to use the radio. Please keep in mind that you travel a distance of 14 m per second at a speed of only 50 km/h. When adjusting the volume, make sure that you are still able to hear sounds coming from outside of the vehicle, so that you are always able to react to warning signals.

Installation / Hook-up

If you would like to install your new car radio yourself or add other audio components to the existing ones, then please read the enclosed instructions on installation and hook-up carefully.

Do not ground the loudspeaker outputs! Use only Blaupunkt-certified accessories and spare parts.

Radio operation

Select the frequency range

You can choose between the frequency ranges:

FM 87.5 – 108 MHz,
AM 531 – 1602 kHz and
LW 153 – 279 kHz.

- Switch on the desired frequency range by pressing either the button **FM•T** or **M•L**.

Switching between AM and LW:

- Press **M•L**.

Station search

m should not be lit up in the display. If it is, switch it off by pressing **lo • m**

- **< >** press right or left.
The car radio will automatically tune into the next station.

If you hold the button pressed, the search function will forward quickly.

Manual station search

m (manual) must be lit up in the display. If it is not, switch it on by pressing **lo•m**.

- **< >** press right or left quickly.
The frequency will move up or down in short intervals.

If you hold the button pressed, then the frequencies will move up or down more quickly.

Adjusting station search sensitivity (only FM)

You can adjust the sensitivity (FM) of the automatic station search.

- Press **lo•m**.
When “lo” is visible in the display, then only those stations with relatively strong signals will be picked up (low sensitivity).
When “lo” is not visible in the display, then stations with weaker signals will also be picked up (high sensitivity).

Stereo - mono switch

If you would like to switch between stereo and mono reception:

- Press **lo•m** for approximately 2 seconds.
During stereo reception the stereo symbol  will light up in the display.
Each time the car radio is switched on, the reception will automatically be set to stereo. The radio will automatically switch to mono when the reception conditions are poor.

Cassette tape operation

Storing stations

For each memory bank (I, II, III, T) you can store up to five stations using the button **1-5**.

- For FM select the memory bank by pressing **FM•T**.

You can store 5 stations each for AM and LW frequencies.

- Select the button **1-5** to store the new station and press it.
- Press **< >** to tune in the station you want to store (automatically or manually).
- Press the button **1-5** and hold it. First the station will be muted and then become audible again.

The station has been stored in the memory bank.

The corresponding memory bank and the button preset will appear in the display.

Note:

If you tune into a station which has already been stored, then the corresponding button preset and the memory bank will flash in the display for approximately 5 seconds.

Storing the strongest stations automatically

(Travelstore)

In your reception area you can automatically store the five nearest FM stations, sorted according to their frequencies.

This feature is particularly useful when you are travelling.

- Press **FM•T** for at least 2 seconds. The radio will search for the nearest FM stations and store them in the memory bank "T" (Travelstore). When the process has been completed, the first station will be set.

If you wish, you can also store stations in the Travelstore memory bank manually.

Recalling stored stations

You can recall the stored stations by pressing the corresponding buttons.

- Select the memory bank. Press **FM•T** until I, II, III or T appears in the display.
- Select the station by pressing the button **1-5**, press repeatedly if necessary.

Insert cassette tape

- Switch the car radio on.
- Insert a cassette tape with the empty reel facing forward and the open side facing to the left.

Tape playback will begin.

When the tape has run to the end, the car radio will switch on automatically.

Remove cassette tape

- Press **FF / Eject** firmly. The cassette will be ejected.

Fast forward

To begin and end fast forwarding,

- Press **FF / Eject** gently.

Appendix

Care of your audio equipment

We recommend that you use only C60/C90 cassette tapes in your car radio. Protect your cassettes from dirt, dust and temperatures exceeding 50 °C. During cold weather, allow cold cassettes to warm up somewhat before playing them in order to avoid uneven tape transport. Operating problems and sound distortions may occur after approximately 100 hours of playing time and are caused by dust particles which adhere to the rubber roller pad and the tape head. Use a cleaner cassette to remove normal dirt build-up. If more dirt than usual has accumulated, use a cotton bud dipped in rubbing alcohol to clean these parts. Never use any hard tools.

Technical data

Amplifier:

Output power: 2 x 5.5 W RMS power according to DIN 45324/3.1 at 4 Ω

FM:

Sensitivity: 1.3 μ V at 26 dB
S/N ratio

Response: 35 - 15 000 Hz (-3 dB)

Cassette:

Response: 40 - 14 000 Hz (-3 dB)

Information subject to change!

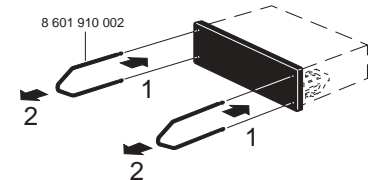
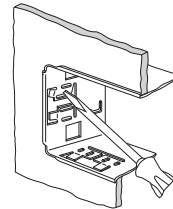
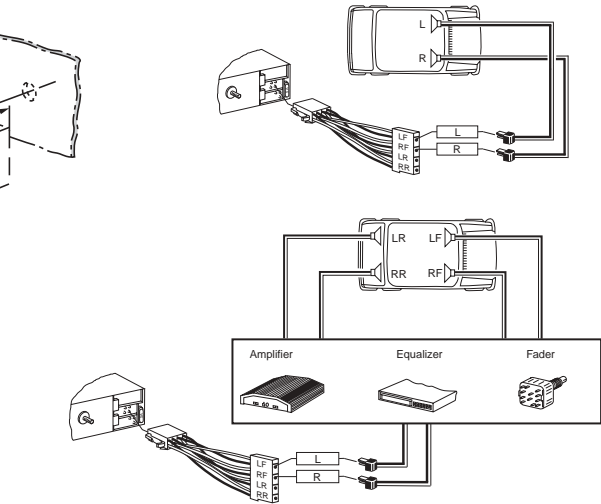
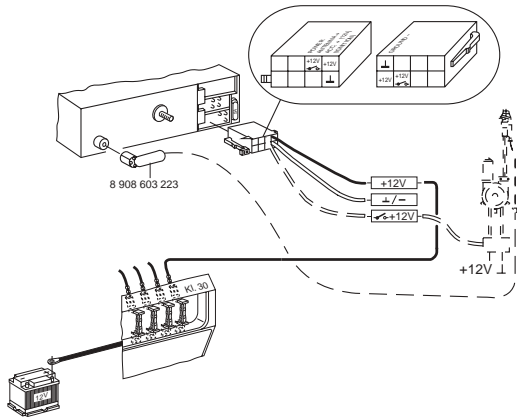
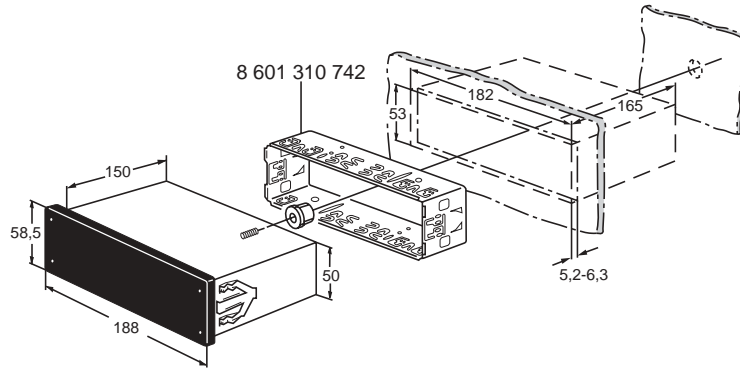

Blaupunkt-Werke GmbH
Bosch Gruppe

K7/VKD 8 622 401 406



Free Manuals Download Website

<http://myh66.com>

<http://usermanuals.us>

<http://www.somanuals.com>

<http://www.4manuals.cc>

<http://www.manual-lib.com>

<http://www.404manual.com>

<http://www.luxmanual.com>

<http://aubethermostatmanual.com>

Golf course search by state

<http://golfingnear.com>

Email search by domain

<http://emailbydomain.com>

Auto manuals search

<http://auto.somanuals.com>

TV manuals search

<http://tv.somanuals.com>