

# ***54M Wireless LAN CardBus Card***

**User's Manual**

**Ver.2.0**

### Federal Communication Commission Interference Statement

This equipment has been tested and found to comply with the limits for a Class B digital device, pursuant to Part 15 of the FCC Rules. These limits are designed to provide reasonable protection against harmful interference in a residential installation. This equipment generates, uses and can radiate radio frequency energy and, if not installed and used in accordance with the instructions, may cause harmful interference to radio communications. However, there is no guarantee that interference will not occur in a particular installation. If this equipment does cause harmful interference to radio or television reception, which can be determined by turning the equipment off and on, the user is encouraged to try to correct the interference by one of the following measures:

- Reorient or relocate the receiving antenna.
- Increase the separation between the equipment and receiver.
- Connect the equipment into an outlet on a circuit different from that to which the receiver is connected.
- Consult the dealer or an experienced radio/TV technician for help.

FCC Caution: Any changes or modifications not expressly approved by the party responsible for compliance could void the user's authority to operate this equipment.

This device complies with Part 15 of the FCC Rules. Operation is subject to the following two conditions: (1) This device may not cause harmful interference, and (2) this device must accept any interference received, including interference that may cause undesired operation.

**IMPORTANT NOTE:**  
**FCC Radiation Exposure Statement:**

This equipment complies with FCC radiation exposure limits set forth for an uncontrolled environment.

This transmitter must not be co-located or operating in conjunction with any other antenna or transmitter.

### About this manual

This User's Manual describes how to install and operate your CardBus Wireless LAN Card. Please read this manual before you install the product.

This manual includes the following topics:

- Product description and features.
- Hardware installation procedure.
- Software installation procedure.
- FAQ

## ***Table of Contents***

<i>About this manual</i> .....	3
<b><i>Chapter 1 - Introduction</i></b> .....	<b>5</b>
Features .....	5
What is Wireless LAN? .....	6
Wireless LAN Modes .....	6
Notes on Wireless LAN Configuration .....	7
<b><i>Chapter 2 - Hardware Installation</i></b> .....	<b>8</b>
Package Contents .....	8
System Requirements for the Adapter .....	8
Hardware description .....	8
Inserting the Wireless LAN Card .....	9
LED Indicators .....	9
Ejecting the Wireless LAN card .....	10
<b><i>Chapter 3 – Driver Installation for Windows</i></b> .....	<b>11</b>
Driver installation for Windows 98 .....	11
Driver installation for Windows 2000 .....	14
Driver installation for Windows ME .....	17
Driver installation for Windows XP .....	19
<b><i>Chapter 4 – Installing and Using the Wireless Utility</i></b> .....	<b>21</b>
Installation in Windows .....	21
Using Wireless Utility In Windows XP .....	24
Use Windows Wireless Network Configuration .....	24
Use Wireless LAN Utility .....	27
Use Wireless LAN Utility In Windows 98, 2000 and ME .....	30
Configuring the CardBus Wireless LAN Card .....	30
<b><i>Chapter 5 – Installing Network Protocols</i></b> .....	<b>36</b>
Installing the Network Protocols for Windows 98 and Millennium .....	36
<b><i>Appendix A – FAQ</i></b> .....	<b>39</b>
<b><i>Appendix B – Specifications</i></b> .....	<b>40</b>

## ***Chapter 1 - Introduction***

Thank you for purchasing the CardBus Wireless LAN Card. This high-speed CardBus Wireless LAN Card provides you with an innovative wireless networking solution. The Adapter is easy to set up and use. With this innovative wireless technology, you can share files and printers on the network—without inconvenient wires!

The Adapter is a network Adapter with a rate of 1, 2, 5.5, 6, 9, 11, 12, 24, 36, 48 and 54 Mbps operating in the ISM band using Direct Sequence Spread Spectrum (DSSS) transmission implementing the IEEE 802.11g draft standard. This Adapter provides Device Drivers for Windows Operating Systems. It also provides tools for the configuration of the Adapter. The tool, as well as the installation steps of the plug-and-play procedure for the Windows operating systems, is described in this document.

### **Features**

The CardBus Wireless LAN Card offers compliance with the IEEE 802.11g specification. This feature allows them to communicate with other wireless devices that support the standard. Features of the Adapter are:

- **Uses 2.4GHz frequency band, which complies with worldwide requirement**
- **Wireless interface following the IEEE 802.11g standard**
- **Using CardBus interface**
- **Enciphering/deciphering of wireless data by the implementation of the WEP algorithm**
- **Wire-free access to networked resources from anywhere beyond the notebook**
- **Allows users move between Access Points without resetting their connection reconfiguration**
- **Delivers data rate up to 54 Mbps**
- **Supports 1, 2, 5.5, 6, 9, 11, 12, 24, 36, 48 and 54 Mbps rates**
- **Provide CardBus Wireless LAN Card Configuration utility**
- **The Adapter uses built-in Chip Antenna with LEDs indicating Power and Link**
- **Supports most popular operating systems**

## What is Wireless LAN?

Wireless Local Area Network (WLAN) systems offer a great number of advantages over traditional wired systems. WLAN is flexible and easy to setup and manage. They are also more economical than wired LAN systems.

Using radio frequency (RF) technology, WLAN transmit and receive data through the air. WLAN combine data connectivity with user mobility. For example, users can roam from a conference room to their office without being disconnected from the LAN.

Using WLAN, users can conveniently access-shared information, and network administrators can configure and augment networks without installing or moving network cables.

WLAN technology provides users with many convenient and cost saving features:

- **Mobility:** WLAN provide LAN users with access to real-time information anywhere in their organization, providing service opportunities that are impossible with wired networks.
- **Ease of Installation:** Installing is easy for novice and expert users alike, eliminating the need to install network cables in walls and ceilings.
- **Scalability:** WLAN can be configured in a variety of topologies to adapt to specific applications and installations. Configurations are easily changed and range from peer-to-peer networks suitable for a small number of users to full infrastructure networks of thousands of users roaming over a broad area.

## Wireless LAN Modes

Wireless LANs can be configured in one of two ways:

<b>Ad-hoc Networking</b>	Also known as a peer-to-peer network, an ad-hoc network is one that allows all workstations and computers in the network to act as servers to all other users on the network. Users on the network can share files, print to a shared printer, and access the Internet with a shared modem. However, with ad-hoc networking, users can only communicate with other wireless LAN computers that are in the wireless LAN workgroup, and are within range.
<b>Infrastructure Networking</b>	Infrastructure networking differs from ad-hoc networking in that it includes an access point. Unlike the ad-hoc structure where users on the LAN contend the shared bandwidth, on an infrastructure network the access point can manage the bandwidth to maximize bandwidth utilization. Additionally, the access point enables users on a

	<p>wireless LAN to access an existing wired network, allowing wireless users to take advantage of the wired networks resources, such as Internet, email, file transfer, and printer sharing.</p> <p>Infrastructure networking has the following advantages over ad-hoc networking:</p> <ul style="list-style-type: none"><li>• <b>Extended range:</b> each wireless LAN computer within the range of the access point can communicate with other wireless LAN computers within range of the access point.</li><li>• <b>Roaming:</b> the access point enables a wireless LAN computer to move through a building and still be connected to the LAN.</li><li>• <b>Wired to wireless LAN connectivity:</b> the access point bridges the gap between wireless LANs and their wired counterparts.</li></ul>
--	--

### Notes on Wireless LAN Configuration

When configuring a wireless LAN (WLAN), be sure to note the following points:

- Optimize the performance of the WLAN by ensuring that the distance between access points is not too far. In most buildings, WLAN Adapters operate within a range of 100 ~ 300 feet, depending on the thickness and structure of the walls.
- Radio waves can pass through walls and glass but not metal. If there is interference in transmitting through a wall, it may be that the wall has reinforcing metal in its structure. Install another access point to circumvent this problem.
- Floors usually have metal girders and metal reinforcing struts that interfere with WLAN transmission.

This concludes the first chapter. The next chapter deals with the hardware installation of the Adapter.

## Chapter 2 - Hardware Installation

This chapter covers connecting your CardBus Wireless LAN Card to CardBus slot of notebook.

### Package Contents

Please make sure that items below are included on package.

- ✓ One CardBus Wireless LAN Card
- ✓ One CD containing drivers and documentation
- ✓ One Quick Installation Guide

### System Requirements for the Adapter

- Operating System: Microsoft Windows 98/ME/2000/XP
- Notebook with CD-ROM drive
- One free CardBus slot
- Pentium-Class 90MHz or higher

### Hardware description

The Wireless LAN Card is encased in a stainless compact frame and has a 68-pin connector for attaching to the CardBus port of notebook.

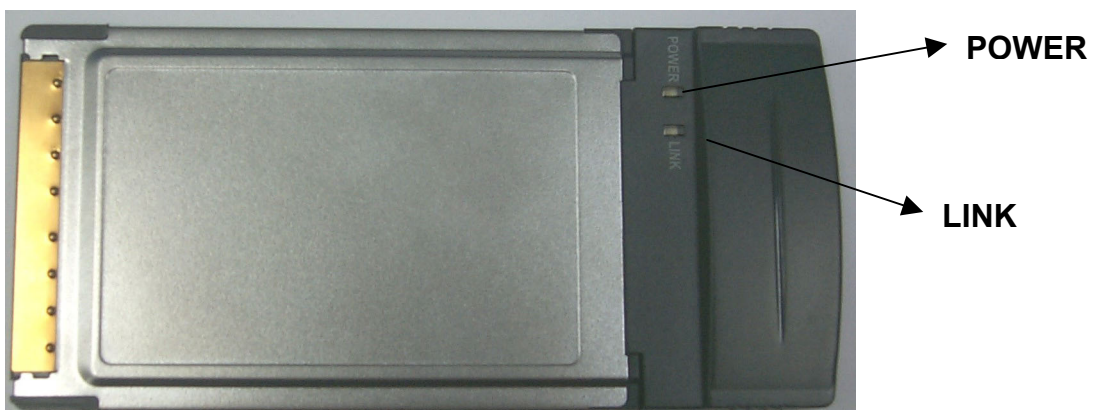



## Inserting the Wireless LAN Card

<b>Note!</b>	These instructions apply to most notebook computers. For detailed information on inserting PC cards into your notebook, consult the notebook manual.
--------------	--

Follow the procedure below to install the Wireless LAN card.

1. With 68-pin connector of the card facing the CardBus slots on notebook, slide the card all the way into an empty slot.



2. Connect to a network.

## LED Indicators

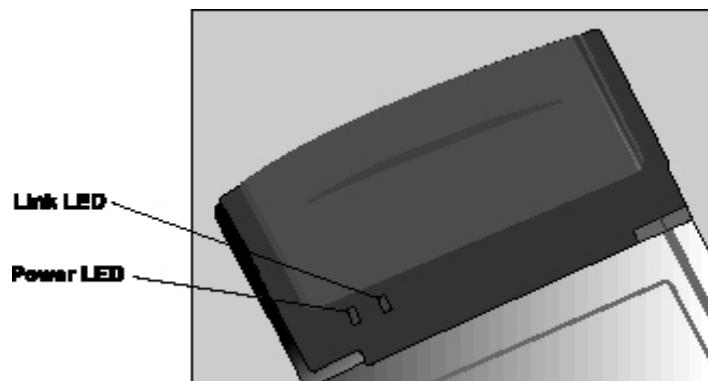

The following table describes the meaning of LED indicators:

LED	MEANING
POWER	Indicates that the Adapter is powered on (solid green).
LINK	Indicates link status. It is normally blinking. When blinking, indicates that the card is scanning the channels, and the link is not active. When lit, indicates that the card is locked to a channel, and the link is active.

## Ejecting the Wireless LAN card

After disconnecting from the LAN, you can eject the Wireless LAN card from the PC Card slot of notebook.

---

<b>Note!</b>	In Windows XP/2000/ME/98 operating systems, you do not have to power down the notebook to remove the card. The card is hot swappable — you can remove the card when the notebook is powered on. However, Microsoft recommends that you stop the card. Refer to your Windows 2000/ME/98 online help for information on stopping the Wireless LAN card.
--------------	---

---

Most notebooks have an eject lever or button for ejecting PC cards from the PC slots. Consult your notebook manual for details.

---

<b>Warning!</b>	<b><i>To prevent data loss, do not eject the Wireless LAN card when a data transmission is taking place. Exit your communications program normally, stop the card if necessary, and then remove the card.</i></b>
-----------------	---

---

After hardware installation is completed, please go to Chapter 3 to install driver on different Operating System.

## Chapter 3 – Driver Installation for Windows

The following sections cover CardBus Wireless LAN Card driver installation in the Windows Operating Systems.

Note!

***You have to install your hardware first before you begin to install the drivers.***

### Driver installation for Windows 98

Follow the steps below to install the CardBus Wireless LAN Card drivers for Windows 98.

1. Insert the CardBus Wireless LAN Card to CardBus slot of notebook first. (Refer to Chapter 2 – Hardware installation.)
2. After Windows 98 detects the CardBus Wireless LAN Card, the *Add New Hardware Wizard* window appears. Clicks **Next** to continue the installation.



3. A screen appears prompting you to select an installation method. Select **Search for the best driver for your device. (Recommended)** and click **Next** to continue.



4. Ensure that the **CD-ROM drive** is selected. Inserts the driver CD-ROM into your CD-ROM drive and clicks **Next** to continue.



5. The following screen appears showing the driver search result. Click **Next** to continue the installation.



6. Windows 98 copies files to your hard disk. The following screen will appear to inform you when the software installation has finished. Click **Finish** to finish the installation.



- The following screen will ask you to restart your computer to finish the installation. Click **Yes** to reboot the system. After system reboot, the Wireless LAN Utility will be installed automatically. Please go to Chapter 4 to install the utility.

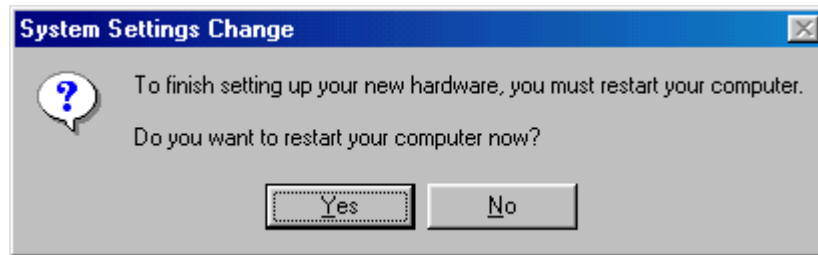

---

**Note!**

In most cases, Windows will automatically copy all of the files needed for networking. If Windows asks you for the files and prompts you to input the path to the files. Follow the instructions on your screen, and then click **OK** to continue.

---

## Driver installation for Windows 2000

Follow the steps below to install the CardBus Wireless LAN Card drivers for Windows 2000.

- Insert the CardBus Wireless LAN Card to CardBus slot of notebook first. (Refer to Chapter 2 – Hardware installation.)
- After Windows 2000 detects the CardBus Wireless LAN Card, the *Found New Hardware Wizard* window appears. Click **Next** to start the installation.



3. A screen appears prompting you to select an installation method. Select **Search for a suitable driver for my device (recommended)** and click **Next** to continue.

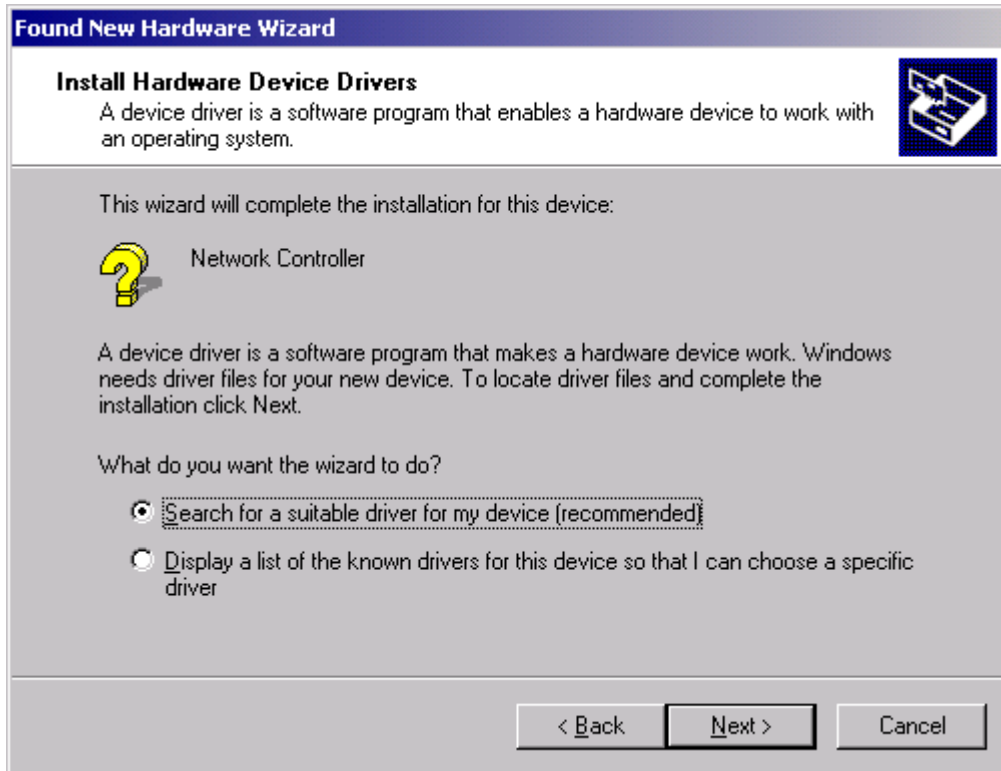

4. Ensure that the **CD-ROM driver** is selected and insert the driver CD-ROM into your CD-ROM drive and click **Next** to continue.

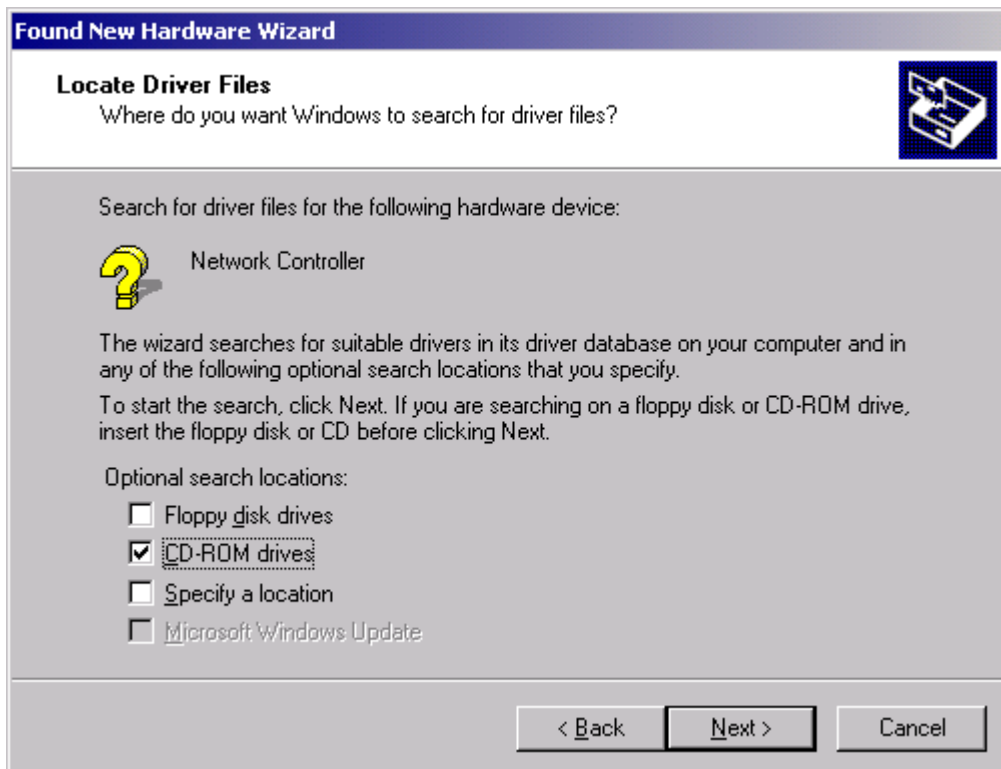

5. The following screen appears showing the driver search result. Click **Next** to continue the installation.

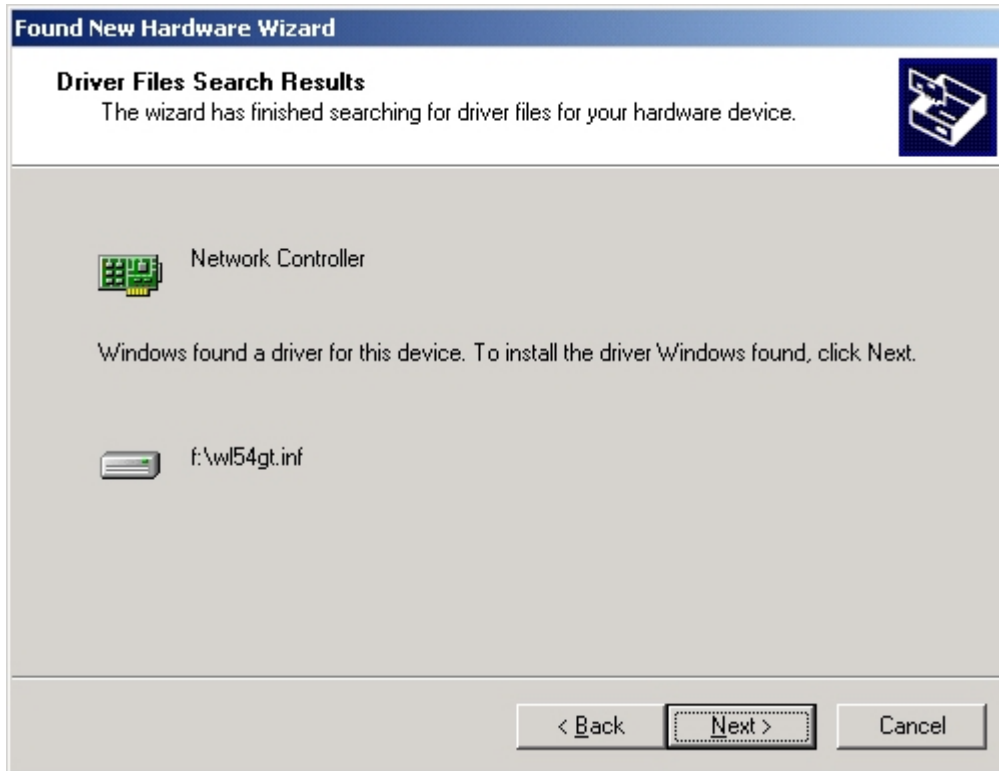

6. The following screen appears. Click **Yes** to continue

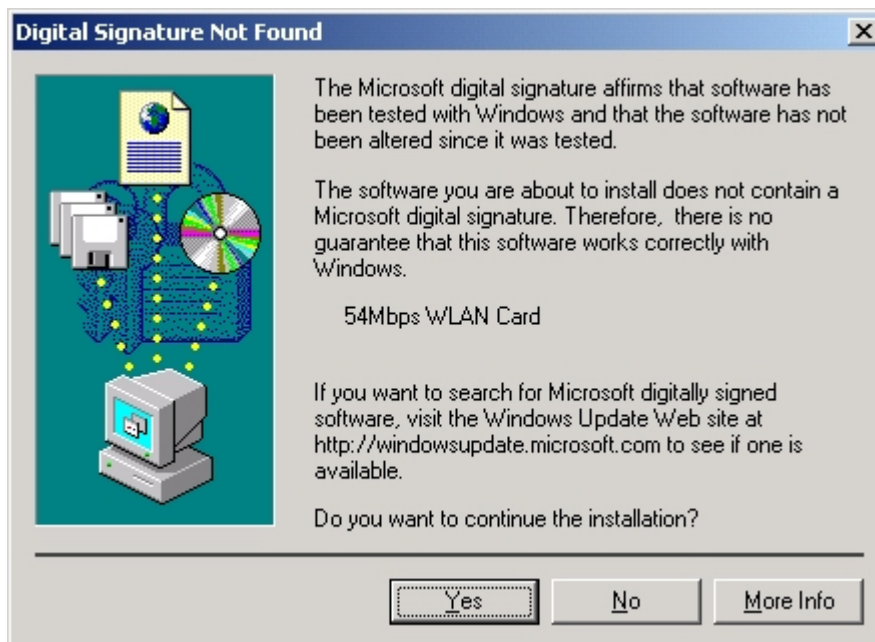



7. The Windows has finished installing software for the device. Click **Finish** to finish the installation.

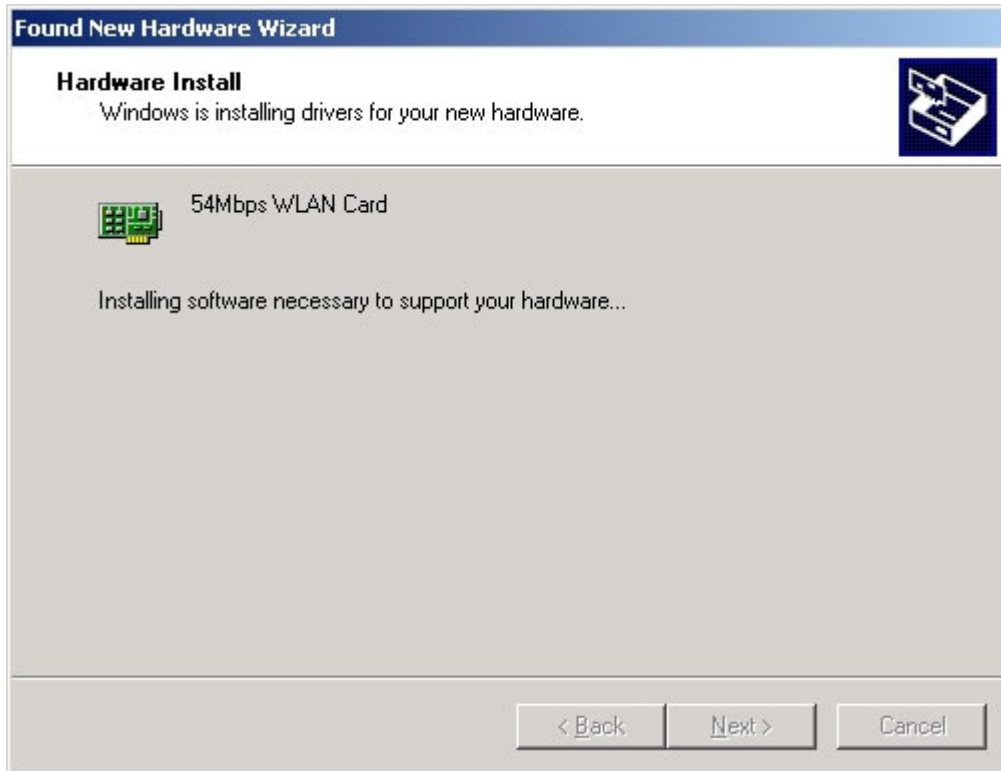

Then system will start to install Wireless LAN Utility. Please refer to procedures at Chapter 4.

## Driver installation for Windows ME

Follow the steps below to install the CardBus Wireless LAN Card drivers for Windows ME.

1. Insert the CardBus Wireless LAN Card to CardBus slot of notebook first. (Refer to Chapter 2 – Hardware installation.)
2. After Windows ME detects the CardBus Wireless LAN Card, the *Add New Hardware Wizard* window appears. Select **Automatic search for a better driver (Recommended)** and insert the driver CD-ROM into CD-ROM drive and click **Next** to continue.

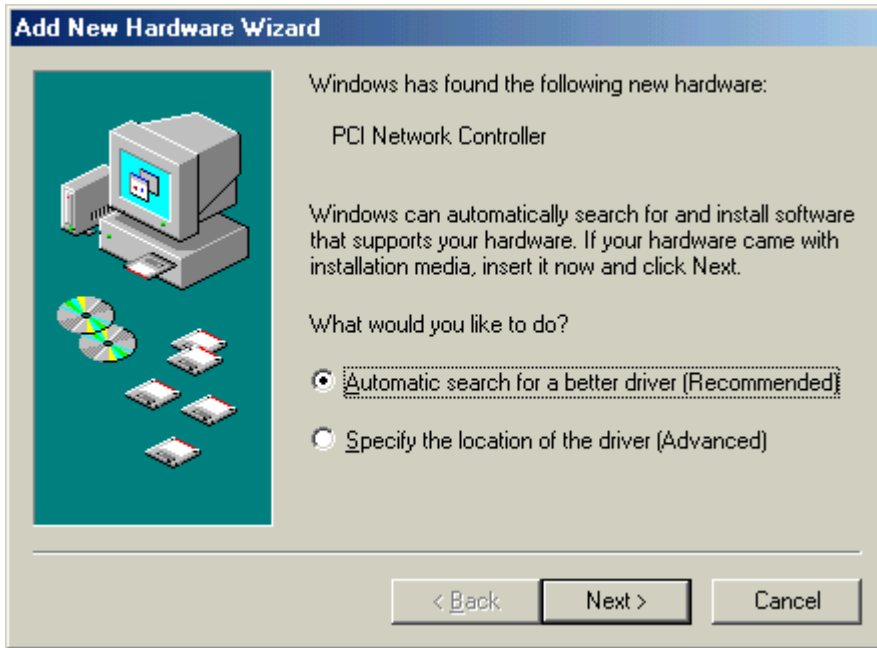

3. The system will find the setup files and follow the instruction to copy files to your hard disk. The following screen will appear when the software installation has finished. Click **Finish** to finish the installation.



4. The following screen will ask you to restart your computer to finish the hardware setting up. Click **Yes** to reboot the system. After system reboot, the Wireless LAN Utility will be installed automatically. Please go to Chapter 4 to install the utility.

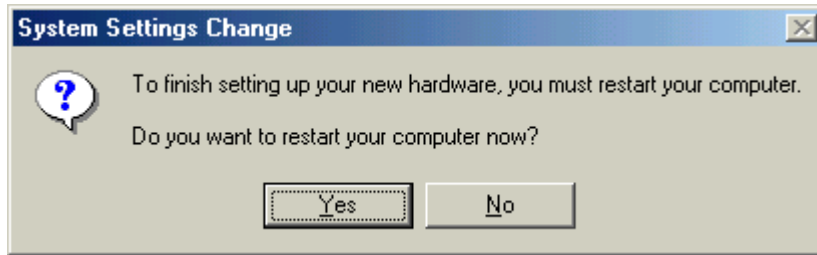

**Note!**

In most cases, Windows will automatically copy all of the files needed for networking. If Windows asks you for the files and prompts you to input the path to the files. Follow the instructions on your screen, and then click **OK** to continue.

## Driver installation for Windows XP

Follow the steps below to install the CardBus Wireless LAN Card drivers for Windows XP.

1. Insert the CardBus Wireless LAN Card to CardBus slot of notebook first. (Refer to Chapter 2 – Hardware installation.)
2. After Windows XP detects the CardBus Wireless LAN Card, the *Found New Hardware Wizard* window appears. Select **Install the software automatically [Recommended]** and insert the driver CD-ROM into CD-ROM drive and click **Next** to continue.

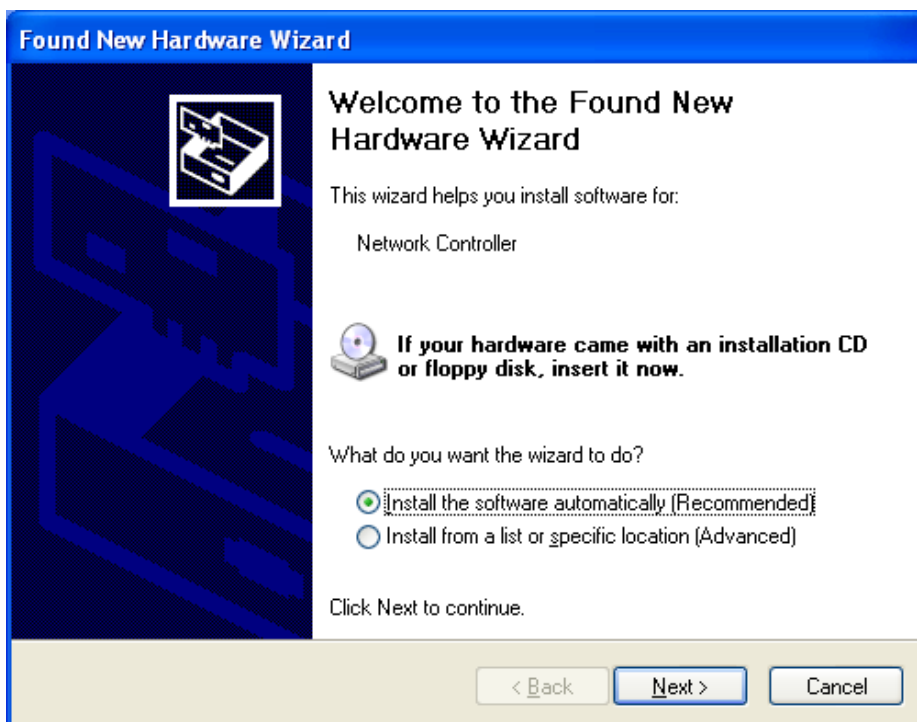

3. Click **Continue Anyway** to continue the installation.



4. The Windows has finished installing software for the device. Click **Finish** to finish the installation



Then system will start to install Wireless utility automatically. Please refer to procedures at Chapter 4.

## Chapter 4 – Installing and Using the

### Wireless Utility

The following sections cover the CardBus Wireless LAN Card utility installation and configuration.

#### Installation in Windows

After you have installed driver, system will start to install Wireless LAN Utility. Please follow the steps below to install the utility.

1. Once you see the following screen, click **Next** to continue.

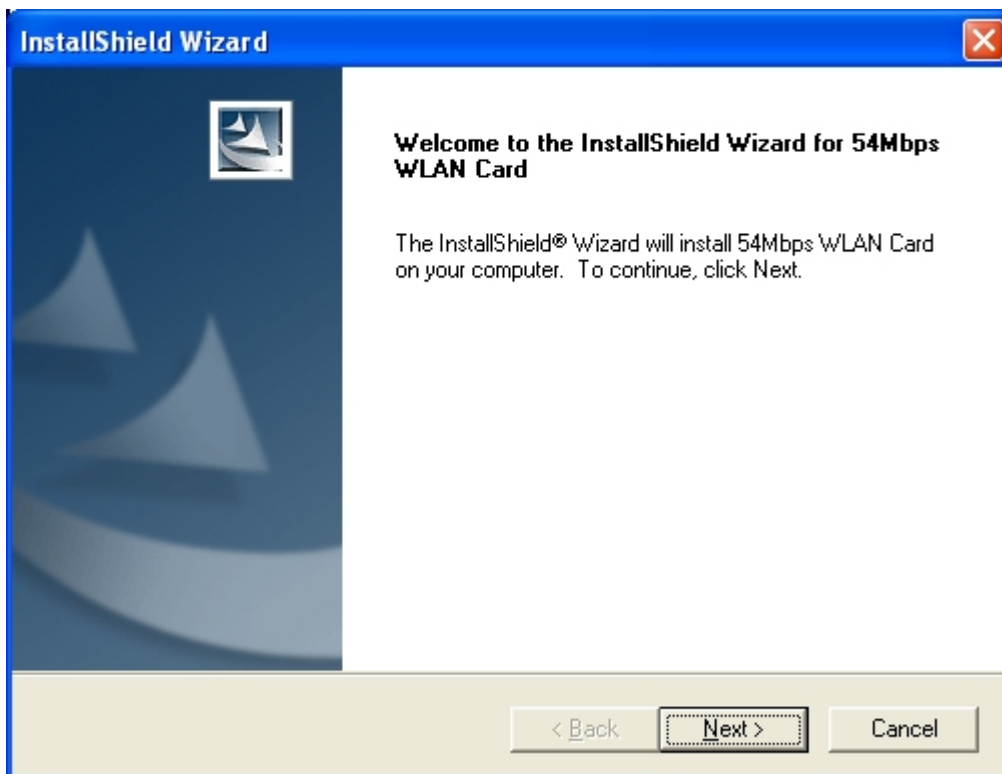

- The screen will show you the default destination chosen by the utility. Click **Next** to continue or click the **Browse** button to select an alternate destination.

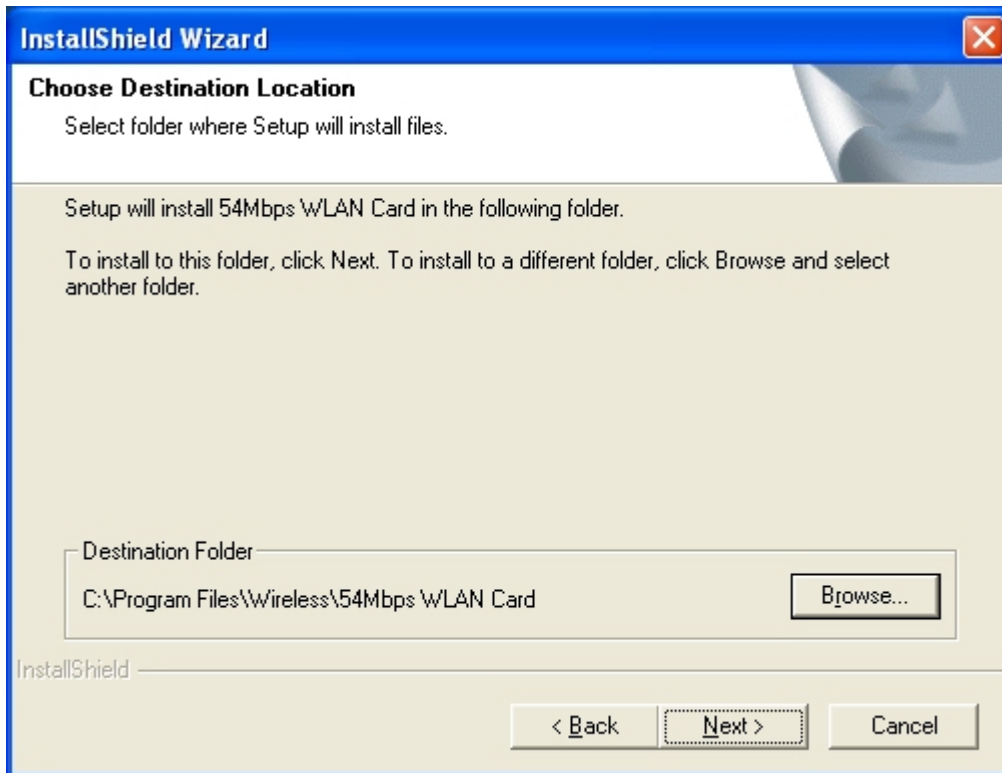

- The following screen will add program icons to the Program Folder. You may type a new folder name or select one from the existing folders list. Click **Next** to continue or click **Back** to review or change any settings.

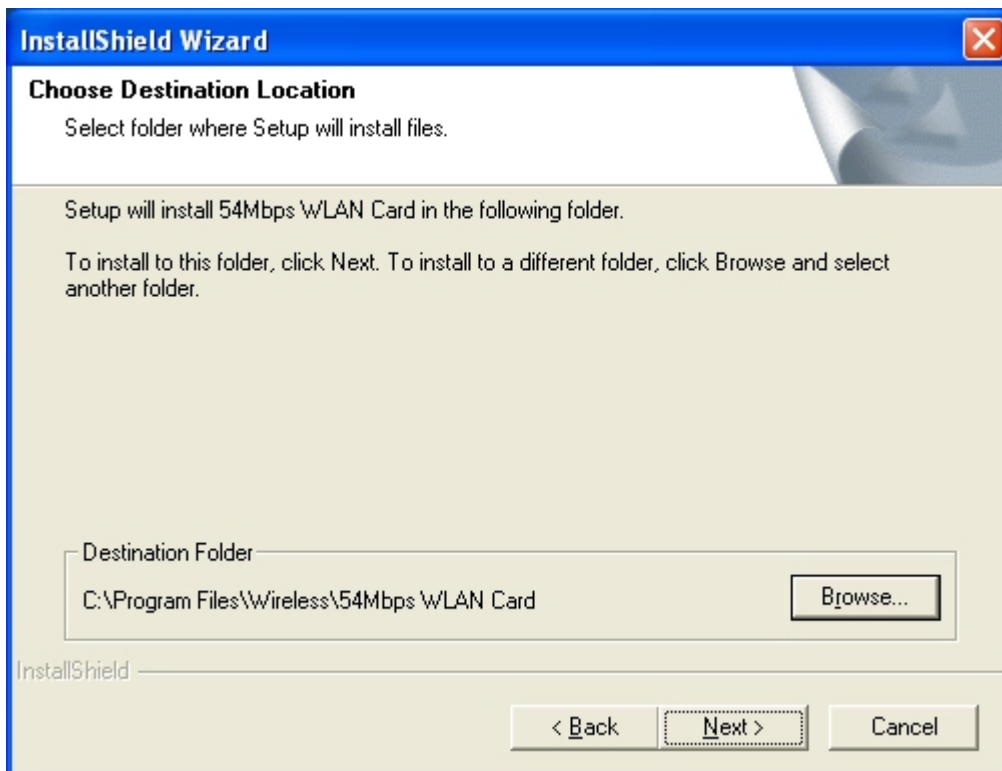

4. The following screen shows the current settings, click **Next** to continue or click **Back** to change the **Destination Folder** in step 3.

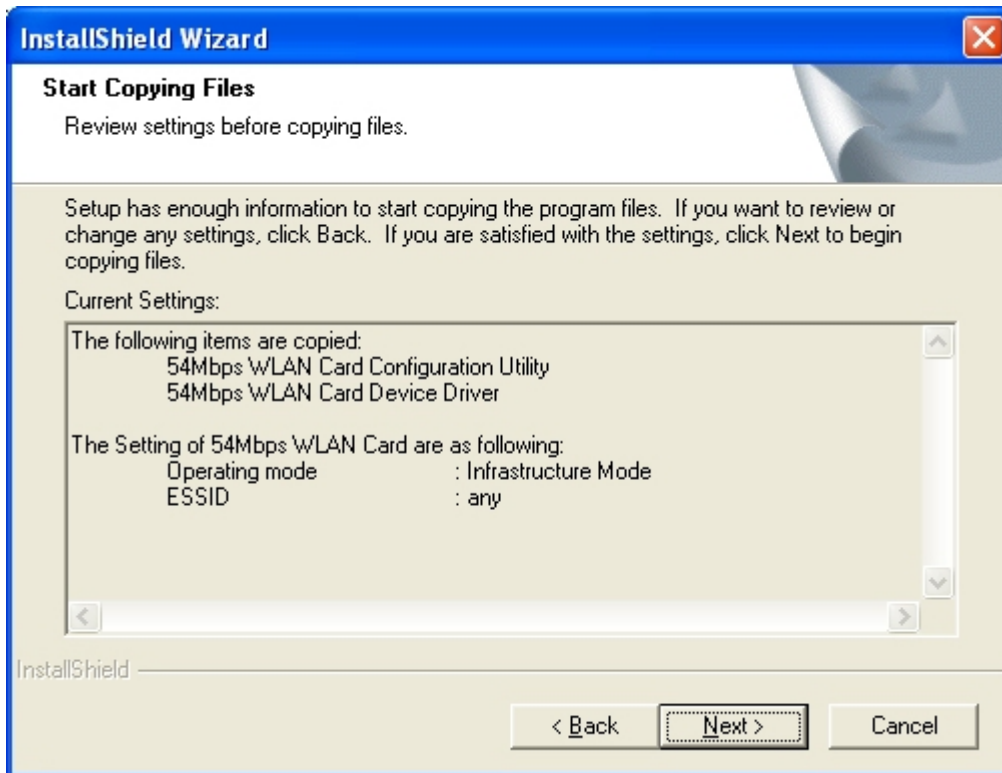

5. The Windows has finished installing Wireless LAN Utility. The following screen will ask you to restart your computer to finish the installation. Click **Finish** to reboot the system.

After you have installed the utility, you will see the Wireless LAN Utility icon in the Windows taskbar:

## Using Wireless Utility In Windows XP



Wireless LAN Utility

There are two ways to configure CardBus Wireless LAN Card. One is Wireless LAN Utility; the other one is Windows Wireless Network Configuration.

## Use Windows Wireless Network Configuration

1. Click the right key of the mouse and Exit Wireless LAN Utility.

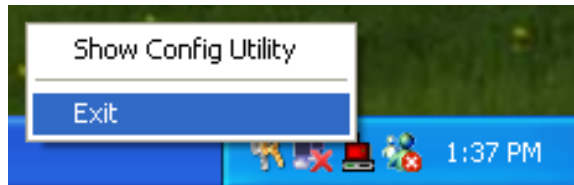

2. Click Windows Wireless Network Configuration icon.



Windows Wireless Network Configuration

3. Click Advanced... button.

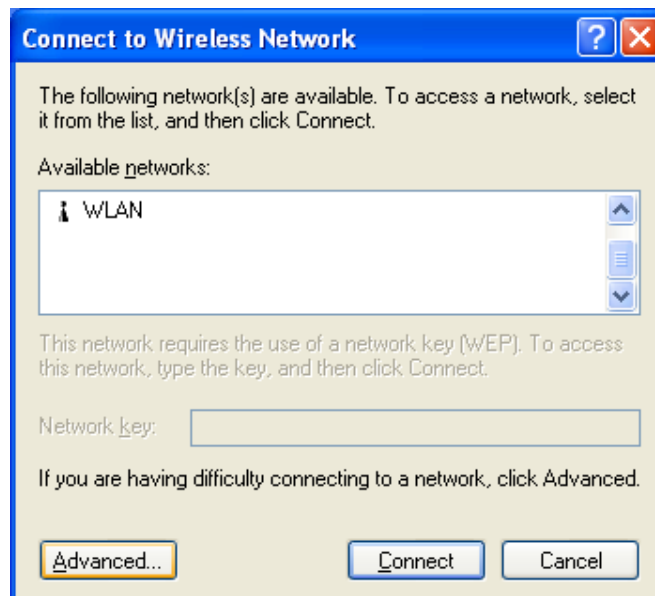



4. Make sure “Use Windows to configure my wireless network settings” is checked and click OK.

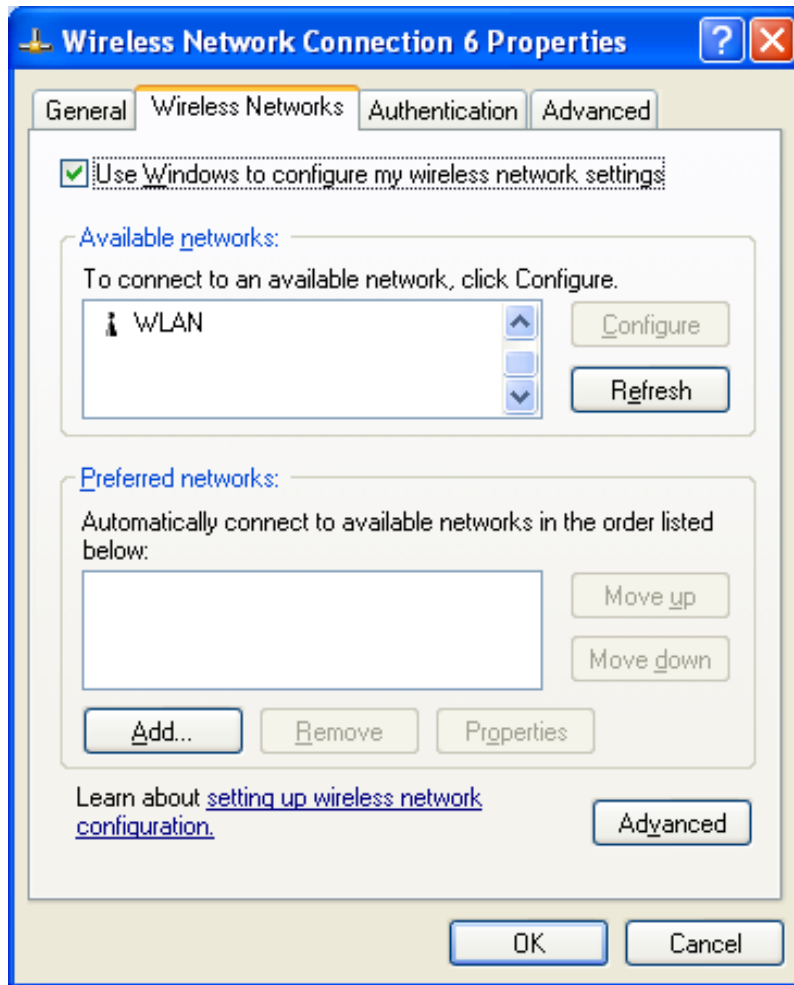

5. Click the Windows Wireless Network Configuration icon again to open the Windows Wireless Network Configuration.



Windows Wireless Network Configuration

6. Select an available network and click Connect button.

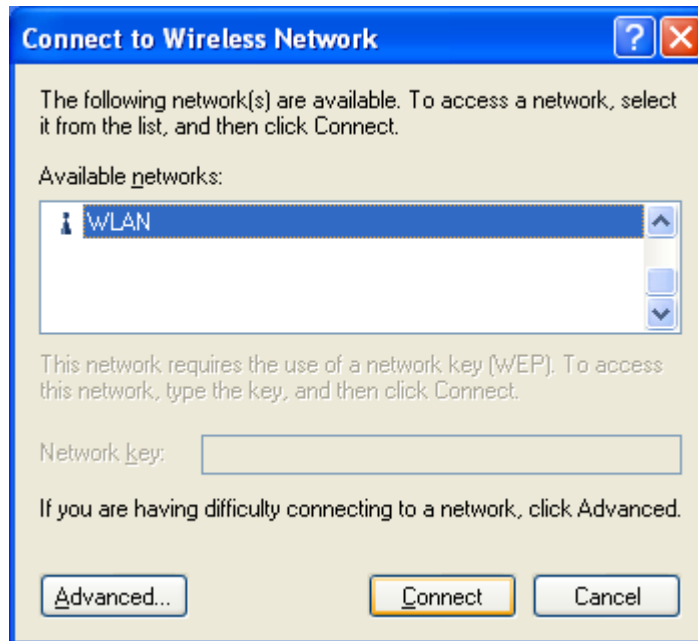

7. The Windows Wireless Network Configuration will be enabled. Click the Windows Wireless Configure icon.



Windows Wireless Network Configuration is enabled

8. Click Properties to start Windows Wireless Network Configuration.

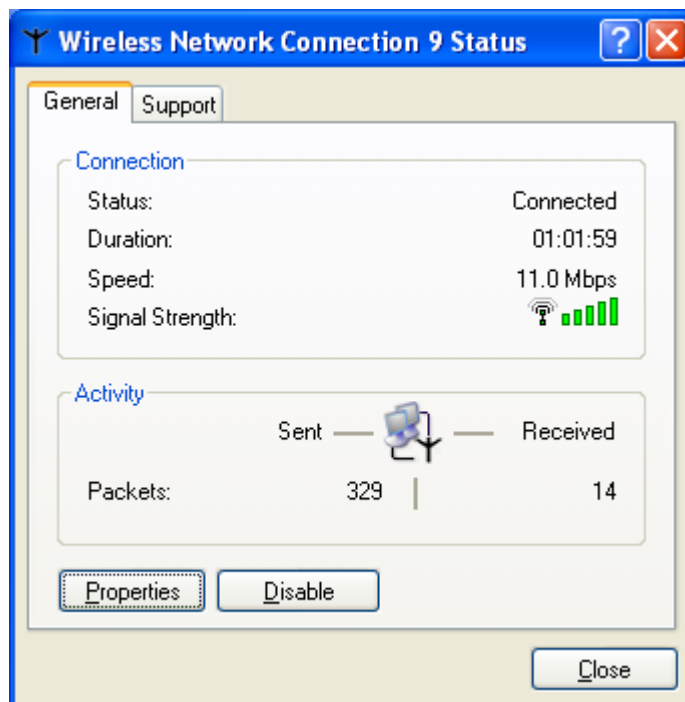

## Use Wireless LAN Utility

1. Exit the Wireless LAN Utility.

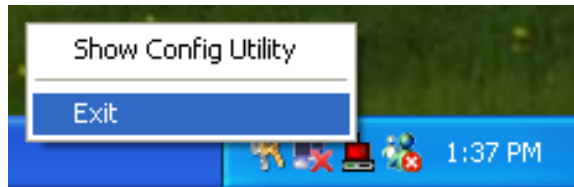

2. Click Windows Wireless Network Configuration icon.



Windows Wireless Network Configuration

3. Click Advanced... button.

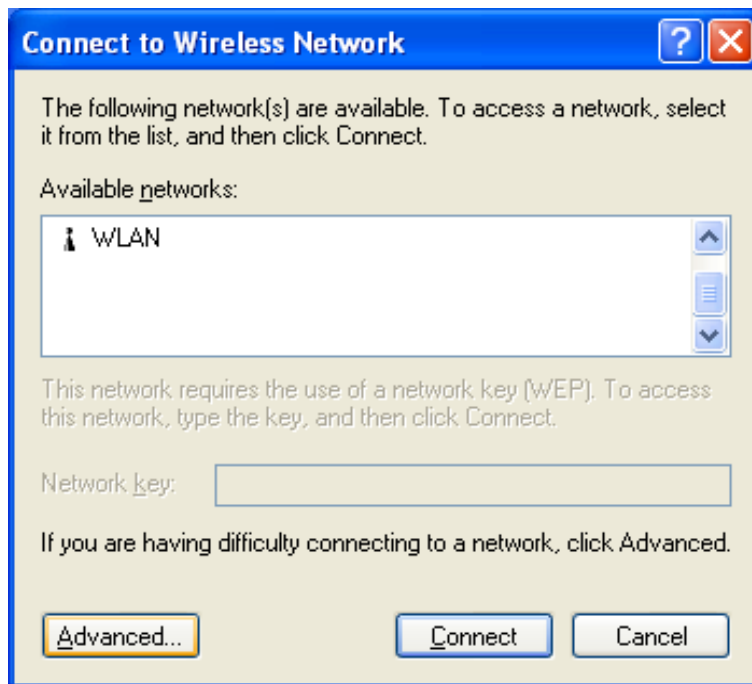

4. Make sure "Use Windows to configure my wireless network settings" is unchecked and click OK button.

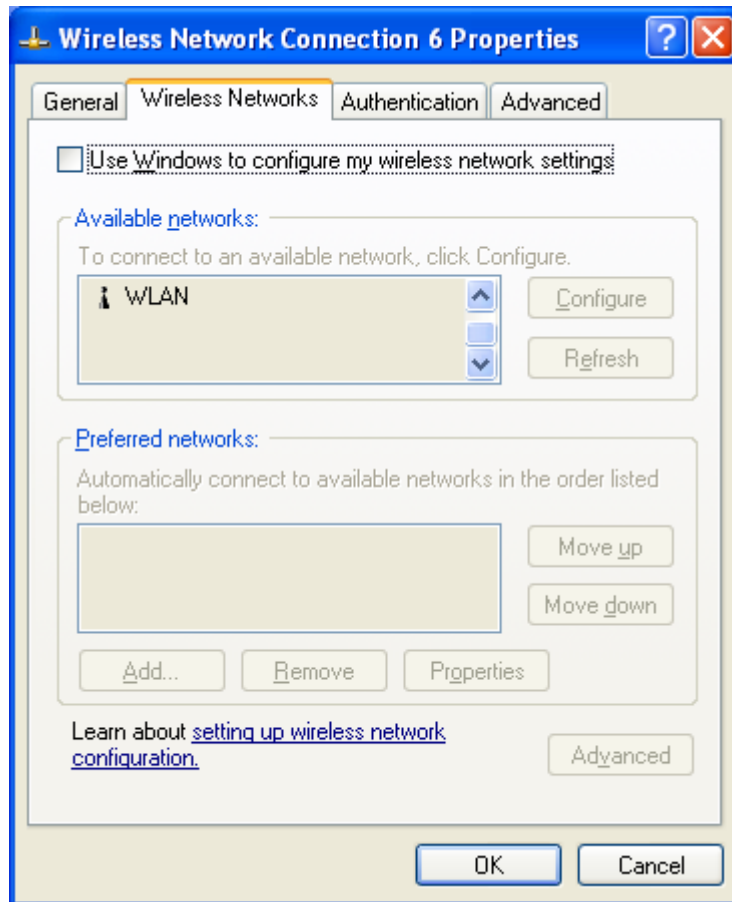

5. Click Start -> All Programs -> IEEE802.11g WLAN CardBus Card then click IEEE802.11g WLAN CardBus Card Utility to restart IEEE802.11g WLAN Card.

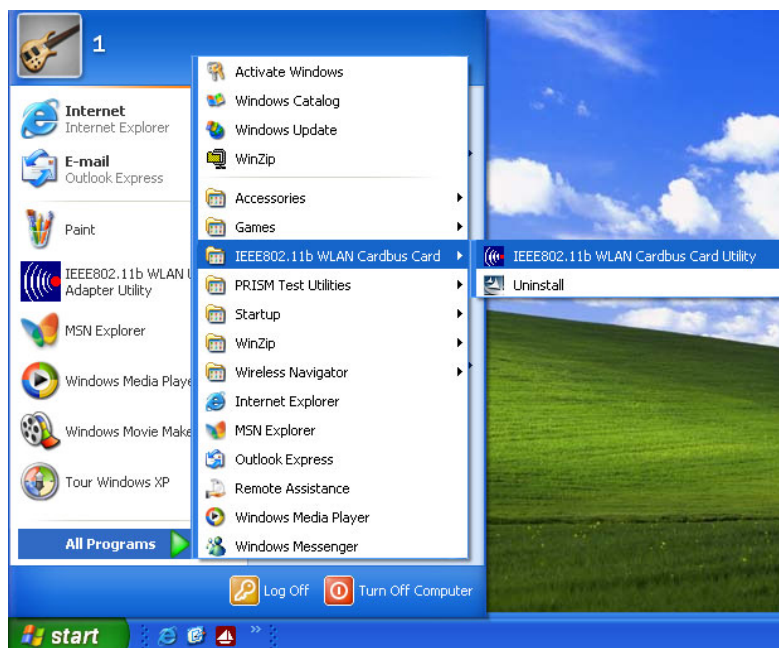

6. The Wireless LAN Utility will appear, Double-click the icon to open the configuration utility.



Wireless LAN Utility

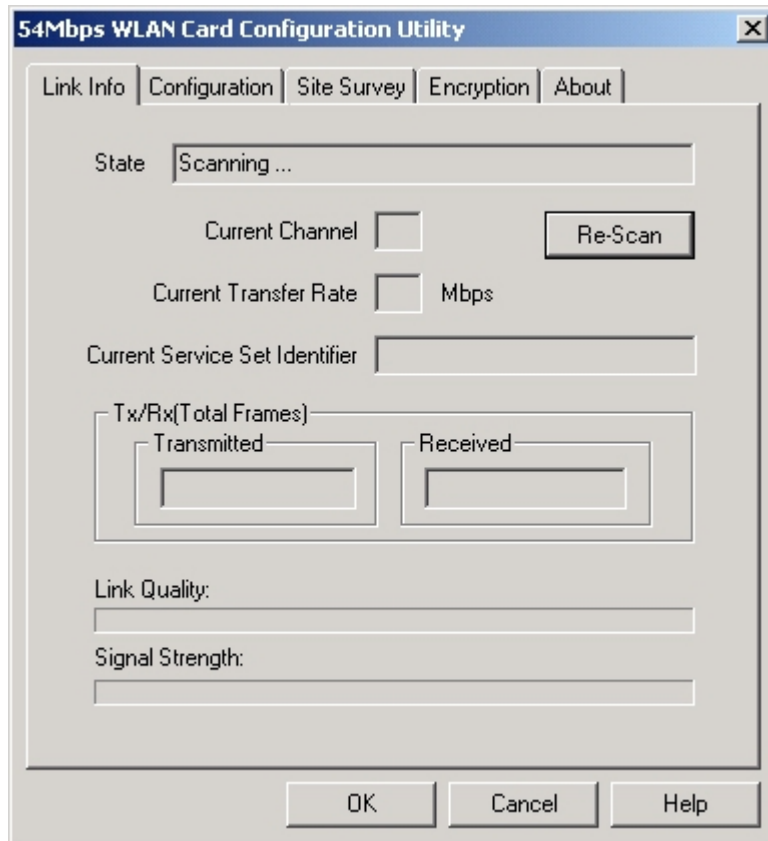

7. Click Re-Scan button to start Wireless LAN Utility. (Refer to Configuring the CardBus Wireless LAN Card.)



## Use Wireless LAN Utility In Windows 98, 2000 and ME



Wireless LAN Utility icon

Icon	Meaning
	Green: indicates a connection is linked to a wireless network.
	Red: indicates that the wireless LAN card is looking for an available access point.

Double-click the icon to open the Wireless LAN Utility. (Refer to Configuring the CardBus Wireless LAN Card.)

## Configuring the CardBus Wireless LAN Card

1. This screen shows you the status of your current connection. Click **Re-Scan** to search for wireless connection (the adapter will search for the connection automatically when it is activated).

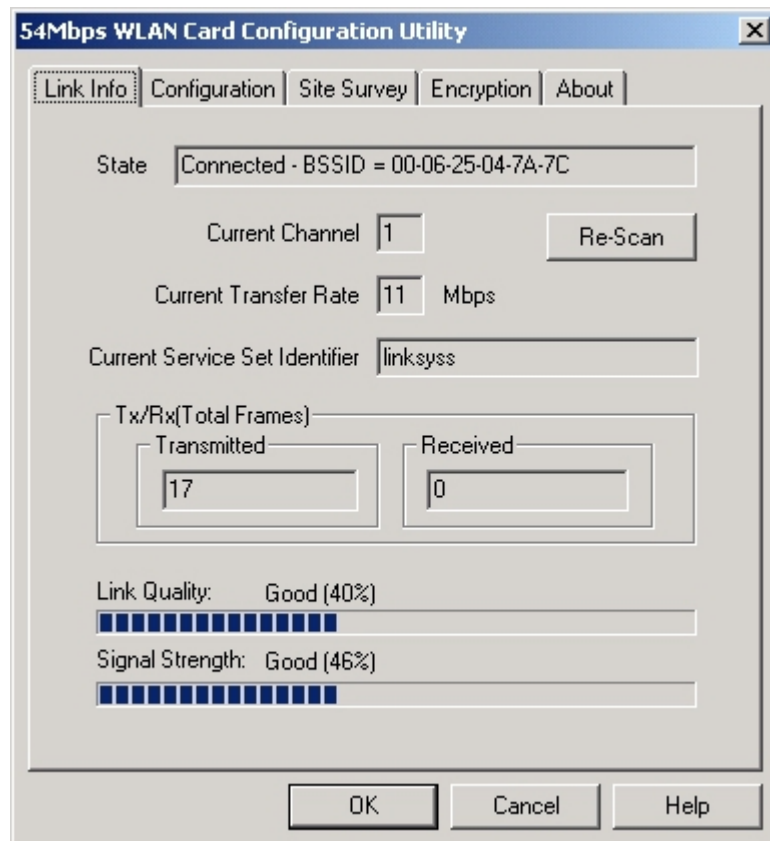

2. Select the “**Configuration**” tab. The **profile** setting allows you to save configurations in different profiles for different working environments. The default profile will contain the initial configuration setting when you install the Card. Under the **Operating Mode** drop-box, you may choose either Infrastructure or Ad-Hoc. The Infrastructure mode allows a wireless adapter to communicate with a wired network employing an Access Point, while the Ad-Hoc mode allows wireless-to-wireless, peer-to-peer communication. If you choose Infrastructure, the **SSID** should have the same name as the Access Point. If you choose **Ad-Hoc**, all clients should share the same **SSID** name. You may also select which **Transfer Rate** you wish to use: **54Mbps/ 48Mbps/ 36Mbps/ 24Mbps/ 12Mbps/ 11Mbps /9Mbps/ 6Mbps/ 5.5Mbps/ 2Mbps/ 1Mbps** or **Auto Rate**. Under **Power Saving Mode**, you can select **Enabled** to allow your adapter to go to sleep mode while the adapter doesn't precede the data transmission. Or select **Disabled** to make the adapter never go to sleep mode. Click **Apply** to save the settings.

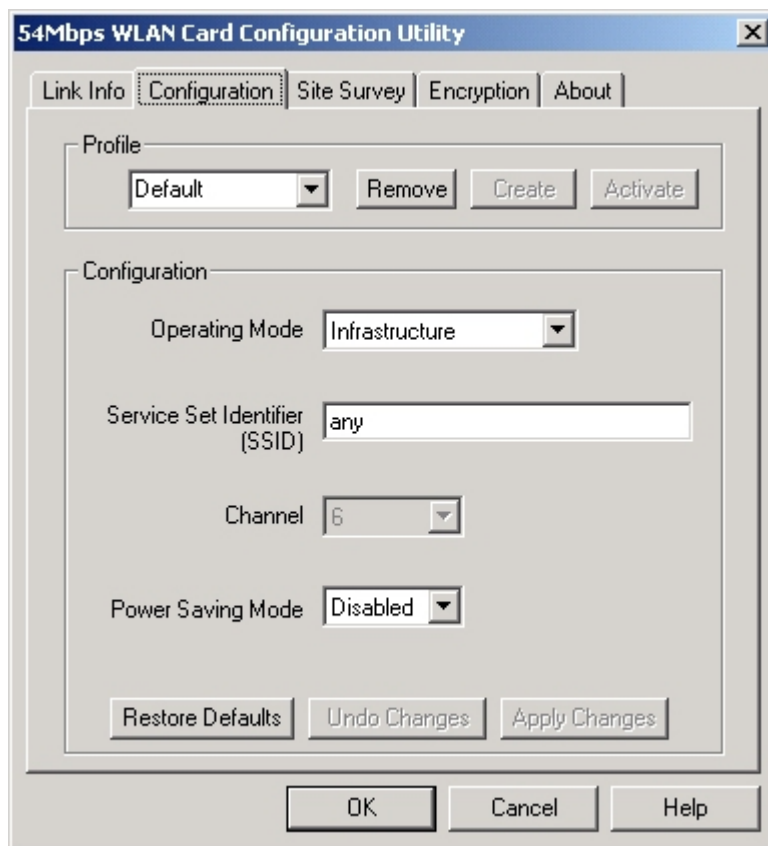

3. Select the “**Site Survey**” tab. The list on the adjacent screen shows you available Access Points and their features. Click on the desired Access Point, and then click **Connect** to connect or **Search** to search for more Access Points. Click **OK** when you are finished.

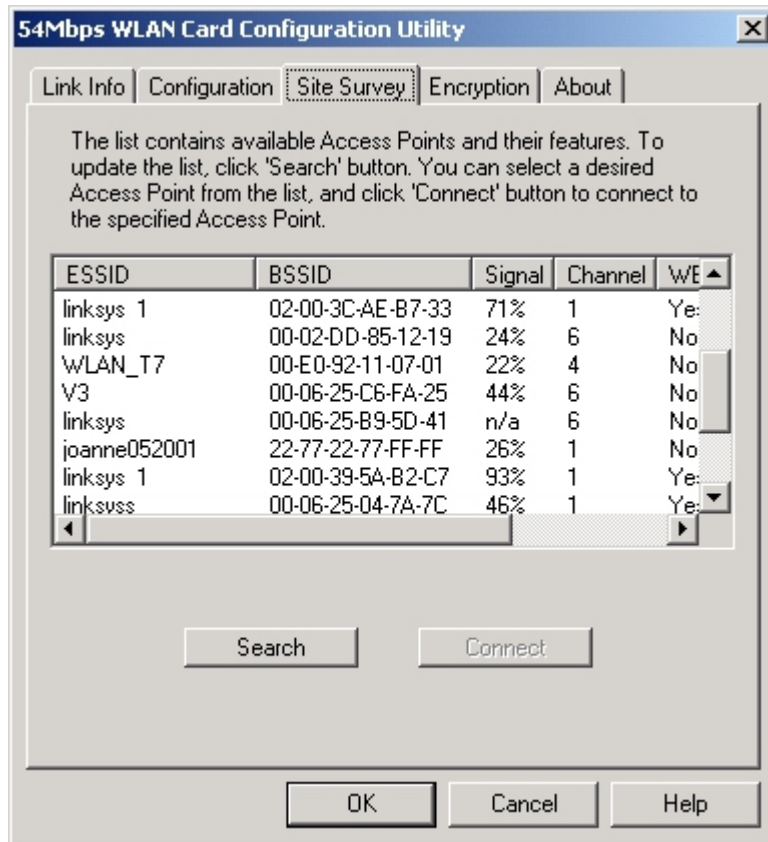



- Click on the **“Encryption”** tab. Under the drop-box, you can choose to have WEP encryption **Disabled, 64-Bit, or 128-Bit**. Wired Equivalent Privacy (WEP) is an encryption scheme used to protect wireless data communication. The Disabled setting prevents the sharing of data with other computers on the WEP network. For data sharing to be enabled, select the level of encryption desired, either 64 or 128-bit.

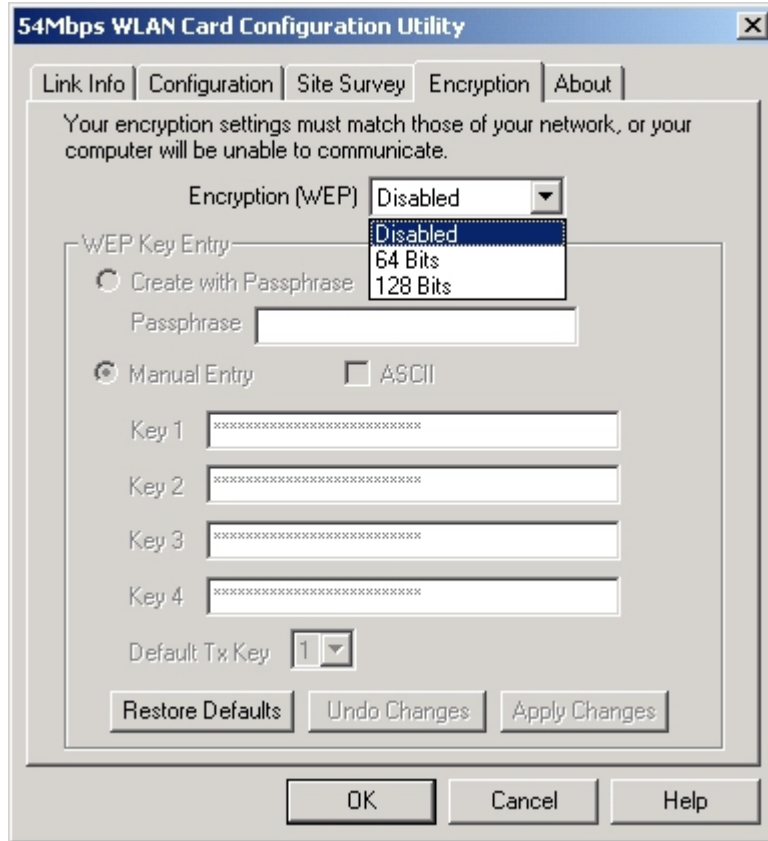

5. Select the “**Advanced**” tab. You can choose the **fragmentation threshold** to define the maximum data frame size your adapter will transmit. When the packet error rate is high, you may set the threshold value to transmit shorter frames. You may select **RTS/CTS threshold** to define when will your adapter send out RTS/CTS frames to reserve bandwidth for transmission. By using the RTS/CTS function, you may request bandwidth from AP to allow you have better chance to send out your data. For the **Security**, it's only applicable while WEP is enabled. For the **Authentication Type**, the current supported algorithms are Open System, Shared Key, and Auto. The algorithm will be invoked when associated to Access Point. To associate to the desired Access Point you must set the same algorithm as the one of the desired Access Point. When select Auto mode, the driver can auto detect the Authentication Type of the Access Point you are going to associate. You can also select **Preamble Type**, which is for framing synchronization. The possible setting are Long and Short. The setting must be the same as the setting of the Access Point you are going to associate.

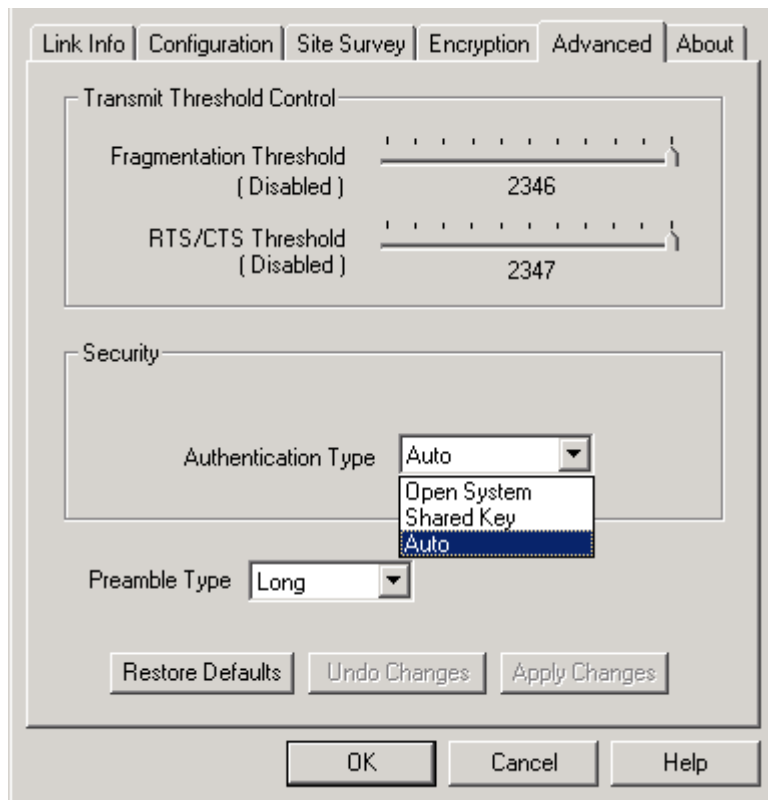

6. The “**About**” tab shows you copyright and version information about the driver, the configuration utility, and the firmware. Click **OK** to complete the configuration.

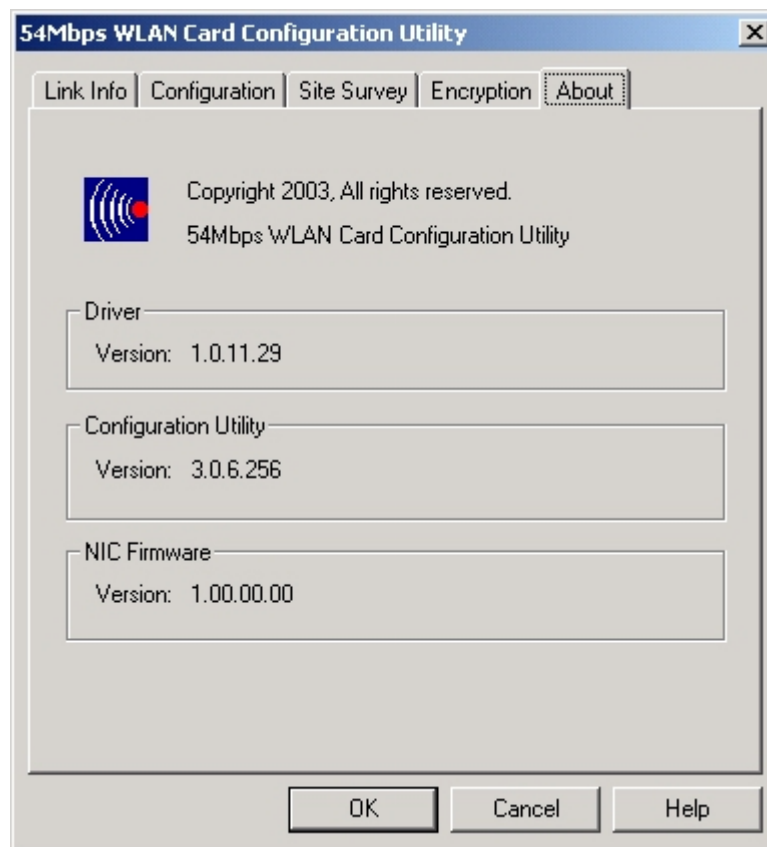

## Chapter 5 – Installing Network Protocols

Protocols are necessary for computers to be recognized on your network. Windows 2000 users need to check their Windows User Guides for protocol installation.

### Installing the Network Protocols for Windows 98 and Millennium

1. From the **Start Menu**, select **Settings** and bring up the **Control Panel**. From the Control Panel, double-click on the **Network** icon.

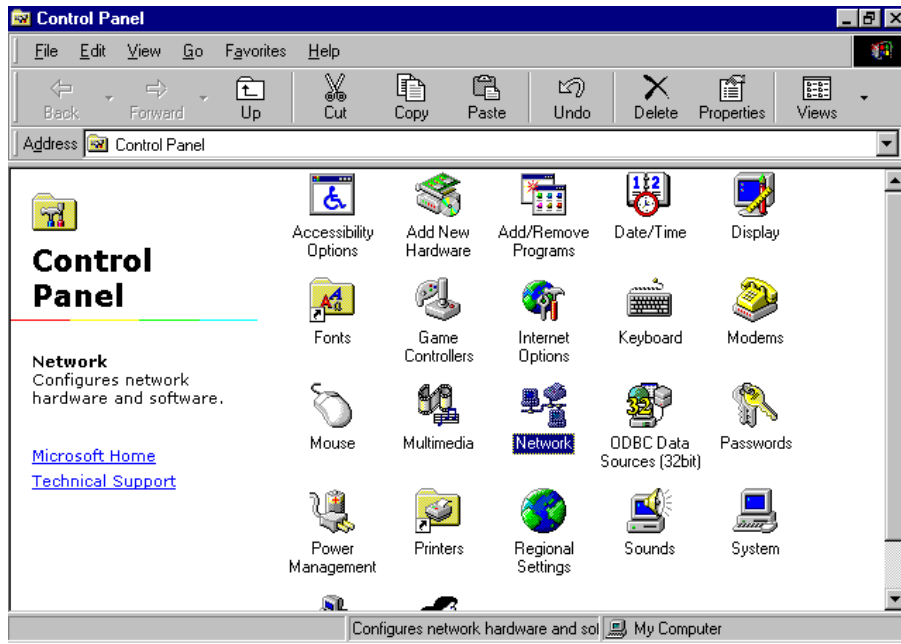

**Note!**

Before adding any network protocols, verify that the protocol is not already installed. Never install duplicate protocols.

2. Select *IEEE802.11g WLAN CardBus Card v3.0* from the list and click the **Add** button.

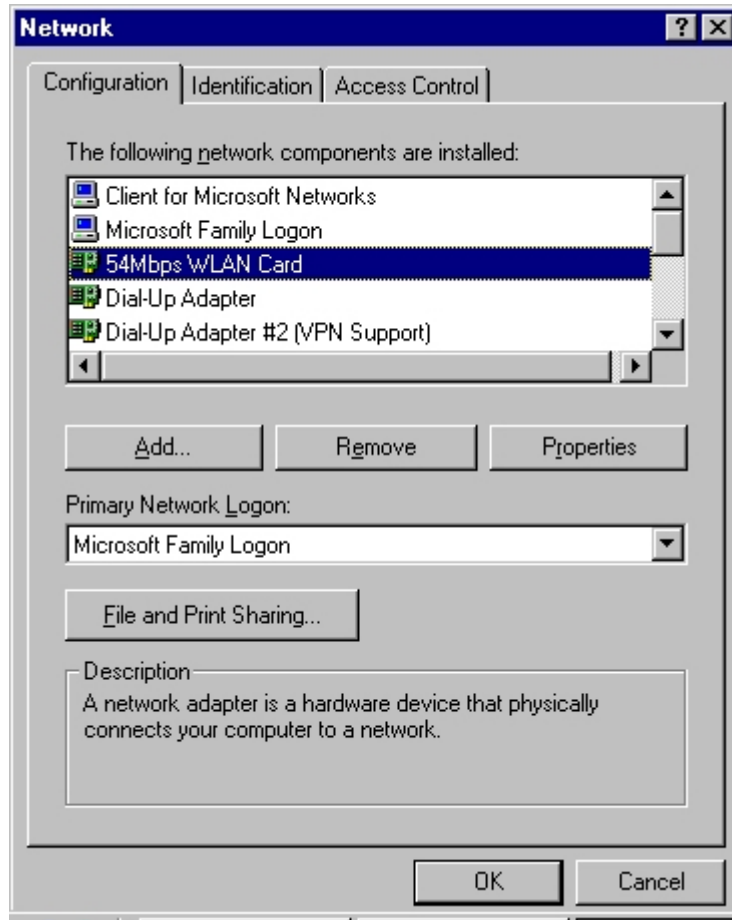

3. Highlight **Protocol** and click the **Add** button.

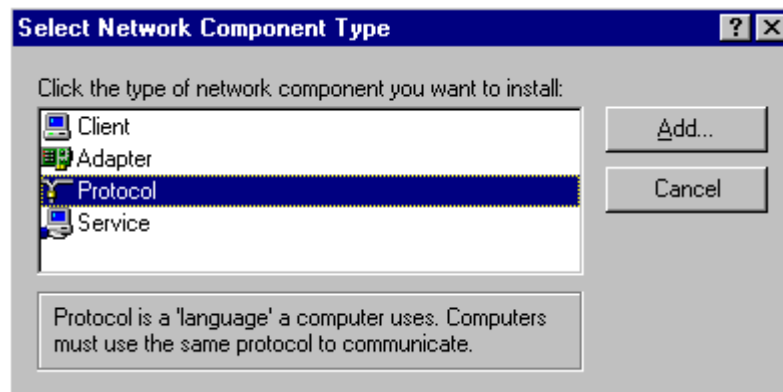

4. Select **Microsoft** from the list of “Manufacturers” and **TCP/IP** from the list of “Network” Protocols” and click the **OK** button to finish the installation.

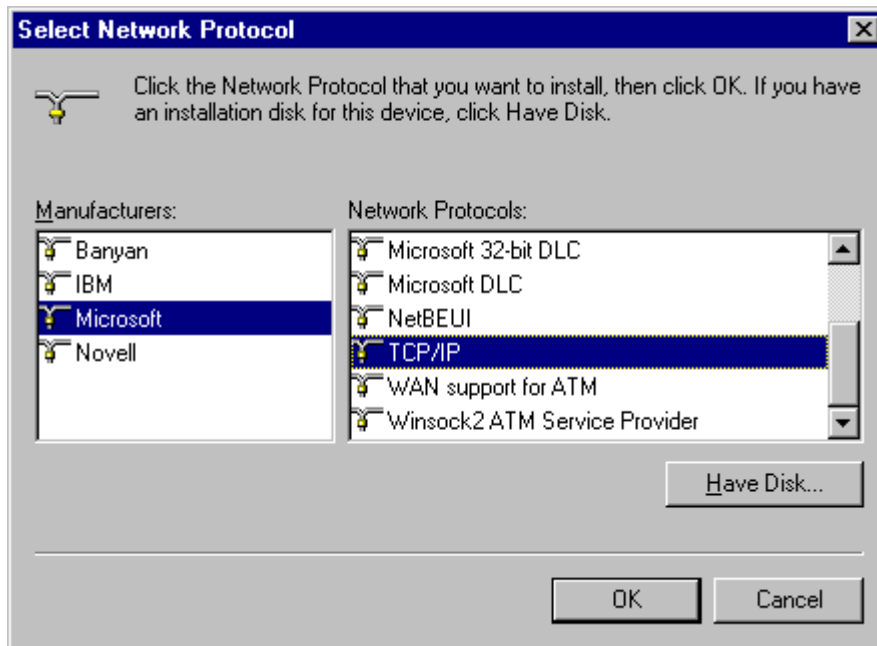

## Appendix A – FAQ

### 1. What is IEEE 802.11 standard?

- The IEEE 802.11 is a wireless LAN industry standard, and the objective of IEEE 802.11 is to make sure that different manufactures' wireless LAN devices can communicate to each other.

### 2. What is WEP?

- As described in the IEEE 802.11 standard, WEP (Wired Equivalent Privacy) is a data privacy mechanism based on a 40 bit shared key algorithm.

### 3. Windows cannot recognize the CardBus Wireless LAN Card.

- Please make sure that the LAN Card is inserted into the CardBus slot of your notebook properly (check this when the notebook is powered off).
- Please check if PC Card support is installed. Double-click the PC Card icon on Control Panel. If PC Card support is not activated, you should activate it now.

### 4. In Infrastructure mode, my notebook cannot communicate with the others notebooks on the network.

- First, make sure that the SSID is same as the others notebook.
- Check if the WEP is enabled on the Access Point, if it is, set your Adapter's WEP the same as the Access Point.
- Also check the Access Point's Authentication Type and Preamble Type and match those settings.

### 5. In ad-hoc mode, my notebook cannot communicate with the others notebooks on the network.

- Make sure the SSID and the Channel number are the same as other wireless stations.
- Check if WEP settings are the same in all wireless stations.
- Check the **Network Properties**, make sure proper protocol is installed and **File and Printer Sharing** is enabled.

## ***Appendix B – Specifications***

<b>Standards:</b>	IEEE 802.11b, IEEE 802.11g
<b>Channels:</b>	11 Channels (US, Canada) 13 Channels (Europe) 14 Channels (Japan)
<b>Antenna:</b>	Built-in Chip Antenna
<b>Frequency:</b>	2.4 to 2.497GHz (Industrial Scientific Medical Band)
<b>Speed :</b>	18dBm@11b, 12dBm@11g
<b>Data Rate:</b>	up to 54Mbps
<b>Operating Ranges:</b>	Indoor (varies depends on the environment): Up to 50M @ 11Mbps Up to 30M @ 54Mbps Outdoor (varies depends on the environment): Up to 150M @ 11Mbps Up to 100M @ 54Mbps
<b>Temperature:</b>	Operating: 0° ~ 55° C Storage: -25° ~ 70° C
<b>Humidity:</b>	10% to 90% (non-condensing)



## Free Manuals Download Website

<http://myh66.com>

<http://usermanuals.us>

<http://www.somanuals.com>

<http://www.4manuals.cc>

<http://www.manual-lib.com>

<http://www.404manual.com>

<http://www.luxmanual.com>

<http://aubethermostatmanual.com>

Golf course search by state

<http://golfingnear.com>

Email search by domain

<http://emailbydomain.com>

Auto manuals search

<http://auto.somanuals.com>

TV manuals search

<http://tv.somanuals.com>