



Dinion2X IP Camera

NBN-498



BOSCH

en Installation and Operation Manual

Table of Contents

1	Safety	8
1.1	Safety precautions	8
1.2	Important safety instructions	9
1.3	Connection in applications	10
1.4	FCC & ICES compliance	11
1.5	UL certification	13
1.6	Bosch notices	14
1.7	Copyrights	15

2	Introduction	16
2.1	Features	16

3	System Information	18
3.1	Overview of functions	18
3.1.1	Progressive scan	18
3.1.2	Day/Night function	18
3.1.3	Wide dynamic range	18
3.1.4	Tri-streaming	19
3.1.5	ONVIF (Open Network Video Interface Forum)	19
3.1.6	Audio	19
3.1.7	Alarm I/O	19
3.1.8	Tamper detection and motion detectors	19
3.1.9	Video encoding	19
3.1.10	Multicast	19
3.1.11	Power-over-Ethernet	20
3.1.12	Encryption	20
3.1.13	Receiver	20
3.1.14	Recording	20
3.1.15	Snapshots	20
3.1.16	Backup	20
3.1.17	Configuration	20
3.2	Operation with external systems	22

4	Planning	24
4.1	Unpacking	24
4.2	System requirements	25
4.3	Install players	26
<hr/>		
5	Installation	27
5.1	Network (and power) connector	27
5.2	Power connector	28
5.3	Alarm and relay connector	29
5.4	Audio connectors	30
5.5	Video service monitor connector	31
5.6	Data connector	32
5.7	Lens mounting	33
5.8	Mounting the camera	34
5.9	Using the camera install menu	35
5.10	Back focus adjustment	35
5.11	Lens adjustment	36
5.11.1	DC-iris lens	36
5.11.2	Manual-iris lens	36
5.11.3	Video-iris lens	37
5.12	Reset button	37
<hr/>		
6	Camera set-up	38
6.1	Camera menu navigation	38
6.2	Install menu	39
6.2.1	Pre-defined modes	39
6.2.2	Lens Wizard submenu	40
6.2.3	Network submenu	41
6.2.4	Defaults submenu	41
6.3	Day/Night switching	42
<hr/>		
7	Browser connection	43
7.1	System requirements	43
7.2	Establishing the connection	44
7.2.1	Password protection in camera	44

7.3	Protected network	44
7.4	Connecting to a hardware decoder	45
7.4.1	Alarm connection	45
7.5	Connection established	46
7.5.1	LIVEPAGE	46
7.5.2	RECORDINGS	46
7.5.3	SETTINGS	46
<hr/>		
8	Basic Mode	48
8.1	Basic Mode menu tree	48
8.2	Device Access	49
8.2.1	Camera name	49
8.2.2	Password	49
8.3	Date/Time	50
8.4	Network	51
8.5	Encoder Profile	52
8.6	Audio	52
8.7	Recording	52
8.7.1	Storage medium	52
8.8	System Overview	52
<hr/>		
9	Advanced Mode	53
9.1	Advanced Mode menu tree	53
9.2	General	55
9.2.1	Identification	55
9.2.2	Password	55
9.2.3	Date/Time	56
9.2.4	Display Stamping	58
9.3	Web Interface	60
9.3.1	Appearance	60
9.3.2	LIVEPAGE Functions	61
9.3.3	Logging	62
9.4	Encoder	63
9.4.1	Privacy Masks	63
9.4.2	Encoder Profile	63
9.4.3	Encoder Streams	67

9.5	Audio	68
9.6	Camera	69
9.6.1	Mode	69
9.6.2	ALC	70
9.6.3	Shutter/AGC	71
9.6.4	Day/night	72
9.6.5	Enhance	73
9.6.6	Color	74
9.6.7	Installer Options	75
9.7	Recording	77
9.7.1	Storage Management	77
9.7.2	Recording Profiles	80
9.7.3	Retention Time	81
9.7.4	Recording Scheduler	82
9.7.5	Recording Status	83
9.8	Alarm	84
9.8.1	Alarm Connections	84
9.8.2	Video Content Analyses (VCA)	87
9.8.3	VCA configuration- Profiles	88
9.8.4	VCA configuration - Scheduled	94
9.8.5	VCA configuration - Event triggered	96
9.8.6	Audio Alarm	97
9.8.7	Alarm E-Mail	98
9.8.8	Alarm Task Editor	100
9.9	Interfaces	101
9.9.1	Alarm input	101
9.9.2	Relay	101
9.9.3	COM1	102
9.10	Network	103
9.10.1	Network	103
9.10.2	Advanced	107
9.10.3	Multicasting	108
9.10.4	JPEG Posting	109
9.10.5	Encryption	110
9.11	Service	111
9.11.1	Maintenance	111
9.11.2	Licenses	113

9.11.3	System Overview	113
<hr/>		
10	Operation via the browser	114
10.1	Livepage	114
10.1.1	Processor load	114
10.1.2	Image selection	115
10.1.3	View Control	115
10.1.4	Digital I/O	115
10.1.5	System Log / Event Log	115
10.1.6	Saving snapshots	115
10.1.7	Recording video sequences	116
10.1.8	Running recording program	116
10.1.9	Audio communication	116
10.2	Recordings page	117
10.2.1	Controlling playback	117
<hr/>		
11	Troubleshooting	119
11.1	Function test	119
11.2	Resolving problems	120
11.3	Customer service	122
<hr/>		
12	Maintenance	123
12.1	Testing the network connection	123
12.2	Communication with Terminal Program	123
12.3	Repairs	125
12.3.1	Transfer and disposal	125
<hr/>		
13	Technical Data	126
13.1	Specifications	126
13.1.1	Dimensions	129
13.1.2	Accessories	130
<hr/>		
	Glossary	131

1 Safety

1.1 Safety precautions

**DANGER!**

High risk: This symbol indicates an imminently hazardous situation such as "Dangerous Voltage" inside the product. If not avoided, this will result in an electrical shock, serious bodily injury, or death.

**WARNING!**

Medium risk: Indicates a potentially hazardous situation. If not avoided, this could result in minor or moderate bodily injury.

**CAUTION!**

Low risk: Indicates a potentially hazardous situation. If not avoided, this could result in property damage or risk of damage to the unit.

1.2 Important safety instructions

Read, follow, and retain for future reference all of the following safety instructions. Follow all warnings on the unit and in the operating instructions before operating the unit.

1. Clean only with a dry cloth. Do not use liquid cleaners or aerosol cleaners.
2. Do not install unit near any heat sources such as radiators, heaters, stoves, or other equipment (including amplifiers) that produce heat.
3. Never spill liquid of any kind on the unit.
4. Take precautions to protect the unit from power and lightning surges.
5. Adjust only those controls specified in the operating instructions.
6. Operate the unit only from the type of power source indicated on the label.
7. Unless qualified, do not attempt to service a damaged unit yourself. Refer all servicing to qualified service personnel.
8. Install in accordance with the manufacturer's instructions in accordance with applicable local codes. Use only attachments/accessories specified by the manufacturer. Equipment change or modification could void the user's guarantee or authorization agreement.

1.3 Connection in applications

Power lines: An outdoor system should not be located in the vicinity of overhead power lines, electrical lights, or power circuits, or where it may contact such power lines or circuits. When installing an outdoor system, extreme care should be taken to keep from touching power lines or circuits, as this contact may be fatal.

U.S.A. models only - refer to the National Electrical Code *Article 820* regarding installation of CATV systems.

12 VDC / 24 VAC power source: This unit is intended to operate with a limited power source. The unit is intended to operate at either 12 VDC or 24 VAC (if PoE is not available). User supplied wiring must be in compliance with electrical codes (Class 2 power levels). If 24 VAC is used, do not ground the 24 VAC supply at the terminals or at the unit's power supply terminals.

PoE: Use only approved PoE devices. Power-over-Ethernet can be connected at the same time as a 12 VDC or 24 VAC power supply.



CAUTION!

The Low Voltage power supply unit must comply with EN/UL 60950. The power supply must be a SELV-LPS unit or a SELV - Class 2 unit (Safety Extra Low Voltage - Limited Power Source).

1.4 FCC & ICES compliance

FCC & ICES Information

(U.S.A. and Canadian Models Only)

This equipment has been tested and found to comply with the limits for a **Class B** digital device, pursuant to *part 15* of the *FCC Rules*. These limits are designed to provide reasonable protection against harmful interference in a **residential installation**. This equipment generates, uses, and can radiate radio frequency energy and, if not installed and used in accordance with the instructions, may cause harmful interference to radio communications. However, there is no guarantee that interference will not occur in a particular installation. If this equipment does cause harmful interference to radio or television reception, which can be determined by turning the equipment off and on, the user is encouraged to try to correct the interference by one or more of the following measures:

- reorient or relocate the receiving antenna;
- increase the separation between the equipment and receiver;
- connect the equipment into an outlet on a circuit different from that to which the receiver is connected;
- consult the dealer or an experienced radio/TV technician for help.

Intentional or unintentional modifications, not expressly approved by the party responsible for compliance, shall not be made. Any such modifications could void the user's authority to operate the equipment. If necessary, the user should consult the dealer or an experienced radio/television technician for corrective action.

The user may find the following booklet, prepared by the Federal Communications Commission, helpful: *How to Identify and Resolve Radio-TV Interference Problems*. This booklet is available from the U.S. Government Printing Office, Washington, DC 20402, Stock No. 004-000-00345-4.

Informations FCC et ICES

(modèles utilisés aux États-Unis et au Canada uniquement)

Suite à différents tests, cet appareil s'est révélé conforme aux exigences imposées aux appareils numériques de **classe B**, en vertu de la *section 15 du règlement* de la *Commission fédérale des communications des États-Unis (FCC)*, et en vertu de la norme *ICES-003 d'Industrie Canada*. Ces exigences visent à fournir une protection raisonnable contre les interférences nuisibles lorsque l'appareil est utilisé dans le cadre d'une **installation résidentielle**. Cet appareil génère, utilise et émet de l'énergie de radiofréquences et peut, en cas d'installation ou d'utilisation non conforme aux instructions, engendrer des interférences nuisibles au niveau des radiocommunications. Toutefois, rien ne garantit l'absence d'interférences dans une installation particulière. Il est possible de déterminer la production d'interférences en mettant l'appareil successivement hors et sous tension, tout en contrôlant la réception radio ou télévision. L'utilisateur peut parvenir à éliminer les interférences éventuelles en prenant une ou plusieurs des mesures suivantes:

- Modifier l'orientation ou l'emplacement de l'antenne réceptrice;
- Éloigner l'appareil du récepteur;
- Brancher l'appareil sur une prise située sur un circuit différent de celui du récepteur;
- Consulter le revendeur ou un technicien qualifié en radio/ télévision pour obtenir de l'aide.

Toute modification apportée au produit, non expressément approuvée par la partie responsable de l'appareil, est strictement interdite. Une telle modification est susceptible d'entraîner la révocation du droit d'utilisation de l'appareil. La brochure suivante, publiée par la Commission fédérale des communications (FCC), peut s'avérer utile : *Comment identifier et résoudre les problèmes d'interférences de radio et de télévision*. Cette brochure est disponible auprès du U.S. Government Printing Office, Washington, DC 20402, États-Unis, sous la référence n° 004-000-00345-4.

1.5 UL certification

Disclaimer

Underwriter Laboratories Inc. ("UL") has not tested the performance or reliability of the security or signaling aspects of this product. UL has only tested fire, shock and/or casualty hazards as outlined in UL's *Standard(s) for Safety for Information Technology Equipment, UL 60950-1*. UL Certification does not cover the performance or reliability of the security or signaling aspects of this product.

UL MAKES NO REPRESENTATIONS, WARRANTIES, OR CERTIFICATIONS WHATSOEVER REGARDING THE PERFORMANCE OR RELIABILITY OF ANY SECURITY OR SIGNALING RELATED FUNCTIONS OF THIS PRODUCT.



Disposal - Your Bosch product was developed and manufactured with high-quality material and components that can be recycled and reused. This symbol means that electronic and electrical appliances, which have reached the end of their working life, must be collected and disposed of separately from household waste material. Separate collecting systems are usually in place for disused electronic and electrical products. Please dispose of these units at an environmentally compatible recycling facility, per *European Directive 2002/96/EC*

1.6 Bosch notices

Video loss

Video loss is inherent to digital video recording; therefore, Bosch Security Systems cannot be held liable for any damage that results from missing video information. To minimize the risk of lost digital information, Bosch Security Systems recommends multiple, redundant recording systems, and a procedure to back up all analog and digital information.

Copyright

This manual is the intellectual property of Bosch Security Systems and is protected by copyright.

All rights reserved.

Trademarks

All hardware and software product names used in this document are likely to be registered trademarks and must be treated accordingly.

Note

This manual has been compiled with great care and the information it contains has been thoroughly verified. The text was complete and correct at the time of printing. The ongoing development of the products may mean that the content of the user guide can change without notice. Bosch Security Systems accepts no liability for damage resulting directly or indirectly from faults, incompleteness or discrepancies between the user guide and the product described.

More information

For more information please contact the nearest Bosch Security Systems location or visit www.boschsecurity.com

1.7 Copyrights

The firmware 4.1 uses the fonts "Adobe-Helvetica-Bold-R-Normal--24-240-75-75-P-138-ISO10646-1" and "Adobe-Helvetica-Bold-R-Normal--12-120-75-75-P-70-ISO10646-1" under the following copyright:

Copyright 1984-1989, 1994 Adobe Systems Incorporated.

Copyright 1988, 1994 Digital Equipment Corporation.

Permission to use, copy, modify, distribute and sell this software and its documentation for any purpose and without fee is hereby granted, provided that the above copyright notices appear in all copies and that both those copyright notices and this permission notice appear in supporting documentation, and that the names of Adobe Systems and Digital Equipment Corporation not be used in advertising or publicity pertaining to distribution of the software without specific, written prior permission.

This software is based in part on the work of the Independent JPEG Group.

2 Introduction

2.1 Features

The Dinion2x IP Day/Night camera is a high-performance, smart surveillance color camera. It incorporates 20-bit digital signal processing and a wide dynamic range sensor for outstanding picture performance under all lighting conditions.

The camera uses H.264 compression technology to give clear images while reducing bandwidth and storage requirements. It is also ONVIF compliant to improve compatibility during system integration.

The camera operates as a network video server and transmits video and control signals over data networks, such as Ethernet LANs and the Internet.

The camera is easy to install and ready to use.

Features include:

- Progressive scan
- True Day/Night performance with switchable IR filter
- 1/3-inch CCD sensor with wide dynamic range
- Tri-streaming (two H.264 streams and one M-JPEG stream)
- Complies with the ONVIF standard for wide compatibility
- Two-way audio and audio alarm
- Alarm input and alarm output to external devices
- Dynamic engine with Smart BLC
- Six pre-programmed operation modes
- Adaptive dynamic noise reduction
- Enhanced video motion detection
- Video and data transmission over IP data networks
- Multicast function for simultaneous picture transmission to multiple receivers
- Integrated Ethernet interface (10/100 Base-T)
- Power-over-Ethernet (PoE)
- Remote control of all built-in functions via TCP/IP
- Data interface RS485/RS422/RS232 for control of pan or tilt heads or motorized zoom lenses (PTZ control)

- Password protection to prevent unauthorized connection or configuration changes
- Event-driven, automatic connection (for example, at switch-on and for alarms)
- Fast, convenient configuration using the integrated Web server and a browser
- Firmware update through flash memory
- Convenient upload and download of configuration data

3 System Information

3.1 Overview of functions

The camera incorporates a network video server. Its primary function is to encode video and control data for transmission over an IP network. With its H.264 encoding, it is ideally suited for IP communication and for remote access to digital video recorders and IP systems. The use of existing networks means that integration with CCTV systems or local networks can be achieved quickly and easily. Video images from a single camera can be simultaneously received on several receivers.

3.1.1 Progressive scan

The camera captures and processes progressively scanned images. When there is fast motion in a scene, progressively scanned images are generally sharper than interlaced images.

3.1.2 Day/Night function

The Day/Night function provides enhanced night viewing by increasing the IR sensitivity. The motorized IR filter can be removed in low-light or IR illuminated applications. The IR filter switches from color to monochrome automatically by sensing the illumination level. In auto switching mode the camera prioritizes motion (the camera gives sharp images without motion blur) or color (the camera gives color pictures as long as the light level permits).

3.1.3 Wide dynamic range

A unique combination of 20-bit digital video processing that enhances sensitivity and 2X-Dynamic which extends the dynamic range, provides a sharper, more detailed image with outstanding accuracy in color reproduction. The 20-bit digital signal is automatically processed to optimally capture the detail in both the high and low light areas of the scene simultaneously, maximizing the information visible in the picture.

3.1.4 Tri-streaming

Tri-streaming allows the data stream to be encoded simultaneously according to three different, individually customized profiles. This creates two full H.264 streams that can serve different purposes and an additional M-JPEG stream.

3.1.5 ONVIF (Open Network Video Interface Forum)

The camera complies to the ONVIF standard which means that it is easier to install and integrate into larger systems. The ONVIF standard is a global standard for the interface of network video products.

3.1.6 Audio

Two-way duplex audio is available in the unit for live voice communications or audio recording.

3.1.7 Alarm I/O

The alarm input can be used to control the functionality of the unit. An alarm output can control external devices.

3.1.8 Tamper detection and motion detectors

The camera offers a wide range of configuration options for alarm signaling in the event of tampering with the camera. An algorithm for detecting movement in the video image is also part of the scope of delivery and can optionally be extended to include special video analysis algorithms.

3.1.9 Video encoding

The camera uses the H.264 compression standards. Thanks to efficient encoding, the data rate remains low even with high image quality and can also be adapted to local conditions within wide limits.

3.1.10 Multicast

In suitably configured networks, the multicast function enables simultaneous, real time transmission to multiple receivers. The prerequisite for this is that the UDP and IGMP V2 protocols are implemented on the network.

3.1.11 Power-over-Ethernet

Power for the camera can be supplied via a Power-over-Ethernet compliant network cable connection. With this configuration, only a single cable connection is required to view, power, and control the camera.

3.1.12 Encryption

The unit offers a variety of options for protection against unauthorized reading. Web browser connections can be protected using HTTPS. Protect the control channels via the SSL encryption protocol. With an additional license, the user data itself can be encrypted.

3.1.13 Receiver

H.264 compatible hardware decoders can be used as a receiver. Computers with decoding software such as VIDOS, or computers with the Microsoft Internet Explorer web browser installed, can also be used as receivers.

3.1.14 Recording

The camera can be used with an iSCSI server connected via the network to store long-term recordings.

3.1.15 Snapshots

Individual video frames (snapshots) can be called up as JPEG images, stored on the hard drive, or displayed in a separate browser window.

3.1.16 Backup

The browser application has an icon for saving the video images provided by the unit as a file on your computer's hard drive. Clicking this icon stores the video sequences and they can be replayed with the Player from Bosch Security Systems included with the package.

3.1.17 Configuration

The camera can be configured using a browser on the local network (Intranet) or from the Internet. Similarly, firmware updates and rapid loading of device configurations are also

possible. Configuration settings can be stored as files on a computer and copied from one camera to another.

3.2 Operation with external systems

The camera can be used with a variety of Bosch software and hardware systems:

- Bosch Video Management System
- VIDOS video management software
- DiBos 900 Series digital video recorder
- Divar 700 Series digital video recorder

Note:

When connected to any of these systems, many of the camera configuration parameters are controlled by the system and not by the settings made via a web browser connected to the camera.

Bosch Video Management System

The Bosch Video Management System is a unique enterprise IP video surveillance solution that provides seamless management of digital video, audio, and data across any IP network. It is designed to work with Bosch CCTV products as part of a total video surveillance management system. Integrate your existing components into one easy-to-manage system, or use Bosch's full-line capabilities and benefit from a complete surveillance solution based on cutting-edge technology and years of experience.

VIDOS

The camera video server and VIDOS software combine to provide a high-performance system solution. VIDOS is software for operating, controlling, and administering CCTV installations (such as surveillance systems) at remote locations. It runs under Microsoft Windows operating systems. Its main job is decoding video, audio, and control data from a remote transmitter. There are many options available for operation and configuration when using a camera with VIDOS.

DiBos 900 Series

The camera is also designed for use with DiBos 900 Series Video Recorders. DiBos can record up to 32 video and audio

streams, and is available as software or as a hybrid DVR with additional analog camera and audio inputs. DiBos supports various functions of the camera, such as controlling relays, remote control of peripheral devices, and remote configuration. DiBos can use alarm inputs to trigger actions and, when motion detection **Motion+** is active, can record the relevant cells, making intelligent motion detection possible.

Divar 700 Series

The Divar 700 Series of digital video recorders can view and record images from the camera via a network connection. The Divar 700 Series controls the camera so that the correct settings are used.

4 Planning

4.1 Unpacking

Unpack carefully and handle the equipment with care. The packaging contains:

- Dinion2X IP camera
- CCD protection cap (mounted on camera)
- Power connector
- Alarm I/O connector
- Data connector
- Spare lens connector (male)
- DVD ROM (mini)
 - Manual
 - System requirements
 - Configuration Manager
 - BVIP Lite Suite
 - MPEG ActiveX control
 - DirectX control
 - Microsoft Internet Explorer
 - Sun JVM
 - Player and Archive Player
 - Adobe Acrobat Reader
- Quick install instructions
- Safety instructions

If equipment has been damaged during shipment, repack it in the original packaging and notify the shipping agent or supplier.

4.2 System requirements

- Computer with Windows XP/Vista operating system, network access, and Microsoft Internet Explorer web browser version 7.0 or later
or
- Computer with Windows XP/Vista operating system, network access and reception software, for example VIDOS, Bosch VMS, or DIBOS 900 Series
or
- H.264 compatible hardware decoder from Bosch Security Systems (such as VIP XD) as a receiver and a connected video monitor
or
- Divar 700 Series Digital Video Recorder

The minimum PC requirements are:

- Operating platform: A PC running Windows XP or Windows Vista with IE 7.0
- Processor: Dual core, 3.0 GHz
- RAM memory: 256 MB
- Monitor resolution: 1024 x 768
- Network interface: 100-BaseT
- DirectX: 9.0c

Make sure the graphics card is set to 16-bit or 32-bit color depth and that Sun JVM is installed on your PC. To play back live video images, an appropriate ActiveX must be installed on the computer. If necessary, install the required software and controls from the product DVD provided. For further assistance, contact your PC system administrator.

4.3 Install players

Play back saved-video sequences using the Player from Bosch Security Systems. This can be found on the DVD-ROM supplied.

to play back saved sequences using the Player, suitable ActiveX software must be installed on the computer.

1. Insert the DVD into the DVD-ROM drive of the computer. If the DVD does not start automatically, open the DVD in Windows Explorer and double-click the **index.html** file to start the installation.
2. Select a language from the list box at the top.
3. Click **Tools** in the menu.
4. Click **Archive Player**; the installation starts.
5. Follow the instructions in the installation program. The Archive Player is installed together with the Player.
6. After a successful installation, two new icons for the Player and the Archive Player appear on the desktop.
7. Double-click the **Player** icon to start the Player.

5 Installation



CAUTION!

Installation should only be performed by qualified service personnel in accordance with the National Electrical Code or applicable local codes.

5.1 Network (and power) connector

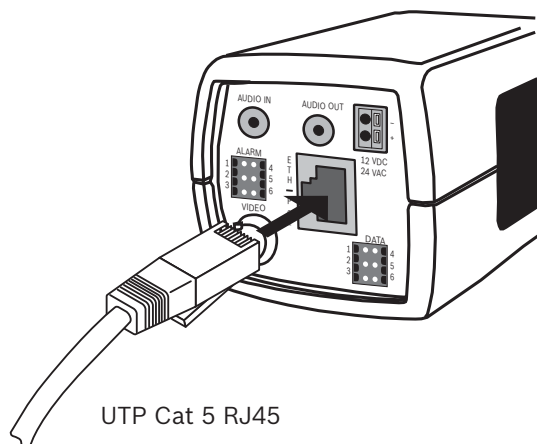

Figure 5.1 Network connection

- Connect the camera to a 10/100 Base-T network.
- Use screened UTP Category 5e cable with RJ45 connectors (the camera network socket is Auto MDIX compliant).
- Power can be supplied to the camera via the Ethernet cable compliant with the Power-over-Ethernet (IEEE 802.3af) standard.

The multicolored LED beside the Ethernet connection indicates Power (red), IP connection (green) and IP traffic (green flashing). It can be disabled in the **Settings/Camera Settings/Install options** menu.

By default, power is supplied to the camera via the Ethernet cable, compliant with the Power-over-Ethernet standard.

5.2 Power connector

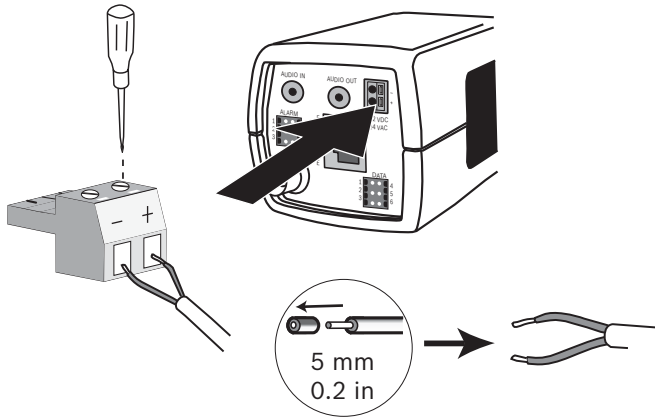

Figure 5.2 Power connection

Connect power from a 24 VAC or 12 VDC class 2 power supply as follows:

- Use AWG16 to 22 stranded wire or AWG16 to 26 solid wire; cut back 5 mm (0.2 in) of insulation.
- Loosen the screws of the supplied 2-pole connector and insert the wires.
- Tighten the screws and insert the 2-pole connector into the power socket of the camera.

Note:

For a **DC supply** the polarity is important. Incorrect polarity does not damage the camera but it will not switch on.

5.3 Alarm and relay connector

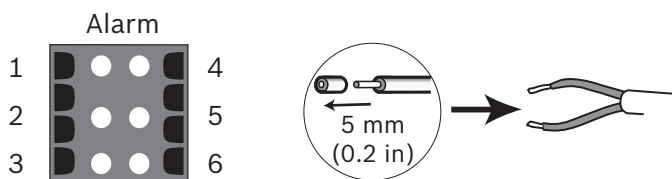

Figure 5.3 Alarm and relay connector pins

Pin	Alarm socket
1	Alarm in 1
2	Alarm in 2
3	Relay out contact 1
4	Ground
5	Ground
6	Relay out contact 2

- Max. wire diameter AWG 22-28 for both stranded and solid; cut back 5 mm (0.2 in) of insulation.
- Alarm output relay switching capability: Max voltage 30VAC or +40 VDC. Max 0.5 A continuous, 10 VA.
- Alarm in: TTL logic, +5V nominal, +40 VDC max, DC coupled with 22 kOhm pull-up to +3.3 V.
- Alarm in: configurable as active low or active high.
- Max. 42 V allowed between camera ground and each of the relay pins.

Use the alarm input to connect external alarm devices such as door contacts or sensors. A zero potential make-contact or switch can be used as the actuator (use a bounce-free contact system).

Use the alarm relay output for switching external devices such as lamps or sirens.

5.4 Audio connectors

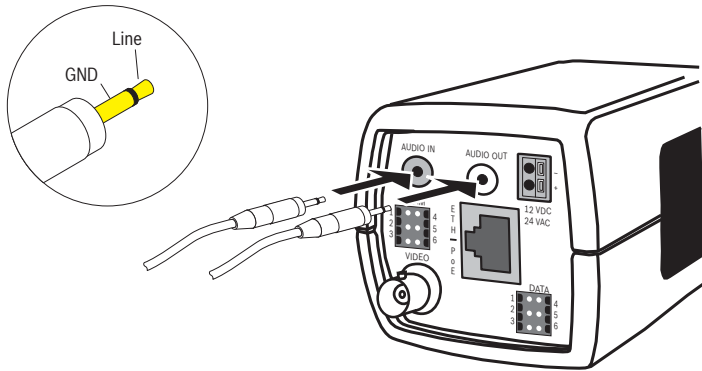

Figure 5.4 Audio connectors

Connect audio devices to the **Audio In** and **Audio Out** connectors.

The unit has full-duplex mono audio. The two-way communication can be used to connect a speaker or door intercom system. The audio input signal is transmitted in sync. with the video signal.

Audio input: Line input level (not suitable for direct microphone signal); impedance 9 kOhm typical; 5.5 Vpp maximum input voltage.

Audio output: Line output level (not suitable for direct speaker connection); impedance 16 Ohm minimum; 3 Vpp maximum output voltage.

Wiring: Shielded audio connection cable is advised. Observe maximum cable lengths for audio line input and output levels.

5.5 Video service monitor connector

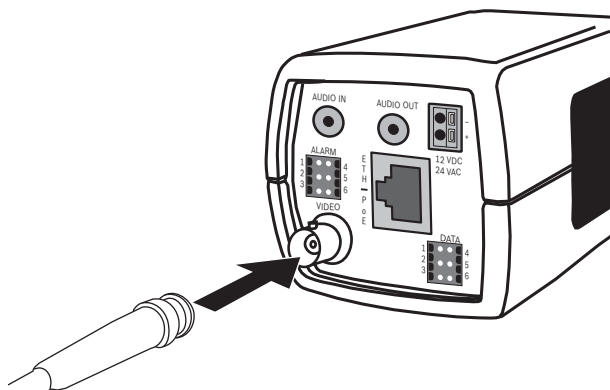

Figure 5.5 Video BNC connector

1. Connect a service monitor to the composite video BNC connector to aid installation.
2. Open the side panel on the camera and press the center button for longer than 2 seconds. This stops the IP video stream and enables the video analog output.

5.6 Data connector

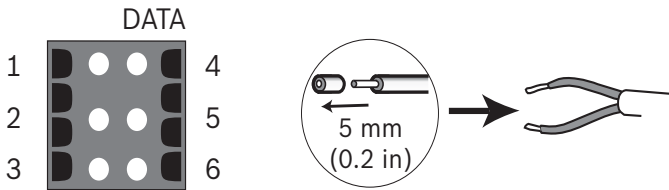

Figure 5.6 Data connector pins

Pin	Data socket
1	Ground
2	RxD / Rx+
3	CTS / Rx-
4	Ground
5	TxD / Tx-
6	RTS / Tx+

The data connector is used to connect the control data coming out of the camera to external devices. RS485, RS422, and RS232 is supported by this data connection.

Note:

To ensure surge and electrostatic protection, keep the cable length between the camera and external device to less than 3 meters.

5.7 Lens mounting

The camera accepts CS-mount lenses. C-mount lenses can be mounted using a lens adapter ring. DC-iris lenses are recommended for best picture performance. The camera automatically detects the type of lens and optimizes performance accordingly. A spare male lens connector is provided.



CAUTION!

To avoid damaging the CCD sensor when using a C-mount lens, make sure the supplied lens adapter ring is mounted onto the camera before mounting the lens.



CAUTION!

Lenses weighing more than 0.5 kg (1.1lbs) must be separately supported.

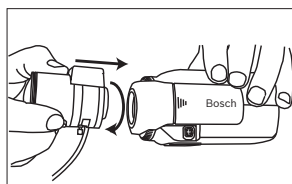

Figure 5.7 Mounting a lens

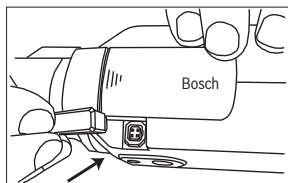

Figure 5.8 Lens connector

Pin	Video iris lens	DC iris lens	
1	Supply (11.5V \pm 0.5, 50mA max.)	Damp -	
2	Not used	Damp +	
3	Video signal 1Vpp 1kOhm	Drive +	
4	Ground	Drive -	

Note

If a short circuit is detected on the lens connector, the message LENS SHORT CIRCUIT is shown. The lens circuit is automatically disabled to avoid internal damage. Remove the lens connector and check the pin connections.

5.8 Mounting the camera

The camera can be mounted either from the top or from the bottom (1/4" 20 UNC thread).

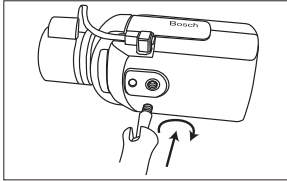

Figure 5.9 Mounting a camera



CAUTION!

The CCD image sensors are highly sensitive and require special care for proper performance and extended lifetime. Do not expose them, or point the camera/lens, to direct sunlight. Do not obstruct the free flow of air around the camera.

5.9 Using the camera install menu

Five keys, located behind the side door panel, are used for accessing the camera menu.

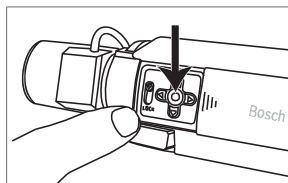
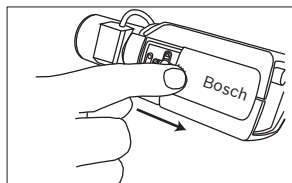

To open the install menu press and hold the center key for approximately two seconds. The BNC video output is activated and the **Install** menu appears on the monitor.

5.10 Back focus adjustment

To optimize picture sharpness in both bright and low-level lighting, adjust the back focus. Use the camera's unique Lens Wizard. This ensures that the object of interest always remains in focus, even when focusing at the maximum lens iris opening (for example, at night).

- When back focusing varifocal lenses, adjust to obtain a sharp picture in both wide-angle and tele positions for both far and near focus.
- When back focusing zoom lenses, ensure the object of interest remains in focus throughout the entire zoom range of the lens.

To adjust back focus:

1. Slide open the door panel at the side of the camera.

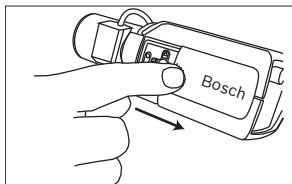

2. Unlock the back focus locking button.

3. Press and hold the center key for more than 2 seconds until the **Install** menu appears.
4. Select **Len Wizard** and move cursor to the **Set Back Focus Now** item.
5. Turn the back focus adjustment as required.

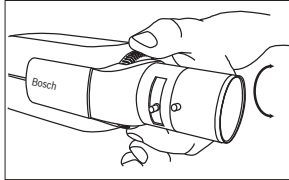

6. Lock the back focus locking button.

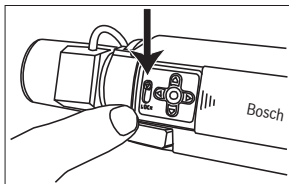

7. Press and hold the center key for more than 2 seconds until all the menus disappear.
8. Close the side door panel.

5.11 Lens adjustment

5.11.1 DC-iris lens

1. Unlock the back focus locking button.
2. Access the **Lens Wizard** menu.
3. **Set Back Focus Now** is highlighted in the menu.
4. Turn the back focus adjustment as required.
5. Lock the back focus locking button.
6. Exit the menu.

5.11.2 Manual-iris lens

1. Unlock the back focus locking button.
2. Adjust the lens to the maximum lens opening.
3. Turn the back focus adjustment as required.
4. Lock the back focus locking button.

5.11.3 Video-iris lens

1. Unlock the back focus locking button.
2. Access the **Lens Wizard** menu.
3. **Set Back Focus Now** is highlighted in the menu.
4. Turn the back focus adjustment as required.
5. Lock the back focus locking button.
6. Select **Set LVL** in the menu; the **Level** bar appears.
7. Point the camera at the scene it will be mostly viewing.
8. Adjust the level potentiometer located on the lens until the **Level** bar is in the central position.
9. Exit the menu.

The best performance with video iris lenses is obtained when the peak/average potentiometer of the lens matches the peak/average balance configuration setting.

5.12 Reset button

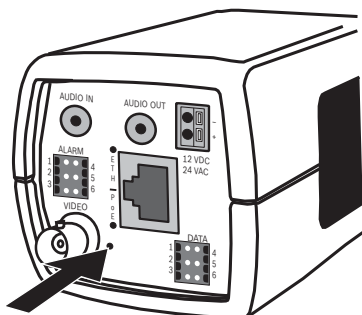

Figure 5.10 Reset button

With the power on, use a small pointed object to press and hold the reset button for more than 10 seconds to restore the factory defaults. This is useful to restore the default IP address or to restore a previous version of the firmware if uploading a new version fails.

6 Camera set-up

The camera normally provides an optimal picture without the need for further adjustments. Configuration of the camera is carried out remotely via the network using a web browser. However, the camera also has a set-up menu in which basic installation settings (lens wizard, IP address) can be accessed. To view this menu, connect a monitor to the composite video output of the camera.

6.1 Camera menu navigation

Five keys are used for navigating through menu system.

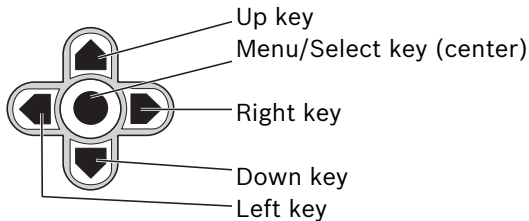

Figure 6.1 Navigation

- To open the install menu and enable the analog video output, press and hold the center key for approximately two seconds. This turns off the IP video stream.
- Use the up or down keys to scroll through a menu.
- Use the left or right keys to move through options or to set parameters.
- When in a menu, quickly double-press the menu/select key to restore the selected item to its factory default.
- To close all menus at once hold down the menu/select key until the menu display disappears or continually select the **Exit** item. (This turns the IP video stream back on.)

Some menus automatically close after about two minutes; other menus have to be closed manually.

6.2 Install menu

When the Install menu is opened, the MAC address of the unit is shown. This is factory set and cannot be changed. (To ensure that the correct MAC address is displayed, wait 20 seconds after power-up before opening the Install menu.)

The items in the Install menu include the Mode selection, the Lens Wizard submenu, the Network submenu, and the Defaults submenu.

Note:

Camera parameter set-up is done via IP. See Section 9.6 Camera for the specific camera menus.

6.2.1 Pre-defined modes

There are six pre-defined modes with settings to make configuration easier. Select one of the six pre-defined modes in the Install/Mode submenu. The modes are defined as follows;

1. **24-hour**
Default installation mode to provide stable pictures over a 24-hour period. These settings are optimized for out-of-the-box installation.
2. **Traffic**
Capture high-speed objects using default shutter in variable lighting conditions.
3. **Low light**
Provide extra enhancement, such as AGC and SensUp to make usable pictures in low-light conditions.
4. **Smart BLC**
Settings optimized to capture details in high contrast and extremely bright-dark conditions.
5. **Low noise**
Enhancements are set to reduce picture noise. Useful for conditional refresh DVR and IP storage systems because reducing noise reduces the amount of storage required.

6. Infrared

Use this mode if the camera is viewing a scene lit by infrared light.

6.2.2 Lens Wizard submenu

Item	Selection	Description
Lens type	Auto, Manual, DC- iris, Video	Auto: - automatically selects the type of lens. Manual, DC-iris, Video modes: select the matching lens type to force the camera to the correct lens mode.
Detected		Shows the type of lens detected when auto lens detection is used.
Set Backfocus now		Select to fully open the iris. Follow the instructions below for setting the backfocus for your particular lens type. After focusing the object of interest remains in focus under bright and low light conditions.
Set LVL		Only for video-iris lenses. Adjust the level control on the lens to center the level detector indicator (see below).
EXIT		Returns to Install menu.

6.2.3 Network submenu

To operate the camera in your network, a network-valid IP address must be assigned. The factory default IP address is 192.168.0.1

Function	Selection	Description
IP Address		Enter an IP address for the camera. Use LEFT/RIGHT to change position in the address, use UP/DOWN to select the digit. Use SELECT to exit the address edit screen.
Subnet Mask		Enter the Subnet mask (default 255.255.255.0).
Gateway		Enter a Gateway address.
DHCP		If the network has a DHCP server for dynamic IP address allocation, set this parameter to On to activate the automatic acceptance of DHCP-assigned IP addresses.
Exit		Return to the Install menu.

The new IP address, subnet mask, and gateway address are set when leaving the menu. The camera reboots internally and the new values are set after a few seconds.

6.2.4 Defaults submenu

Item	Selection	Description
Restore All?	No, Yes	Restores all settings of the six modes to their default (factory) values. Select YES then press the Menu/Select button to restore all values. When completed the message RESTORED! is shown.

6.3 Day/Night switching

The camera is equipped with a motorized IR filter. The mechanical IR filter can be removed in low-light or IR illuminated applications by software configuration settings. If **Auto** switching mode is selected, the camera automatically switches the filter depending on the observed light level. The switching level is programmable. In **Auto** switching mode the camera prioritizes motion (the camera gives sharp images without motion blur as long as the light level permits) or color (the camera gives color pictures as long as the light level permits). The camera recognizes IR illuminated scenes to prevent unwanted switching to color mode.

There are four different methods of controlling the IR filter:

- via an alarm input,
- automatically, based on the observed light levels, or
- as part of the programmable mode profile.

7 Browser connection

A computer with Microsoft Internet Explorer can be used to receive live images from the camera, control cameras, and replay stored sequences. The camera is configured over the network using the browser (or via the supplied Configuration Manager). The configuration options using the menu system of the camera itself are limited to setting up the lens and network.

Note:

The camera can also be connected to DIBOS 900 Series, VIDOS, Bosch Video Management System, and Divar 700 Series Digital Video Recorder, as well as third party video management systems.

7.1 System requirements

- Microsoft Internet Explorer version 7.0 or higher
- Monitor: resolution at least 1024 × 768 pixels, 16 or 32 bit color depth
- Sun JVM installed
- Intranet or Internet network access

The Web browser must be configured to enable Cookies to be set from the IP address of the unit.

In Windows Vista, deactivate protected mode on the **Security** tab under **Internet Options**.

Read the information in the **System Requirements** document on the product DVD supplied and, if necessary, install the required programs and controls.

To play back live video images, an appropriate ActiveX must be installed on the computer. If necessary, the required software and controls can be installed from the product DVD provided.

- a. Insert the mini-DVD into the DVD-ROM drive of the computer. If the DVD does not start automatically, open the root directory of the DVD in Windows Explorer and double click **MPEGAx.exe**.
- b. Follow the on-screen instructions.

7.2 Establishing the connection

The camera must be assigned a valid IP address to operate on your network. The default address pre-set at the factory is 192.168.0.1

1. Start the Web browser.
2. Enter the IP address of the camera as the URL.

Note:

If the connection is not established, the maximum number of possible connections may already have been reached.

Depending on the device and network configuration, up to 25 web browsers, or 50 VIDOS or Bosch VMS connections are supported.

7.2.1 Password protection in camera

A camera offers the option of limiting access across various authorization levels. If the camera is password-protected, a message to enter the password appears.

1. Enter the user name and the associated password in the appropriate fields.
2. Click **OK**. If the password is correct, the desired page is displayed.

7.3 Protected network

If a Radius server is used for network access control (802.1x authentication), the camera must be configured first. To configure the camera for a Radius network, connect it directly to a PC via a crossed network cable and configure the two parameters, **Identity** and **Password**. Only after these have been configured can communication with the camera via the network occur.

7.4 Connecting to a hardware decoder

A compatible H.264 hardware decoder with a monitor can be connected to the camera using an Ethernet network connection. Cameras are designed to automatically connect with other BVIP devices with the correct configuration. The units only need to be part of the same closed network. In this way it is possible to cover large distances with little installation or cabling effort.

7.4.1 Alarm connection

With the appropriate configuration, a connection between camera and decoder is established automatically when an alarm is triggered. After a short time, the live video image from the transmitter is shown on the connected monitor. In this case, no computer is needed to establish the connection

Note:

Make sure the devices are configured for the network environment and that the correct IP address for the remote location is set on the Alarm connections configuration page.

7.5 Connection established

When a connection is established, the **LIVEPAGE** is initially displayed. The application title bar displays three items: **LIVEPAGE**, **RECORDINGS**, **SETTINGS**.

Note:

The **RECORDINGS** link is only visible if a storage medium is available.

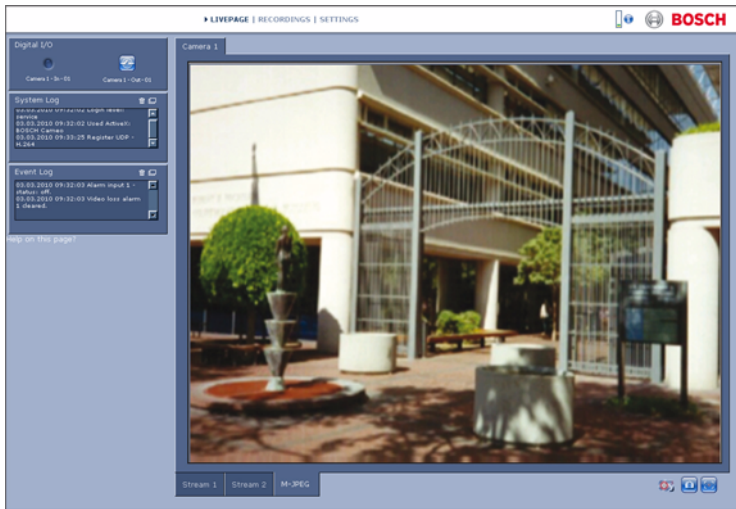

Figure 7.1 Livepage

7.5.1 LIVEPAGE

The **LIVEPAGE** is used to display and control the video stream. Refer to *Section 10 Operation via the browser*, page 114 for more information.

7.5.2 RECORDINGS

Click **RECORDINGS** in the application title bar to open the playback page. Refer to *Section 10 Operation via the browser*, page 114 for more information.

7.5.3 SETTINGS

Click **SETTINGS** in the application title bar to configure the camera and the application interface. A new page containing

the configuration menu is opened. All settings are stored in the camera memory so that they are retained, even if the power is interrupted.

Changes that influence the fundamental functioning of the unit (for example, firmware updates) can only be made using the configuration menu.

The configuration menu tree allows all parameters of the unit to be configured. The configuration menu is divided into **Basic Mode** and **Advanced Mode**.

Refer to *Section 8 Basic Mode, page 48* for more information on basic settings; refer to *Section 9 Advanced Mode, page 53* for more information on advanced settings.

Note:

It is recommended that only expert users or system administrators use the **Advanced Mode**.

8 Basic Mode

8.1 Basic Mode menu tree

The basic mode configuration menu allows a set of basic camera parameters to be configured.

Basic Mode	
>	Device Access
>	Date/Time
>	Network
>	Encoder Profile
>	Audio
>	Recording
>	System Overview

To view the current settings:

1. If necessary, click the Basic Mode menu to expand it. The sub-menus are displayed.
2. Click a sub-menu. The corresponding page is opened.

The settings are changed by entering new values or by selecting a pre-defined value in a list field.

Saving changes

After making changes in a window, click **Set** to send the new settings to the device and save them there.

Clicking **Set** saves only the settings in the current window.

Changes in any other windows are ignored.

Click **SETTINGS** in the applications title bar to close the window without saving the changes.

Note:

Device time settings are lost after 1 hour without power if no central time server is selected.

Note:

When entering names do not use any special characters, for example **&**. Special characters are not supported by the internal recording management system.

8.2 Device Access

8.2.1 Camera name

Assign a name to assist in identification. This name simplifies the management of multiple devices in more extensive systems. The name is used for remote identification, for example, in the event of an alarm. Enter a name that makes it as easy as possible to identify the location unambiguously.

8.2.2 Password

A password prevents unauthorized access to the device. The device recognizes three authorization levels: **service**, **user**, and **live**.

- **service** is the highest authorization level. Entering the correct password gives access to all the functions of the camera and allows all configuration settings to be changed.
- **user** is the middle authorization level. This user can operate the device, play back recordings, and also control a camera but cannot change the configuration.
- **live** is the lowest authorization level. It can only be used to view the live video image and switch between the different live image displays.

Use the various authorization levels to limit access. Proper password protection is only guaranteed if all higher authorization levels are also protected with a password. For example, if a **live** password is assigned, a **service** and a **user** password should also be set. When assigning passwords, always start from the highest authorization level, **service**, and use different passwords.

Password

Define and change a separate password for each level while logged in as **service** or if the device is not protected by a password. Enter the password for the selected level.

Confirm password

Re-enter the new password to ensure that there are no typing mistakes.

The new password is only saved after clicking **Set**. Therefore, click **Set** immediately after entering and confirming the password, even if assigning a password at another level.

8.3 Date/Time

Device date, time and zone

If there are multiple devices operating in the system or network, it is important to synchronize their internal clocks. For example, it is only possible to identify and correctly evaluate simultaneous recordings when all devices are operating on the same time.

As the device time is controlled by the internal clock, it is not necessary to enter the day or date of the week. These are set automatically. The time zone in which the system is located is also set automatically.

1. Click **Sync to PC** to apply the system time from your computer to the device.

Time server IP address

The camera can receive the time signal from a time server using various time server protocols and then use it to set the internal clock. The device polls the time signal automatically once every minute. Enter the IP address of a time server.

Time server type

Select the protocol that is supported by the selected time server. It is recommended to select the **SNTP server** protocol. This protocol provides high accuracy and is required for special applications and future function extensions. Select **Time server** if the server uses the RFC 868 protocol.

Note:

It is important to ensure that the date/time is correct for recording. An incorrect date/time setting could prevent correct recording.

8.4 Network

Use the settings on this page to integrate the device into a network. Some changes only take effect after a reboot. In this case, the **Set** button changes to **Set and Reboot**.

1. Make the desired changes.
2. Click **Set and Reboot**.
 - The device is rebooted and the changed settings are activated. If the IP address, subnet mask, or gateway address is changed, then the device is only available under the new addresses after the reboot.

DHCP

If the network has a DHCP server for dynamic IP address allocation, set this parameter to **On** to activate the automatic acceptance of DHCP-assigned IP addresses.

Note:

Certain applications (for example, Bosch Video Management System) use the IP address for the unique assignment of the device. If using these applications, the DHCP server must support the fixed assignment between IP address and MAC address, and must be appropriately set up so that, once an IP address is assigned, it is retained each time the system is rebooted.

IP address

Enter the desired IP address for the camera. The IP address must be valid for the network.

Subnet mask

Enter the appropriate subnet mask for the set IP address.

Gateway address

Enter the IP address of the gateway to establish a connection to a remote location in a different subnet. Otherwise, this field can remain empty (0.0.0.0).

8.5 Encoder Profile

Select a profile for encoding the video signal. Pre-programmed profiles are available that give priority to different parameters. When a profile is selected, its details are displayed.

8.6 Audio

Switch the camera audio **On** or **Off**. Adjust the input and output levels with the sliders.

8.7 Recording

Record the images from the camera to a storage medium. For long-term authoritative images, it is essential to use a Divar 700 Series Digital Video Recorder or an appropriately sized iSCSI system.

8.7.1 Storage medium

1. Select the required storage medium from the list.
2. Click **Start** to start recording or **Stop** to end recording.

8.8 System Overview

This page provides general information on the hardware and firmware system, including version numbers. No items can be changed on this page but they can be copied for information purposes when troubleshooting.

9 Advanced Mode

9.1 Advanced Mode menu tree

The advanced mode configuration menu contains all camera parameters that can be configured.

Advanced Mode	
>	General
>	Web Interface
>	Encoder
>	Camera
>	Recording
>	Alarm
>	Interfaces
>	Network
>	Service

To view the current settings:

1. Click the **Advanced Mode** menu to expand it. The associated menu sub-headings are displayed.
2. Click a menu sub-heading to expand it.
3. Click a sub-menu. The corresponding page is opened.

The settings are changed by entering new values or by selecting a pre-defined value in a list field.

Saving changes

After making changes in a window, click **Set** to send the new settings to the device and save them there.

Clicking **Set** saves only the settings in the current window.

Changes in any other windows are ignored.

Click **SETTINGS** in the applications title bar to close the window without saving the changes made.

Note:

Device time settings are lost after 1 hour without power if no central time server is selected.

Note:

When entering names do not use any special characters, for example **&**. Special characters are not supported by the internal recording management system.

9.2 General

General	
>	Identification
>	Password
>	Date/Time
>	Display Stamping

9.2.1 Identification

Camera ID

Each device should be assigned a unique identifier that can be entered here as an additional means of identification.

Camera name

Assign a name to assist in identification. This name simplifies the management of multiple devices in more extensive systems. The name is used for remote identification, for example, in the event of an alarm. Enter a name that makes it as easy as possible to identify the location unambiguously.

Initiator extension

Add text to an initiator name to make identification easier in large iSCSI systems. This text is added to the initiator name, separated from it by a full stop.

9.2.2 Password

A password prevents unauthorized access to the device. The device recognizes three authorization levels: **service**, **user**, and **live**.

- **service** is the highest authorization level. Entering the correct password gives access to all the functions of the camera and allows all configuration settings to be changed.
- **user** is the middle authorization level. This user can operate the device, play back recordings, and also control a camera but cannot change the configuration.

- **live** is the lowest authorization level. It can only be used to view the live video image and switch between the different live image displays.

Use the various authorization levels to limit access. Proper password protection is only guaranteed if all higher authorization levels are also protected with a password. For example, if a **live** password is assigned, a **service** and a **user** password should also be set. When assigning passwords, always start from the highest authorization level, **service**, and use different passwords.

Password

Define and change a separate password for each level while logged in as **service** or if the device is not protected by a password. Enter the password for the selected level.

Confirm password

Re-enter the new password to ensure that there are no typing mistakes.

The new password is only saved after clicking **Set**. Therefore, click **Set** immediately after entering and confirming the password, even if assigning a password at another level.

9.2.3 Date/Time

Date format

Select the required date format.

Device date / Device time

If there are multiple devices operating in your system or network, it is important to synchronize their internal clocks. For example, it is only possible to identify and correctly evaluate simultaneous recordings when all devices are operating on the same time.

1. Enter the current date. Since the device time is controlled by the internal clock, it is not necessary to enter the day of the week – it is added automatically.

2. Enter the current time or click **Sync to PC** to apply the system time from your computer to the device.

Note:

It is important to ensure that the date/time is correct for recording. An incorrect date/time setting could prevent correct recording.

Device time zone

Select the time zone in which the system is located.

Daylight saving time

The internal clock can switch automatically between normal and daylight saving time (DST). The device already contains the data for DST switch-overs up to the year 2015. Use this data or create alternative time saving data, if required.

Note:

If a table is not created, there is no automatic switching. When editing the table, note that values occur in linked pairs (DST start and end dates).

First, check the time zone setting. If it is not correct, select the appropriate time zone for the system:

1. Click **Set**.
2. Click **Details**. A new window opens showing an empty table.
3. Click **Generate** to fill the table with the preset values from the camera.
4. Select the region or the city which is closest to the system's location from the list box below the table.
5. Click one of the entries in the table to make changes. The entry is highlighted.
6. Click **Delete** to remove the entry from the table.
7. Choose other values from the list boxes under the table, to change the selected entry. Changes are immediate.
8. If there are empty lines at the bottom of the table, for example after deletions, add new data by marking the row and selecting values from the list boxes.

9. When finished, click **OK** to save and activate the table.

Time server IP address

The camera can receive the time signal from a time server using various time server protocols and then use it to set the internal clock. The device polls the time signal automatically once every minute. Enter the IP address of a time server.

Time server type

Select the protocol that is supported by the selected time server. It is recommended to select the **SNTP server** protocol. This protocol provides high accuracy and is required for special applications and future function extensions. Select **Time server** if the server uses the RFC 868 protocol.

9.2.4 Display Stamping

Various overlays or stamps in the video image provide important supplementary information. These overlays can be enabled individually and arranged on the image in a clear manner.

Camera name stamping

This field sets the position of the camera name overlay. It can be displayed at the **Top**, at the **Bottom**, or at a position of choice using the **Custom** option, or it can be set to **Off** for no overlay information.

If the **Custom** option is selected, enter values in the X and Y position fields.

Time stamping

This field sets the position of the time and date overlay. It can be displayed at the **Top**, at the **Bottom**, or at a position of choice using the **Custom** option, or it can be set to **Off** for no overlay information.

If the **Custom** option is selected, enter values in the X and Y position fields.

Display milliseconds

If necessary, display milliseconds for Time stamping. This information can be useful for recorded video images; however,

it does increase the processor's computing time. Select **Off** if displaying milliseconds is not needed.

Alarm mode stamping

Select **On** for a text message to be overlaid in the event of an alarm. It can be displayed at a position of choice using the **Custom** option, or it can be set to **Off** for no overlay information.

If the **Custom** option is selected, enter values in the X and Y position fields.

Alarm message

Enter the message to be displayed on the image in the event of an alarm. The maximum text length is 31 characters.

Video watermarking

Select **On** for the transmitted video images to be watermarked. After activation, all images are marked with a green **W**. A red **W** indicates that the sequence (live or saved) has been manipulated.

9.3 Web Interface

Web Interface	
>	Appearance
>	LIVEPAGE Functions
>	Logging

9.3.1 Appearance

Adapt the appearance of the web interface and change the website language to meet your requirements. If necessary, replace the company's logo (top right) and the device name (top left) in the top part of the window with individual graphics. Either GIF or JPEG images can be used. The file paths must correspond to the access mode (for example, C:\Images\Logo.gif for access to local files or <http://www.myhostname.com/images/logo.gif> for access via the Internet/Intranet). For access via the Internet/Intranet, there must be a connection in order to display the image. The image files are not stored on the camera.

To restore the original graphics, delete the entries in the Company logo and Device logo fields.

Website language

Select the language for the user interface here.

Company logo

Enter the path to a suitable image in this field. The image can be stored on a local computer, a local network, or at an Internet address.

Device logo

Enter the path for a suitable image for the device logo in this field. The image can be stored on a local computer, a local network, or at an Internet address.

JPEG interval

Specify the interval at which the individual images should be generated for the M-JPEG image on the **Livepage**.

9.3.2 LIVEPAGE Functions

In this window, adapt the **Livepage** functions to meet your requirements. Choose from a variety of different options for displaying information and controls.

1. Mark the check boxes for the functions to be displayed on the **Livepage**. The selected elements are checked.
2. Check the **Livepage** to see how the desired items are available.

Transmit audio

When selected, the audio from the camera (if on) is sent to the computer.

Show alarm inputs

The alarm inputs are displayed next to the video image as icons along with their assigned names. If an alarm is active, the corresponding icon changes color.

Show relay outputs

The relay output is shown next to the video image as an icon along with its assigned name. If a relay is switched, the icon changes color.

Show VCA trajectories

The trajectories (motion lines of objects) from the video content analysis are displayed in the live video image if a corresponding analysis type is activated.

Show VCA metadata

When video content analysis (VCA) is activated, additional information is displayed in the live video stream. For example, in **Motion+** mode, the sensor areas for motion detection are marked.

Show event log

The event messages are displayed with the date and time in a field next to the video image.

Show system log

The system messages are displayed with the date and time in a field next to the video image and provide information about the establishment and termination of connections, etc.

Allow snapshots

Specify whether the icon for saving individual images should be displayed below the live image. Individual images can only be saved if this icon is visible.

Allow local recording

Specify whether the icon for saving video sequences on the local memory should be displayed below the live image. Video sequences can only be saved if this icon is visible.

Path for JPEG and video files

Enter the path for the storage location of individual images and video sequences saved from the **Livepage**. If necessary, click **Browse** to find a suitable folder.

9.3.3 Logging

Save event log

Select this option to save event messages in a text file on the local computer. This file can be viewed, edited, and printed with any text editor or standard office software.

File for event log

Enter the path for saving the event log here. If necessary, click **Browse** to find a suitable folder.

Save system log

Select this option to save system messages in a text file on the local computer. This file can be viewed, edited, and printed with any text editor or standard office software.

File for system log

Enter the path for saving the system log here. If necessary, click **Browse** to find a suitable folder.

9.4 Encoder

Encoder	
>	Privacy Masks
>	Encoder Profile
>	Encoder Streams
>	Audio

9.4.1 Privacy Masks

Four privacy mask areas can be defined. The activated masked areas are filled with the selected pattern in live view.

1. Select the pattern to be used for all masks (Gray).
2. Check the box of the mask you wish to activate.
3. Use the mouse to define the area for each of the masks.

9.4.2 Encoder Profile

Adapt the video data transmission to the operating environment (network structure, bandwidth, data structures). The camera simultaneously generates two H.264 video streams and an M-JPEG stream (Tri-streaming). Select the compression settings of these streams individually, for example, one setting for transmissions to the Internet and one for LAN connections. The settings are made individually for each stream.

Define profiles

Eight definable profiles are available. The pre-programmed profiles give priority to different parameters.

- **High resolution 1**
High resolution (4CIF/D1) for high bandwidth connections
- **High resolution 2**
High resolution (4CIF/D1) with lower data rate
- **Low bandwidth**
High resolution (4CIF/D1) for low bandwidth connections
- **DSL**
High resolution (4CIF/D1) for DSL connections at 500 kbps maximum

- **ISDN (2B)**
CIF resolution for ISDN connections at 100 kbps maximum
- **ISDN (1B)**
CIF resolution for ISDN connections at 50 kbps maximum
- **MODEM**
CIF resolution for analog modem connections at 22 kbps maximum
- **GSM**
CIF resolution for GSM connections

Profile Configuration

Profiles can be configured for use with the H.264 settings of encoder streams. Select a profile by clicking the appropriate tab. Change the name of a profile and individual parameter values within a profile.

Profiles are rather complex. They include a number of parameters that interact with one another, so it is generally best to use the default profiles. Only change a profile if completely familiar with all the configuration options. The parameters as a group constitute a profile and are dependent on one another. If a setting outside the permitted range for a parameter is entered, the nearest valid value is substituted when the settings are saved.

Profile name

Enter a new name for the profile here.

Target data rate

To optimize utilization of the bandwidth in the network, limit the data rate for the camera. The target data rate should be set according to the desired picture quality for typical scenes with no excessive motion.

For complex images or frequent changes of image content due to frequent movements, this limit can temporarily be exceeded up to the value entered in the **Maximum data rate** field.

Maximum data rate

This maximum data rate is not exceeded under any circumstances. Depending on the video quality settings for the

I-frames and P-frames, this can result in individual images being skipped.

The value entered here must be at least 10% higher than the value entered in the **Target data rate** field. If the value entered here is too low, it is automatically adjusted.

Encoding interval

The **Encoding interval** slider determines the interval at which images are encoded and transmitted. This can be particularly advantageous with low bandwidths. The image rate in ips (images per second) is displayed next to the slider.

Video resolution

Select the desired resolution for the video image. The following resolutions are available:

- **CIF**
352 × 288/240 pixels
- **4CIF/D1**
704 × 576/480 pixels

Expert Settings

if necessary, use the expert settings to adapt the I-frame quality and the P-frame quality to specific requirements. The setting is based on the H.264 quantization parameter (QP).

I-frame quality

This setting adjusts the image quality of the I-frames. The basic setting **Auto** automatically adjusts the quality to the settings for the P-frame video quality. Alternatively, use the slider to set a value between 9 and 51. The value **9** represents the best image quality with, if necessary, a lower frame refresh rate depending on the settings for the maximum data rate. A value of **51** results in a very high refresh rate and lower image quality.

P-frame quality

This setting adjusts the maximum image quality of the P-frames. The basic setting **Auto** automatically adjusts to the optimum combination of movement and image definition (focus). Alternatively, use the slider to set a value between 9 and 51.

The value **9** represents the best image quality with, if necessary, a lower frame refresh rate depending on the settings for the maximum data rate. A value of **51** results in a very high refresh rate and lower image quality.

Default

Click **Default** to return the profile to the factory default values.

9.4.3 Encoder Streams

Select H.264 Settings

- Select the codec algorithm for streams 1 and 2. The following algorithms are available
 - H.264 BP+ (HW decoder)**
 - H.264 MP Low Latency**
- Select the default profile for streams 1 and 2 from the eight profiles that have been defined.

The algorithm properties have the following settings:

	H.264 BP+ (HW decoder)	H.264 MP Low Latency
CABAC	off	on
CAVLC	on	off
GOP structure	IP	IP
I-frame distance	15	30
Deblocking filter	on	on
Recommended for	Hardware decoders, Divar 700 Series	Software decoders, PTZ and rapid image movements

Preview >>

Previews of streams 1 and 2 can be shown.

- Click **Preview >>** to display a preview of the video for streams 1 and 2. the current profile is shown above the preview.
- Click **1:1 Live View** below a preview to open a viewing window for that stream. Various additional items of information are shown across the top of the window.
- Click **Preview <<** to close the preview displays.

Note:

Deactivate the display of the video images if the performance of the computer is adversely affected by the decoding of the data stream.

JPEG stream

Set the parameters for the M-JPEG stream.

- Select the **Max. frame rate** in images per second (IPS).
- The **Picture quality** slider allows adjustment of the M-JPEG image quality from **Low** to **High**.

Note:

The JPEG resolution follows the highest resolution setting either in stream 1 or stream 2. For example, if stream 1 is **4CIF/D1** and stream 2 is CIF, the JPEG resolution will be **4CIF/D1**.

9.5 Audio

Switch the camera audio **On** or **Off**. Adjust the input and output levels with the sliders.

Note:

The audio signals are sent in a separate data stream parallel to the video data, and so increase the network load. The audio data requires an additional bandwidth of approximately 80 kbps for each connection. If you do not want any audio data to be transmitted, select **Off**.

9.6 Camera

Camera	
>	Mode
>	ALC
>	Shutter/AGC
>	Day/night
>	Enhance
>	Color
>	Installer Options

If the camera is in monochrome mode, all color-related menu items are disabled and cannot be accessed.

9.6.1 Mode

Pre-defined modes

The camera has six pre-programmed operating modes that can be selected in the **Mode** menu.

The modes are defined as follows:

1. **24-hour**
Default installation mode to provide stable pictures over a 24-hour period. These settings are optimized for out-of-the-box installation.
2. **Traffic**
Capture high-speed objects using default shutter in variable lighting conditions.
3. **Low light**
Provide extra enhancement, such as AGC and SensUp to make usable pictures in low-light conditions.
4. **Smart BLC**
Settings optimized to capture details in high contrast and extremely bright-dark conditions.

5. **Low noise**

Enhancements are set to reduce picture noise. Useful for conditional refresh DVR and IP storage systems because reducing noise reduces the amount of storage required.

6. **Infrared**

Use this mode if the camera is viewing a scene lit by infrared light.

These modes are pre-programmed by default but can be adjusted according to personal preferences. The Mode menu allows selection and set-up of picture enhancement functions for each mode. If the changes are not satisfactory, restore the default values for the mode.

Mode ID

Enter a name for the selected mode.

Copy mode to

Select a mode to copy the current mode to.

Restore Mode Defaults

Click to restore the factory defaults. A confirmation screen appears. Allow 5 seconds for the camera to optimize the picture after a mode reset.

9.6.2 **ALC**

ALC level

Adjust the video output level (-15 to 0 to +15).

Select the range within which the ALC will operate. A positive value is more useful for low-light conditions; a negative value is more useful for very bright conditions.

Some ALC adjustment may improve scene content when Smart/BLC is enabled.

Peak average

Adjust the balance between peak and average video control (-15 to 0 to +15). At -15 the camera controls the average video level, at +15 the camera controls the peak video level.

A negative value gives more priority to average light levels; a positive value gives more priority to peak light levels. Video iris lens: choose an average level for best results (peak settings may cause oscillations).

Speed

Adjust the speed of the video level control loop (Slow, Medium, or Fast). For most scenes it should remain at the default value.

9.6.3 Shutter/AGC

Shutter

- **Fixed** – allows a user-defined shutter speed.
- **AES** (auto-shutter) – the camera automatically sets the optimum shutter speed. The camera tries to maintain the selected default shutter speed as long as the light level of the scene permits.
- **FL** – flickerless mode avoids interference from light sources (recommended for use with video iris or DC iris lenses only).

Default shutter / Fixed shutter

Select the shutter speed (1/60 [1/50], 1/100, 1/120, 1/250, 1/500, 1/1000, 1/2000, 1/5000, 1/10K) for the default (AES) or fixed value.

In AES mode, the camera tries to maintain the selected shutter speed as long as the light level of the scene is high enough.

In Fixed mode, select the shutter speed.

Actual shutter

Displays the actual shutter value from the camera to help compare lighting levels and optimum shutter speed during set-up.

Sensitivity up

Selects the factor by which the sensitivity of the camera is increased (OFF, 2x, 3x, etc. to a maximum of 10x).

Note:

If Sensitivity up is active, some noise or spots may appear in the picture. This is normal camera behavior. Sensitivity up may cause some motion blur on moving objects.

Gain

AGC - the camera automatically sets the gain to the lowest possible value needed to maintain a good picture.

Fixed - sets Fixed gain value.

Maximum gain / Fixed gain

Selects the maximum value the gain can have during AGC operation (0 to 30 dB).

Selects the gain setting for Fixed gain operation (0 is no gain).

Actual gain

Displays the actual AGC value from the camera to help compare gain level with lighting levels and picture performance.

9.6.4

Day/night

The Day/Night camera is equipped with a motorized IR (infrared) filter. The IR filter can be removed in low-light or IR-illuminated applications. There are four different methods of switching:

- via the alarm input,
- as part of the programmable mode profile,
- automatically, based on the observed light levels, or
- via the settings page.

Day/night

Auto - the camera switches the IR cut-off filter on and off depending on the scene illumination level.

Monochrome - the IR cut-off filter is removed, giving full IR sensitivity.

Color - the camera always produces a color signal regardless of light levels.

Switch level

Set the video **Switch level** at which the camera in Auto mode switches to monochrome operation (-15 to 0 to +15).

A low (negative) value means that the camera switches to monochrome at a lower light level. A high (positive) value means that the camera switches to monochrome at a higher light level.

Priority

In Auto switching mode, set the camera priority to either:

- **Color:** the camera gives color pictures as long as the light level permits.
- **Motion:** the camera gives sharp images without motion blur as long as the light level permits (it switches to monochrome earlier than it would with Color priority).

The camera recognizes IR-illuminated scenes to prevent unwanted switching to color mode.

IR contrast

There are two modes for IR contrast:

- **Enhanced:** the camera optimizes contrast in applications with high IR illumination levels. Select this mode for IR (730 to 940 nm) light sources and for scenes with grass and green foliage.
- **Normal:** the camera optimizes contrast in mono applications with visible light illumination.

Color burst

- **Off:** the color burst in the video signal is switched Off in monochrome mode.
- **On:** the color burst remains active even in monochrome mode (required by some DVRs and IP encoders).

9.6.5 Enhance

Dynamic engine

- **Off:** turns off all automatic scene detail and enhancements (only recommended for testing).
- **XF Dynamic:** extra internal processing is enabled for low-light applications (traffic, etc.).
- **2X Dynamic:** 2X Dynamic adds dual sensor exposure to the XF Dynamic features. In harsh lighting conditions pixels

from each exposure are mixed to give a more detailed image (use 2X Dynamic when SmartBLC is not required).

- **Smart BLC:** BLC window and weighting factor are automatically defined. Camera dynamically adjusts these for changing light conditions. Includes all the benefits of 2X Dynamic.

Auto black

Auto black ON automatically increases the visibility of details even when scene contrast is less than full-range due to mist, fog, etc.

Sharpness level

Adjusts the black level between -15 and +15. Zero position of slider corresponds to the factory default black level.

A low (negative) value makes the picture less sharp. Increasing sharpness brings out more detail. Extra sharpness can enhance the details of license plates, facial features and the edges of certain surfaces.

Dynamic noise reduction

In AUTO mode the camera automatically reduces the noise in the picture. This may cause some motion blur on exceptionally fast moving objects immediately in front of the camera. This can be corrected by widening the field of view or selecting Off.

Peak white invert

Use Peak white invert to reduce glare from the CRT/LCD display.

Use in ANPR/LPR applications to reduce headlight glare. (Test on-site to ensure that it does benefit the application and is not distracting for operators.)

9.6.6 Color

White balance

- **ATW:** Auto tracking white balance allows the camera to continually adjust for optimal color reproduction.
- **AWB hold:** Puts ATW on hold and saves the color settings.

- In **Manual** mode the Red, Green, and Blue gain can be manually set to a desired position.

Speed

Adjust the speed (**Fast**, **Medium** or **Slow**) of the white balance control loop.

R-gain

Offsets factory white point alignment (reducing red introduces more cyan).

ATW and AWBhold (-5 to +5): adjusts the Red gain to optimize the white point.

Manual (-50 to +50): adjusts the Red gain.

B-gain

Offsets factory white point alignment (reducing blue introduces more yellow).

ATW and AWBhold (-5 to +5): adjusts the B gain to optimize the white point.

Manual (-50 to +50): adjusts the Blue gain.

G-gain

Manual (-50 to +50): adjusts the Green gain.

It is only necessary to change the white point offset for special scene conditions.

Saturation

Adjusts the color saturation; -15 gives a monochrome image.

9.6.7 Installer Options

Synchronization

Select the **Synchronization** method for the camera:

- **Line lock** to lock to the power supply frequency;
- **Internal** for free running camera operation.

Ticker bar

Switches a ticker bar on the live image on or off.

Camera buttons

Disable the **Camera buttons** on the camera to prevent unauthorized change of the camera settings.

Camera LED

Disable the **Camera LED** on the camera to switch it off.

Show test pattern

Select **On** to show a video test signal.

Pattern

Select the desired test pattern to help with installation and fault-finding.

Restore all defaults

Click **Restore all defaults** to restore the factory defaults for the camera. A confirmation screen appears. Allow 5 seconds for the camera to optimize the picture after a mode reset.

Note:

The default IP address is restored. Connect to the camera again using this address.

9.7 Recording

Recording	
>	Storage Management
>	Recording Profiles
>	Retention Time
>	Recording Scheduler
>	Recording Status

Record the images from the camera to an appropriately configured iSCSI system. For long-term authoritative images use an appropriately sized iSCSI system.

A Video Recording Manager (**VRM**) can control all recording when accessing an iSCSI system. The VRM is an external program for configuring recording tasks for video servers. For further information, contact your local customer service at Bosch Security Systems.

9.7.1 Storage Management

Device manager

If the **VRM** option is activated, the VRM Video Recording Manager manages all recording and no further settings can be configured here.

Note:

Activating or deactivating VRM causes the current settings to be lost; they can only be restored through reconfiguration.

Recording media

Select the required recording media to activate them and then configure the recording parameters.

iSCSI Media

If an **iSCSI system** is selected as the storage medium, a connection to the desired iSCSI system is needed to set the configuration parameters.

The storage system selected must be available on the network and completely set up. Amongst other things, it must have an IP address and be divided into logical drives (LUN).

1. Enter the IP address of the required iSCSI destination in the **iSCSI IP address** field.
2. If the iSCSI destination is password protected, enter this into the **Password** field.
3. Click the **Read** button. The connection to the IP address is established. The **Storage overview** field displays the logical drives.

Activating and Configuring Storage Media

The storage overview displays the available storage media. Select individual media or iSCSI drives and transfer these to the **Managed storage media** list. Activate the storage media in this list and configure them for storage.

Note:

Each storage medium can only be associated with one user. If a storage medium is already being used by another user, decouple the user and connect the drive to the camera. Before decoupling, make absolutely sure that the previous user no longer needs the storage medium.

1. In the **Storage overview** section, double-click the required storage medium, an iSCSI LUN or one of the other available drives. The medium is then added to the **Managed storage media** list. Newly added media is indicated in the **Status** column by the status **Not active**.
2. Click **Set** to activate all media in the **Managed storage media** list. These are indicated in the **Status** column by the status **Online**.
3. Check the box in the **Rec. 1** or **Rec. 2** column to specify which data stream should be recorded on the storage media selected. **Rec. 1** stores stream 1, **Rec. 2** stores stream 2.
4. Check the boxes for the **Overwrite older recordings** option to specify which older recordings can be

overwritten once the available memory capacity has been used. **Recording 1** corresponds to stream 1, **Recording 2** corresponds to stream 2.

Note:

If older recordings are not allowed to be overwritten when the available memory capacity has been used, the recording in question is stopped. Specify limitations for overwriting old recordings by configuring the retention time.

Formatting Storage Media

Delete all recordings on a storage medium at any time. Check the recordings before deleting and back up important sequences on the computer's hard drive.

1. Click a storage medium in the **Managed storage media** list to select it.
2. Click **Edit** below the list. A new window opens.
3. Click **Formatting** to delete all recordings in the storage medium.
4. Click **OK** to close the window.

Deactivating Storage Media

Deactivate any storage medium from the **Managed storage media** list. It is then no longer used for recordings.

1. Click a storage medium in the **Managed storage media** list to select it.
2. Click **Remove** below the list. The storage medium is deactivated and removed from the list.

9.7.2 Recording Profiles

Define up to ten different recording profiles here, then assign these to individual days or times of day on the **Recording Scheduler** page. Modify the names of the recording profiles on the tabs in the **Recording Scheduler** page.

1. Click a tab to edit the corresponding profile.
2. If necessary, click **Default** to return all settings to their defaults.
3. Click **Copy Settings** to copy the currently visible settings to other profiles. A window opens to select the target profiles for the copied settings.
4. For each profile, click **Set** to save.

Stream profile settings

Select the profile setting that is to be used for each data stream when recording. This selection is independent of the selection for live data stream transmission. (The properties of the profiles are defined on the **Encoder Profile** page.)

Recording includes

Specify whether, in addition to video data, audio or metadata (for example alarms or VCA data) should also be recorded. Including metadata could make subsequent searches of recordings easier but it requires additional memory capacity. Without metadata, it is not possible to include video content analysis in recordings.

Standard recording

Select the mode for standard recordings:

- **Continuous:** the recording proceeds continuously. If the maximum memory capacity is reached, older recordings will automatically be overwritten.
- **Pre-alarm:** recording takes place in the pre-alarm time, during the alarm and during the post-alarm time only.
- **Off:** no automatic recording takes place.

Stream

Select the data stream to be used for standard recordings. (You can select the data stream for alarm recordings separately and independently of this setting.)

Alarm recording

Select the **Pre-alarm time** from the list box.

Select the **Post-alarm time** from the list box.

Select the **Alarm stream** to use for alarm recording. The encoding interval for alarm recording can be selected from the predefined profiles.

Alarm triggers

Select the alarm type (**Alarm input/ Motion/Audio alarm / Video loss alarm**) that is to trigger a recording. Select the **Virtual alarm** sensors that are to trigger a recording, via RCP+ commands or alarm scripts, for example.

9.7.3

Retention Time

Specify the retention times for recordings. If the available memory capacity of a medium has been used, older recordings are only overwritten if the retention time entered here has expired.

Make sure that the retention time corresponds with the available memory capacity. A rule of thumb for the memory requirement is as follows: 1 GB per hour retention time with 4CIF for complete frame rate and high image quality.

Enter the required retention time in hours or days for each recording. **Recording 1** corresponds to Stream 1, **Recording 2** corresponds to Stream 2.

9.7.4 Recording Scheduler

The recording scheduler allows you to link the created recording profiles to the days and times at which the camera's images are to be recorded in the event of an alarm. Schedules can be defined for weekdays and for holidays.

Weekdays

Assign as many time periods (in 15-minute intervals) as needed for any day of the week. Move the mouse cursor over the table – the time is displayed.

1. Click the profile to be assigned in the **Time periods** box.
2. Click a field in the table and, while holding down the left mouse button, drag the cursor across all of the fields to be assigned to the selected profile.
3. Use the right mouse button to deselect any of the intervals.
4. Click **Select All** to select all of the intervals to be assigned to the selected profile.
5. Click **Clear All** to deselect all of the intervals.
6. When finished, click **Set** to save the settings to the device.

Holidays

Define holidays whose settings will override the settings for the normal weekly schedule.

1. Click the **Holidays** tab. Days that have already been defined are shown in the table.
2. Click **Add**. A new window opens.
3. Select the desired date from the calendar. Drag the mouse to select a range of dates. These are handled as a single entry in the table.
4. Click **OK** to accept the selection(s). The window closes.
5. Assign the defined holidays to the recording profile as described above.

Delete user-defined holidays at any time.

1. Click **Delete** in the **Holidays** tab. A new window opens.
2. Click the date to be deleted.
3. Click **OK**. The selection is removed from the table and the window is closed.
4. Repeat for any other dates to be deleted.

Profile names

Change the names of the recording profiles listed in the Time periods box.

1. Click a profile.
2. Click **Rename**.
3. Enter the new name and click **Rename** again.

Activate recording

After completing configuration, activate the recording schedule and start recording. Once activated, the **Recording Profiles** and the **Recording Scheduler** are deactivated and the configuration cannot be modified. Terminate recording at any time to modify the configuration.

1. Click **Start** to activate the recording schedule.
2. Click **Stop** to deactivate the recording schedule.
Recordings that are currently running are interrupted and the configuration can be modified.

Recording status

The graphic indicates the recording activity. An animated graphic is seen when recording is taking place.

9.7.5 Recording Status

Details of the recording status are displayed here for information. These settings cannot be changed.

9.8 Alarm

Alarm	
>	Alarm Connections
>	VCA
>	Audio Alarm
>	Alarm E-Mail
>	Alarm Task Editor

9.8.1 Alarm Connections

Select the response of the camera when an alarm occurs. In the event of an alarm, the device can automatically connect to a pre-defined IP address. The device can contact up to ten IP addresses in the order listed until a connection is established.

Connect on alarm

Select **On** so that the camera automatically connects to a pre-defined IP address in the event of an alarm. Select **Follows input 1** so that the device maintains the connection for as long as an alarm exists.

Number of destination IP address

Specify the numbers of the IP addresses to be contacted in the event of an alarm. The device contacts the remote locations one after the other in the numbered sequence until a connection is made.

Destination IP address

For each number, enter the corresponding IP address for the desired remote station.

Destination password

If the remote station is password protected, enter the password here.

Only ten passwords can be defined here. Define a general password if more than ten connections are required, for example, when connections are initiated by a controlling

system such as VIDOS or Bosch Video Management System. The camera connects to all remote stations protected by the same general password. To define a general password:

1. Select 10 in the **Number of destination IP address** list box.
2. Enter 0.0.0.0 in the **Destination IP address** field.
3. Enter the password in the **Destination password** field.
4. Set the user password of all the remote stations to be accessed using this password.

Setting destination 10 to the IP-address 0.0.0.0 overrides its function as the tenth address to try.

Video transmission

If the device is operated behind a firewall, select **TCP (HTTP port)** as the transfer protocol. For use in a local network, select **UDP**.

Please note that in some circumstances, in the event of an alarm, a larger bandwidth must be available on the network for additional video images (if Multicast operation is not possible). To enable Multicast operation, select the **UDP** option for the **Video transmission** parameter here and on the **Network** page.

Remote port

Select a browser port, depending on the network configuration. The ports for HTTPS connections are only available if the **On** option in **SSL encryption** is selected.

Video output

If it is known which device is being used as the receiver, select the analog video output to which the signal should be switched. If the destination device is unknown, it is advisable to select the **First available** option. In this case, the image is placed on the first free video output. This is an output on which there is no signal. The connected monitor only displays images when an alarm is triggered. If a particular video output is selected and a split image is set for this output on the receiver, select the decoder from **Decoder** in the receiver that is to be used to display the alarm image. Refer to the destination device

documentation concerning image display options and available video outputs.

Decoder

Select a decoder of the receiver to display the alarm image. The decoder selected has an impact on the position of the image in a split screen.

SSL encryption

SSL encryption protects data used for establishing a connection, such as the password. By selecting **On**, only encrypted ports are available for the **Remote port** parameter. SSL encryption must be activated and configured on both sides of a connection. The appropriate certificates must also have been uploaded. Configure and activate encryption for media data (video, metadata) on the **Encryption** page.

Auto-connect

Select **On** to automatically re-established a connection to one of the previously specified IP addresses after each reboot, connection breakdown, or network failure.

Audio

Select **On** to transmit the audio stream with an alarm connection.

9.8.2 Video Content Analyses (VCA)

The camera has integrated VCA which can detect and analyze changes in the signal using image processing algorithms. Such changes can be due to movements in the camera's field of view. Select various VCA configurations and adapt these to your application, as required. The **Silent MOTION+** configuration is active by default. In this configuration, metadata is created to facilitate searches of recordings, however, no alarm is triggered.

1. Select a VCA configuration and make the required settings.
2. If necessary, click the **Default** button to return all settings to their default values.

Note:

If there is not enough computing power, priority is given to live images and recordings. This can lead to impairment of the VCA system. Observe the processor load and optimize the encoder settings or the VCA settings if necessary, or turn off VCA completely.

9.8.3 VCA configuration- Profiles

Configure two profiles with different VCA configurations. Save profiles on your computer's hard drive and load saved profiles from there. This can be useful if testing a number of different configurations. Save a functioning configuration and test new settings. Use the saved configuration to restore the original settings at any time.

1. Select a VCA profile and enter the required settings.
2. If necessary, click **Default** to return all settings to default values.
3. Click the **Save...** to save the profile settings to another file. A new window opens in which to specify the file name and where to save it.
4. Click **Load...** to load a saved profile. A new window opens in which to select the profile file and specify where to save the file.

To rename a profile:

1. To rename the file, click the icon to the right of the list field and enter the new profile name in the field.
2. Click the icon again. The new profile name is saved.

The current alarm status is displayed for information purposes.

Aggregation time (s)

Set an aggregation time of between 0 and 20 seconds. The aggregation time always starts when an alarm event occurs. It extends the alarm event by the value set. This prevents alarm events that occur in quick succession from triggering several alarms and successive events in a rapid sequence. No further alarm is triggered during the aggregation time.

The post-alarm time set for alarm recordings only starts once the aggregation time has expired.

Analysis type

Select the required analysis algorithm. By default, only **Motion+** is available – this offers a motion detector and essential recognition of tampering.

Metadata is always created for a video content analysis, unless this was explicitly excluded. Depending on the analysis type selected and the relevant configuration, additional information overlays the video image in the preview window next to the parameter settings. With the **Motion+** analysis type, for example, the sensor fields in which motion is recorded are marked with rectangles.

Note:

Additional analysis algorithms with comprehensive functions, such as IVMD and IVA, are available from Bosch Security Systems.

Motion detector

Motion detection is available for the **Motion+** analysis type. For the detector to function, the following conditions must be met:

- Analysis must be activated.
- At least one sensor field must be activated.
- The individual parameters must be configured to suit the operating environment and the desired responses.
- The sensitivity must be set to a value greater than zero.

Note:

Reflections of light (from glass surfaces, etc.), lights switching on and off, or changes in the light level caused by cloud movement on a sunny day can trigger unintended responses from the motion detector and generate false alarms. Run a series of tests at different times of the day and night to ensure that the video sensor is operating as intended. For indoor surveillance, ensure constant lighting of the areas during the day and at night.

Sensitivity

Sensitivity is available for the **Motion+** analysis type. The basic sensitivity of the motion detector can be adjusted for the environmental conditions to which the camera is subject. The sensor reacts to variations in the brightness of the video image. The darker the observation area, the higher the value that must be selected.

Minimum object size

Specify the number of sensor fields that a moving object must cover to generate an alarm. This setting prevents objects that are too small from triggering an alarm. A minimum value of 4 is recommended. This value corresponds to four sensor fields.

Debounce time 1 s

The debounce time prevents very brief alarm events from triggering individual alarms. If the **Debounce time 1 s** option is activated, an alarm event must last at least 1 second to trigger an alarm.

Selecting the area

Select the areas of the image to be monitored by the motion detector. The video image is subdivided into square sensor fields. Activate or deactivate each of these fields individually. To exclude particular regions of the camera's field of view from monitoring due to continuous movement (by a tree in the wind, for example), the relevant fields can be deactivated.

1. Click **Select Area** to configure the sensor fields. A new window opens.
2. If necessary, click **Clear All** first to clear the current selection (fields marked red).
3. Left-click the fields to be activated. Activated fields are marked red.
4. If necessary, click **Select All** to select the entire video-frame for monitoring.
5. Right-click any fields to deactivate.
6. Click **OK** to save the configuration.
7. Click the close button (**X**) in the window title bar to close the window without saving the changes.

Tamper detection

Detect tampering of cameras and video cables by means of various options. Run a series of tests at different times of the day and night to ensure that the video sensor is operating as intended.

Sensitivity and **Trigger delay (s)** can only be changed if **Reference check** is selected.

Sensitivity

The basic sensitivity of the tamper detection can be adjusted for the environmental conditions to which the camera is subject. The algorithm reacts to the differences between the reference image and the current video image. The darker the observation area, the higher the value that must be selected.

Trigger delay (s)

Set delayed alarm triggering here. The alarm is only triggered after a set time interval in seconds has elapsed and then only if the triggering condition still exists. If the original condition has been restored before this time interval elapses, the alarm is not triggered. This avoids false alarms triggered by short-term changes, for example, cleaning activities in the direct field of vision of the camera.

Global change (slider)

Set how large the global change in the video image must be for an alarm to be triggered. This setting is independent of the sensor fields selected under **Select Area**. Set a high value if fewer sensor fields need to change to trigger an alarm. With a low value, it is necessary for changes to occur simultaneously in a large number of sensor fields to trigger an alarm. This option allows detection, independently of motion alarms, manipulation of the orientation or location of a camera resulting from turning the camera mount bracket, for example.

Global change

Activate this function if the global change, as set with the Global change slide control, should trigger an alarm.

Scene too bright

Activate this function if tampering associated with exposure to extreme light (for instance, shining a flashlight directly on the objective) should trigger an alarm. The average brightness of the scene provides a basis for recognition.

Scene too dark

Activate this function if tampering associated with covering the objective (for instance, by spraying paint on it) should trigger an alarm. The average brightness of the scene provides a basis for recognition.

Scene too noisy

Activate this function if tampering associated with EMC interference (noisy scene as the result of a strong interference signal in the vicinity of the video lines) should trigger an alarm.

Reference check

Save a reference image that can be continuously compared with the current video image. If the current video image in the marked areas differs from the reference image, an alarm is triggered. This detects tampering that would otherwise not be detected, for example, if the camera is turned.

1. Click **Reference** to save the currently visible video- image as a reference.
2. Click **Select Area** and select the areas in the reference image that are to be monitored.
3. Check the box **Reference check** to activate the on-going check. The stored reference image is displayed in black and white below the current video image, and the selected areas are marked in yellow.
4. Select the **Disappearing edges** or **Appearing edges** option to specify the reference check once again.

Disappearing edges

The area selected in the reference image should contain a prominent structure. If this structure is concealed or moved, the reference check triggers an alarm. If the selected area is too homogenous, so that concealing and moving the structure would not trigger an alarm, then an alarm is triggered immediately to indicate the inadequate reference image.

Appearing edges

Select this option if the selected area of the reference image includes a largely homogenous surface. If structures appear in this area, then an alarm is triggered.

Selecting the area

Select the image areas in the reference image that are to be monitored. The video image is subdivided into square fields. Activate or deactivate each of these fields individually. Select only those areas for reference monitoring in which no movement takes place and that are always evenly lit, as false alarms could otherwise be triggered.

1. Click **Select Area** to configure the sensor fields. A new window opens.
2. If necessary, click **Clear All** first to clear the current selection (fields marked yellow).
3. Left-click the fields to be activated. Activated fields are marked yellow.
4. If necessary, click **Select All** to select the entire video-frame for monitoring.
5. Right-click any fields to deactivate.
6. Click **OK** to save the configuration.
7. Click the close button (**X**) in the window title bar to close the window without saving the changes.

9.8.4 VCA configuration - Scheduled

A scheduled configuration allows you to link a VCA profile with the days and times at which the video content analysis is to be active. Schedules can be defined for weekdays and for holidays.

Weekdays

Link any number of 15-minute intervals with the VCA profiles for each day of the week. Moving the mouse cursor over the table displays the time below it. This aids orientation.

1. Click the profile to link in the **Time periods** field.
2. Click in a field in the table, hold down the mouse button and drag the cursor over all the periods to be assigned to the selected profile.
3. Use the right mouse button to deselect any of the intervals.
4. Click **Select All** to link all time intervals to the selected profile.
5. Click **Clear All** to deselect all of the intervals.
6. When finished, click **Set** to save the settings in the device.

Holidays

Define holidays on which a profile should be active that are different to the standard weekly schedule.

1. Click the **Holidays** tab. Any days that have already been selected are shown in the table.
2. Click **Add**. A new window opens.
3. Select the desired date from the calendar. Select several consecutive calendar days by holding down the mouse button. These will later be displayed as a single entry in the table.
4. Click **OK** to accept the selection. The window closes.
5. Assign the individual holidays to the VCA profiles, as described above.

Deleting Holidays

Delete defined holidays at any time:

1. Click **Delete**. A new window opens.
2. Click the date to delete.

3. Click **OK**. The item is deleted from the table and the window closes.
4. The process must be repeated for deleting additional days.

9.8.5 VCA configuration - Event triggered

This configuration allows you to stipulate that the video content analysis is only to be activated when triggered by an event. As long as no trigger is activated, the **Silent MOTION+** configuration in which metadata is created is active; this metadata facilitates searches of recordings, but does not trigger an alarm.

Trigger

Select a physical alarm or a virtual alarm as a trigger. A virtual alarm is created using software, with RCP+ commands or alarm scripts, for example.

Trigger active

Select the VCA configuration here that is to be enabled via an active trigger. A green check mark to the right of the list field indicates that the trigger is active.

Trigger inactive

Select the VCA configuration here that is to be activated if the trigger is not active. A green check mark to the right of the list field indicates that the trigger is inactive.

Delay (s)

Select the delay period for the reaction of the video content analysis to trigger signals. The alarm is only triggered after a set time interval in seconds has elapsed and then only if the triggering condition still exists. If the original condition has been restored before this time interval elapses, the alarm is not triggered. A delay period may be useful in avoiding false alarms or frequent triggering. During the delay period, the **Silent MOTION+** configuration is always enabled.

9.8.6 Audio Alarm

Create alarms based on audio signals. Configure signal strengths and frequency ranges so that false alarms, for example, machine noise or background noise, are avoided. Set up normal audio transmission before configuring the audio alarm.

Audio alarm

Select **On** for the device to generate audio alarms.

Name

The name makes it easier to identify the alarm in extensive video monitoring systems, for example with the VIDOS and Bosch Video Management System programs. Enter a unique and clear name here.

Signal Ranges

Exclude particular signal ranges in order to avoid false alarms. For this reason the total signal is divided into 13 tonal ranges (mel scale). Check or uncheck the boxes below the graphic to include or exclude individual ranges.

Threshold

Set up the threshold on the basis of the signal visible in the graphic Set the threshold using the slide control or, alternatively, move the white line directly in the graphic using the mouse.

Sensitivity

Use this setting to adapt the sensitivity to the sound environment and effectively suppress individual signal peaks. A high value represents a high level of sensitivity.

9.8.7 Alarm E-Mail

As an alternative to automatic connecting, alarm states can also be documented by e-mail. This makes it possible to notify a recipient who does not have a video receiver. In this case, the camera automatically sends an e-mail to a user-defined e-mail address.

Send alarm e-mail

Select **On** for the device to automatically send an alarm e-mail in the event of an alarm.

Mail server IP address

Enter the IP address of a mail server that operates on the SMTP standard (Simple Mail Transfer Protocol). Outgoing e-mails are sent to the mail server via the address entered. Otherwise, leave the box blank (0.0.0.0).

SMTP user name

Enter a registered user name for the chosen mail server.

SMTP password

Enter the required password for the registered user name.

Format

Select the data format of the alarm message.

- **Standard (with JPEG):** e-mail with JPEG image file attachment.
- **SMS:** e-mail in SMS format to an e-mail-to-SMS gateway (for example, to send an alarm by cellphone) without an image attachment.

When a cellphone is used as the receiver, make sure to activate the e-mail or SMS function, depending on the format, so that these messages can be received. Obtain information on operating your cellphone from your cellphone provider.

Attach JPEG from camera

Check the box to specify that JPEG images are sent from the camera.

Destination address

Enter the e-mail address for alarm e-mails here. The maximum address length is 49 characters.

Sender name

Enter a unique name for the e-mail sender, for example, the location of the device. This makes it easier to identify the origin of the e-mail.

Test e-mail

Click **Send Now** to test the e-mail function. An alarm e-mail is immediately created and sent.

9.8.8 Alarm Task Editor

Editing scripts on this page overwrites all settings and entries on the other alarm pages. This procedure cannot be reversed. To edit this page, you should have programming knowledge and be familiar with the information in the **Alarm Task Script Language** document and the English language. The document can be found on the product DVD supplied.

As an alternative to the alarm settings on the various alarm pages, enter the desired alarm functions in script form here. This will overwrite all settings and entries on the other alarm pages.

1. Click **Examples** under the **Alarm Task Editor** field to see some script examples. A new window opens.
2. Enter new scripts in the **Alarm Task Editor** field or change existing scripts in line with your requirements.
3. When finished, click **Set** to transmit the scripts to the device. If the transfer was successful, the message **Script successfully parsed.** is displayed over the text field. If it was not successful, an error message is displayed with further information.

9.9 Interfaces

Interfaces	
>	Alarm input
>	Relay
>	COM1

9.9.1 Alarm input

Configure the alarm triggers for the camera.

Select **N.C.** (Normally Closed) if the alarm is to be triggered by closing the contact.

Select **N.O.** (Normally Open) if the alarm is to be triggered by opening the contact.

Name

Enter a name for the alarm input. This is then displayed below the icon for the alarm input on the **LIVEPAGE** (if configured).

Action

Select the camera mode to switch to when alarm input 1 is triggered. See *Section 9.8.8 Alarm Task Editor, page 100*, for information on alarm actions based on alarm inputs.

9.9.2 Relay

Configure the switching behavior of the relay output.

Select different events that automatically activate an output. For example, turn on a floodlight by triggering a motion alarm and then turn the light off again when the alarm has stopped.

Idle state

Select **Open** for the relay to operate as an N.O. contact, or select **Closed** if the relay is to operate as an N.C. contact.

Select

Select **External device** or **Motion+/IVA** to trigger the relay.

Relay name

The relay can be assigned a name here. The name is shown on the button next to **Trigger relay**. The **LIVEPAGE** can also be configured to display the name next to the relay icon.

Trigger relay

Click the button to switch the relay manually (for example, for testing purposes or to operate a door opener).

9.9.3**COM1**

Configure the data connector for the camera.

Serial port function

Select a controllable unit from the list. If you wish to use the serial port to transmit transparent data, select **Transparent**. Select **Terminal** if you wish to operate the unit from a terminal. After selecting a unit, the remaining parameters in the window are set automatically and should not be changed.

Camera ID

If necessary, enter the ID of the peripheral you wish to control (for example a dome camera or pan/tilt head).

Baud rate

Select the value for the transmission rate in bps.

Data bits

The number of data bits per character cannot be changed.

Stop bits

Select the number of stop bits per character.

Parity check

Select the type of parity check.

Interface mode

Select the desired protocol for the serial interface.

9.10 Network

Network	
>	Network
>	Advanced
>	Multicasting
>	JPEG Posting
>	Encryption

9.10.1 Network

The settings on this page are used to integrate the device into a network. Some changes only take effect after a reboot. In this case **Set** changes to **Set and Reboot**.

1. Make the desired changes.
2. Click **Set and Reboot**.

The device is rebooted and the changed settings are activated. If the IP address, subnet mask, or gateway address is changed, then the device is only available under the new addresses after the reboot.

Automatic IP assignment

If a DHCP server is employed in the network for the dynamic assignment of IP addresses, activate acceptance of IP addresses automatically assigned to the device. Certain applications (VIDOS, Bosch Video Management System, Archive Player, Configuration Manager) use the IP address for the unique assignment of the device. If using these applications, the DHCP server must support the fixed assignment between IP address and MAC address, and must be appropriately set up so that, once an IP address is assigned, it is retained each time the system is rebooted.

IP address

Enter the desired IP address for the camera. The IP address must be valid for the network.

Subnet mask

Enter the appropriate subnet mask for the set IP address.

Gateway address

For the device to establish a connection to a remote location in a different subnet, enter the IP address of the gateway here. Otherwise, this field can remain empty (0.0.0.0).

DNS server address

The device is easier to access if it is listed on a DNS server. For example, to establish an Internet connection to the camera, it is sufficient to enter the name given to the device on the DNS server as a URL in the browser. Enter the DNS server's IP address. Servers are supported for secure and dynamic DNS.

Details >>**Video transmission**

If the device is used behind a firewall, TCP (Port 80) should be selected as the transmission protocol. For use in a local network, choose UDP.

Multicast operation is only possible with the UDP protocol. The TCP protocol does not support multicast connections. The MTU value in UDP mode is 1514 bytes.

HTTP browser port

Select a different HTTP browser port from the list if required. The default HTTP port is 80. To limit connection to HTTPS, deactivate the HTTP port. To do this, activate the **Off** option.

HTTPS browser port

To limit browser access to encrypted connections, choose an HTTPS port from the list. The standard HTTPS port is 443. Select the **Off** option to deactivate HTTPS ports and limit connections to unencrypted ports.

The camera uses the TLS 1.0 protocol. Ensure that the browser has been configured to support this protocol. Also ensure that Java application support is activated (in the Java Plug-in Control Panel of the Windows Control Panel).

To limit connections to SSL encryption, set the **Off** option in the HTTP browser port, the RCP+ port, and Telnet support. This deactivates all unencrypted connections allowing connections on the HTTPS port only.

Configure and activate encryption for media data (video, audio, metadata) on the **Encryption** page.

RCP+ port 1756

Activating RCP+ port 1756 allows unencrypted connections on this port. To allow only encrypted connections, set the **Off** option to deactivate the port.

Telnet support

Activating Telenet support allows unencrypted connections on this port. To allow only encrypted connections, set the **Off** option to deactivate telnet support, making telnet connections impossible.

Interface mode ETH

If necessary, select the Ethernet link type for interface **ETH**. Depending on the device connected, it may be necessary to select a special operation type.

Network MSS (Byte)

Set the maximum segment size for the IP packet's user data here. This gives the option to adjust the size of the data packets to the network environment and to optimize data transmission. Please comply with the MTU value of 1,514 bytes in UDP mode.

iSCSI MSS (Byte)

Specify a higher MSS value for a connection to the iSCSI system than for the other data traffic via the network. The potential value depends on the network structure. A higher value is only useful if the iSCSI system is located in the same subnet as the camera.

Enable DynDNS

DynDNS.org is a DNS hosting service that stores IP addresses in a database ready for use. It allows selecting the device via the Internet using a host name, without having to know the current IP address of the device. Enable this service here. To do this, obtain an account with DynDNS.org and register the required host name for the device on that site.

Note:

Information about the service, registration process and available host names can be found at DynDNS.org.

Host name

Enter the host name registered on DynDNS.org for the device here.

User name

Enter the user name registered at DynDNS.org here.

Password

Enter the password registered at DynDNS.org here.

Force registration now

Force the registration by transferring the IP address to the DynDNS server. Entries that change frequently are not provided in the Domain Name System. It is a good idea to force the registration when setting up the device for the first time. Only use this function when necessary and no more than once a day, to avoid the possibility of being blocked by the service provider. To transfer the IP address of the device, click the **Register** button.

Status

The status of the DynDNS function is displayed here for information purposes; these settings cannot be changed.

9.10.2 Advanced

The settings on this page are used to set advanced settings the network. Some changes only take effect after a reboot. In this case **Set** changes to **Set and Reboot**.

1. Make the desired changes.
2. Click **Set and Reboot**.

The device is rebooted and the changed settings are activated.

SNMP

The camera supports the SNMP V2 (Simple Network Management Protocol) for managing and monitoring network components, and can send SNMP messages (traps) to IP addresses. It supports SNMP MIB II in the unified code.

If **On** is selected for the SNMP parameter and a SNMP host address is not entered, the device does not send the traps automatically and will only reply to SNMP requests. If one or two SNMP host addresses are entered, SNMP traps are sent automatically. Select **Off** to deactivate the SNMP function.

1. SNMP host address / 2. SNMP host address

To send SNMP traps automatically, enter the IP addresses of one or two target devices here.

SNMP traps

To choose which traps are sent:

1. Click **Select**. A dialog box appears.
2. Click the check boxes of the appropriate traps.
3. Click **Set** to close the window and send all of the checked traps.

Authentication (802.1x)

To configure Radius server authentication, connect the camera directly to a computer using a network cable. If a Radius server controls access rights over the network, select **On** to activate authentication to communicate with the device.

1. Enter the user name that the Radius server uses for the camera in the **Identity** field.
2. Enter the **Password** that the Radius server expects from the camera.

RTSP port

If necessary, select a different port for the exchange of the RTSP data from the list. The standard RTSP port is 554. Select **Off** to deactivate the RTSP function.

9.10.3 Multicasting

In addition to a one-to-one connection between a camera and a single receiver (unicast), the camera can enable multiple receivers to receive the video signal simultaneously. This is either done by duplicating the data stream in the device and then distributing it to multiple receivers (multi-unicast), or by distributing an individual data stream in the network itself to multiple receivers in a defined group (multicast). Enter a dedicated multicast address and port for each stream. Then switch between the streams by clicking the associated tabs. The prerequisite for multicast operation is a multicast-capable network that uses the UDP and IGMP protocols. Other group membership protocols are not supported. The TCP protocol does not support multicast connections.

A special IP address (class D address) must be configured for multicast operation in a multicast-enabled network. The network must support group IP addresses and the Internet Group Management Protocol (IGMP V2). The address range is from 225.0.0.0 to 239.255.255.255. The multicast address can be the same for multiple streams. However, it is then necessary to use a different port in each case so that multiple data streams are not sent simultaneously using the same port and multicast address. The settings must be made individually for each stream.

Enable

Enable simultaneous data reception on several receivers that need to activate the multicast function. To do this, check the box and then enter the multicast address.

Multicast Address

Enter a valid multicast address to be operated in multicast mode (duplication of the data stream in the network). With the

setting 0.0.0.0 the encoder for the stream operates in multi-unicast mode (copying of data stream in device). The camera supports multi-unicast connections for up to five simultaneously-connected receivers.

Duplication of data places a heavy demand on the CPU and can lead to impairment of the image quality under certain circumstances.

Port

Enter the port address for the stream here.

Streaming

Click the checkbox to activate multicast streaming mode. An activated stream is marked with a check. (Streaming is typically not required for standard multicast operation.)

Multicast packet TTL

A value can be entered to specify how long the multicast data packets are active on the network. If multicast is to be run via a router, the value must be greater than 1.

9.10.4 JPEG Posting

Save individual JPEG images on an FTP server at specific intervals. If required, retrieve these images at a later date to reconstruct alarm events. JPEG resolution corresponds to the highest setting from the two data streams.

File name

Select how file names are created for the individual images that are transmitted.

- **Overwrite:** The same file name is always used and any existing file will be overwritten by the current file.
- **Increment:** A number from 000 to 255 is added to the file name and automatically incremented by 1. When it reaches 255, it starts again from 000.
- **Date/time suffix:** The date and time are automatically added to the file name. When setting this parameter, ensure that the date and time of the device are always set

correctly . For example, the file snap011005_114530.jpg was stored on October 1, 2005 at 11.45 and 30 seconds.

Posting interval

Enter the interval in seconds at which the images are sent to an FTP server. Enter zero for no images to be sent.

FTP server IP address

Enter the IP address of the FTP server on which to save the JPEG images.

FTP server login

Enter your login name for the FTP server.

FTP server password

Enter the password that gives access to the FTP server.

Path on FTP server

Enter an exact path to post the images on the FTP server.

9.10.5**Encryption**

If an encryption license is installed, this submenu gives access to the encryption parameters.

9.11 Service

Service	
>	Maintenance
>	Licenses
>	System Overview

9.11.1 Maintenance

CAUTION!



Before starting a firmware update, make sure to select the correct upload file. Uploading the wrong files can result in the device no longer being addressable, requiring it to be replaced. Do not interrupt the firmware installation. Even changing to another page or closing the browser window leads to interruption. Interruption may lead to faulty coding of the Flash memory. This can result in the device no longer being addressable, requiring it to be replaced.

Firmware

The camera functions and parameters can be updated by uploading new firmware. To do this, the latest firmware package is transferred to the device via the network. The firmware is installed there automatically. Thus, a camera can be serviced and updated remotely without requiring a technician to make changes to the device on site. The latest firmware can be obtained from your customer service center or from the Bosch Security Systems download area.

To update the firmware:

1. First, store the firmware file on your hard disk.
2. Enter the full path for the firmware file in the field or click **Browse** to locate and select the file.
3. Click **Upload** to begin transferring the file to the device. The progress bar allows monitoring of the transfer.

The new firmware is unpacked and the Flash memory is reprogrammed. The time remaining is shown by the message **going to reset Reconnecting in ... seconds**. When the upload is completed successfully, the device reboots automatically. If the operating status LED lights up red, the upload has failed and must be repeated. To perform the upload, switch to a special page:

1. In the address bar of your browser, enter /main.htm after the device IP address, for example:
192.168.0.10/main.htm
2. Repeat the upload.

Configuration

Save configuration data for the camera to a computer and load saved configuration data from a computer to the device.

To save the camera settings:

1. Click **Download**; a dialog box appears.
2. Follow the instructions to save the current settings.

To load configuration data from the computer to the device:

1. Enter the full path of the file to upload or click **Browse** to select the desired file.
2. Make certain that the file to be loaded comes from the same device type as the device to be reconfigured.
3. Click **Upload** to begin transmission to the device. The progress bar allows monitoring of the transfer.

Once the upload is complete, the new configuration is activated. The time remaining is shown by the message **going to reset Reconnecting in ... seconds**. When the upload is completed successfully, the device reboots automatically.

SSL certificate

To work with an SSL connection, both sides of the connection must have the appropriate certificates. Upload one or more certificate files, one at a time, to the camera.

1. Enter the full path of the file to upload or click **Browse** to locate the file.
2. Click **Upload** to start the file transfer.

Once all files have been successfully uploaded, the device must be rebooted. In the address field of the browser, enter `/reset` after the camera's IP address, for example:

192.168.0.10/reset

The new SSL certificate is valid.

Maintenance log

Download an internal maintenance log from the device to send it to Customer Service for support purposes. Click **Download** and select a storage location for the file.

9.11.2 Licenses

This window is for the activation of additional functions by entering activation codes. An overview of installed licenses is shown.

9.11.3 System Overview

This window is for information only and cannot be modified. Keep this information at hand when seeking technical support. Select the text on this page with a mouse and copy it so that it can be pasted into an e-mail if required.

10 Operation via the browser

10.1 Livepage

After the connection is established, the **Livepage** is initially displayed. It shows the live video image on the right of the browser window. Depending on the configuration, various text overlays may be visible on the live video image. Other information may also be shown next to the live video image on the **Livepage**. The display depends on the settings on the **LIVEPAGE Functions** page.

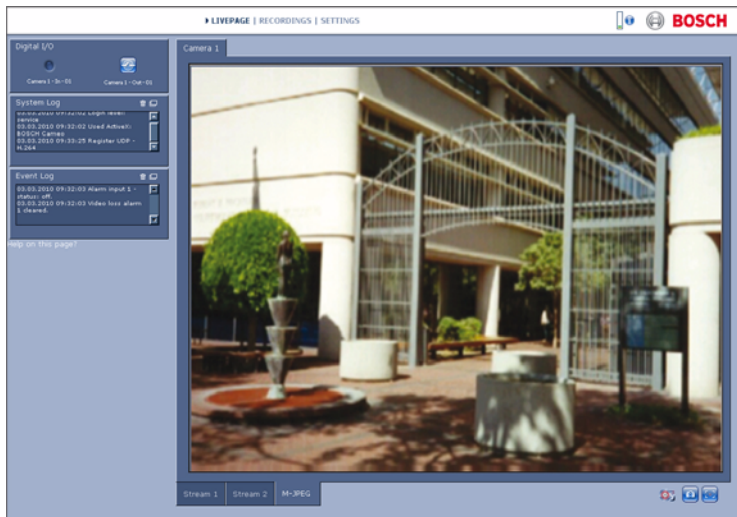

Figure 10.1 Livepage

10.1.1 Processor load

When accessing the camera with a browser, the processor load and network information is available in the upper right of the window next to the Bosch logo.



Move the mouse cursor over the icons to display numerical values. This information can help with problem solving or when fine tuning the device.

10.1.2 Image selection

View the image on a full screen.

- Click the **Stream 1**, **Stream 2** or **M-JPEG** tab below the video image to switch between the different displays for the camera image.

10.1.3 View Control

If the data port is set-up to control a PTZ device, a View Control tab is shown and activated. Use the controls to position the camera and to adjust zoom, focus and iris. Six pre-set positions can be defined and selected.

Move the mouse cursor over the video image; additional options for controlling peripherals are displayed with the mouse cursor.

10.1.4 Digital I/O

Depending on the configuration of the unit, the alarm input and the relay output are displayed next to the camera image. The alarm symbol is for information and indicates the input status of the alarm input: Active 1 = Symbol lights, Active 0 = Symbol not lit.

The relay on the camera allows the operation of a device (for example, a light or a door opener).

- To operate, click the relay symbol. The symbol is red when the relay is activated.

10.1.5 System Log / Event Log

The **System Log** field contains information about the operating status of the camera and the connection. These messages can be saved automatically in a file. Events such as the triggering or end of alarms are shown in the **Event Log** field. These messages can be saved automatically in a file.

To delete the entries from the fields, click the icon in the top right-hand corner of the relevant field.

10.1.6 Saving snapshots

Individual images from the video sequence that is currently being shown on the **Livepage** can be saved in JPEG format on the computer's hard drive.

- Click the camera icon  to save single images.

The storage location depends on the configuration of the camera.

10.1.7 Recording video sequences

Sections of the video sequence that is currently being shown on the **Livepage** can be saved on the computer's hard drive. The sequences are recorded at the resolution specified in the encoder configuration. The storage location depends on the configuration of the camera.

1. Click the recording icon  to record video sequences.
 - Saving begins immediately. The red dot on the icon indicates that a recording is in progress.
2. Click the recording icon again to stop recording.

Play back saved video sequences using the Player from Bosch Security Systems.

10.1.8 Running recording program

The hard drive icon below the camera images on the **Livepage** changes during an automatic recording.

The icon lights up and displays a moving graphic  to indicate a running recording. If no recording is taking place, a static icon is displayed.

10.1.9 Audio communication

Audio can be sent and received via the **Livepage** if the active monitor and the remote station of the camera support audio.

1. Press and hold the F12 key to send an audio signal to the camera.
2. Release the key to stop sending audio.

All connected users receive audio signals sent from the camera but only the user who first pressed the F12 key can send audio signals; others must wait for the first user to release the key.

10.2 Recordings page

Access the **Recordings** page for playing back recorded video sequences from the **Livepage** as well as from the **Settings** menu. The **Recordings** link is only visible if a storage medium has been selected.

1. Click **Recordings** in the navigation bar in the upper section of the window. The playback page appears and playback begins immediately.
2. Select **Recording 1** or **2** in the drop-down menu. (The contents for 1 and 2 are identical, only the quality and location may be different.)

10.2.1 Controlling playback



A time bar below the video image allows quick orientation. The time interval associated with the sequence is displayed in the bar in gray. A green arrow above the bar indicates the position of the image currently being played back within the sequence.

The time bar offers various options for navigation in and between sequences.

- Change the time interval displayed by clicking the plus or minus icons. The display can span a range from two months to a few seconds.
- If required, drag the green arrow to the point in time at which the playback should begin.
- Red bars indicate the points in time where alarms were triggered. Drag the green arrow to navigate to these points quickly.

Control playback by means of the buttons below the video image. The buttons have the following functions:



Start/Pause playback



Jump to start of active sequence or to previous sequence



Jump to start of the next video sequence in the list

Slide control

Continuously select playback speed by means of the speed regulator:



Bookmarks

In addition, set markers in the sequences, so-called bookmarks, and jump directly to these. These bookmarks are indicated as small yellow arrows above the time interval. Use the bookmarks as follows:



Jump to the previous bookmark



Set bookmark



Jump to the following bookmark

Bookmarks are only valid while in the Recordings page; they are not saved with the sequences. All bookmarks are deleted when you leave the page.

Trick mode

View recordings frame by frame in trick mode by using a mouse with a scroll wheel. To do this, place the mouse cursor in the timeline below the timescale and turn the scroll wheel. Playback is automatically stopped (paused) during scrolling. Trick mode requires significantly higher memory capacity and computing power.

11 Troubleshooting

11.1 Function test

The camera offers a variety of configuration options. Therefore, check that it works properly after installation and configuration. This is the only way to ensure that the camera will function as intended in the event of an alarm.

Your check should include the following functions:

- Can the camera be called up remotely?
- Does the camera transmit all the data required?
- Does the camera respond as desired to alarm events?
- Is it possible to control peripheral devices, if necessary?

11.2 Resolving problems

The following table is intended to help identify the causes of malfunctions and correct them where possible.

Malfunction	Possible causes	Solution
No image transmission to remote location.	Defective camera.	Connect a local monitor to the camera and check the camera function.
	Faulty cable connections.	Check all cables, plugs, contacts and connections.
	Incorrect encoder stream property set for connection to hardware decoder.	Select the H.264 BP+ (HW decoder) option on the Encoder Streams configuration page.
No connection established, no image transmission.	The unit's configuration.	Check all configuration parameters.
	Faulty installation.	Check all cables, plugs, contacts and connections.
	Wrong IP address.	Check the IP addresses (terminal program).
	Faulty data transmission within the LAN.	Check the data transmission with ping.
	The maximum number of connections has been reached.	Wait until there is a free connection and call the transmitter again.

Malfunction	Possible causes	Solution
No audio transmission to remote station.	Hardware fault.	Check that all connected audio units are operating correctly.
	Faulty cable connections.	Check all cables, plugs, contacts and connections.
	Incorrect configuration.	Check audio parameters on the Audio configuration and LIVEPAGE Functions pages.
	The audio voice connection is already in use by another receiver.	Wait until the connection is free and then call the sender again.
The unit does not report an alarm.	Alarm source is not selected.	Select possible alarm sources on the Alarm sources configuration page.
	No alarm response specified.	Specify the desired alarm response on the Alarm connections configuration page; if necessary change the IP address.
Control of cameras or other units is not possible.	The cable connection between the serial interface and the connected unit is not correct.	Check all cable connections and ensure all plugs are properly fitted.
	The interface parameters do not match those of the other unit connected.	Make sure that the settings of all units involved are compatible.

Malfunction	Possible causes	Solution
The unit is not operational after a firmware upload.	Power failure during programming by firmware file.	Have the unit checked by Customer Service and replace if necessary.
	Incorrect firmware file.	Enter the IP address of the unit followed by / main.htm in your Web browser and repeat the upload.
Placeholder with a red cross instead of the ActiveX components.	JVM not installed on your computer or not activated.	Install Sun JVM from the product CD.
Web browser contains empty fields.	Active proxy server in network.	Create a rule in the local computer's proxy settings to exclude local IP addresses.
The POWER LED flashes red.	Firmware upload failed.	Repeat firmware upload.

11.3 Customer service

If a fault cannot be resolved, please contact your supplier or system integrator, or go directly to Bosch Security Systems Customer Service.

The version numbers of the internal processors can be viewed on a special page. Please note this information before contacting Customer Service.

1. In the address bar of your browser, after the unit IP address, enter: `/version`
for example: `192.168.0.80/version`
2. Write down the information or print out the page.

12 Maintenance

12.1 Testing the network connection

The ping command can be used to check the connection between two IP addresses. This allows testing whether a device is active in the network.

1. Open the DOS command prompt.
2. Type ping followed by the IP address of the device.

If the device is found, the response appears as " Reply from ... ", followed by the number of bytes sent and the transmission time in milliseconds. Otherwise, the device cannot be accessed via the network. This might be because:

- The device is not properly connected to the network.
Check the cable connections in this case.
- The device is not correctly integrated into the network.
Check the IP address, subnet mask, and gateway address.

12.2 Communication with Terminal Program

Data Terminal

If a camera cannot be found in the network or the connection to the network is interrupted, you can connect a data terminal to the camera for initial setup and for setting important parameters. The data terminal consists of a computer with a terminal program.

You require a serial transmission cable with a 9-pin Sub-D plug to connect to the computer.

HyperTerminal, a communications accessory included with Microsoft Windows, can be used as the terminal program.

1. Disconnect the camera from the Ethernet network before working with the terminal program.
2. Connect the serial interface of the camera using any available serial interface on the computer.

Configuring the Terminal

Before the terminal program can communicate with the camera, the transmission parameters must be matched. Make the following settings for the terminal program:

- 19,200 bps
- 8 data bits
- No parity check
- 1 stop bit
- No protocol

Command Inputs

After the connection has been established, you must log on to the camera to access the main menu. Other submenus and functions can be accessed using the on-screen commands.

1. If necessary, turn off the local echo so that entered values are not repeated on the display.
2. Enter one command at a time.
3. When you have entered a value, such as the IP address, check the characters you have entered before pressing Enter to transfer the values to the camera.

Assigning an IP Address

Before you can operate a camera in your network you must first assign it an IP address that is valid for your network.

The following default address is preset at the factory:

192.168.0.1

1. Start a terminal program such as HyperTerminal.
2. Enter the user name **service**. The terminal program displays the main menu.
3. Enter command **1** to open the **IP** menu.
4. Enter **1** again. The terminal program displays the current IP address and prompts you to enter a new IP address.
5. Enter the desired IP address and press Enter. The terminal program displays the new IP address.
6. Use the displayed commands for any additional settings you require.

Note:

You must reboot to activate the new IP address, a new subnet mask or a gateway IP address.

Reboot

Briefly interrupt the power supply to the camera for a reboot (disconnect the power supply unit from the mains supply and switch on again after a few seconds).

Additional Parameters

You can use the terminal program to check other basic parameters and modify them where necessary. Use the on-screen commands in the various submenus to do this.

12.3 Repairs

**CAUTION!**

Never open the casing of the unit. The unit does not contain any user serviceable parts. Ensure that all maintenance or repair work is performed only by qualified personnel (electrical engineering or network technology specialists). In case of doubt, contact your dealer's technical service center.

12.3.1 Transfer and disposal

The camera should only be passed on together with this installation guide. The unit contains environmentally hazardous materials that must be disposed of according to law. Defective or superfluous devices and parts should be disposed of professionally or taken to your local collection point for hazardous materials.

13 Technical Data

13.1 Specifications

Type number	NBN-498
Imager	1/3-inch CCD sensor
Active pixels (PAL)	752x582
Active pixels (NTSC)	768x494
Rated supply voltage	12 VDC, 550 mA (IVA: 650 mA) 24 VAC, 550 mA (IVA: 650 mA) PoE 48 VDC, 200 mA (IVA: 250 mA)
Power consumption	≤6 W
Minimum illumination	0.15 lx color, 30 IRE 0.06 lx Mono, 30 IRE
Day/Night	Color, Mono (IR contrast), Auto
Modes	6 programmable (preset) modes: 24-hour, Traffic, Low-light, SmartBLC, Low noise, Infrared
Dynamic range	120 dB (20-bit image processing)
SNR	> 50 dB
Dynamic engine	XF-Dynamic, 2X-Dynamic, SmartBLC
SmartBLC	On (includes 2X-Dynamics), Off
AGC	AGC On (0-30 dB) or Off
White Balance	ATW, AWB hold and manual (2500 to 10000K)
Color saturation	Adjustable from monochrome (0%) to 133% color
Shutter	AES (1/60 [1/50] to 1/10000) customer selectable AES (1/60 [1/50] to 1/150000) automatic, flickerless or fixed
Sens Up	Adjustable from Off to 10x
AutoBlack	Automatic continuous, Off
DNR	Automatic noise filtering On/Off selectable
Sharpness	Sharpness enhancement level selectable
Peak White Invert	Suppresses highlights in scenes
Privacy Masking	Four independent areas, fully programmable; gray

Video Motion Analysis	Motion+, Intelligent Video Analysis (option)
Test pattern generator	Color bars 100%, Greyscale 11-step, Sawtooth 2H, Checker board, Cross hatch, UV plane
Synchronization	Internal, Line Lock
ALC lens	Video or DC iris auto detect
Controls	OSD with softkey operation, Web browser
Control feedback	Actual shutter, Actual gain
LAN interface	1 × Ethernet 10/100 Base-T, automatic adaptation, half/full duplex, RJ-45
Video encoding protocols	H.264 (ISO/IEC 14496-10), M-JPEG, JPEG
Video data rate	9,600 KBit/s... 6 MBit/s
Image resolutions (PAL/NTSC)	4CIF: 704 × 576/480 pixels (25/30 IPS) CIF: 352 × 288/240 pixels (25/30 IPS)
Group of pictures	I, IP
Image refresh rate Field/image-based coding	1 to 50/60 fields/s, adjustable (PAL/NTSC)
Network protocols	Telnet, RTP, HTTP, ARP, TCP, UDP, IP, ICMP, DHCP, IGMPv2, 802.1x, HTTPS, IGMPv3, SNMPv2, UPnP
Encryption	TLS 1.0, SSL, AES (optional)
Alarm input (2)	Non-isolated closing contact TTL logic, +5V nominal, +40 VDC max, DC coupled with 22 kOhm pull-up to +3.3
Relay output (1)	Maximum voltage 30 VAC or +40 VDC. Maximum 0.5 A continuous, 10 VA
Audio input (Line in)	5.5 Vpp maximum, impedance 9 kOhm typical
Audio output (Line out)	3 Vpp maximum, impedance 10 kOhm typical
Audio standard G.711	300 Hz to 3.4 kHz at 8 kHz sampling rate

Audio signal-to-noise ratio	> 50 dB
Data port	RS-232/422/485
Lens mount	CS compatible, C-mount compatible with adapter ring
Tripod mount	Bottom and top 1/4" 20 UNC
Dimensions (H x W L) without lens	58 x 66 x 122 mm (2.28 x 2.60 x 4.80 in)
Weight without lens	542 g (1.195 lb)
Operating temperature	-20 °C to +50 °C (-4 °F to +122 °F)
Operating temperature (IVA)	-20 °C to +45 °C (-4 °F to +113 °F)

13.1.1 Dimensions

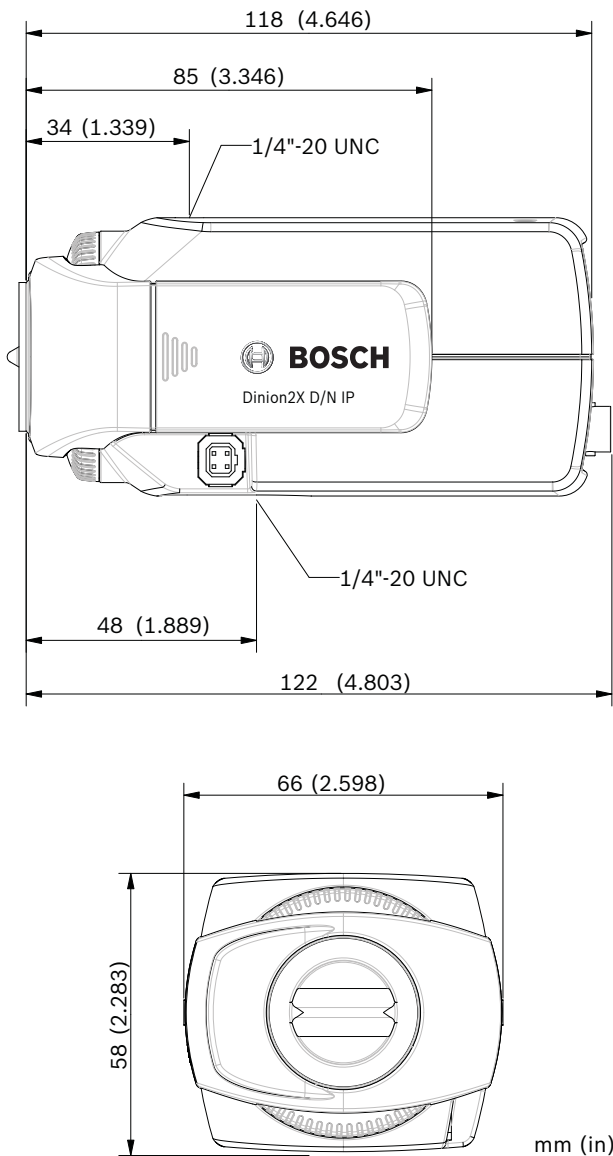

Figure 13.1 Side and front dimensions

13.1.2 Accessories

Recommended lenses

LTC 3364/21 Varifocal Lens IR corrected

- 1/3-inch, 2.8 – 6 mm, DC-iris, CS-mount F1.4-200, 4-pin

LTC 3664/30 Varifocal Lens IR corrected

- 1/3-inch, 3.0 – 8 mm, DC-iris, CS-mount F1.0-360, 4-pin

LTC 3664/40 Varifocal Lens IR corrected

- 1/3-inch, 2.8 – 11 mm, DC-iris, CS-mount F1.4-360, 4-pin

LTC 3674/20 Varifocal Lens IR corrected

- 1/3-inch, 7.5 – 50 mm, DC-iris, CS-mount F1.3-360, 4-pin

LTC 3764/20 Varifocal Lens IR corrected

- 1/2-inch, 4 – 12 mm, DC-iris, C-mount F1.2-360, 4-pin

LTC 3774/30 Varifocal Lens IR corrected

- 1/2-inch, 10 – 40 mm, DC-iris, C-mount F1.4-360, 4-pin

Power transformers

UPA-2410-60 Power Supply

- 120 VAC, 60 Hz, 24 VAC, 10 VA Out

UPA-2430-60 Power Supply

- 120 VAC, 60 Hz, 24 VAC, 30 VA Out

UPA-2450-60 Power Supply

- 120 VAC, 60 Hz, 24 VAC, 50 VA Out

UPA-2420-50 Power Supply

- 220 VAC, 50 Hz, 24 VAC, 20 VA Out

UPA-2450-50 Power Supply

- 220 VAC, 50 Hz, 24 VAC, 50 VA Out

Contact your Bosch representative for the latest available accessories.

Glossary

0...9

10/100Base-TIEEE-802.3 specification for 10 or 100 Mbps Ethernet.

802.1x The IEEE 802.1x standard provides a general method for authentication and authorization in IEEE-802 networks. Authentication is carried out via the authenticator, which checks the transmitted authentication information using an authentication server (see RADIUS server) and approves or denies access to the offered services (LAN, VLAN or WLAN) accordingly.

A

ARP Address Resolution Protocol: a protocol for mapping MAC and IP addresses.

B

Baud Unit of measure for the speed of data transmission
bps Bits per second, the actual data rate.

C

CF CompactFlash: interface standard, for digital storage media amongst other things. Used in computers in the form of CF cards, digital cameras and Personal Digital Assistants (PDA).

CIF Common Intermediate Format: video format with 352 × 288/240 pixels.

D

DHCP Dynamic Host Configuration Protocol: uses an appropriate server to enable dynamic assignment of an IP address and other configuration parameters to computers on a network (Internet or LAN).

DNS Domain Name Service: A service that stores domain names and translates them into Internet Protocol (IP) addresses.

F

- FTP** File Transfer Protocol: Used to transfer files between computers on a network, such as the Internet.
- Full duplex** Simultaneous data transmission in both directions (sending and receiving).

G

- GBIC** GigaBit Interface Converter: applied in network technology to render interfaces flexible, for converting an electrical interface into an optical interface, for example. This enables flexible operation of an interface as a Gigabit Ethernet via twisted-pair cables or fiber optic cables.
- GoP** Group of Pictures: In MPEG video encoding, a group of pictures, or GoP, specifies the order in which intra-frames and inter-frames are arranged.

H

- H.264** Standard for high-efficiency video compression, based on the predecessors MPEG-1, MPEG-2 and MPEG-4. H.264 typically achieves a coding efficiency around three times as high as MPEG-2. This means that comparable quality can be achieved at around a third of MPEG-2 data quantity.
- HTTP** Hypertext Transfer Protocol: protocol for transmitting data over a network.
- HTTPS** Hypertext Transfer Protocol Secure: encrypts and authenticates communication between Web server and browser.

I

- ICMP** Internet Control Message Protocol: One of the core protocols of the Internet protocol suite. It is chiefly used by networked computers' operating systems to send error messages indicating, for instance, that a requested service is not available or that a host or router could not be reached.
- ID** Identification: a machine readable character string.

IEEE	Institute of Electrical and Electronics Engineers: The world's leading professional association for the advancement of technology.
IGMP	Internet Group Management Protocol: A communications protocol used to manage the membership of Internet Protocol multicast groups.
Internet Protocol	The main protocol used on the Internet, normally in conjunction with the Transfer Control Protocol (TCP): TCP/IP.
IP	See Internet Protocol.
IP address	A 4-byte number uniquely defining each unit on the Internet. It is usually written in dotted decimal notation, for example "209.130.2.193"
iSCSI	Internet Small Computer System Interface: Protocol that manages storage via a TCP/IP network. iSCSI enables access to stored data from everywhere in the network.
ISDN	Integrated Services Digital Network: Comprised of digital telephony and data-transport services offered by regional telephone carriers. ISDN involves the digitization of the telephone network, which permits voice, data, text, graphics, music, video, and other source material to be transmitted over existing telephone wires.

J

JPEG	Joint Photographic Experts Group: The name of the committee that created a standard for encoding still images.
------	--

K

Kbps	Kilobits per second: the actual data rate.
------	--

L

LAN	Local Area Network: A communications network serving users within a limited geographical area such as a building or university campus. It is controlled by a network operating system and uses a transfer protocol.
LUN	Logical Unit Number: logical drive in iSCSI storage systems.

M

- MAC** Media Access Control: A quasi-unique identifier attached to most network adapters (NICs). It is a number that acts like a name for a particular network adapter.
- MIB** Management Information Base: a collection of information for remote servicing using the SNMP protocol.
- MPEG-4** A further development of MPEG-2 designed for transmitting audiovisual data at very low transfer rates (for example over the Internet).
- MSS** Maximum Segment Size: maximum byte figure for the user data in a data packet.

N

- Net mask** A mask that explains which part of an IP address is the network address and which part is the host address. It is usually written in dotted decimal notation, for example "255.255.255.192"
- NTP** Network Time Protocol: a standard for synchronizing computer system clocks via packet-based communication networks. NTP uses the connectionless network protocol UDP. This was developed specifically for enabling time to be reliably transmitted over networks with variable packet runtime (Ping).

O

- OF** Optical Fiber: now used predominantly as the transmission medium for line-borne telecommunication processes (glass fiber cable).

P

- Parameters** Values used for configuration.

Q

- QCIF** Quarter CIF: video format with 176 × 144/120 pixels (see CIF).

R

- RADIUS server** Remote Authentication Dial-In User Service: a client/server protocol for the authentication, authorization and accounting of users with dial-up connections on a computer network. RADIUS is the de-facto standard for central authentication of dial-up connections via Modem, ISDN, VPN, Wireless LAN (see 802.1x) and DSL.
- RFC 868** A Request For Comment protocol for synchronizing computer clocks over the Internet.
- RS232/RS422/RS485** Recommended standards for serial data transmission. A communication interface for third party control, firmware upgrades, and service purposes for camera and DVR products.
- RTP** Realtime Transport Protocol: a transfer protocol for real-time video and audio.

S

- SFP** Small Form-factor Pluggable: small, standardized module for network connections, designed as a plug connector for high-speed network connections.
- SNIA** Storage Networking Industry Association: association of companies for defining the iSCSI standard.
- SNMP** Simple Network Management Protocol: a protocol for network management, for managing and monitoring network components.
- SNTP** Simple Network Time Protocol: a simplified version of NTP (see NTP).
- SSL** Secure Sockets Layer: an encryption protocol for data transmission in IP-based networks. The predecessor to TLS (see TLS).
- Subnet mask** See Net mask.

T

- TCP** Transfer Control Protocol
- Telnet** Login protocol with which users can access a remote computer (Host) on the Internet or local area network (LAN) connections.

- TLS** Transport Layer Security: TLS 1.0 and 1.1 and the standard advanced developments of SSL 3.0 (see SSL).
- TTL** Time-To-Live: life cycle of a data packet in station transfers.

U

- UDP** User Datagram Protocol: One of the core protocols of the Internet Protocol suite.
- URL** Uniform Resource Locator: Previously Universal Resource Locator. The unique address for a file that is accessible on the Internet.
- UTP** Unshielded Twisted Pair: A variant of twisted pair cabling, UTP cable is not surrounded by any shielding.

W

- WAN** Wide Area Network: A long distance link used to extend or connect remotely located local area networks.

Bosch Security Systems

www.boschsecurity.com

© Bosch Security Systems, 2010

Free Manuals Download Website

<http://myh66.com>

<http://usermanuals.us>

<http://www.somanuals.com>

<http://www.4manuals.cc>

<http://www.manual-lib.com>

<http://www.404manual.com>

<http://www.luxmanual.com>

<http://aubethermostatmanual.com>

Golf course search by state

<http://golfingnear.com>

Email search by domain

<http://emailbydomain.com>

Auto manuals search

<http://auto.somanuals.com>

TV manuals search

<http://tv.somanuals.com>