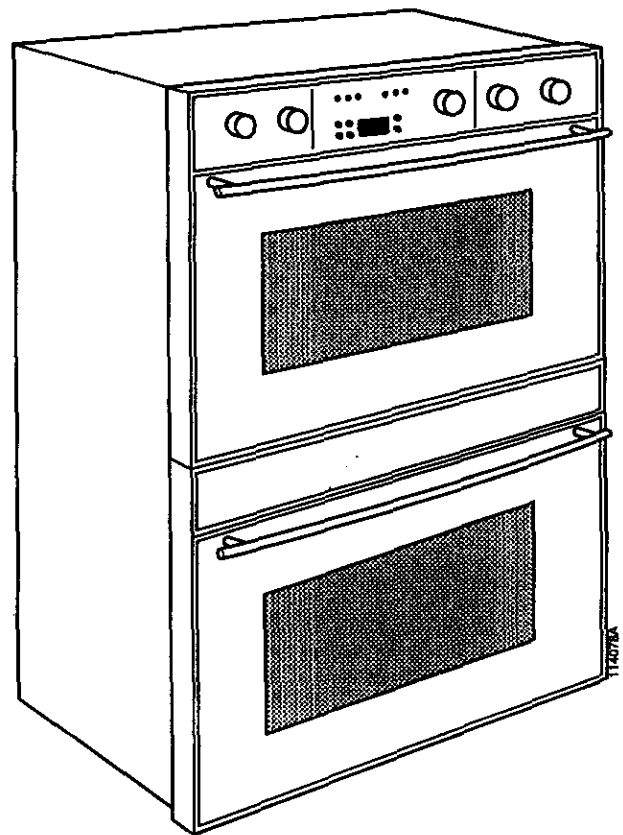
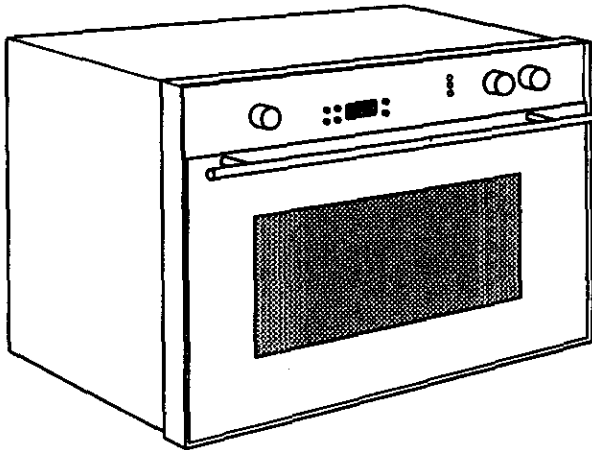


BOSCH



**Use and Care Manual
for Bosch Electric Built-in
Single & Double Oven
Models HBL 63../64../65../66..
HBN 64../65../66..**

***Manuel d'utilisation et d'entretien
Four électrique Bosch encastré, simple et double..
Modeles HBL 63../64../65../66..
HBN 64../65../66..***

Dear Bosch Oven Owner:

Thank you and congratulations on your choice and purchase of a Bosch oven. Whether you are an expert chef or a beginning cook we believe that you will find your Bosch oven meets and exceeds your expectations. Bosch engineers have spent years developing these units to be the most versatile and energy efficient so that you may take great pride in the quality of construction of these fine ovens.

We also ask that you read this manual thoroughly before using your new oven. Please pay particular attention to the Safety Instructions printed at the front of the book and the numerous safety hints and cautions placed throughout this manual. Also, be sure to familiarize yourself with the proper operation of the oven and its cleaning and maintenance procedures. Adherence to these instructions and procedures will assure that you realize the full potential of your new Bosch oven as well as protect it from damage and yourself from injury.

BSH Home Appliances

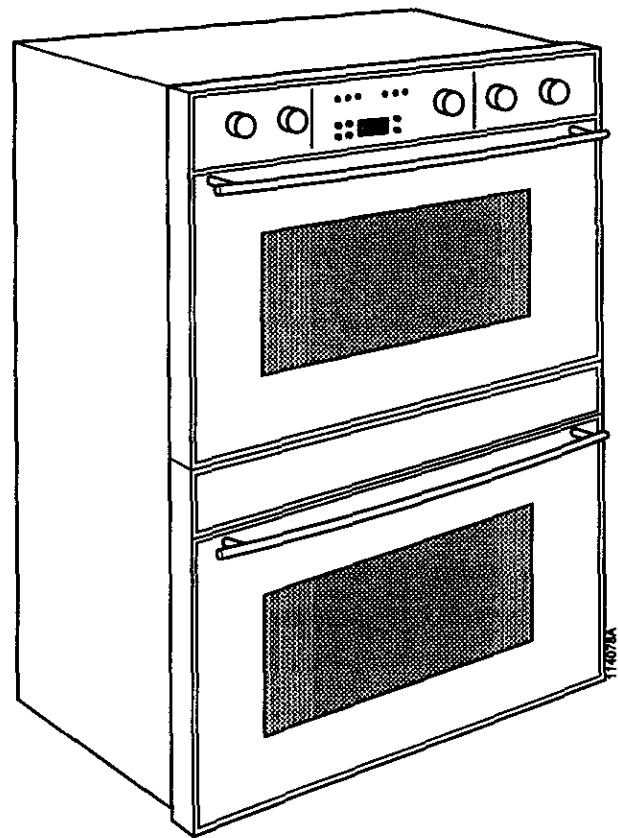
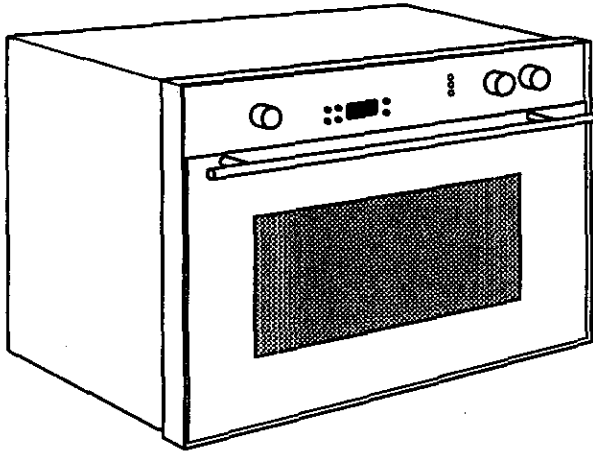
*Cher client,
Chère cliente,*

Tous nos remerciements et félicitations pour avoir choisi d'acquérir un four Bosch. Que vous soyez un fin gastronome ou un débutant dans la matière, vous découvrirez que votre four Bosch répond à toutes les exigences qu'on pourrait avoir à l'égard d'un four. Les ingénieurs de Bosch ont passé des années à mettre au point ces appareils qui sont parmi les plus polyvalents et les plus économiques, sans parler de leur haute qualité de construction.

Nous vous demanderons de bien vouloir lire ce manuel avant d'utiliser votre nouveau four, surtout si c'est la première fois que vous possédez un four Bosch. Lisez attentivement les conseils de sécurité et les nombreuses mises en garde mentionnés dans ce manuel. Prenez soin également de vous familiariser avec le fonctionnement de votre appareil et ses procédures d'entretien et de nettoyage. C'est en respectant ces instructions et procédures que vous tirerez le plus de profit et le plus de plaisir de votre nouveau four.

BSH Home Appliances

BOSCH



**Use and Care Manual
for Bosch Electric Built-in
Single & Double Oven
Models HBL 63../64../65../66..
HBN 64../65../66..**

READ ALL INSTRUCTIONS BEFORE USING THIS APPLIANCE

Table of Contents

Important Safety Instructions	3
Product Features	4
About Your Oven.....	4
Cooling Fan	4
Racks and Rack Positions	4
Baking Elements.....	5
Broiling Elements.....	5
Convection Element	5
About Convection Ovens	5
Oven Operation	6
Oven Models	6
Using Your Oven	6
Cooking Function Settings, Table 3	8
Oven Programmer	9
Setting the Electronic Clock.....	9
Timer	9
Using the Oven Controls	11
Manual Operation of Oven.....	11
Electronic Control of Oven	12
Immediate Start/Automatic Shut-Off.....	12
Delayed Start/Automatic Shut-Off.....	12
Care and Cleaning	15
Using Self Clean Function	15
Replacing an Oven Light.....	16
Oven Door Removal	17
Service and Repair	18
Problem Solving, Table 4.....	19
If You Need Assistance	20
Model Information	20
Product Warranty	21

IMPORTANT SAFETY INSTRUCTIONS

WARNING - When using this appliance, basic safety precautions should always be followed to reduce the risk of fire, electric shock, and/or injury to persons, including the following.

1. **Read All Instruction Before Using the Oven.**
2. **Proper Installation** - Be sure your appliance is properly installed and grounded by a qualified technician. Have the installer show you where the fuse or breaker box is located and how to turn off the power to the oven.
3. **Do Not Operate the Oven if it is Damaged or Not Working Properly.**
4. **Never Use Your Appliance for Warming or Heating the Room.**
5. **Do Not Leave Children Alone** - Children should not be left alone or unattended in area where the appliance is in use. They should never be allowed to sit or stand on any part of the appliance.
6. **Do Not Touch Heating Elements or Interior Surfaces of Oven** - Heating elements may be hot even though they are dark in color. Interior surfaces of the oven, including racks become hot enough to cause serious burns. Do not touch or let clothing or other flammable material come into contact with the heating elements or interior surfaces or racks of the oven during or immediately after use. Allow the oven to cool.
7. **Wear Proper Apparel** - Loose-fitting or hanging garments should never be worn while using the appliance. Fabric may ignite and result in personal injury.
8. **Use Only Dry Potholders** - Moist or damp potholders on hot surfaces may result in burns from steam. Do not let potholder touch hot heating elements. Do not use a towel or other bulky cloth.
9. **User Servicing** - Do not repair or replace any part of the appliance unless specifically recommended in the manual. All other service should be referred to a qualified technician.
10. **Storage in or on Appliance** - Flammable materials should not be stored in an oven or near surface units.
11. **Do Not Use Water on Grease Fires** - Smother fire or flame or use dry chemical or foam type extinguisher.
12. **Use Care When Opening Door** - Let hot air or steam escape before removing or replacing food.
13. **Do Not Heat Unopened Food Containers** - Build-up of pressure may cause container to burst and result in injury.
14. **Keep Oven Vent Ducts Unobstructed**
15. **Placement of Oven Racks** - Always place oven racks in desired location while oven is cool. If rack must be moved while oven is hot, do not let potholder contact hot heating element in oven.
16. **Do Not Clean Door Gasket** - The door gasket is essential for a good seal. Care should be taken not to rub, damage, or move gasket.
17. **Do Not Use Oven Cleaners** - No commercial oven cleaner or oven liner protective coating of any kind should be used in or around any part of the oven.
18. **Clean Only Parts Listed in Manual**
19. **Before Self-Cleaning the Oven** - Remove broiler pan, broiler grid, anti-splash cover, pan support, oven racks and other utensils.
20. **Check for Off When Done** - Always check the position of the oven control knobs when you have finished cooking to make sure they are all in the off positions.
21. **“CAUTION”** - Do not store items of interest to children in cabinets above the oven - children climbing on the oven to reach items could be burned or otherwise seriously injured.
22. **Always Disconnect the Electrical Supply Before Servicing the Oven.**

Product Features

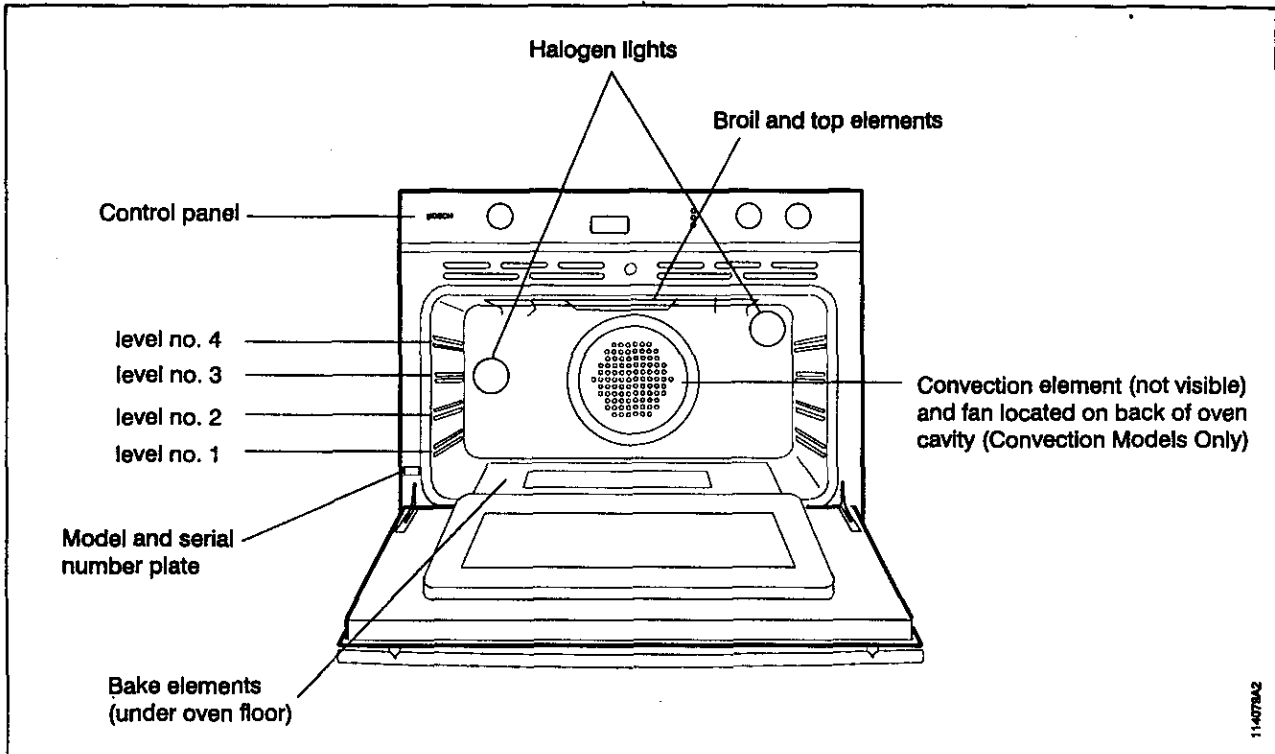


Figure 1.

About Your Oven

Above you will find an illustration of a Bosch oven showing the components of the oven. This manual covers the complete line of Bosch single and double ovens so some of the features described may not be available on your oven.

Cooling Fan

All the ovens whether convection type or thermal type have a cooling fan to cool the control panel. You may hear this fan continue to run after cooking and/or cleaning has been completed. The fan will run as long as the oven is hot and the oven's function selector is turned to any position other than "Off". This is normal operation.

Rack Positions

The oven has rack guides at four levels as shown in the illustration. Each level guide consists of paired supports formed in the sidewalls on each side of the oven cavity.

The rack or support should be positioned within the paired supports. Each oven is provided with the following parts and utensils, see Figure 2:

- Anti-splash pan cover
- Broiler pan
- Pan support
- Rack(s)

Always be sure to position the oven racks, supports, etc. before turning the oven on. Make sure that the rack(s) are level once they are in position. To remove oven rack or pan support from the oven, lift rack/support at front and lift out. To replace oven rack or pan support:

1. Place rear of rack or support between the rack level guides.
2. While lifting front of rack, slide rack or support in all the way, then lower front. Please refer to illustration if there is any question as to which side is the front of either the rack or the support.

Baking Elements

The Bosch oven uses two baking elements: one located at the top of the oven and the second located below the floor of oven cavity to provide ease in cleaning the oven cavity.

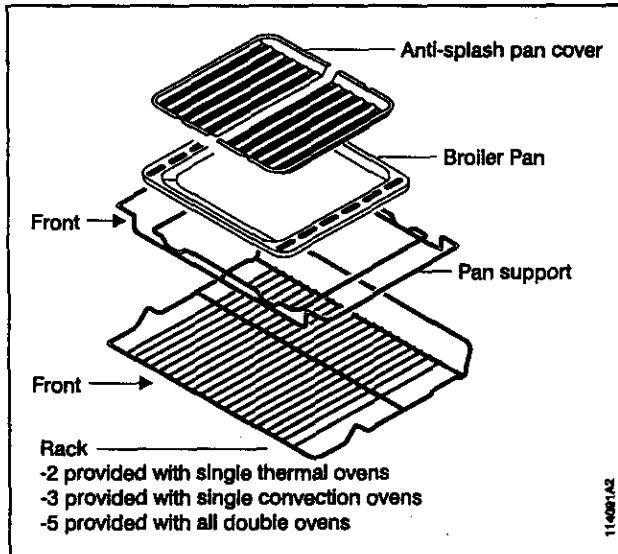


Figure 2.

Broiling Elements

The broiling elements of the Bosch ovens are located at the top of the oven cavity. Do not touch the heating elements or let potholders touch the broiler elements. Never use a towel or bulky cloth for a potholder; they could catch on fire.

Convection Element

If you have purchased one of the convection oven models you will find the convection element (not visible) and fan located at the back of the oven cavity. This element and fan combination performs the cooking when in the convection bake mode. When in any of the convection modes the fan is on, see Table 3.

About Convection Ovens

Both the single ovens and double ovens are available as either conventional thermal ovens or as convection ovens. Although most people are familiar with the operation of a conventional thermal oven many are unclear as to how a convection oven works or in what ways it is superior to a

conventional thermal oven. Below you will find a brief explanation of how a convection oven works and its advantages.

In Bosch Ovens, the Genuine European Convection™ system (the 3 elements, fan and venting panel) circulates even, heated air throughout the oven. This process:

- Seals in juices and flavor
- Provides even baking and browning
- Saves time and energy
- Baking on multiple levels at the same time
- Dehydrates herbs, fruits and vegetables
- Bakes whole meals at once with no flavor transfer
- Thaws evenly

The enclosed Bosch cookbook provides many helpful tips and a description of each cooking cycle. It also has many recipes for each cycle to help you enjoy your new oven. Many of your own recipes have time and temperature instruction for the regular bake cycle. As a rule, most of these recipes can be cooked with better results in one of the convection cycles. In general, to convert standard recipes for use in convection, you reduce the temperature by about 25°F and check for doneness at the minimum suggested cooking time. When baking on more than 1 rack it may be necessary to increase the cooling time a few minutes for each additional rack. As individual tastes vary, you may find you need to adjust the time and temperature to achieve desired results.

You may feel your new oven cooks differently than your old oven. We recommend you use the various cooking cycles for a few months and refer to the Bosch Cookbook to become more familiar with it.

We do not recommend you use oven thermometers found at many grocery stores to check oven temperature. They may be inaccurate and are slow to respond to temperature changes.

Oven Operation

Oven Models

There are 21 different models of Bosch ovens, see Tables 1 & 2, below. Bosch ovens are available in 27" or 30", in white, black or stainless steel, in single or double oven configurations as well as being provided as either standard, thermal-type ovens or convection type, with the double ovens being available with either a single convection oven or with two convection ovens.

Single Oven Models	Convection	Colors		
		Wht	SS	Blk
HBL 632A UC	No	X		
HBL 635A UC	No		X	
HBL 636A UC	No			X
HBL 642A UC HBN 642A UC	Yes	X		
HBL 645A UC HBN 645A UC	Yes		X	
HBL 646A UC HBN 646A UC	Yes			X

Table 1.

Double Oven Models	Convection (top/bottom)	Wht	SS	Blk
HBL 652A UC HBN 652A UC	Yes/No	X		
HBL 655A UC HBN 655A UC	Yes/No		X	
HBL 656A UC HBN 656A UC	Yes/No			X
HBL 662A UC HBN 662A UC	Yes/Yes	X		
HBL 665A UC HBN 665A UC	Yes/Yes		X	
HBL 666A UC HBN 666A UC	Yes/Yes			X

Table 2.

Due to the number of models offered not all the features described below may apply to your oven.

Using Your Oven

It is very important to learn how to properly use your oven to obtain the best cooking results. Following you will find important information for the safe and efficient use of your oven.

Before Using for the First Time

Before using your Bosch oven for the first time remove all packing and foreign materials from the oven(s). Any material of this sort left in the oven(s) may melt and/or burn when the oven(s) are used.

Oven Control Panel

All the ovens have the following controls, as shown in Figure 3:

- Programmer push-buttons:
 - Set Clock button
 - Timer button
 - Cook Time button
 - Start Time button
 - Time set + and - buttons.
- Programmer display
- On/Off light
- Heat light
- Door lock light
- Timer/Manual selector knob
- Temperature control knob(s)
- Mode selector knob(s)

The double oven control panel is the upper panel shown in Figure 3 and the single oven control panel is the lower panel shown.

Programmer Push-Buttons

The programmer push-buttons are used to set and program the oven. See sections **Timer and Programming the Oven** for explanation on how to use the programmer push-buttons.

Programmer Display

The programmer display performs many functions. When the electricity to your oven is first turned on the display will be blank. For information on setting the display and its use as a timer or for programmed cooking see sections **Timer and Programming the Oven**, following.

Timer/Manual Selector

The Timer/Manual selector knob is used to set the oven(s) for Manual or Timer mode.

On Light

The on light will be illuminated whenever the oven is on.

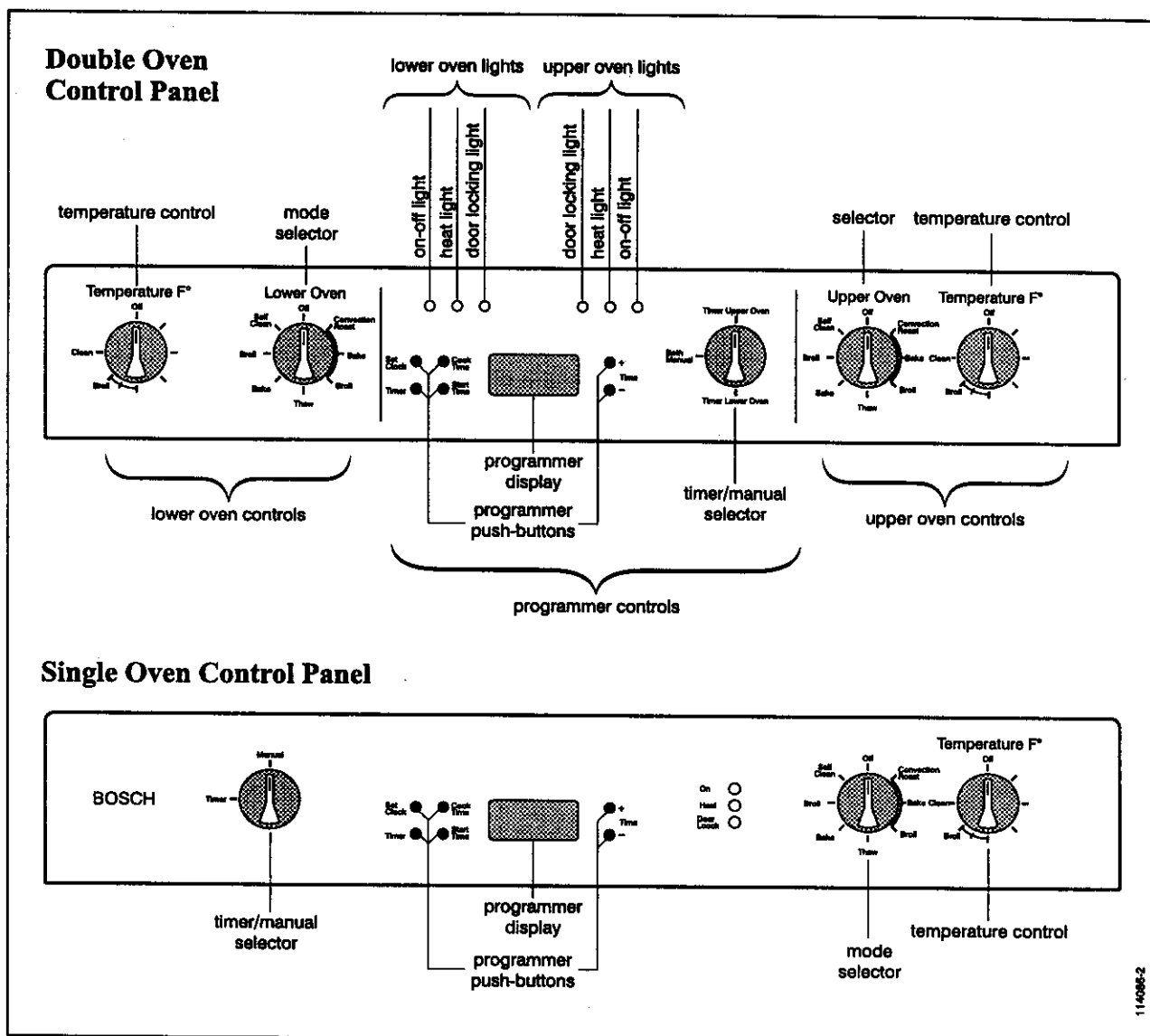


Figure 3.

Heat Light

The heat light will be lit when you turn on your oven. When the oven reaches the set temperature the light will turn off to let you know the oven is preheated. (Preheat time should take approximately 12-15 minute when using 240 volts. If electrical supply is less than 240 volts preheat times will be longer). The light is connected to the cooking elements and will turn off and on as the oven cycles to maintain the set temperature.

Door Lock Light

The door lock light will be illuminated whenever the oven is in the self-clean mode and the door is locked.

Temperature Control Knob

The temperature control knob is marked in degrees Fahrenheit (°F). This control knob is used to adjust the oven temperature.

Mode Selector

The mode selector knob is used to set the oven to Off, or for Self Clean, or to select the cooking function desired. A number of modes are available depending on the model oven you have purchased.

Please see Table 3, Cooking Function Settings, for information on selecting a cooking mode.

1140852

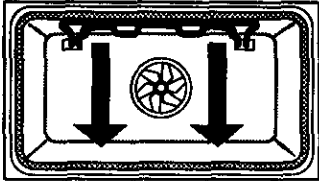
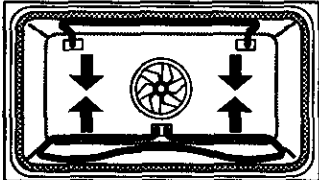

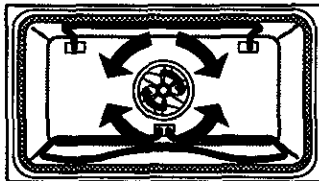
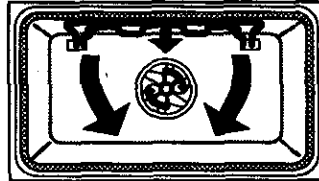
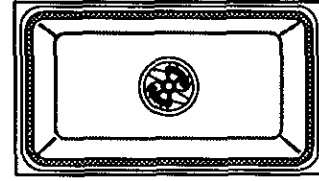
Cooking Function Settings	
Thermal Oven	Function Information
	<p>Broil - Used for broiling. When set on Broil the two top elements operate whenever heating.</p> <p>May be used with door open or closed.</p>
	<p>Bake (Roast) - This mode is used for baking, roasting and heating of casseroles, etc. When set on Bake the top element and the bottom element operate whenever heating.</p>
<p>Note: Lower element shown for clarity only. Lower element actually is located below floor of cavity</p>	
Convection Ovens have following additional cooking functions	
	<p>Convection Bake - The most versatile mode for baking and heating a variety of dishes. Also recommended for preparing large quantities of food on several racks.</p> <p>When set on Convection the rear circular bake element operates whenever heating. Fan operates.</p>
	<p>Convection Roast - Use for roasting.</p> <p>When set on Convection Roast the top element and the bottom element operate whenever heating. Fan operates.</p>
	<p>Convection Broil - Use of fish and broiling thick cuts of meat. The door must be closed when Convection Broiling. When set on Convection Broil both top elements operate whenever heating. Fan operates.</p>
	<p>Thaw - Use for defrosting. When set on Thaw no elements operate, only the fan is on.</p>
<p>Note: Lower element shown for clarity only. Lower element actually is located below floor of cavity</p>	

Table 3. Cooking Function Settings

Oven Programmer

The oven programmer can be used to electronically control the cooking in your oven. Figure 4 shows all the call-outs that are available on the display and their locations. The buttons directly adjacent to the display are the programming buttons. These are used to program the oven, including setting the clock.

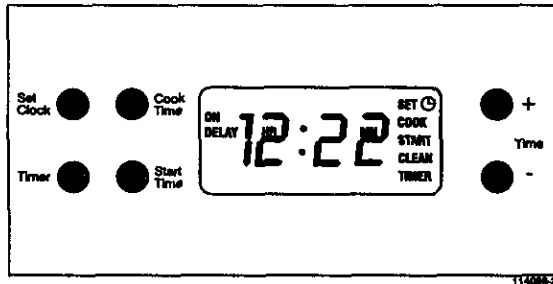


Figure 4.

Setting the Electronic Clock

When you first turn on the power to your oven, or if the power to the oven has been off for a while the display will come on showing all the call-outs, as shown in Figure 4, and then will become blank, with dashes in the display area and the set clock symbol in the upper right of the programmer display, as shown in Figure 5.

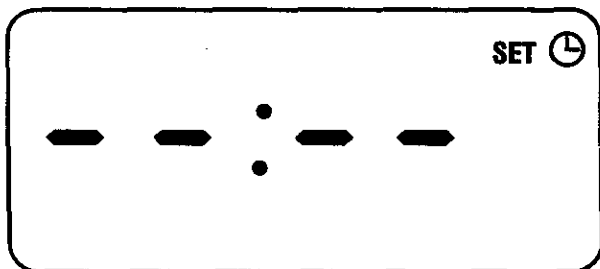


Figure 5.

To set time of day

Press in **Set Clock** button. A "beep" will be heard. Then press either the plus (+) or minus (-) button, to the right of the display, to set the correct time. If the plus (+) or minus (-) button is pressed it will advance or decrease the time in 1 minute increments, if the plus (+) or minus (-) button is held in the minutes will increase or decrease in 10 minute increments. Once the time is

properly set depress the **Set Clock** button again to enter the time. A "beep" will sound and the **Set Clock** symbol, in the upper right, will disappear.

To change the time of day simply repeat the steps described above. To check the time of day when the timer is in use depress the **Set Clock** button. The time of day will be displayed briefly and then will return to the timer function.

Timer

The timer acts as a kitchen timer, counting down from the set time.

To Set Timer

- Press **Timer** button. A "beep" will be heard and the display will change from showing the time of day to read zero (.00) and say **SET TIMER**, to the right, as shown in Figure 6.
- Then press either the plus (+) or minus (-) button, to the right of the display, to set the timer to the time interval desired.



Figure 6.

- Notes:**
1. Each time the plus (+) or minus (-) button is depressed the display will increase or decrease in 1 minute increments. If the plus (+) or minus (-) button is held in the display will increase or decrease in 10 minute increments.
 2. If the plus (+) or minus (-) button is not depressed within 5 seconds of depressing the **Timer** button the **Timer** button will have to be depressed again to again call up the timer mode.

- Once the desired time interval is set release the buttons.
- The timing interval will start after approximately 4 seconds.

- The indicator word **TIMER** will remain in the display during timer countdown.
- The timer will countdown in minutes until the last minute when it will switch over and countdown in seconds.
- At the end of the timing interval the indicator word **TIMER** will blink on and off and three “beeps” will be heard.
- The display will return to time of day or any active programmed function and “beeping” will continue every 10 seconds until any button is touched.
- Once any button is touched the flashing word **TIMER** disappears from the display.

To Cancel Timer

With the indicator word **TIMER** in the display all that is necessary to cancel the timer is to depress

the Timer button once.

If some other timed function has been programmed after setting the timer, the **TIMER** indicator word can be recalled to the display by depressing the Timer button.

Then with the indicator word **TIMER** in the display you can, as above, cancel the timer by depressing the Timer button a second time.

Then after 5 seconds the display will return to time of day or any active programmed function.

To Check Timer During Timed Function

If some other timed function has been programmed after setting the timer, **TIMER** may be recalled to the display by depressing the Timer button.

The amount of time remaining on the timer can then be viewed.

Using the Oven Controls

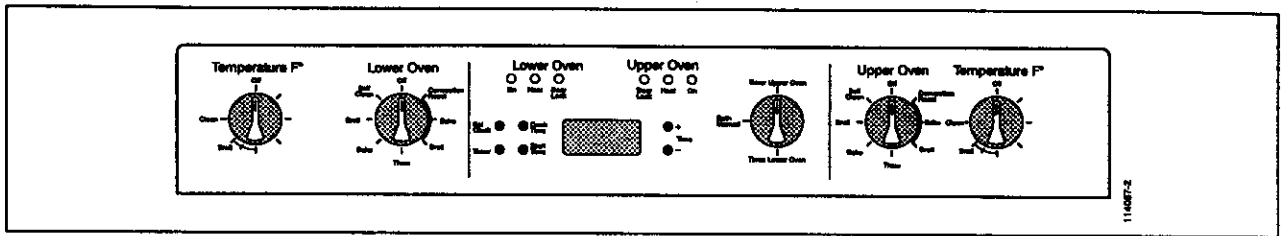


Figure 7. Double Oven Control Panel, HBL/HBN66

The oven controls may be used to operate the oven manually or under control of the oven programmer. Manual operation will be discussed first and then use of the oven programmer.

Manual Operation of the Oven

Before turning on your oven, position the racks properly for their intended use. To change the position of the racks, lift rack at the front and pull-out and re-insert at the desired level.

For manual operation of the oven set the Timer/Manual Selector knob (see Figure 3) to **Manual**. If you have a double oven, as shown above (Figure 7) you have three setting positions available:

- **Timer Upper Oven** - when on this setting the programmer must be used to control the upper oven while the lower oven may be operated manually
- **Both Manual** - when on this setting both ovens may be used manually.
- **Timer Lower Oven** - when on this setting the programmer must be used to control the lower

oven while the upper oven may be operated manually.

Once you have set the mode selector to **Manual** or, if you have a double oven, decided which oven you are going to use:

1. Set Mode selector knob for the oven to the cooking mode desired. Refer to Figure 3 and Table 3 if you are not sure which of the knobs on your oven is the selector knob or which function you wish the oven to perform.

Note: The cooling fan will begin to run as soon as the function selector knob is turned from the **Off** position.

2. Set the temperature control knob for the oven to the temperature desired.

Note: If you have a convection oven and have selected **THAW** it is not necessary to set the temperature control knob as no heating takes place in **THAW** mode.

3. Once cooking has been completed be sure to turn the selector knob and the temperature knob to the **Off** position.

Electronic Control of Oven

Immediate Start /Automatic Shut-Off

To use the electronic control so that your cooking starts immediately and then shuts-off automatically:

1. Set the oven rack(s) as desired and place food in the oven.
2. Make sure that the oven clock is set to the correct time.
3. Set the Timer/Manual Selector (Figure 3) to Timer for the single oven or to **Timer Upper Oven or Timer Lower Oven** for double oven, so that oven programmer is enabled for the oven you wish to use in programmed operation.

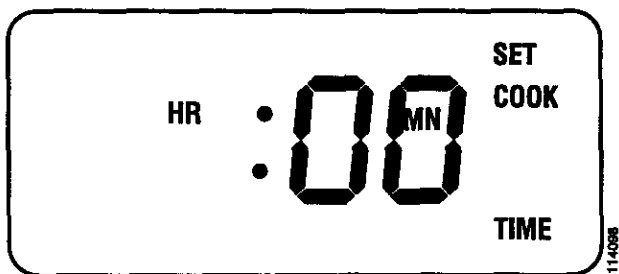


Figure 8.

4. Set oven Mode Selector knob to the cooking function desired:
 - Broil
 - Bake
 - Convection Bake
 - Convection Roast
 - Convection Broil
 - Thaw
5. Set oven Temperature Control knob to the desired temperature.
6. Depress **Cook Time** button, a "beep" will sound and the display will show SET-COOK-TIME on the right hand side of the display, as shown in Figure 8.

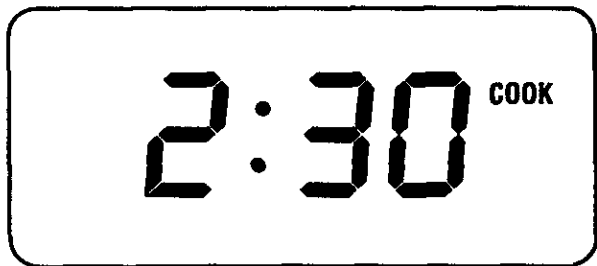


Figure 9.

7. Then press either the plus (+) or minus (-) button, to the right of the display, to set the the timer to the time interval desired. Maximum cooking time is 11 hours and 50 minutes (minimum cooking time is 1 minute).

Note: If the plus (+) or minus (-) button is not depressed within 5 seconds of touching the **Cook Time** button the **Cook Time** button will have to be depressed again to call up SET - COOK - TIME.

8. After the cook time has been set a "beep" will sound and the indicator word COOK will appear in the display and the oven will begin heating. Figure 9 shows what the display would look like at this time if a cooking time of 2 hours and 30 minutes had been set.
9. At the end of the programmed cooking time, the oven will automatically shut-off and the indicator word COOK will blink. Three "beeps" will sound and the oven will continue to beep every 10 seconds until any button is pushed.

Be sure to turn the Mode Selector knob and the Temperature knob to their Off positions after electronic controlled cooking has been completed.

To Cancel Cook Time

To cancel cook time at any time depress Cook Time button twice.

Delayed Start/Automatic Shut-Off

The programmer may also be used to have your oven start at a later time, cook for a preset cooking period and shut itself off automatically. This function is not recommended for foods that contain baking powder or yeast as these foods will not rise properly if cooked in this way. Also, please keep in mind that the time required for the oven to come up to temperature must be included in the cooking time. In most cases this means that approximately 10 minutes should be added to the cooking time. A preheat time is usually not necessary for convection function, but in all cases follow your recipe.



WARNING

When using delayed cooking special consideration must be given to avoid potential sickness and spoiling of food:

1. Avoid using foods that will spoil while placed in the oven waiting for cooking to begin. In particular avoid using foods containing eggs and dairy products in delayed cooking. In addition unfrozen cooked or uncooked meats, poultry and fish should not be placed in the oven if they will be there for more than two hours.
2. Do not allow food to remain in the oven more than one hour after the end of the cooking cycle.

To use the programmer so that your cooking will start at some later time and shut-off automatically:

1. Set the oven rack(s) as desired and place food in the oven.
2. Make sure that the oven clock is set to the correct time.
3. Set the Timer/Manual Selector (Figure 3) to **Timer**, for the single oven, or to **Timer Upper Oven** or **Timer Lower Oven**, for the double oven, so that oven programmer is enabled for the oven you wish to use in programmed operation.

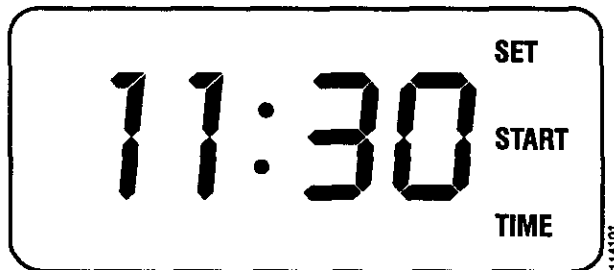


Figure 10.

4. Set oven Selector knob to the cooking function desired:
 - Broil
 - Bake
 - Convection Bake
 - Convection Roast
 - Convection Broil
 - Thaw

5. Set oven Temperature Control knob to the desired temperature.
6. Depress Start Time button. A "beep" will sound and the display will show SET-START-TIME on the right hand side of the display, as shown in Figure 10.
7. Then press either the plus (+) or minus (-) button, to the right of the display, to set the timer to the start time desired. After the time has been entered a "beep" will be heard and the indicator words DELAY-START-TIME will appear briefly.

Note: If the plus (+) or minus (-) button is not depressed within 5 seconds of touching the Start Time button the Start Time button will have to be depressed again to call up SET - START - TIME.

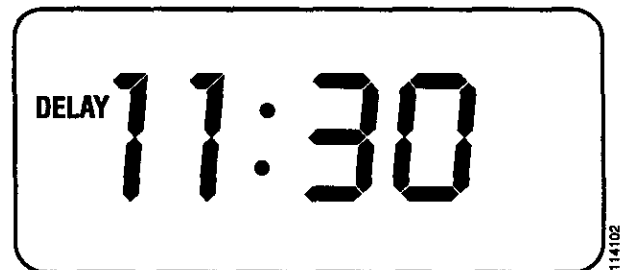


Figure 11.

8. Depress Cook Time button. A "beep" will sound and the display will show SET-COOK-TIME on the right hand side of the display as shown in Figure 8.
9. Then press either the plus (+) or minus (-) button, to the right of the display, to set the the timer to the time interval desired. Maximum cooking time is 11 hours and 50 minutes (minimum cooking time is 1 minute). The display will return to the time of the day with the word DELAY appearing to the left of the day, as shown in Figure 11.
10. When the start time is reached the indicator word COOK will appear in the display with the set cook time. At the end of the programmed cook time the oven will shut-off automatically. The indicator word COOK will blink and three (3) "beeps" will be heard. The oven will continue to "beep" every 10 seconds until any button is depressed.

Be sure to turn the Mode Selector knob and the Temperature knob to their Off positions after the programmed cooking has been completed.

To Check Start Time/before cooking begins

Depress Start Time button. The start time will be displayed briefly and then the display will return to time of day.

To Change Start Time/before Cooking begins

Depress **Start Time** button. A “beep” will sound and the display will show SET - START - TIME on the right hand side of the display. Then press either the plus (+) or minus (-) button to the right of the display, to set the timer to the start time desired.

After the time has been entered a “beep” will be heard and the indicator words DELAY-START-TIME will appear briefly and then the display will return to time of day with the word DELAY appearing to the left of the time of day, as shown Figure 11.

To Check Cook Time

Depress Cook Time button. The cook time will be displayed briefly, then the display will return to on-going program.

To Change Cook Time

Depress Cook Time button. A “beep” will sound and the display will show SET - COOK - TIME on the right hand side of the display, see Figure 8. Then press either the plus (+) or minus (-) button, to the right of the display, to set the timer to the time interval desired. Maximum cooking time is 11 hours and 50 minutes (minimum cooking time is 1 minute).

To Cancel Delay Start

Depress Start Time button twice.

To Cancel Cook Time

Depress Cook Time button twice.

Care & Cleaning

The Bosch line of ovens feature a pyrolytic self-cleaning function that eliminates the difficult and time consuming manual scrubbing of the oven interior. During self-cleaning the oven uses very high temperature (approx. 850°F) to burn away soil and grease. The fumes produced during this function of the oven are then filtered and expelled. You will note however that a powder ash residue will be left on the bottom of the oven after completion of self cleaning. Once the oven has cooled sufficiently the residue may be removed using a damp cloth or sponge. See the following instruction on use of the self clean function.



Make sure all controls are Off and the oven is cool before cleaning. Failure to do so can result in burns or electrical shock.

For parts of the oven other than the oven cavity the following cleaning methods are recommended:

- **Control Panel**
Use warm soapy water or spray glass cleaner to clean the control panel. With a soft cloth or sponge wash, rinse and dry the control panel thoroughly. **DO NOT** use abrasive cleaners or steel wool pads. These will damage the surface.
- **Stainless Steel**
To clean, use a standard cleaner designed for stainless steel such as: Cameo®, Bar Keepers Friend® or Bon-Ami®. Follow manufacture instructions. When clean, a polish such as Twinkle® or Stainless Steel Magic® can be applied. **DO NOT USE ABRASIVE MATERIALS SUCH AS STEEL WOOL OR ROUGH SPONGES. IT WILL SCRATCH THE SURFACE.**
- **Front of Oven Door(s) and Handle(s)**
Use warm soapy water or spray glass cleaner to clean the glass door surface. With a soft cloth or sponge wash, rinse and dry the door front(s) and handle(s) thoroughly. **DO NOT** use abrasive cleaners or steel wool pads. These will damage the surface.
- **Broiler Pan and Rack(s)**
Use warm soapy water. With a steel wool pad wash, rinse and thoroughly dry the pan and/or rack(s). **DO NOT** clean the broiler pans or

racks by leaving them in the oven when running the Self Clean function.

- **Frame Outside Door Gasket Area**
Make sure oven is cool, then use warm soapy water. With a non-abrasive, plastic scrubbing pad clean the frame surface outside the door gasket area. This area must be cleaned by hand because the area outside the gasket does not get hot enough to burn off the soil (see Figure 12).

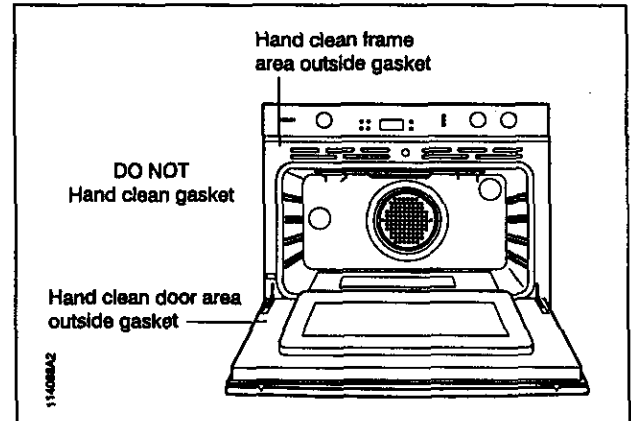


Figure 12.

- **Door Outside gasket Area**
Make sure oven is cool, then use warm soapy water. With a non-abrasive, plastic scrubbing pad clean the area outside the door gasket area. This area must be cleaned by hand because the area outside the gasket does not get hot enough to burn off the soil (see Figure 12).

Using the Self Clean Function

The Self Clean function is a timed function and therefore is used just as if using the oven in **Immediate Start/Automatic Shut-Off** or **Delayed Start/Automatic Shut-Off**. There are a few preparations that must be made however as well as some post function clean-up that you will find described below:

1. Before using Self Clean be sure to remove the broiler pan, pan support, pan grid anti-splash cover as well as the racks. Also, if you have placed any aluminum foil in the oven this should also be removed.

Note: If items are left in the oven during self cleaning they may become damaged and racks will become discolored. Also, the racks will become difficult to slide in and out.

2. Clean soil from the frame around the door, outside the door gasket (see Figure 12). Do not clean the door gasket by hand as this

could move or damage the gasket. The areas outside the gasket area must be cleaned by hand because these areas do not become hot enough during Self Clean to burn away the soiled spots.

3. Also wipe up excess grease and other food spills with a damp cloth. This will minimize the amount of smoke created during self cleaning.

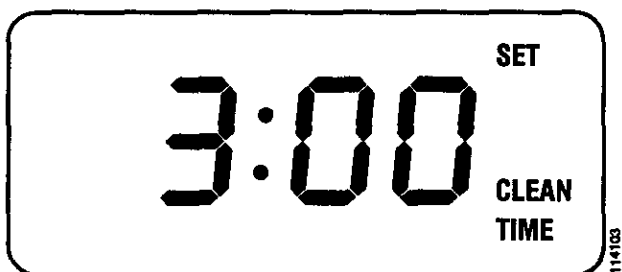


Figure 13.

4. Make sure that the oven door is completely closed and the oven clock is set to the correct time.
5. Set the Timer/Manual Selector knob (see Figure 3) to **Timer**, for single oven, or to **Timer Upper Oven** or **Timer Lower Oven**, for double oven, so that oven programmer is enabled for the oven you wish to have self clean.
6. Set the Function Selector to **Self Clean**. The display will change to say **SET - CLEAN - TIME** with an initial setting of 3 hours. If the plus (+) or minus (-) buttons are not depressed within a few seconds the display will revert to **CLEAN** function, as shown in Figure 14.
7. Set the Temperature Control to **Clean**.
8. If you wish to change to a cleaning time of other than 3 hours depress the **COOK TIME** button. A "beep" will sound and the display will show **SET - CLEAN - TIME** on the right hand side of the display as shown in Figure 13. The programmer setting is initially for a duration of 3 hours. The cleaning time can be set for 2 hours and 30 minutes to 4 hours depending on how soiled the oven cavity has become:
 - > Use 2:30 - to - 3:30 hours for light soil.
 - Use 3:00 - to - 3:30 hours for medium soil.
 - Use 3:30 - to - 4:00 hours for heavy soil.
9. To adjust the cleaning time press the plus (+) or minus (-) button, to the right of the display.

play.

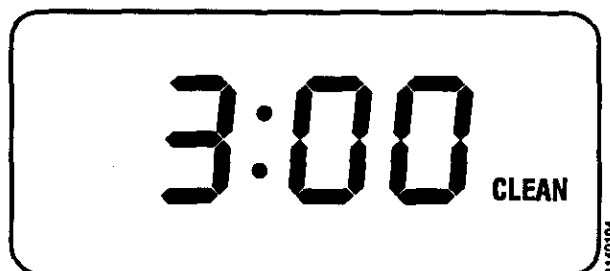


Figure 14.

Note: If the plus (+) or minus (-) button is not depressed within 5 seconds of touching the **COOK TIME** button the **COOK TIME** button will have to be depressed again to call up **SET - CLEAN - TIME**.

10. After the Clean Time has been set a "beep" will sound and the indicator word **CLEAN** will appear in the display and the oven will begin the self cleaning process. As the oven heats past 560°F the automatic door lock will operate to lock the door of the oven that is in Self Clean. The Door Lock indicator light will become illuminated to show that the door is locked. The door will remain locked and the indicator light will remain on throughout the self cleaning process until the temperature drops below the 560°F temperature noted above.
 11. At the end of the programmed clean time the oven will automatically shut-off. Allow the oven to cool.
 12. Open the door. Then after making sure that the oven has cooled to a safe temperature, use a damp cloth or sponge to clean out the powder ash residue left in the oven. If white spots remain in the oven they can be removed with a damp sponge. These white spots are normally just salt spots that cannot be removed by self cleaning.
 13. Reinstall the oven racks and broiler pan.
- Be sure to turn the selector knob and the temperature knob to the Off position after the electronic controlled self cleaning has been completed.

Replacing an Oven Light

Each oven is equipped with two halogen lights located in the back wall of the oven. The lights are switched on when the door is opened or when the oven is in a cooking cycle. The oven lights are not illuminated during **SELF CLEAN**. Each light as-

sembly consists of a removable lens, a light bulb as well as a light socket housing that is fixed in place, see Figure 15. Light bulb replacement is considered to be a routine maintenance item. To replace a light bulb:

1. Read **WARNING** on this page.
2. Turn off power at the main power supply (your fuse or breaker box).

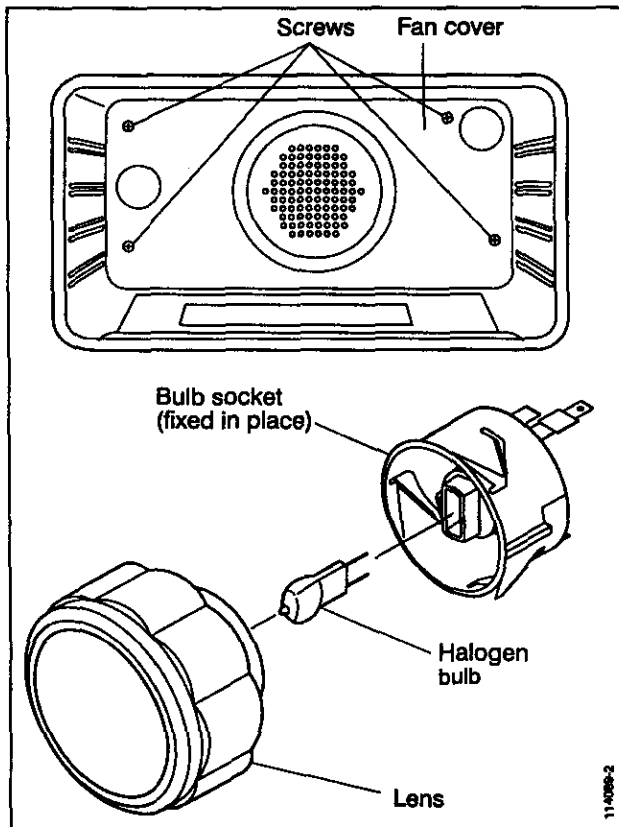


Figure 15.

! WARNING

Make sure the oven and lights are cool and power to the oven has been turned off before replacing the light bulb(s). Failure to do so could result in electrical shock or burns.

The lenses must be in place when using the oven.

The lenses serve to protect the light bulb from breaking.

The lenses are made of glass. Handle carefully to avoid breakage. Broken glass could cause an injury.

3. In multifunction ovens remove the fan cover by unscrewing the four screws.
4. Remove the lens by unscrewing it.
5. Remove the light bulb from its socket by pulling it.
6. Replace the bulb with a new one taking care to don't touch it with naked fingers. Their grease can damage the bulb when it becomes hot. The bulb is halogen 12V-20W.
7. Screw the lens back on.
8. Replace the fan cover if the cavity is provided with.
9. Pay attention that the seal at the lamp opening is placed well in its position and is sealing the gap between opening and back of the cavity.
10. Turn the power back on at the main power supply (your fuse or breaker box).

Oven Door Removal

The oven door can be removed for hand cleaning if needed.

! WARNING

Make sure oven is cool and power to the oven has been turned off before removing the door. Failure to do so could result in electrical shock or burns.

The oven door is heavy and fragile. Use both hands to remove the oven door. The door front is glass. Handle carefully to avoid breakage. Broken glass could cause an injury.

Grasp only the sides of the oven door. Do not grasp the handle as it may swing in your hand and cause damage or injury.

Failure to grasp the oven door firmly and properly could result in personal injury or product damage.

To remove the door for 30" models HBL6..

1. Be sure to read the above **WARNING** before attempting to remove oven door.
2. Open the door completely.
3. Lift up the hinge bracket on each hinge as shown in Figure 16.

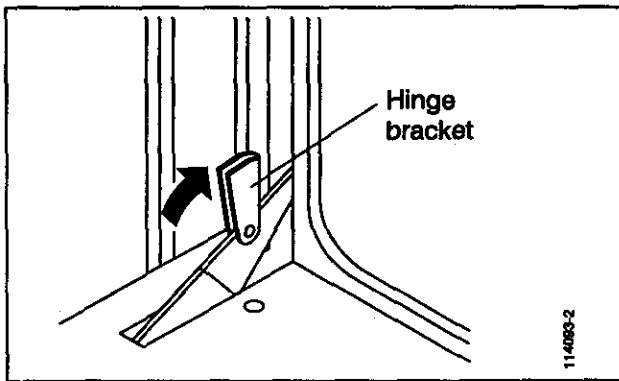


Figure 16.

4. Hold the door firmly on both sides using both hands and pull the door straight out of the hinge slots. Hold firmly; the door is heavy.
5. Place the door in a convenient location for cleaning.

After cleaning the door can be replaced by reversing the above procedure.

Be sure to slide the door straight into the slots, as shown in Figure 17.

After moving the hinge brackets back down into position be sure to close and open the door slowly to assure that it is correctly and securely in place.

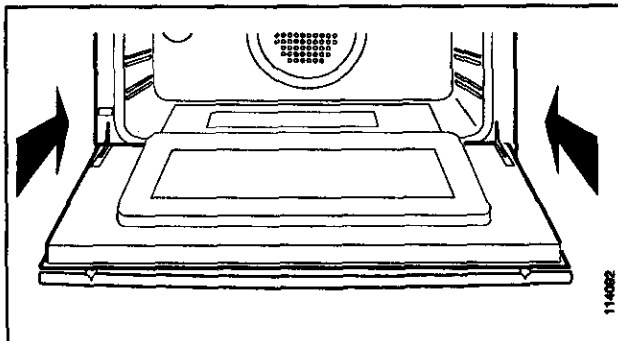


Figure 17.

To remove the door for 27" models HBN6..

1. Be sure to read the above WARNING before attempting to remove oven door.
2. Open the door completely.
3. Lift up the hinge bracket (1, Fig. 18) into the slot (2, Fig. 18).

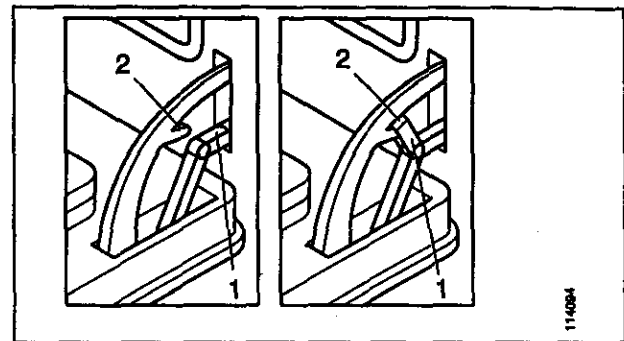


Figure 18.

4. Hold the door firmly on both sides using both hands and close the door. Hold firmly; the door is heavy.
5. Place the door in a convenient location for cleaning.

After cleaning the door can be replaced by reversing the above procedure.

Be sure to slide the hinge parts (1, Fig. 19) into their slots properly.

After moving the hinge brackets back down into position be sure to close and open the door slowly to assure that it is correctly and securely in place.

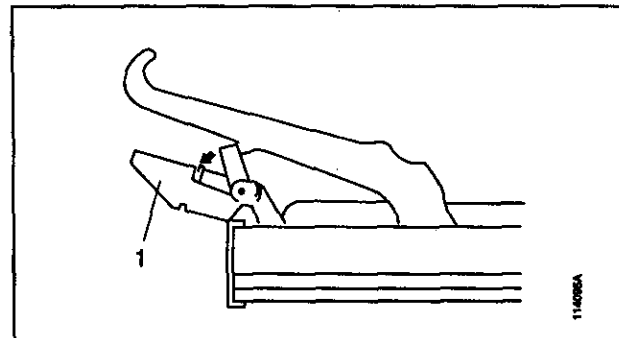


Figure 19.

Service and Repair

The Bosch oven(s) require no special care other than the care and cleaning noted above.

If service becomes necessary, contact your dealer or installer or the Bosch Authorized Service Contractor in your area.

Do not attempt to repair the appliance yourself. Any work performed by unauthorized personnel may void the warranty.

If your appliance should fail to operate, before calling for service please review Table 4 "Problem Solving".

You could save the cost of a service call.

Problem Solving

Ovens may exhibit problems that are unrelated to a malfunction of the oven itself. Service calls for such items, not covered by warranty, must be paid for by you. The following may serve to answer your questions about a problem you are having without having to call a service person.

PROBLEM	POSSIBLE CAUSE	SUGGESTION(S)
Nothing works	Oven not connected to correct electrical circuit.	Have oven connected to properly sized electrical power supply by a qualified electrician.
	A household fuse may have blown or circuit breaker has tripped	Replace fuse or reset circuit breaker.
	Power supply connections are loose.	Have qualified electrician check connections.
The oven will not heat	The Function Selector is in Off position	Turn the function selector to a cooking function.
	The Temperature knob of the oven is not turned up to a temperature.	Set the Temperature knob to temperature desired.
	Timed mode is selected, but COOK TIME has not been set.	Check display and review instruction for programming oven.
	Delayed cooking has been selected and START TIME has not been reached.	Check time of day and check START TIME. Oven should start at preselected START TIME. To cancel delayed start press START TIME button twice.
Clock displays incorrect time of day	Time of day not properly set.	See section of this manual headed Setting Electronic Clock .
Cooking results are not what was expected	The oven is not leveled.	Level oven. See Installation Instructions.
	Oven temperature calibration differs from your previous oven.	The calibration of your old oven may have drifted gradually over time, while your new oven is more exact. Adjust oven temperature settings as needed.
	The oven was not preheated before baking.	Preheat oven when recipe calls for preheated oven.
	Incorrect cooking time, temperature or rack position being used.	
	The recipe has not been tested or is not from a reliable source.	Use only tested recipes from a reliable source.
	The pan is not the correct type or size.	Refer to a reliable cookbook or recipe for recommended pan size.
	Browning or baking results are not like they used to be in the former oven.	Change temperature settings in convection bake as described on page 5 of this manual and increase baking time accordingly.
Door will not open	Oven is in SELF CLEAN and the oven temperature is above 560 °F.	Wait for oven to finish and cool down.
	Oven has finished SELF CLEAN but oven temperature is still above 560 °F.	Wait for oven to cool.
Oven light(s) will not work	Light bulb is burned out.	Replace bulb as described in this manual in section titled Replacing an Oven Light .
	Oven is operating in SELF CLEAN.	Lights do not come on in SELF CLEAN.

Table 4.

If You Need Assistance or Service

If after reviewing Table 4 you decide that you do require service for your oven contact your dealer or installer or the Bosch Authorized Service Contractor in your area. Do not attempt to repair the appliance yourself. Any work performed by unauthorized personnel may void the warranty.

If you are having a problem with your Bosch oven and are not pleased with the service you received:

- First, please contact your installer or the Bosch Authorized Service Contractor in your area and explain to them why you are not satisfied. This will usually correct the problem.
- If after working with your installer or service person the problem still has not been resolved to your satisfaction, please let us know by either writing to us at,

**BSH Home Appliances
Dept. BSH/SC
800 South 25th Avenue
Broadview, IL 60153**

or, calling us at, **1-800/944-2904**

Please be sure to include, if writing, or have available, if calling the following information:

- Model Number
- Serial Number
- Date of Original Purchase
- Date Problem Originated
- Explanation of Problem

Also, if writing, please be sure to include a daytime phone number.

You will find the model number and serial number information on the rating plate located on the frame, to the left of the oven opening, as shown in Figure 20.

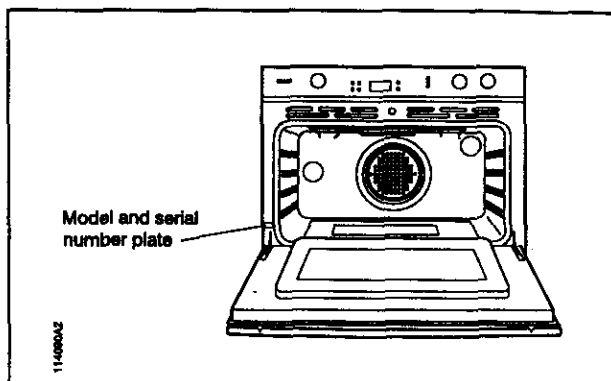


Figure 20.

Model Information

As a handy reference, it is recommended that you copy the information from your Model/Rating Plate to the table below as well as the name of the dealer from whom you purchased the oven and the local Bosch Authorized Service Contractor. Also, keep your invoice for the oven.

The invoice, with date of purchase, as well as the model number and serial number will be required for warranty validation:

Model No.:

Serial No.:

Date of Purchase:

Dealer's name:

Phone:

Bosch Authorized Service Contractor:

Phone:

Statement of Limited Warranty

The warranties provided by BSH Home Appliances ("Bosch") in this Statement of Limited Warranty apply only to the Bosch Electric Built-In Ovens ("Built-In Oven") sold to you, the first using purchaser, provided that the Built-In Oven was purchased (1) for your use and not for resale and (2) in the United States or Canada and is located in the country of purchase. As used in this Statement of Limited Warranty, the term "Date of Installation" shall refer to the earlier of the date the Built-In Oven is installed or ten (10) business days after the date the Built-In Oven is sold to the first using purchaser. The warranties stated herein apply only to the first using purchaser and are not transferable.

Standard Limited Warranty

Bosch warrants that its Built-In Oven is free from defects in materials and workmanship for a period of twelve (12) months from the Date of Installation. During the warranty period, Bosch or its authorized service center will repair or replace, at its sole option, any Built-In Oven that proves to have been defective under conditions of normal use without charge. All removed parts and components shall become the property of Bosch, at Bosch's option. All replaced and/or repaired parts shall assume the identity of the original part for purposes of this warranty and this warranty shall not be extended with respect to such parts.

Extended Limited Warranty

Bosch further warrants that the electric heating elements, controls and electrical devices (excluding light bulbs) of the Built-In Oven shall be free from defects in materials and the porcelain oven cavity and door liner are warranted against rust through for a period of time beginning on the twelfth (12th) month from the Date of Installation and continuing until the sixtieth (60th) month from the Date of Installation ("extended warranty period"). During the extended warranty period, Bosch will replace any electric heating elements, controls, or electrical device (excluding, light bulbs) of the Built-In Oven that proves to have been defective under normal conditions of use or, porcelain oven cavity and/or door liner that has failed due to rust through, without charge, excluding any labor (including but not limited to labor charges incurred in the removal and reinstallation of any Built-In Oven), transportation, and/or shipping costs incurred in the performance of this extended warranty. All replaced parts covered under this paragraph shall assume the identity of the original for purposes of this extended warranty and this warranty shall not be extended with respect to such parts.

Other Conditions of the Limited Warranties

The warranties provided in this Statement of Limited Warranty exclude defects or damage resulting from (1) use of the Built-In Oven in other than its normal and customary manner (commercial use of the Built-In Oven shall not be deemed normal or customary), (2) misuse, abuse, accidents or neglect, (3) improper operation, maintenance, installation or unauthorized service, (4) adjustment or alteration or modification of any kind, (5) a failure to comply with applicable state, local, city, and county electrical and/or building codes, (6) spills of food or liquid, and (7) external forces such as floods, fires, acts of God or other circumstances beyond Bosch's control. Also excluded from this warranty are scratches and damages on external surfaces and exposed parts or Built-In Ovens on which the serial numbers have been altered, defaced or removed.

To the extent allowed by law, this warranty sets out your exclusive remedies with respect to products covered by it, whether the claim arises in contract or tort (including strict liability, and negligence) or otherwise. Bosch will not be liable for consequential or incidental damages, losses, or expenses. THIS WARRANTY IS IN LIEU OF ALL OTHER EXPRESS WARRANTIES. ANY WARRANTY IMPLIED BY LAW, WHETHER FOR MERCHANTABILITY OR FITNESS FOR A PARTICULAR PURPOSE OR OTHERWISE, SHALL BE EFFECTIVE ONLY FOR THE PERIOD THAT THIS EXPRESS WARRANTY IS EFFECTIVE. No attempt to alter, modify or amend this warranty shall be effective unless authorized in writing by an officer of BSH.

How to Obtain Warranty Service

To obtain warranty service for the Built-In Oven, you should contact the nearest Bosch authorized service center or the BSH Home Appliances - Sales Group at 2800 South 25th Avenue, Broadview, Illinois 60153. Attn: Department BSH/SC.

NOTICE TO CALIFORNIA OWNERS

If your Built-In Oven needs warranty service and there is no authorized Bosch service center reasonably close to you, you may notify the Bosch reseller from whom you purchased the Built-In Oven. If the Bosch reseller fails to repair or replace the defective parts, or partially refund your purchase price (where applicable), you may have the Built-In Oven repaired at any large appliance repair shop or center and you will be reimbursed for all reasonable expenses provided the costs are substantiated in writing and the work performed is covered by this warranty. Bosch shall not reimburse any repair costs hereunder which exceed the depreciated value of the Built-In Oven.

Free Manuals Download Website

<http://myh66.com>

<http://usermanuals.us>

<http://www.somanuals.com>

<http://www.4manuals.cc>

<http://www.manual-lib.com>

<http://www.404manual.com>

<http://www.luxmanual.com>

<http://aubethermostatmanual.com>

Golf course search by state

<http://golfingnear.com>

Email search by domain

<http://emailbydomain.com>

Auto manuals search

<http://auto.somanuals.com>

TV manuals search

<http://tv.somanuals.com>